

*Portable Projector*

# ***NP905/NP901W***

---

*User's Manual*



**Information on USB Wireless LAN:**

The NP905/NP901W series projectors distributed in some areas and countries do not come standard with the USB Wireless LAN Unit.

If you purchase the projector without the USB Wireless LAN Unit installed and need to present to the projector via a wireless connection, the optional USB Wireless LAN Unit must be installed.

The model without the USB wireless unit has a dummy cover.

- IBM is a trademark or registered trademark of International Business Machines Corporation.
- Macintosh, Mac OS X and PowerBook are trademarks of Apple Inc., registered in the U.S. and other countries.
- Microsoft, Windows, Windows Vista, and PowerPoint are either a registered trademark or trademark of Microsoft Corporation in the United States and/or other countries.
- VESA is a registered trademark of Video Electronics Standards Association.
- All Rights Reserved. Corel, the Corel logo, Ulead, the Ulead logo, Ulead Photo Explorer, InterVideo, the InterVideo logo, are trademarks or registered trademarks of Corel Corporation and/or its subsidiaries.
- HQV is a registered trademark of Silicon Optix Inc.
- HDMI, the HDMI Logo and High-Definition Multimedia Interface are trademarks or registered trademarks of HDMI Licensing LLC.
- Trademark PJLink is a trademark applied for trademark rights in Japan, the United States of America and other countries and areas.
- MicroSaver is a registered trademark of Kensington Computer Products Group, a division of ACCO Brands.
- Other product and company names mentioned in this user's manual may be the trademarks or registered trademarks of their respective holders.

**NOTES**

- (1) The contents of this guide may not be reprinted in part or whole without permission.
- (2) The contents of this guide are subject to change without notice.
- (3) Great care has been taken in the preparation of this manual; however, should you notice any questionable points, errors or omissions, please contact us.
- (4) Notwithstanding article (3), NEC will not be responsible for any claims on loss of profit or other matters deemed to result from using the Projector.

# Important Information

## Safety Cautions

### Precautions

Please read this manual carefully before using your NEC NP905/NP901W projector and keep the manual handy for future reference.

#### CAUTION



To turn off main power, be sure to remove the plug from power outlet. The power outlet socket should be installed as near to the equipment as possible, and should be easily accessible.

#### CAUTION



TO PREVENT SHOCK, DO NOT OPEN THE CABINET. THERE ARE HIGH-VOLTAGE COMPONENTS INSIDE. REFER SERVICING TO QUALIFIED SERVICE PERSONNEL.



This symbol warns the user that uninsulated voltage within the unit may be sufficient to cause electrical shock. Therefore, it is dangerous to make any kind of contact with any part inside of the unit.



This symbol alerts the user that important information concerning the operation and maintenance of this unit has been provided. The information should be read carefully to avoid problems.

**WARNING:** TO PREVENT FIRE OR SHOCK, DO NOT EXPOSE THIS UNIT TO RAIN OR MOISTURE. DO NOT USE THIS UNIT'S PLUG WITH AN EXTENSION CORD OR IN AN OUTLET UNLESS ALL THE PRONGS CAN BE FULLY INSERTED.

### DOC Compliance Notice (for Canada only)

This Class B digital apparatus meets all requirements of the Canadian Interference-Causing Equipment Regulations.

### Acoustic Noise Information Ordinance-3. GSGV (for Germany only):

The sound pressure level is less than 70 dB (A) according to ISO 3744 or ISO 7779.

#### CAUTION



Avoid displaying stationary images for a prolonged period of time. Doing so can result in these images being temporarily sustained on the surface of the LCD panel. If this should happen, continue to use your projector. The static background from previous images will disappear.

### WARNING TO CALIFORNIA RESIDENTS:

Handling the cables supplied with this product will expose you to lead, a chemical known to the State of California to cause birth defects or other reproductive harm. *WASH HANDS AFTER HANDLING.*

### Disposing of your used product



EU-wide legislation as implemented in each Member State requires that used electrical and electronic products carrying the mark (left) must be disposed of separately from normal household waste. This includes projectors and their electrical accessories or lamps. When you dispose of such products, please follow the guidance of your local authority and/or ask the shop where you purchased the product.

After collecting the used products, they are reused and recycled in a proper way. This effort will help us reduce the wastes as well as the negative impact such as mercury contained in a lamp to the human health and the environment at the minimum level.

The mark on the electrical and electronic products only applies to the current European Union Member States.

### RF Interference (for USA only)

#### WARNING

The Federal Communications Commission does not allow any modifications or changes to the unit EXCEPT those specified by NEC Display Solutions of America, Inc. in this manual. Failure to comply with this government regulation could void your right to operate this equipment. This equipment has been tested and found to comply with the limits for a Class B digital device, pursuant to Part 15 of the FCC Rules. These limits are designed to provide reasonable protection against harmful interference in a residential installation. This equipment generates, uses, and can radiate radio frequency energy and, if not installed and used in accordance with the instructions, may cause harmful interference to radio communications. However, there is no guarantee that interference will not occur in a particular installation.

If this equipment does cause harmful interference to radio or television reception, which can be determined by turning the equipment off and on, the user is encouraged to try to correct the interference by one or more of the following measures:

- Reorient or relocate the receiving antenna.
- Increase the separation between the equipment and receiver.
- Connect the equipment into an outlet on a circuit different from that to which the receiver is connected.
- Consult the dealer or an experienced radio / TV technician for help.

For UK only: In UK, a BS approved power cable with moulded plug has a Black (five Amps) fuse installed for use with this equipment. If a power cable is not supplied with this equipment please contact your supplier.

### Important Safeguards

These safety instructions are to ensure the long life of your projector and to prevent fire and shock. Please read them carefully and heed all warnings.

#### Installation

- Do not place the projector in the following conditions:
  - on an unstable cart, stand, or table.
  - near water, baths or damp rooms.
  - in direct sunlight, near heaters or heat radiating appliances.
  - in a dusty, smoky or steamy environment.
  - on a sheet of paper or cloth, rugs or carpets.
- If you wish to have the projector installed on the ceiling:
  - Do not attempt to install the projector yourself.
  - The projector must be installed by qualified technicians in order to ensure proper operation and reduce the risk of bodily injury.
  - In addition, the ceiling must be strong enough to support the projector and the installation must be in accordance with any local building codes.
  - Please consult your dealer for more information.

### Place the projector in a horizontal position

The tilt angle of the projector should not exceed 10 degrees, nor should the projector be installed in any way other than the desktop and ceiling mount, otherwise lamp life could decrease dramatically.



### **Fire and Shock Precautions**

- Ensure that there is sufficient ventilation and that vents are unobstructed to prevent the build-up of heat inside your projector. Allow at least 4 inches (10cm) of space between your projector and a wall.
- Do not try to touch the ventilation outlet as it can become heated while the projector is turned on.
- Prevent foreign objects such as paper clips and bits of paper from falling into your projector. Do not attempt to retrieve any objects that might fall into your projector. Do not insert any metal objects such as a wire or screwdriver into your project. If something should fall into your projector, disconnect it immediately and have the object removed by a qualified service personnel.
- Do not place any objects on top of the projector.
- Do not touch the power plug during a thunderstorm. Doing so can cause electrical shock or fire.
- The projector is designed to operate on a power supply of 100-240V AC 50/60 Hz. Ensure that your power supply fits this requirement before attempting to use your projector.
- Do not look into the lens while the projector is on. Serious damage to your eyes could result.
- Keep any items such as magnifying glass out of the light path of the projector. The light being projected from the lens is extensive, therefore any kind of abnormal objects that can redirect light coming out of the lens, can cause unpredictable outcome such as fire or injury to the eyes.
- Do not cover the lens with the black lens cap or equivalent while the projector is on. Doing so can lead to melting of the cap and possibly burning your hands due to the heat emitted from the light output.
- Do not place any objects, which are easily affected by heat, in front of the projector lens or a projector exhaust vent.  
Doing so could lead to the object melting or getting your hands burned from the heat that is emitted from the light output and exhaust.
- Handle the power cable carefully. A damaged or frayed power cable can cause electric shock or fire.
  - Do not use any power cables than the supplied one.
  - Do not bend or tug the power cable excessively.
  - Do not place the power cable under the projector, or any heavy object.
  - Do not cover the power cable with other soft materials such as rugs.
  - Do not heat the power cable.
  - Do not handle the power plug with wet hands.
- Turn off the projector, unplug the power cable and have the projector serviced by a qualified service personnel under the following conditions:
  - When the power cable or plug is damaged or frayed.
  - If liquid has been spilled into the projector, or if it has been exposed to rain or water.
  - If the projector does not operate normally when you follow the instructions described in this user's manual.
  - If the projector has been dropped or the cabinet has been damaged.
  - If the projector exhibits a distinct change in performance, indicating a need for service.
- Disconnect the power cable and any other cables before carrying the projector
- Turn off the projector and unplug the power cable before cleaning the cabinet or replacing the lamp.
- Turn off the projector and unplug the power cable if the projector is not to be used for an extended period of time.
- When using a LAN cable:  
For safety, do not connect to the connector for peripheral device wiring that might have excessive voltage.

### CAUTION

- When carrying the projector by the carrying handle, make sure the two screws that attach the carrying handle to the projector cabinet are tight. (→ page 5)  
Insufficient tightening of the two screws could result in the projector falling and causing injury.
- Do not use the tilt-foot for purposes other than originally intended. Misuses such as using the tilt foot to carry or hang (from the wall or ceiling) the projector can cause damage to the projector.
- Do not send the projector in a soft case by parcel delivery service or cargo shipment. The projector inside the soft case could be damaged.
- Select [HIGH] in Fan mode if you continue to use the projector for consecutive days. (From the menu, select [SETUP - OPTIONS] → [FAN MODE] → [HIGH].)
- Do not unplug the power cable from the wall outlet or projector when the projector is powered on. Doing so can cause damage to the AC IN connector of the projector and (or) the prong plug of the power cable.  
To turn off the AC power supply when the projector is powered on, use a power strip equipped with a switch and a breaker.
- The projector can be unplugged during its cool down period after it is turned off.  
Do not try to touch the ventilation outlet on the left front (when seen from the front) as it can become heated while the projector is turned on and immediately after the projector is turned off.
- Do not turn off the AC power for 60 seconds after the lamp is turned on and while the POWER indicator is blinking green. Doing so could cause premature lamp failure.

### Remote Control Precautions

- Handle the remote control carefully.
- If the remote control gets wet, wipe it dry immediately.
- Avoid excessive heat and humidity.
- Do not heat, take apart, or throw batteries into fire.
- If you will not be using the remote control for a long time, remove the batteries.
- Ensure that you have the batteries' polarity (+/-) aligned correctly.
- Do not use new and old batteries together, or use different types of batteries together.
- Dispose of used batteries according to your local regulations.

### Lamp Replacement

- To replace the lamp, follow all instructions provided on page 125.
- Be sure to replace the lamp when the message **[THE LAMP HAS REACHED THE END OF ITS USABLE LIFE. PLEASE REPLACE THE LAMP.]** appears. If you continue to use the lamp after the lamp has reached the end of its usable life, the lamp bulb may shatter, and pieces of glass may be scattered in the lamp case. Do not touch them as the pieces of glass may cause injury.

If this happens, contact your dealer for lamp replacement.

### A Lamp Characteristic

The projector has a high-pressure mercury lamp as a light source.

A lamp has a characteristic that its brightness gradually decreases with age. Also repeatedly turning the lamp on and off will increase the possibility of its lower brightness.

### CAUTION:

When removing the lamp from a ceiling-mounted projector, make sure that no one is under the projector. Glass fragments could fall if the lamp has been burned out.

### About High Altitude mode

- Set [FAN MODE] to [HIGH ALTITUDE] when using the projector at altitudes approximately 5500 feet/1600 meters or higher.  
Using the projector at altitudes approximately 5500 feet/1600 meters or higher without setting to [HIGH ALTITUDE] can cause the projector to overheat and the protector could shut down. If this happens, wait a couple minutes and turn on the projector.
- Using the projector at altitudes less than approximately 5500 feet/1600 meters and setting to [HIGH ALTITUDE] can cause the lamp to overcool, causing the image to flicker. Switch [FAN MODE] to [AUTO].
- Using the projector at altitudes approximately 5500 feet/1600 meters or higher can shorten the life of optical components such as the lamp.

### USB Wireless LAN Unit

#### Cautions on Usage

#### Warning

- The USB Wireless LAN Unit is not meant for use with facilities or equipment involving the safeguard of human life, such as medical equipment, nuclear facilities or equipment, aeronautical or space equipment, transportation facilities or equipment, etc., or with facilities or equipment requiring high levels of reliability. Do not use the USB Wireless LAN Unit in such cases.
- Do not use the USB Wireless LAN Unit near cardiac pacemakers.
- Do not use the USB Wireless LAN Unit near medical equipment. Doing so may cause electromagnetic interference with the medical equipment, possible leading to death.
- Do not disassemble or modify the USB Wireless LAN Unit in any way. Doing so could lead to fire or electric shock.
- Do not use the USB Wireless LAN Unit in wet or moist places, such as in bathrooms or near humidifiers. Doing so could lead to fire, electric shock or malfunction.

#### Caution

To prevent damage due to static electricity, eliminate any static electricity from your body before touching the USB Wireless LAN Unit.

- Static electricity from the human body may damage the USB Wireless LAN Unit. Before touching the USB Wireless LAN Unit, touch an aluminum sash, a door knob, or some other metal object around you to eliminate the static electricity.

#### Caution

The radio waves used by the USB Wireless LAN Unit pass through the wood or glass used in normal homes (but not through window panes with built-in metallic mesh).

The radio waves do not pass through iron reinforcing bars, metal or concrete, however, so the USB Wireless LAN Unit cannot be used for communicating through walls or floors made with these materials.



### FCC Compliance

This device complies with Part 15 of the FCC Rules. Operation is subject to the following two conditions: (1) this device may not cause harmful interference and (2) this device must accept any interference received, including interference that may cause undesired operation.

This equipment has been tested and found to comply with the limits for a Class B Personal Computer and Peripheral, pursuant to Part 15 of the FCC Rules. These limits are designed to provide reasonable protection against harmful interference in a residential installation.

This equipment generates, uses and can radiate radio frequency energy and, if not installed and used in accordance with the instructions, may cause harmful interference to radio communications.

However, there is no guarantee that interference will not occur in a particular installation. If this equipment does cause harmful interference to radio or television reception, which can be determined by turning the equipment off and on, the user is encouraged to try to correct the interference by one or more of the following measures:

- Reorient or relocate the receiving antenna.
- Increase the separation between the equipment and receiver.
- Connect the equipment into an outlet on a circuit different from that to which the receiver is connected.
- Consult the dealer or an experienced radio/TV technician for help.

This equipment has been tested to comply with the limits for a Class B personal computer and peripheral, pursuant to Subpart B of Part 15 of FCC Rules. Only peripherals (computer input/output devices, terminals, printers, etc.) certified (DoC) or verified to comply with Class B limits may be attached to this equipment. Operation with non-certified (DoC) or non-verified personal computer and/or peripherals is likely to result in Interference to radio and TV reception.

The connection of a unshielded equipment interface cable to this equipment will invalidate the FCC Certification of this device and may cause interference levels which Exceed the limits established by FCC for equipment.

You are cautioned that changes or modifications not expressly approved by the party responsible for compliance could void your authority to operate the equipment.

### Regulatory Information/Disclaimers

Installation and use of this Wireless LAN device must be in strict accordance with the instructions included in the user documentation provided with the product. Any changes or modifications (including the antennas) made to this device that are not expressly approved by the manufacturer may void the user's authority to operate the equipment. The manufacturer is not responsible for any radio or television interference caused by unauthorized modification of this device, or the substitution of the connecting cables and equipment other than manufacturer specified. It is the responsibility of the user to correct any interference caused by such unauthorized modification, substitution or attachment. Manufacturer and its authorized resellers or distributors will assume no liability for any damage or violation of government regulations arising from failing to comply with these guidelines.

#### CAUTION

To comply with FCC RF exposure compliance requirements, the antenna used for this transmitter must be installed to provide a separation distance of at least 7.87"/20cm from all persons and must not be co-located or operating in conjunction with any other antenna or transmitter.

SAR compliance has been established in typical laptop computer(s) with USB slot, and product could be used in typical laptop computer with USB slot. Other application like handheld PC or similar device has not been verified and may not compliance with related RF exposure rule and such use shall be prohibited.

### Usage restrictions in North America

The following channels can be used indoors only.

- In the United States and Canada: 36, 40, 44, and 48 channels
- In Mexico: 149, 153, 157, 161, and 165 channels

The other channels can be used both indoors and outdoors.

This Class B digital apparatus complies with Canadian RSS-210.  
Cet appareil numérique de la Classe B est conforme à la norme CNR-210 du Canada.

To comply with Canada RSS-210(Issue 7) section A9.4(b)(ii); this radio product will not transmit on any channels operating in the exclusion band of 5600 - 5650MHz. All channels in the 5600 - 5650MHz band will be disabled by factory firmware and is not user changeable.

### Regulatory Statement:

Operation of this device is subjected to the following National regulations and may be prohibited to use if certain restriction should be applied.

### France:

Outdoor use limited to 10mW e.i.r.p. within the band 2454 – 2483.5 MHz. Derogation in French overseas departments of Guyane and La Reunion: outdoor use not allowed in band 2400 - 2420 MHz.

Hereby, NEC Display Solutions, Ltd. declares that this USB Wireless LAN Unit (Model: NP01LM) is in compliance with the essential requirements and other relevant provisions of Directive 1999/5/EC.

### Cautions on security when using wireless LAN products

With a wireless LAN, radio waves are used instead of LAN cables for the exchange of data between the wireless access points (computers, etc.), offering the advantage that LAN connections can be made freely within the range of the radio waves.

On the other hand, the radio waves reach all points within this range, regardless of walls or other obstacles, possibly resulting in the problems described below if the proper security measures are not taken.

#### • Contents of transmissions may be intercepted

Malicious third parties may purposely intercept the radio waves and steal information contained in the transmissions, including such personal information as ID numbers, passwords, credit card numbers, e-mail messages, etc.

#### • Improper intrusions

Malicious third parties may without permission access the personal or company network and steal personal or confidential information, pretend to be someone else and leak incorrect information, rewrite information that has been intercepted, introduce computer viruses or otherwise damage data or the system, etc.

Wireless LAN cards and wireless access points generally include security measures for dealing with these problems. Making the proper security settings before using the products can reduce the risk of such problems arising.

We recommend that you fully understand the problems that can arise when using the products without making the security settings, then that you make the security settings based on your own decision and at your own discretion.

Operation of the USB Wireless LAN Unit is subjected to the regulations of the countries listed below, and may be prohibited to use outside the country where you purchased. If you need to use the projector outside the country where you purchased, you must remove the USB Wireless LAN Unit from the projector before exporting.

# Table of Contents

---

<b>Important Information</b> .....	i
<b>1. Introduction</b> .....	1
❶ What's in the Box?.....	1
❷ Introduction to the Projector .....	2
Congratulations on Your Purchase of the Projector.....	2
Features you'll enjoy :.....	2
About this user's manual.....	3
❸ Part Names of the Projector .....	4
Front/Top .....	4
Rear .....	4
Bottom.....	5
Carrying the Projector.....	5
Top Features.....	6
Terminal Panel Features.....	7
❹ Part Names of the Remote Control .....	8
Battery Installation .....	9
Operating Range for Wireless Remote Control .....	9
Remote Control Precautions.....	9
<b>2. Installation and Connections</b> .....	10
❶ Setting Up the Screen and the Projector .....	10
Selecting a Location (NP905) .....	10
Selecting a Location (NP901W).....	11
❷ Making Connections.....	12
Connecting Your PC or Macintosh Computer.....	12
Connecting an External Monitor.....	14
Connecting Your HDMI Compatible Equipment.....	15
Connecting Your DVD Player with Component Output.....	16
Connecting Your VCR.....	17
Connecting to a Network.....	18
Connecting the Supplied Power Cable .....	21
<b>3. Projecting an Image (Basic Operation)</b> .....	22
❶ Turning on the Projector .....	22
Note on Startup screen (Menu Language Select screen).....	23
❷ Selecting a Source .....	24
Selecting the computer or video source.....	24
❸ Adjusting the Picture Size and Position.....	25
Adjusting the focus (Focus ring) .....	26
Finely adjusting the size of an image (Zoom lever) .....	26
Adjusting the Tilt Foot .....	27
❹ Correcting Keystone Distortion.....	28
❺ Optimizing an RGB Image Automatically .....	30
Adjusting the Image Using Auto Adjust.....	30
❻ Adjusting Volume Up & Down .....	30
❼ Turning off the Projector .....	31
❽ After Use.....	32

<b>4. Convenient Features</b> .....	33
<b>1</b> Turning Off the Image and Sound .....	33
<b>2</b> Freezing a Picture .....	33
<b>3</b> Enlarging and Moving a Picture.....	33
<b>4</b> Changing Lamp Mode .....	34
<b>5</b> Getting Integrated Help .....	34
<b>6</b> Using a USB Mouse .....	35
Operate the Menus using the USB mouse .....	35
<b>7</b> Using the Supplied Remote Mouse Receiver.....	36
<b>8</b> Correcting Horizontal and Vertical Keystone Distortion (Cornerstone) .....	38
Cornerstone .....	38
<b>9</b> Displaying Two Pictures at the Same Time.....	41
Selecting the PIP or SIDE BY SIDE Mode [MODE].....	41
[POSITION] .....	42
<b>10</b> Preventing Unauthorized Use of the Projector .....	43
Turning on the Security function by assigning a keyword for the first time .....	43
Checking If Security is enabled.....	46
Disabling the Security .....	47
<b>11</b> Limiting Access Level to Available Menu Items.....	48
<b>12</b> Operation Using an HTTP Browser .....	51
Overview .....	51
Preparation Before Use .....	51
Handling of the Address for Operation via a Browser.....	51
Structure of the HTTP Server .....	52
<b>13</b> Projecting Your Computer's Screen Image from the Projector via a Network [NETWORK PROJECTOR] .....	54
<b>14</b> Using the Projector to Operate Your Computer via a Network [REMOTE DESKTOP] .....	58
<b>5. Using the Viewer</b> .....	63
<b>1</b> Making the Most out of the Viewer Function .....	63
Features.....	63
Easy to use .....	63
Simple utility software (for computer).....	63
<b>2</b> Saving data to a USB memory device.....	63
Using Ulead Photo Explorer 8.0.....	63
Using Windows Explorer to save files.....	63
<b>3</b> Operating the Viewer Function from the Projector (playback).....	64
Projecting slides (Viewer) .....	64
Operating Viewer Menu .....	64
Projecting a movie file.....	65
Setting Option for Viewer.....	67
THUMBNAILES menu.....	68
Exiting Viewer .....	68
<b>4</b> Changing Background Logo.....	69

<b>6. Using On-Screen Menu</b> .....	70
<b>1</b> Using the Menus.....	70
Using ADVANCED menu and BASIC menu.....	71
Entering alphanumeric characters by using Software Keyboard.....	71
<b>2</b> Menu tree.....	72
<b>3</b> Menu Elements.....	74
<b>4</b> Menu Descriptions & Functions [SOURCE].....	75
COMPUTER 1 and 2.....	75
HDMI.....	75
VIDEO.....	75
S-VIDEO.....	75
VIEWER.....	75
NETWORK.....	75
ENTRY LIST.....	75
<b>5</b> Menu Descriptions & Functions [ADJUST].....	78
[PICTURE].....	78
[IMAGE OPTIONS].....	81
[VIDEO].....	85
[AUDIO].....	86
<b>6</b> Menu Descriptions & Functions [SETUP].....	87
[BASIC].....	87
[MENU].....	95
[INSTALLATION(1)].....	96
[INSTALLATION(2)].....	99
[OPTIONS].....	115
<b>7</b> Menu Descriptions & Functions [INFO.].....	117
[USAGE TIME].....	117
[SOURCE (1)].....	118
[SOURCE (2)].....	118
[WIRED LAN].....	119
[WIRELESS LAN (1)].....	119
[WIRELESS LAN (2)].....	120
[VERSION (1)].....	120
[VERSION (2)].....	120
<b>8</b> Menu Descriptions & Functions [RESET].....	121
Returning to Factory Default.....	121
 <b>7. Maintenance</b> .....	 122
<b>1</b> Cleaning or Replacing the Filter.....	122
<b>2</b> Cleaning the Cabinet and the Lens.....	124
<b>3</b> Replacing the Lamp.....	125

<b>8. Appendix</b> .....	128
① Troubleshooting.....	128
Indicator Messages.....	128
Common Problems & Solutions .....	129
② Specifications .....	131
③ Cabinet Dimensions .....	135
④ Screen Size and Projection Distance .....	136
⑤ Pin Assignments of D-Sub COMPUTER 1/2 Input Connector .....	139
Mini D-Sub 15 Pin Connector .....	139
⑥ Compatible Input Signal List.....	140
⑦ PC Control Codes and Cable Connection.....	141
PC Control Codes.....	141
Cable Connection .....	142
PC Control Connector (D-SUB 9P).....	142
⑧ Removing and Attaching the USB Wireless LAN Unit.....	143
⑨ Troubleshooting Check List.....	146
⑩ TravelCare Guide .....	148

# 1. Introduction

## ① What's in the Box?

Make sure your box contains everything listed. If any pieces are missing, contact your dealer. Please save the original box and packing materials if you ever need to ship your Projector.

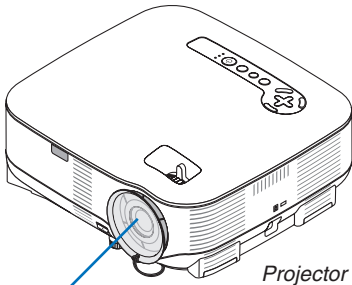

Lens cap  
(24FU0141)

Projector

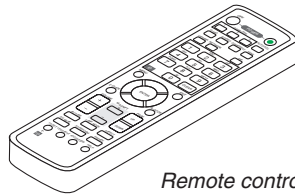

Remote control  
(7N900811)

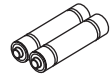

Batteries (AA x 2)

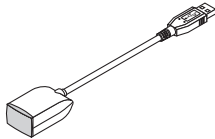

Remote Mouse Receiver  
(7N900722)

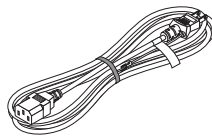

Power cable  
(7N080204) US  
(7N080011) EU

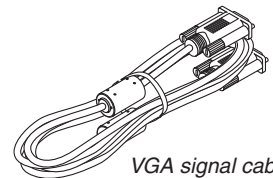

VGA signal cable  
(7N520052)

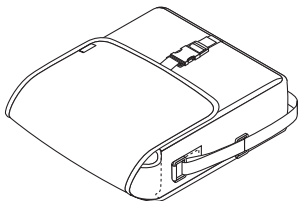

Soft Case  
(24BS7851)

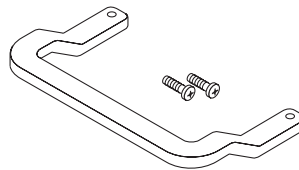

Carrying handle (24FU0131)  
Screw (M4x2: 24V01221)

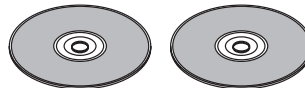
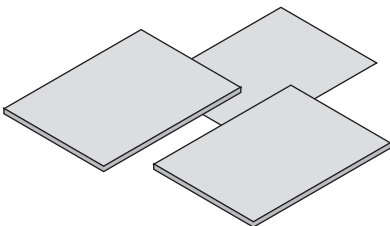

CD-ROM  
User's manual and User Supportware 5  
(7N951181)/(7N951133)

- Important Information (7N8P8451)
- Quick Setup Guide (7N8P8441)
- Wired and Wireless Network Setup Guide (7N8P8461)

- Security sticker

### For North America only

Registration card  
Limited warranty

### For Europe only

Guarantee policy

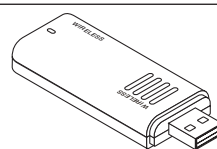

Installed USB wireless LAN unit  
North America: NP01LM3  
Europe: NP01LM2

## **② Introduction to the Projector**

This section introduces you to the NP905/NP901W projector and describes key features and controls.

### **Congratulations on Your Purchase of the Projector**

The NP905 is a sophisticated XGA projector that produces an enhanced display. The NP901W is a WXGA projector that produces a wide XGA image. With the NP905/NP901W you will be able to project images up to 300" (measured diagonally). Enjoy crisp and sharp large screen display from your PC, workstation or Macintosh computer, DVD player, VCR, satellite hookup, HDTV source, as well as images from your USB storage device. The NP905/NP901W provides for enhanced security options to help deter projector theft and provides for full projector control through the PC control port (D-Sub 9 Pin) and LAN support. With input and output flexibility, long lamp life and a full function remote, the NP905/NP901W lets you enjoy larger than life viewing from a compact and easy to setup and use projector.

### **Features you'll enjoy :**

- **LCD projector with high resolution and high brightness**

High resolution display - up to UXGA compatible, XGA (NP905)/WXGA (NP901W) native resolution.

- **Direct Power Off & Auto Start**

The projector has a feature called "Direct Power Off". This feature allows the projector to be turned off (even when projecting an image) using a power strip equipped with a switch and a breaker.

The AUTO POWER ON feature eliminates the need to always use the POWER button on the remote control or projector cabinet.

- **Integrated RJ-45 connector for wired networking capability along with wireless networking capabilities**

An RJ-45 connector and a USB Wireless LAN unit are equipped as standard features\*.

Present from anywhere in the room when using as a wireless LAN projector and software contained on the supplied User Supportware 5 CD-ROM, no physical signal cable connection to a PC is required.

---

*NOTE: The NP905/NP901W series projectors distributed in some areas and countries do not come standard with the USB Wireless LAN Unit.*

*If you purchase the projector without the USB Wireless LAN Unit installed and need to present to the projector via a wireless connection, the optional USB Wireless LAN Unit must be installed.*

---

- **Windows Vista standard functions Network Projector and Remote Desktop can be used**

A Windows Vista-based computer can be operated using the projector over a network.

The projector supports the Network Projector function and the Remote Desktop function of Windows Vista.

- **A variety of input ports and a comprehensive array of system control interfaces**

This projector supports input signals on the following ports: HDMI, 15pin D-Sub, composite and S-video.

- **Wall Color Correction**

Built-in Wall Color Correction presets provide for adaptive color correction when projecting onto non-white screen material (or a wall).

- **Seven picture preset modes for user adjustable picture and color settings**

Each picture preset mode can be customized and memorized according to your preference.

- **Silicon Optix HQV technology produces superior video processing**

The technology produces superior video processing using pixel-based, motion-adaptive de-interlacing to remove undesirable motion artifacts typical of interlaced signals.

- **Preventing unauthorized use of the projector**

Enhanced smart security settings for password protection, cabinet control panel lock, and USB memory protection key to help prevent unauthorized access, adjustments and theft deterrence.



### **About this user's manual**

The fastest way to get started is to take your time and do everything right the first time. Take a few minutes now to review the user's manual. This may save you time later on. At the beginning of each section of the manual you'll find an overview. If the section doesn't apply, you can skip it.

### 3 Part Names of the Projector

#### Front/Top

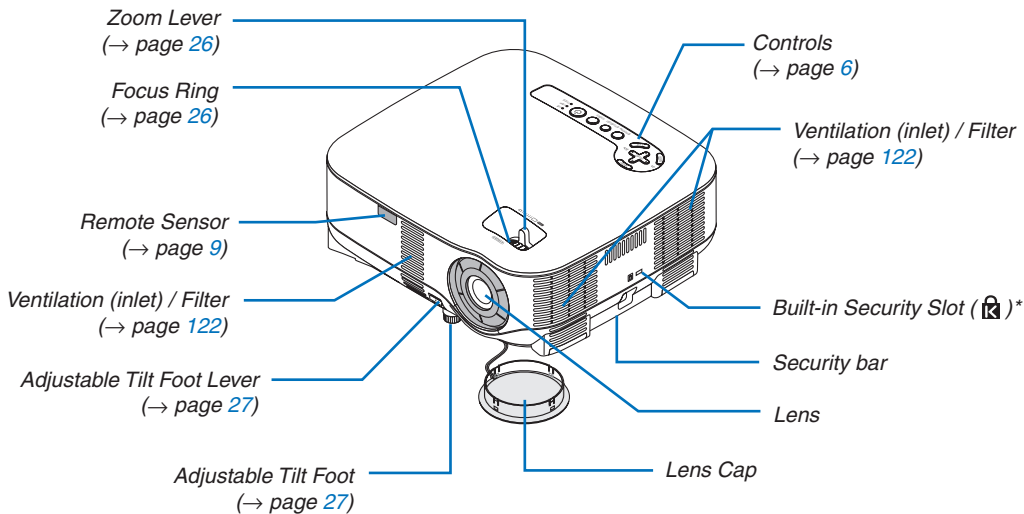

\* This security slot supports the MicroSaver® Security System.

#### Rear

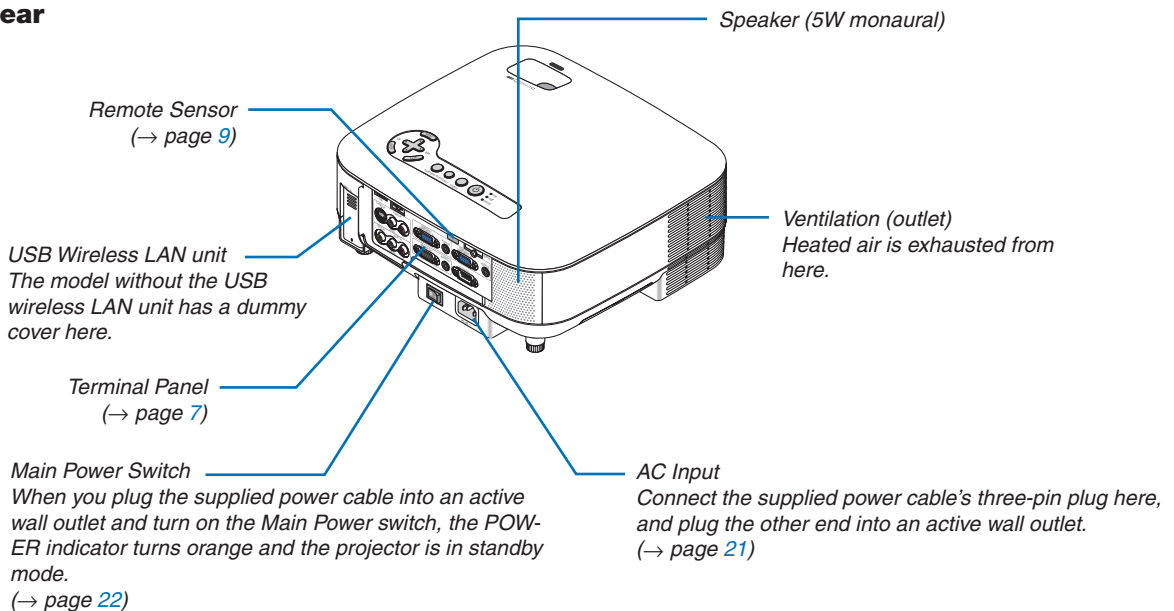

#### NOTE:

The USB Wireless LAN Unit emits weak radio waves when the projector is in standby\* mode or turned on. If you use the projector with the USB Wireless LAN Unit in the area where the use of wireless LAN equipment is prohibited, remove the USB Wireless LAN Unit from the projector. (→ page 143)

\* To stop emitting radio waves from the USB Wireless LAN Unit during standby mode, select [POWER-SAVING] from [STANDBY MODE].

**Bottom**

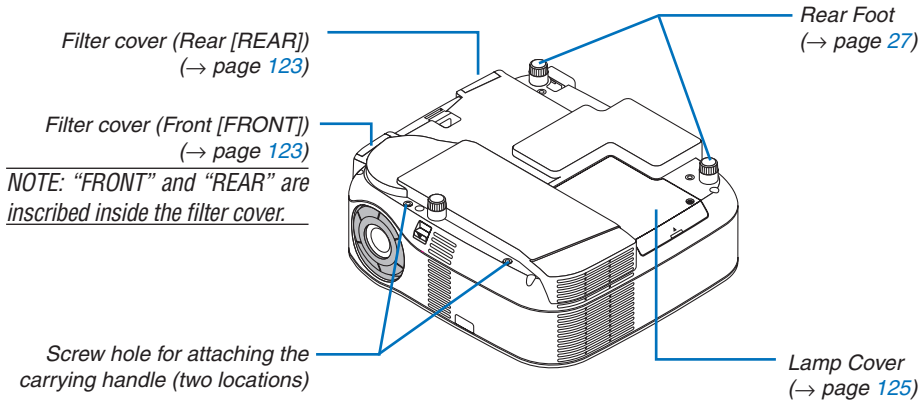

**Carrying the Projector**

Always carry your projector by the handle.

Ensure that the power cable and any other cables connecting to video sources are disconnected before moving the projector.

When moving the projector or when it is not in use, cover the lens with the lens cap.

**Attaching the supplied carrying handle**

You can carry the projector by attaching the supplied carrying handle securely to the projector.

To attach the supplied carrying handle, use a Phillips-head screwdriver and the supplied two screws.

Place a soft cloth on the working surface before turning the projector over to prevent scratching the top cover. Make sure that the carrying handle is attached with correct orientation as shown below.

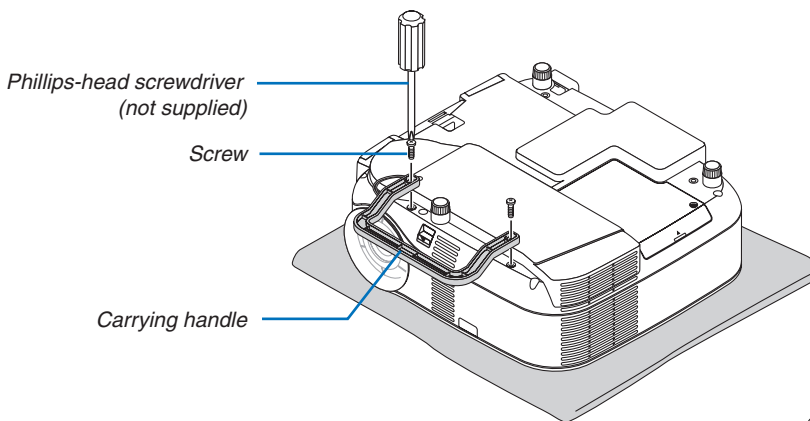

**CAUTION**

- When carrying the projector by the carrying handle, make sure the two screws that attach the carrying handle to the projector cabinet are tight.
- Use the supplied lens cap to protect the lens surface when carrying the projector.

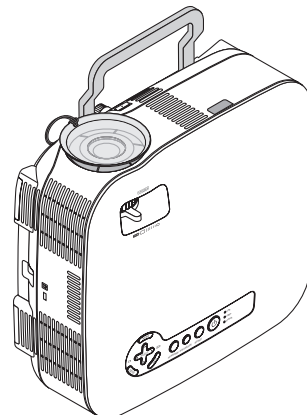

Top Features

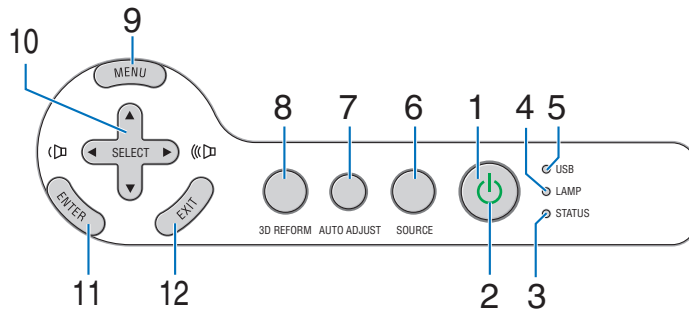

1. POWER Button (⏻) (→ page 22, 31)

*NOTE: To turn on the projector, press and hold this button for a minimum of two seconds. To turn off the projector, press this button twice.*

2. POWER Indicator (→ page 22, 31, 128)

3. STATUS Indicator (→ page 128)

4. LAMP Indicator (→ page 125, 128)

5. USB Indicator

Lights when a USB memory is inserted into the USB port.

*NOTE: The USB indicator will not light when non-USB storage devices such as USB mouse devices are inserted.*

6. SOURCE Button

7. AUTO ADJUST Button (→ page 30)

8. 3D REFORM Button (→ page 28, 38)

9. MENU Button

10. SELECT ▲▼◀▶ / Volume Buttons

11. ENTER Button

12. EXIT Button

## Terminal Panel Features

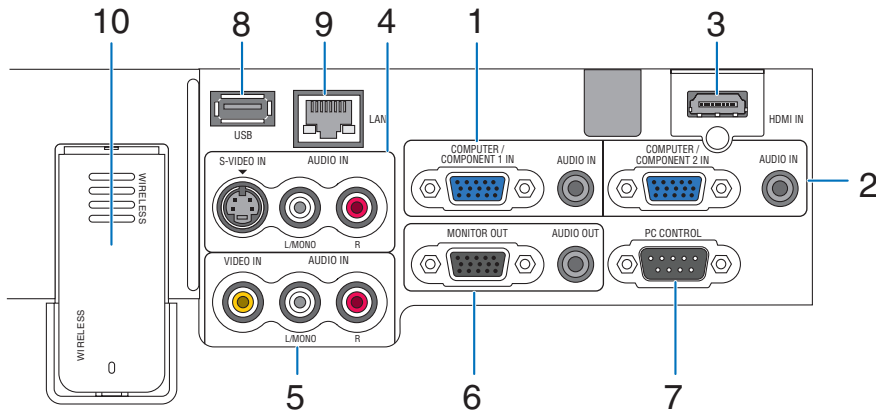

The actual appearance of the terminal panel may differ slightly from that shown in the drawing, but this does not affect the projector's performance.

1. **COMPUTER 1 IN/COMPONENT 1 IN Connector (Mini D-Sub 15 Pin)** (→page 12, 16)  
**AUDIO IN (Stereo Mini Jack)** (→page 12, 16)
2. **COMPUTER 2 IN/COMPONENT 2 IN Connector (Mini D-Sub 15 Pin)** (→page 12, 16)  
**AUDIO IN (Stereo Mini Jack)** (→page 12, 16)
3. **HDMI IN (19 Pin HDMI Type A)** (→page 13, 15)
4. **S-VIDEO IN Connector (Mini DIN 4 Pin)** (→page 17)  
**AUDIO L/MONO, R (RCA)** (→page 17)
5. **VIDEO IN Connector (RCA)** (→page 17)  
**AUDIO L/MONO, R (RCA)** (→page 17)
6. **MONITOR OUT Connector (Mini D-Sub 15 Pin)** (→page 14)  
**AUDIO OUT (Stereo Mini Jack)** (→page 14)
7. **PC CONTROL Port (D-Sub 9 Pin)** (→page 141, 142)  
Use this port to connect your PC or control system to control your projector via a serial cable. This enables you to control the projector using serial communication protocol. A commercially available RS232C cross cable is required to use this port. You can also control the projector by using PC Control Utility 3.0 contained on the supplied User Supportware 5 CD-ROM. To do so you must first have PC Control Utility 3.0 installed on your PC. If you are writing your own program, typical PC control codes are on page 141.
8. **USB Port (Type A)** (→page 35)
9. **LAN Port (RJ-45)** (→page 18, 99)
10. **USB Wireless LAN unit** (→page 143)

*NOTE: A dummy cover is provided on this location of the projector without the USB Wireless LAN Unit.*

## 4 Part Names of the Remote Control

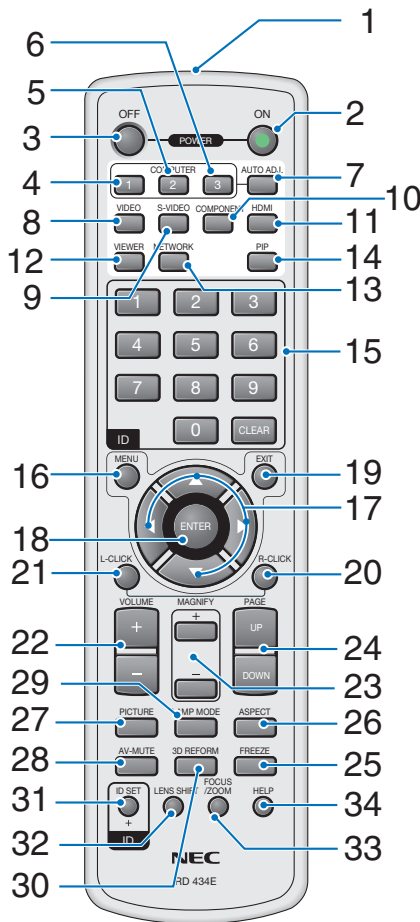

- 12. VIEWER Button (→ page 24, 63)
- 13. NETWORK Button (→ page 24)
- 14. PIP Button (→ page 42)
- 15. Numeric Keypad Button/CLEAR Button (→ page 114)
- 16. MENU Button
- 17. SELECT ▲▼◀▶ Button
- 18. ENTER Button
- 19. EXIT Button
- 20. MOUSE R-CLICK Button (→ page 37)
- 21. MOUSE L-CLICK Button (→ page 37)
- 22. VOLUME +/- Buttons (→ page 30)
- 23. MAGNIFY +/- Buttons (→ page 33)
- 24. PAGE UP/DOWN Buttons (→ page 37)
- 25. FREEZE Button (→ page 33)
- 26. ASPECT Button (→ page 83)
- 27. PICTURE Button (→ page 78, 80)
- 28. AV-MUTE Button (→ page 33)
- 29. LAMP MODE Button (→ page 34)
- 30. 3D REFORM Button (→ page 28, 38)
- 31. ID SET Button (→ page 114)
- 32. LENS SHIFT Button (not available on this model)
- 33. FOCUS/ZOOM Button (not available on this model)
- 34. HELP Button (→ page 34)

- 1. Infrared Transmitter
- 2. POWER ON Button (→ page 22)  
*NOTE: To turn on the projector, press and hold the POWER ON button for a minimum of two seconds.*
- 3. POWER OFF Button (→ page 31)  
*NOTE: To turn off the projector, press the POWER OFF button twice.*
- 4. COMPUTER 1 Button (→ page 24)
- 5. COMPUTER 2 Button (→ page 24)
- 6. COMPUTER 3 Button  
(not available on this model)
- 7. AUTO ADJ. Button (→ page 30)
- 8. VIDEO Button (→ page 24)
- 9. S-VIDEO Button (→ page 24)
- 10. COMPONENT Button (→ page 24)  
(not available on this model)
- 11. HDMI Button (→ page 24)

## Battery Installation

**1** Press the catch and remove the battery cover.

**2** Install new ones (AA). Ensure that you have the batteries' polarity (+/-) aligned correctly.

**3** Slip the cover back over the batteries until it snaps into place.

*NOTE: Do not mix different types of batteries or new and old batteries.*

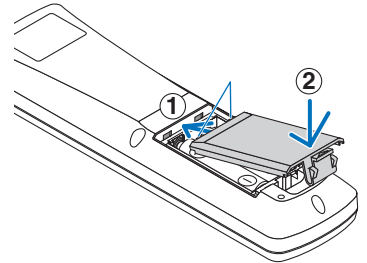
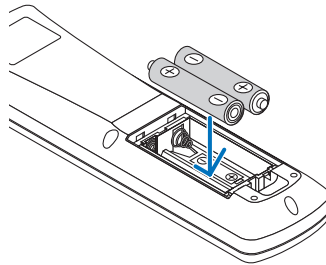
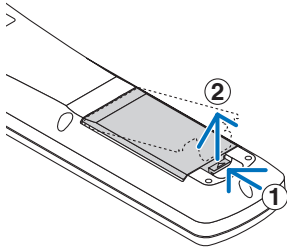

## Operating Range for Wireless Remote Control

*NOTE: Actual operating range may differ slightly from that shown in the drawing.*

*TIP: You can determine which remote sensor on the projector is enabled in wireless mode. The options are: front, rear or both. (→ page 113)*

- The infrared signal operates by line-of-sight up to a distance of about 22 feet/7 m and within a 60-degree angle of the remote sensor on the projector cabinet.
- The projector will not respond if there are objects between the remote control and the sensor, or if strong light falls on the sensor.  
Weak batteries will also prevent the remote control from properly operating the projector.

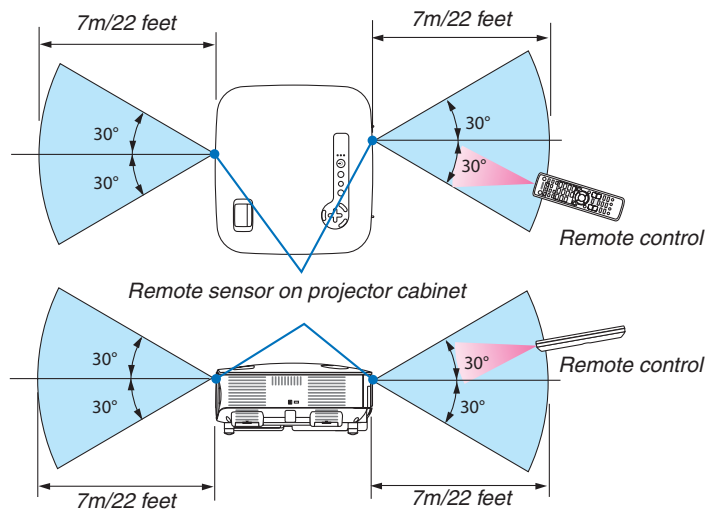

## Remote Control Precautions

- Handle the remote control carefully.
- If the remote control gets wet, wipe it dry immediately.
- Avoid excessive heat and humidity.
- Do not heat, take apart, or throw batteries into fire.
- If you will not be using the remote control for a long time, remove the batteries.
- Ensure that you have the batteries' polarity (+/-) aligned correctly.
- Do not use new and old batteries together, or use different types of batteries together.
- Dispose of used batteries according to your local regulations.

# 2. Installation and Connections

This section describes how to set up your projector and how to connect PCs, video and audio sources.

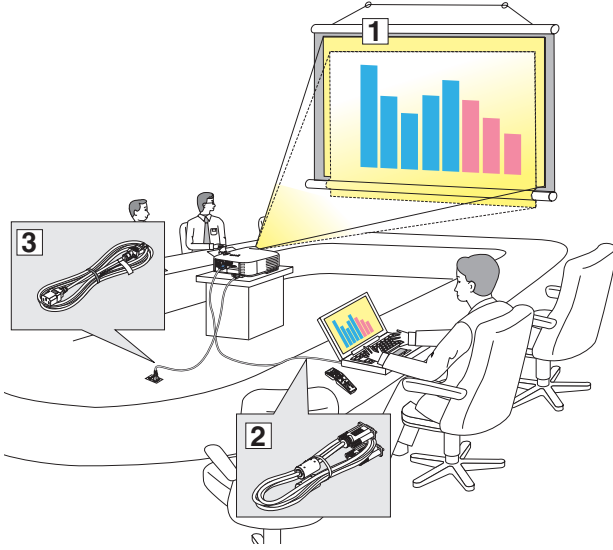

Your projector is simple to set up and use. But before you get started, you must first:

- 1 Set up a screen and the projector.
- 2 Connect your computer or video equipment to the projector. See pages 12 - 20.
- 3 Connect the supplied power cable. See page 21.

**NOTE:** Ensure that the power cable and any other cables are disconnected before moving the projector. When moving the projector or when it is not in use, cover the lens with the lens cap.

## 1 Setting Up the Screen and the Projector

### NP905

The further your projector is from the screen or wall, the larger the image. The minimum size the image can be is 21 inches (0.53 m) measured diagonally when the projector is 29 inches (0.73 m) from the wall or screen. The largest the image can be is 300 inches (7.62 m) when the projector is about 386 inches (9.8 m) from the wall or screen. Use the drawing below as a guide.

### Selecting a Location

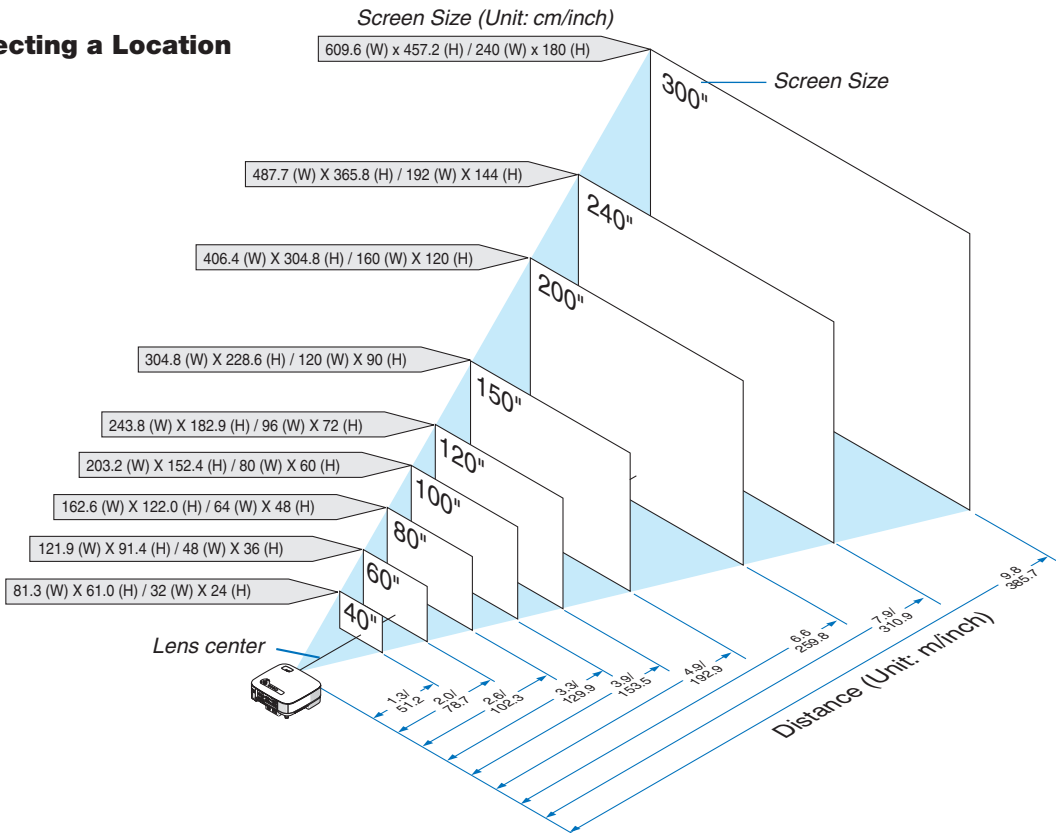

**TIP:** The screen sizes above are intermediate values between tele (minimum display area) and wide (maximum display area). Image size can be adjusted with the zoom adjustment up to a maximum of 10%.

For "Screen Size and Projection Distance", see page 136.



### NP901W

The further your projector is from the screen or wall, the larger the image. The minimum size the image can be is 20 inches (0.51 m) measured diagonally when the projector is roughly 26 inches (0.66 m) from the wall or screen. The largest the image can be is 300 inches (7.62 m) when the projector is about 403 inches (10.2 m) from the wall or screen. Use the drawing below as a guide.

### Selecting a Location

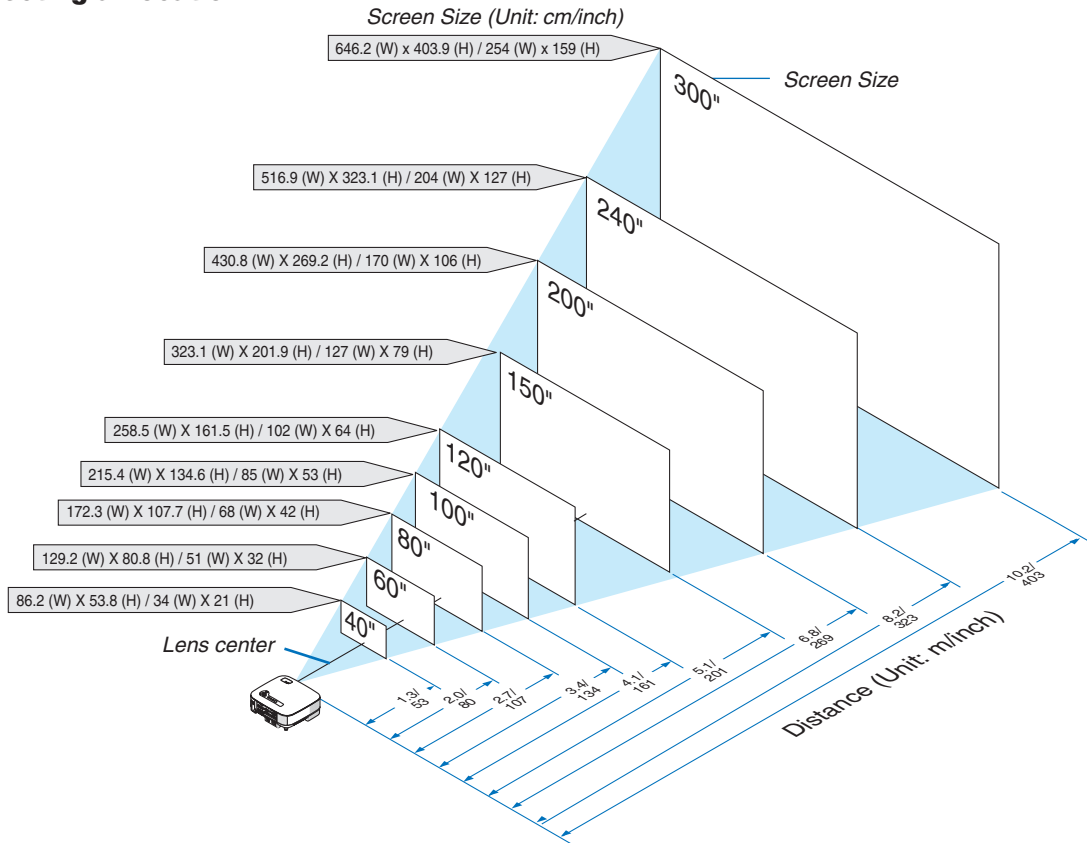

**TIP:** The screen sizes above are intermediate values between tele (minimum display area) and wide (maximum display area). Image size can be adjusted with the zoom adjustment up to a maximum of 10%. For "Screen Size and Projection Distance", see page 136.

## ② Making Connections

### Connecting Your PC or Macintosh Computer

*NOTE: When using with a notebook PC, be sure to connect the projector and notebook PC while the projector is in standby mode and before turning on the power to the notebook PC.*

*In most cases the output signal from the notebook PC is not turned on unless connected to the projector before being powered up.*

*\* If the screen goes blank while using your remote control, it may be the result of the computer's screen-saver or power management software.*

#### Enabling the computer's external display

Displaying an image on the notebook PC's screen does not necessarily mean it outputs a signal to the projector. When using a PC compatible laptop, a combination of function keys will enable/disable the external display. Usually, the combination of the 'Fn' key along with one of the 12 function keys gets the external display to come on or off. For example, NEC laptops use Fn + F3, while Dell laptops use Fn + F8 key combinations to toggle through external display selections.

*NOTE: The COMPUTER 1 IN and COMPUTER 2 IN connectors support Plug & Play (DDC2B).*

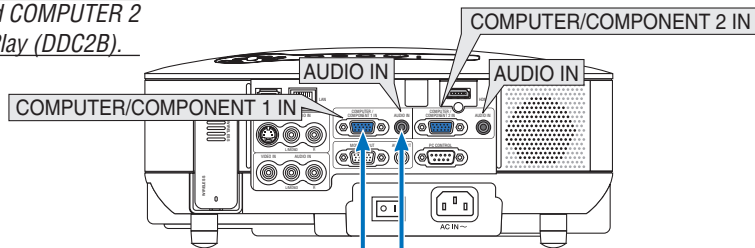

*NOTE: For older Macintosh, use a commercially available pin adapter (not supplied) to connect to your Mac's video port.*

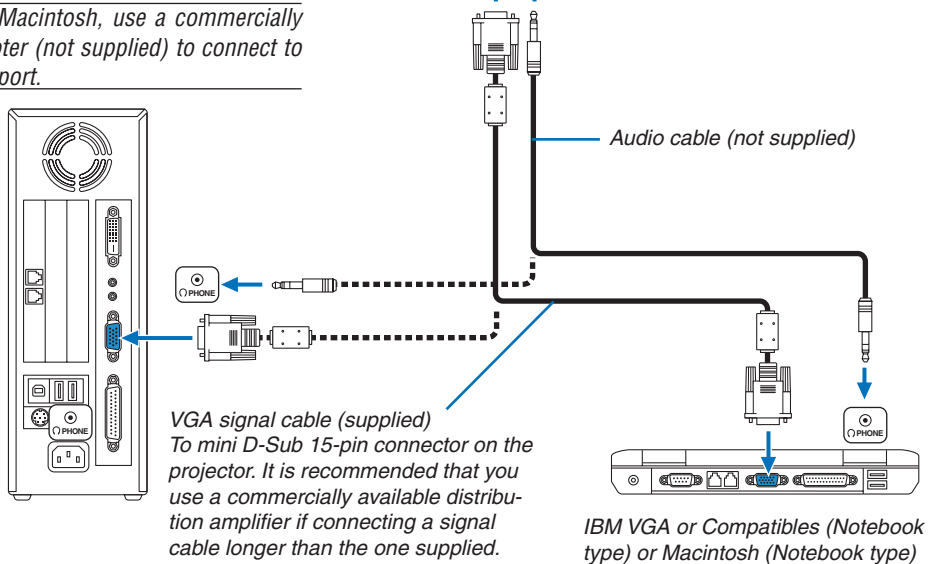

- First turn off the computer and the projector before making connections.
- Turn down the volume on the computer before connecting an audio cable to the headphone jack of the computer. After connecting the computer to the projector, you can adjust the sound level on the computer and the projector to your preference.
- You are recommended to connect an audio cable to an audio out connector (mini jack type) if any.

*NOTE: The NP905/NP901W is not compatible with video decoded outputs of either the NEC ISS-6020 or ISS-6010 switchers.*

## 2. Installation and Connections

*NOTE: An image may not be displayed correctly when a Video or S-Video source is played back via a commercially available scan converter.*

*This is because the projector will process a video signal as a computer signal at the default setting. In that case, do the following.*

- \* When an image is displayed with the lower and upper black portion of the screen or a dark image is not displayed correctly: Project an image to fill the screen and then press the AUTO ADJ button on the remote control or the AUTO ADJUST button on the projector cabinet.*

- If you have a PC with a DVI output, use a commercially available DVI-to-HDMI cable to connect the PC to the HDMI IN connector of the projector. Only the digital signal is available. Connect the AUDIO output of the PC to the COMPUTER/COMPONENT 2 AUDIO IN stereo mini jack, and in the menu select [HDMI SETTINGS] → [AUDIO SELECT] → [COMPUTER 2]. (→ page 116)

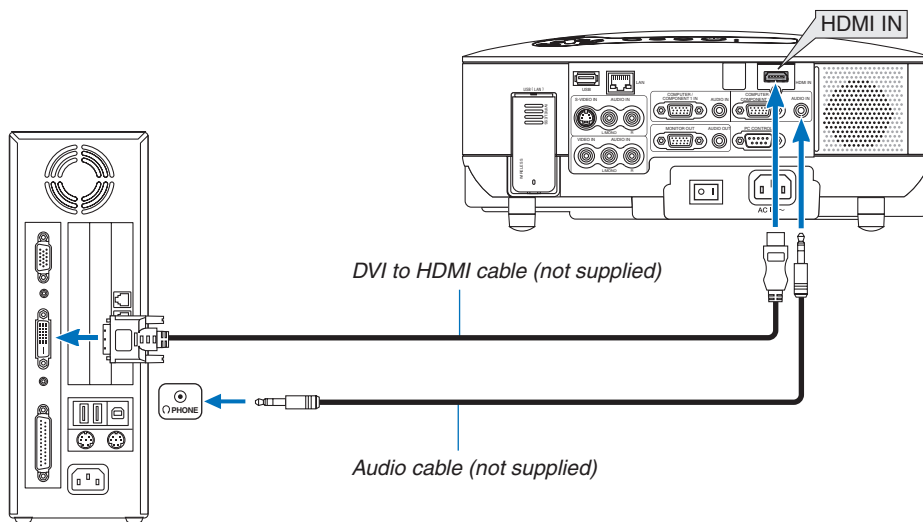

*NOTE: When Viewing a DVI Digital Signal*

- Use a DVI-to-HDMI cable with a length of 78" (2 m) or less.
- Turn off the projector and the PC before connecting the DVI-to-HDMI cable.
- To project a DVI digital signal: Connect the cables, turn the projector on, then select the HDMI input. Finally, turn on your PC. Failure to do so may not activate the digital output of the graphics card resulting in no picture being displayed. Should this happen, restart your PC.
- Some graphics cards have both analog RGB (15-pin D-Sub) and DVI(or DFP outputs). Use of the 15-pin D-Sub connector may result in no picture being displayed from the digital output of the graphics card.
- Do not disconnect the DVI-to-HDMI cable while the projector is running. If the signal cable has been disconnected and then re-connected, an image may not be correctly displayed. Should this happen, restart your PC.
- The HDMI IN connector accepts VGA (640 x 480), SVGA (800 x 600), XGA (1024 x 768), 1152 x 864, SXGA (1280 x 1024 @ up to 60Hz), and SXGA+ (1400 x 1050 @ 60Hz).

### Connecting an External Monitor

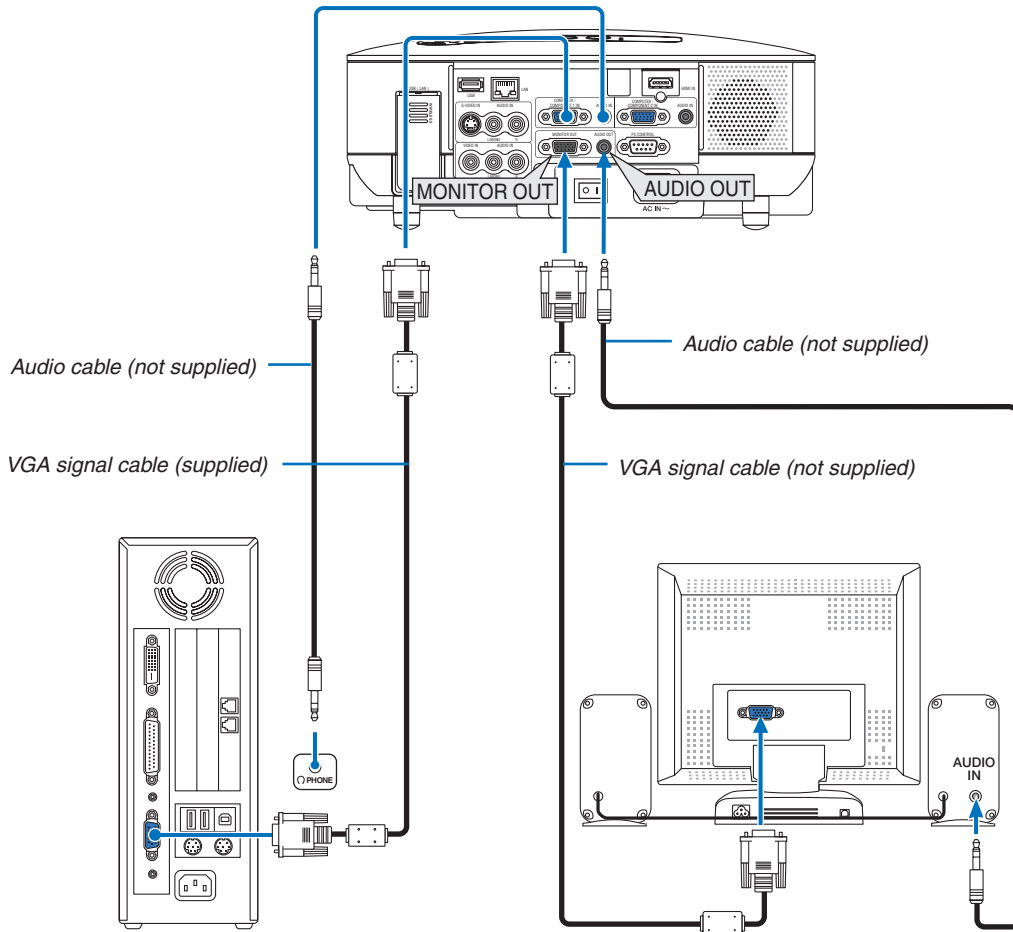

You can connect a separate, external monitor to your projector to simultaneously view on a monitor the RGB analog or component image you're projecting.

#### NOTE:

- *Daisy chain connection is not possible.*
- *The MONITOR OUT connector will not output video and sound (Digital signal) via the HDMI IN connector.*
- *When audio equipment is connected, the projector speaker is disabled.*
- *When [NORMAL] is selected from [STANDBY MODE], the MONITOR OUT connector outputs the last displayed video signal and the AUDIO OUT jack outputs the last audio signal. The sound level remains the same as the last one.*
- *Selecting [POWER-SAVING] in [STANDBY MODE] stops outputting a video signal from the MONITOR OUT connector during standby mode. This causes the AUDIO OUT jack to stop outputting sound.*

### Connecting Your HDMI Compatible Equipment

You can connect the HDMI output of your DVD player, hard disk player, or notebook type PC to the HDMI IN connector of your projector.

*NOTE: The HDMI IN connector supports Plug & Play (DDC2B).*

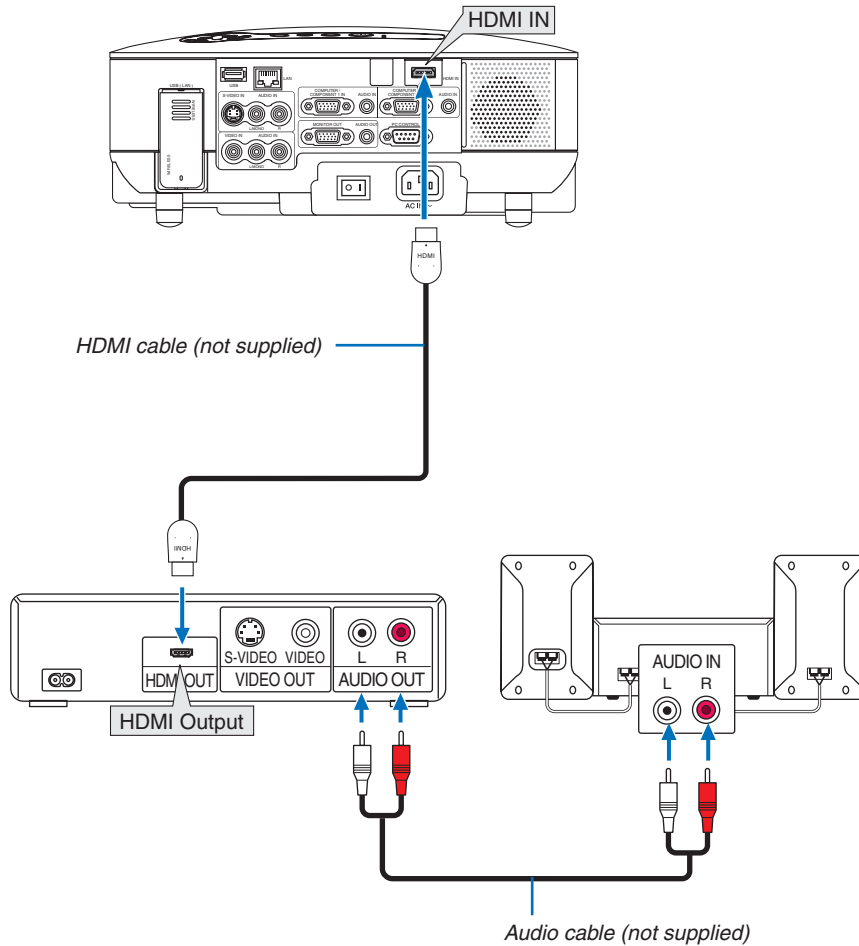

*NOTE: Use an HDMI connect cable for HIGH SPEED (HDMI Ver1.3a category 2 cable)*

**TIP:** For users of audio video equipment with an HDMI connector:

Select "Enhanced" rather than "Normal" if HDMI output is switchable between "Enhanced" and "Normal".

This will provide improved image contrast and more detailed dark areas.

For more information on settings, refer to the instruction manual of the audio video equipment to be connected.

- When connecting the HDMI IN connector of the projector to the DVD player, the projector's video level can be made settings in accordance with the DVD player's video level. In the menu select [HDMI SETTINGS] -> [VIDEO LEVEL] and make necessary settings.
- Acceptable signals are 480p, 720p, 1080i, and 1080p.
- If the HDMI input sound cannot be heard, in the menu select [HDMI SETTINGS] → [AUDIO SELECT] → [HDMI].

### What is HDCP/HDCP technology?

HDCP is an acronym for High-bandwidth Digital Content Protection. High bandwidth Digital Content Protection (HDCP) is a system for preventing illegal copying of video data sent over a Digital Visual Interface (DVI).

If you are unable to view material via the HDMI input, this does not necessarily mean the projector is not functioning properly. With the implementation of HDCP, there may be cases in which certain content is protected with HDCP and might not be displayed due to the decision/intention of the HDCP community (Digital Content Protection, LLC).

### Connecting Your DVD Player with Component Output

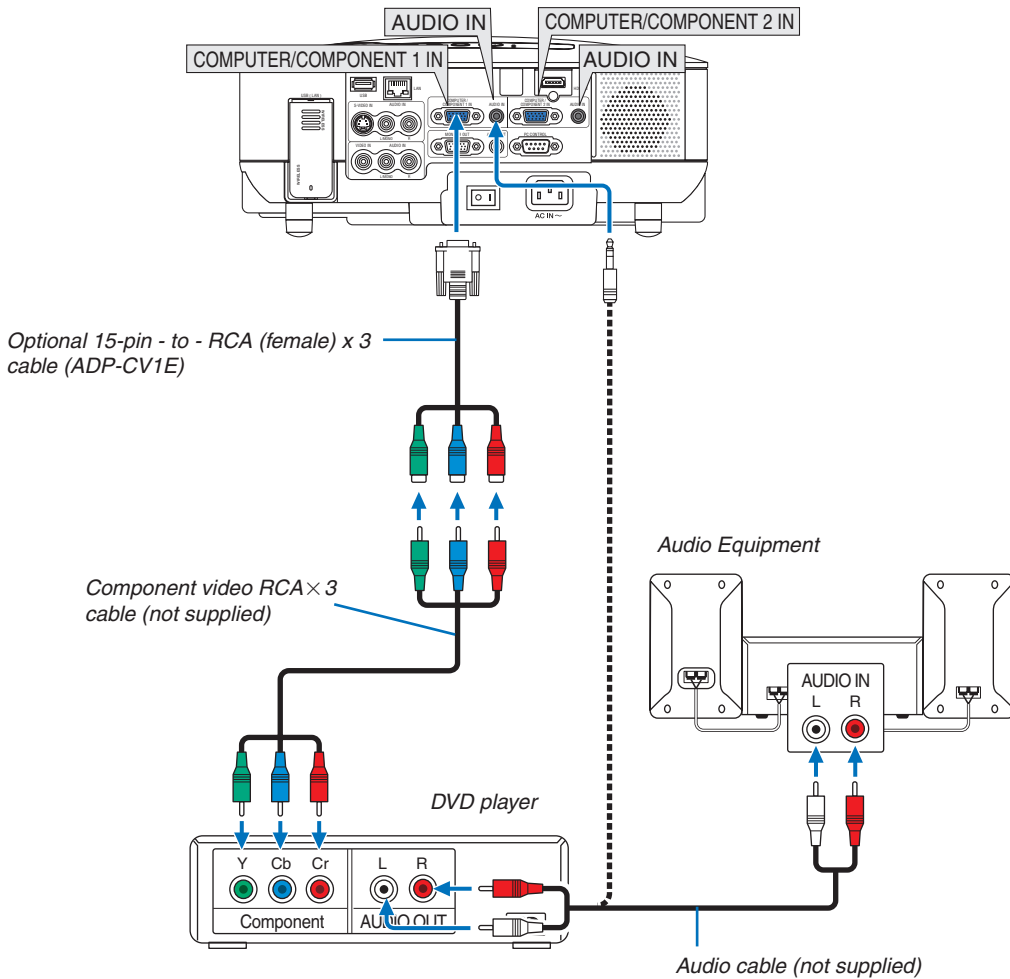

**TIP:** A component signal will be automatically displayed. If not, from the menu, select [SETUP] → [OPTIONS] → [SIGNAL SELECT] → [COMPUTER 1 (or 2)] → [COMPONENT].

**NOTE:** Refer to your DVD player's owner's manual for more information about your DVD player's video output requirements.

### Connecting Your VCR

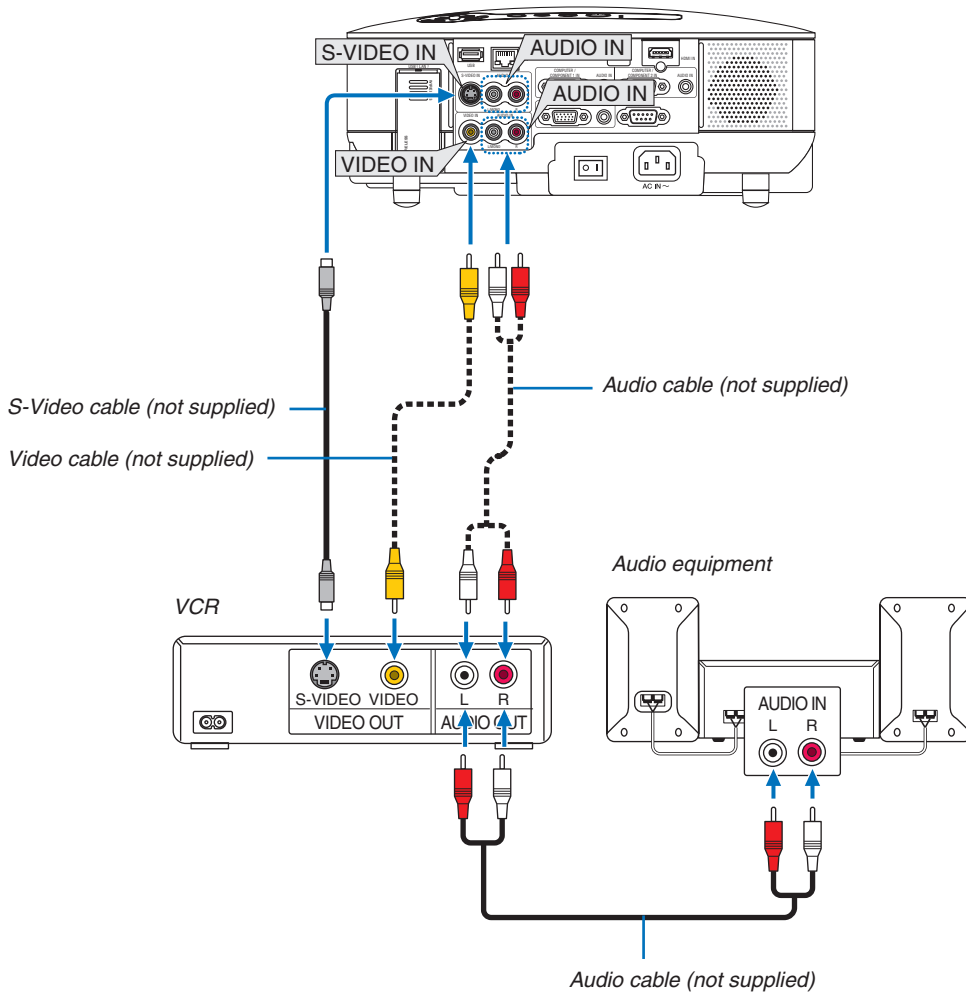

*NOTE: Refer to your VCR owner's manual for more information about your equipment's video output requirements.*

*NOTE: An image may not be displayed correctly when a Video or S-Video source is played back in fast-forward or fast-rewind via a scan converter.*

### Connecting to a Network

The NP905/NP901W comes standard with a LAN port (RJ-45) which provides a LAN connection using a LAN cable. The USB Wireless LAN Unit also provides a wireless LAN connection. To use a LAN connection, you are required to assign an IP address to the projector. For setting the NETWORK, see page 99. (From the menu, select [SETUP] → [INSTALLATION(2)] → [NETWORK SETTINGS])

---

*NOTE: Some NEC models does not come standard with the USB Wireless LAN Unit. If you buy such a projector, the optional USB Wireless LAN unit is required to make presentations via a wireless connection.*

---

With the LAN connection, two features are available: Projector control and Picture transmission.

#### Projector control feature

With the wired or wireless LAN connection, you can control (power on/off, input select, etc.) and receive information from the projector over the network using a computer. The following three methods are available:

- \* Using the HTTP Server feature on the projector. (→ page 51)
- \* Using PC Control Utility 3.0 from the supplied User Supportware 5 CD-ROM.
- \* Using Image Express Utility 2.0 from the supplied User Supportware 5 CD-ROM.

#### Picture transmission feature (Using WindowsVista)

A Windows Vista-based computer can be operated using the projector over a network. The projector supports the Network Projector function and the Remote Desktop function of Windows Vista. (→ page 54, 58)

#### Picture transmission feature (Using User Supportware 5 CD-ROM)

With the wired or wireless LAN connection, you can send images and slides from a personal computer to the projector which then can be projected on the screen. The following two methods are available:

- \* Using Image Express Utility 2.0 from the supplied User Supportware 5 CD-ROM.
- \* Using Ulead Photo Explorer 8.0 from the supplied User Supportware 5 CD-ROM.

With the USB mouse connected to the projector, you can also operate the desktop screen on your Windows PC connected to the LAN or the wireless LAN.

- \* Using Desktop Control Utility 1.0 from the supplied User Supportware 5 CD-ROM.

**TIP:** Five Windows software programs (Image Express Utility 2.0, Desktop Control Utility 1.0, Ulead Photo Explorer 8.0, Viewer PPT Converter and PC Control Utility 3.0) and a Macintosh software program (Image Express Utility 2 for Mac OS X) are contained on the supplied Projector User Supportware 5 CD-ROM. For their functions and operations, see the user's guides (PDF) contained on the same CD-ROM.

- For the procedure to connect the projector with the network (wireless LAN/wired LAN), refer to “Network Set-up Guide” attached.
- For the procedure to connect Windows Vista with the network (wireless LAN/wired LAN), refer to the manual of Windows Vista.



### Example of LAN connection

(A) Example of wired LAN connection

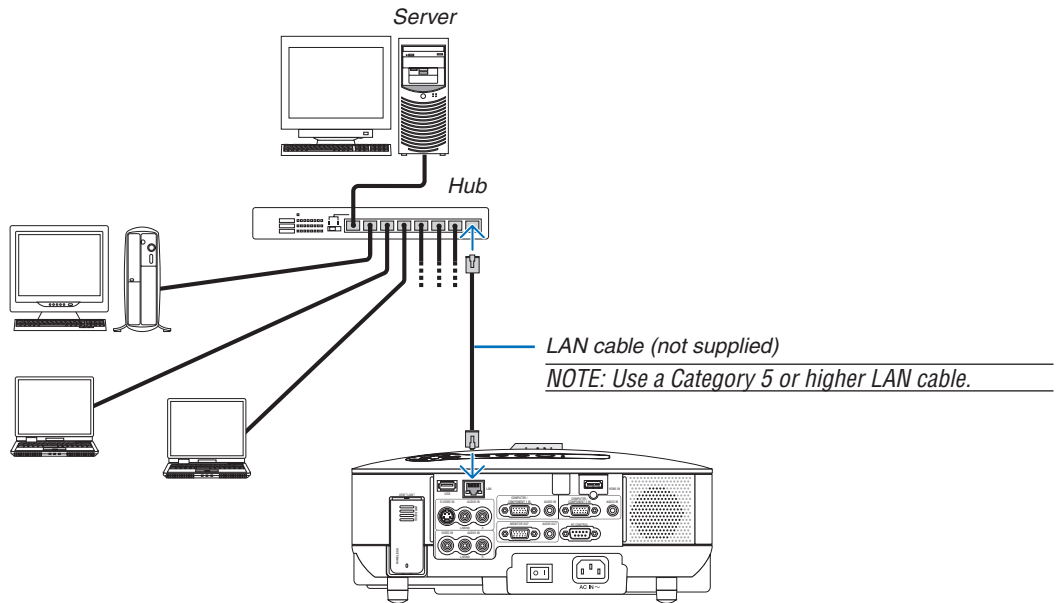

(B) Example of wireless LAN connection  
(Network Type → Infrastructure)

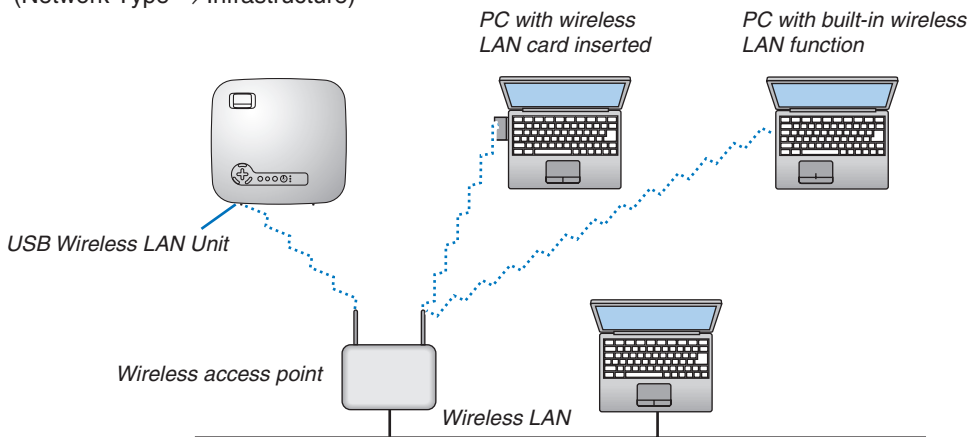

To make connection with wireless LAN via a wireless access point, you need to select the Infrastructure mode. From the menu, select [SETUP] → [INSTALLATION(2)] → [NETWORK SETTINGS] → [WIRELESS] → [ADVANCED] → [CONNECTION] → [NETWORK TYPE] → [INFRASTRUCTURE].

## 2. Installation and Connections

(C) Example of wireless LAN connection (Network Type → Ad Hoc)

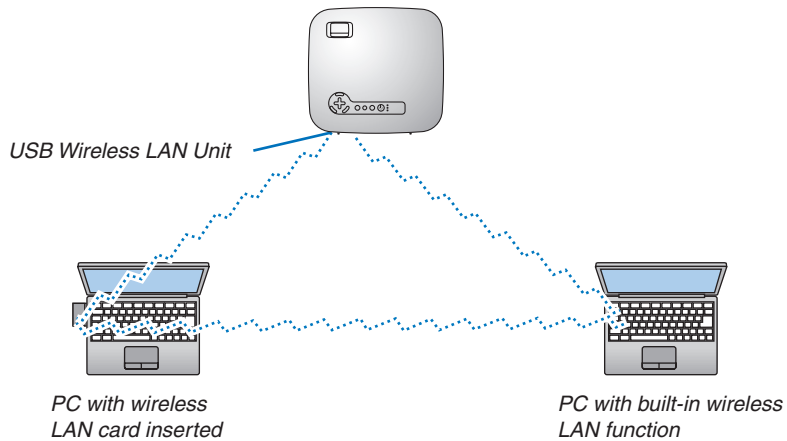

To enable direct communication (i.e., peer-to-peer) between personal computers and projectors, you need to select the Ad Hoc mode.

From the menu, select [SETUP] → [INSTALLATION(2)] → [NETWORK SETTINGS] → [WIRELESS] → [ADVANCED] → [CONNECTION] → [NETWORK TYPE] → [AD HOC].

The Ad Hoc mode complies with IEEE802.11 standard.

### Connecting the Supplied Power Cable

Connect the supplied power cable to the projector.

First connect the supplied power cable's three-pin plug to the AC IN of the projector, and then connect the other plug of the supplied power cable in the wall outlet.

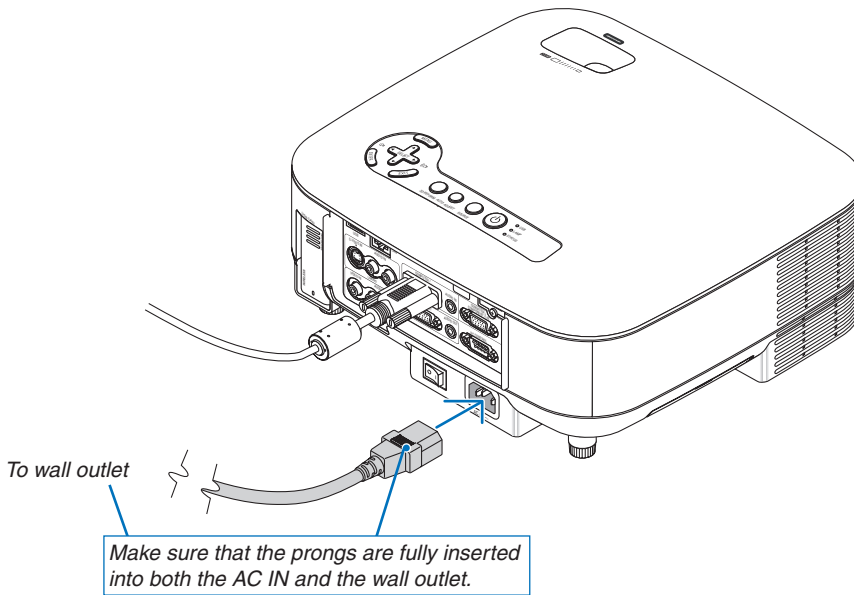

### About Direct Power Off

The projector has a feature called "Direct Power Off". This feature allows the projector to be turned off (even when projecting an image) using a power strip equipped with a switch and a breaker.

#### **⚠ CAUTION:**

Do not try to touch the ventilation outlet on the left front (when seen from the front) as it can become heated while the projector is turned on and immediately after the projector is turned off.

#### **⚠ CAUTION:**

Do not unplug the power cable from the wall outlet or projector when the projector is powered on. Doing so can cause damage to the AC IN connector of the projector and (or) the prong plug of the power cable.

**TIP:** To turn off the AC power supply when the projector is powered on, use a power strip equipped with a switch and a breaker.

**TIP:** The projector can be unplugged during its cool down period after it is turned off.

# 3. Projecting an Image (Basic Operation)

This section describes how to turn on the projector and to project a picture onto the screen.

## 1 Turning on the Projector

### NOTE:

- The projector has two power switches: a main power switch and a POWER button (POWER ON and OFF on the remote control).
- When plugging in or unplugging the supplied power cable, make sure that the main power switch is pushed to the off (O) position. Failure to do so may cause damage to the projector.
- The projector has a feature to prevent itself from being used by unauthorized individuals. To use this feature, register a key-word. (→ page 43)

### 1. Remove the lens cap.

- Do not try to remove the lens cap by pulling on the string. Doing so can cause damage.

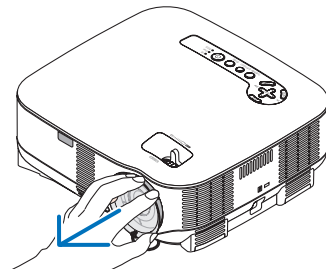

### 2. To turn on the main power to the projector, press the Main Power switch to the on position (I).

- The projector will go into standby mode. When in standby mode, the POWER indicator will light orange and the STATUS indicator will light green.

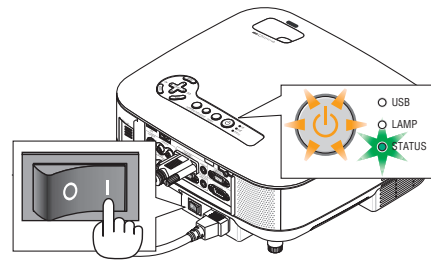

### 3. After making sure that the projector is in standby mode, press the POWER or POWER (ON) button for a minimum of 2 seconds when the STATUS indicator goes off and the POWER indicator starts blinking.

**When the POWER indicator turns a steady green, and the projector is ready to use.**

- After you turn on your projector, ensure that the computer or video source is turned on and that your lens cap is removed.

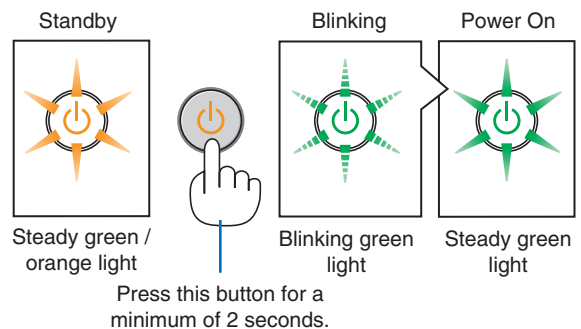
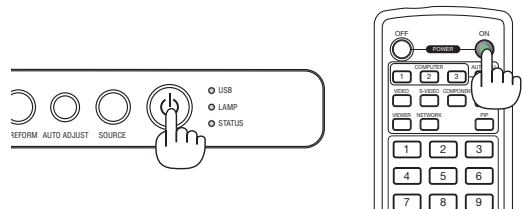

(→ page 128)

NOTE: When no signal is available, a blue, black or logo screen is displayed.

### 3. Projecting an Image (Basic Operation)

#### Note on Startup screen (Menu Language Select screen)

When you first turn on the projector, you will get the Startup menu. This menu gives you the opportunity to select one of the 21 menu languages.

To select a menu language, follow these steps:

1. Use the **SELECT** button to select one of the 21 languages for the menu.

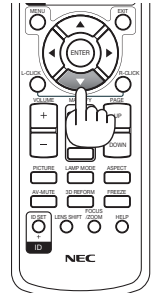
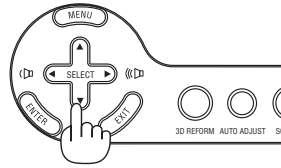

2. Press the **ENTER** button to execute the selection.

After this has been done, you can proceed to the menu operation.

If you want, you can select the menu language later. (→ [LANGUAGE] on page 94)

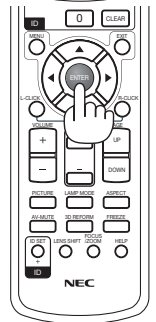
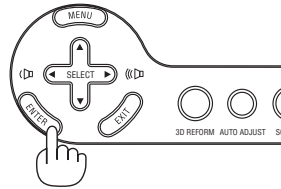

#### NOTE:

- The projector cannot be turned off for 60 seconds after the lamp is turned on and while the POWER indicator is blinking green.
- If you turn on the projector immediately after the lamp is turned off or when the ambient temperature is high, the cooling fans will run for a moment and then you will get an image on the screen.
- Immediately after turning on the projector, screen flicker may occur. This is normal. Wait 3 to 5 minutes until the lamp lighting is stabilized.

- When the Lamp mode is set to Eco, the Lamp indicator will light green.
- If one of the following things happens, the projector will not turn on.
  - If the internal temperature of the projector is too high, the projector detects abnormal high temperature. In this condition the projector will not turn on to protect the internal system. If this happens, wait for the projector's internal components to cool down.
  - When the lamp reaches its end of usable life, the projector will not turn on. If this happens, replace the lamp. (→ page 125)
  - If the lamp fails to light, and if the STATUS indicator flashes on and off in a cycle of six times, wait a full minute and then turn on the power.

#### NOTE: Turning the Main Power Switch Off then Back On

Allow a minimum of 5 seconds between turning off the main power switch and turning it back on again.

The same will be applied when a power strip equipped with a switch and a breaker is used.

Failing to do so could result in no power to the projector. (There will be no stand-by LED)

Should this happen, unplug the power cable and plug it in again. Turn on the main power switch.

## 2 Selecting a Source

### Selecting the computer or video source

#### Selecting from Source List

Press and quickly release the SOURCE button on the projector cabinet to display the Source list. Each time the SOURCE button is pressed, the input source will change as follows: "COMPUTER 1/2", "HDMI", "VIDEO" (VCR), "S-VIDEO", "VIEWER" (slides on a USB memory) or "NETWORK" (LAN port [RJ-45] or installed USB wireless LAN unit).

To display the selected source, press the ENTER button.

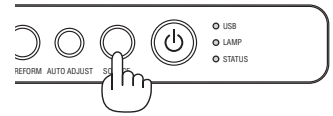

#### Detecting the Signal Automatically

Press and hold the SOURCE button for a minimum of 1 second, the projector will search for the next available input source. Each time you press and hold the SOURCE button for a minimum of 1 second, the input source will change as follows:

COMPUTER1 → COMPUTER2 → HDMI → VIDEO → S-VIDEO → VIEWER → COMPUTER1 → ...

If no input signal is present, the input will be skipped. When the input source you wish to project is displayed, release the button.

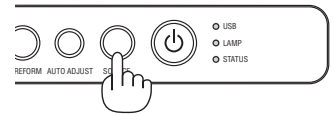

#### Using the Remote Control

Press any one of the COMPUTER 1/2, HDMI, VIDEO, S-VIDEO, VIEWER or NETWORK buttons.

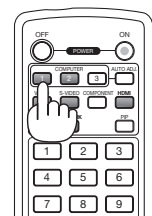

## ③ Adjusting the Picture Size and Position

Use the adjustable tilt foot lever, the zoom lever or the focus ring to adjust the picture size and position.

Adjusting the throw angle (the height of an image)  
[Tilt foot]

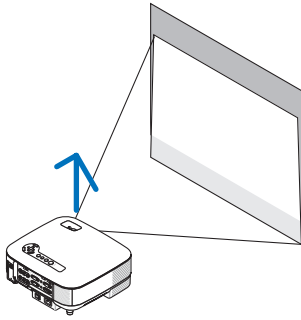

(→ page 27)

Adjusting the focus  
[Focus ring]

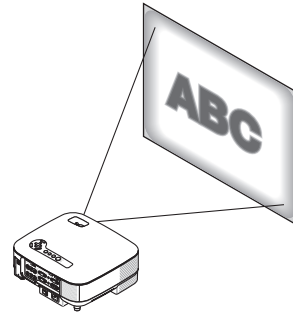

Adjusting the left and right tilt of an image  
[Rear foot]

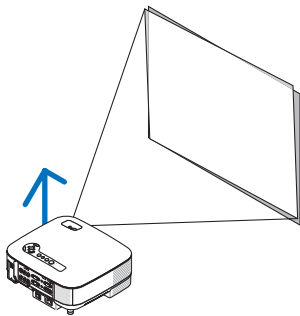

Finely adjusting the size of an image  
[Zoom lever]

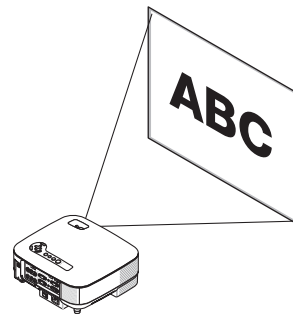

Adjusting the keystone correction  
[Keystone] \*

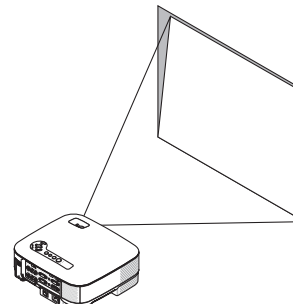
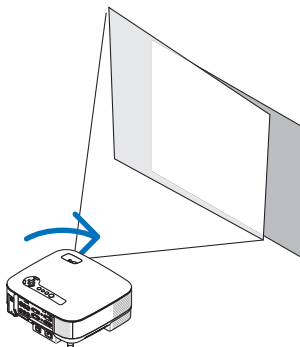

NOTE\*: See “④ Correcting Keystone Distortion” on page 28 for Keystone.

\* In the above drawings, cables are omitted for clarity.

### 3. Projecting an Image (Basic Operation)

#### Adjusting the focus (Focus ring)

- Rotate the focus ring to make focus adjustment.

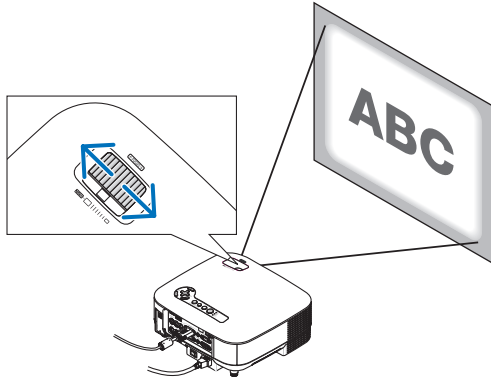

#### Finely adjusting the size of an image (Zoom lever)

- Rotate the zoom lever to adjust the image size on the screen.

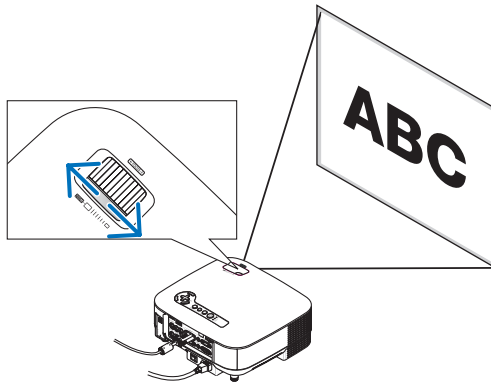



### 3. Projecting an Image (Basic Operation)

#### Adjusting the Tilt Foot

1. Lift the front edge of the projector.



**CAUTION:**

Do not try to touch the ventilation outlet during Tilt Foot adjustment as it can become heated while the projector is turned on and during its cool down period after it is turned off.

2. Push up the Adjustable Tilt Foot Lever on the front of the projector to extend the adjustable tilt feet (maximum height).

3. Lower the front of the projector to the desired height.

4. Release the Adjustable Tilt Foot lever to lock the Adjustable tilt foot.

There is approximately 10 degrees (up) of adjustment for the front of the projector.

**TIP:** For operating the [KEYSTONE] screen, see “4 Correcting Keystone Distortion” on page 28.

**NOTE:** Your “Keystone” correction data can be reset by pressing and holding the 3D REFORM button for a minimum of 2 seconds.



**CAUTION:**

Do not use the tilt-foot for purposes other than originally intended. Misuses such as using the tilt foot to carry or hang (from the wall or ceiling) the projector can cause damage to the projector.

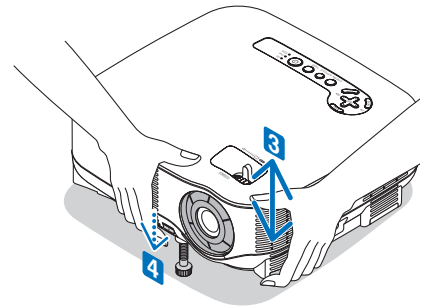
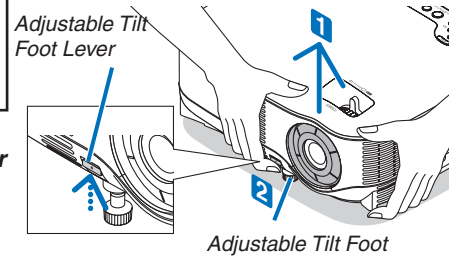

The rear foot height can be adjusted up to 0.5 inch/13 mm. Rotate the rear foot to the desired height in order to square the image on the projection surface, but the vertical distance from the bottom to the desk or floor should be 0.5 inch /13mm to make the projector horizontal on the flat surface.

#### 4 Correcting Keystone Distortion

When the projector is not exactly perpendicular to the screen, keystone distortion occurs. To overcome it, you can use the “Keystone” function, a digital technology that can adjust for keystone-type distortion, resulting in a crisp, square image. The following procedure explains how to use the [KEystone] screen from the menu to correct trapezoidal distortions.

When the projector is set up at an angle in relation to the screen, adjust the Horizontal option of the Keystone menu so that the top and bottom of sides of the projected image are parallel.

##### Auto Keystone Correction

The Auto Keystone correction feature will correct vertical distortion of a projected image on the screen. No special operation required. Just put the projector on a flat surface.

To use the Auto Keystone function, first you must select [AUTO KEYSTONE] in [KEYSTONE] from the menu.

##### Manual Keystone Correction

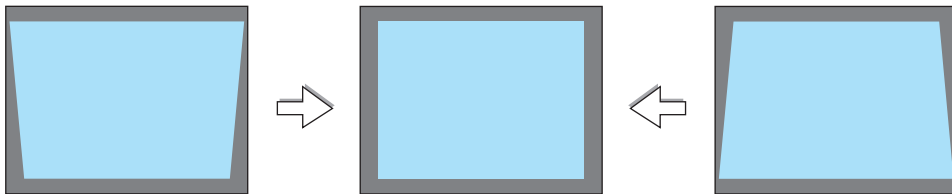

1. Press the 3D REFORM button on the remote control or the projector cabinet.

The Keystone screen will be displayed on the screen.



2. Press the SELECT ▼ button to select [VERTICAL] and then use the SELECT ◀ or ▶ so that the left and right sides of the projected image are parallel.

\* Adjust the vertical keystone distortion.

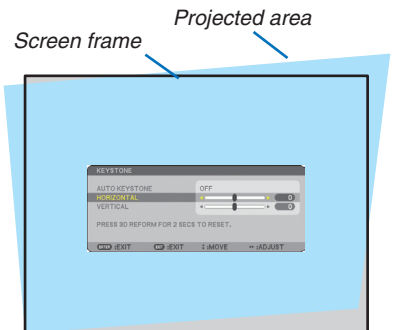

3. Align the left (or right) side of the screen with the left (or right) side of the projected image.

- Use the shorter side of the projected image as the base.
- In the right example, use the left side as the base.

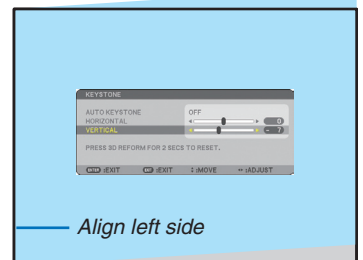

4. Press the SELECT ▲ button to select [HORIZONTAL] and then use the SELECT ◀ or ▶ so that the top and bottom sides of the projected image are parallel.

- Adjust the horizontal keystone distortion.

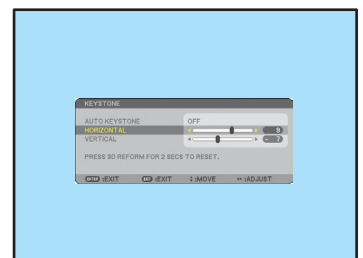

### 3. Projecting an Image (Basic Operation)

5. Repeat steps 2 and 4 to correct keystone distortion.

6. After completing Keystone correction, press the EXIT button.

The Keystone screen will disappear.

- To perform Keystone correction again, press the 3D REFORM button to display the Keystone screen and repeat above steps 1 to 6.

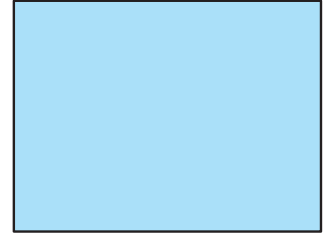

---

**NOTE:**

- If the projection angle is the same as in the last use, the previous correction setting values are retained in the memory. To use the previous correction setting values after changing projection angle, select [ON] in [AUTO KEYSTONE] from the menu. (→ page 87)
  - When doing Step 2, adjust the position of image so that the screen is smaller than the area of the projected area.
  - To reset the 3D Reform correction setting values, press and hold the 3D REFORM button for a minimum of 2 seconds.
  - Each time the 3D REFORM button is pressed, the item will change as follows: KEYSTONE → CORNERSTONE → None → KEYSTONE → ...
- For information on [CORNERSTONE], see “Correcting Horizontal and Vertical Keystone Distortion (Cornerstone)” on page 38.
- The Cornerstone adjustment will not be available during the Keystone adjustment. To perform the Cornerstone adjustment, press and hold the 3D REFORM button for a minimum of 2 seconds to reset the Keystone correction setting values. The Keystone adjustment will not be available during the Cornerstone adjustment. To perform the Keystone adjustment, press and hold the 3D REFORM button for a minimum of 2 seconds to reset the Cornerstone correction setting values.
  - The 3D Reform feature can cause an image to be slightly blurred because the correction is made electronically.
-

## 5 Optimizing an RGB Image Automatically

### Adjusting the Image Using Auto Adjust

Optimizing an RGB image automatically.

Press the AUTO ADJUST button to optimize an RGB image automatically.

This adjustment may be necessary when you connect your computer for the first time.

[Poor picture]

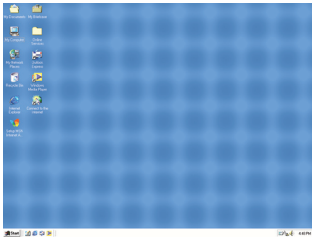

[Normal picture]

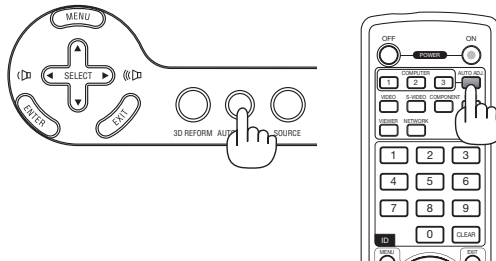
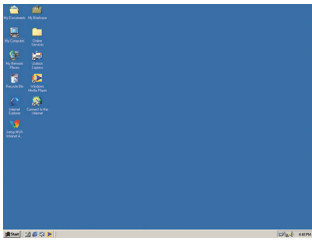

#### NOTE:

- Some signals may take time to display or may not be displayed correctly.
- The Auto Adjust function does not work for component, video signals.
- If the Auto Adjust operation cannot optimize the RGB signal, try to adjust Clock and Phase manually. (→ page 81)

## 6 Adjusting Volume Up & Down

Sound level from the speaker and the AUDIO OUT jack (Stereo mini) on the projector can be adjusted.

Another way to adjust volume is to use the menu. Select [ADJUST] → [AUDIO] → [VOLUME] from the menu.

#### NOTE:

- Volume control is not available with the SELECT ◀ or ▶ button when an image is enlarged by using the MAGNIFY (+) button or when the menu is displayed.

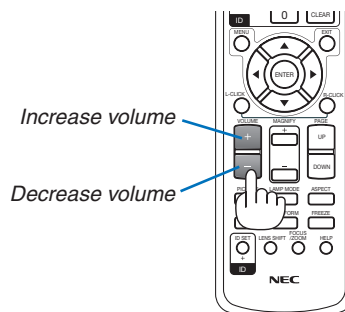
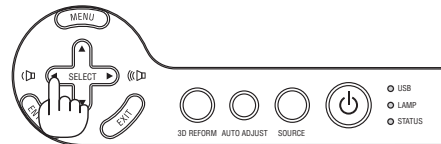

## 7 Turning off the Projector

To turn off the projector:

1. Press the **POWER** button on the projector cabinet or the **POWER OFF** button on the remote control. The [POWER OFF / ARE YOU SURE?] message will appear.

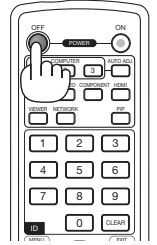
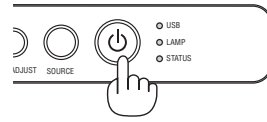

2. Press the **ENTER** button

After the projector turns off, the cooling fans keep operating for a while (Cooling-off time).

The cooling fans stop operating when the projector turns off and goes into standby mode.

When in standby mode, the **POWER** indicator will light orange and the **STATUS** indicator will light green.

3. After making sure that the projector is in standby mode, turn off the **Main Power switch**. The power indicator will go out.

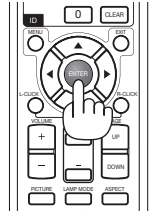
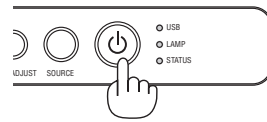

#### About Direct Power Off

The projector has a feature called "Direct Power Off". This feature allows the projector to be turned off (even when projecting an image) using a power strip equipped with a switch and a breaker.

#### CAUTION

- Do not unplug the power cable from the wall outlet or projector when the projector is powered on. Doing so can cause damage to the AC IN connector of the projector and (or) the prong plug of the power cable. To turn off the AC power supply when the projector is powered on, use a power strip equipped with a switch and a breaker.
- Do not turn off the AC power supply within 10 seconds of making adjustment or setting changes and closing the menu. Doing so can cause loss of adjustments and settings and return to default.

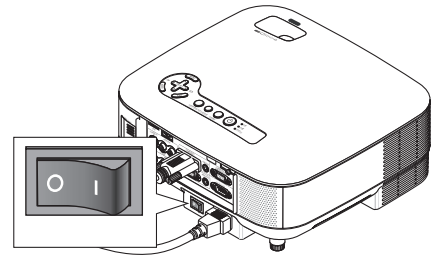

**TIP:** The projector can be unplugged during its cool down period after it is turned off.

## 8 After Use

**Preparation:** Make sure that the main power is turned off.

1. **Unplug the power cable.**
2. **Disconnect any other cables.**
3. **Retract adjustable tilt feet if extended.**
4. **Cover the lens with the lens cap.**
5. **Put the projector and accessories in the supplied soft case.**

Place the projector in the soft case with the lens facing upward as shown below. This is to prevent the lens from damage.

Insert the projector with  
the lens facing upward

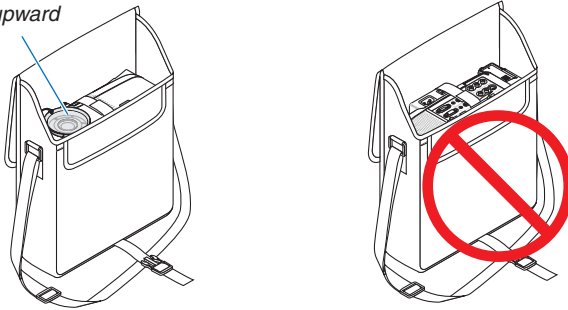

---

**NOTE:** When placing the projector in the soft case, retract the tilt foot and the rear feet. Failure to do so may cause damage to the projector.

---

**⚠ CAUTION:**

Use caution when putting the projector in the soft case immediately after the projector has been operating. The projector cabinet is hot.

# 4. Convenient Features

## ① Turning Off the Image and Sound

Press the AV-MUTE button to turn off the image and sound for a short period of time. Press again to restore the image and sound.

*NOTE: Even though the image is turned off, the menu still remains on the screen.*

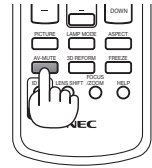

## ② Freezing a Picture

Press the FREEZE button to freeze a picture. Press again to resume motion.

*NOTE: The image is frozen but the original video is still playing back.*



## ③ Enlarging and Moving a Picture

You can enlarge the area you want up to 400 percent.

To do so:

### 1. Press the MAGNIFY (+) button.

Each time the MAGNIFY (+) button is pressed, the image is magnified.

\* Image can be magnified up to 400%

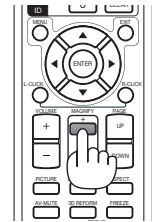
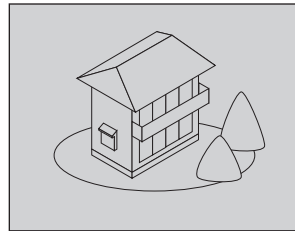

### 2. Press the SELECT ▲▼◀▶ button.

The area of the magnified image will be moved.

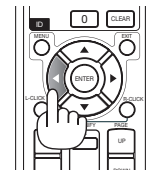
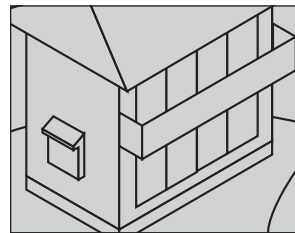

### 3. Press the MAGNIFY (-) button.

Each time the MAGNIFY (-) button is pressed, the image is reduced.

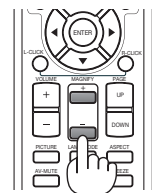

## 4 Changing Lamp Mode

The lamp life can be extended by using the Eco mode.

To change to the [ECO] mode, do the following:

1. Press the **LAMP MODE** button to display [LAMP MODE] screen.
2. Use the **SELECT ▲** or **▼** button to select [ECO] mode.
3. Press the **ENTER** button.

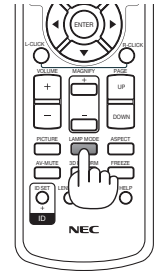

To cancel it, press the **EXIT** button.

To change from [ECO] to [NORMAL], Go back to Step 2 and select [NORMAL]. Repeat Step 3.

Lamp Mode	Description	Status of LAMP indicator
NORMAL MODE	This is the Default setting (100% Brightness).	Off
ECO MODE	Select this mode to increase the lamp life (approx. 80% Brightness light output)	Steady Green light

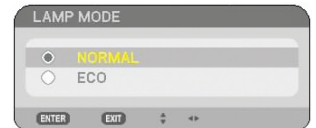

**NOTE:**

- The projector is always in [NORMAL MODE] for one minute after the lamp is turned on and while the POWER indicator is blinking green. The lamp condition will not be affected even when [LAMP MODE] is changed.
- After a lapse of one minute from when the projector displays a blue, black or logo screen, [LAMP MODE] will automatically switch to [ECO MODE].

The projector will return to the [NORMAL MODE] once a signal is accepted.

## 5 Getting Integrated Help

You get the contents about Help in English, German and Japanese.

1. Press the **HELP** button on the remote control.
  - When no menus appear, the “How to Use Help” screen will be displayed.
  - When menus appear, the screen will be displayed, explaining the function of a highlighted item.
2. Use the **SELECT ▲** or **▼** button to scroll the viewing area.
3. Press the **EXIT** button.
  - The Help will be closed.

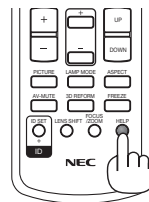

Display Help

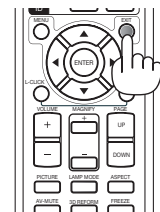

Exit Help



## 6 Using a USB Mouse

Using a USB mouse gives you a smooth operation. A commercially available USB mouse can be used.

Menu items that can be operated with your USB mouse are:

- VIEWER
- NETWORK
- ENTRY LIST
- TOOLS
- SECURITY SETTINGS
- NETWORK SETTINGS
- CORNERSTONE

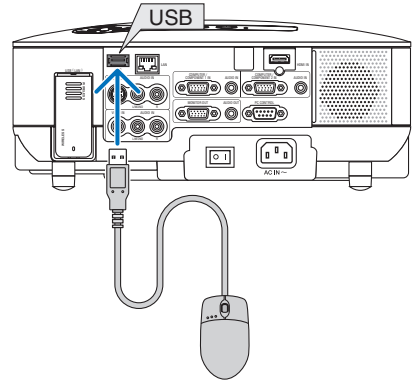

*NOTE: We do not warrant that the USB port of the projector will support all USB mouse devices in the market.*

### Operate the Menus using the USB mouse

#### Mouse Cursor

When connecting a USB mouse to the projector, you get a mouse cursor on the screen. Unless you use your USB mouse within 10 seconds, the mouse cursor disappears.

#### Adjusting and Setting Display

You can select a menu item and click with the left mouse button to make adjustments and settings. With the middle button you can use a scroll bar in the menu or the help.

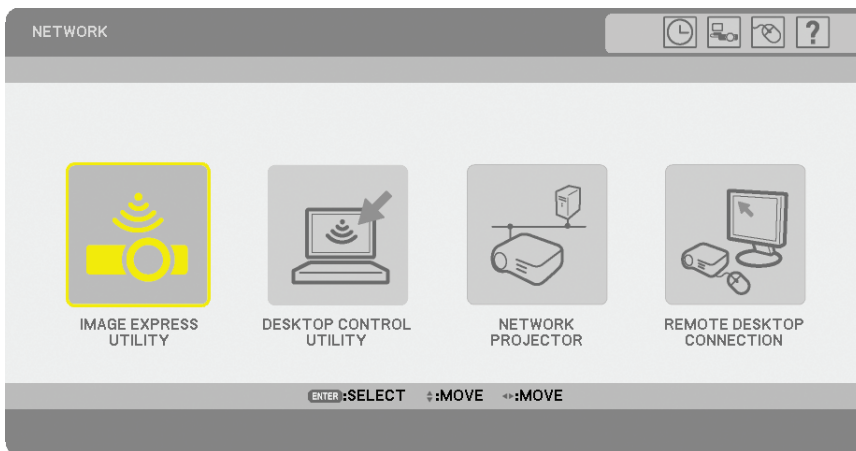

Icons on the top right of the menu



- Click [Clock] symbol to display the [DATE, TIME PRESET] menu.
- Click [Network] symbol to display the [NETWORK SETTINGS] menu. (→ page 99)
- Click [Mouse] symbol to display the [MOUSE] menu.
- Click [?] to display a selection of the selected menu item.

### ⑦ Using the Supplied Remote Mouse Receiver

The remote mouse receiver enables you to operate your computer's mouse functions from the remote control. It is a great convenience for your computer-generated presentations.

#### Connecting the remote mouse receiver to your computer

If you wish to use the remote mouse function, connect the mouse receiver and computer. The mouse receiver can be connected directly to the computer's USB port (type A).

---

*NOTE: Depending on the type of connection or OS installed on your computer, you may have to restart your computer or change your computer settings.*

---

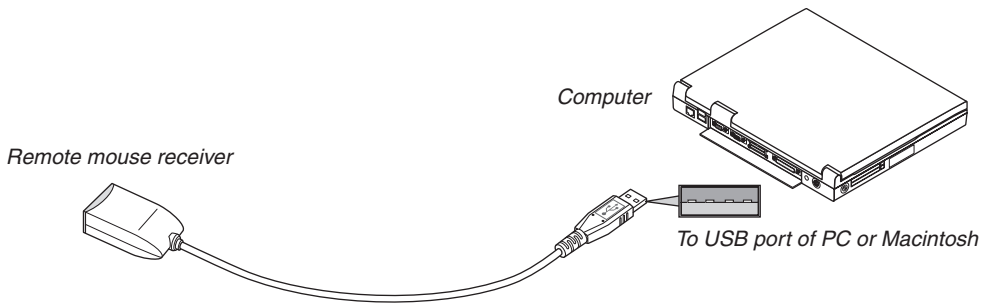

#### When operating a computer via the remote mouse receiver

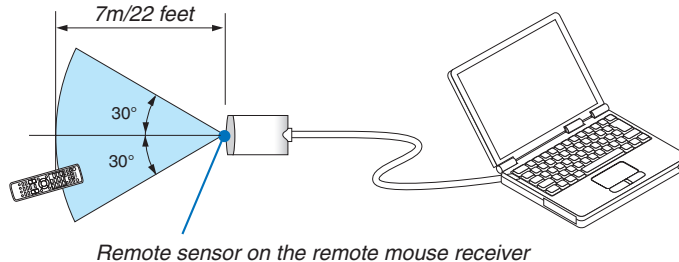

#### When connecting using the USB port

For PC, the mouse receiver can only be used with a Windows 98/Me/XP\*, Windows 2000, Windows Vista, or Mac OS X 10.0.0 or later operating system.

---

\* *NOTE: In SP1 or older version of Windows XP, if the mouse cursor will not move correctly, do the following: Clear the Enhance pointer precision check box underneath the mouse speed slider in the Mouse Properties dialog box [Pointer Options tab].*

- *The PAGE UP and DOWN buttons do not work with PowerPoint for Macintosh.*
- 

*NOTE: Wait at least 5 seconds after disconnecting the mouse receiver before reconnecting it and vice versa. The computer may not identify the mouse receiver if it is repeatedly connected and disconnected in rapid intervals.*

---

### Operating your computer's mouse from the remote control

You can operate your computer's mouse from the remote control.

PAGE UP/DOWN Button.....scrolls the viewing area of the window or to move to the previous or next slide in PowerPoint on your computer.

SELECT ▲▼◀▶ Button .....moves the mouse cursor on your computer.

MOUSE L-CLICK Button .....works as the mouse left button.

MOUSE R-CLICK Button .....works as the mouse right button.

---

#### NOTE:

- When you operate the computer using the SELECT ▲▼◀▶ button with the menu displayed, both the menu and the mouse pointer will be affected. Close the menu and perform the mouse operation.
  - The PAGE UP and DOWN buttons do not work with PowerPoint for Macintosh.
- 

#### About Drag Mode:

By pressing the MOUSE L-CLICK or R-CLICK button for 2 or 3 seconds then releasing, the drag mode is set and the drag operation can be performed simply by pressing the SELECT ▲▼◀▶ button. To drop the item, press the MOUSE L-CLICK (or R-CLICK) button. To cancel it, press the MOUSE R-CLICK (or L-CLICK) button.

**TIP:** You can change the Pointer speed on the Mouse Properties dialog box on the Windows. For more information, see the user documentation or online help supplied with your computer.

## 8 Correcting Horizontal and Vertical Keystone Distortion (Cornerstone)

Use the 3D Reform feature to correct keystone (trapezoidal) distortion to make the top or bottom and the left or right side of the screen longer or shorter so that the projected image is rectangular.

### Cornerstone

1. Press and hold the 3D REFORM button for a minimum of 2 seconds to reset current adjustments.  
Current adjustments for [KEystone] or [CORNERSTONE] will be cleared.
2. Project an image so that the screen is smaller than the area of the raster.
3. Pick up any one of the corners and align the corner of the image with a corner of the screen.

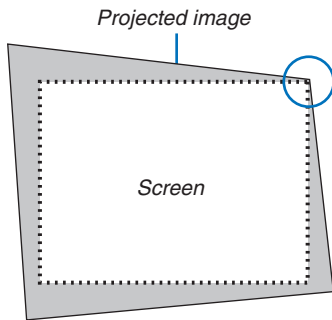

The drawing shows the upper right corner.

#### TIP:

NP905: When [WIDE SCREEN] is selected from [SCREEN TYPE], lines that show "16:9" will be displayed. Click the outer corners.

NP901W: When [4:3 SCREEN] is selected from [SCREEN TYPE], lines that show "4:3" will be displayed. Click the outer corners.

4. Press the 3D REFORM button twice.

The Cornerstone adjustment screen is displayed.

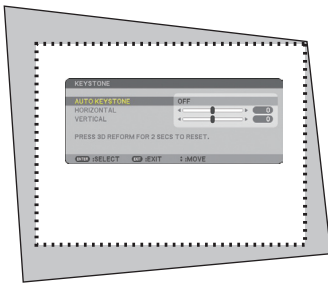

**TIP:** If you are adjusting [KEYSTONE], [CORNERSTONE] will not be available. If this happens, press and hold the 3D REFORM button for a minimum of 2 seconds to reset the [KEYSTONE] adjustments.



The drawing shows the upper left icon (▲) is selected.

5. Use the SELECT ▲▼◀▶ button to select one icon (▲) which points in the direction you wish to move the projected image frame.
6. Press the ENTER button.

7. Use the **SELECT ▲▼◀▶** button to move the projected image frame as shown on the example.

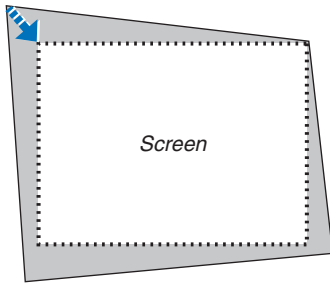

8. Press the **ENTER** button.

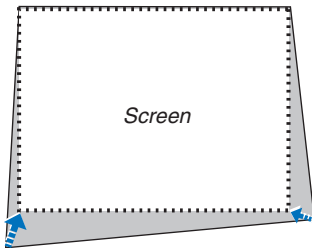

9. Use the **SELECT ▲▼◀▶** button to select another icon which points in the direction.

On the Cornerstone adjustment screen, select [EXIT] or press the EXIT button on the remote control.

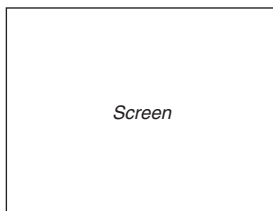

The confirmation screen is displayed.

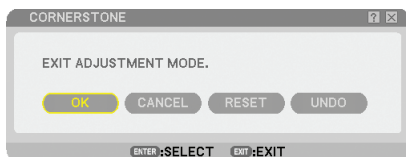

10. Press the **SELECT ◀ or ▶** button to highlight the [OK] and press the **ENTER** button.

This completes the Cornerstone correction.

Selecting [CANCEL] will return to the adjustment screen without saving changes (Step 3).

Selecting [RESET] will return to the factory default.

Selecting [UNDO] will exit without saving changes.

---

*NOTE: To reset the 3D Reform correction setting values, press and hold the 3D REFORM button for a minimum of 2 seconds.*

---

*NOTE: During 3D Reform adjustment, [ASPECT RATIO] and [SCREEN] may not be available. Should this happen, first reset the 3D Reform data and then do each setting. Second repeat the 3D Reform adjustment. Changing [ASPECT RATIO] and/or [SCREEN] setting can limit [3D REFORM] in its adjustable range.*

---

The adjustable ranges for 3D Reform are as follows:

	HORIZONTAL	VERTICAL
CORNERSTONE	Max. +/- 40° approx.	Max. +/- 30° approx.
KEystone		

\* The following are conditions under which the maximum angle is achieved:

- Image is projected in Wide (Zoom lever to the maximum)

---

**NOTE:**

- *Even when the projector is turned on, the last used correction values are applied.*
  - *Turning on the projector will reset the previous correction setting values and correct distortion anew if the projection angle is changed from the last use.*  
*If the projection angle is the same as in the last use, the previous correction setting values are retained in the memory.*
  - *The range of keystone correction is not the maximum tilt angle of projector.*
- 

*NOTE: Using 3D Reform correction can cause the image to be slightly blurred because the correction is made electronically.*

---

## 9 Displaying Two Pictures at the Same Time

The projector has a feature that allows you to view two different signals simultaneously. You have two modes: PIP mode and Side by Side mode.

From the menu you can select [SETUP] → [BASIC] → [PIP/SIDE BY SIDE].

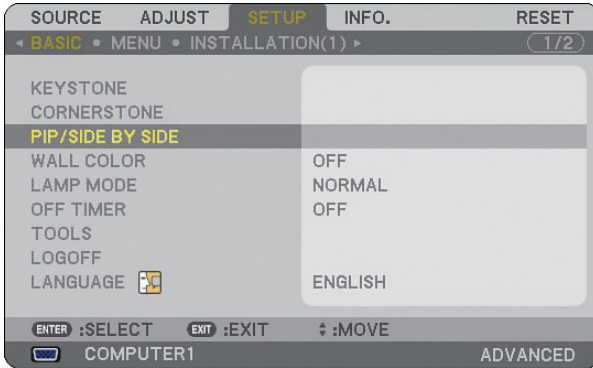

The [PIP/SIDE BY SIDE] menu item has the following three options: MODE, POSITION, and SOURCE. Use the SELECT ▲ or ▼ button to select [MODE], [POSITION] or [SOURCE] and press the ENTER button.

### Selecting the PIP or SIDE BY SIDE Mode [MODE]

This option allows you to select two modes: PIP and Side by Side.

Use the SELECT ▲ or ▼ button to select [PIP] or [SIDE BY SIDE] and press the ENTER button.

PIP: This option allows you to view a sub picture in the main picture.

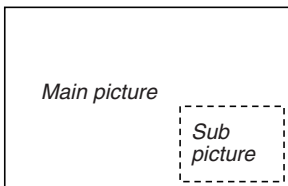

SIDE BY SIDE: This allows you to view two pictures side by side.

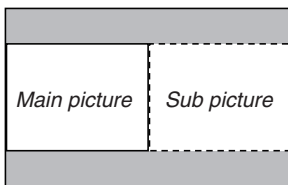

#### NOTE:

- The main picture will be displayed on the left side and the sub picture on the right side.
- The main picture signal supports the COMPUTER 1 IN/COMPONENT 1 IN and the COMPUTER 2 IN/COMPONENT 2 IN connectors.  
The sub picture signal supports the VIDEO IN and S-VIDEO IN connectors.
- The main picture supports an RGB signal with a resolution of 1280 x 1024 pixels or less.

### Viewing Two Pictures

**1. Press the PIP button on the remote control.**

The PIP/SIDE BY SIDE SOURCE screen will be displayed.

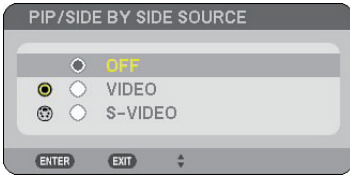

**2. Use the SELECT ▲ or ▼ button to select the source and press the ENTER button.**

The PIP screen or SIDE BY SIDE screen will be displayed, depending on which was selected in the [MODE] setting screen.

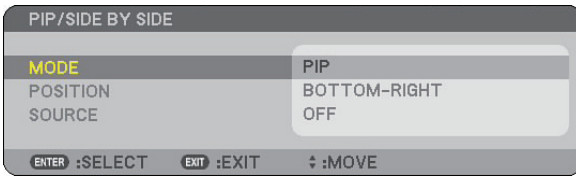

**3. Press the PIP button again to return to the normal screen (single picture).**

**TIP:**

- Selecting another source will return to the normal screen.
- Selecting a source not supported for the main picture or the sub picture will return to the normal screen.

### [POSITION]

This option allows you to select the position of a sub picture in the main picture.

**NOTE:**

- The default setting is [BOTTOM-RIGHT].

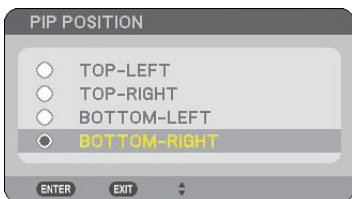

Use the SELECT ▲ or ▼ button to select the sub picture's position and press the ENTER button. The options are: TOP-LEFT, TOP-RIGHT, BOTTOM-LEFT, and BOTTOM-RIGHT.

The following adjustments and settings are available for the main picture only.

- Adjusting picture and sound
- Setting an aspect ratio for the screen. (→ page 83)

The following operations are available for both the main and sub pictures.

- Picture and audio mute
- Freezing a moving picture
- Magnifying a picture



## 10 Preventing Unauthorized Use of the Projector

Assigning a keyword prevents the projector from being used by unauthorized individuals.

### Turning on the Security function by assigning a keyword for the first time

1. Press the **MENU** button.

*The menu will be displayed.*

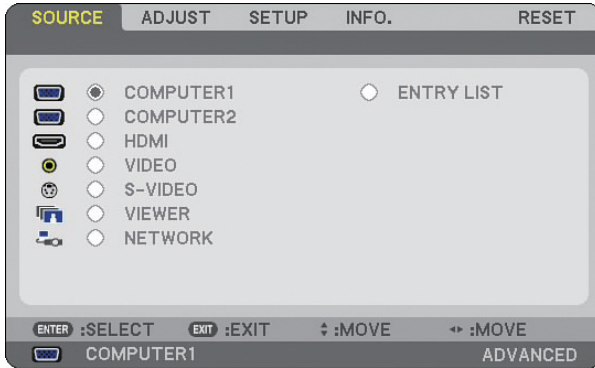

2. Press the **SELECT** button to highlight the [SETUP] submenu and press the **ENTER** button.

*The page tab [BASIC] will be highlighted.*

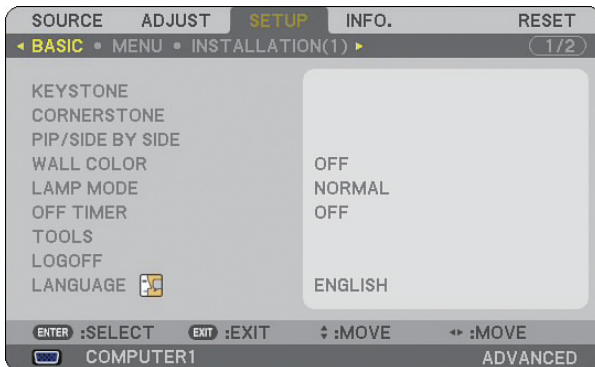

3. Press the **SELECT** button three times to highlight the page tab [INSTALLATION (2)].

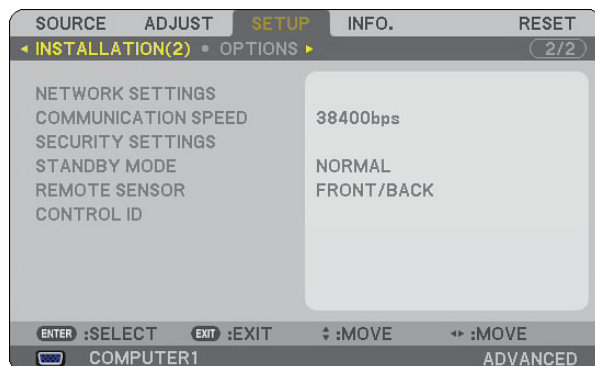

4. Press the **SELECT ▼** button three times to highlight [SECURITY SETTINGS].

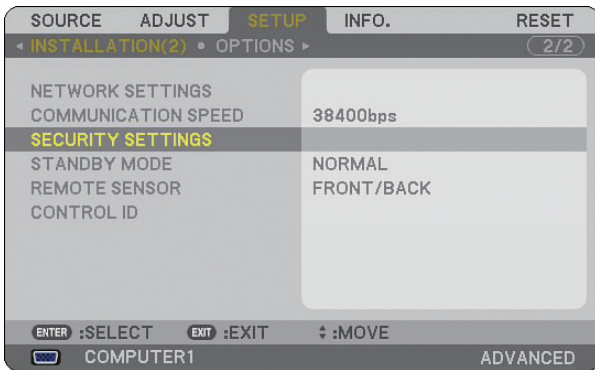

5. Press the **ENTER** button to display the SECURITY SETTINGS menu.

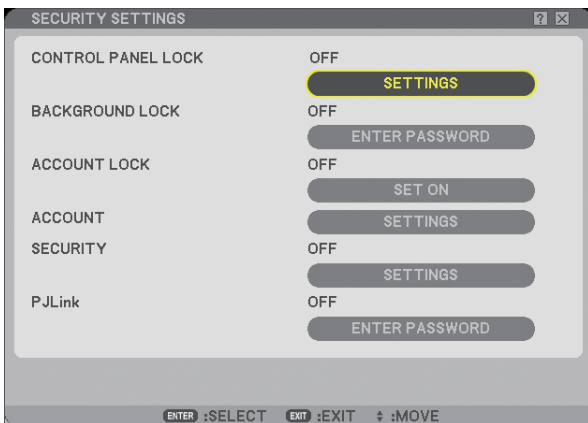

6. Press the **SELECT ▼** button four times to highlight [SECURITY SETTINGS] and press the **ENTER** button. The Security screen will be displayed.

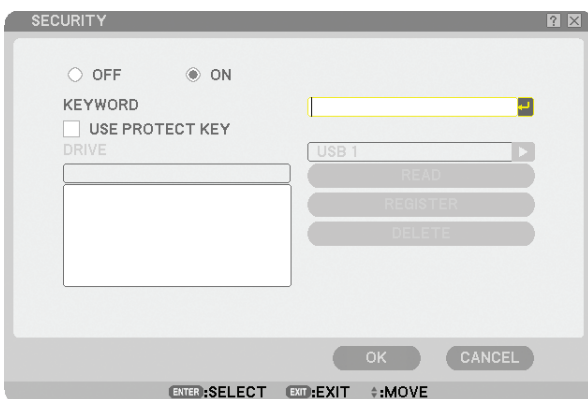

7. Press the **SELECT ▼** button once to highlight the Keyword entry box and press the **ENTER** button. The Software keyboard will be displayed.

8. Enter an alphanumeric keyword using the Software keyboard.  
For example, to enter "1234", follow the steps 8-1 to 8-4 below.

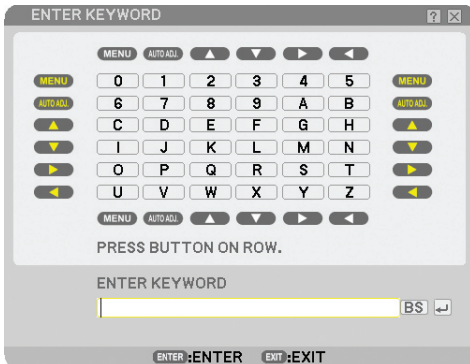

**NOTE:**

- When using your USB mouse, click each number or alphabet.
- BS: Delete the character before the cursor or highlight.
- : Confirm the keyword and close the Software keyboard.
- The keyword must be 1 to 10 characters long.
- Please make a note of your keyword.

Enter a keyword by using the remote control.

- 8-1. Press the MENU button and the AUTO ADJ. button to enter "1".  
The asterisk "\*" will be displayed in the keyword entry box.
  - 8-2. Press the MENU button and the SELECT ▲ button to enter "2".  
The asterisk "\*" will be displayed in the keyword entry box.
  - 8-3. Press the MENU button and the SELECT ▼ button to enter "3".  
The asterisk "\*" will be displayed in the keyword entry box.
  - 8-4. Press the MENU button and the SELECT ► button to enter "4".  
The asterisk "\*" will be displayed in the keyword entry box.
  - 8-5. Press the ENTER button.
9. Press the SELECT ▲ button once to highlight [OFF] and press the SELECT ► button to highlight [ON].

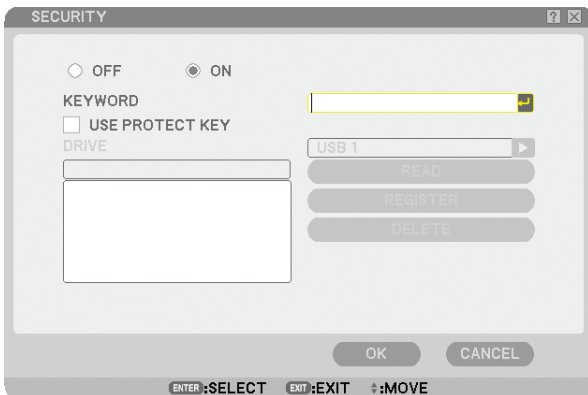

10. Press the **SELECT** ▼ button to highlight [OK] and press the **ENTER** button.

The confirmation screen will be displayed.



11. Press the **SELECT** ◀ or ▶ button to highlight [YES] and press the **ENTER** button.

The Security Function will take effect when the projector is turned on next time.

### Checking If Security is enabled

Turn off the projector and turn it back on to check if the Security function is enabled.

1. Press the **POWER** button.

The [POWER OFF / ARE YOU SURE?] message will appear.

Press the **ENTER** button or the **POWER** or the **POWER OFF** button again.

The lamp lights off and the **POWER** indicator flashes orange. Please wait until the **POWER** indicator changes from flashing to steady light.

2. When the **POWER** indicator lights steady orange, push the Main **POWER** switch to the off position (O).

The projector will turn off.

3. Push the Main **POWER** switch to the on position (I).

The **POWER** indicator lights orange. The projector is in standby condition.

4. Press and hold the **POWER** button for a minimum of two seconds.

The projector will turn on. The [PROJECTOR IS LOCKED! ENTER YOUR KEYWORD.] message will be displayed at the bottom of the screen.

5. Press the **MENU** button.

The Keyword entry screen will be displayed

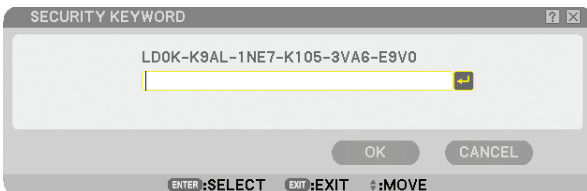

6. Press the **ENTER** button.

The Software keyboard will be displayed.

7. Use the same procedures as steps 1 to 8 described in the “Turning on the Security function by assigning a keyword for the first time” section to enter “1234”.

Each time one number is entered, an “\*” (asterisk) will appear. Keyword appears as asterisks so the real keyword is hidden.

8. After entering your keyword, highlight [OK] and press the **ENTER** button.

The Software keyboard will disappear. This will allow you to operate the projector.

### Disabling the Security

**1. Press the MENU button.**

The menu will be displayed.

---

*NOTE: Immediately after the projector has been turned on and the "Projector is locked! Enter your keyword." message is displayed at the bottom of the screen, pressing the MENU button will display the Keyword entry screen. At this time, pressing the MENU button will display the menu.*

---

**2. Press the SELECT ► button to highlight [SETUP] and press the ENTER button.**

The page tab [BASIC] will be highlighted.

**3. Press the SELECT ► button twice to highlight the page tab [INSTALLATION (2)].**

**4. Press the SELECT ▼ button three times to highlight [SECURITY SETTINGS] and press the ENTER button.**

**5. Press the SELECT ▼ button four times to highlight [SECURITY] - [SETTINGS] and press the ENTER button.**

The Keyword entry screen will be displayed

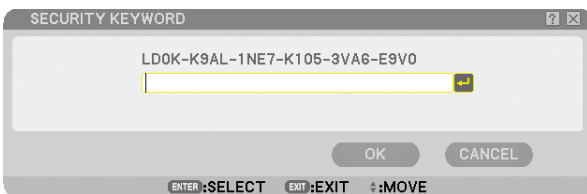

**6. Press the ENTER button.**

The Software keyboard will be displayed.

**7. Use the same procedures as steps 1 to 8 described in the "Turning on the Security function by assigning a keyword for the first time" section to enter "1234".**

Each time one number is entered, an "\*" (asterisk) will appear. Keyword appears as asterisks so the real keyword is hidden.

**8. After entering your keyword, highlight [OK] and press the ENTER button.**

The Software keyboard will disappear. The Security screen will be displayed.

**9. Highlight [ON] and press the SELECT ◀ button to highlight [OFF].**

**10. Press the SELECT ▼ button to highlight [OK] and press the ENTER button.**

The Security Function will be disabled when the projector is turned on next time.

---

*NOTE: Do not forget your keyword. However, if you forget your keyword, NEC or your dealer will provide you with your Release Code upon proof of ownership.*

---

### 11 Limiting Access Level to Available Menu Items

The Account function allows you to manage available menu items by user level.

The projector has two menu modes: the ADVANCED menu and the BASIC menu.

ADVANCED menu .. This is the menu that contains all the available menus and commands. Users with an ADMINISTRATOR or ADVANCED account can access the ADVANCED menu.

BASIC menu ..... This is the basic menu that contains minimum essentials of menus and commands. Users with a BASIC account can access the BASIC menu.

See page 49 for settings available to ADVANCED and BASIC menus.

---

**NOTE:**

- A user with an ADMINISTRATOR account that has no password set is registered at the factory. This will allow the user to access the ACCOUNT items without password entry.
- 

### Logging On

Logging on your projector

When a user is registered, trying to display the menu will display the LOGON screen, prompting the user to select the user and to enter the password.

---

*NOTE: If one user logs on to the projector, any other user cannot log on.*

---

**1. Enter a user name.**

**2. Enter the registered password if you have it.**

**3. Select [OK].**

---

*NOTE: Do not forget your password. If you forget your password, ask your administrator. If your administrator forget the password, ask NEC or your dealer. NEC or your dealer will provide you with your Release Code (24 character length) upon proof of ownership.*

---

### Logging Off

Logging off your projector

Logging off your projector will prevent an unauthorized user from operating your projector.

**1. From the menu, select [SETUP] → [BASIC] → [LOGOFF].**

**2. Select [YES].**

### Creating or Adding a User

1. From the menu, select [SETUP] → [INSTALLATION (2)] → [SECURITY SETTINGS].

2. Select [ACCOUNT]-[SETTINGS].

The [ACCOUNT] setting screen will be displayed.

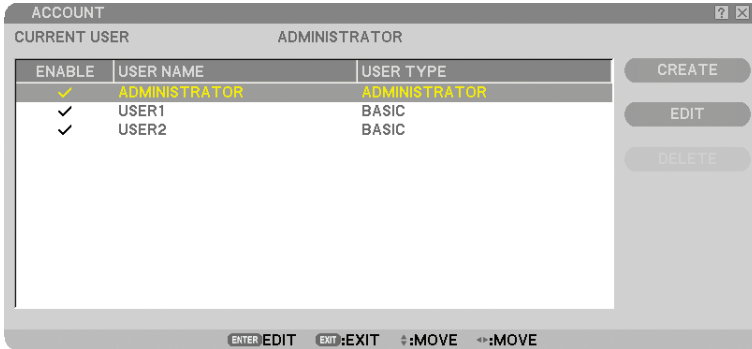

3. Select [CREATE].

The [ACCOUNT] create screen will be displayed.

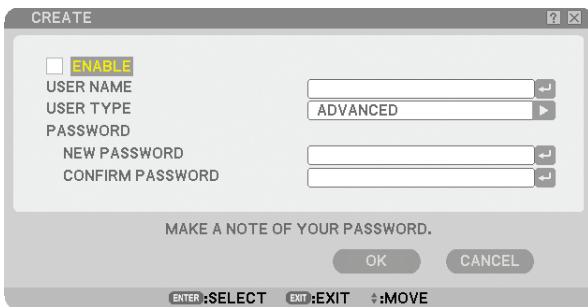

4. Enter a user name, user type, and password.

- A user name must be 16 alphanumeric characters or less (case sensitive).
- User type has two options: [ADVANCED] and [BASIC].
- Use the software keyboard to enter a password in the NEW PASSWORD entry field.

A password must be 10 alphanumeric characters or less. If no password is set, the user is registered without a password.

- After entering a password, enter the same password in [CONFIRM PASSWORD] input screen again.
- Make a note of your password.

5. Place a checkmark on [ENABLE].

The account will be made available.

6. Select [OK].

This will complete adding a user.

*NOTE: Up to 12 user names can be created.*

### Editing a User (Changing Account Settings)

1. From the menu, select **[SETUP]** → **[INSTALLATION (2)]** → **[SECURITY SETTINGS]**.

---

*NOTE: A user with an ADMINISTRATOR account is recommended to change the account settings.*

---

2. Select **[ACCOUNT]-[SETTINGS]**.

The **[ACCOUNT]** setting screen will be displayed.

3. Select a user name you wish to edit.

4. Select **[EDIT]**.

The **[EDIT]** screen will be displayed.

Enter your password and press the **ENTER** button.

If no password is set, simply press the **ENTER** button without entering any password.

5. Change the settings and select **[OK]**.

### Deleting a User

1. From the menu, select **[SETUP]** → **[INSTALLATION (2)]** → **[SECURITY SETTINGS]**.

---

*NOTE: A user with an ADMINISTRATOR account is recommended to delete the account settings.*

---

2. Select **[ACCOUNT]-[SETTINGS]**.

The **[ACCOUNT]** setting screen will be displayed.

3. Select a user name you wish to delete.

4. Select **[DELETE]**.

The **[DELETE]** screen will be displayed.

Enter your password and press the **ENTER** button.

The confirmation screen will be displayed.

5. Select **[YES]**.

This will complete deleting the user.

---

*NOTE: Do not forget your password. If you forget your password, ask your administrator. If your administrator forget the password, ask NEC or your dealer. NEC or your dealer will provide you with your Release Code (24 character length) upon proof of ownership.*

---



# 12 Operation Using an HTTP Browser

## Overview

The use of HTTP server functions will allow control of the projector from a web browser without the installation of special software. Please be sure to use "Microsoft Internet Explorer 4.x" or a higher version for the web browser. (This device uses "JavaScript" and "Cookies" and the browser should be set to accept these functions. The setting method will vary depending on the version of browser. Please refer to the help files and the other information provided in your software.)

Access is gained to the HTTP server functions by specifying

`http:// <the projector's IP address> /index.html`

in the entry column of the URL.

---

### NOTE:

- *The display's or button's response can be slowed down or operation may not be accepted depending the settings of your network. Should this happen, consult your network administrator.  
The projector may not respond if its buttons are repeatedly pressed in rapid intervals. Should this happen, wait a moment and repeat. If you still can't get any response, turn off and back on the projector.*
  - *Do not use the HTTP Server functions and PC Control Utility 3.0 included on the supplied Supportware 5 CD-ROM. Using both at the same time may result in a connection failure or slow response.*
- 

## Preparation Before Use

Make network connections and set up the projector and confirm that it is complete before engaging in browser operations. (→ [NETWORK SETTINGS] on page 99)

Operation with a browser that uses a proxy server may not be possible depending on the type of proxy server and the setting method. Although the type of proxy server will be a factor, it is possible that items that have actually been set will not be displayed depending on the effectiveness of the cache, and the contents set from the browser may not be reflected in operation. It is recommended that a proxy server not be used unless it is unavoidable.

## Handling of the Address for Operation via a Browser

Regarding the actual address that is entered for the address or entered to the URL column when operation of the projector is via a browser, the host name can be used as it is when the host name corresponding to the IP address of the projector has been registered to the domain name server by a network administrator, or the host name corresponding to the IP address of the projector has been set in the "HOSTS" file of the computer being used.

Example 1: When the host name of the projector has been set to "pj.nec.co.jp",  
`http://pj.nec.co.jp/index.html`  
is specified for the address or the entry column of the URL.

Example 2: When the IP address of the projector is "192.168.73.1", access is gained to the  
HTTP server functions by specifying  
`http://192.168.73.1/index.html`  
for the address or the entry column of the URL.

Structure of the HTTP Server

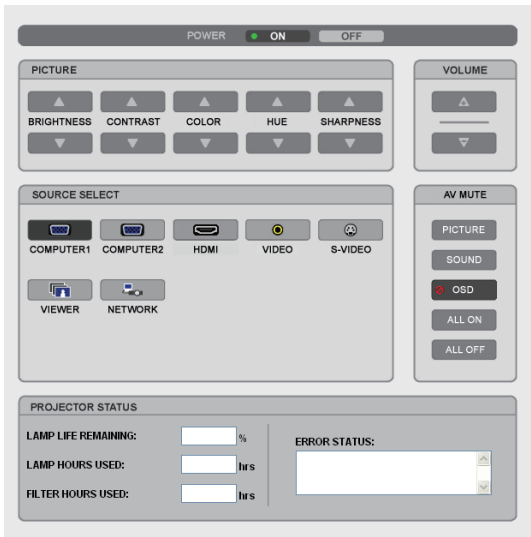

POWER: This controls the power of the projector.  
 ON .....Power is switched on.  
 OFF .....Power is switched off.

VOLUME: This controls the volume of the projector.  
 ▲ .....Increases the volume adjustment value.  
 ▼ .....Decreases the volume adjustment value.

AV-MUTE: This controls the mute function of the projector.  
 PICTURE ON .....Mutes the video.  
 PICTURE OFF .....Cancels the video muting.  
 SOUND ON .....Mutes the audio.  
 SOUND OFF .....Cancels the audio muting.  
 OSD ON .....Mutes the on-screen display.  
 OSD OFF .....Cancels the muting of the on-screen display.  
 ALL ON .....Mutes each of the video, audio, and on-screen display functions.  
 ALL OFF .....Cancels the muting of each of the video, audio, and on-screen display functions.

PICTURE: Controls the video adjustment of the projector.  
 BRIGHTNESS ▲ .....Increases the brightness adjustment value.  
 BRIGHTNESS ▼ .....Decreases the brightness adjustment value.  
 CONTRAST ▲ .....Increases the contrast adjustment value.  
 CONTRAST ▼ .....Decreases the contrast adjustment value.  
 COLOR ▲ .....Increases the color adjustment value.  
 COLOR ▼ .....Decreases the color adjustment value.  
 HUE ▲ .....Increases the hue adjustment value.  
 HUE ▼ .....Decreases the hue adjustment value.  
 SHARPNESS ▲ .....Increases the sharpness adjustment value.  
 SHARPNESS ▼ .....Decreases the sharpness adjustment value.

- The functions that can be controlled will vary depending on the signal being input to the projector. (→ page 80)

**SOURCE SELECT:** This switches the input connector of the projector.

- COMPUTER 1.....Switches to the COMPUTER 1 IN connector.
- COMPUTER 2.....Switches to the COMPUTER 2 IN connector.
- HDMI.....Switches to the HDMI IN connector.
- VIDEO.....Switches to the VIDEO IN connector.
- S-VIDEO.....Switches to the S-VIDEO IN connector.
- VIEWER.....Switches to the data on the USB memory device.
- NETWORK.....Switches to a LAN signal.

**PROJECTOR STATUS:** This displays the condition of the projector.

- LAMP LIFE REMAINING ....Displays the remaining life of the lamp as a percentage.
- LAMP HOURS USED.....Displays how many hours the lamp has been used.
- FILTER HOURS USED ....Displays how many hours the filter has been used.
- ERROR STATUS.....Displays the status of errors occurring within the projector.

## 13 Projecting Your Computer's Screen Image from the Projector via a Network [NETWORK PROJECTOR]

A Windows Vista-based computer can be operated using the projector over a network. The projector supports the Network Projector function and the Remote Desktop function of Windows Vista.

By selecting the projector connected to the same network as that of your PC, the PC screen image can be projected to the screen via network. There is no need of connection using the VGA signal cable.

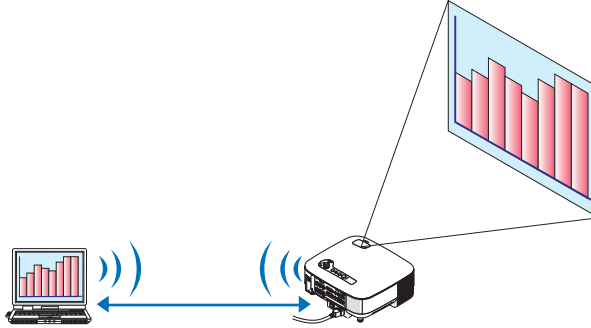

The projector supports the Network Projector function and the Remote Desktop function of Windows Vista.

### Operation Environment

Applicable OS	Windows Vista (32-bit version) Home Premium Windows Vista (32-bit version) Business Windows Vista (32-bit version) Ultimate Windows Vista (32-bit version) Enterprise <i>(Note) These functions are not available on Windows Vista Home Basic.</i>
Hardware specifications	The specifications recommended by Microsoft as the operation environment for Windows Vista should be satisfied.
Network Environment	Wired LAN or wireless LAN environment that supports TCP/IP is required.
Screen color	High Color (16 bits) True Color (24 bits and 32 bits) * Setting with 256 colors or less is not available.

### Setting the Projector to Network Projector Input Mode

1. **With the projector turned on, press the SOURCE button.**

The input selection window appears.

Another way to display the input selection window is to press the NETWORK button on the remote control. The NETWORK screen will be displayed. Go to step 3.



2. Press the **SELECT** ▼ or ▲ button to select **[NETWORK]** and press the **ENTER** button.

In the screen, the **[NETWORK]** menu is displayed.



3. From the **[NETWORK]** menu, select **[NETWORK PROJECTOR]**.

The **[PROJECTOR NAME/DISPLAY RESOLUTION/PASSWORD/URL]** will be displayed.

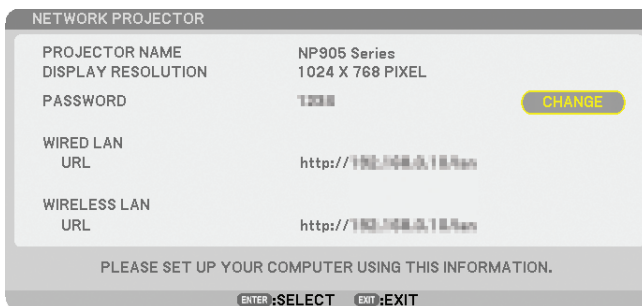

**TIP:**

- To change the default password “1234”, select **[CHANGE]** and press the **ENTER** button. The **[ENTER PASSWORD]** screen will be displayed, Enter a numeric password. The password must be eight characters or less. The changed password stored in the projector will be displayed in the **[NETWORK PROJECTOR]** screen next time.

Changing the resolution of Windows Vista screen to the information on [DISPLAY RESOLUTION] in the NETWORK PROJECTOR screen.

1. Click [Start] from the desktop of Windows Vista.
2. Click [Control Panel].
3. Click [Adjust screen resolution] displayed under [Appearance and Personalization].
4. Operate [Resolution] slide bar to change the resolution to the resolution displayed on [DISPLAY RESOLUTION] in the NETWORK PROJECTOR screen..

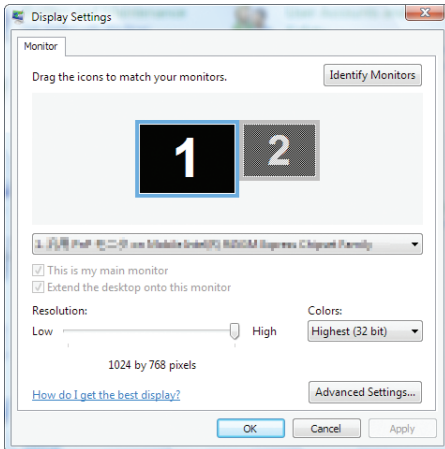

5. Click [OK].

The message "Do you keep this screen setting?" is displayed.

6. Click [Yes].

The resolution of Windows Vista screen is changed to the resolution displayed on [DISPLAY RESOLUTION] in the NETWORK PROJECTOR screen..

### Projecting the Image with Network Projector

1. Click [Start] from the desktop of Windows Vista.
2. Click [All Programs].
3. Click [Accessories].
4. Click [Connect to a Network Projector].

When the [Permission Connect to a Network Projector] window appears,click [Yes].

The "Connect to a Network Projector" window appears.

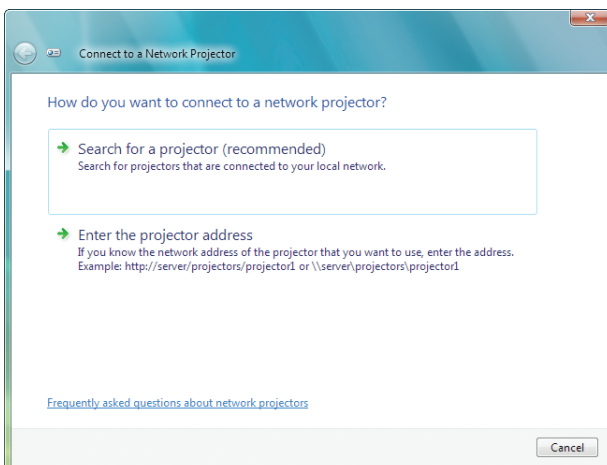

**5. Click [→ Search for a projector (recommended)].**

In the “Available projectors” box, your projector model name is displayed.

**6. Click your projector model name.**

The message “Enter the password for the projector that you selected.” is displayed at the bottom of the window.

**7. Check the password displayed in the screen projected by the projector.**

**8. Input the password to the password input box displayed by the operation at Step 7.**

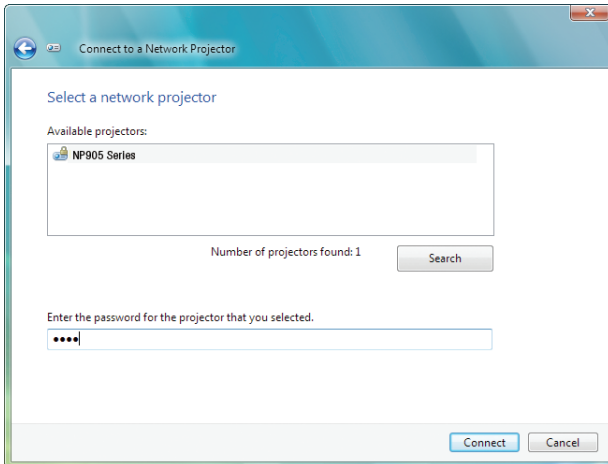

**9. Click [Connect].**

The network projector function works and the screen of Windows Vista is projected from the projector.

---

*NOTE: When the network projector function works, the background color of the desktop changes to black. When the network projector function is stopped, the original background color is restored.*

---

*Reference: If the projector cannot be found at Step 5, click [ → Enter the projector address]. Then, input the “Network address” (Input example: <http://10.32.97.61/lan>) and “Projectorpassword” (Input example: 82291627) displayed in the screen projected from the projector.*

---

### Exiting the Network Projector Operation

**1. Click [Projecting: your projector model name] in the Windows Vista task bar.**

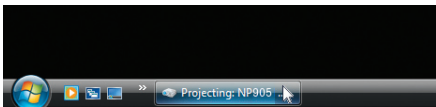

**2. Click [Disconnect].**

The Network Projector function is stopped.

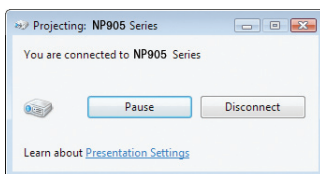

**3. Press the MENU button of the projector to display the menu. From the menu, select an input terminal other than [NETWORK].**

## 14 Using the Projector to Operate Your Computer via a Network [REMOTE DESKTOP]

- By selecting the PC connected to the same network as that of the projector, the PC screen image can be projected to the screen via network.  
Then, by operating the keyboard connected to the projector, you can operate Windows Vista on the PC connected with the network.
- With the Remote Desktop function, you can remotely operate the PC placed at a distance from the projector.

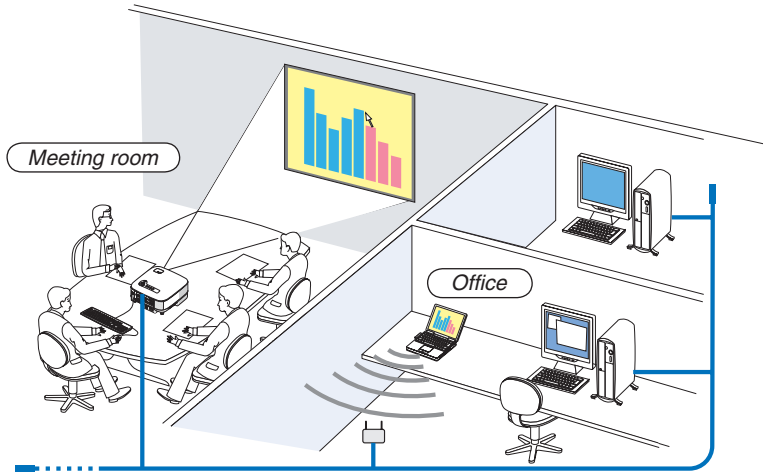

### NOTE:

- Available versions of Windows Vista are provided on page 54. Windows Vista Home Premium is not available for REMOTE DESKTOP.
- In this user's manual this feature is described using Windows Vista as an example, but the following Windows XP will also work with this feature.  
Windows XP Professional Service Pack 2 or later
- A keyboard is required to use the Remote Desktop function.
- The Remote Desktop function can be operated with a keyboard only. Using a wireless mouse with a wireless keyboard is more useful for operating.  
Use a commercially available wireless keyboard, a wireless mouse, and a USB wireless receiver.  
Use a commercially available USB keyboard and USB mouse.
- A USB keyboard with a built-in USB hub cannot be used with the projector.
- A wireless keyboard or mouse that supports Bluetooth cannot be used with the projector.

Prepare a commercially available wireless keyboard (US layout version).

*NOTE: We do not warrant that the USB port of the projector will support all USB keyboards in the market.*

Connect the USB wireless receiver to the USB port (Type A) of the projector. Make all necessary settings for your wireless keyboard and mouse.

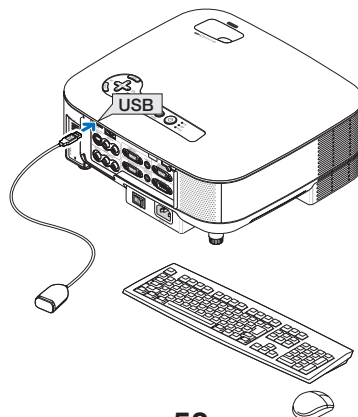



### Setting the password to the user account of Windows Vista

*TIP: If a password has been set for an account, the steps 1 to 9 can be skipped.*

1. Click [Start] from the desktop of Windows Vista.
2. Click [Control Panel].
3. Click [Add or remove user accounts] displayed under [User Accounts].
4. When the [User Account Control] confirmation window appears, click [Continue].
5. Click [Administrator].
6. Click [Create a password].
7. Input the password to the [New password] box.
8. Input the same password as that at Step 7 to the [Confirm new password] box.
9. Click [Create a password].

The Administrator is changed to [Password Protection].

### Setting the Remote Access

1. Click [Start] from the desktop of Windows Vista.
2. Click [Control Panel].
3. Click [System and Maintenance].
4. Click [Allow remote access] displayed under [System].
5. When the [User Account Control] confirmation window appears, click [Continue].  
The [System Properties] window appears.
6. Click [Allow connections from computers running any version of Remote Desktop (less secure)] in the Remote Desktop box and click [OK].

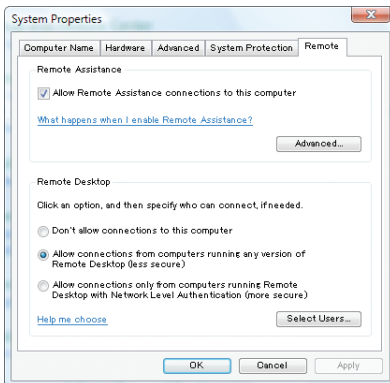

### Checking the IP address on Windows Vista

1. Click [Start] from the desktop of Windows Vista.
2. Click [Control Panel].
3. Click [View network status and tasks] displayed under [Network and Internet].

- Click **[View status]** displayed in blue on the right of **[Local Area Connection]** in the window.  
The **[Local Area Connection Status]** window appears.

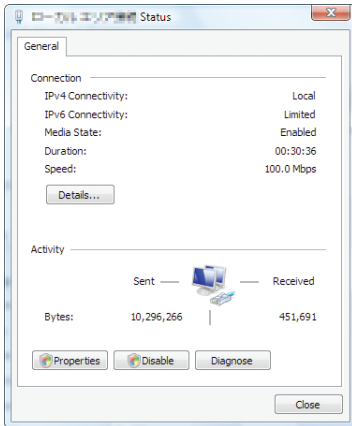

- Click **[Details...]**.  
Write down the value for "IPv4 IP Address" (xxx.xxx.xxx.xxx) displayed.

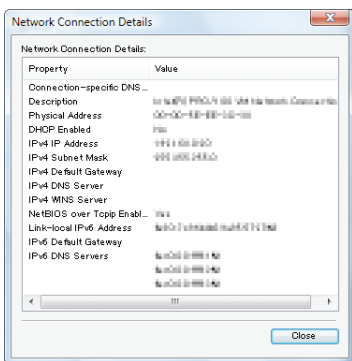

- Click **[Close]**.
- Click **[X]** at the upper right of the window.  
The system goes back to the desktop.

### Starting the Remote Desktop

- With the projector turned on, press the **SOURCE** button.

The input selection window appears.

Another way to display the input selection window is to press the **NETWORK** button on the remote control. The **NETWORK** screen will be displayed. Go to step 3.



2. Press the **SELECT** ▼ or ▲ button to select **[NETWORK]** and press the **ENTER** button.

The **[NETWORK]** menu will be displayed.



3. From the **[NETWORK]** menu, use the wireless keyboard to select **[REMOTE DESKTOP CONNECTION]**.

The **[Remote Desktop Connection]** window appears.



**TIP:**

Setting **[OPTIONS]** in **REMOTE DESKTOP**

Clicking **[OPTIONS]** displays the **[PERFORMANCE]** screen.

Making settings to **[OPTIONS]** will allow you to display the desktop background, or to enable the window animation function during the Remote Desktop operation. However, doing this will cause the display's or mouse's response to slow down.

If the display's or mouse's response is slowed down, try one or more of the following:

**DESKTOP BACKGROUND:** Clear the check mark to display the desktop background in monochrome.

**MENU AND WINDOW ANIMATION:** Clear the check mark to disable menu and window animation.

**THEMES:** Clear the check mark not to use Themes.

**SHOW CONTENTS OF WINDOW WHILE DRAGGING:** Clear the check mark to show only the window pane while dragging.

4. Operate the wireless keyboard to input the IP address of Windows Vista and click **[CONNECT]**.

The log-on screen of Windows Vista is displayed in the screen projected by the projector.

5. Operate the wireless keyboard to input the user's password and press **[Enter]**.

The remote desktop function is started.

Windows Vista desktop is displayed in the screen projected by the projector.

Log out the computer.

Use the wireless keyboard connected to the projector to operate Windows Vista.

---

**NOTE:** When the projection is made with the remote desktop function, the background color of the desktop is changed to black.

---

### Exiting the Remote Desktop

1. Operate the keyboard to click [Start] from the desktop screen projected by the projector.

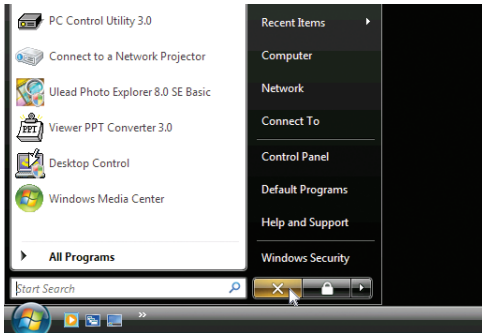

2. Click [X] on the right of the start menu.

The remote desktop function is stopped.

3. Press the **SOURCE** button of the projector to select an input terminal other than [NETWORK].

When using the remote control, press a button other than the NETWORK button.

# 5. Using the Viewer

---

## ① Making the Most out of the Viewer Function

### Features

The Viewer feature allows you to view slides or movie files stored on a USB memory on the projector. Even if no computer is available, presentations can be conducted simply with the projector. This feature is convenient for holding presentations at meetings and in offices, as well as for playing images taken on digital cameras.

### Easy to use

- Presentations can be made by inserting a USB memory (not supplied)
- Easy slide switching
- Remote control operation
- Jumping to a list of slides or any specific slide
- Display a movie file

### Simple utility software (for computer)

- Ulead Photo Explorer 8.0SE Basic operable.
- Control screen for displaying lists of slides and editing.

### TIP:

- *To use the Viewer, first you need to create presentation materials on your PC (JPEG, BMP, GIF<sup>\*1</sup>, PNG<sup>\*1</sup>, Index<sup>\*2</sup> and MPG (MPEG2) files).*
- *An image with higher than 4000 pixels in width or height cannot be displayed.*
- *The following image formats cannot be displayed:  
Progressive JPEG, Interlaced GIF, animation GIF, interlaced PNG,  $\alpha$  channel PNG.  
For creating presentation materials using the Ulead Photo Explorer 8.0, see the supplied "User Supportware 5 User's Guide" or On-line help in Ulead Photo Explorer 8.0.*
- <sup>\*1</sup> *Both PNG and GIF format support non-interlaced images only.*
- <sup>\*2</sup> *"Index" file is a file created using the Ulead Photo Explorer 8.0 or Viewer PPT Convert 3.0 contained on the supplied NEC User Supportware 5 CD-ROM.  
See the supplied "User Supportware 5 User's Guide" for installing the Ulead Photo Explorer 8.0 on your computer.*
- *The video format available for VIEWER is MPEG2 MP@ML.*
- *A movie file with display size greater than 720 x 576 pixels (width x height) cannot be played back.*
- *Movie files converted by using the compact/expand format which is not unsupported by this projector cannot be played back.  
In this case, there will be no icon to show that playback is not possible.  
The audio format available for VIEWER is MPEG-1 Layer 1 and 2.  
\* Linear PCM and AC-3 audio formats are not available for VIEWER.*

---

### NOTE:

- *Use commercially available USB memory devices.*
  - *We do not warrant that the USB port of the projector will support all USB memory devices in the market.*
  - *The projector does not support NTFS formatted USB memory device.  
Be sure to use a USB memory device formatted with the FAT32, FAT16 or FAT file system.  
To format your USB memory device in your computer, refer to the document or help file that comes with your Windows.*
- 

## ② Saving data to a USB memory device

There are two ways to save your data to a USB memory device.

### Using Ulead Photo Explorer 8.0

Install Ulead Photo Explorer 8.0 from the supplied User Supportware 5 CD-ROM to your computer. Use Ulead Photo Explorer 8.0 to create graphic data on your computer and save the files to a USB memory device. Files created on Ulead Photo Explorer 8.0/Viewer PPT Converter 3.0 are index format and are stored in [Presentation] folder.

For more details about Ulead Photo Explorer 8.0, see the supplied "Wired and Wireless Network Setup Guide", "Basic Operation Guide (PDF)" on the User Supportware 5 CD-ROM and the help file of Ulead Photo Explorer 8.0.

### Using Windows Explorer to save files

Supported file format for Viewer are JPEG, BMP, PNG, GIF, Index and MPG.

### 3 Operating the Viewer Function from the Projector (playback)

This section describes the operation for showing slides created or movie files.

#### Projecting slides (Viewer)

Preparation: Store JPEG or BMP files (JPEG, BMP, non-interlaced GIF or non-interlaced PNG files) in a USB memory inserted into your PC.

To start the Viewer, press the SOURCE button on the cabinet to select [VIEWER]. (→ page 24)

Viewer screen will be displayed. (A slide will be displayed at the factory default.)

- You can use the VIEWER button on the remote control to select [VIEWER].

#### Operating Viewer Menu

1. Insert a USB memory into the USB port of the projector.

The USB indicator lights.

2. Press the VIEWER button on the remote control or select the [VIEWER] from the source list.

An image stored in the USB memory will be displayed.

NOTE: When [SHOW THUMBNAILS] is turned on in the OPTIONS menu, the thumbnail screen will be displayed. (→ page 67)

NOTE: Pressing the EXIT button during slide playback will display the thumbnail screen.

#### Slide and Thumbnail

When VIEWER is selected, one of the two screens is displayed.

One is a slide and the other is a thumbnail screen.

[SLIDE]



[THUMBNAILS]

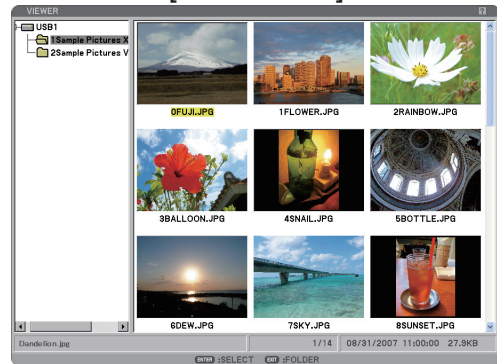

**TIP:** To switch from [SLIDE] to [THUMBNAILS], press the EXIT button.

#### The Control Bar

Pressing the MENU button during slide playback will display the control bar which allows you to operate a slide-show. Press the EXIT button to close the control bar.

The control bar contains the following icon buttons:

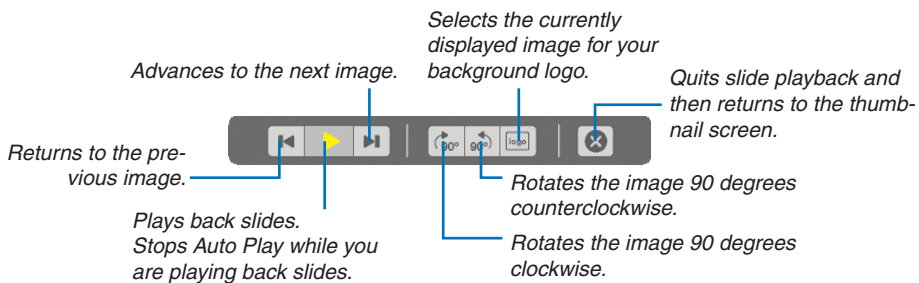

**Projecting a movie file**

Preparation: Store MPG files in a USB memory inserted into your PC.

**To display a movie file:**

1. Press the **SOURCE** button to select [VIEWER].

Viewer screen will be displayed. (A slide will be displayed at the factory default.)

2. Select a movie file icon from [THUMBNAILS] screen and press the **ENTER** button.

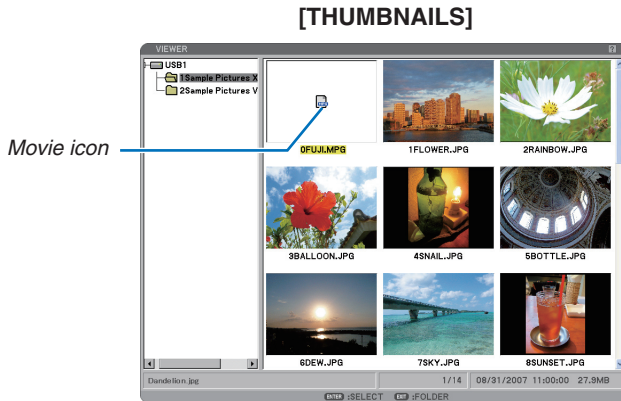

**TIP:** To return from the movie screen to [THUMBNAILS], press the **EXIT** button.

**NOTE:**

- If you select an unsupported file, a message "This file cannot play back." will be displayed and the VIEWER will return to the thumbnail screen.
- If you change a source during playback of a movie file, the playback will stop.
- If you press any other button than the **ENTER** button during playback of a movie file, the playback will stop and the VIEWER may return to the thumbnail screen.
- If you start playing back a movie file with the projector connected to the network, the network will be disconnected.
- If you use a USB memory device which has a slow reading speed, the movie file may not play back correctly.
- If you remove or insert the USB memory device during playback of a movie file, an error may occur with the VIEWER.

**Remote control button operation when a movie is played back:**

**ENTER** ..... Press this button during playback to pause playback. Press this button when the movie is paused to resume playback.

Press this button during fast-forward or rewind to return to playback.

Press this button when the movie is stopped to start playback.

**EXIT** ..... Press this button to return to the thumbnail screen.

**The Control Bar**

Pressing the **MENU** button during playback will display the control bar which allows you to operate movie files. Press the **EXIT** button to close the control bar.

The control bar contains the following icon buttons:

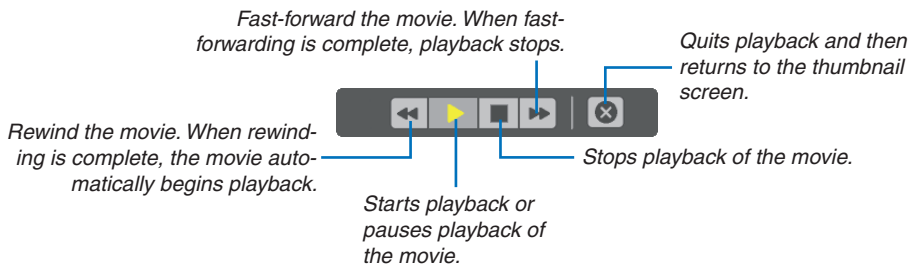

Thumbnail screen

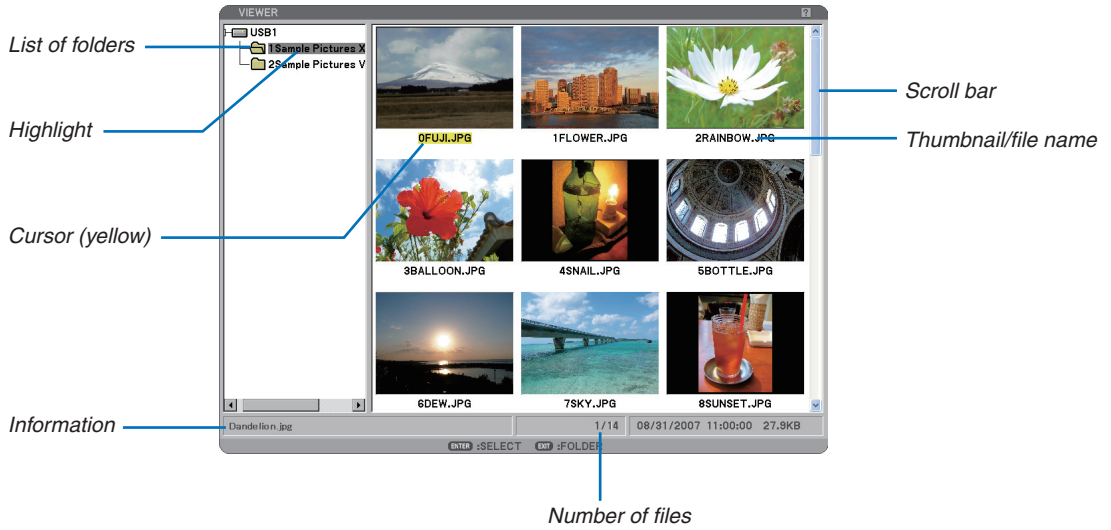

- Highlight ..... Indicates the selected folder or drive.
- List of folders..... Indicates folders contained on a USB memory.
- Information ..... Indicates information of the selected file or folder.  
 Folder: folder name, number of files, creation date (month/day/year), creation time (hour:minute:second).  
 File: file name, slide number/number of displayable slides in a folder, creation date (month/day/year), creation time (hour:minute:second), file size.
- Number of files ..... Indicates number of displayable slides in the selected folder. The maximum number of images recognized as slides within one directory is about 250.
- Thumbnail/file name ..... Indicates thumbnails and names contained in a folder.
- Cursor..... Indicates the selected slide.
- Scroll bar ..... Used to view folders or files not visible in the window.



## Setting Option for Viewer

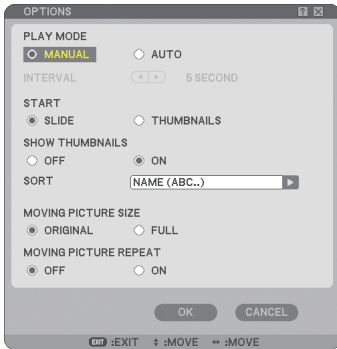

### PLAY MODE:

- MANUAL..... Views a slide manually when the Viewer source is selected.
- AUTO ..... Plays back slides automatically when the Viewer source is selected.

### INTERVAL:

Specifies interval time between 5 and 300 seconds.

### START:

Specifies start screen when the Viewer source is selected.

### SHOW THUMBNAI LS:

Selecting the Viewer source will display a list of thumbnails of graphic files stored in the USB memory when [ON] is selected. Selecting the Viewer source will display a list of icons of graphic files stored in the USB memory when [OFF] is selected.

### SORT:

Rearranges the slides or thumbnails by name, extension, date or size.

---

*NOTE: This setting is not available for the following folders:*

*\* Folders created with the "Output Viewer" feature of Ulead Photo Explorer 8.0 or with Viewer PPT Converter 3.0*

---

### MOVING PICTURE SIZE:

- ORIGINAL ..... Displays the movie file in its true resolution.
- FULL ..... Displays the movie file to fill the screen with its original aspect ratio maintained.

### MOVING PICTURE REPEAT:

- OFF ..... When the movie reaches its end, its playback will stop.
- ON ..... When the movie reaches its end, its playback will start again from the beginning.

### OK/CANCEL:

- To close the Options menu while saving changes, select [OK] and press the ENTER button.
- To close the Options menu without saving changes, select [CANCEL] and press the ENTER button.

### THUMBNAILS menu

The THUMBNAILS menu will appear when you press the MENU button on the remote control or the projector cabinet. To close the THUMBNAILS menu, press the EXIT button.

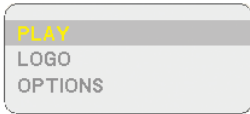

The THUMBNAILS menu includes the following commands:

- PLAY ..... Plays back automatically or manually depending on the setting in Options. This allows you to move on to the next slide when [MANUAL] is selected in the [PLAY MODE].
- LOGO ..... Replace the default background logo with another logo in JPEG, BMP, non-interlaced GIF or non-interlaced PNG format.
- OPTIONS..... Displays the Viewer setting options.

### Exiting Viewer

To exit Viewer, switch to another input such as COMPUTER 1, COMPUTER 2, HDMI, VIDEO, S-VIDEO or NETWORK.

- \* To switch to another input, there are two ways:
  - Press the COMPUTER 1, COMPUTER 2, HDMI, VIDEO, S-VIDEO or NETWORK button on the remote control.
  - Press the MENU button on the remote control to display the Viewer menu. Press the MENU button again to display the main menu and select the input from the [SOURCE] submenu.

## 4 Changing Background Logo

You can change the default background logo using the Viewer feature.

*NOTE: File size must be 256KB or less. Maximum file resolution is 1024 x 768 for NP905 and 1280 x 800 for NP901W. File formats other than JPEG, BMP, non-interlaced GIF or non-interlaced PNG are not available.*

Preparation: Store JPEG or BMP files (JPEG, BMP, non-interlaced GIF or non-interlaced PNG files) in a USB memory into the projector's USB port.

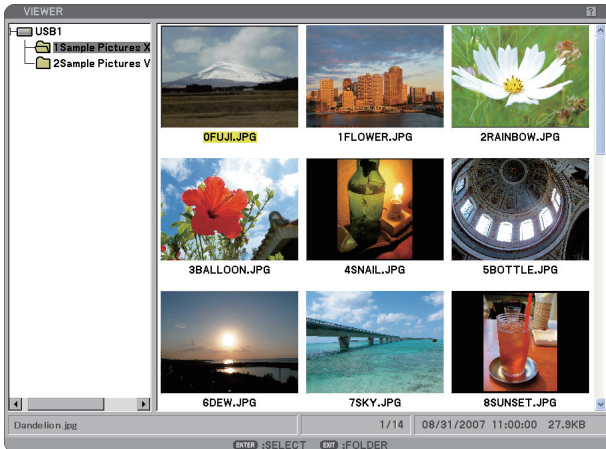

*NOTE: To change highlight from the Thumbnails screen (right window) to a directory tree (left window), press the EXIT button. To return highlight to the Thumbnails screen, press the ENTER button.*

1. Use the **SELECT ▲▼◀▶** button to select a file (slide) for your background logo when displaying the Thumbnail screen.
2. Press the **MENU** button to display the **THUMBNAILS** menu.

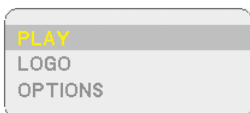

3. Use the **SELECT ▼** button to select **[LOGO]** and then press the **ENTER** button.

A confirmation dialog box will be displayed.

4. Use the **SELECT ◀** button to select **[YES]** and press the **ENTER** button. This completes changing a logo for the background.

- \* Once you have changed the background from the default "NEC Projector" image (jpg) to another, you cannot return the logo to background even by using [Reset]. To put the default "NEC Projector" image (jpg) back in the background logo, repeat the above steps.

The default "NEC Projector" image (jpg) file is included on the supplied User Supportware 5 CD-ROM (NP905: /Logo/necpj\_bb\_x.jpg and NP901W: necpj\_bbw\_x.jpg).

# 6. Using On-Screen Menu

## 1 Using the Menus

1. Press the **MENU** button on the remote control or the projector cabinet to display the menu.



---

*NOTE: The commands such as ◀▶, ENTER, EXIT in the bottom show available buttons for your operation.*

---

2. Press the **SELECT** ◀▶ buttons on the remote control or the projector cabinet to display the submenu.
3. Press the **ENTER** button on the remote control or the projector cabinet to highlight the top item or the first tab.
4. Use the **SELECT** ▲▼ buttons on the remote control or the projector cabinet to select the item you want to adjust or set.  
You can use the **SELECT** ◀▶ buttons on the remote control or the projector cabinet to select the tab you want.
5. Press the **ENTER** button on the remote control or the projector cabinet to display the submenu window.
6. Adjust the level or turn the selected item on or off by using the **SELECT** ▲▼◀▶ buttons on the remote control or the projector cabinet.  
Changes are stored until you adjust it again.
7. Repeat steps 2 -6 to adjust an additional item, or press the **EXIT** button on the remote control or the projector cabinet to quit the menu display.

---

*NOTE: When a menu or message is displayed, several lines of information may be lost, depending on the signal or settings.*

---

8. Press the **MENU** button to close the menu.  
To return to the previous menu, press the **EXIT** button.

### Using ADVANCED menu and BASIC menu

The projector has two menu modes: the ADVANCED menu and the BASIC menu.

**ADVANCED menu** .. This is the menu that contains all the available menus and commands. Users with an ADMINISTRATOR or ADVANCED account can access the ADVANCED menu.

**BASIC menu** ..... This is the basic menu that contains minimum essentials of menus and commands. Users with a BASIC account can access the BASIC menu.

See page 49 for settings available to ADVANCED and BASIC menus.

#### NOTE:

- A user with an ADMINISTRATOR account that has no password set is registered at the factory. This will allow the user to access the ACCOUNT items without password entry.
- When using your USB mouse, click each number or alphabet.  
BS: Delete the character before the cursor or highlight.  
OK/[ENTER]: Confirm the keyword and close the Software keyboard.

### Entering alphanumeric characters by using Software Keyboard

[IP ADDRESS, PASSWORD]

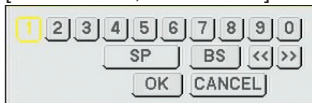

[USER NAME, PROJECTOR NAME]



[PASSWORD OR KEYWORD]

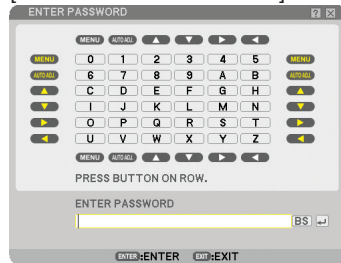

#### 1 to 0 and Characters

..... Use to type in password or keyword.

MODE ..... Selects one of three modes for numbers, alphabet and special characters.

SP ..... Inserts a space

BS ..... Deletes one character backward

<< ..... Returns to the previous

>> ..... Advances to the next

OK ..... Executes the selection

CANCEL ..... Cancels the selection

#### When using the remote control:

1. Press the MENU, AUTO ADJ, SELECT ▲, SELECT ▼, SELECT ► or SELECT ◀ button to select a character in the row.

Example: To enter "C", press the SELECT ▲ button.

2. Press the MENU, AUTO ADJ, SELECT ▲, SELECT ▼, SELECT ► or SELECT ◀ button to select a character in the column.

Example: To enter "C", press the MENU button.

EXIT ..... Deletes a character.

ENTER ..... Makes your input take effect and closes the input screen.

#### When using the mouse:

Point to a character and click it.

[BS] ..... Deletes a character.

[ENTER] ..... Makes your input take effect and closes the input screen.

2 Menu tree

Basic menu items are indicated by shaded area.

Factory default settings are indicated by the gray shaded area.

Menu		Item				
SOURCE		COMPUTER 1, COMPUTER 2, HDMI, VIDEO, S-VIDEO, VIEWER, NETWORK, ENTRY LIST				
ADJUST	PICTURE	MODE	STANDARD, PROFESSIONAL			
			1 to 7			
		PRESET	DETAIL SETTINGS	GENERAL	REFERENCE	HIGH-BRIGHT, PRESENTATION, VIDEO, MOVIE, GRAPHIC, sRGB, DICOM SIM.
					GAMMA CORRECTION	DYNAMIC, NATURAL, BLACK DETAIL
					COLOR TEMPERATURE	5000, 6500, 7800, 8500, 9300, 10500
					WHITE BALANCE	CONTRAST RGB, BRIGHTNESS RGB
		CONTRAST				
		BRIGHTNESS				
		SHARPNESS				
		COLOR				
	HUE					
	RESET					
	IMAGE OPTIONS	CLOCK				
		PHASE				
		HORIZONTAL POSITION				
		VERTICAL POSITION				
		OVERSCAN	0%, 5%, 10%			
		ASPECT RATIO	RGB	5:4, 4:3, 16:9, 16:10, 15:9		
			4:3 SCREEN (COMPONENT)/VIDEO/S-VIDEO	4:3, LETTERBOX, WIDE SCREEN, ZOOM		
		WIDE SCREEN (COMPONENT)/VIDEO/S-VIDEO	4:3 WINDOW, LETTERBOX, WIDE SCREEN, 4:3 FILL			
	RESOLUTION	AUTO, NATIVE				
	VIDEO	NOISE REDUCTION	RANDOM NR, MOSQUITO NR, BLOCK NR			
		DEINTERLACE	AUTO, VIDEO, FILM			
		3D Y/C SEPARATION	OFF, ON			
	AUDIO	VOLUME, BASS, TREBLE, BALANCE, 3D SURROUND (OFF, ON)				
	SETUP	BASIC	KEYSTONE	AUTO KEYSTONE, HORIZONTAL, VERTICAL		
			CORNERSTONE			
PIP/SIDE BY SIDE			MODE, POSITION, SOURCE			
WALL COLOR			OFF, BLACKBOARD, BLACKBOARD (GRAY), LIGHT YELLOW, LIGHT GREEN, LIGHT BLUE, SKY BLUE, LIGHT ROSE, PINK			
LAMP MODE			NORMAL, ECO			
OFF TIMER			OFF, 0:30, 1:00, 2:00, 4:00, 8:00, 12:00, 16:00			
TOOLS			PROGRAM TIMER, CORNERSTONE, ENTRY LIST, [DATE, TIME PRESET], [MOUSE], [HELP]			
LOGOFF						
LANGUAGE			ENGLISH, DEUTSCH, FRANÇAIS, ITALIANO, ESPAÑOL, SVENSKA, SUOMI, NORSK, NEDERLANDS, TÜRKÇE, POLSKI, РУССКИЙ, ΕΛΛΗΝΙΚΑ, MAGYAR, PORTUGÊS, ČEŠTINA, عربي, DANSK, 日本語, 한국어, 中文			
MENU		COLOR SELECT	COLOR, MONOCHROME			
		SOURCE DISPLAY	ON, OFF			
		MESSAGE DISPLAY	ON, OFF			
		TIME DISPLAY	ON, OFF			
		ID DISPLAY	ON, OFF			
		MENU DISPLAY TIME	MANUAL, AUTO 5 SEC, AUTO 15 SEC, AUTO 45 SEC			
		BACKGROUND	BLUE, BLACK, LOGO			
		FILTER MESSAGE	OFF, 100[H], 200[H], 500[H], 1000[H]			
CLOSED CAPTION	OFF, CAPTION 1-4, TEXT 1-4					

## 6. Using On-Screen Menu

Menu		Item		
SETUP	INSTALLATION (1)	ORIENTATION	DESKTOP FRONT, CEILING REAR, DESKTOP REAR, CEILING FRONT	
		SCREEN	SCREEN TYPE: 4:3 SCREEN, WIDE SCREEN* <sup>1</sup> / POSITION* <sup>2</sup>	
		GEOMETRIC CORRECTION	OFF, 1, 2, 3	
		MULTI-SCREEN COMP.	MODE, CONTRAST, BRIGHTNESS	
	INSTALLATION (2)	NETWORK SETTINGS	GENERAL	PROJECTOR NAME, WIRED LAN, WIRELESS LAN
			WIRED	PROFILES, DHCP, IP ADDRESS, SUBNET MASK, GATEWAY, DNS CONFIGURATION, RECONNECT
			WIRELESS	PROFILES, DHCP, IP ADDRESS, SUBNET MASK, GATEWAY, DNS CONFIGURATION, ADVANCED, RECONNECT
			DOMAIN	HOST NAME, DOMAIN NAME
			MAIL	ALERT MAIL, SENDER'S ADDRESS, SMTP SERVER NAME RECIPIENT'S ADDRESS 1-3, TEST MAIL
		COMMUNICATION SPEED	4800 BPS, 9600 BPS, 19200 BPS, 38400 BPS	
		SECURITY SETTINGS	CONTROL PANEL LOCK, BACKGROUND LOCK, ACCOUNT LOCK, ACCOUNT, SECURITY, PJLink	
		STANDBY MODE	NORMAL / POWER-SAVING	
		REMOTE SENSOR	FRONT / BACK, FRONT, BACK	
		CONTROL ID	CONTROL ID NUMBER, CONTROL ID	
	OPTIONS	AUTO ADJUST	OFF, NORMAL, FINE	
		AUTO POWER ON (AC)	OFF, ON	
		AUTO POWER OFF	OFF, 0:05, 0:10, 0:20, 0:30	
		FAN MODE	AUTO, HIGH, HIGH ALTITUDE	
		DEFAULT SOURCE SELECT	LAST, AUTO, COMPUTER1, COMPUTER2, HDMI, VIDEO, S-VIDEO, VIEWER, NETWORK	
		SIGNAL SELECT	COMPUTER1	RGB/COMPONENT, RGB, COMPONENT
			COMPUTER2	RGB/COMPONENT, RGB, COMPONENT
		COLOR SYSTEM	VIDEO, S-VIDEO	
		HDMI SETTINGS	VIDEO LEVEL, AUDIO SELECT	
		OUT TERMINAL	LAST, COMPUTER1, COMPUTER2	
	INFO.	USAGE TIME	LAMP LIFE REMAINING, LAMP HOURS USED, FILTER HOURS USED	
		SOURCE (1)	INPUT TERMINAL, SIGNAL TYPE, VIDEO TYPE, SOURCE NAME, ENTRY NO.	
		SOURCE (2)	HORIZONTAL FREQUENCY, VERTICAL FREQUENCY, SYNC TYPE, SYNC POLARITY, SCAN TYPE	
WIRED LAN		IP ADDRESS, SUBNET MASK, GATEWAY, MAC ADDRESS		
WIRELESS LAN (1)		IP ADDRESS, SUBNET MASK, GATEWAY, MAC ADDRESS, AUTHENTICATION		
WIRELESS LAN (2)		SSID, NETWORK TYPE, WEP/WPA, CHANNEL, SIGNAL LEVEL		
VERSION (1)		PRODUCT, SERIAL NUMBER, LAN UNIT TYPE, LAN UNIT VERSION		
VERSION (2)		FIRMWARE, DATA, FIRMWARE2, DATA2		
RESET	CURRENT SIGNAL, ALL DATA, ALL DATA (INCLUDING ENTRY LIST), CLEAR LAMP HOURS, CLEAR FILTER HOURS			

**NOTE:**

\*<sup>1</sup> Default SCREEN TYPE is 4:3 SCREEN for NP905 and WIDE SCREEN for NP901W.

\*<sup>2</sup> POSITION is not available with NP901W.

### 3 Menu Elements

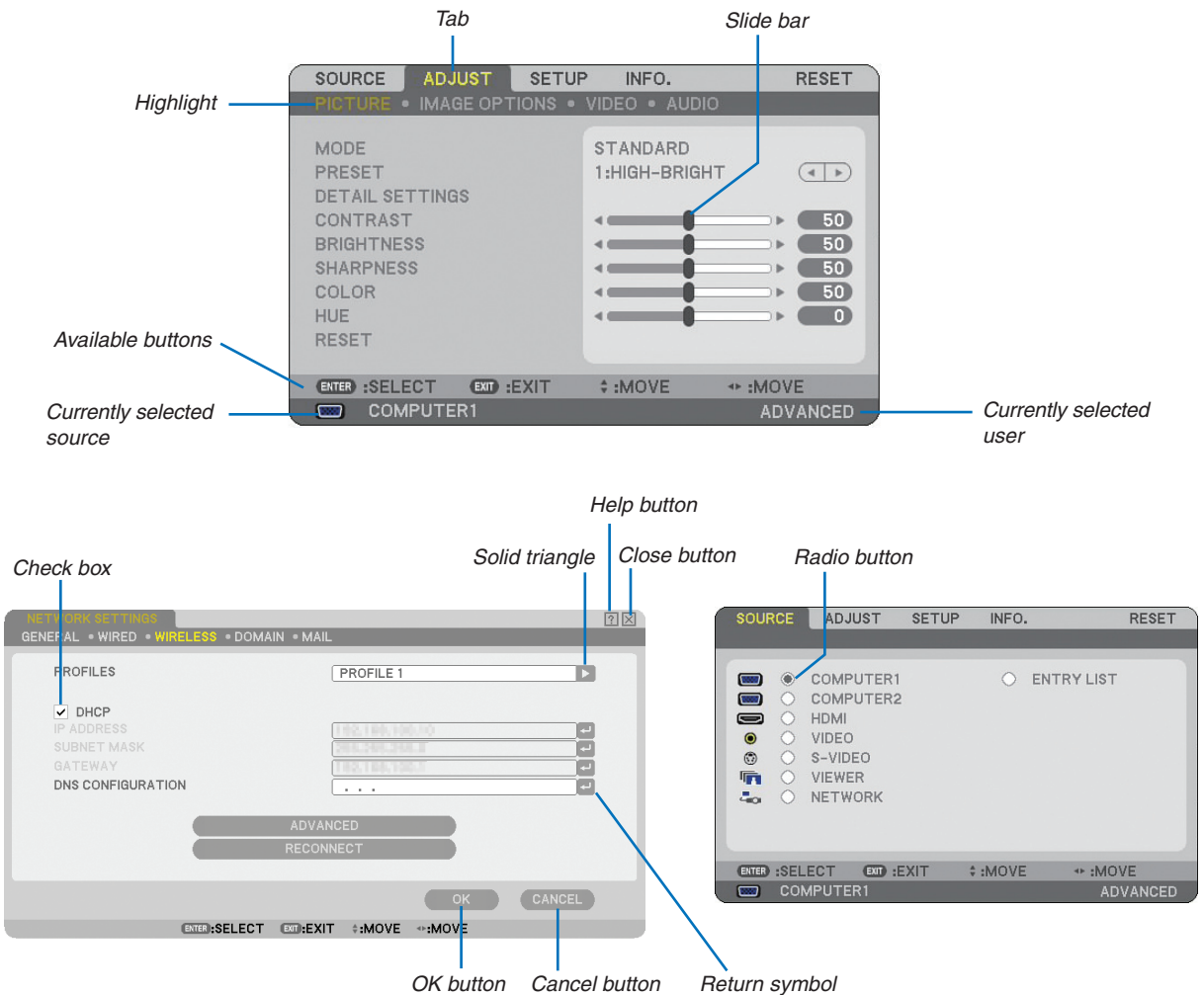

**Menu windows or dialog boxes typically have the following elements:**

- Highlight..... Indicates the selected menu or item.
- Solid triangle ..... Indicates further choices are available. A highlighted triangle indicates the item is active.
- Tab..... Indicates a group of features in a dialog box. Selecting on any tab brings its page to the front.
- Radio button..... Use this round button to select an option in a dialog box.
- Check box..... Place a checkmark in the square box to turn the option On.
- Slide bar ..... Indicates settings or the direction of adjustment.
- OK button ..... Press to confirm your setting. You will return to the previous menu.
- Cancel button..... Press to cancel your setting. You will return to the previous menu.
- Close button ..... Click to close the window and saving changes (USB mouse only).
- Help button..... Indicates that help about that feature is available (USB mouse only). Press the HELP button on the remote control to display help.
- Return symbol..... Indicates the software keyboard is available.



## 4 Menu Descriptions & Functions [SOURCE]

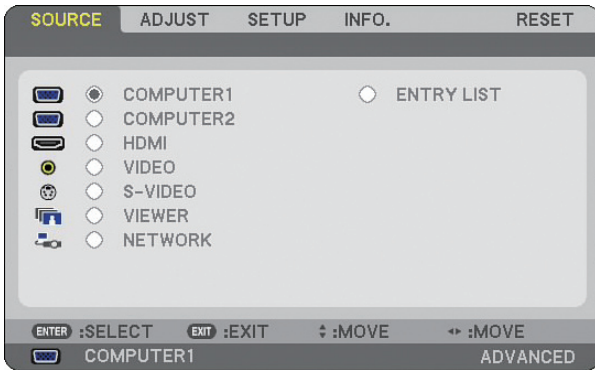

### COMPUTER 1 and 2

Selects the computer connected to your COMPUTER 1 or COMPUTER 2 input connector signal.

*NOTE: When the component input signal is connected to the COMPUTER 1 IN/COMPONENT 1 IN or COMPUTER 2 IN/COMPONENT 2 IN connector, select [COMPUTER 1] or [COMPUTER 2] respectively.*

### HDMI

Selects the HDMI compatible equipment connected to your HDMI IN connector.

### VIDEO

Selects what is connected to your VIDEO input-VCR, DVD player or document camera.

### S-VIDEO

Selects what is connected to your S-VIDEO input-VCR or DVD player.

*NOTE: A frame may freeze for a brief period of time when a video is played back in fast-forward or fast-rewind with a Video or S-Video source.*

### VIEWER

This feature enables you to make presentations using a USB memory that contains movie files, captured images and slides created with the exclusive Ulead Photo Explorer 8.0 for NEC contained on the CD-ROM. See the supplied NEC Wired and Wireless Network Setup Guide for installing the Ulead Photo Explorer 8.0 for NEC.

(→ page 63 “5. Using the Viewer”)

### NETWORK

Selects a signal from the LAN port (RJ-45) or the installed USB wireless LAN unit.

When a source connected on a network is not made settings, the [NETWORK] menu will be displayed.

(→ page 99)

### ENTRY LIST

Displays a list of signals. (→ page 76)

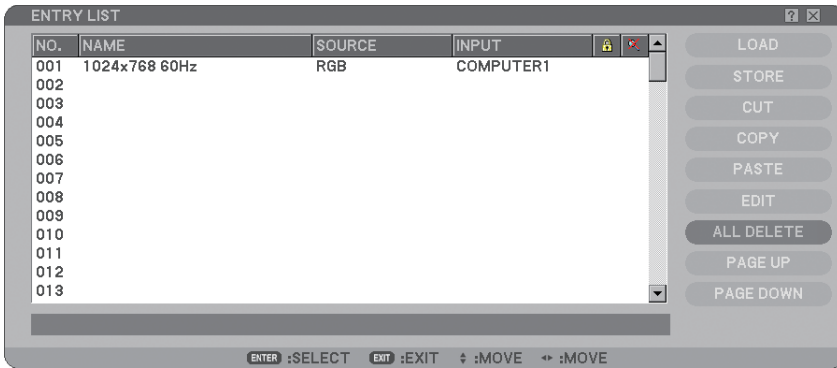
**[ENTRY LIST]****Using the Entry List**

When any source adjustments are made, the adjustments are automatically registered in the Entry List. The (adjustment values of) registered signals can be loaded from the Entry List whenever necessary. However, only up to 100 patterns can be registered in the Entry List. When 100 patterns have been registered in the Entry List, an error message is then displayed and no additional patterns can be registered. You should thus delete (adjustment values of) signals that are no longer needed.

**Entering the Currently Projected Signal into the Entry List**

1. *Display the Entry List.*
2. *Use the SELECT ▲ or ▼ button on your remote control or the projector cabinet to select any number.*
3. *Use the SELECT ► button to select [STORE] and press the ENTER button.*

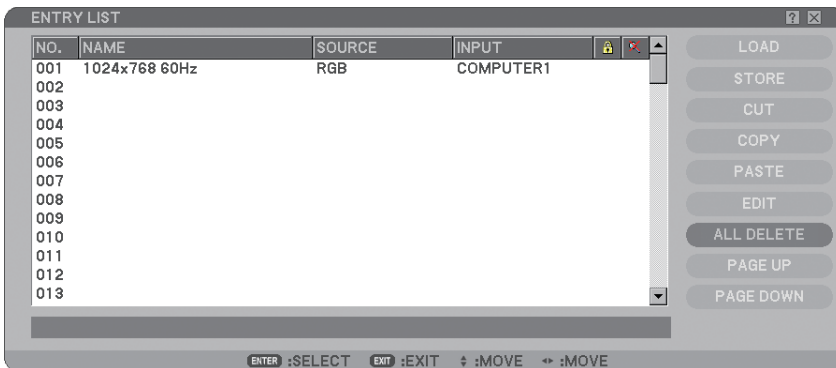

You can edit signals on the [ENTRY LIST].

- LOAD ..... Enables you to select a signal from the list.
- STORE ..... Enables you to store the currently projected signal.
- CUT..... Enables you to remove a selected signal from the list and place it on the “clipboard” in the projector.
- COPY ..... Enables you to copy a selected signal from the list and place it on the “clipboard” in the projector.
- PASTE..... Enables you to paste the signal placed on the “clipboard” to any other line of the list.
- EDIT..... Enables you to change SOURCE NAME, INPUT TERMINAL, LOCK, and SKIP.

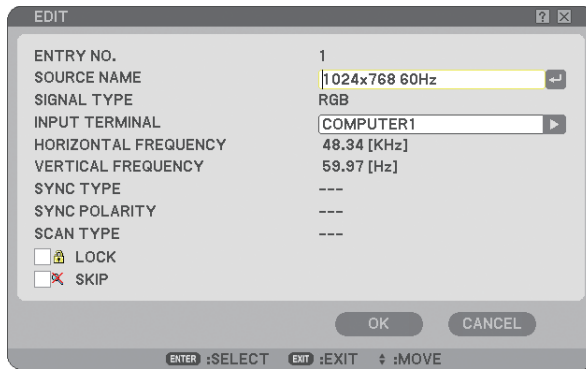

### SOURCE NAME:

Enter a signal name. Up to 18 alphanumeric characters can be used.

### INPUT TERMINAL:

Change the input terminal.

### LOCK:

Set so that the selected signal cannot be deleted when [ALL DELETE] is executed. After executing [LOCK], the changes cannot be saved.

### SKIP:

Set so that the selected signal will be skipped during auto search.

When complete, select OK and press ENTER. To exit without storing the setting, select Cancel. Select [SOURCE NAME] and press ENTER to display the Source Name Edit window. You can change source name on this window. Press  to display the software keyboard, which you can enter alphanumeric characters.

ALL DELETE..... This feature enables you to delete all the registered signals in the Entry List.

PAGE UP/ PAGE DOWN... Enables you to go to the next page or the previous page.

The following buttons are not available for the currently projecting signals:

- 1) The CUT and PASTE buttons on the [ENTRY LIST] screen
- 2) The INPUT TERMINAL button on the [EDIT] screen

---

*NOTE: When all the signals in the [ENTRY LIST] are deleted, the currently projected signal will be also deleted except locked signals.*

---

## 5 Menu Descriptions & Functions [ADJUST]



### [PICTURE]



### [MODE]

This function allows you to determine how to save settings for [DETAIL SETTINGS] of [PRESET] for each input.

STANDARD..... Saves settings for each item of [PRESET] (Preset 1 through 7)

PROFESSIONAL..... Saves all the settings of [PICTURE] for each input.

### [PRESET]

This option allows you to adjust neutral tint for yellow, cyan or magenta. There are seven factory presets optimized for various types of images, you can set user adjustable settings.

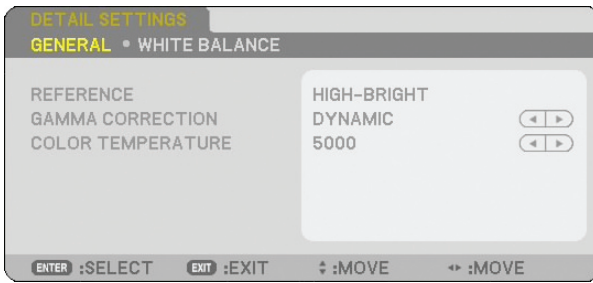
**[DETAIL SETTINGS]**

This will provide you with two pages of menus that provide more detailed settings.

**[GENERAL]****Selecting Reference Setting [REFERENCE]**

This feature allows you to use color correction or gamma values as reference data to optimize for various types of images. You can select one of the following seven settings.

- HIGH-BRIGHT .... Recommended for use in a brightly lit room.
- PRESENTATION . Recommended for making a presentation using a PowerPoint file.
- VIDEO ..... Recommended for typical TV program viewing.
- MOVIE..... Recommended for movies.
- GRAPHIC ..... Recommended for graphics.
- sRGB..... Standard color values.
- DICOM SIM..... Recommended for DICOM simulation format.

**NOTE:**

- The DICOM SIM option is for training/reference only and should not be used for actual diagnosis.
- DICOM stands for Digital Imaging and Communications in Medicine. It is a standard developed by the American College of Radiology (ACR) and the National Electrical Manufacturers Association (NEMA).  
The standard specifies how digital image data can be moved from system to system.

**Selecting Gamma Correction Mode [GAMMA CORRECTION]**

Each mode is recommended for:

- DYNAMIC..... Creates a high-contrast picture.
- NATURAL..... Natural reproduction of the picture.
- BLACK DETAIL ... Emphasizes detail in dark areas of the picture.

**Adjusting Color Temperature [COLOR TEMPERATURE]**

This option allows you to select the color temperature of your choice.

**NOTE:**

- When [PRESENTATION] or [HIGH-BRIGHT] is selected in [REFERENCE], this function is not available.
- When [WHITE BALANCE] settings has been changed, the color temperature value on screen does not reflect the real color temperature.

**[WHITE BALANCE]****Adjusting White Balance [WHITE BALANCE]**

This allows you to adjust the white balance. Contrast for each color (RGB) to adjust the white level of the screen; Brightness for each color (RGB) is used to adjust the black level of the screen.

### [CONTRAST]

Adjusts the intensity of the image according to the incoming signal.

### [BRIGHTNESS]

Adjusts the brightness level or the back raster intensity.

### [SHARPNESS]

Controls the detail of the image for Video. (not valid for RGB and digital signals).

### [COLOR]

Increases or decreases the color saturation level (not valid for RGB and digital signals).

### [HUE]

Varies the color level from +/- green to +/-blue. The red level is used as reference. This adjustment is only valid for Video, Component and TV standard inputs (not valid for RGB and digital signals).

Input signal	CONTRAST	BRIGHTNESS	SHARPNESS	COLOR	HUE
Computer/HDMI (RGB)	Yes	Yes	No	No	No
Computer/HDMI (Component)	Yes	Yes	Yes	Yes	Yes
Video, S-Video	Yes	Yes	Yes	Yes	Yes
Viewer, Network	Yes	Yes	No	No	No

Yes=Adjustable, No=Not adjustable

### [RESET]

The settings and adjustments for [PICTURE] will be returned to the factory settings with the exception of the following; Preset numbers and [REFERENCE] within the [DETAIL SETTINGS] screen when [STANDARD] is selected in [MODE]. The settings and adjustments under [DETAIL SETTINGS] within the [PRESET] screen that are not currently selected will not be reset.

**[IMAGE OPTIONS]**

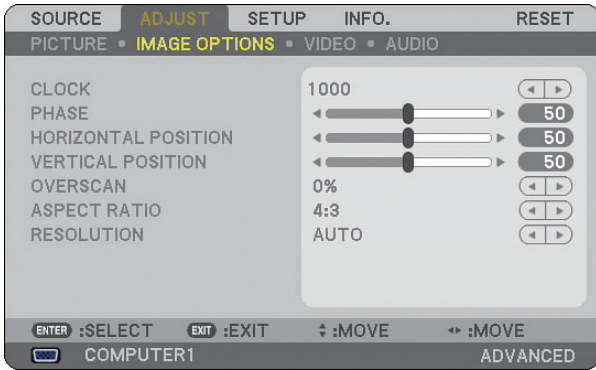

**Adjusting Clock and Phase [CLOCK/PHASE]**

This allows you to manually adjust CLOCK and PHASE.

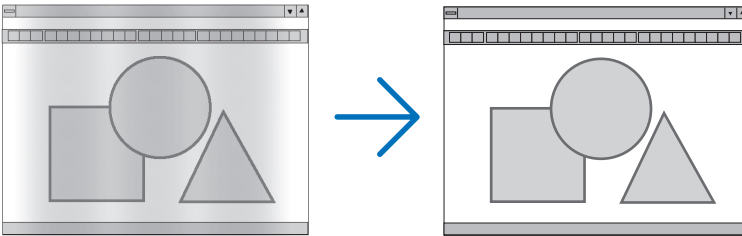

**CLOCK**..... Use this item to fine tune the computer image or to remove any vertical banding that might appear. This function adjusts the clock frequencies that eliminate the horizontal banding in the image. This adjustment may be necessary when you connect your computer for the first time.

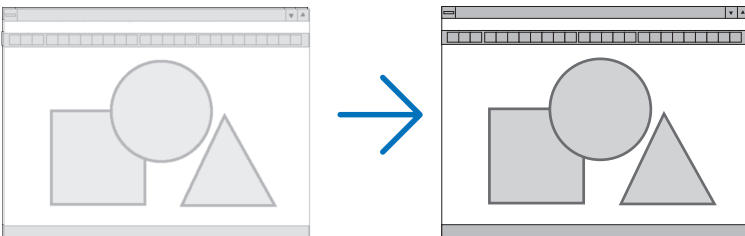

**PHASE**..... Use this item to adjust the clock phase or to reduce video noise, dot interference or cross talk. (This is evident when part of your image appears to be shimmering.) Use [PHASE] only after the [CLOCK] is complete.

**Adjusting Horizontal/Vertical Position [HORIZONTAL/VERTICAL POSITION]**

Adjusts the image location horizontally and vertically.

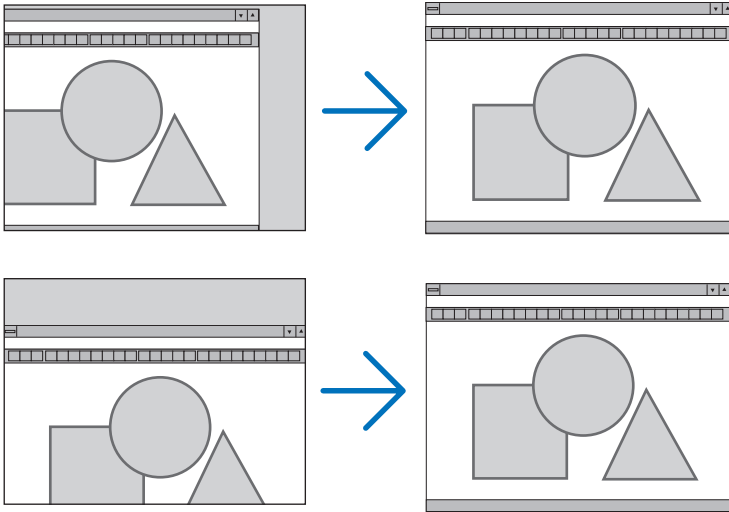

**Selecting Overscan Percentage [OVERSCAN]**

Select overscan percentage (0%, 5% and 10%) for signal.

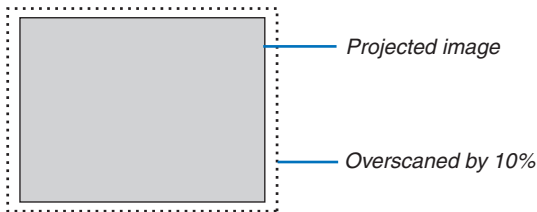

---

*NOTE: When [NATIVE] is selected in [RESOLUTION], [OVERSCAN] is not available.*

---



Selecting Aspect Ratio [ASPECT RATIO]

Screen Type 4:3 SCREEN (VIDEO)

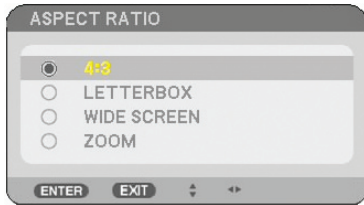

Screen Type WIDE SCREEN (VIDEO)



RGB

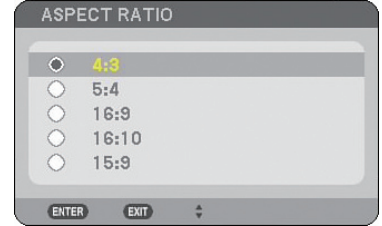

Aspect Ratio allows you to select the best Aspect mode to display your source image. When screen type 4:3 SCREEN is selected for the source, the following selections will display:

**For VIDEO**

- 4:3 ..... Standard 4:3 aspect
- LETTERBOX ..... Reduced to display the true aspect with black borders on top and bottom
- WIDE SCREEN ..... Left & Right stretched with black borders on top and bottom
- ZOOM ..... Left & Right stretched. Left & Right sides cut. Available for 4:3 only.

When screen type WIDE SCREEN is selected for the source, the following selections will display:

**For VIDEO**

- 4:3 WINDOW ..... Reduced to display the true aspect with black borders on right and left
- LETTERBOX ..... Standard 16:9 aspect
- WIDE SCREEN ..... Left and right stretched to display the true aspect
- 4:3 FILL ..... Stretched to display in 16:9 aspect ratio

**For RGB**

- 4:3 ..... For a video signal with an aspect ratio of 4:3
- 5:4 ..... For a video signal with an aspect ratio of 5:4
- 16:9 ..... For a video signal with an aspect ratio of 16:9
- 16:10 ..... For a video signal with an aspect ratio of 16:10
- 15:9 ..... For a video signal with an aspect ratio of 15:9

**NOTE:**

- You can adjust image position vertically for a source with black borders on top and bottom. (→ page 97)
- When [NATIVE] is selected in [RESOLUTION], [ASPECT RATIO] is not available.

*NOTE: Please note that using this projector for the purpose of commercial gain or the attraction of public attention in a venue such as a coffee shop or hotel and employing compression or expansion of the screen image with a [ASPECT RATIO] or [SCREEN] setting may raise concern about the infringement of copyrights which are protected by copyright law.*

**NP905**

**VIDEO**

Input Signal / Screen Type	4:3	SQUEEZE	LETTERBOX	
Screen Type	4:3	WIDE SCREEN	ZOOM	LETTERBOX
Screen Type	4:3 WINDOW	4:3 Fill	WIDE SCREEN	LETTERBOX

**RGB (HDMI included)**

Screen Type	Input Signal	4:3	5:4	16:9	16:10	15:9
	4:3 SCREEN					
Screen Type	4:3 SCREEN					
	WIDE SCREEN					

**NP901W**

**VIDEO**

Screen Type	Input Signal	4:3	LETTERBOX	SQUEEZE	4:3	
	4:3 SCREEN					
Screen Type	WIDE SCREEN					

**RGB (HDMI included)**

Screen Type	Input Signal	4:3	5:4	16:9	16:10	15:9
	4:3 SCREEN					
Screen Type	WIDE SCREEN					

Typical resolutions and aspect ratios for computer screens.

Resolution	Aspect Ratio
VGA 640 x 480	4:3
SVGA 800 x 600	4:3
XGA 1024 x 768	4:3
SXGA 1280 x 1024	5:4
WXGA 1280 x 768	15:9
WXGA 1280 x 800	16:10
UXGA 1600 x 1200	4:3

**Selecting Resolution [RESOLUTION]**

[AUTO] : Displays an RGB signal to fit the screen in the projector’s native resolution (NP905: 1024 x 768 pixels/ NP901W: 1280 x 800 pixels).

[NATIVE] : Displays an RGB signal in its true resolution.

Example: When a source with 800 x 600 pixels is selected using the NP905/NP901W:

**NP905**

**NP901W**

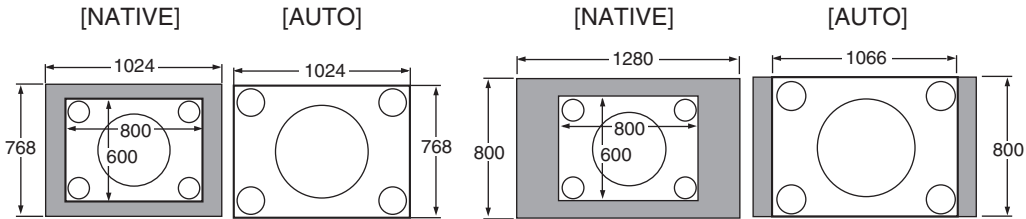

- When [NATIVE] is selected, [OVERSCAN] and [ASPECT] are not available.
- [RESOLUTION] is not available under the following conditions:
  - When [SCREEN TYPE] is set for the resolution other than the projector’s native resolution.
  - When a signal other than RGB is selected.
  - When a signal with a higher resolution than the projector’s native resolution is displayed.

**[VIDEO]**

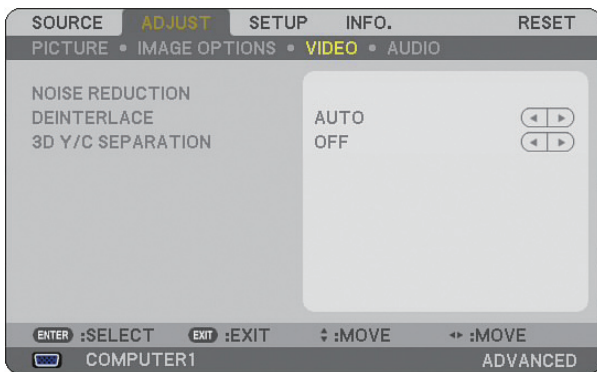

**Using Noise Reduction [NOISE REDUCTION]**

This function is used to reduce video noise.

- RANDOM NR ..... Reduces flickering random noise in an image.
- MOSQUITO NR ..... Reduces mosquito noise that appears around the edges of an image during DVD playback.
- BLOCK NR ..... Reduces block noise or mosaic-like patterns by selecting ON.

**Selecting Interlaced Progressive Conversion Process Mode [DEINTERLACE]**

This function allows you to select an interlaced-to-progressive conversion process for video signals.

- AUTO ..... Determines an appropriate interlaced-to-progressive conversion process automatically.
- VIDEO ..... Applies a normal interlaced-to-progressive conversion process.
- FILM ..... Applies the automatic detection mode for telecine signals. This option is recommended for a movie picture.

*NOTE: This function is not available with RGB signals.*

### Turning On or Off the 3D Dimensional Separation [3D Y/C SEPARATION]

When projecting an image from a VIDEO input, set to ON to project the highest quality image.

OFF ..... Turns off the 3 dimensional separation feature.

ON ..... Turns on the 3 dimensional separation feature.

---

*NOTE: Only available for NTSC 3.58 video signals.*

---

### [AUDIO]

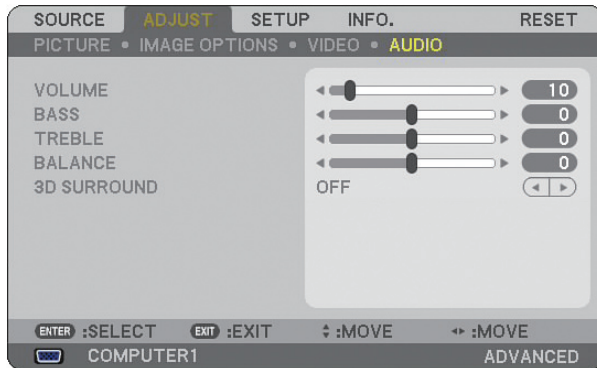

### Controlling Sound [VOLUME/BASS/TREBLE/BALANCE]

Adjusts the volume, bass and treble level, left and right balance of the projector speaker and AUDIO OUT (Stereo Mini Jack).

### Enabling 3D Surround [3D SURROUND]

Turn on or off the 3D surround effect.

If the AUDIO OUT stereo mini jack of the projector is connected to external equipment, adjusting the sound on the external equipment can cause sound to be distorted or cracked, depending on the bass, treble or 3D Surround adjustment. If this happens, return the adjustments of the projector to the factory default (BASS:0, TREBLE: 0, 3D SURROUND: OFF).

## 6 Menu Descriptions & Functions [SETUP]

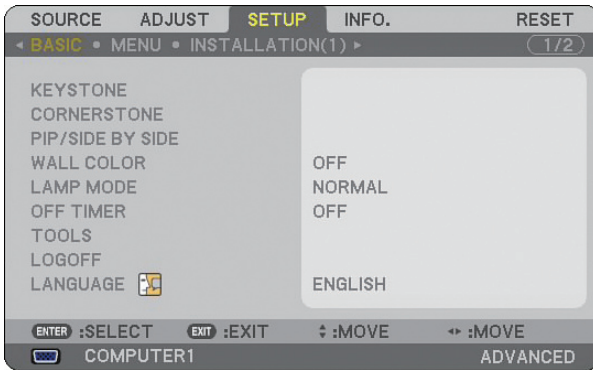

### [BASIC]

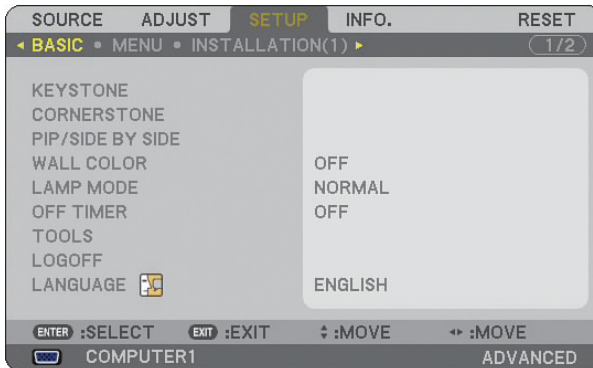

### Selecting Keystone Mode [KEYSTONE]

This feature allows you to correct keystone distortion. Selecting this item will display the Keystone setting menu. [AUTO KEYSTONE] will turn on the auto keystone feature. Changes will be saved even when you turn off the projector. You can correct vertical distortion manually from the menu. (→ page 28) To do do, select [OFF] on the[AUTO KEYSTONE] screen.

---

*NOTE: The [KEYSTONE] item is not available when [CORNERSTONE] or [GEOMETRIC CORRECTION] is selected.*

---

### Selecting Cornerstone Mode [CORNERSTONE]



This option allows you to correct trapezoidal distortion.

Selecting this item will display the Cornerstone adjustment screen. (→ page 38)

---

*NOTE: The [CORNERSTONE] item is not available when [KEystone] or [GEOMETRIC CORRECTION] is selected.*

---

### Using the PIP/SIDE BY SIDE Function [PIP/SIDE BY SIDE]

This function allows you to view two different signals simultaneously. (→ page 41)

#### MODE:

This option allows you to select two modes: PIP and SIDE BY SIDE.

PIP: This option allows you to view a sub picture in the main picture.

SIDE BY SIDE: This allows you to view two pictures side by side.

#### POSITION:

When [PIP] is selected for [MODE], this option allows you to select the position of a sub picture in the main picture.

The options are: top-left, top-right, bottom left, and bottom right.

---

*NOTE: The [POSITION] cannot be selected when [SIDE BY SIDE] is selected.*

---

#### SOURCE:

This option allows you to select a sub picture signal.

The options are: Off, VIDEO and S-VIDEO.

Selecting [OFF] will cancel the PIP/SIDE BY SIDE mode and return to the normal screen.

## Using the Wall Color Correction [WALL COLOR]

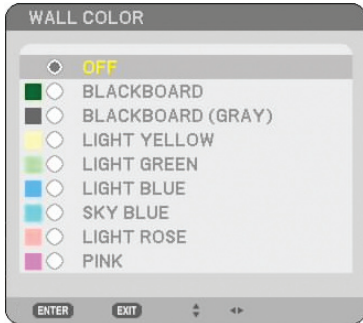

This function allows for quick adaptive color correction in applications where the screen material is not white. The following nine options are available.

## Setting Lamp Mode to Normal or Eco [LAMP MODE]

This feature enables you to select two brightness modes of the lamp: Normal and Eco modes. The lamp life can be extended by using the Eco mode. Selecting Eco mode decreases fan noise when compared to Normal mode.

Lamp Mode	Description	Status of LAMP indicator
NORMAL MODE	This is the Default setting (100% Brightness).	Off
ECO MODE	Select this mode to increase the lamp life (approx. 80% Brightness light output)	Steady Green light

*NOTE: If the projector is overheated in Normal mode, there may be a case where the Lamp mode will be forced into the Eco mode to protect the projector. This mode is called "forced Eco mode".*

*When the projector is in forced Eco mode, the picture brightness decreases. The LAMP indicator's steady green light indicates the lamp is in Eco mode.*

*When the projector comes back to normal temperature, the Lamp mode returns to Normal mode.*

*In the forced Eco mode, changing [LAMP MODE] setting in the menu will not affect the actual lamp mode.*

### Using Off Timer [OFF TIMER]

1. Select your desired time between 30 minutes and 16 hours: OFF, 0:30, 1:00, 2:00, 4:00, 8:00, 12:00, 16:00.
2. Press the ENTER button on the remote control.
3. The remaining time starts counting down.
4. The projector will turn off after the countdown is complete.

**NOTE:**

- To cancel the preset time, set [OFF] for the preset time or turn off the power.
- When the remaining time reaches 3 minutes before the projector is turned off, the [THE PROJECTOR WILL TURN OFF WITHIN 3 MINUTES] message will be displayed on the bottom of the screen.

### [TOOLS]



### Using Program Timer [PROGRAM TIMER]

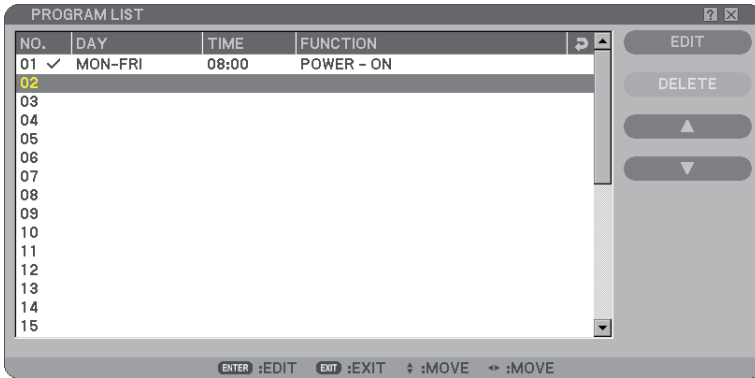

This option turns on/off the projector and changes video signals automatically at a specified time.

**NOTE:**

- Before setting the Program Timer, make sure that the [DATE, TIME PRESET] feature is set. (→ page 93)
- Make sure that the projector is in the stand by condition with the Main Power Switch on.
- The projector has a built-in clock. The clock will keep working for about two weeks after the main power is turned off. If the main power is not supplied to the projector for two weeks or more, the built-in clock stops working.



Setting a new program timer

1. On the **PROGRAM TIMER** screen, use the **SELECT ▲** or **▼** button to select **[SETTINGS]** and press the **ENTER** button.



The **[PROGRAM LIST]** screen will be displayed.

*NOTE: When the Program Timer is turned on, the **[PROGRAM LIST]** cannot be edited.*

2. Select a blank program number and press the **ENTER** button.

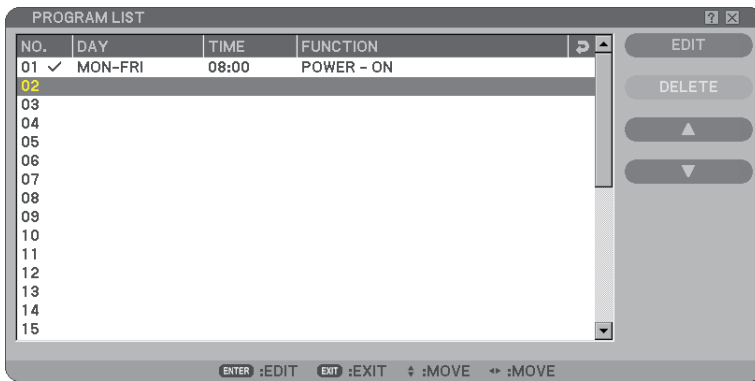

The **[EDIT]** screen will be displayed.

3. Make settings for each item as required.

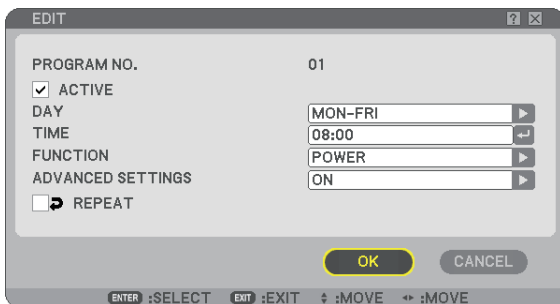

ACTIVE ..... Place a check mark to enable the program.

DAY..... Select days of the week for the program timer. To execute the program from Monday to Friday, select **[MON-FRI]**. To execute the program in everyday basis, select **[EVERYDAY]**.

TIME..... Set the time to execute the program. Enter time in 24-hour format.

FUNCTION ..... Select a function to be executed. Selecting **[POWER]** will allow you to turn on or off the projector by setting **[ADVANCED SETTINGS]**. Selecting **[SOURCE]** will allow you to select a video source by setting **[ADVANCED SETTINGS]**.

ADVANCED SETTINGS.. Select power on/off or a type of video source for the selected item in **[FUNCTION]**.

REPEAT..... Place a check mark to repeat the program continuing basis . To use the program this week only, clear the check mark.

### 4. Select [OK] and press the ENTER button.

*This will complete the settings.*

*You will be returned to the [PROGRAM LIST] screen.*

---

#### NOTE:

- *Up to 30 different timer settings can be programmed.*
  - *When [PROGRAM TIMER] is turned on, the [STANDBY MODE] setting is ignored.*
  - *The Program Timer is executed on a set time basis, not in a program basis.*
  - *Once the program not marked with a check in [REPEAT] has been executed, the check mark in the [ACTIVE] check box will be cleared automatically and the program will be disabled.*
  - *When the on-time and the off-time set for the same time, the off-time setting will take preference.*
  - *Two different sources are set for the same time, the larger program number will take preference.*
  - *The on-time setting will not be executed while the cooling fans are running or an error is occurring.*
  - *If the off-time setting is expired under the condition in which the power off is not possible, the off-timer setting will not be executed until the power off becomes possible.*
  - *Programs not marked with a check mark in [ACTIVE] of the [EDIT] screen will not be executed even if the Program Timer is enabled.*
  - *When the projector is turned on by using the program timer and if you want to turn off the projector, set the off-time or do it manually so as not to leave the projector on for a long period of time.*
- 

### Activating the program timer

#### 1. Select [ON] on the [PROGRAM TIMER] screen and press the ENTER button.

*The [ON] will be activated.*

#### 2. Press the EXIT button.

*The [PROGRAM TIMER] screen will be changed to the [TOOL] screen.*

---

#### NOTE:

- *Selecting [OFF] will disable the Program Timer even when a program is marked with a check mark on [PROGRAM LIST] screen.*
  - *When the [ON] is turned on, the [PROGRAM LIST] cannot be edited. To edit the programs, select [OFF] to turn off the Program Timer.*
- 

### Changing the programmed settings

#### 1. On the [PROGRAM LIST] screen, select a program you want to edit and press the ENTER button.

#### 2. Change the settings on the [EDIT] screen.

#### 3. Select [OK] and press the ENTER button.

*The programmed settings will be changed.*

*You will be returned to the [PROGRAM LIST] screen.*

### Changing the order of programs

#### 1. On the [PROGRAM LIST] screen, select a program whose order you want to change and press the SELECT ► button.

#### 2. Press the SELECT ▼ button to select ▲ or ▼.

#### 3. Press the ENTER button a few times to select a row to which you wish to move the program.

*The order of the programs will be changed.*

### Deleting the programs

1. **On the [PROGRAM LIST] screen, select a program number you want to delete and press the SELECT ► button.**
2. **Press the SELECT ▼ button to select [DELETE].**
3. **Press the ENTER button.**  
*The confirmation screen will be displayed.*
4. **Select [YES] and press the ENTER button.**  
*The program will be deleted.*

*This will complete deleting the program.*

### Using [CORNERSTONE]

(→ page 38)

### Using [ENTRY LIST]

(→ page 76)

### Setting the Current Date and Time [DATE, TIME PRESET]

You can set the current time, month, date, and year.

---

*NOTE: The projector has a built-in clock. The clock will keep working for about 2 weeks after the main power is turned off. If the main power is off for 2 weeks or more, the built-in clock will cease. If the built-in clock ceases, set the date and time again. The built-in clock will not cease while in the standby mode.*

---

TIME ZONE: Select your time zone.

DAYLIGHT SAVING TIME: Place a check mark to adjust the clock for daylight saving changes.

INTERNET TIME SERVER: Place a check mark to turn on clock synchronization. When this option is turned on, the projector's built-in clock will be synchronized with an Internet timer server in every 24 hours and at the time of projector's start up.

UPDATE button: Synchronizes the projector's built-in clock immediately.

The UPDATE button is not available unless the INTERNET TIME SERVER check box is turned on.

### Setting Mouse Pointer, Button and Sensitivity [MOUSE]

This option lets you to change your USB mouse settings. The mouse settings feature is available for USB mouse only. Choose the settings you want:

MOUSE BUTTON ... [RIGHT HAND] or [LEFT HAND]

MOUSE SENSITIVITY.. [FAST], [MEDIUM] or [SLOW]

### Using [HELP]

(→ page 34)

### Logging Off Your Projector [LOGOFF]

This feature allows you to log off your projector without turning it off.

Logging off your projector will prevent an unauthorized user from operating your projector.

To log off your projector, follow the steps below.

1. Press the **MENU** button and use the **SELECT ►** button to highlight [SETUP].

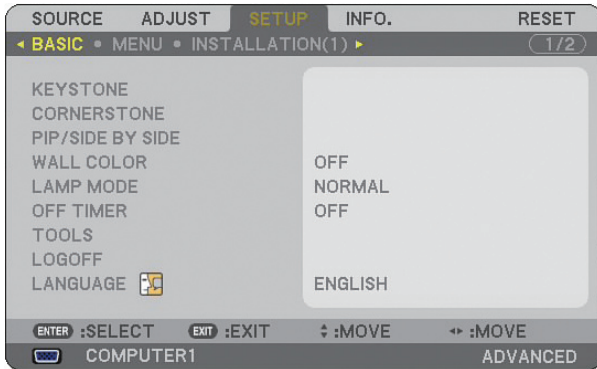

2. Use the **SELECT ▼** or the **ENTER** button to highlight [BASIC].



3. Use the **SELECT ▼** button to highlight [LOGOFF], and press the **ENTER** button.

The [LOG OFF PROJECTOR /ARE YOU SURE?] message will be displayed.

4. Select [YES] and press the **ENTER** button to log off your projector and close the menu, and then the **LOGON** screen will be displayed.

---

**NOTE:**

- When selecting [NO] and press the **ENTER** button, you will return to the Logoff screen in Step 2.
- 

To log on your projector, select a user name, then enter your password and select [OK] and press the **ENTER** button.

The **LOGON** screen will close. Logging on your projector is done.

---

**NOTE:**

The default **LOGON** screen will be shown as follows:

USER NAME → ADMINISTRATOR

PASSWORD → No setting

See "Limiting Access Level to Available Menu Items" on page 49 for entering a user name and assigning a password.

---

### Selecting Menu Language [LANGUAGE]

You can choose one of 21 languages for on-screen instructions.

**[MENU]****Selecting Menu Color [COLOR SELECT]**

You can choose between two options for menu color: color and monochrome.

**Turning On / Off Source Display, Message and Time [SOURCE DISPLAY], [MESSAGE DISPLAY], [TIME DISPLAY], [ID DISPLAY]**

- SOURCE DISPLAY ..... This option turns on or off input name display such as Computer 1, Computer 2, HDMI, Video, and No Input to be displayed on the top right of the screen.
- MESSAGE DISPLAY ..... This option turns on or off messages. Even though selecting [OFF], the following message will appear.
  - “Projector is locked”. When the projector security is unlocked, the message will disappear.
- TIME DISPLAY ..... This option turns on or off the current time displayed on the top left of the screen.
- ID DISPLAY ..... This option turns on or off the ID number which is displayed when the ID SET button on the remote control is pressed.

*NOTE: The source and current time will be displayed for the time specified in [MENU DISPLAY TIME]. When [MANUAL] is selected in [MENU DISPLAY TIME], the source and current time will be always displayed.*

**Selecting Menu Display Time [MENU DISPLAY TIME]**

This option allows you to select how long the projector waits after the last touch of a button to turn off the menu. The preset choices are [MANUAL], [AUTO 5 SEC], [AUTO 15 SEC], and [AUTO 45 SEC]. The [AUTO 45 SEC] is the factory preset.

**Selecting a Color or Logo for Background [BACKGROUND]**

Use this feature to display a blue/black screen or logo when no signal is available. The default background is blue. You can change the logo screen using the Viewer feature. (→ page 63)

**NOTE:**

- Your setting will not be affected even when [RESET] is done from the menu.
- When the BACKGROUND LOCK in [SECURITY SETTINGS] is turned on, the background cannot be changed.
- When the HDMI IN input is selected with no signal applied, the blue screen is displayed regardless if [LOGO] is selected in [BACKGROUND] of the menu.

**Selecting Interval Time for Filter Message [FILTER MESSAGE]**

This option allows you to select the time preference between displaying the message for cleaning the filters. Clean the filter when you get the message “Please clean filter.” (→ page 122)

Five options are available: Off, 100[H], 200[H], 500[H], 1000[H]

The default setting is 500[H].

*NOTE: The message for filter cleaning will be displayed for one minute when the projector is turned on or off. To cancel the message, press any button on the projector cabinet or the remote control.*

*NOTE: Your setting will not be affected even when [RESET] is done from the menu.*

**Setting Closed Caption [CLOSED CAPTION]**

This option sets several closed caption modes that allow text to be superimposed on the projected image of Video or S-Video.

- OFF ..... This exits the closed caption mode.
- CAPTION 1-4 ..... Text is superimposed.
- TEXT 1-4 ..... Text is displayed in full screen.

**[INSTALLATION(1)]**

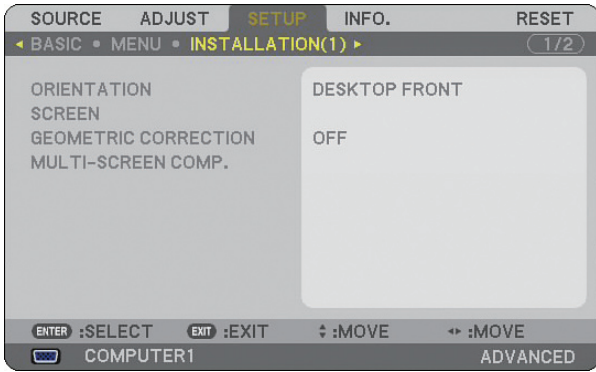

**Selecting Projector Orientation [ORIENTATION]**

This reorients your image for your type of projection. The options are: desktop front projection, ceiling rear projection, desktop rear projection, and ceiling front projection.

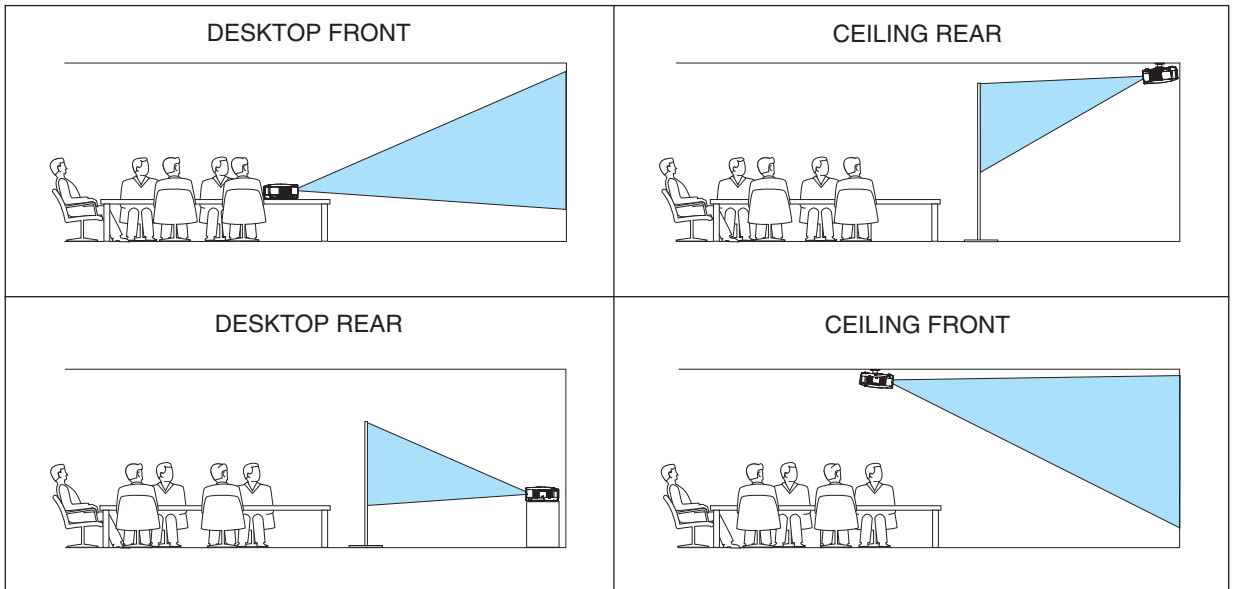

### Selecting Aspect Ratio and Position for Screen [SCREEN]

SCREEN TYPE ..... Select one of two options: 4:3 SCREEN or WIDE SCREEN for the screen to be used. See also [ASPECT RATIO].

(→ page 83)

POSITION ..... This feature allows you to adjust the vertical position of the image when WIDE SCREEN has been selected for the screen type.

(NP905 only)

When WIDE SCREEN has been selected there is no-signal area above and below the image.

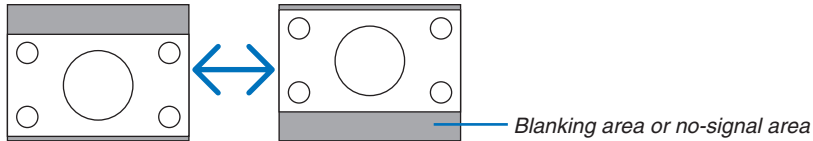

---

*NOTE: This option is available only when [WIDE SCREEN] is selected in [SCREEN TYPE].*

---

**NOTE:**

- After changing the screen type, check the setting of [ASPECT RATIO] in the menu. (→page 83)
  - NP905: [POSITION] is not available when [4:3 SCREEN] is selected for [SCREEN TYPE] or when [LETTERBOX] is selected for [ASPECT RATIO].
- 

### Using Geometric Correction [GEOMETRIC CORRECTION]

This feature retrieves geometric data registered in the projector memory.

Three presets of geometric data have been registered. To turn off this feature, select [OFF].

**NOTE:**

- The [KEystone] and [CORNERSTONE] adjustments are not available when geometric data is applied.
  - To clear your geometric data, press the 3D REFORM button for a minimum of 2 seconds.
  - The [GEOMETRIC CORRECTION] feature can cause an image to be slightly blurred because the correction is made electronically.
-

### Using Multi-Screen Compensation [MULTI-SCREEN COMP.]

This feature allows you to match images projected from multiple projectors that are placed in parallel.

MODE ..... OFF: Turns off this function to return to the normal brightness.

ON: Turns on this function to make the screen darker. The [BRIGHTNESS] and the [CONTRAST] can be adjusted.

CONTRAST ..... Adjusts the bright part of the picture.

BRIGHTNESS..... Adjusts the dark part of the picture.

### Adjusting

**1. Prepare black and white images so that the images can be displayed on the computer screen.**

**2. Display the black image on the computer screen, and project the image from the projector.**

**3. Select [MULTI-SCREEN COMP.] → [MODE] → [ON].**

**4. Adjust the dark part of the images.**

*Press the SELECT ▼ button to select [BRIGHTNESS] and use the SELECT ◀ or ▶ to match the black part of another projector.*

**5. Display the white screen on the computer screen.**

*Project the image from two or more projectors.*

**6. Adjust the bright part of the images.**

*Press the SELECT ▼ button to select [CONTRAST] and use the SELECT ◀ or ▶ to match the white part of another projector.*

*Moving the slide bar toward [+] (plus) can change the white part of the image. Should this happen, move the slide bar toward [-] (minus) to adjust the brightness.*

#### TIP:

- When you use multiple projectors, you can use the [CONTROL ID] function to operate a single projector or all the projectors from the remote control. (→ page 114)
- Your setting will not be affected even when [RESET] is done from the menu.



### [INSTALLATION(2)]

#### [NETWORK SETTINGS]

This feature allows you to set various setting items when the projector is used on your network.

##### **Important**

- Consult with your network administrator about these settings.
- The NP905/NP901W series projectors distributed in some areas and countries do not come standard with the USB Wireless LAN Unit.  
If you purchase the projector without the USB Wireless LAN Unit installed and need to present to the projector via a wireless connection, the optional USB Wireless LAN Unit must be installed.

##### **Hints on How to Set Up LAN Connection**

To configure the projector to communicate on the network using the LAN port (RJ-45) or Wireless LAN Unit:

1. **Select the [WIRED] tab for the LAN port (RJ-45) or the [WIRELESS] tab for the Wireless LAN Unit.**
2. **On the [WIRED] tab or the [WIRELESS] tab, select a number from the [PROFILES] list for your LAN settings.**  
*Two settings can be stored in memory for each the LAN port and the Wireless LAN Unit respectively.*
3. **On the [WIRED] tab or the [WIRELESS] tab, turn on or off [DHCP], specify IP address, Subnet Mask, Gateway and DNS Configuration. Select [OK] and press the ENTER button.**  
(→ page 102, 103)

To recall the settings from memory:

After selecting the [WIRED] tab or the [WIRELESS] tab, select the number from the [PROFILES] list. Select [OK] and press the ENTER button. (→ page 102, 103)

To connect a DHCP server:

On the [WIRED] tab or the [WIRELESS] tab, select [DHCP] and press the ENTER button. A check mark will be placed. Select again and press the ENTER button. The check box will be cleared.

When setting an IP address without using a DHCP server, clear the check box for [DHCP]. (→ page 102, 103)

To set only for wireless LAN (NETWORK TYPE and WEP/WPA):

1. **On the [WIRELESS] tab, select [PROFILES] and then select [PROFILE 1] or [PROFILE 2].**
2. **On the [WIRELESS] tab, select [ADVANCED] and press the ENTER button. The [ADVANCED] menu will be displayed.**  
(→ page 104, 105)

To select a wireless LAN access point:

1. **On the [WIRELESS] tab, select [PROFILES] and then select [PROFILE 1] or [PROFILE 2].**
2. **On the [WIRELESS] tab, select [ADVANCED] and press the ENTER button.**
3. **On the Advanced menu, select [CONNECTION] → [SITE SURVEY] and press the ENTER button.**
4. **Select an SSID which you can access.**

*To select an SSID, highlight [SSID] and use the SELECT ► to select [OK] and press the ENTER button. When you do not use [SITE SURVEY], simply enter an SSID and [INFRASTRUCTURE] or [AD HOC]. (→ page 104)*

To receive error messages or information on the remaining lamp life via e-mail:

1. On the [MAIL] tab, select [ALERT MAIL] and press the ENTER button. A check mark will be placed.
2. Set [SENDER'S ADDRESS], [SMTP SERVER NAME] and [RECIPIENT'S ADDRESS]. Select [OK] and press the ENTER button.

(→ page 107)

To execute [EASY CONNECTION] using Image Express Utility 2.0:

The [EASY CONNECTION] is a mode that can abbreviate the troublesome LAN settings when using the Image Express Utility 2.0 and connecting the PC and projector via a wireless LAN.

The Image Express Utility 2.0 is contained on the supplied User Supportware 5 CD-ROM. To use [EASY CONNECTION], select [WIRELESS] → [PROFILES] → [EASY CONNECTION]. (→ page 103)

*NOTE: This function can be used when Windows XP is used as the OS and when you have a "Computer Administrator" privilege. If the OS is Windows Vista, input of logon password as "Administrator" may be prompted.*

### [GENERAL]

The screenshot shows a dialog box titled "NETWORK SETTINGS" with a "GENERAL" tab selected. The dialog is divided into "WIRED LAN" and "WIRELESS LAN" sections. The "PROJECTOR NAME" is set to "NP905 Series". The "WIRED LAN" section shows IP ADDRESS: 192.168.0.10, SUBNET MASK: 255.255.255.0, GATEWAY: 192.168.0.1, and MAC ADDRESS: 00-00-10-F0-00-0A. The "WIRELESS LAN" section shows IP ADDRESS, SUBNET MASK, and GATEWAY as dashes, and MAC ADDRESS as 00-00-00-00-00-00. At the bottom, there are "OK" and "CANCEL" buttons, and a footer with navigation keys: ENTER:SELECT, EXIT:EXIT, +:MOVE, and -:MOVE.

Category	Field	Value
PROJECTOR NAME	PROJECTOR NAME	NP905 Series
	WIRED LAN	
	IP ADDRESS	192.168.0.10
	SUBNET MASK	255.255.255.0
WIRED LAN	GATEWAY	192.168.0.1
	MAC ADDRESS	00-00-10-F0-00-0A
	WIRELESS LAN	
	IP ADDRESS	-----
WIRELESS LAN	SUBNET MASK	-----
	GATEWAY	-----
	MAC ADDRESS	00-00-00-00-00-00

This page allows you to specify a unique projector name and to check the current status of the LAN settings.

### [PROJECTOR NAME]

Specify a unique projector name. Press  to display the software keyboard and type in. Up to 16 alphanumeric characters, signs and symbols can be used. After entering a name, select [OK] and press the ENTER button.

---

*NOTE: The [PROJECTOR NAME] will not be affected even when [RESET] is done from the menu.*

---

### Using Software Keyboard

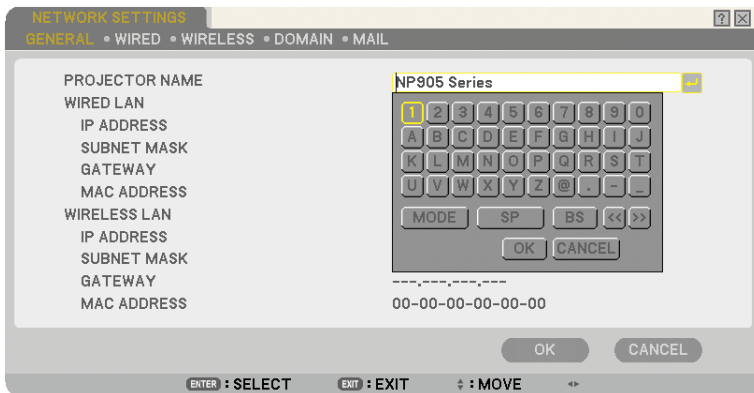

1 to 0 and

Characters ..... Use to type in password or keyword.

MODE ..... Selects one of three modes for numbers, alphabet and special characters.

SP ..... Inserts a space

BS ..... Deletes one character backward

<< ..... Returns to the previous

>> ..... Advances to the next

OK ..... Executes the selection

CANCEL ..... Cancels the selection

(→ page 71)

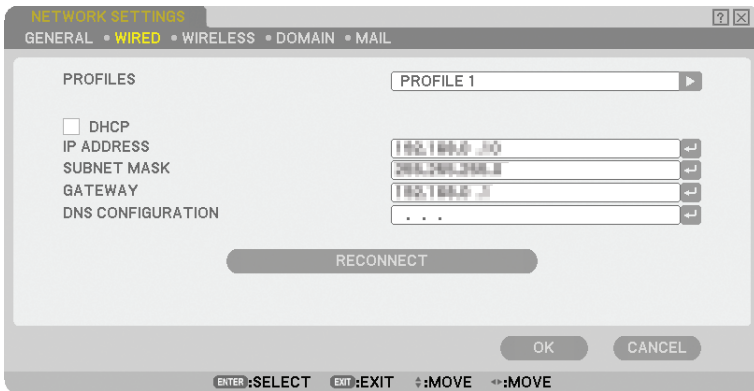
**[WIRED]**

Profiles (for LAN port [RJ-45]):

Up to two settings for the LAN port (RJ-45) can be stored in memory of the projector.

Select [PROFILE 1] or [PROFILE 2] and then do settings for [DHCP] and the other options.

After doing this, select [OK] and press the ENTER button. This will store your settings in memory.

To recall the settings from memory:

After selecting the [WIRED] tab, select the [PROFILE 1] or [PROFILE 2] from the [PROFILES] list.

Select [OK] and press the ENTER button.

**DHCP:**

Enabling this option automatically assigns an IP address to the projector from your DHCP server.

Disabling this option allows you to register the IP address or subnet mask number obtained from your network administrator.

IP ADDRESS..... Set your IP address. Press to display the software keyboard and type in 12 numeric characters.

SUBNET MASK ..... Set your subnet mask number. Press to display the software keyboard and type in 12 numeric characters.

GATEWAY ..... Set the default gateway of the network connected to the projector. Press to display the software keyboard and type in 12 numeric characters.

DNS CONFIGURATION.. Type in the IP address of DNS server on the network connected to the projector. 12 numeric characters are used.

RECONNECT ..... Use this button to retry to connect the projector to a network. Try this if you have changed [PROFILES].

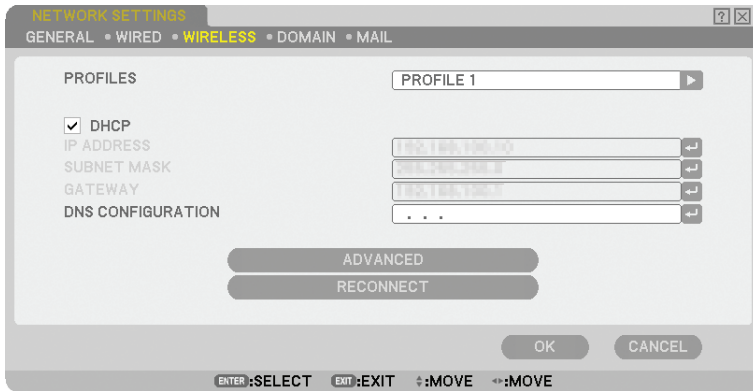
**[WIRELESS]**

PROFILES (for USB Wireless LAN unit):

To execute a wireless LAN easily using Image Express Utility 2.0, select [EASY CONNECTION].

Up to two settings for the USB wireless LAN unit can be stored in memory of the projector. Select [PROFILE 1] or [PROFILE 2] and then do settings for [DHCP] and the other options. After doing this, select [OK] and press the ENTER button. This will store your settings in memory.

To recall the settings from memory:

After selecting the [WIRELESS] tab, select the [PROFILE 1] or [PROFILE 2] from the [PROFILES] list. Select [OK] and press the ENTER button.

DHCP:

Place a check mark to automatically assign an IP address to the projector from your DHCP server.

Clear this check box to register the IP address or subnet mask number obtained from your network administrator.

IP ADDRESS..... Set your IP address. Press to display the software keyboard and type in 12 numeric characters.

SUBNET MASK ..... Set your subnet mask number. Press to display the software keyboard and type in 12 numeric characters.

GATEWAY ..... Set the default gateway of the network connected to the projector. Press to display the software keyboard and type in 12 numeric characters.

DNS CONFIGURATION.. Type in the IP address of DNS server on the network connected to the projector. 12 numeric characters are used.

ADVANCED ..... Displays the Advanced menu which includes various setting for wireless LAN connection (NETWORK TYPE and SECURITY). See the Advanced menu later on.

RECONNECT ..... Use this button to retry to connect the projector to a network. Try this if you have changed [PROFILES].

---

*NOTE: If you select [EASY CONNECTION] from [PROFILES], you cannot make settings to DHCP and its following items except [CHANNEL] in [ADVANCED].*

---

**[ADVANCED] menu**  
**[CONNECTION] (required for wireless only)**

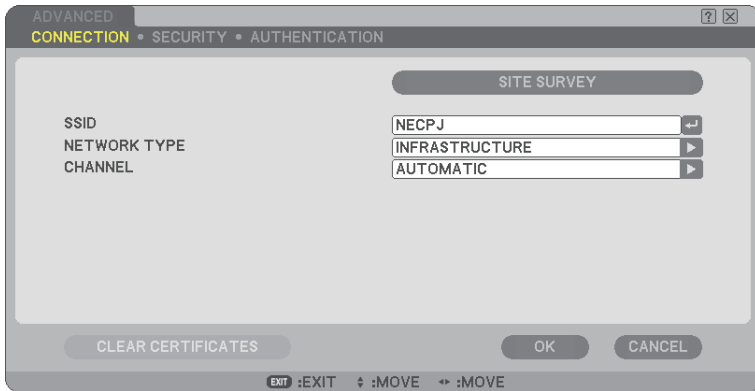

**SITE SURVEY:**

Displays a list of available SSIDs for wireless LAN on site. Select an SSID which you can access. To select an SSID, highlight [SSID] and use the SELECT ► to select [OK] and press the ENTER button.

- 📶 : Wireless access point
- 📶💻 : Ad Hoc PC
- 🔑 : WEP or WPA enabled

**SSID (Network name):**

Enter an identifier (SSID) for wireless LAN when selecting [INFRASTRUCTURE] or [AD HOC] in [NETWORK TYPE]. Communication can be done only with equipment whose SSID matches SSID for your wireless LAN. Up to 32 alphanumeric characters can be used (case sensitive).

**NETWORK TYPE:**

Select communication method when using wireless LAN.

**INFRASTRUCTURE..** Select this option when communicating with one or more equipment connected to the wireless or wired LAN network via a wireless access point.

**AD HOC .....** Select this option when using the wireless LAN to directly communicate with a computer in peer-to-peer mode. This is a method that meets the IEEE802.11 wireless standard.

---

*NOTE: When in Ad Hoc mode, only 802.11b is available for communication method.  
 Data transmission speed in Ad Hoc mode is limited up to 11Mbps.*

---

**CHANNEL:**

Select a channel. Available channels vary depending on the country and region.

**TIP:** When you select [INFRASTRUCTURE], make sure that the projector and your access point are on the same channel; when you select [AD HOC], make sure that the projector and your computer are on the same channel.

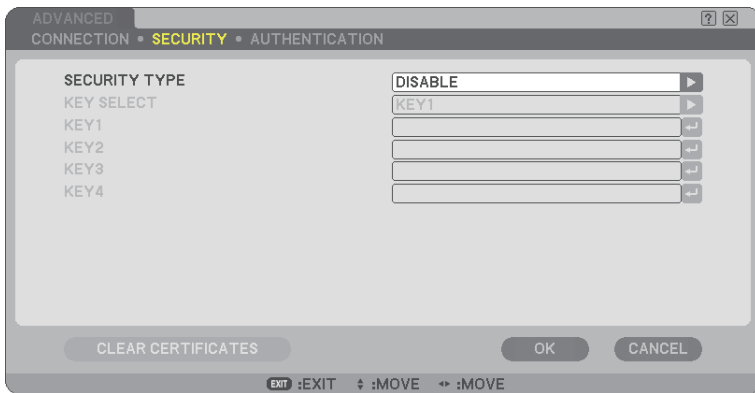
**[SECURITY] (required for wireless only)****SECURITY TYPE**

Select encryption mode for secure transmission.

When [WEP] or [DISABLE] is selected in [SECURITY TYPE]:

Select this option whether using the WEP (Wired Equivalent Privacy) key for encryption or not. To use encryption, specify WEP key.

DISABLE ..... Will not turn on the encryption feature. Your communications may be monitored by someone.

WEP(64bit) ..... Uses 64-bit datalength for secure transmission.

WEP(128bit) ..... Uses 128-bit datalength for secure transmission. This option will increase privacy and security when compared to use of 64-bit datalength encryption.

WPA-PSK, WPA-EAP, WPA2-PSK, WPA2-EAP

..... These options provide stronger security than WEP.

For setting, refer to "WPA Setting Guide" on the supplied User's Manual CD-ROM.

**NOTE:**

- The WEP settings must be the same as communication devices such as PC or access point in your wireless network.
- When you use WEP, your image transmission speed will slow down.
- [WPA-PSK], [WPA-EAP], [WPA2-PSK] and [WPA2-EAP] are not available when [AD HOC] is selected from [NETWORK TYPE].

**KEY SELECT:**

Selects one WEP key from the four keys below when selecting [64bit] or [128bit] in [SECURITY TYPE].

**KEY1-4:**

Enter encryption key when selecting [64bit] or [128bit] in [SECURITY TYPE].

Up to 5 characters can be set in 64 bit, and up to 13 characters in 128 bit.

The key can also be set in hexadecimal digit.

Press the [HEX] button to change to [ASCII] to set the key in ASCII digit. You can toggle this button between [ASCII] and [HEX].

\* Enter 0x(numeral and alphabet respectively) right in front of your key code.

\* Hexadecimal uses 0 to 9 and A to F.

\* When setting in a hexadecimal digit, up to 10 characters can be set in 64 bit, and up to 26 characters in 128 bit.

Using Software Keyboard to enter an encryption key

1. Select one of [KEY 1], [KEY 2], [KEY 3] and [KEY 4] and press the ENTER button.

The software keyboard will be displayed.



2. Use the SELECT ▲▼◀▶ button to select one key and press the ENTER button.
3. After finishing entering the WEP key, use the SELECT ▲▼◀▶ button to select [OK] and press the ENTER button.

The software keyboard will disappear.

When [WPA-PSK], [WPA-EAP], [WPA2-PSK] or [WPA2-EAP] is selected in [SECURITY TYPE]:

ENCRYPTION TYPE: Select [TKIP] or [AES].

KEY: Enter encryption key. Key length must be eight or greater and 63 or less.

**[AUTHENTICATION]** (required for wireless only)

Setting is required for using WPA-EAP or WPA2-EAP. For setting, refer to "WPA Setting Guide" on the supplied User's Manual CD-ROM.

**[DOMAIN]**

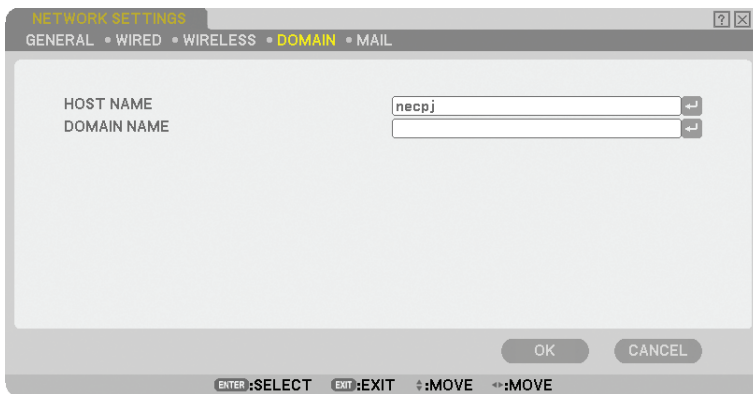

HOST NAME ..... Type in a hostname. Up to 15 alphanumeric characters can be used.

DOMAIN NAME..... Type in domain name of the network connected to the projector. Up to 60 alphanumeric characters can be used.



**[MAIL]**

NETWORK SETTINGS

GENERAL • WIRED • WIRELESS • DOMAIN • **MAIL**

ALERT MAIL

SENDER'S ADDRESS

SMTP SERVER NAME

RECIPIENT'S ADDRESS 1

RECIPIENT'S ADDRESS 2

RECIPIENT'S ADDRESS 3

TEST MAIL

OK CANCEL

ENTER:SELECT EXIT:EXIT -:MOVE <-:MOVE

**ALERT MAIL:**

Checking this box enables Alert Mail feature.

This option notifies your computer of an error message via e-mail when using wireless or wired LAN. The error message will be notified when the projector lamp has reached the end of its usable life or an error occurs in the projector.

Sample of a message sent from the projector:

*The lamp is at the end of its usable life. Please replace the lamp.*

*Projector Name: X X X X*

*Lamp Hours Used: xxxx [H]*

**SENDER'S ADDRESS:**

Specify the senders address. Use the Software keyboard. Up to 60 alphanumeric and symbols characters can be used. See "Using Software Keyboard" in Appendix for more details.

**SMTP SERVER NAME:**

Type in the SMTP server name to be connected to the projector. Up to 60 alphanumeric characters can be used.

**RECIPIENT'S ADDRESS 1 to 3:**

Type in your recipient's address. Up to 60 alphanumeric and symbols characters can be used.

**TEST MAIL:**

Send a test mail to check if your settings are correct.

**NOTE:**

- If you entered an incorrect address in a test, you may not receive an Alert mail. Should this happen, check if the Recipient's Address is correctly set.
- Unless any one of the [SENDER'S ADDRESS], [SMTP SERVER'S NAME] or [RECIPIENT'S ADDRESS 1-3] is selected, [TEST MAIL] is not available.
- Be sure to highlight [OK] and press the ENTER button before executing [TEST MAIL].

---

**NOTE:** To use the Mail Alert feature on wireless LAN connection, select [INFRASTRUCTURE] for [NETWORK TYPE].

---

### Selecting Communication Speed [COMMUNICATION SPEED]

This feature sets the baud rate of the PC Control port (D-Sub 9 Pin). It supports data rates from 4800 to 38400 bps. The default is 38400 bps. Select the appropriate baud rate for your equipment to be connected (depending on the equipment, a lower baud rate may be recommended for long cable runs).

Your selected communication speed will not be affected even when [RESET] is done from the menu.

### Setting Security [SECURITY SETTINGS]

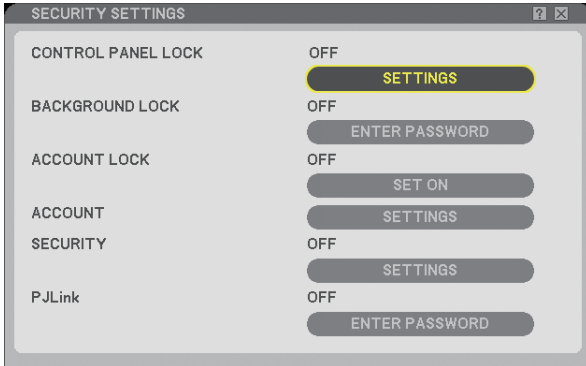

### Disabling the Cabinet Buttons [CONTROL PANEL LOCK]

This option turns on or off the Control Panel Lock function.

#### NOTE:

- This Control Panel Lock does not affect the remote control functions.
- When the control panel is locked, pressing and holding the EXIT button on the projector cabinet for about 10 seconds will change the setting to [OFF].

### Setting a Password [BACKGROUND LOCK]

A password can be set for your projector to avoid operation by an unauthorized person.

When [BACKGROUND LOCK] is set, changing the background data in the USB memory will display the Password input screen.

*NOTE: When [BACKGROUND LOCK] is turned on, [BACKGROUND] cannot be selected from the menu.*

### [ENTRY]

To assign your password:

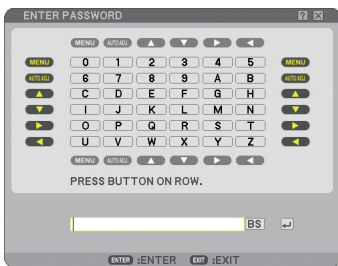

*NOTE: Up to 10 alphanumeric characters can be assigned.*

#### 1. Type a password.

Select the [ENTER PASSWORD] entry box and press the ENTER button. (→ page 71)

An asterisk will be displayed.

*The Software keyboard appears. Use the Software keyboard to type a password on the [ENTER PASSWORD] screen and press the ENTER button.*

*The [CONFIRM PASSWORD] screen will be displayed.*

- 2. Type the same password again and press the ENTER button.**  
*Your password will be assigned.*

### **[DELETE]**

To delete your password:

- 1. Select [DELETE PASSWORD] and press the ENTER button.**

- 2. Enter your password.**

*An asterisk will be displayed.*

- 3. Press the ENTER button.**

*Your password will be deleted.*

---

### **NOTE:**

- *Do not forget your password. However, if you forget your password, consult with your dealer.*
  - *The [BACKGROUND LOCK] will not be affected even when [RESET] is done from the menu.*
- 

### **ACCOUNT LOCK**

When [ACCOUNT LOCK] is set to [ON], you can set it to [OFF].

When [ACCOUNT LOCK] is set to [OFF], you can set it to [ON].

The [ACCOUNT] setting is available only when [ACCOUNT LOCK] is set to [OFF].

---

*NOTE: Do not forget your password. However, if you forget your password, use the projector's ADMINISTRATOR account to log on and set [ACCOUNT LOCK] to [OFF].*

---

### **ACCOUNT**

See page [49](#).

**[SECURITY]**

The Security function enables you to protect your projector so that the projector will not project a signal unless you enter a keyword. There is also an option to lock the projector by using a registered USB memory\* as a protect key. Once you have registered your USB memory as a protect key, you are required to insert the registered USB memory into the USB port of the projector each time you turn on the projector. You can enable the Security function by using a keyword only. (→ page 43)

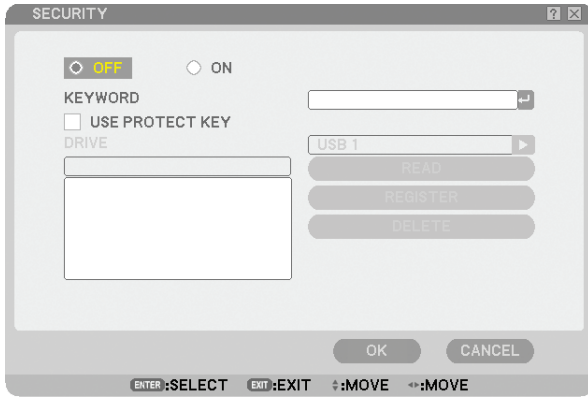

\* The projector does not support NTFS formatted USB memory device. Be sure to use a USB memory device formatted with the FAT32, FAT16 or FAT file system. To format your USB memory device in your computer, refer to the document or help file that comes with your Windows.

- ON/OFF ..... This turns the Security function on or off. This setting will take effect when the projector is turned on next time. This setting will take effect when the projector is turned on next time.
- KEYWORD ..... Enter an appropriate keyword when you use the Security function. (Up to 10 characters can be used.) The Security function is available only when your keyword is entered.
- USE PROTECT KEY.. Check this box to lock your projector when using a USB memory. To use a keyword without a USB memory, do not check this box.
- READ ..... Reads data from a USB memory.
- REGISTER..... Registers data from the USB memory. The Security function is not available unless at least one USB memory is registered. (if the [USE PROTECT KEY] check box is selected) Up to 5 USB memory devices can be registered.
- DELETE..... Deletes data of a registered USB memory.

**To set up a keyword to enable the Security function without using a registered USB memory.**

**1. Use the SELECT ▲ or ▼ button to select [KEYWORD] and use the software keyboard to enter a keyword.**

*NOTE: Please make a note of your keyword.*

**2. Use the SELECT ▲ or ▼ button to select [OFF] and then use the SELECT ◀ or ▶ to select [ON].**

**3. Use the SELECT ▲ or ▼ button to select [OK] , then press the ENTER button.**

*The [ARE YOU SURE?] message will appear.*

**4. Use the SELECT ◀ or ▶ button to select [YES] and press the ENTER button.**

The Security function takes effect.

### To register a USB memory device as a protect key.

**Preparation:** Insert the USB memory device into the USB port (type A) of the projector.

1. Use the **SELECT ▲** or **▼** button to select **[USE PROTECT KEY]** and press the **ENTER** button.
2. Use the **SELECT ▲** or **▼** button to select **[READ]** and press the **ENTER** button.  
*Data of the USB memory will be read into the projector.*
3. Use the **SELECT ▲** or **▼** button to select **[REGISTER]** and press the **ENTER** button.  
*Downloaded data will be registered and be displayed in the list window.*
4. Use the **SELECT ▲** or **▼** button to select **[KEYWORD]** and use the software keyboard to enter a keyword.

---

*NOTE: Please make a note of your keyword.*

---

5. Use the **SELECT ▲** or **▼** button to select **[OFF]** and then use the **SELECT ◀** or **▶** to select **[ON]**.
6. Use the **SELECT ▲** or **▼** button to select **[OK]**, then press the **ENTER** button.  
*The [ARE YOU SURE?] message will appear.*
7. Use the **SELECT ◀** or **▶** button to select **[YES]** and press the **ENTER** button.  
*The Security function takes effect.*

### To turn on the projector when Security is enabled (when using your keyword only).

1. Press and hold the **POWER** button for a minimum of two seconds.  
*The projector will be turned on and a message to the effect that the projector is security-protected will be displayed.*
2. Press the **MENU** button.  
*The Release Code input screen will be displayed.*
3. Enter your keyword in the Release Code input screen.  
*You can view the projected image.*

---

*NOTE: Do not forget your keyword. However, if you forget your keyword, NEC or your dealer will provide you with your Release Code. See more information at the end of this section.*

---

### To turn on the projector when Security is enabled (when using USB memory device as a protect key).

**Preparation:** Insert the registered USB memory device into the USB port (type A) of the projector.

Press and hold the **POWER** button for a minimum of two seconds.

The projector will turn on and then recognize the USB memory device. Once the image has been projected, it will stay on without the USB memory device.

- *The projector does not support NTFS formatted USB memory device.  
Be sure to use a USB memory device formatted with the FAT32, FAT16 or FAT file system.  
To format your USB memory device in your computer, refer to the document or help file that comes with your Windows.*
- *We do not warrant that the USB port of the projector will support all USB memory devices in the market.*
- *When the projector is turned on, if the registered USB memory device is not inserted into the projector, no signal will be displayed with a message to the effect that the projector is security-protected. To turn off the security protection, insert the registered USB memory device into the projector.*

- The security disable mode is maintained until the main power is turned off (by setting the main power switch to “O” or unplugging the power cord). In the following cases you will be asked to check the protect key or input the keyword:
  - (1) When [OK] is selected at an image for which security is set and the power is turned off then back on
  - (2) When the main power is turned off then back on while the security function is enabled
  - (3) When you attempt to display an image for which security is set while the security function is enabled
- Blanks (spaces) cannot be used in the Keyword section.

### To delete USB memory data you registered.

1. Use the **SELECT ▲** or **▼** button to select [DELETE] and use the **SELECT ◀** button to select the list window.
2. Use the **SELECT ▲** or **▼** button to select the information on the USB memory device you wish to delete.
3. Press the **SELECT ▶** button to select [DELETE] and press the **ENTER** button.

The information on the USB memory device will be deleted.

### If you've lost your registered USB memory, proceed as follows:

1. **Press and hold the POWER button for a minimum of two seconds.**  
*The projector will be turned on and display a message to the effect that the projector is security-protected.*
2. **Press the MENU button.**  
*The Release Code input screen will be displayed as well as your Request Code (24 alphanumeric characters).*

---

*NOTE: NEC or your dealer will provide you with your Release Code in exchange for your registered keyword and Request Code.*

---

3. **Enter your Release Code in the Release Code Input screen.**  
*The security protection will be turned off.*

---

#### **NOTE:**

- Some brands of USB memory devices cannot be used as a protect key.
  - You should register one or more USB memory devices in case your registered USB memory device is damaged or stolen. Up to 5 pieces can be registered.
  - Once the registered USB memory device has been formatted, the USB memory device cannot be recognized as your registered protect key.
- 

The Security will not be disabled by using [RESET].

### Setting a Password for PJLink [PJLink]

This option allows you to set a password when you use the PJLink feature.

Password: Enter a password (up to 32 characters)

To set and delete a password, repeat steps described in [BACKGROUND LOCK].

---

*NOTE: Do not forget your password. However, if you forget your password, consult with your dealer.*

---

*NOTE: What is PJLink?*

*PJLink is a standardization of protocol used for controlling projectors of different manufacturers. This standard protocol is established by Japan Business Machine and Information System Industries Association (JBMA) in 2005.*

*The projector supports all the commands of PJLink Class 1.*

*Setting of PJLink will not be affected even when [RESET] is done from the menu.*

---

### Selecting Power-saving in [STANDBY MODE]

The projector has two standby modes: [NORMAL] and [POWER-SAVING].

Power-saving mode is the mode that allows you to put the projector in the power-saving condition which consumes less power than the Normal mode. The projector is preset for Normal mode at the factory.

---

*NOTE:*

- *The HTTP server functions are not available during POWER-SAVING mode.*
  - *The MONITOR OUT function is not available during POWER-SAVING mode.*
  - *Control through the PC Control connector and LAN mode is not available during POWER-SAVING mode. For PC control and LAN mode of the projector it is recommended to leave the projector in the Normal mode.*
  - *When [PROGRAM TIMER] is turned on, the [STANDBY MODE] setting is ignored.*
  - *Your setting will not be affected even when [RESET] is done from the menu.*
- 

NORMAL ..... Power indicator: Orange light/Status indicator: Green light

POWER-SAVING ..... Power indicator: Orange light/Status indicator: Off

### Turning On or Off Remote Sensor [REMOTE SENSOR]

This option determines which remote sensor on the projector is enabled in wireless mode.

The options are: front/back, front, and back.

### Setting ID to the Projector [CONTROL ID]

You can operate multiple projectors separately and independently with the same single remote control. To do so, you have to assign an ID number to each projector.

CONTROL ID NUMBER..... Select a number from 1 to 254 you wish to assign to your projector.

CONTROL ID..... Select [OFF] to turn off the CONTROL ID setting and select [ON] to turn on the CONTROL ID setting.

---

*NOTE: Your setting will not be affected even when [RESET] is done from the menu.*

---

### Using the Remote Control to change IDs

#### 1. Press the ID SET button on the remote control.

The CONTROL ID screen will be displayed.



If the projector can be operated with the current remote control ID, the [ACTIVE] will be displayed. If the projector cannot be operated with the current remote control ID, the [INACTIVE] will be displayed. To operate the inactive projector, assign the ID by using the following procedure (Step 2).

#### 2. Press one of 0 to 9 buttons while pressing and holding the ID SET button on the remote control.

The range of IDs is from 1 to 254.

To clear the ID:

Press the CLEAR button while pressing the ID SET button.

---

*NOTE:*

- Setting "0 (zero)" means to clear the ID.
  - You cannot operate the projector using the remote control if the remote ID is not the same as the projector ID.
  - No ID means that all the projectors can be operated together with a single remote control. To set "No ID", enter "000" or press the CLEAR button.
- 

#### 3. Release the ID SET button.

The updated CONTROL ID screen will be displayed.

---

*NOTE: The IDs can be cleared in a few days after the batteries are run down or removed.*

---

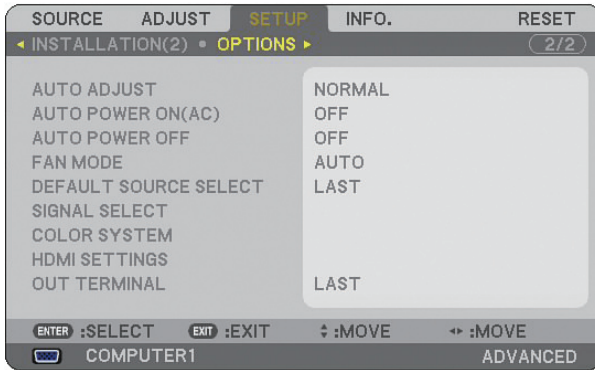

**[OPTIONS]****Setting Auto Adjust [AUTO ADJUST]**

This feature sets the Auto Adjust mode so that the RGB image can be automatically or manually adjusted for noise and stability. You can automatically make adjustment in two ways: [NORMAL] and [FINE].

- OFF ..... The RGB image will not be automatically adjusted.  
You can manually optimize the RGB image.
- NORMAL..... Default setting. The RGB image will be automatically adjusted. Normally select this option.
- FINE..... Select this option if fine adjustment is needed. It takes more time to switch to the source than when [NORMAL] is selected.

**Enabling Auto Power On [AUTO POWER ON (AC)]**

Turns the projector on automatically when the power cable is inserted into an active power outlet and the main power switch is turned on. This eliminates the need to always use the POWER button on the remote control or projector cabinet.

To use the AUTO POWER ON (AC) function, you must first press the main power switch to the position “On” before plugging in the power cable.

**Enabling Power Management [AUTO POWER OFF]**

When this option is selected you can enable the projector to automatically turn off (at the selected time: 5min., 10min., 20min., 30min.) if there is no signal received by any input.

**Enabling High Speed Fan Mode [FAN MODE]**

This option allows you to select three modes for fan speed: Auto mode, High speed mode, and High Altitude mode.

- AUTO ..... The built-in fans automatically run at a variable speed according to the internal temperature.
- HIGH..... The built-in fans run at high speed.
- HIGH ALTITUDE..... The built-in fans run at a high speed. Select this option when using the projector at altitudes approximately 5500 feet/1600 meters or higher.

When you wish to cool down the temperature inside the projector quickly, select [HIGH].

**NOTE:**

- It is recommended that you select High speed mode if you use the projector non-stop for consecutive days.
- Using the projector at altitudes approximately 5500 feet/1600 meters or higher without setting to [HIGH ALTITUDE] can cause the projector to overheat and the projector could shut down. If this happens, wait a couple minutes and turn on the projector.
- Using the projector at altitudes less than approximately 5500 feet/1600 meters and setting to [HIGH ALTITUDE] can cause the lamp to overcool, causing the image to flicker. Switch [FAN MODE] to [AUTO].
- Your setting will not be affected even when [RESET] is done from the menu.

### Selecting Default Source [DEFAULT SOURCE SELECT]

You can set the projector to default to any one of its inputs each time the projector is turned on.

- LAST..... Sets the projector to default to the previous or last active input each time the projector is turned on.
- AUTO ..... Searches for an active source in order of COMPUTER1 → COMPUTER2 → HDMI → VIDEO → S-VIDEO → VIEWER → COMPUTER1 and displays the first found source.
- COMPUTER 1 ..... Displays the RGB source from the COMPUTER 1 IN connector every time the projector is turned on.
- COMPUTER 2 ..... Displays the RGB source from the COMPUTER 2 IN connector every time the projector is turned on.
- HDMI ..... Displays the digital source from the HDMI IN connector every time the projector is turned on.
- VIDEO ..... Displays the Video source from the VIDEO IN connector every time the projector is turned on.
- S-VIDEO ..... Displays the Video source from the S-VIDEO IN connector every time the projector is turned on.
- VIEWER ..... Displays slides or plays back movie files from the USB memory device every time the projector is turned on.
- NETWORK ..... Displays a signal from LAN port (RJ-45) or the USB Wireless LAN Unit.

### Selecting Signal Format [SIGNAL SELECT]

#### COMPUTER 1/2

Allows you to set [COMPUTER 1] and [COMPUTER 2] to automatically detect an incoming RGB or component source such as a computer or DVD player. However there may be some RGB and component signals that the projector is unable to detect. In this case, select [RGB].

### Selecting [COLOR SYSTEM]

This feature enables you to select video standards manually.

Normally select [AUTO]. Select the video standard from the pulldown menu. This must be done for Video and S-Video Connectors separately.

### Setting HDMI [HDMI SETTINGS]

Make the settings for video level and audio level when connecting HDMI equipment such as a DVD player.

- VIDEO LEVEL..... Select [NORMAL] to disable the [ENHANCED] feature of your HDMI equipment. Select [ENHANCED] to improve image contrast and increase detail in the dark areas.
- AUDIO SELECT ..... Select [HDMI] to switch the HDMI IN digital audio signal and select [COMPUTER 2] to switch the COMPUTER 2 input audio signal.

### Setting MONITOR OUT Connector [OUT TERMINAL]

This option allows you to determine which RGB or component source is output from the MONITOR OUT and the AUDIO OUT connectors during Standby mode.

- LAST..... The video and audio signal from the last COMPUTER 1 or COMPUTER 2 input will be output to the MONITOR OUT connector.
- COMPUTER 1, 2 .... The video and audio signal from the COMPUTER 1 or COMPUTER 2 input will be output to the MONITOR OUT connector.

## 7 Menu Descriptions & Functions [INFO.]

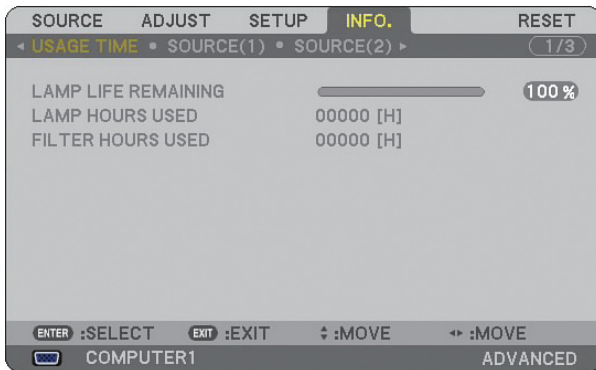

Displays the lamp usage hours, the status of the current signal and settings, NETWORK settings and version. The information included are as follows:

### [USAGE TIME]

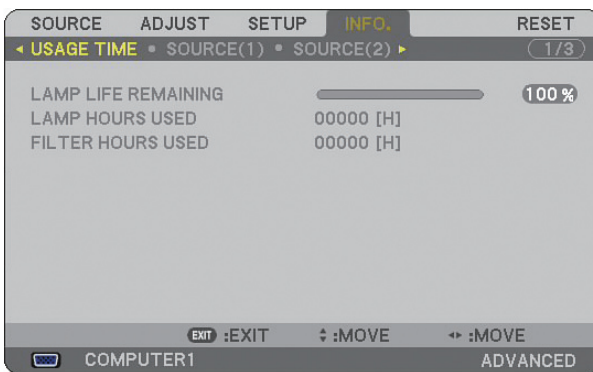

LAMP LIFE REMAINING (%)  
 LAMP HOURS USED (H)  
 FILTER HOURS USED (H)

*NOTE: The progress indicator shows the percentage of remaining lamp life. The value informs you of the amount of lamp and filter usage respectively.*

- When the remaining lamp time reaches 0, the Lamp Life Remaining bar indicator changes from 0% to 600 Hours and the countdown starts.  
 If lamp life remaining time reaches 0 hours, the projector will not turn on regardless of whether the lamp mode is set to Normal or Eco.
- The message to the effect that the lamp should be replaced will be displayed for one minute when the projector is turned on or off. To dismiss this message, press any button on the projector or the remote control.

Lamp Life

NORMAL	ECO
2500 Hours (Min.)	3500 Hours (Max.)

**[SOURCE (1)]**

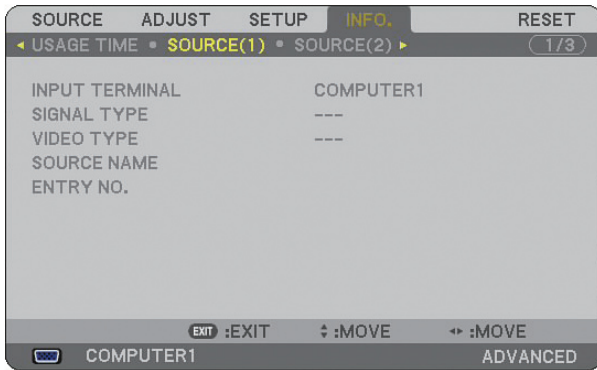

INPUT TERMINAL                      SIGNAL TYPE  
 VIDEO TYPE                              SOURCE NAME  
 ENTRY NO.

**[SOURCE (2)]**

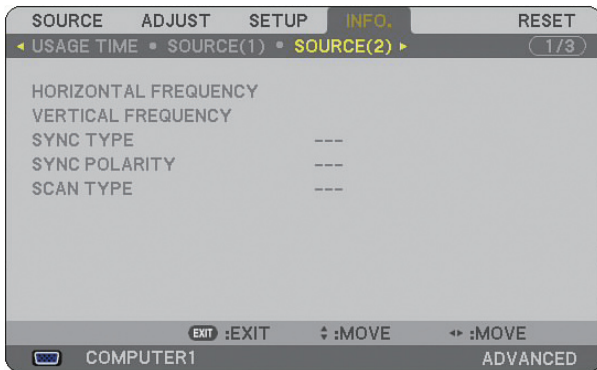

HORIZONTAL FREQUENCY      VERTICAL FREQUENCY  
 SYNC TYPE                              SYNC POLARITY  
 SCAN TYPE

**[WIRED LAN]**

This page shows information on settings for the LAN port (RJ-45)

IP ADDRESS ..... Indicates the IP address of the projector when the LAN port (RJ-45) is used.

SUBNET MASK ..... Indicates the subnet mask of the projector when the LAN port (RJ-45) is used.

GATEWAY ..... Indicates the gateway of the network connected to the projector when the LAN port (RJ-45) is used.

MAC ADDRESS..... Indicates the MAC address of the LAN port (RJ-45).

**[WIRELESS LAN (1)]**

This page shows information on settings for the USB Wireless LAN unit

IP ADDRESS .....Indicates the IP address of the projector when the USB Wireless LAN unit is used.

SUBNET MASK .....Indicates the subnet mask of the projector when the USB Wireless LAN unit is used.

GATEWAY .....Indicates the gateway of the network connected to the projector when the USB Wireless LAN unit is used.

MAC ADDRESS.....Indicates the MAC address of the USB Wireless LAN unit.

AUTHENTICATION .....Indicates the current authentication status.

**[WIRELESS LAN (2)]**

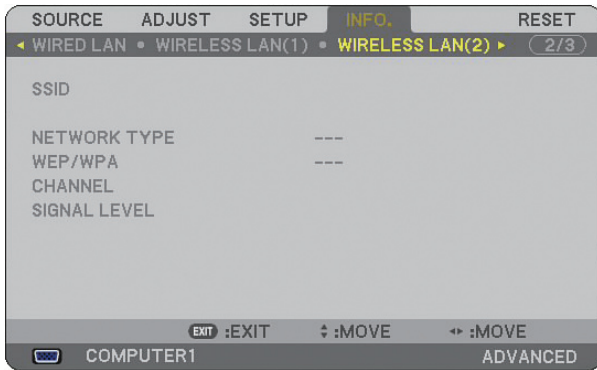

This page shows information on settings for WEP key for encryption.

SSID ..... Indicates the identifier (SSID) for your wireless LAN.

NETWORK TYPE.... Indicates that [EASY CONNECTION], [INFRASTRUCTURE] or [AD HOC] is selected for your communication method.

WEP/WPA..... Indicates your selected datalength encryption: On or Off

CHANNEL ..... Indicates the channel you selected in the [SITE SURVEY]. The channel must match for all wireless devices communicating on your wireless LAN.

SIGNAL LEVEL..... Indicates receiving condition of radio signal level while you are using a wireless LAN connection.

**[VERSION (1)]**



PRODUCT  
SERIAL NUMBER  
LAN UNIT TYPE  
LAN UNIT VERSION  
CONTROL ID

**[VERSION (2)]**



FIRMWARE  
DATA  
FIRMWARE2  
DATA2

## 8 Menu Descriptions & Functions [RESET]

### Returning to Factory Default

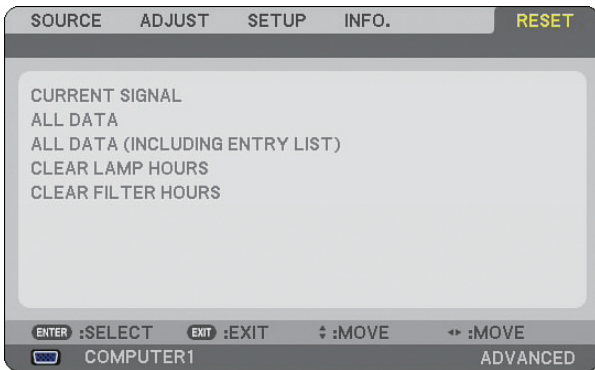

The Reset feature allows you to change adjustments and settings to the factory preset for sources by the following methods:

#### [CURRENT SIGNAL]

Resets the adjustments for the current signal to the factory preset levels.  
All the items in [ADJUST] can be reset.

#### [ALL DATA]

Reset all the adjustments and settings for all the signals to the factory preset except [ENTRY LIST], [LANGUAGE], [BACKGROUND], [FILTER MESSAGE], [MULTI-SCREEN COMP.], [SECURITY SETTINGS], [NETWORK SETTINGS], [COMMUNICATION SPEED], [STANDBY MODE], [CONTROL ID], [FAN MODE], [DATE, TIME PRESET], [LAMP LIFE REMAINING], [LAMP HOURS USED] and [FILTER HOURS USED].

#### [ALL DATA (INCLUDING ENTRY LIST)]

Reset all the adjustments and settings for all the signals to the factory preset except [LANGUAGE], [BACKGROUND], [FILTER MESSAGE], [MULTI-SCREEN COMP.], [SECURITY SETTINGS], [NETWORK SETTINGS], [COMMUNICATION SPEED], [STANDBY MODE], [CONTROL ID], [FAN MODE], [DATE, TIME PRESET], [LAMP LIFE REMAINING], [LAMP HOURS USED] and [FILTER HOURS USED].  
Also deletes all the signals in the [ENTRY LIST] and returns to the factory preset.

---

*NOTE: Locked signals in Entry List cannot be reset.*

---

#### Clearing Lamp Hour Meter [CLEAR LAMP HOURS]

Resets the lamp clock back to zero.

---

*NOTE: Elapsed time of the lamp use will not be affected even when [RESET] is done from the menu.*

---

*NOTE: The projector will turn off and go into standby mode when you continue to use the projector for another 600 hours after the lamp has reached the end of its life. In this condition you cannot clear the lamp hour meter on the menu. If this happens, press the HELP button on the remote control for 10 seconds to reset the lamp clock back to zero. Do this only after replacing the lamp.*

---

#### Resetting the Filter Usage Hours [CLEAR FILTER HOURS]

Resets the filter usage back to zero.

---

*NOTE: Elapsed time of the filter use will not be affected even when [RESET] is done from the menu.*

---

# 7. Maintenance

This section describes the simple maintenance procedures you should follow to clean the filters and replace the lamp.

## ① Cleaning or Replacing the Filter

The air-filter sponge keeps dust and dirt from getting inside the projector and should be frequently cleaned. If the filter is dirty or clogged, your projector may overheat.

---

*NOTE: The message for filter cleaning will be displayed for one minute when the projector is turned on or off.  
To cancel the message, press any button on the projector cabinet or the remote control.*

---

### CAUTION

- Turn off the projector, turn off the main power switch and unplug the projector before replacing the filter.
- Only clean the outside of the filter cover with a vacuum cleaner.
- Do not attempt to operate the projector without the filter cover.

### To clean the air-filter:

Vacuum the filter-through the filter cover.

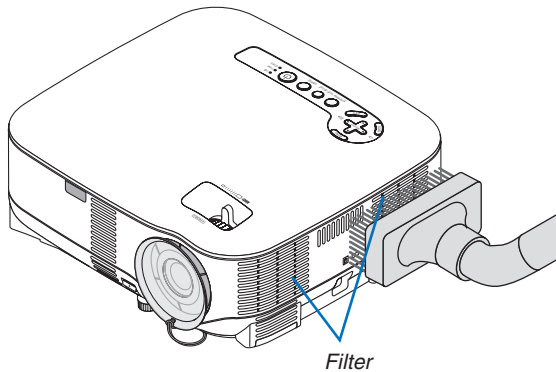

To reset the filter usage time, from the menu, select [RESET] → [CLEAR FILTER HOURS].  
(→ page 121 for resetting the filter usage time)



### To replace the filter (sponge):

#### CAUTION

- Replace both filters at the same time.
- Before replacing the filters, remove dust and dirt from the projector cabinet.
- The projector contains high-precision parts. Keep out dust and dirt during filter replacement.
- Do not wash the filter with water. Water will damage the filter membrane.
- Reattach the filter cover correctly. Failure to do so may cause projector malfunction.

**Preparation:** Replace the lamp before replacing the filters.

*NOTE: When you replace the lamp, it is also wise to replace the filter. The filter comes in the same package with your replacement lamp.*

**1. Remove the filter cover by pushing down on the catch of the cover until you feel it detach.**

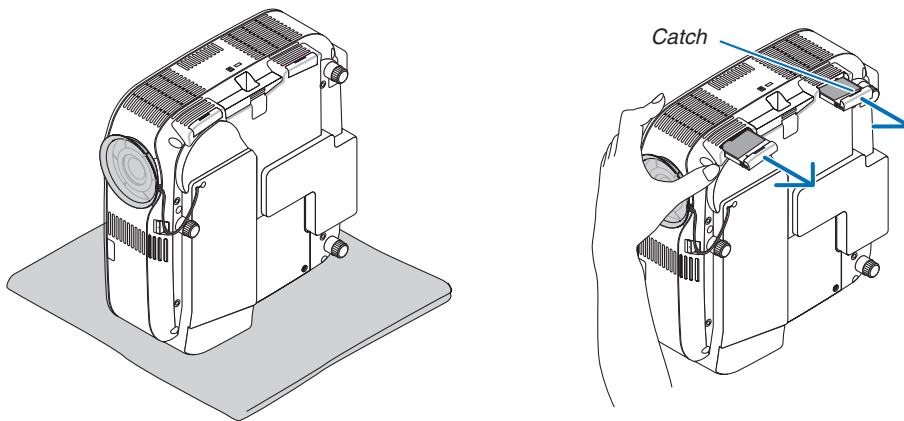

**2. Gently peel off the filter (sponge) and replace it with the new one.**

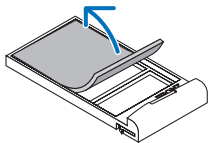

*The filter is attached with self-adhesive tape. Peel off the release paper before use.*

**3. Reinstall the new filter cover.**

- Slip the filter cover back until it snaps into place.

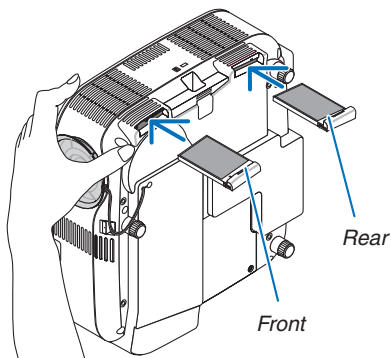

4. Connect the supplied power cable, turn on the Main Power switch and turn on the projector.
5. Finally, select the menu → [RESET] → [CLEAR FILTER HOURS] to reset the filter usage hours.  
(→ page 121 for resetting the filter usage time)

### ② Cleaning the Cabinet and the Lens

1. Turn off the projector before cleaning.
2. Clean the cabinet periodically with a damp cloth. If heavily soiled, use a mild detergent. Never use strong detergents or solvents such as alcohol or thinner.
3. Use a blower or lens paper to clean the lens, and be careful not to scratch or mar the lens.

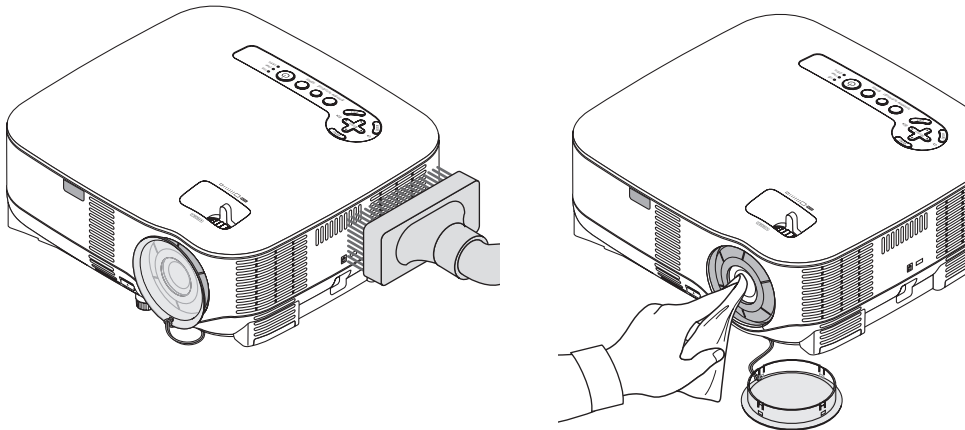

### 3 Replacing the Lamp

When the lamp reaches the end of its life, the LAMP indicator in the cabinet will blink red. Even though the lamp may still be working, replace the lamp to maintain the optimal projector performance. After replacing the lamp, be sure to clear the lamp hour meter. (→ page 121)

#### ⚠ CAUTION

- DO NOT TOUCH THE LAMP immediately after it has been used. It will be extremely hot. Turn the projector off, wait 30 seconds, turn off the main power switch and then disconnect the power cable. Allow at least one hour for the lamp to cool before handling.
- DO NOT REMOVE ANY SCREWS except one lamp cover screw and two lamp housing screws. You could receive an electric shock.
- Do not break the glass on the lamp housing.  
Keep finger prints off the glass surface on the lamp housing. Leaving finger prints on the glass surface might cause an unwanted shadow and poor picture quality.
- The projector will turn off and go into standby mode when you continue to use the projector for another 600 hours after the lamp has reached the end of its life. If this happens, be sure to replace the lamp. If you continue to use the lamp after the lamp reaches the end of its life, the lamp bulb may shatter, and pieces of glass may be scattered in the lamp case. Do not touch them as the pieces of glass may cause injury. If this happens, contact your NEC dealer for lamp replacement.

#### To replace the lamp:

Optional lamp and tools needed for replacement:

- Replacement lamp NP05LP
- Phillips screwdriver or equivalent

**1. Place the projector on a soft cloth and turn it over to access the lamp cover on the bottom.**

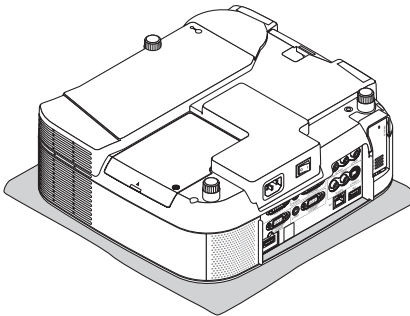

**2. Use a Phillips screwdriver to loosen the lamp cover screw and remove the lamp cover.**

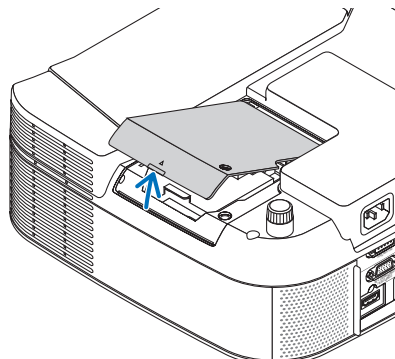
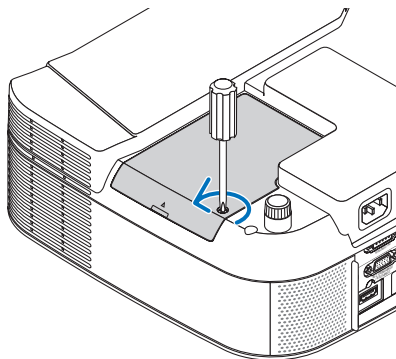

3. Loosen the two screws securing the lamp housing until the phillips screwdriver goes into a freewheeling condition. The two screws are not removable.

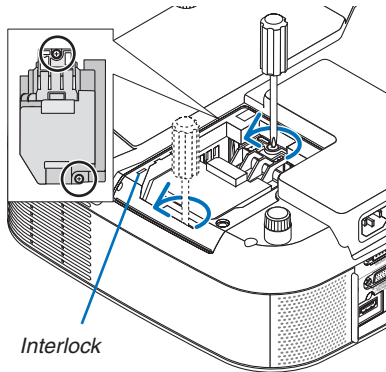

*NOTE: There is an interlock on this case to prevent the risk of electrical shock. Do not attempt to circumvent this interlock.*

4. Remove the lamp housing by holding it.  
Insert a new lamp housing until the lamp housing is plugged into the socket.

### CAUTION

Do not use a lamp other than the NEC replacement lamp NP05LP.  
Order this from your NEC dealer.

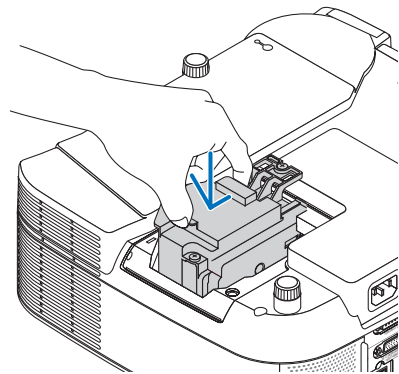
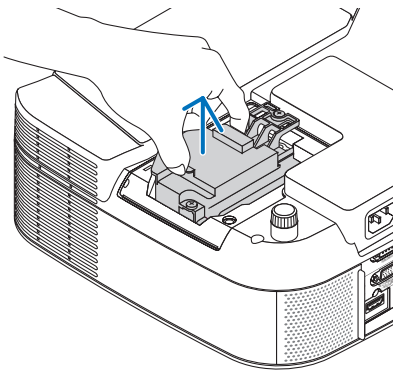

5. **Secure it in place with the two screws.**  
**Be sure to tighten the screws.**

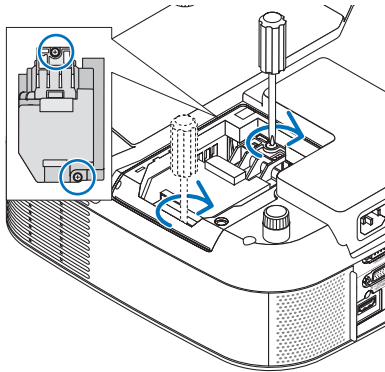

6. **Reattach the lamp cover.**  
**Slip the lamp cover back until it snaps into place.**  
**Tighten the lamp cover screw.**  
**Be sure to tighten the screw.**

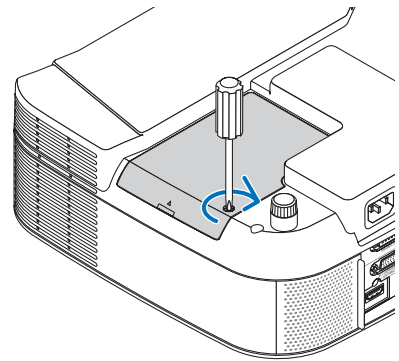
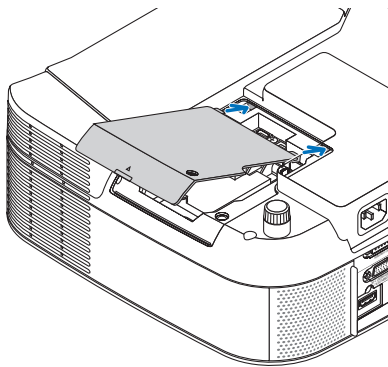

7. **Connect the supplied power cable, turn on the Main Power switch and turn on the projector.**  
8. **Finally, select the menu → [RESET] → [CLEAR LAMP HOURS] to reset the lamp life remaining and lamp usage hours.**

---

*NOTE: When you continue to use the projector for another 600 hours after the lamp has reached the end of its life, the projector cannot turn on and the menu is not displayed.*

*If this happens, press the HELP button on the remote control for 10 seconds to reset the lamp clock back to zero.*

*When the lamp time clock is reset to zero, the LAMP indicator goes out.*

---

### **Note for US Residents**

The lamp in this product contains mercury. Please dispose according to Local, State or Federal Laws.

# 8. Appendix

## 1 Troubleshooting

This section helps you resolve problems you may encounter while setting up or using the projector.

### Indicator Messages

#### Power Indicator

Indicator Condition			Projector Condition	Note
Off			The main power is off.	–
Blinking light	Green	0.5 sec On, 0.5 sec Off	The projector is getting ready to turn on.	Wait for a moment.
		2.5 sec On, 0.5 sec Off	Off Timer (Off Time) is activated.	–
	Orange	0.5 sec On, 0.5 sec Off	The projector is cooling down.	Wait for a moment.
		2.5 sec On, 0.5 sec Off	The Program Timer is activated.	–
Steady light	Green		The projector is turned on.	–
	Orange		The projector is in Standby.	–

#### Status Indicator

Indicator Condition			Projector Condition	Note
Off			Normal	–
Blinking light	Red	1 cycle (0.5 sec On, 2.5 sec Off)	Lamp cover error	Reattach the lamp cover correctly. (→ page 127)
		2 cycle (0.5 sec On, 0.5 sec Off)	Temperature error	The projector is overheated. Move the projector to a cooler location.
		4 cycle (0.5 sec On, 0.5 sec Off)	Fan error	Fans will not work correctly.
		6 cycle (0.5 sec On, 0.5 sec Off)	Lamp error	Lamp fails to light. Wait a full minute and then turn on again.
	Green		Re-firing the lamp	The projector is re-firing.
	Orange	1 cycle (0.5 sec On, 2.5 sec Off)	Network conflict	Both the built-in wired LAN and the wireless LAN cannot be connected to the same network at the same time. To use both built-in wired LAN and wireless LAN at the same time, connect them to different networks. (→ page 102, 103)
Steady light	Orange		Control Panel Lock is on	You have pressed cabinet button when Control Panel Lock is on. (→ page 108)
			CONTROL ID error	Remote control ID and projector ID are not matched.
	Green		The projector is in Standby.	–

#### Lamp Indicator

Indicator Condition			Projector Condition	Note
Off			Normal	–
Blinking light	Red		Lamp has reached its end of life. Lamp replacement message will be displayed.	Replace the lamp. (→ page 125)
Steady light	Red		Lamp has been used beyond its limit. The projector will not turn on until the lamp is replaced.	Replace the lamp. (→ page 125)
	Green		Lamp is in Eco mode	–

#### Over-Temperature Protection

If the temperature inside the projector rises too high, the over-temperature protector will automatically turn off the lamp with the STATUS indicator blinking (2-cycle On and Off.)

Should this happen, do the following:

- Unplug the power cable after the cooling fans stop.
- Move the projector to a cooler location if the room where you are presenting is particularly too warm.
- Clean the ventilation holes if they are clogged with dust.
- Wait about 60 minutes until the inside of the projector becomes cool enough.

## Common Problems &amp; Solutions (→ “Power/Status/Lamp Indicator” on page 128)

Problem	Check These Items
Does not turn on	<ul style="list-style-type: none"> <li>• Check that the power cable is plugged in and that the power button on the projector cabinet or the remote control is on. (→ page 21, 22)</li> <li>• Ensure that the lamp cover is installed correctly. (→ page 127)</li> <li>• Check to see if the projector has overheated. If there is insufficient ventilation around the projector or if the room where you are presenting is particularly warm, move the projector to a cooler location.</li> <li>• Check to see if you continue to use the projector for another 600 hours after the lamp has reached the end of its life. If so, replace the lamp. After replacing the lamp, reset the lamp hours used. (→ page 121)</li> <li>• The lamp may fail to light. Wait a full minute and then turn on the power again.</li> <li>• Set [FAN MODE] to [HIGH ALTITUDE] when using the projector at altitudes approximately 5500 feet/1600 meters or higher. Using the projector at altitudes approximately 5500 feet/1600 meters or higher without setting to [HIGH ALTITUDE] can cause the projector to overheat and the projector could shut down. If this happens, wait a couple minutes and turn on the projector. (→ page 115) Also when the lamp is turned off, the projector internal temperature is hot. If the power is turned on before the projector has cooled down, the fan will run a short time before the lamp will turn on.</li> </ul>
Will turn off	<ul style="list-style-type: none"> <li>• Ensure that the [OFF TIMER], [PROGRAM TIMER] or [AUTO POWER OFF] is off. (→ page 90, 115)</li> </ul>
No picture	<ul style="list-style-type: none"> <li>• Use the SOURCE button on the projector cabinet or the VIDEO, the S-VIDEO, the COMPUTER 1, the COMPUTER 2, the HDMI, the VIEWER or the NETWORK button on the remote control to select your source. (→ page 24)</li> <li>• Ensure your cables are connected properly.</li> <li>• Use menus to adjust the brightness and contrast. (→ page 80)</li> <li>• Check to see if the image is muted. (→ page 33)</li> <li>• Remove the lens cap.</li> <li>• Reset the settings or adjustments to factory preset levels using the Reset in the Menu. (→ page 121)</li> <li>• Enter your registered keyword if the Security function is enabled. (→ page 43)</li> <li>• Be sure to connect the projector and notebook PC while the projector is in standby mode and before turning on the power to the notebook PC. In most cases the output signal from the notebook PC is not turned on unless connected to the projector before being powered up. * If the screen goes blank while using your remote control, it may be the result of the computer's screen-saver or power management software.</li> <li>• See also the next page.</li> </ul>
Color tone or hue is unusual	<ul style="list-style-type: none"> <li>• Check if an appropriate color is selected in [WALL COLOR]. If not, select an appropriate option. (→ page 89)</li> <li>• Adjust [HUE] in [ADJUST]. (→ page 80)</li> </ul>
Image isn't square to the screen	<ul style="list-style-type: none"> <li>• Reposition the projector to improve its angle to the screen. (→ page 25)</li> <li>• Use the 3DReform function to correct the trapezoid distortion. (→ page 28)</li> </ul>
Picture is blurred	<ul style="list-style-type: none"> <li>• Adjust the focus. (→ page 26)</li> <li>• Reposition the projector to improve its angle to the screen. (→ page 25)</li> <li>• Ensure that the distance between the projector and screen is within the adjustment range of the lens. (→ page 136)</li> <li>• Condensation may form on the lens if the projector is cold, brought into a warm place and is then turned on. Should this happen, let the projector stand until there is no condensation on the lens.</li> </ul>
Flicker appears on screen	<ul style="list-style-type: none"> <li>• Set [FAN MODE] to other than [HIGH ALTITUDE] mode when using the projector at altitudes approximately 5500 feet/1600 meters or lower. Using the projector at altitudes less than approximately 5500 feet/1600 meters and setting to [HIGH ALTITUDE] can cause the lamp to overcool, causing the image to flicker. Switch [FAN MODE] to [AUTO]. (→ page 115)</li> </ul>
Image is scrolling vertically, horizontally or both	<ul style="list-style-type: none"> <li>• Use the SOURCE button on the projector cabinet or the VIDEO, the S-VIDEO, the COMPUTER 1, the COMPUTER 2, the HDMI, the VIEWER or the NETWORK button on the remote control to select your source (Video, S-Video, Computer, Component, Viewer or NETWORK). (→ page 24)</li> <li>• Adjust the computer image manually with the [CLOCK]/[PHASE] in [ADJUST] → [IMAGE OPTIONS]. (→ page 81)</li> </ul>
Remote control does not work	<ul style="list-style-type: none"> <li>• Install new batteries. (→ page 9)</li> <li>• Make sure there are no obstacles between you and the projector.</li> <li>• Stand within 22 feet (7 m) of the projector. (→ page 9)</li> <li>• Check if one or more remote sensors are enabled. Select [SETUP] → [INSTALLATION] → [REMOTE SENSOR] from the menu. (→ page 113)</li> <li>• Make sure that the remote control's ID corresponds with the projector's ID.</li> </ul>
Indicator is lit or blinking	<ul style="list-style-type: none"> <li>• See the POWER/STATUS/LAMP Indicator. (→ page 128)</li> </ul>
Vertical stripes in RGB mode	<ul style="list-style-type: none"> <li>• Press the AUTO ADJUST button on the projector cabinet or the AUTO ADJ. button on the remote control. (→ page 30)</li> <li>• Adjust the computer image manually with the [CLOCK]/[PHASE] in [ADJUST] → [IMAGE OPTIONS]. (→ page 81)</li> </ul>
USB mouse does not work	<ul style="list-style-type: none"> <li>• Make sure that your USB mouse is properly connected to the projector. (→ page 35) The projector may not support some brands of a USB mouse.</li> <li>• Some menu items cannot be operated with a USB mouse.</li> </ul>

For more information contact your dealer.

### If there is no picture, or the picture is not displayed correctly.

- Power on process for the projector and the PC.

Be sure to connect the projector and notebook PC while the projector is in standby mode and before turning on the power to the notebook PC.

In most cases the output signal from the notebook PC is not turned on unless connected to the projector before being powered up.

---

*NOTE: You can check the horizontal frequency of the current signal in the projector's menu [SOURCE(2)] under Information. If it reads "0kHz", this means there is no signal being output from the computer. See page 118 or go to next step.*

---

- Enabling the computer's external display.

Displaying an image on the notebook PC's screen does not necessarily mean it outputs a signal to the projector. When using a PC compatible laptop, a combination of function keys will enable/disable the external display. Usually, the combination of the 'Fn' key along with one of the 12 function keys gets the external display to come on or off. For example, NEC laptops use Fn + F3, while Dell laptops use Fn + F8 key combinations to toggle through external display selections.

- Non-standard signal output from the computer

If the output signal from a notebook PC is not an industry standard, the projected image may not be displayed correctly. Should this happen, deactivate the notebook PC's LCD screen when the projector display is in use. Each notebook PC has a different way of deactivate/reactivate the local LCD screens as described in the previous step. Refer to your computer's documentation for detailed information.

- Image displayed is incorrect when using a Macintosh

When using a Macintosh with the projector, set the DIP switch of the Mac adapter (not supplied with the projector) according to your resolution. After setting, restart your Macintosh for the changes to take affect.

For setting display modes other than those supported by your Macintosh and the projector, changing the DIP switch on a Mac adapter may bounce an image slightly or may display nothing. Should this happen, set the DIP switch to the 13" fixed mode and then restart your Macintosh. After that, restore the DIP switches to a displayable mode and then restart the Macintosh again.

---

*NOTE: A Video Adapter cable manufactured by Apple Inc. is needed for a PowerBook which does not have a mini D-Sub 15-pin connector.*

---

- Mirroring on a PowerBook

- \* When using the projector with a Macintosh PowerBook, output may not be set to 1024 x 768 unless "mirroring" is off on your PowerBook. Refer to owner's manual supplied with your Macintosh computer for mirroring.

- Folders or icons are hidden on the Macintosh screen

Folders or icons may not be seen on the screen. Should this happen, select [View] → [Arrange] from the Apple menu and arrange icons.



## ② Specifications

This section provides technical information about the projector's performance.

Model Number NP905/NP901W

### Optical

	NP905	NP901W
LCD Panel	0.63 inch LCD with Micro Lens Array (Aspect Ratio 4:3)	0.56 inch LCD with Micro Lens Array (Aspect Ratio 16:10)
Resolution	1024 x 768 pixels* up to UXGA with scaling technology (up to 1400 x 1050 @ 60 Hz on HDMI)	1280 x 800 pixels* up to UXGA with scaling technology (up to 1400 x 1050 @ 60 Hz on HDMI)
Lens	Manual zoom and focus: Zoom Ratio= 1-1.2 F1.70 - 2.07 f= 18.9 - 22.7 mm	Zoom Ratio= 1-1.2 F1.7 - 1.9 f= 17.7 - 21.3 mm
Lamp	210W AC (172W in ECO Mode)	
Light Output	3000 lumens (approx. 80% in ECO Mode)	2000 lumens (approx. 80% in ECO Mode)
Contrast Ratio (full white: full black)	500:1	400:1
Image Size (Diagonal)	21" - 300"/ 0.53 m - 7.62 m	20" - 300"/ 0.5 m - 7.62 m
Projection Distance	29 - 424 inches/0.73 - 10.8 m	28 - 440 inches/0.72 - 11.2 m
Projection Angle	Tele: 8.3° - 8.6°/Wide: 9.9° - 10.3°	Tele: 8.9° - 9.3°/Wide: 10.7° - 11.2°

### Electrical

Inputs	2 Analog RGB (Mini D-Sub 15P), 1 HDMI (19P), 1 S-Video (Mini DIN 4P), 1 Video (RCA), 2 Stereo Mini Audio, 2 (L/R) RCA Audio
Outputs	1 RGB (Mini D-Sub 15P), 1 Stereo Mini Audio
PC Control	1 PC Control Port (D-Sub 9P)
USB Port	1 A Type
LAN Port	RJ-45
Wireless LAN	USB
Video Compatibility	NTSC, NTSC4.43, PAL, PAL60, PAL-N, PAL-M, SECAM, DTV: 480i, 480p, 720p, 1080i (60Hz), 576i, 576p, 1080i (50Hz), 1080p (50Hz/60Hz) DVD: Progressive (50/60Hz)
Scan Rate	Horizontal: 15 kHz to 108 kHz (RGB: 24 kHz or over) Vertical: 48 Hz to 120 Hz
Video Bandwidth	RGB: 165MHz (Maximum sampling rate)
Color Reproduction	16.7 million colors simultaneously, Full color
Horizontal Resolution	NTSC / NTSC4.43 / PAL / PAL-M / PAL-N / PAL60 / Y, Cb, Cr: 540 TV lines SECAM: 300 TV lines RGB: 1024 dots (H) x 768 dots (V)
External Control	RS232, IR, LAN
Sync Compatibility	Separate Sync / Composite Sync / Sync on G
Built-in Speaker	5W (monaural)
Power Requirement	100 - 240V AC, 50/60Hz
Input Current	3.7 - 1.5A
Power Consumption	310W in Lamp NORMAL Mode/260W in Lamp ECO Mode/18W in STANDBY Mode/3W in POWER-SAVING Mode

\* Effective pixels are more than 99.99%.

**Mechanical**

Installation	Orientation: Desktop/Front, Desktop/Rear, Ceiling/Front, Ceiling/Rear	
Dimensions	12.2"(W) x 4.9"(H) x 11.4"(D) (not including protrusions)	
	310 mm (W) x 125 mm (H) x 289 mm (D) (not including protrusions)	
Weight	8.2 lbs/3.7 kg	
Environmental Considerations	Operational Temperatures :	41° to 104°F / 5° to 40°C, (Eco mode selected automatically at 95° to 104°F/35° to 40°C), 20% to 80% humidity (non-condensing) (Operational temperatures during use of USB Wireless LAN Unit: 41° to 95° F / 5° to 35°C )
	Storage Temperatures :	14° to 122°F / -10° to 50°C, 20% to 80% humidity (non-condensing)
Regulations	UL/C-UL Approved (UL 60950-1, CSA 60950-1) Meets DOC Canada Class B requirements Meets FCC Class B requirements Meets AS/NZS CISPR.22 Class B Meets EMC Directive (EN55022, EN55024, EN61000-3-2, EN61000-3-3) Meets Low Voltage Directive (EN60950-1, TÜV GS Approved) 	

For additional information visit:

US : <http://www.necdisplay.com/>

Europe : <http://www.nec-display-solutions.com/>

Global : <http://www.nec-pj.com/>

For information on our optional accessories, visit our website or see our brochure.

The specifications are subject to change without notice.

**USB Wireless LAN Unit**

For United States, Canada, and Mexico

Product Name	NP01LM3
Operating Voltage	5V (power supplied from the projector)
MAX Amps	Tx: 472 mA(Max) Rx: 300 mA(Max)
Wireless Standard	IEEE802.11a, IEEE802.11b, IEEE802.11g
Modulation Method	CCK/DQPSK/DBPSK/OFDM
LED Display (Blue)	During communication: blinking Standby: slow blinking No operation: light off

**IEEE802.11a**

Center Frequency Range/ Operating channels	5150 to 5350, 5725 to 5850 MHz 36,40,44,48,52,56,60,64,149,153,157,161,165 channels
Transmission method	OFDM method (Orthogonal Frequency Division Multiplexing method)
Data Rates	54/48/36/24/18/12/9/6 (Mbps)

**IEEE802.11b**

Center Frequency Range/ Operating channels	2412 to 2462 MHz 1 to 11 channels
Transmission method	DS-SS method (direct dispersion spectrum dispersion method)
Data Rates	11/5.5/2/1 (Mbps)

<b>IEEE802.11g</b>	
Center Frequency Range/ Operating channels	2412 to 2462 MHz 1 to 11 channels
Transmission method Data Rates	OFDM method (Orthogonal Frequency Division Multiplexing method) 54/48/36/24/18/12/9/6 (Mbps)
Interface	USB 2.0 (connected to USB wireless LAN port on the projector)
Dimensions	Width:1.1"/28 mm Height:0.43"/11 mm Length:3.03"/77 mm
Weight	0.042 lbs/19 g
Environmental Considerations	Operational Temperatures : 41° to 104°F / 5° to 40°C, 20% to 80% humidity (non-condensing) Storage Temperatures : 14° to 122°F (-10° to 50°C), 20% to 80% humidity (non-condensing)
For other countries except United States, Canada and Mexico	
Product Name	NP01LM2
Operating Voltage	5V (power supplied from the projector)
MAX Amps	Tx: 472 mA(Max) Rx: 300 mA(Max)
Wireless Standard	IEEE802.11a, IEEE802.11b, IEEE802.11g
Modulation Method	CCK/DQPSK/DBPSK/OFDM
LED Display (Blue)	During communication: blinking Standby: slow blinking No operation: light off
<b>IEEE802.11a</b>	
Center Frequency Range/ Operating channels	5150 to 5250, 5250 to 5350, 5470 to 5725 MHz 36, 40, 44, 48, 52, 56, 60, 64, 100, 104, 108, 112, 116, 120, 124, 128, 132, 136, 140 channels
Transmission method Data Rates	OFDM method (Orthogonal Frequency Division Multiplexing method) 54/48/36/24/18/12/9/6 (Mbps)
<b>IEEE802.11b</b>	
Center Frequency Range/ Operating channels	2412 to 2472 MHz 1 to 13 channels
Transmission method Data Rates	DS-SS method (direct dispersion spectrum dispersion method) 11/5.5/2/1 (Mbps)
<b>IEEE802.11g</b>	
Center Frequency Range/ Operating channels	2412 to 2472 MHz 1 to 13 channels
Transmission method Data Rates	OFDM method (Orthogonal Frequency Division Multiplexing method) 54/48/36/24/18/12/9/6 (Mbps)
Interface	USB 2.0 (connected to USB wireless LAN port on the projector)
Dimensions	Width:1.1"/28 mm Height:0.43"/11 mm Length:3.03"/77 mm
Weight	0.042 lbs/19 g
Environmental Considerations	Operational Temperatures : 41° to 104°F / 5° to 40°C, 20% to 80% humidity (non-condensing) Storage Temperatures : 14° to 122°F (-10° to 50°C), 20% to 80% humidity (non-condensing)

Operation of the USB Wireless LAN Unit is subjected to the regulations of the countries listed below, and may be prohibited to use outside the country where you purchased. If you need to use the projector outside the country where you purchased, you must remove the USB Wireless LAN Unit from the projector.

Product Name	Supported countries and areas
NP01LM2	Austria / Belgium / Bulgaria / Cyprus / Czech / Denmark / Estonia / Finland / France / Germany / Greece / Hungary / Iceland / Ireland / Italy / Latvia / Liechtenstein / Lithuania / Luxembourg / Malta / Norway / Poland / Portugal / Romania / Slovak / Slovenia / Spain / Sweden / Switzerland / The Netherlands / United Kingdom
NP01LM3	Canada / Mexico / United States

- Certificate marks and codes of the NP01LM Series (English)
- Zertifizierungen und Codes der NP01LM-Serien (German)
- Certifications et codes des séries NP01LM (French)
- Marchi certificati e codici della Serie NP01LM (Italian)
- Marcas y códigos certificados de la serie NP01LM (Spanish)
- Marcas e códigos certificados da Série NP01LM (Portuguese)
- Certifierade märken och koder för NP01LM serie (Swedish)
- Обозначения сертификатов и коды серии NP01LM (Russian)
- NP01LM 시리즈의 인증서 표시 및 코드 (Korean)

NP01LM2	
NP01LM3	Mexico CFT ID: RCPNENP07-1083

Finnish	NEC Display Solutions, Ltd. vakuuttaa täten että USB Wireless LAN Unit (Model: NP01LM) tyyppinen laite on direktiivin 1999/5/EY oleellisten vaatimusten ja sitä koskevien direktiivin muiden ehtojen mukainen.
Portuguese	NEC Display Solutions, Ltd. declara que este USB Wireless Unit (Model: NP01LM) está conforme com os requisitos essenciais e outras disposições da Directiva 1999/5/CE.
Dutch	Hierbij verklaart NEC Display Solutions, Ltd. dat het toestel USB Wireless LAN Unit (Model: NP01LM) in overeenstemming is met de essentiële eisen en de andere relevante bepalingen van richtlijn 1999/5/EG. Bij deze verklaart NEC Display Solutions, Ltd. dat deze USB Wireless LAN Unit (Model: NP01LM) voldoet aan de essentiële eisen en aan de overige relevante bepalingen van Richtlijn 1999/5/EC.
Danish	Undertegnede NEC Display Solutions, Ltd. erklærer herved, at følgende udstyr USB Wireless LAN Unit (Model: NP01LM) overholder de væsentlige krav og øvrige relevante krav i direktiv 1999/5/EF.
Greek	ΜΕ ΤΗΝ ΠΑΡΟΥΣΑ NEC Display Solutions, Ltd. ΔΗΛΩΝΕΙ ΟΤΙ USB Wireless LAN Unit (Model: NP01LM) ΣΥΜΜΟΡΦΩΝΕΤΑΙ ΠΡΟΣ ΤΙΣ ΟΥΣΙΩΔΕΙΣ ΑΠΑΙΤΗΣΕΙΣ ΚΑΙ ΤΙΣ ΛΟΙΠΕΣ ΣΧΕΤΙΚΕΣ ΔΙΑΤΑΞΕΙΣ ΕΙΣ ΤΗΣ ΟΔΗΓΙΑΣ 1999/5/ΕΚ.

### 3 Cabinet Dimensions

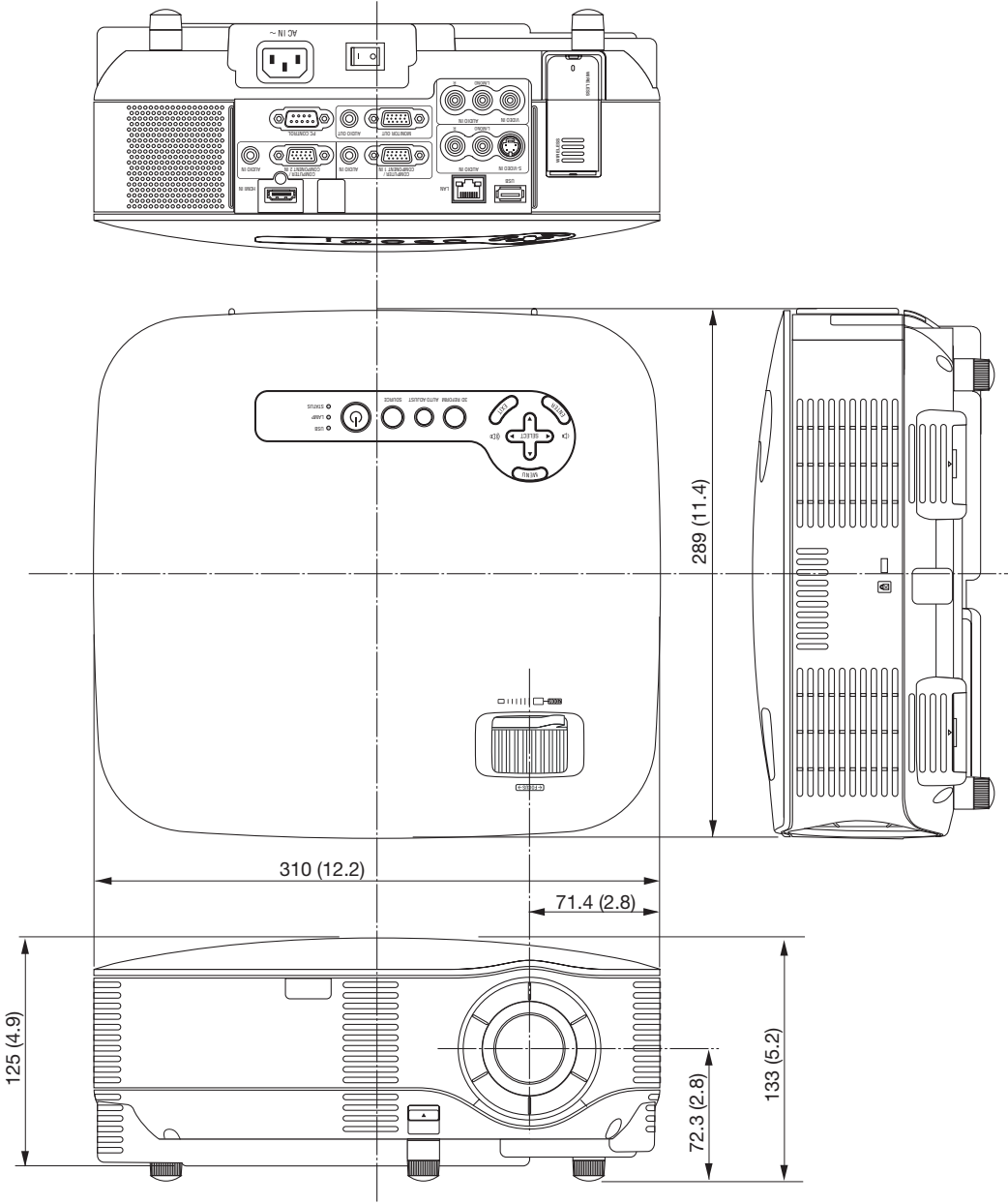

Unit: mm (inch)

## 4 Screen Size and Projection Distance

### Throw Distance and Screen Size (NP905/NP901W)

The following shows the proper relative positions of the projector and screen. Refer to the table to determine the position of installation.

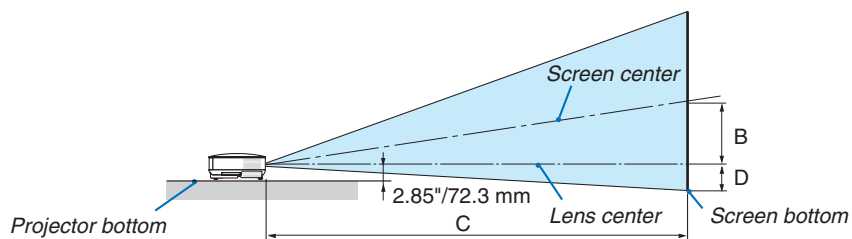

#### Distance Chart

B = Vertical distance between lens center and screen center

C = Throw distance

D = Vertical distance between lens center and screen bottom (top of screen for ceiling application)

$\alpha$  = Throw angle

*NOTE: The values in the tables are design values and may vary.*

#### NP905

Screen Size			B	C		D	a	
Diagonal	Width	Height		Wide – Tele			Wide – Tele	
inch	inch	inch	inch	inch	inch	inch	degree	
21	17	13	4	-- 29	-2	-- 8.6		
25	20	15	5	28 – 34	-2	10.3 – 8.6		
30	24	18	6	34 – 41	-3	10.2 – 8.5		
40	32	24	8	46 – 56	-4	10.1 – 8.4		
60	48	36	12	70 – 84	-6	10.1 – 8.4		
72	58	43	15	84 – 101	-7	10.0 – 8.4		
80	64	48	17	93 – 112	-8	10.0 – 8.4		
84	67	50	17	98 – 118	-8	10.0 – 8.4		
90	72	54	19	105 – 126	-8	10.0 – 8.4		
100	80	60	21	117 – 141	-9	10.0 – 8.3		
120	96	72	25	141 – 169	-11	10.0 – 8.3		
150	120	90	31	176 – 211	-14	10.0 – 8.3		
180	144	108	37	211 – 254	-17	10.0 – 8.3		
200	160	120	41	235 – 282	-19	10.0 – 8.3		
210	168	126	43	247 – 296	-20	10.0 – 8.3		
240	192	144	50	282 – 339	-23	9.9 – 8.3		
270	216	162	56	318 – 381	-25	9.9 – 8.3		
300	240	180	62	353 – 424	-28	9.9 – 8.3		

Screen Size			B	C		D	a	
Diagonal	Width	Height		Wide – Tele			Wide – Tele	
mm	mm	mm	mm	mm	mm	mm	degree	
533	427	320	110	-- 730	-50	-- 8.6		
635	508	381	130	720 – 870	-60	10.3 – 8.6		
762	610	457	160	870 – 1050	-70	10.2 – 8.5		
1016	813	610	210	1170 – 1410	-100	10.1 – 8.4		
1524	1219	914	310	1770 – 2130	-140	10.1 – 8.4		
1829	1463	1097	380	2130 – 2560	-170	10.0 – 8.4		
2032	1626	1219	420	2370 – 2850	-190	10.0 – 8.4		
2134	1707	1280	440	2490 – 2990	-200	10.0 – 8.4		
2286	1829	1372	470	2670 – 3210	-210	10.0 – 8.4		
2540	2032	1524	520	2970 – 3570	-240	10.0 – 8.3		
3048	2438	1829	630	3570 – 4290	-290	10.0 – 8.3		
3810	3048	2286	790	4470 – 5370	-360	10.0 – 8.3		
4572	3658	2743	940	5370 – 6450	-430	10.0 – 8.3		
5080	4064	3048	1050	5970 – 7170	-480	10.0 – 8.3		
5334	4267	3200	1100	6270 – 7530	-500	10.0 – 8.3		
6096	4877	3658	1260	7170 – 8610	-570	9.9 – 8.3		
6858	5486	4115	1410	8070 – 9690	-640	9.9 – 8.3		
7620	6096	4572	1570	8970 – 10770	-710	9.9 – 8.3		

#### NP901W

Screen Size			B	C		D	a	
Diagonal	Width	Height		Wide – Tele			Wide – Tele	
inch	inch	inch	inch	inch	inch	inch	degree	
20	17	11	5	23 – 28	-1	11.2 – 9.3		
25	21	13	6	29 – 36	-1	11.1 – 9.2		
30	25	16	7	36 – 43	-1	11.0 – 9.2		
40	34	21	9	48 – 58	-1	10.9 – 9.1		
56	47	30	13	67 – 81	-2	10.8 – 9.0		
60	51	32	14	72 – 87	-2	10.8 – 9.0		
70	59	37	16	85 – 102	-2	10.8 – 9.0		
80	68	42	18	97 – 116	-3	10.8 – 9.0		
90	76	48	21	109 – 131	-3	10.8 – 9.0		
100	85	53	23	121 – 146	-3	10.7 – 9.0		
120	102	64	28	146 – 175	-4	10.7 – 9.0		
150	127	79	35	183 – 219	-5	10.7 – 8.9		
180	153	95	41	219 – 263	-6	10.7 – 8.9		
200	170	106	46	244 – 293	-7	10.7 – 8.9		
210	178	111	48	256 – 308	-7	10.7 – 8.9		
240	204	127	55	293 – 352	-8	10.7 – 8.9		
270	229	143	62	330 – 396	-9	10.7 – 8.9		
300	254	159	69	366 – 440	-10	10.7 – 8.9		

Screen Size			B	C		D	a	
Diagonal	Width	Height		Wide – Tele			Wide – Tele	
mm	mm	mm	mm	mm	mm	mm	degree	
508	431	269	120	590 – 720	-20	11.2 – 9.3		
635	538	337	150	750 – 900	-20	11.1 – 9.2		
762	646	404	180	900 – 1090	-30	11.0 – 9.2		
1016	862	538	230	1210 – 1460	-40	10.9 – 9.1		
1422	1206	754	330	1710 – 2060	-50	10.8 – 9.0		
1524	1292	808	350	1840 – 2210	-50	10.8 – 9.0		
1778	1508	942	410	2150 – 2580	-60	10.8 – 9.0		
2032	1723	1077	470	2460 – 2960	-70	10.8 – 9.0		
2286	1939	1212	530	2770 – 3330	-80	10.8 – 9.0		
2540	2154	1346	580	3080 – 3700	-90	10.7 – 9.0		
3048	2585	1615	700	3700 – 4450	-110	10.7 – 9.0		
3810	3231	2019	880	4640 – 5570	-130	10.7 – 8.9		
4572	3877	2423	1050	5570 – 6690	-160	10.7 – 8.9		
5080	4308	2692	1170	6190 – 7440	-180	10.7 – 8.9		
5334	4523	2827	1230	6500 – 7810	-190	10.7 – 8.9		
6096	5169	3231	1400	7440 – 8930	-210	10.7 – 8.9		
6858	5816	3635	1580	8370 – 10050	-240	10.7 – 8.9		
7620	6462	4039	1750	9310 – 11180	-270	10.7 – 8.9		

NP905

This section should be used when considering the distance to the screen and the screen size.

Available projection distances are 0.73 m/29 inches for 21" screen to 10.8 m/424 inches for 300" screen, according to the chart.

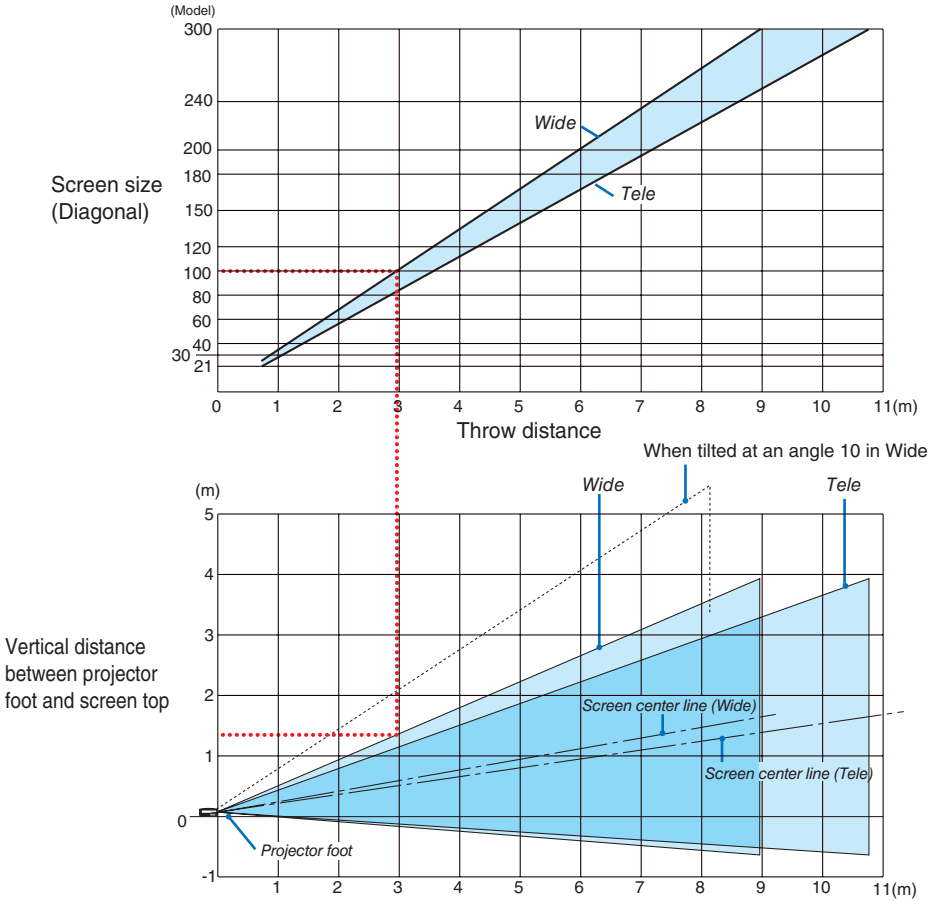

Using the Chart

Example for 100" screen:

The projection distance is approximately 3.0 m (120") according to the upper chart.

The lower chart shows that the vertical distance between the projector foot and the screen top is approximately 1.35 m (53"). The projection angle can be adjusted up to 10°. (The lower chart shows that the projector is placed in a horizontal position)

**NP901W**

This section should be used when considering the distance to the screen and the screen size.

Available projection distances are 0.72 m/28 inches for 20" screen to 11.2 m/440 inches for 300" screen, according to the chart.

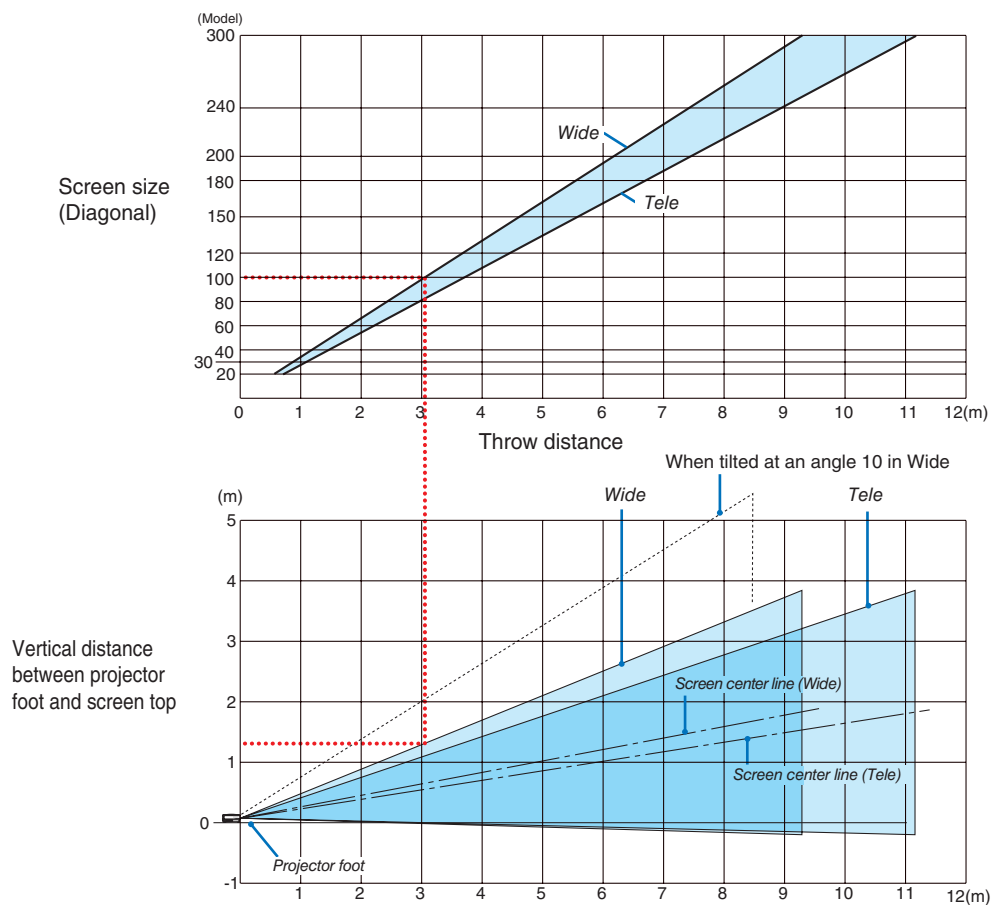
**Using the Chart**

Example for 100" screen:

The projection distance is approximately 3.0 m (120") according to the upper chart.

The lower chart shows that the vertical distance between the projector foot and the screen top is approximately 1.3 m (52"). The projection angle can be adjusted up to 10°. (The lower chart shows that the projector is placed in a horizontal position)



## ⑤ Pin Assignments of D-Sub COMPUTER 1/2 Input Connector

### Mini D-Sub 15 Pin Connector

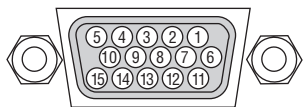

Signal Level  
 Video signal : 0.7Vp-p (Analog)  
 Sync signal : TTL level

Pin No.	RGB Signal (Analog)	YCbCr Signal
1	Red	Cr
2	Green or Sync on Green	Y
3	Blue	Cb
4	Ground	
5	Ground	
6	Red Ground	Cr Ground
7	Green Ground	Y Ground
8	Blue Ground	Cb Ground
9	No Connection	
10	Sync Signal Ground	
11	No Connection	
12	Bi-directional DATA (SDA)	
13	Horizontal Sync or Composite Sync	
14	Vertical Sync	
15	Data Clock	

## ⑥ Compatible Input Signal List

Signal	Resolution ( Dots )	Frequency H. ( kHz )	Refresh Rate ( Hz )
NTSC	–	15.73	60.00
PAL	–	15.63	50.00
PAL60	–	15.73	60.00
SECAM	–	15.63	50.00
D VESA	640 × 480	31.47	59.94
D IBM	640 × 480	31.48	59.95
D MAC	640 × 480	35.00	66.67
D VESA	640 × 480	37.86	72.81
D VESA	640 × 480	37.50	75.00
D IBM	640 × 480	39.38	75.00
D VESA	640 × 480	43.27	85.01
D VESA	800 × 600	35.16	56.25
D VESA	800 × 600	37.88	60.32
D VESA	800 × 600	48.08	72.19
D VESA	800 × 600	46.88	75.00
D VESA	800 × 600	53.67	85.06
D MAC	832 × 624	49.72	74.55
D VESA	1024 × 768	48.36	60.00
D VESA	1024 × 768	56.48	70.07
D MAC	1024 × 768	60.24	74.93
D VESA	1024 × 768	60.02	75.03
D VESA	1024 × 768	68.68	85.00
D VESA	1152 × 864	67.50	75.00
D SUN	1152 × 900	61.80	65.95
D VESA	1280 × 960	60.00	60.00
D VESA	1280 × 1024	63.98	60.02
MAC	1280 × 1024	69.87	65.18
D SXGA+	1400 × 1050	–	60.00
VESA	1600 × 1200	75.00	60.00
VESA	1600 × 1200	81.25	65.00
VESA	1600 × 1200	87.50	70.00
VESA	1600 × 1200	93.75	75.00
D HDTV (1080p)	1920 × 1080	67.50	60.00 Progressive
D HDTV (1080p)	1920 × 1080	56.25	50.00 Progressive
D HDTV (1080i)(1125i)	1920 × 1080	33.75	60.00 Interlace
D HDTV (1080i)(1125i)	1920 × 1080	28.13	50.00 Interlace
D HDTV (720p)(750p)	1280 × 720	45.00	60.00 Progressive
D HDTV (720p)	1280 × 720	37.50	50.00 Progressive
D SDTV(576p)(625p)	–	31.25	50.00 Progressive
D SDTV (480p)(525p)	–	31.47	59.94 Progressive
DVD YCbCr	–	15.73	59.94 Interlaced
DVD YCbCr	–	15.63	50.00 Interlaced

D: Images above flagged with “D” are supported by digital signal.

### NOTE:

- An image with higher or lower resolution than the projector's native resolution (NP905: 1024 x 768 / NP901W: 1280 x 800) will be displayed with scaling technology.
- Some composite sync signals may not be displayed correctly.  
Signals other than those specified in the table above may not be displayed correctly. If this should happen, change the refresh rate or resolution on your PC. Refer to Display Properties help section of your PC for procedures.

## 7 PC Control Codes and Cable Connection

### PC Control Codes

Function	Code Data											
POWER ON	02H	00H	00H	00H	00H	02H						
POWER OFF	02H	01H	00H	00H	00H	03H						
INPUT SELECT COMPUTER 1	02H	03H	00H	00H	02H	01H	01H	09H				
INPUT SELECT COMPUTER 2	02H	03H	00H	00H	02H	01H	02H	0AH				
INPUT SELECT HDMI	02H	03H	00H	00H	02H	01H	1AH	22H				
INPUT SELECT VIDEO	02H	03H	00H	00H	02H	01H	06H	0EH				
INPUT SELECT S-VIDEO	02H	03H	00H	00H	02H	01H	0BH	13H				
INPUT SELECT VIEWER	02H	03H	00H	00H	02H	01H	1FH	27H				
PICTURE MUTE ON	02H	10H	00H	00H	00H	12H						
PICTURE MUTE OFF	02H	11H	00H	00H	00H	13H						
SOUND MUTE ON	02H	12H	00H	00H	00H	14H						
SOUND MUTE OFF	02H	13H	00H	00H	00H	15H						
ON SCREEN MUTE ON	02H	14H	00H	00H	00H	16H						
ON SCREEN MUTE OFF	02H	15H	00H	00H	00H	17H						
ASPECT RATIO (4:3 Screen)												
4:3	03H	10H	00H	00H	05H	18H	00H	00H	00H	00H	30H	
LETTERBOX	03H	10H	00H	00H	05H	18H	00H	00H	01H	00H	31H	
WIDESCREEN	03H	10H	00H	00H	05H	18H	00H	00H	02H	00H	32H	
ZOOM	03H	10H	00H	00H	05H	18H	00H	00H	03H	00H	33H	
ASPECT RATIO (16:9 Screen)												
4:3 WINDOW	03H	10H	00H	00H	05H	18H	00H	00H	00H	00H	30H	
LETTERBOX	03H	10H	00H	00H	05H	18H	00H	00H	01H	00H	31H	
WIDESCREEN	03H	10H	00H	00H	05H	18H	00H	00H	02H	00H	32H	
4:3 FILL	03H	10H	00H	00H	05H	18H	00H	00H	04H	00H	34H	
ASPECT RATIO (RGB)												
4:3	03H	10H	00H	00H	05H	18H	00H	00H	00H	00H	30H	
16:9	03H	10H	00H	00H	05H	18H	00H	00H	02H	00H	32H	
5:4	03H	10H	00H	00H	05H	18H	00H	00H	0BH	00H	3BH	
16:10	03H	10H	00H	00H	05H	18H	00H	00H	0CH	00H	3CH	
15:9	03H	10H	00H	00H	05H	18H	00H	00H	0DH	00H	3DH	
AUTO ADJUST	02H	0FH	00H	00H	02H	05H	00H	18H				

*NOTE: Contact your local dealer for a full list of PC Control Codes if needed.*

## Cable Connection

### Communication Protocol

Baud rate.....	38400 bps
Data length.....	8 bits
Parity.....	No parity
Stop bit .....	One bit
X on/off .....	None
Communications procedure .....	Full duplex

---

*NOTE: Depending on the equipment, a lower baud rate may be recommended for long cable runs.*

---

## PC Control Connector (D-SUB 9P)

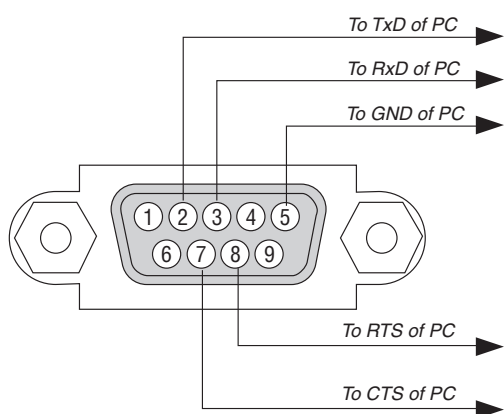

---

*NOTE 1: Pins 1, 4, 6 and 9 are no used.*

---

*NOTE 2: Jumper "Request to Send" and "Clear to Send" together on both ends of the cable to simplify cable connection.*

---

*NOTE 3: For long cable runs it is recommended to set communication speed within projector menus to 9600 bps.*

---

## 8 Removing and Attaching the USB Wireless LAN Unit

Insert the optional USB Wireless LAN Unit into the USB Wireless LAN Unit port on the rear panel of the projector.

### Important

- Do not insert other USB devices into the USB Wireless LAN unit port.
- Do not insert the USB Wireless LAN unit into the USB port (Type A).
- The USB Wireless LAN Unit must be inserted into the USB Wireless LAN Unit port in the correct direction. It cannot be inserted in the reverse direction. If the USB Wireless LAN Unit is inserted in the reverse direction with excessive force applied, the USB port may break.
- Before touching the USB Wireless LAN Unit, touch a metallic object (such as a door knob or aluminum window frame) to discharge the static electricity from your body.
- Always insert or remove the USB Wireless LAN unit when the main power is turned off. Failure to do so may cause projector malfunction or damage to the USB wireless LAN unit. If the projector will not work correctly, turn off the projector, wait 30 seconds, and turn it back on.
- The blue LED on the Wireless LAN Unit flashes to show that Wireless LAN Unit is working.
- If the Wireless LAN Unit is attached incorrectly, the blue LED will not light.

### Removing the USB Wireless LAN Unit

1. Press **POWER** button to set the projector to **Stand-by mode**, then press the “O (off)” side of the main power switch of the projector.

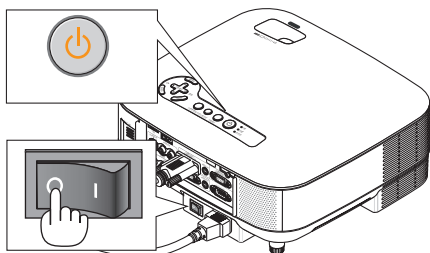

2. Place the projector on a soft cloth and turn over the projector.

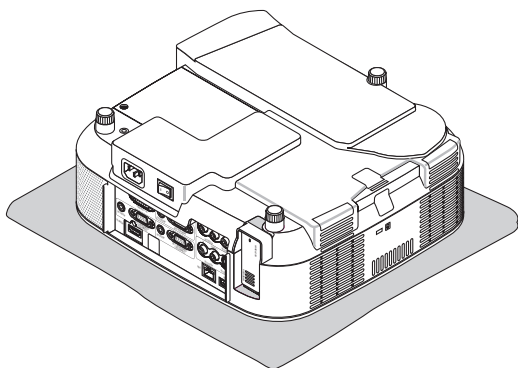

3. Loosen the holder screw and then remove the screw and the holder.

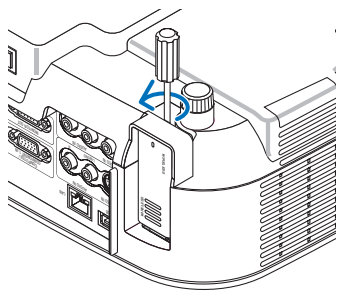

4. Slowly pull out the USB Wireless LAN Unit or dummy case.

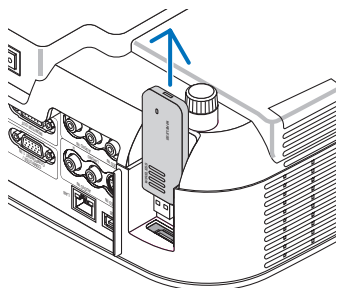

5. Reattach the holder if you do not use the USB Wireless LAN Unit.

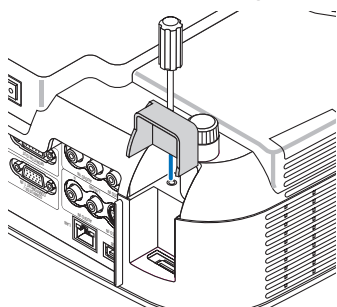

### Inserting the USB Wireless LAN Unit

1. Press POWER button to set the projector to Stand-by mode, then press the "O (off)" side of the main power switch of the projector.

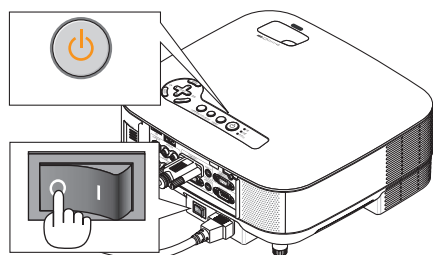

2. Place the projector on a soft cloth and turn over the projector.

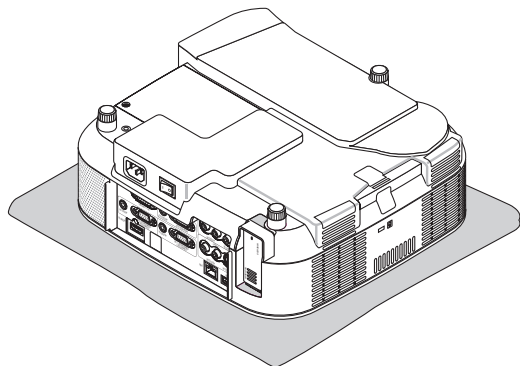

3. Loosen the holder screw and then remove the screw and the holder.

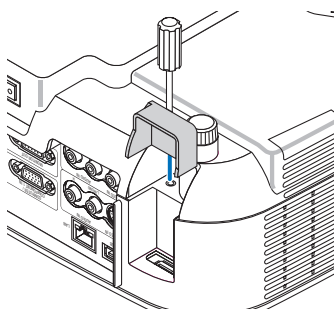

4. Insert the USB Wireless LAN Unit.

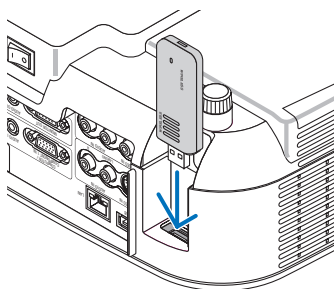

5. Secure the holder with the screw to the projector.

---

*NOTE: Be sure to place the catch into the groove on the USB Wireless LAN Unit.*

---

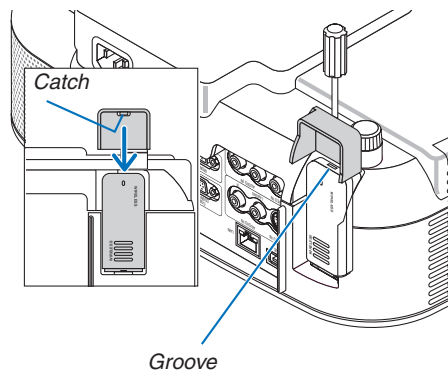

## 9 Troubleshooting Check List

Before contacting your dealer or service personnel, check the following list to be sure repairs are needed also by referring to the “Troubleshooting” section in your user’s manual. This checklist below will help us solve your problem more efficiently.

\* Print the following pages.

**Frequency of occurrence**  always  sometimes (How often? \_\_\_\_\_)  other (\_\_\_\_\_)

### Power

- |  |   |
|--|---|
| <ul style="list-style-type: none"> <li><input type="checkbox"/> No power (POWER indicator does not light green) See also “Status Indicator (STATUS)”.</li> <li><input type="checkbox"/> Power cable’s plug is fully inserted into the wall outlet.</li> <li><input type="checkbox"/> Main power switch is pressed to the ON position.</li> <li><input type="checkbox"/> Lamp cover is installed correctly .</li> <li><input type="checkbox"/> Lamp Hours Used (lamp operation hours) was cleared after lamp replacement.</li> <li><input type="checkbox"/> No power even though you press and hold the POWER button for a minimum of 2 seconds.</li> </ul> | <ul style="list-style-type: none"> <li><input type="checkbox"/> Shut down during operation.           <ul style="list-style-type: none"> <li><input type="checkbox"/> Power cable’s plug is fully inserted into the wall outlet.</li> <li><input type="checkbox"/> Lamp cover is installed correctly .</li> <li><input type="checkbox"/> Auto Power Off is turned off (only models with the Auto Power Off function).</li> <li><input type="checkbox"/> Off Timer is turned off (only models with the Off Timer function ).</li> <li><input type="checkbox"/> PROGRAM TIMER is turned off (only models with the Program Timer function.)</li> </ul> </li> </ul> |
|--|---|

### Video and Audio

- |  |  |
|--|--|
| <ul style="list-style-type: none"> <li><input type="checkbox"/> No image is displayed from your PC or video equipment to the projector.</li> <li><input type="checkbox"/> Still no image even though you connect the projector to the PC first, then start the PC.</li> <li><input type="checkbox"/> Enabling your notebook PC’s signal output to the projector.           <ul style="list-style-type: none"> <li>• <i>A combination of function keys will enable/disable the external display. Usually, the combination of the “Fn” key along with one of the 12 function keys turns the external display on or off.</i></li> </ul> </li> <li><input type="checkbox"/> No image (blue background, logo, no display).</li> <li><input type="checkbox"/> Still no image even though you press the AUTO ADJUST button.</li> <li><input type="checkbox"/> Still no image even though you carry out [RESET] in the projector’s menu.</li> <li><input type="checkbox"/> Signal cable’s plug is fully inserted into the input connector</li> <li><input type="checkbox"/> A message appears on the screen. ( _____ )</li> <li><input type="checkbox"/> The source connected to the projector is active and available.</li> <li><input type="checkbox"/> Still no image even though you adjust the brightness and/or the contrast.</li> <li><input type="checkbox"/> Input source’s resolution and frequency are supported by the projector.</li> <li><input type="checkbox"/> Image is too dark.           <ul style="list-style-type: none"> <li><input type="checkbox"/> Remains unchanged even though you adjust the brightness and/or the contrast.</li> </ul> </li> <li><input type="checkbox"/> Image is distorted.           <ul style="list-style-type: none"> <li><input type="checkbox"/> Image appears to be trapezoidal (unchanged even though you carry out the [KEystone] or [3D REFORM] adjustment).</li> </ul> </li> </ul> | <ul style="list-style-type: none"> <li><input type="checkbox"/> Parts of the image are lost.           <ul style="list-style-type: none"> <li><input type="checkbox"/> Still unchanged even though you press the AUTO ADJUST button.</li> <li><input type="checkbox"/> Still unchanged even though you carry out [RESET] in the projector’s menu.</li> </ul> </li> <li><input type="checkbox"/> Image is shifted in the vertical or horizontal direction.           <ul style="list-style-type: none"> <li><input type="checkbox"/> Horizontal and vertical positions are correctly adjusted on a computer signal.</li> <li><input type="checkbox"/> Input source’s resolution and frequency are supported by the projector.</li> <li><input type="checkbox"/> Some pixels are lost.</li> </ul> </li> <li><input type="checkbox"/> Image is flickering.           <ul style="list-style-type: none"> <li><input type="checkbox"/> Still unchanged even though you press the AUTO ADJUST button.</li> <li><input type="checkbox"/> Still unchanged even though you carry out [RESET] in the projector’s menu.</li> <li><input type="checkbox"/> Image shows flickering or color drift on a computer signal.</li> <li><input type="checkbox"/> Still unchanged even though you change [FAN MODE] from [HIGH ALTITUDE] to [AUTO].</li> </ul> </li> <li><input type="checkbox"/> Image appears blurry or out of focus.           <ul style="list-style-type: none"> <li><input type="checkbox"/> Still unchanged even though you checked the signal’s resolution on PC and changed it to projector’s native resolution.</li> <li><input type="checkbox"/> Still unchanged even though you adjusted the focus.</li> </ul> </li> <li><input type="checkbox"/> No sound.           <ul style="list-style-type: none"> <li><input type="checkbox"/> Audio cable is correctly connected to the audio input of the projector.</li> <li><input type="checkbox"/> Still unchanged even though you adjusted the volume level.</li> <li><input type="checkbox"/> AUDIO OUT is connected to your audio equipment (only models with the AUDIO OUT connector).</li> </ul> </li> </ul> |
|--|--|

### Other

- |  |  |
|--|--|
| <ul style="list-style-type: none"> <li><input type="checkbox"/> Remote control does not work.           <ul style="list-style-type: none"> <li><input type="checkbox"/> No obstacles between the sensor of the projector and the remote control.</li> <li><input type="checkbox"/> Projector is placed near a fluorescent light that can disturb the infrared remote controls.</li> <li><input type="checkbox"/> Batteries are new and are not reversed in installation.</li> <li><input type="checkbox"/> If present on the remote control, projector selector switch is not used.</li> </ul> </li> </ul> | <ul style="list-style-type: none"> <li><input type="checkbox"/> Buttons on the projector cabinet do not work ( only models with the Control Panel Lock function).           <ul style="list-style-type: none"> <li><input type="checkbox"/> Control Panel Lock is not turned on or is disabled in the menu.</li> <li><input type="checkbox"/> Still unchanged even though you press and hold the EXIT button for a minimum of 10 seconds.</li> </ul> </li> </ul> |
|--|--|



In the space below please describe your problem in detail.

### Information on application and environment where your projector is used

#### Projector

Model number:

Serial No.:

Date of purchase:

Lamp operating time (hours):

Lamp Mode:  Normal  Eco

Information on input signal:

Horizontal synch frequency [     ] kHz

Vertical synch frequency [     ] Hz

Synch polarity H  (+)  (-)

V  (+)  (-)

Synch type  Separate  Composite

Sync on Green

STATUS Indicator:

Steady light  Orange  Green

Flashing light [     ] cycles

Remote control model number:

#### Installation environment

Screen size:                    inch

Screen type:  White matte  Beads  Polarization  
 Wide angle  High contrast

Throw distance:                feet/inch/m

Orientation:  Ceiling mount  Desktop

Power outlet connection:

Connected directly to wall outlet

Connected to power cord extender or other (the number of connected equipment \_\_\_\_\_)

Connected to a power cord reel or other (the number of connected equipment \_\_\_\_\_)

#### Computer

Manufacturer:

Model number:

Notebook PC  / Desktop

Native resolution:

Refresh rate:

Video adapter:

Other:

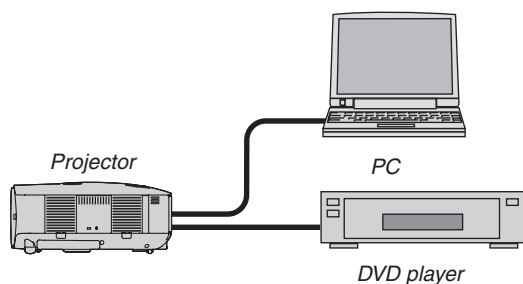

#### Signal cable

NEC standard or other manufacturer's cable?

Model number:                    Length:                    inch/m

Distribution amplifier

Model number:

Switcher

Model number:

Adapter

Model number:

#### Video equipment

VCR, DVD player, Video camera, Video game or other

Manufacturer:

Model number:

## 10 TravelCare Guide

### TravelCare - a service for international travelers

This product is eligible for "TravelCare", NEC's unique international warranty.

Please note that TravelCare coverage differs in part from coverage under the warranty included with the product.

### Services offered with TravelCare

This warranty allows customers to receive service on their product at the NEC and NEC-designated service stations in the countries listed herein when temporarily traveling internationally for business or pleasure.

For details on services offered by the different service stations, please refer to the "List of TravelCare Outlets" below.

#### 1 Repair services

The product will be repaired and delivered within 10 business days, not including shipping time.

During the term of warranty, the cost of maintenance parts, labor costs for repairs and shipping costs within the service station's coverage area are covered by the warranty.

#### 2 Replacement product rental service

If the customer desires, he or she can rent a replacement product while the original product is being repaired.

Fee: US\$200 for 12 days

This fee must be paid at the local service station in cash or credit card.

The US\$200 rental fee is non-refundable even if the customer rents it less than 12 days before returning.

The replacement product will be delivered within 3 business days. If the customer did not return the replacement product within 12 days, the customer will be charged the price of the unit.

If the customer returned the replacement product in a faulty or damaged condition, the repair cost will be charged to the customer. Note that this service is not offered in all countries and regions. Please refer to the "List of TravelCare Outlets".

In addition, this replacement product rental service is not offered after the product's warranty has expired.

### Term of warranty

1

- a. Upon presentation of the warranty or receipt received upon purchase:

Valid for the term indicated on the warranty or the normal term of warranty for the country of purchase.

- b. When only the product is brought in:

Valid for a period of within 14 months of the date of manufacture indicated by the serial number attached to the product.

- 2 When a product whose term of warranty is expired is brought in:

Repairs will be offered for a fee. In this case the customer is not eligible for the replacement product rental service.

- 3 In the following cases, repairs may be charged, even if the product's warranty is still in effect:

- 1) If the term of warranty, model name, serial number and name of the store of purchase are not indicated on the warranty or have been altered.
- 2) Problems or damage caused by dropping or shocks during shipment or movement by the customer or by improper handling by the customers.
- 3) Problems or damage caused by improper usage or unwarrantable alterations or repairs by the customer.
- 4) Problems or damage caused by fire, salt damage, gas damage, earthquakes, lightning damage, storm or flood damage or other natural disasters or such external factors as dust, cigarette smoke, abnormal voltage, etc.
- 5) Problems or damage caused by use in hot or humid places, in vehicles, boats or ships, etc.

- 6) Problems or damage caused by expendable supplies or devices connected to the product other than those designated by NEC.
- 7) Problems caused by natural consumption, wear or deterioration of parts under normal usage conditions.
- 8) Problems or damage to lamps and other expendable supplies, included parts or optional parts.
- 9) Other conditions stipulated in the warranty included with the product also apply.

**NOTE:** The product can be used overseas with voltages of 100 to 120V and 200 to 240V by using a power cable suited for the standards and power source voltage of the country in which the product is being used.

### List of TravelCare Outlets

This list applies as of October 1, 2007.

For the most up-to-date information, please refer to the websites of the service stations in the various countries on the List of TravelCare Outlets or to the NEC website at <http://www.nec-pj.com>.

#### In Europe

NEC Europe, Ltd. / European Technical Centre

Address: Unit G, Stafford Park 12, Telford TF3 3BJ, U.K.

Telephone: +44 1952 237000

Fax Line: +44 1952 237006

Email Address: [AFR@uk.neceur.com](mailto:AFR@uk.neceur.com)

WEB Address: <http://www.neceur.com>

(Regions Covered)

EU: Austria\*, Belgium\*, Denmark\*, Finland\*, France\*, Germany\*, Greece\*, Ireland\*, Italy\*, Luxembourg\*, The Netherlands\*, Portugal\*, Spain\*, Sweden\* and the United Kingdom\*

EEA: Norway\*, Iceland and Liechtenstein

#### In North America

NEC Display Solutions of America, Inc.

Address: 500 Park Boulevard, Suite 1100

Itasca, Illinois 60143, U.S.A.

Telephone: +1 800 836 0655

Fax Line: +1 800 356 2415

Email Address: [vsd.tech-support@necdisplay.com](mailto:vsd.tech-support@necdisplay.com)

WEB Address: <http://www.necdisplay.com/>

(Regions Covered)

U.S.A. \*, Canada\*

#### In Oceania

NEC Australia Pty., Ltd.

Address:

New South Wales;

184 Milperra Road, Reversby NSW 2212

Telephone: +61 2 9780 8688 Fax Line: +61 2 9780 8659

Victoria;

Unit 1/6 Garden Road, Clayton VIC 3168

Telephone: +61 3 8562 6245 Fax Line: +61 3 8562 6220

Newcastle;

120 Parry Street Newcastle West NSW 2300

Telephone: +61 2 4926 2466

Queensland;

Unit 4/305 Montague Road West End QLD 4101

Telephone: +61 7 3840 5858 Fax Line: +61 7 3840 5866

Goldcoast QLD;

Shop1 48 Ferry Road Southport QLD 4215

Telephone: +61 7 5591 3670

South Australia;

84A Richmond Road, Keswick SA 5035

Telephone: +61 8 8375 5707 Fax Line: +61 8 8375 5757

Western Australia;

45 Sarich Court Osborne Park WA 6017

Telephone: +61 8 9445 5901 Fax Line: +61 8 9445 5999

WEB Address: <http://www.nec.com.au>

(Regions Covered)

Australia\*, New Zealand

**In Asia and Middle East**

## NEC Display Solutions, Ltd.

Address: 686-1, Nishioi, Oi-Machi, Ashigarakami-Gun,  
Kanagawa 258-0017, Japan  
Telephone: +81 465 85 2369  
Fax Line: +81 465 85 2393  
Email Address: support\_pjweb@gw.neds.nec.co.jp  
WEB Address: <http://www.nec-pj.com>

(Regions Covered)  
Japan\*

## NEC Solutions (China) Co.,Ltd.

Address: Rm 1903, Shining Building, 35 Xueyuan Rd,  
Haidian District Beijing 100083, P.R.C.  
Telephone: +8610 82317788  
Fax Line: +8610 82331722  
Email Address: Lily@necsl.com.cn  
Johnson\_liu@necsl.com.cn  
WEB Address: <http://www.necsl.com.cn>

(Regions Covered)  
China

## NEC Hong Kong Ltd.

Address: 25/F.,The Metropolis Tower, 10 Metropolis Drive,  
Hungghom, Kowloon, Hong Kong  
Telephone: +852 2369 0335  
Fax Line: +852 2795 6618  
Email Address: nechksc@nechk.nec.com.hk  
esmond\_au@nechk.nec.com.hk  
WEB Address: <http://www.nec.com.hk>

(Regions Covered)  
Hong Kong

## NEC Taiwan Ltd.

Address: 7F, No.167, SEC.2, Nan King East Road, Taipei,  
Taiwan, R.O.C.  
Telephone: +886 2 8500 1714  
Fax Line: +886 2 8500 1420  
Email Address: chenguanfu@nec.com.tw  
WEB Address: <http://www.nec.com.tw>

(Regions Covered)  
Taiwan

## NEC Asia Pte.Ltd.

Address: 401 Commonwealth Drive, #07-02, Haw Par  
Technocentre, Singapore 149598  
Telephone: +65 6 273 8333  
Fax Line: +65 6 274 2226  
Email Address: tehgh@rsc.ap.nec.com.sg  
WEB Address: <http://www.nec.com.sg/ap>

(Regions Covered)  
Singapore

## NEC Systems Integration Malaysia Sdn Bhd

Address: Ground Floor, Menara TA One, 22, Jalan P. Ramlee,  
50250 Kuala Lumpur, Malaysia  
Telephone: +6 03 2178 3600 (ISDN)  
Fax Line: +6 03 2178 3789  
Email Address: necare@nsm.nec.co.jp  
WEB Address: <http://www.necarecenter.com>

(Regions Covered)  
Malaysia

## Hyosung ITX Co., Ltd.

Address: 2nd Fl., Ire B/D. #2, 4Ga, Yangpyeng-Dong,  
Youngdeungpo-Gu, Seoul, Korea 150-967  
Telephone: +82 2 2163 4193  
Fax Line: +82 2 2163 4196  
Email Address: moneybear@hyosung.com

(Regions Covered)  
South Korea

## Lenso Communication Co., Ltd.

Address: 292 Lenso House 4, 1st Floor, Srinakarin Road,  
Huamark, Bangkok, Bangkok 10240, Thailand  
Telephone: +66 2 375 2425  
Fax Line: +66 2 375 2434  
Email Address: pattara@lenso.com  
WEB Address: <http://www.lenso.com>

(Regions Covered)  
Thailand

## ABBA Electronics L.L.C.

Address: Tariq Bin Ziyad Road, P.O.Box 327, Dubai,  
United Arab Emirates  
Telephone: +971 4 371800  
Fax Line: +971 4 364283  
Email Address: ABBA@emirates.net.ae

(Regions Covered)  
United Arab Emirates

## Samir Photographic Supplies

Address: P.O.Box 599, Jeddah 21421, Saudi Arabia  
Telephone: +966 2 6828219  
Fax Line: +966 2 6830820  
Email Address: asif@samir-photo.com

## Riyadh

Address: P.O.Box 5519, Riyadh 11432, Saudi Arabia  
Telephone: +966 1 4645064  
Fax Line: +966 1 4657912  
Email Address: bhimji@samir-photo.com

## Alkhobar

Address: P.O.Box 238, Alkhobar 31952, Saudi Arabia  
Telephone: +966 3 8942674  
Fax Line: +966 3 8948162  
Email Address: chamsedin@samir-photo.com

(Regions Covered)  
Saudi Arabia

**NOTE:** In countries designated with an asterisk (\*), replacement product rental service are offered.

Date: / / ,

P-1/ ,

**TO: NEC or NEC's Authorized Service Station:  
FM:**

---

(Company & Name with signature)

Dear Sir (s),

I would like to apply your TravelCare Service Program based on attached registration and qualification sheet and agree with your following conditions, and also the Service fee will be charged to my credit card account, if I don't return the Loan units within the specified period. I also confirm following information is correct. Regards.

***Application Sheet for TravelCare Service Program***

Country, product purchased :	
User's Company Name :	
User's Company Address : Phone No., Fax No. :	
User's Name :	
User's Address :	
Phone No., Fax No. :	
Local Contact office :	
Local Contact office Address :	
Phone No., Fax No. :	
User's Model Name :	
Date of Purchase :	
Serial No. on cabinet :	
Problem of units per User :	
Required Service :	(1) Repair and Return      (2) Loan unit
Requested period of Loan unit :	
Payment method :	(1) Credit Card      (2) Travelers Cheque      (3) Cash
In Case of Credit Card : Card No. w/Valid Date :	

### Condition of your TravelCare Service Program

Enduser is requested to understand following condition of TravelCare Service Program and complete the necessary information on the application sheet.

#### 1. Service Options:

There are 3 types of "Service" available. Enduser has to understand following condition and is required to fill in the Application Sheet.

##### 1) Repair and Return:

The 'Faulty unit' is sent or collected from the customer. It is repaired and returned within 10 days to the customer, excluding transport time.

There may have a case, repair and return can't be done by NEC Authorized Service Station, because of shortage of spare parts due to same model is not sold in the territory.

##### 2) Repair and Return with Loan: (This service is limited to some Service Stations)

This service is offered to the Enduser, who cannot wait until their unit is repaired.

The customer can borrow a unit for \$200 up to 12 days. Customer then sends in inoperable unit to nearest NEC Authorized Service Station for service. In order to prevent collection problem, Enduser is required to fill in Application Sheet.

Enduser needs to confirm the availability of the Service to NEC Authorized Service Stations.

##### 3) Loan Only:

For this service, NEC Authorized Service Station supplies the customer with a loan unit for US\$200 up to 12 days. Customer keeps the inoperable unit and when customer returns home, customer arranges to have the projector serviced in the home country.

#### 2. Warranty Exclusions:

This program does not apply if the Projector's serial number has been defaced, modified or removed.

If, in the judgement of NEC Authorized Service Station or its agent the defects or failures result from any cause other than fair wear and tear or NEC neglect, or fault including the following without limitation:

- 1) Accidents, transportation, neglect, misuse, abuse, water, dust, smoke or default of or by the Customer its employees or agents or any third party;
- 2) Failure or fluctuation of electrical power, electrical circuitry, air conditioning, humidity control or other environmental conditions such as use it in smoking area;
- 3) Any fault in the attachments or associated products or components (whether or not supplied by NEC or its agents which do not form part of the Product covered by this warranty);
- 4) Any act of God, fire, flood, war, act of violence or any similar occurrence;
- 5) Any attempt by any person other than any person authorized by NEC to adjust, modify, repair, install or service the product.
- 6) Any Cross-border charges such as, duty, insurance, tax etc.

#### 3. Charges for Warranty Exclusions and Out of Warranty Case:

In case faulty unit is under warranty exclusions case or under Out of Warranty period, NEC Authorized Service Station will Inform estimation of actual service cost to the Enduser with reason.

#### 4. Dead on Arrival (DOA):

Enduser must take this issue up with their original supplier in the country of purchase.

NEC Authorized Service Station will repair the DOA unit as a Warranty repair, but will not exchange DOA unit with new units.

#### 5. Loan Service Charges and Conditions:

Upon acceptance of this NEC Projector, Customer agrees to assume liability for this loan unit.

The current cost of use of this loan unit is \$200.00 USD for 12 calendar days.

If Customer does not return the unit within the 12 calendar days, Customer will be charged the next highest cost up to and including the full list price to Credit Cards, which price will be informed by NEC Authorized Service Stations. Please see the attached listing of contacts for each country to arrange for pickup of the loan unit.

If you return to their country of origin with the loan unit, you will be charged additional freight to return the unit to the loaning country.

Thank you for your understanding of this program.