

# pCO sistema

CAREL

## General manual



ENG

User manual

LEGGI E CONSERVA  
QUESTE ISTRUZIONI  
READ AND SAVE  
THESE INSTRUCTIONS





**We wish to save you time and money!**  
**We can assure you that the thorough reading of this manual will guarantee correct installation and safe use of the product described.**

#### IMPORTANT WARNINGS

CAREL bases the development of its products on decades of experience in HVAC, on the continuous investments in technological innovations to products, procedures and strict quality processes with in-circuit and functional testing on 100% of its products, and on the most innovative production technology available on the market. CAREL and its subsidiaries nonetheless cannot guarantee that all the aspects of the product and the software included with the product respond to the requirements of the final application, despite the product being developed according to state-of-the-art techniques.

The customer (manufacturer, developer or installer of the final equipment) accepts all liability and risk relating to the configuration of the product in order to reach the expected results in relation to the specific final installation and/or equipment.

CAREL may, based on specific agreements, act as a consultant for the positive commissioning of the final unit/application, however in no case does it accept liability for the correct operation of the final equipment/system.

The CAREL product is a state-of-the-art product, whose operation is specified in the technical documentation supplied with the product or can be downloaded, even prior to purchase, from the website [www.carel.com](http://www.carel.com).

Each CAREL product, in relation to its advanced level of technology, requires setup/configuration/programming/commissioning to be able to operate in the best possible way for the specific application. The failure to complete such operations, which are required/indicated in the user manual, may cause the final product to malfunction; CAREL accepts no liability in such cases.

Only qualified personnel may install or carry out technical service on the product.

The customer must only use the product in the manner described in the documentation relating to the product.

In addition to observing any further warnings described in this manual, the following warnings must be heeded for all CAREL products:

- Prevent the electronic circuits from getting wet. Rain, humidity and all types of liquids or condensate contain corrosive minerals that may damage the electronic circuits. In any case, the product should be used or stored in environments that comply with the temperature and humidity limits specified in the manual.
- Do not install the device in particularly hot environments. Too high temperatures may reduce the life of electronic devices, damage them and deform or melt the plastic parts. In any case, the product should be used or stored in environments that comply with the temperature and humidity limits specified in the manual.
- Do not attempt to open the device in any way other than described in the manual.
- Do not drop, hit or shake the device, as the internal circuits and mechanisms may be irreparably damaged.
- Do not use corrosive chemicals, solvents or aggressive detergents to clean the device.
- Do not use the product for applications other than those specified in the technical manual.

All of the above suggestions likewise apply to the controllers, serial boards, programming keys or any other accessory in the CAREL product portfolio.

CAREL adopts a policy of continual development. Consequently, CAREL reserves the right to make changes and improvements to any product described in this document without prior warning.

The technical specifications shown in the manual may be changed without prior warning.

The liability of CAREL in relation to its products is specified in the CAREL general contract conditions, available on the website [www.carel.com](http://www.carel.com) and/or by specific agreements with customers; specifically, to the extent where allowed by applicable legislation, in no case will CAREL, its employees or subsidiaries be liable for any lost earnings or sales, losses of data and information, costs of replacement goods or services, damage to things or people, downtime or any direct, indirect, incidental, actual, punitive, exemplary, special or consequential damage of any kind whatsoever, whether contractual, extra-contractual or due to negligence, or any other liabilities deriving from the installation, use or impossibility to use the product, even if CAREL or its subsidiaries are warned of the possibility of such damage.

#### **Disposing of the parts of the controller:**

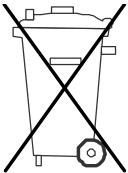

#### **INFORMATION FOR USERS ON THE CORRECT HANDLING OF WASTE ELECTRICAL AND ELECTRONIC EQUIPMENT (WEEE)**

In reference to European Union directive 2002/96/EC issued on 27 January 2003 and the related national legislation, please note that:

1. WEEE cannot be disposed of as municipal waste and such waste must be collected and disposed of separately;
2. The public or private waste collection systems defined by local legislation must be used. In addition, the equipment can be returned to the distributor at the end of its working life when buying new equipment;
3. The equipment may contain hazardous substances: the improper use or incorrect disposal of such may have negative effects on human health and on the environment;
4. The symbol (crossed-out wheeled bin) shown on the product or on the packaging and on the instruction sheet indicates that the equipment has been introduced onto the market after 13 August 2005 and that it must be disposed of separately;
5. In the event of illegal disposal of electrical and electronic waste, the penalties are specified by local waste disposal legislation.



# Contents

<b>INTRODUCTION</b> .....	<b>7</b>
<b>1. GENERAL FEATURES</b> .....	<b>7</b>
1.1 Programmability.....	7
<b>2. DESCRIPTION OF THE PRODUCTS</b> .....	<b>8</b>
2.1 pCO <sup>3</sup> controller.....	8
2.2 pCO <sup>3</sup> technical specifications.....	11
2.3 pCO <sup>1</sup> controller.....	14
2.4 pCO <sup>1</sup> technical specifications.....	16
2.5 pCO <sup>RS</sup> board.....	19
2.6 pCO <sup>RS</sup> technical specifications.....	20
2.7 pCO <sup>C</sup> controller.....	22
2.8 pCO <sup>C</sup> technical specifications.....	24
<b>3. USER TERMINALS</b> .....	<b>27</b>
3.1 pGD0/pGD1, pGD2/pGD3 graphic terminals.....	27
<b>4. INSTALLING THE pCO CONTROLLER</b> .....	<b>31</b>
4.1 General installation instructions.....	31
4.2 Power supply.....	32
4.3 Connecting the analogue inputs.....	32
4.4 Connecting the digital inputs.....	36
4.5 Connecting the analogue outputs.....	38
4.6 Connecting the digital outputs.....	39
<b>5. Configuration of the pLAN network</b> .....	<b>41</b>
5.1 Introduction.....	41
5.2 Installing the pGD0 and pGD1 terminals.....	43
5.3 Installing the pGD2 and pGD3 terminals.....	44
5.4 Installing the Aria terminal.....	45
5.5 Setting the pLAN address on the pCO <sup>1</sup> , pCO <sup>RS</sup> , pCO <sup>C</sup> and pCO <sup>3</sup> .....	46
5.6 pLAN electrical connections between the pCO controllers.....	46
5.7 Remote installation of a terminal in a pLAN network.....	47
5.8 pLAN network technical specifications.....	48
<b>6. OPTIONS AND EXTERNAL MODULES</b> .....	<b>49</b>
6.1 Connectors.....	50
6.2 Optional pCO sistema boards.....	50
6.3 Signal LEDs and software updates.....	54
<b>7. Updates, Firmware and Logs for pCO controllers</b> .....	<b>55</b>
7.1 WINLOAD.....	55
7.2 Smart Key.....	56
7.3 NAND FLASH memory.....	56
7.4 Checking the software installed on the pCO and other information.....	56
<b>8. General connection diagrams</b> .....	<b>58</b>
<b>9. Troubleshooting</b> .....	<b>62</b>

<b>10. Networks and Protocols.....</b>	<b>64</b>
10.1 pLAN protocol.....	64
10.2 Local terminal protocol.....	64
10.3 CAREL Slave protocol.....	64
10.4 CAREL Master protocol.....	65
10.5 CAREL Master 5 expansions protocol.....	65
10.6 WinLoad protocol.....	66
10.7 PST protocol.....	67
10.8 Modbus Slave protocol.....	67
10.9 Modbus Master protocol.....	68
10.10 Modbus Master protocol - Benschaw.....	68
10.11 PSTN protocol (modem).....	68
10.12 GSM protocol (GSM modem).....	69
10.13 MP-Bus protocol.....	69
10.14 Serial printer protocol.....	70
<b>Appendix:</b>	
Devices that can be connected to the pCO .....	71
Overview of the pCO .....	79

# INTRODUCTION

pCO sistema: the CAREL range of programmable controllers.

This consists of programmable controllers, user interfaces, gateways and communication and remote management interfaces to offer the HVAC/R market a control system that is powerful, flexible and easy to interface with the more commonly-used building management systems. pCO sistema is very reliable and can be easily customised to differentiate the controller on the manufacturer's own air-conditioning or refrigeration unit.

## 1. GENERAL FEATURES

All versions of these controllers use a 16-bit microprocessor and up to 4 Mbytes of memory to ensure high performance in terms of speed and memory space. The pCO sistema controllers also come in different sizes according to the number of inputs and outputs so as to always offer the best cost/performance ratio. Given the increasing demand for integration, the pCO sistema family can communicate using some of the most commonly-used communication serial standards, and with the addition of optional boards can be integrated into the most widely available BMS systems.

The pCO<sup>\*</sup> family features the possibility to connect ratiometric sensors, the integration of a Built-In terminal, an upgraded programming key and a serial port for connection to the controlled field devices (valves, I/O expansions, electronic valve drivers...). All these features ensure our controllers a level of excellence in responding to the needs of the HVAC/R market.

### 1.1 Programmability

The CAREL pCO sistema controllers can be programmed using the EasyTools development system, with the following advantages:

- transfer of the software to different types of CAREL hardware. The applications developed for the pCO can simply and quickly transferred from one hardware platform to another (and vice-versa), simply adapting only the inputs and the outputs;
- rapid development, at competitive costs, of custom programs;
- reliability guaranteed by the use of standard routines, tested in the field.

The use of EasyTools, moreover, ensures the customer the maximum level of privacy and self-management when developing new programs on their own. The possibility to use the same hardware for different applications allows standardisation, with the clear advantages of being able to feature in-circuit and functional testing and burn-in procedures on all of the products and consequently reach a high level of reliability, both overall and in terms of the individual electronic components.

EasyTools: exclusive CAREL development software, easy to use, for the programming, simulation, supervision and definition of pLAN networks using CAREL terminals and pCO programmable controllers.

#### 1.1.1 Applications

The programmability of the pCO sistema controllers ensures the absolute flexibility of the applications.

The same standard hardware can be used to control:

- chillers and heat pumps;
- roof-top units;
- air-conditioners;
- small / medium air handling units (upon request);
- showcases (upon request and to specifications);
- cold rooms (upon request and to specifications);
- seasoning rooms;
- compressor packs;
- universal circuit-dosing switches.

Other types of programs can be developed to specific customer requirements.

#### 1.1.2 Hardware architecture

The structure of the pCO sistema controllers features:

- the **pCO controller**, fitted with a 16-bit microprocessor for running the control program, and the set of terminals required for connection to the controlled devices (for example: valves, compressors, fans). The program and the parameters are saved permanently in the flash memory, preventing data loss in the event of power failure (without requiring a backup battery).  
The pCO can also be connected to pLAN networks made up of a maximum of 32 pCO controllers and terminals. Each board can exchange information without the need for additional hardware (any variable, digital or analogue, according to the application software) at high transmission speeds. The connection to the supervisor/telemaintenance serial line, based on the RS485 standard, is made using the optional serial boards (PCOS004850) and the CAREL communication protocol.
- The **terminal**, also managed by microprocessor, fitted with display, keypad and LEDs to allow the programming of the control parameters (set point, differential band, alarm thresholds) and basic functions by the user (ON/OFF, display of the controlled values, optional printing).  
The terminal does not have to be connected to the pCO for normal operation, but can be used for the initial programming of the fundamental parameters.

The power of the application software means that the user terminal allows:

- the initial programming of the unit, with password-protected access;
- the possibility to modify, at any time, the fundamental operating parameters, optionally protected by password;
- the display and audible signalling (by buzzer) of any alarms;
- the display of the active functions, using the LEDs;
- the display of all the values measured.

## 2. DESCRIPTION OF THE PRODUCTS

### 2.1 pCO<sup>3</sup> controller

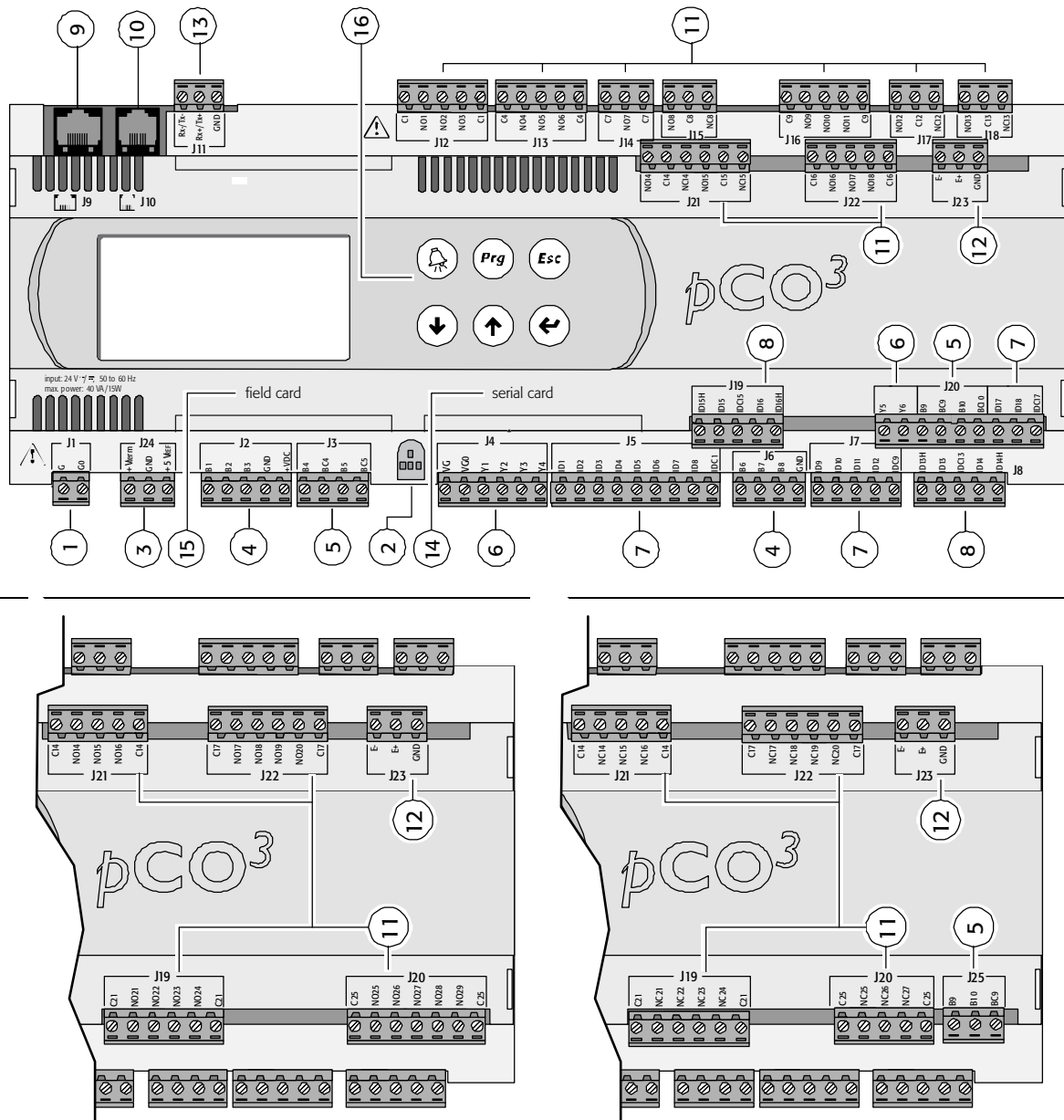

Fig. 2.a

**Key:**

- |     |  |
|-----|--|
| 1.  | power supply connector [G (+), G0 (-)];  |
| 2.  | yellow power LED and 3 status LEDs (see paragraph 6.3);  |
| 3.  | additional power supply for the terminal and 0 to 5 V ratiometric probes;                          |
| 4.  | universal analogue inputs: NTC, 0 to 1 V, 0 to 5 V ratiometric, 0 to 10 V, 0 to 20 mA, 4 to 20 mA; |
| 5.  | passive analogue inputs: NTC, PT1000, ON/OFF;  |
| 6.  | 0 to 10 V analogue outputs;  |
| 7.  | 24 Vac/Vdc digital inputs;   |
| 8.  | 230 Vac or 24 Vac/Vdc digital inputs;  |
| 9.  | connector for the display panel (external panel with direct signals);                              |
| 10. | connector for all standard pCO series terminals and for downloading the application program;       |
| 11. | relay digital outputs;   |
| 12. | connector for connection to the I/O expansion board;   |
| 13. | pLAN network connector;  |
| 14. | cover for inserting the supervisor and telemaintenance option;                                     |
| 15. | cover for inserting the field card option;   |
| 16. | Built-In terminal (LCD, buttons and LEDs).   |



### 2.1.1 Meaning of the pCO<sup>3</sup> inputs/outputs

Connector	Signal	Description
J1-1	G	+24 Vdc or 24 Vac power supply
J1-2	G0	power supply reference
J2-1	B1	universal analogue input 1 (NTC, 0 to 1 V, 0 to 10 V, 0 to 20 mA, 4 to 20 mA)
J2-2	B2	universal analogue input 2 (NTC, 0 to 1 V, 0 to 10 V, 0 to 20 mA, 4 to 20 mA)
J2-3	B3	universal analogue input 3 (NTC, 0 to 1 V, 0 to 10 V, 0 to 20 mA, 4 to 20 mA)
J2-4	GND	common for analogue inputs
J2-5	+VDC	21 Vdc power supply for active probes (maximum current 200 mA)
J3-1	B4	passive analogue input 4 (NTC, PT1000, ON/OFF)
J3-2	BC4	common for analogue input 4
J3-3	B5	passive analogue input 5 (NTC, PT1000, ON/OFF)
J3-4	BC5	common for analogue input 5
J4-1	VG	power to optically-isolated analogue output, 24 Vac/Vdc
J4-2	VG0	power to optically-isolated analogue output, 0 Vac/Vdc
J4-3	Y1	analogue output no. 1, 0 to 10 V
J4-4	Y2	analogue output no. 2, 0 to 10 V
J4-5	Y3	analogue output no. 3, 0 to 10 V
J4-6	Y4	analogue output no. 4, 0 to 10 V
J5-1	ID1	digital input no. 1, 24 Vac/Vdc
J5-2	ID2	digital input no. 2, 24 Vac/Vdc
J5-3	ID3	digital input no. 3, 24 Vac/Vdc
J5-4	ID4	digital input no. 4, 24 Vac/Vdc
J5-5	ID5	digital input no. 5, 24 Vac/Vdc
J5-6	ID6	digital input no. 6, 24 Vac/Vdc
J5-7	ID7	digital input no. 7, 24 Vac/Vdc
J5-8	ID8	digital input no. 8, 24 Vac/Vdc
J5-9	IDC1	common for digital inputs from 1 to 8 (negative pole for DC power supply)
J6-1	B6	universal analogue input 6 (NTC, 0 to 1 V, 0 to 10 V, 0 to 20 mA, 4 to 20 mA)
J6-2	B7	universal analogue input 7 (NTC, 0 to 1 V, 0 to 10 V, 0 to 20 mA, 4 to 20 mA)
J6-3	B8	universal analogue input 8 (NTC, 0 to 1 V, 0 to 10 V, 0 to 20 mA, 4 to 20 mA)
J6-4	GND	common for analogue inputs
J7-1	ID9	digital input no. 9, 24 Vac/Vdc
J7-2	ID10	digital input no. 10, 24 Vac/Vdc
J7-3	ID11	digital input no. 11, 24 Vac/Vdc
J7-4	ID12	digital input no. 12, 24 Vac/Vdc
J7-5	IDC9	common for digital inputs from 9 to 12 (negative pole for DC power supply)
J8-1	ID13H	digital input 13, 230 Vac
J8-2	ID13	digital input 13, 24 Vac/Vdc
J8-3	IDC13	common for digital inputs 13 and 14 (negative pole for DC power supply)
J8-4	ID14	digital input 14, 24 Vac/Vdc
J8-5	ID14H	digital input 14, 230 Vac
J9		8-pin telephone connector for connection to a display panel
J10		6-pin telephone connector for connection to the standard user terminal
J11-1	RX-/TX-	RX-/TX- connector for RS485 connection to the pLAN network
J11-2	RX+/TX+	RX+/TX+ connector for RS485 connection to the pLAN network
J11-3	GND	GND connector for RS485 connection to the pLAN network
J12-1	C1	common for relays: 1, 2, 3
J12-2	NO1	normally open contact, relay no. 1
J12-3	NO2	normally open contact, relay no. 2
J12-4	NO3	normally open contact, relay no. 3
J12-5	C1	common for relays: 1, 2, 3
J13-1	C4	common for relays: 4, 5, 6
J13-2	NO4	normally open contact, relay no. 4
J13-3	NO5	normally open contact, relay no. 5
J13-4	NO6	normally open contact, relay no. 6
J13-5	C4	common for relays: 4, 5, 6
J14-1	C7	common for relay no. 7

Connector	Signal	Description
J14-2	NO7	normally open contact, relay no. 7
J14-3	C7	common for relay no. 7
J15-1	NO8	normally open contact, relay no. 8
J15-2	C8	common for relay no. 8
J15-3	NC8	normally closed contact, relay no. 8
J16-1	C9	common for relays: 9, 10, 11
J16-2	NO9	normally open contact, relay no. 9
J16-3	NO10	normally open contact, relay no. 10
J16-4	NO11	normally open contact, relay no. 11
J16-5	C9	common for relays: 9, 10, 11
J17-1	NO12	normally open contact, relay no. 12
J17-2	C12	common for relay no. 12
J17-3	NC12	normally closed contact, relay no. 12
J18-1	NO13	normally open contact, relay no. 13
J18-2	C13	common for relay no. 13
J18-3	NC13	normally closed contact, relay no. 13
J19-1	ID15H	digital input 15, 230 Vac
J19-2	ID15	digital input 15, 24 Vac/Vdc
J19-3	IDC15	common for digital inputs 15 and 16 (negative pole for DC power supply)
J19-4	ID16	digital input 16, 24 Vac/Vdc
J19-5	ID16H	digital input 16, 230 Vac
J20-1	Y5	analogue output no. 5 to 0 to 10 V
J20-2	Y6	analogue output no. 6 to 0 to 10 V
J20-3	B9	passive analogue input 9 (NTC, PT1000, ON/OFF)
J20-4	BC9	common for analogue input 9
J20-5	B10	passive analogue input 10 (NTC, PT1000, ON/OFF)
J20-6	BC10	common for analogue input 10
J20-7	ID17	digital input no. 17, 24 Vac/Vdc
J20-8	ID18	digital input no. 18, 24 Vac/Vdc
J20-9	IDC17	common for digital inputs 17 and 18 (negative pole for DC power supply)
J21-1	NO14	normally open contact, relay no. 14
J21-2	C14	common for relay no. 14
J21-3	NC14	normally closed contact, relay no. 14
J21-4	NO15	normally open contact, relay no. 15
J21-5	C15	common for relay no. 15
J21-6	NC15	normally closed contact, relay no. 15
J22-1	C16	common for relays: 16, 17, 18
J22-2	NO16	normally open contact no. 16
J22-3	NO17	normally open contact no. 17
J22-4	NO18	normally open contact no. 18
J22-5	C16	common for relays: 16, 17, 18
J23-1	E-	E- terminal for RS485 connection to the I/O expansion modules
J23-2	E+	E+ terminal for RS485 connection to the I/O expansion modules
J23-3	GND	GND terminal for RS485 connection to the I/O expansion modules
J24-1	+V term	additional power supply terminal for Aria
J24-2	GND	power supply common
J24-3	+5 Vref	power supply for 0/5 V ratiometric probes

**Note:** J19, J20, J21, J22 and J23 correspond to the "LARGE" model.

## 2.2 pCO<sup>3</sup> technical specifications

### • pCO<sup>3</sup> analogue inputs

Analogue conversion	10-bit A/D converter embedded in CPU		
Maximum number	SMALL	MEDIUM and EXTRALARGE NO	LARGE and EXTRALARGE NC
	5	8	10
Type	<i>Universal</i> : 6 (inputs B1, B2, B3, B6, B7, B8) -CAREL NTC (-50T90°C; R/T 10kΩ±1% at 25°C) or HT NTC (0T150°C) -Voltage: 0 to 1 Vdc, 0 to 5 Vdc ratiometric or 0 to 10 Vdc -Current: 0 to 20 mA or 4 to 20 mA. Input resistance: 100Ω Can be selected via software. <i>Passive</i> : 4 (inputs B4, B5, B9, B10) -CAREL NTC (-50T90°C; R/T 10kΩ ±1% at 25°C) or HT NTC (0T150°C) -PT1000 (-100T200°C; R/T 1kΩ at 0°C) or digital input from voltage-free contact Can be selected via software.		
Minimum normally-open voltage-free digital input detection time	<i>Normally open</i> (open-closed-open)		250 ms
	<i>Normally closed</i> (closed-open-closed)		250 ms
NTC input precision	± 0.5°C		
PT1000 input precision	± 1°C		
0-1V input precision	± 3 mV		
0-10V input precision	± 30 mV		
0-5V input precision	± 15 mV		
0-20 mA input precision	± 0.06 mA		

**Warning:** for the power supply of any active probes, the 21 Vdc available at the +Vdc terminal (J2) can be used. The maximum current is 150 mA, protected against short-circuits. To supply the 0/5V ratiometric probes, use the 5V available at the +5Vref (terminal J24). The maximum current is 60 mA.

### • pCO<sup>3</sup> digital inputs

Type	optically-isolated			
Maximum number		no. optically-isolated inputs at 24 Vac 50/60 Hz or 24Vdc	no. optically-isolated inputs at 24 Vac/Vdc or 230 Vac 50/60 Hz	Total
	SMALL	8	None	8
	MEDIUM/EXTRALARGE	12	2	14
	LARGE	14	2+2	18
Minimum digital input pulse detection time	<i>Normally open</i> (open-closed-open)		200 ms	
	<i>Normally closed</i> (closed-open-closed)		400 ms	
Power supply to the inputs	External	230 Vac or 24 Vac (50/60 Hz)	+10/-15%	
		24Vdc	+10/-20%	
Classification of the measurement circuits (IEC EN 61010-1)	Category 1 24 Vac/Vdc Category 3 230 Vac			

#### Warnings:

- the two 230 Vac or 24 Vac/Vdc inputs at terminals J8 (ID13, ID14) or J19 (ID15, ID16) have the same common pole and consequently both must be set to the same voltage (230 Vac or 24 Vac/Vdc). There is primary insulation between the two inputs;
- for DC voltage inputs (24Vdc) connect the negative pole to the common terminal.

### • pCO<sup>3</sup> analogue outputs

Type	optically-isolated	
Maximum number	4 outputs (Y1-Y4), 0 to 10 Vdc	SMALL, MEDIUM and EXTRALARGE
	6 outputs (Y1-Y6), 0 to 10 Vdc	LARGE
Power supply	external	24 Vac/Vdc
Precision	outputs Y1-Y4	± 2% of full scale
	outputs Y5-Y6	-2/+5% of full scale
Resolution	8 bit	
Settling time	outputs Y1-Y4	2s
	outputs Y5-Y6	2s or 15s can be selected via software
Maximum load	1 kΩ (10mA)	

- pCO<sup>3</sup> digital outputs**

Insulation distance	The relay outputs have different features depending on the model of pCO <sup>3</sup> . The outputs can be divided into groups. There is double insulation between the groups (cells in the table) and consequently these may have different voltages. There is also double insulation between each terminal of the digital outputs and the rest of the controller. The relays belonging to the same group (individual cells in the table) have basic insulation and therefore must have the same power supply (24 Vac or 230 Vac).							
Makeup of the groups	Version	Reference of the relays with the same insulation						
		Group 1	Group 2	Group 3	Group 4	Group 5	Group 6	Group 7
	<b>SMALL</b>	1 to 7	8					
	Type of relay	Type A	Type A					
	<b>MEDIUM</b>	1 to 7	8	9 to 13				
	Type of relay	Type A	Type A	Type A				
	<b>LARGE</b>	1 to 7	8	9 to 13	14 to 18			
	Type of relay	Type A	Type A	Type A	Type A			
	<b>EXTRALARGE NO</b>	1 to 7	8	9 to 13	14 to 16	17 to 20	21 to 24	25 to 29
Type of relay	Type A	Type A	Type A	Type B	Type B	Type B	Type B	
<b>EXTRALARGE NC</b>	1 to 7	8	9 to 13	14 to 16	17 to 20	21 to 24	25 to 27	
Type of relay	Type A	Type A	Type A	Type C	Type C	Type C	Type C	
Number of changeover contacts	1: SMALL (output 8); 3:MEDIUM and EXTRALARGE NO/NC (outputs 8,12 and 13); 5: LARGE (outputs 8, 12, 13, 14 and 15)							
Switchable power	Relay type A	Relay ratings	SPDT, 2000 VA, 250 Vac, 8 A resistive					
		pCO <sup>3</sup> approval	UL873	2.5 A resistive, 2 A FLA, 12 A LRA, 250 Vac, C300 pilot duty (30,000 cycles)				
			EN 60730-1	2 A resistive, 2 A inductive, cosφ=0.6, 2(2)A (100,000 cycles)				
	Relay type B	Relay ratings	SPDT, 1250 VA, 250 Vac, 5 A resistive					
		pCO <sup>3</sup> approval	UL873	1 A resistive, 1 A FLA, 6 A LRA, 250 Vac, D300 pilot duty (30,000 cycles)				
			EN 60730-1	1 A resistive, 1 A inductive, cosφ=0.6, 1(1)A (100,000 cycles)				
Relay type C	Relay ratings	SPDT, 1250 VA, 250 Vac, 5 A resistive						
	pCO <sup>3</sup> approval	UL873	1 A resistive, 1 A FLA, 6 A LRA, 250 Vac, D300 pilot duty (30,000 cycles)					
		EN 60730-1	1 A resistive, 1 A inductive, cosφ=0.6, 1(1)A (100,000 cycles)					
Maximum number of SSR outputs	1: SMALL (output 7); 2:MEDIUM and EXTRALARGE NO/NC (outputs 7 and 12); 3: LARGE (outputs 7, 12 and 14) Electrical specifications: working voltage 24 Vac/Vdc, maximum switchable output 10 Watts							

**Warnings:**

- The groups that the digital outputs are divided into have two common pole terminals to simplify wiring;
- make sure that the current running through the common terminals does not exceed the rated current of an individual terminal, that is, 8 A.

- pCO<sup>3</sup> mechanical specifications**

**Mechanical dimensions**

SMALL	13 DIN modules	110 x 227.5 x 60mm
MEDIUM, LARGE, EXTRALARGE	18 DIN modules	110 x 315 x 60mm

**Plastic container**

Assembly	Fitted on DIN rail as per DIN 43880 and IEC EN 50022
Material	Technopolymer
Flame retardancy	V0 (UL94) and 960°C (IEC 695)
Ball pressure test	125°C
Resistance to creeping current	≥ 250 V
Colour	Grey RAL7035

- pCO<sup>3</sup> other features**

Operating conditions	-25T70°C, 90% RH non-condensing	
Storage conditions	-40T70°C, 90% RH non-condensing	
Index of protection	IP20, IP40 on the front panel only	
Environmental pollution	2	
Class according to protection against electric shock	to be integrated into Class 1 and/or 2 appliances	
PTI of the insulating materials	250 V	
Period of stress across the insulating parts	long	
Type of action	1C	
Type of disconnection or microswitching	microswitching, for all relay outputs	
Category of resistance to heat and fire	Category D	
Immunity against voltage surges	Category 1	
Ageing characteristics (operating hours)	80,000	
No. of automatic operating cycles	100,000 (EN 60730-1); 30,000 (UL 873)	
Software class and structure	Class A	
Category of immunity to voltage surges (IEC EN 61000-4-5)	Category 3	
Clock	clock with battery	standard
	precision	100 ppm
	Battery specifications	Lithium button battery, code CR2430, voltage 3 Vdc (dimensions 24x3 mm)

- pCO<sup>3</sup> electrical specifications**

Power supply	24 Vac +10/-15% 50/60 Hz and 28 to 36Vdc +10/-20%
Maximum current with terminal connected	40 VA (Vac) / 15 W (Vdc)
Type of insulation of the power supply from the rest of the controller	-
Terminal block	with male/female plug-in connectors (250 Vac max, 8 A max)
Cable cross-section	min 0.5 mm <sup>2</sup> – max 2.5 mm <sup>2</sup>
CPU	H8S2320, 16 bit, 24 MHz
Program memory (FLASH MEMORY)	2+2 Mbyte (Dual Bank) 16 bit
Data memory (RAM)	512 Kbyte, 16 bit
T memory, buffer (EEPROM)	13 Kbyte
P memory, parameters (EEPROM)	32 Kbyte, not available to the pLAN network
Working cycle duration (application of average complexity)	0.2 s
Clock with battery	standard

**pCO<sup>3</sup> dimensions (in mm)**

- MEDIUM, LARGE, EXTRALARGE N.O. and N.C.: 18 DIN modules**

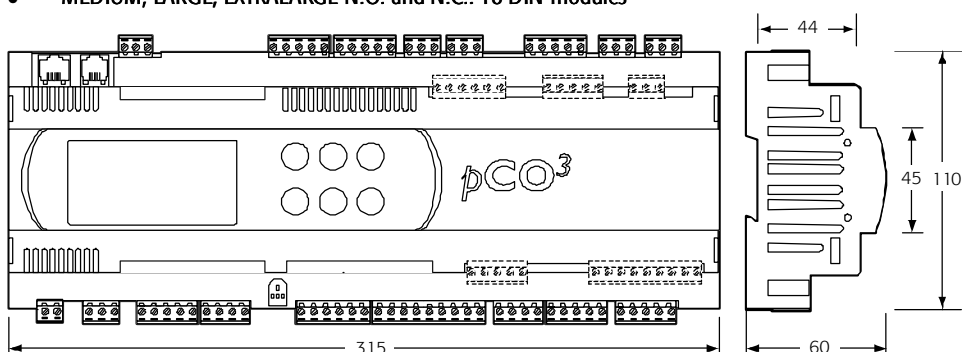

**Fig. 2.b**

- SMALL: 13 DIN modules**

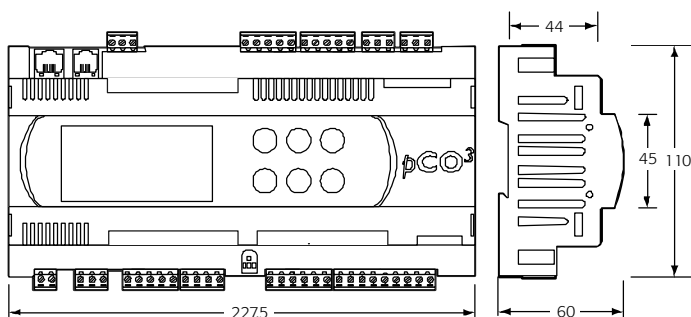

**Fig. 2.c**

**Product certification:**

- IEC EN 50155 standard: "Railway applications • Electronic equipment used on rolling stock";
- UL 873 and C22.2 No. 24-93: "Temperature-Indicating and -Regulating Equipment";
- EC regulations 37/2005 of 12 January 2005; in particular, if the electronic controller is fitted with standard Carel NTC probes, it is compliant with standard EN13485 on "Thermometers for measuring the air temperature in applications on units for the conservation and sale of refrigerated, frozen and deep-frozen food and ice cream".

## 2.3 pCO<sup>1</sup> controller

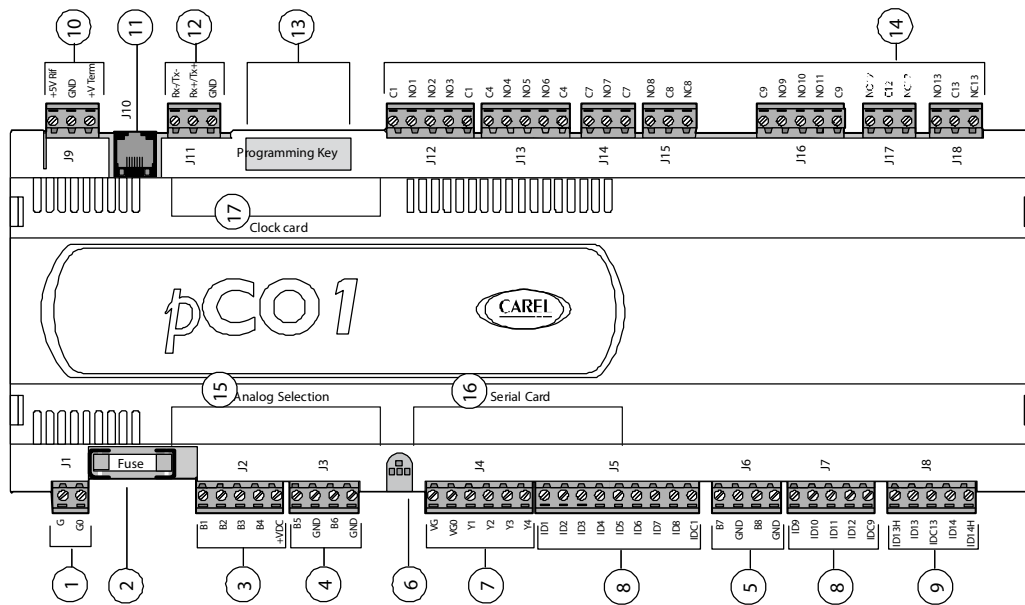

Fig. 2.d

**Key:**

1.	power supply connector [G (+), G0 (-)]
2.	250 Vac, 2 A slow-blow fuse (T2 A)
3.	universal analogue inputs: NTC, 0/1V, 0/5 V, 0/20 mA, 4/20 mA
4.	passive analogue inputs: NTC and ON/OFF
5.	passive analogue inputs: NTC
6.	yellow power LED and 3 status LEDs (see paragraph 6.3)
7.	0 to 10 V analogue outputs and PWM outputs
8.	24 Vac/Vdc digital inputs
9.	230 Vac or 24 Vac/Vdc digital inputs
10.	connector with Vref for power supply to 5V ratiometric probe and V term for power supply to Aria terminal
11.	connector for all standard pCO* series terminals and for downloading the application program
12.	pLAN network connector
13.	programming key connector
14.	relay digital outputs
15.	port for selecting the type of analogue inputs
16.	cover for inserting the optional supervisor and telemaintenance board
17.	cover for inserting the clock board

### 2.3.1 Meaning of the pCO<sup>1</sup> inputs/outputs

Connector	Signal	Description
J1-1	G	+24 Vdc or 24 Vac power supply
J1-2	G0	power supply reference
J2-1	B1	universal analogue input 1 (NTC, 0/1V, 0/5 V, 0/20 mA, 4/20 mA)
J2-2	B2	universal analogue input 2 (NTC, 0/1V, 0/5 V, 0/20 mA, 4/20 mA)
J2-3	B3	universal analogue input 3 (NTC, 0/1V, 0/5 V, 0/20 mA, 4/20 mA)
J2-4	B4	universal analogue input 4 (NTC, 0/1V, 0/5 V, 0/20 mA, 4/20 mA)
J2-5	+VDC	24 Vdc power supply for active probes (maximum current 100 mA)
J3-1	B5	passive analogue input 5 (NTC, ON/OFF)
J3-2	GND	common for analogue input 5
J3-3	B6	passive analogue input 6 (NTC, ON/OFF)
J3-4	GND	common for analogue input 6
J4-1	VG	power to optically-isolated analogue output, 24 Vac/Vdc
J4-2	VG0	power to optically-isolated analogue output, 0 Vac/Vdc
J4-3	Y1	analogue output no. 1, 0/10 V
J4-4	Y2	analogue output no. 2, 0/10 V
J4-5	Y3	analogue output no. 3, PWM (for phase cutting speed controllers)
J4-6	Y4	analogue output no. 4, PWM (for phase cutting speed controllers)
J5-1	ID1	digital input no. 1, 24 Vac/Vdc

Connector	Signal	Description
J5-2	ID2	digital input no. 2, 24 Vac/Vdc
J5-3	ID3	digital input no. 3, 24 Vac/Vdc
J5-4	ID4	digital input no. 4, 24 Vac/Vdc
J5-5	ID5	digital input no. 5, 24 Vac/Vdc
J5-6	ID6	digital input no. 6, 24 Vac/Vdc
J5-7	ID7	digital input no. 7, 24 Vac/Vdc
J5-8	ID8	digital input no. 8, 24 Vac/Vdc
J5-9	IDC1	common for digital inputs from 1 to 8 (negative pole for DC power supply)
J6-1	B7	passive analogue input 7 (NTC)
J6-2	GND	common for analogue input 7
J6-3	B8	passive analogue input 8 (NTC)
J6-4	GND	common for analogue input 8
J7-1	ID9	digital input no. 9, 24 Vac/Vdc
J7-2	ID10	digital input no. 10, 24 Vac/Vdc
J7-3	ID11	digital input no. 11, 24 Vac/Vdc
J7-4	ID12	digital input no. 12, 24 Vac/Vdc
J7-5	IDC9	common for digital inputs from 9 to 12 (negative pole for DC power supply)
J8-1	ID13H	digital input 13, 230 Vac
J8-2	ID13	digital input 13, 24 Vac/Vdc
J8-3	IDC13	common for digital inputs 13 and 14 (negative pole for DC power supply)
J8-4	ID14	digital input 14, 24 Vac/Vdc
J8-5	ID14H	digital input 14, 230 Vac
J9-1	+ 5 V ref	power supply for 0/5 V ratiometric probes
J9-2	GND	power supply common
J93	+ Vterm	additional power supply terminal for Aria
J10		6-pin telephone connector for connection to the standard user terminal
J11-1	TX-	RX-/TX- connector for RS485 connection to the pLAN network
J11-2	TX+	RX+/TX+ connector for RS485 connection to the pLAN network
J11-3	GND	GND connector for RS485 connection to the pLAN network
J12-1	C1	common for relays: 1, 2, 3
J12-2	NO1	normally open contact, relay no. 1
J12-3	NO2	normally open contact, relay no. 2
J12-4	NO3	normally open contact, relay no. 3
J12-5	C1	common for relays: 1, 2, 3
J13-1	C4	common for relays: 4, 5, 6
J13-2	NO4	normally open contact, relay no. 4
J13-3	NO5	normally open contact, relay no. 5
J13-4	NO6	normally open contact, relay no. 6
J13-5	C4	common for relays: 4, 5, 6
J14-1	C7	common for relay no. 7
J14-2	NO7	normally open contact, relay no. 7
J14-3	C7	common for relay no. 7
J15-1	NO8	normally open contact, relay no. 8
J15-2	C8	common for relay no. 8
J15-3	NC8	normally closed contact, relay no. 8
J16-1	C9	common for relays: 9, 10, 11
J16-2	NO9	normally open contact, relay no. 9
J16-3	NO10	normally open contact, relay no. 10
J16-4	NO11	normally open contact, relay no. 11
J16-5	C9	common for relays: 9, 10, 11
J17-1	NO12	normally open contact, relay no. 12
J17-2	C12	common for relay no. 12
J17-3	NC12	normally closed contact, relay no. 12
J18-1	NO13	normally open contact, relay no. 13
J18-2	C13	common for relay no. 13
J18-3	NC13	normally closed contact, relay no. 13

## 2.4 pCO<sup>1</sup> technical specifications

### • pCO<sup>1</sup> analogue inputs

Analogue conversion	10-bit A/D converter embedded in CPU	
Maximum number	SMALL 6	MEDIUM 8
Type	<i>Universal</i> : 4 (inputs B1, B2, B3, B4) -CAREL NTC (-50T90°C; R/T 10kΩ±1% at 25°C) HT NTC (0T150°C) -Voltage 0 to 1 Vdc, 0 to 5 Vdc ratiometric -Current 0 to 20 mA or 4 to 20 mA. Input resistance: 100Ω. Can be selected via dipswitch  <i>Passive</i> : 4 (inputs B5, B6, B7, B8) -CAREL NTC (-50T90°C; R/T 10kΩ±1% at 25°C) HT NTC (0T150°C) -Digital input (inputs B5, B6) from voltage-free contact Can be selected via dipswitch	
Minimum normally-open voltage-free digital input detection time	<i>Normally open</i> (open-closed-open)	250 ms
	<i>Normally closed</i> (closed-open-closed)	250 ms
Time constant for each input	2s	
Input precision NTC	± 0.5°C	
Input precision 0-1V	± 3 mV	
Input precision 0-5V	± 15 mV	
Input precision 0-20 mA	± 0.06 mA	

**Warning:** for the power supply of any active probes, the 24 Vdc available at the +Vdc terminal (J2) can be used. The maximum current is 100 mA, protected against short-circuits. To supply the 0/5V ratiometric probes, use the 5V available at the +5Vref (terminal J9). The maximum current is 60 mA.

### • pCO<sup>1</sup> digital inputs

Type	optically-isolated			
Maximum number		no. optically-isolated inputs at 24 Vac 50/60 Hz or 24Vdc	no. optically-isolated inputs at 24 Vac/Vdc or 230 Vac 50/60 Hz	Total
	SMALL	8	None	8
	MEDIUM	12	2	14
Minimum digital input pulse detection time	<i>Normally open</i> (open-closed-open)		200 ms	
	<i>Normally closed</i> (closed-open-closed)		400 ms	
Power supply to the inputs	external	230 Vac or 24 Vac (50/60 Hz)	+10/-15%	
		24Vdc	+10/-20%	

#### Warnings:

- the two 230 Vac or 24 Vac/Vdc inputs at terminals J8 have the same common pole and consequently both must be set to the same voltage (230 Vac or 24 Vac/Vdc). There is primary insulation between the two inputs;
- for DC voltage inputs (24Vdc) connect the negative pole to the common terminal.

### • pCO<sup>1</sup> analogue outputs

Type	optically-isolated	
Maximum number	2 outputs (Y1-Y2), 0 to 10 Vdc and 2 outputs (Y3-Y4) PWM with 5 V pulse of programmable duration	SMALL, MEDIUM
Power supply	external	24 Vac/Vdc
Precision	outputs Y1-Y2	± 1% of full scale
Resolution	0.5%	
Settling time	outputs Y1-Y2	2s
Maximum load	1 kΩ (10mA) for 0 to 10 Vdc and 470Ω (10mA) for PWM	



- pCO<sup>1</sup> digital outputs**

Insulation distance	The relay outputs have different features depending on the model of pCO <sup>1</sup> The outputs can be divided into groups. There is double insulation between the groups (cells in the table) and consequently these may have different voltages. There is also double insulation between each terminal of the digital outputs and the rest of the controller. The relays belonging to the same group (individual cells in the table) have basic insulation and therefore must have the same power supply (24 Vac or 230 Vac).							
Makeup of the groups	Version	Reference of the relays with the same insulation						
		Group 1	Group 2	Group 3	Group 4	Group 5	Group 6	Group 7
	<b>SMALL</b>	1 to 3	4 to 6	7	8			
	Type of relay	Type A	Type A	Type A	Type A			
Number of changeover contacts	<b>MEDIUM</b>	1 to 3	4 to 6	7	8	9 to 11	12	13
	Type of relay	Type A	Type A	Type A	Type A	Type A	Type A	Type A
Switchable power	Relay type A	Relay ratings	SPDT, 2000 VA, 250 Vac, 8 A resistive					
Maximum number of SSR outputs	Relay type A	pCO <sup>1</sup> approval	UL873	2.5 A resistive, 2 A FLA, 12 A LRA, 250 Vac, C300 pilot duty (30,000 cycles)				
			EN 60730-1	2 A resistive, 2 A inductive, $\cos\phi=0.6$ , 2(2)A (100,000 cycles)				
	1: SMALL (output 8); 3: MEDIUM (outputs 8, 12 and 13);							
	2: SMALL (output 7 and 8); 4: MEDIUM (outputs 7, 8, 12 and 13); Electrical specifications: working voltage 24 Vac/Vdc, maximum switchable output 10 Watts							

## Warnings:

- The groups that the digital outputs are divided into have two common pole terminals to simplify wiring.
- Make sure that the current running through the common terminals does not exceed the rated current of an individual terminal, that is, 8 A

- pCO<sup>1</sup> mechanical specifications**

## Mechanical dimensions

<b>SMALL</b>	13 DIN modules	110 x 227.5 x 60mm
<b>MEDIUM</b>	18 DIN modules	110 x 315 x 60mm

## Plastic container

Assembly	Fitted on DIN rail as per DIN 43880 and IEC EN 50022
Material	technopolymer
Flame retardancy	V0 (UL94) and 960°C (IEC 695)
Ball pressure test	125°C
Resistance to creeping current	≥250 V
Colour	Grey RAL7035

- pCO<sup>1</sup> other features**

Operating conditions	-10T60°C, 90% RH non-condensing	
Storage conditions	-20T70°C, 90% RH non-condensing	
Index of protection	IP20, IP40 on the front panel only	
Environmental pollution	2	
Class according to protection against electric shock	to be integrated into Class 1 and/or 2 appliances	
PTI of the insulating materials	250 V	
Period of stress across the insulating parts	long	
Type of action	1C	
Type of disconnection or microswitching	microswitching, for all relay outputs	
Category of resistance to heat and fire	Category D	
Immunity against voltage surges	Category 1	
Ageing characteristics (operating hours)	80,000	
No. of automatic operating cycles	100,000 (EN 60730-1); 30,000 (UL 873)	
Software class and structure	Class A	
Category of immunity to voltage surges (IEC EN 61000-4-5)	Category 3	
Clock	clock with battery	standard
	precision	100 ppm
	Battery specifications	Lithium button battery, code CR2430, voltage 3 Vdc (dimensions 24x3 mm)

- pCO<sup>1</sup> electrical specifications**

Power supply	24 Vac +10/-15% 50/60 Hz and 22 to 38Vdc +10/-20%
Maximum current with terminal connected	P=13 W
Type of insulation of the power supply from the rest of the controller	-
Terminal block	with male/female plug-in connectors (250 Vac max, 8 A max)
Cable cross-section	min 0.5 mm <sup>2</sup> – max 2.5 mm <sup>2</sup>
CPU	H8S2320, 16 bit, 14 MHz
Program memory (FLASH MEMORY)	2 Mbyte, 16 bit
Data memory (RAM)	512 Kbyte, 8 bit
T memory, buffer (FLASH MEMORY)	4 Kbyte, 16 bit
P memory, parameters (EEPROM)	optional (32 Kbyte not available to the pLAN network)
Working cycle duration (application of average complexity)	0.5 s
Clock with battery	optional

### Dipswitches for selecting the type of probe

**B1 B2 B3 B4 B5 B6**  
ON OFF

**0÷1V**

**NTC**

**0÷20mA**

**0÷5V**

**Esempio/ Example**

**0÷1V NTC 0÷20mA 0÷5V NTC digital input**

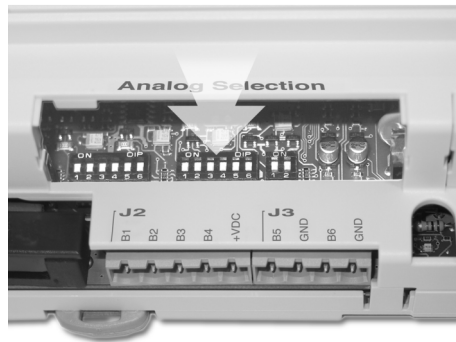

Input B1, B2, B3, B4

Input			Input
OFF	OFF	OFF	0÷1V
ON	OFF	OFF	NTC
OFF	ON	OFF	0÷20mA
OFF	OFF	ON	0÷5V

Input B5, B6

Input	
ON	digital input
OFF	NTC

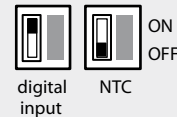

### pCO' dimensions (in mm.)

- MEDIUM 18 DIN modules

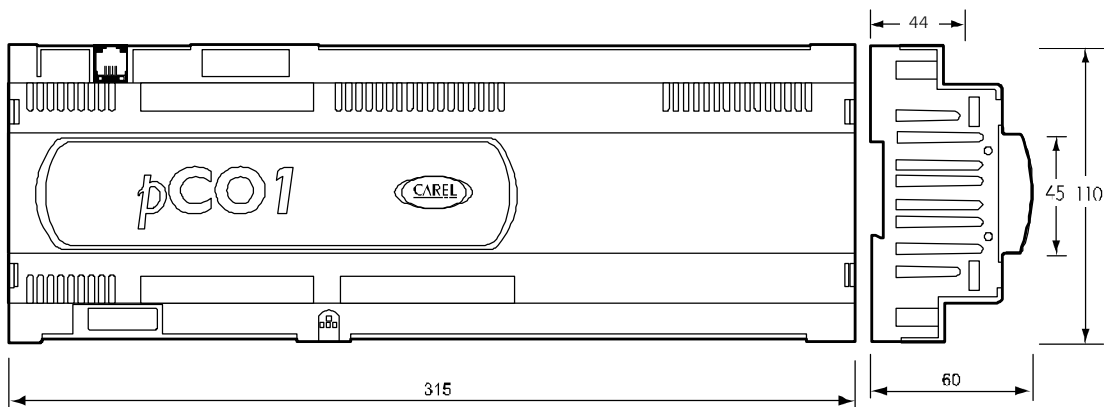

Fig. 2.e

- SMALL 18 DIN modules

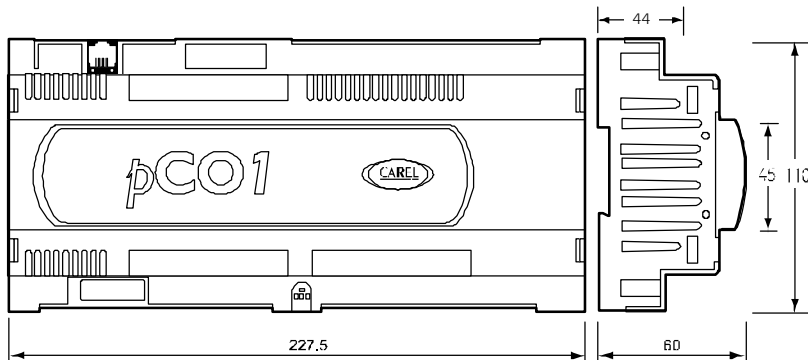
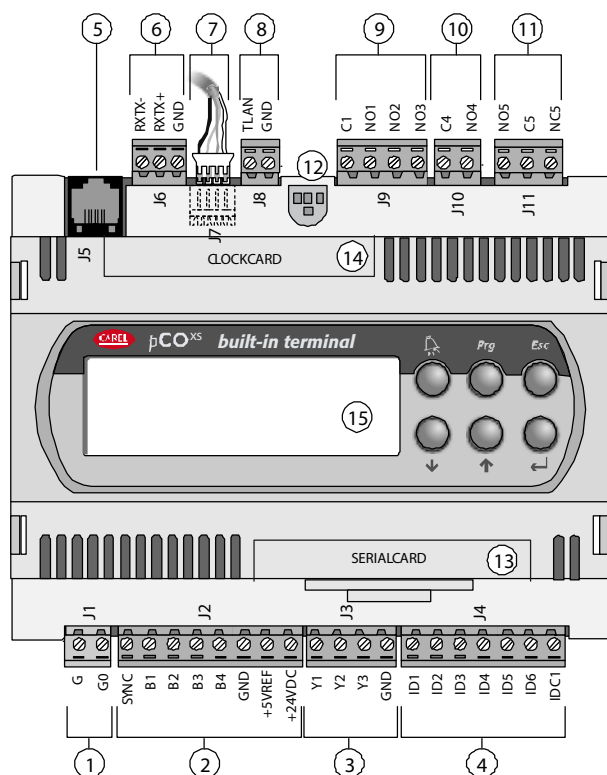

Fig. 2.f

## 2.5 pCO<sup>XS</sup> board



### Key:

1	Power supply connector [G (+), G0 (-)], 24 Vac or 24 to 48 Vdc;
2	Input (24 Vac) for phase control and NTC, 0/1 V, 0/5 V, 0/20 mA, 4/20 mA analogue inputs, +5Vref for power supply to 5V ratiometric probe and +24 Vdc power to active probes;
3	0 to 10 V analogue outputs and PWM output;
4	Digital inputs with voltage-free contact;
5	Connector for all standard pCO* series terminals and for downloading the application program;
6	pLAN network connector;
7	tLAN terminal connector;
8	tLAN or MP-Bus network connector;
9	Relay digital outputs with one common;
10	Relay/SSR digital output;
11	Digital output for alarm relay with changeover contact/SSR;
12	Yellow power LED and 3 status LEDs (see paragraph 6.3)
13	Cover for inserting the supervisor and telemaintenance option
14	Cover for inserting the dock board;
15	Built-In terminal.

Fig. 2.f

### 2.5.1 Meaning of the pCO<sup>XS</sup> board inputs/outputs

Connector	Signal	Description
J1-1	G	24 Vac or 24 to 48 Vdc power supply
J1-2	G0	power supply reference
J2-1	SYNC	synchronicity input for phase control (G0 is the reference)
J2-2	B1	universal analogue input 1 (NTC, 0/1V, 0/5 V, 0/20 mA, 4/20 mA)
J2-3	B2	universal analogue input 2 (NTC, 0/1V, 0/5 V, 0/20 mA, 4/20 mA)
J2-4	B3	universal analogue input 3 (NTC, 0/5 V)
J2-5	B4	universal analogue input 4 (NTC, 0/5 V)
J2-6	GND	reference for the analogue inputs
J2-7	+5VREF	power supply for 0/5 V ratiometric probes
J2-8	+24VDC	24 Vdc power supply for active probes
J3-1	Y1	analogue output no. 1, 0/10 V
J3-2	Y2	analogue output no. 2, 0/10 V
J3-3	Y3	analogue output no. 3, PWM (for phase cutting speed controllers)
J3-4	GND	reference for analogue output
J4-1	ID1	digital input no. 1
J4-2	ID2	digital input no. 2
J4-3	ID3	digital input no. 3
J4-4	ID4	digital input no. 4
J4-5	ID5	digital input no. 5
J4-6	ID6	digital input no. 6
J4-7	IDC1	common for digital inputs from 1 to 6
J5		6-pin telephone connector for connection to the standard user terminal
J6-1	RX-/TX-	RX-/TX- connector for RS485 connection to the pLAN network
J6-2	RX+/TX+	RX+/TX+ connector for RS485 connection to the pLAN network
J6-3	GND	reference for RS485 connection to the pLAN network
J7		tLAN terminal connector
J8-1	tLAN	connector to the tLAN network
J8-2	GND	reference for connection to the tLAN network
J9-1	C1	common for relays: 1, 2, 3
J9-2	NO1	normally open contact, relay no. 1
J9-3	NO2	normally open contact, relay no. 2
J9-4	NO3	normally open contact, relay no. 3
J10-1	C4	common for relays: 4
J10-2	NO4	normally open contact, relay no. 4
J11-1	NO5	normally open contact, relay no. 5
J11-2	C5	common for relays: 5
J11-3	NC5	normally closed contact, relay no. 5

Tab. 2.e

## 2.6 pCO<sup>XS</sup> technical specifications

### • pCO<sup>XS</sup> analogue inputs

Analogue conversion	10-bit A/D converter embedded in CPU
Maximum number	4
Type	<i>Universal: 2 (inputs B1, B2)</i> -CAREL NTC (-50T90°C; R/T 10kΩ±1% at 25°C) -Voltage 0 to 1 Vdc, 0 to 5 Vdc ratiometric; -Current 0 to 20 mA or 4 to 20 mA. Input resistance: 100Ω Can be selected via software <i>Universal: 2 (inputs B3, B4)</i> -CAREL NTC (-50T90°C; R/T 10kΩ±1% at 25°C) -Voltage 0 to 5 Vdc ratiometric Can be selected via software
Time constant for each input	1 s
Input precision NTC	± 0.5°C
Input precision 0-1V	± 3 mV
Input precision 0-5V	± 15 mV
Input precision 0-20 mA	± 0.06 mA

**Warning:** for the power supply of any active probes, the 24 Vdc available at the +Vdc terminal (J2) can be used. The maximum current is 80 mA, protected against short-circuits. To supply the 0/5V ratiometric probes, use the 5V available at the +5Vref (terminal J2). The maximum current is 60 mA.

### • pCO<sup>XS</sup> digital inputs

Type	Not optically-isolated with voltage-free contact		
Maximum number	no. optically-isolated inputs at 24 Vac 50/60 Hz or 24Vdc	no. optically-isolated inputs at 24 Vac/Vdc or 230 Vac 50/60 Hz	Total
	6	None	6
Minimum digital input pulse detection time	<i>Normally open</i> (open-closed-open)		150 ms
	<i>Normally closed</i> (closed-open-closed)		400 ms
Power supply to the inputs	internal		

### • pCO<sup>XS</sup> analogue outputs

Type	Not optically-isolated	
Maximum number	2 outputs (Y1 and Y2), 0 to 10 Vdc and 1 output (Y3), PWM with 5V pulse of programmable duration	
Power supply	internal	
Precision	outputs Y1-Y2	± 3% of full scale
Resolution	8 bit	
Settling time	outputs Y1-Y2	2s
Maximum load	1 kΩ (10 mA) for 0 to 10 Vdc and 470Ω (10 mA) for PWM	

**Note:** the synchronicity for the PWM output derives from the SYNC and GO inputs. The PWM output (Y3) can become a pulse modulation output (duration of the pulse proportional to the analogue value) by setting the software. The PWM may be in synchronicity with the SYNC signal or have a fixed cycle duration of 2 ms.

### • pCO<sup>XS</sup> digital outputs

Insulation distance	The relay outputs have different features depending on the model of pCO <sup>XS</sup> . The outputs can be divided into groups. There is double insulation between the groups (cells in the table) and consequently these may have different voltages. There is also double insulation between each terminal of the digital outputs and the rest of the controller. The relays belonging to the same group (individual cells in the table) have basic insulation and therefore can have the same power supply (24 Vac or 230 Vac).						
	Version	Reference of the relays with the same insulation					
Group 1		Group 2	Group 3				
Makeup of the groups	-	1 to 3	4	5			
	Type of relay	Type A	Type A	Type A			
Number of changeover contacts	1: output 5						
Switchable power	Relay type A	Relay ratings	SPDT, 2000 VA, 250 Vac, 8 A resistive				
		pCO <sup>XS</sup> approval	UL873	2.5 A resistive, 2 A FLA, 12 A LRA, 250 Vac, (30,000 cycles)			
			EN 60730-1	2 A resistive, 2 A inductive, cosφ=0.6, 2(2)A (100,000 cycles)			
Maximum number of SSR outputs	2: outputs 4 and 5; Electrical specifications: working voltage 24 Vac/Vdc, maximum switchable output 10 Watts						

#### Warnings:

- the groups that the digital outputs are divided into have two common pole terminals to simplify wiring
- Make sure that the current running through the common terminals does not exceed the rated current of an individual terminal, that is, 8 A.

- pCO<sup>SS</sup> Mechanical specifications

### Mechanical dimensions

SMALL	13 DIN modules	110 x 227.5 x 60mm
<b>Plastic container</b>		
Assembly	Fitted on DIN rail as per DIN 43880 and IEC EN 50022	
Material	technopolymer	
Flame retardancy	V0 (UL94) and 960°C (IEC 695)	
Ball pressure test	125°C	
Resistance to creeping current	± 250 V	
Colour	Grey RAL7035	

- pCO<sup>SS</sup> other features

Operating conditions	-10T60°C, 90% RH non-condensing (vers. standard) -25T70°C, 90% RH non-condensing (extended range vers.)
Storage conditions	-20T70°C, 90% RH non-condensing (standard vers.) -40T70°C, 90% RH non-condensing (extended range vers.)
Index of protection	IP20, IP40 on the front panel only
Environmental pollution	2
Class according to protection against electric shock	to be integrated into Class 1 and/or 2 appliances
PTI of the insulating materials	250 V
Period of stress across the insulating parts	long
Type of action	1C
Type of disconnection or microswitching	microswitching, for all relay outputs
Category of resistance to heat and fire	Category D
Immunity against voltage surges	Category 1
Ageing characteristics (operating hours)	80,000
No. of automatic operating cycles	100,000 (EN 60730-1); 30,000 (UL 873)
Software class and structure	Class A
Category of immunity to voltage surges (IEC EN 61000-4-5)	Category 3

Clock	clock with battery	standard
	precision	100 ppm
Battery specifications	Lithium button battery, code CR2430, voltage 3 Vdc (dimensions 24x3 mm)	

- pCO<sup>SS</sup> electrical specifications

Power supply	24 Vac +10/-15% 50/60 Hz and 24 to 48Vdc +10/-20%, isolated
Type of insulation of the power supply from the rest of the controller	functional
Maximum current with terminal connected	P=8 W
Terminal block	with male/female plug-in connectors (250 Vac max, 8 A max)
Cable cross-section	min 0.5 mm <sup>2</sup> – max 2.5 mm <sup>2</sup>
CPU	H8S2320, 16 bit, 24 MHz
Program memory (FLASH MEMORY)	1 Mbyte, 16 bit (expandable up to 1+1 Mbyte Dual Bank)
Data memory (RAM)	128 Kbyte, 8 bit (expandable up to 512 Kbyte)
T memory, buffer (FLASH MEMORY)	4 Kbyte, 16 bit
P memory, parameters (EEPROM)	32 Kbyte not available to the pLAN network
Working cycle duration (application of average complexity)	0.3 s
Clock with battery	Optional

### pCO<sup>SS</sup> dimensions (in mm): 8 DIN modules

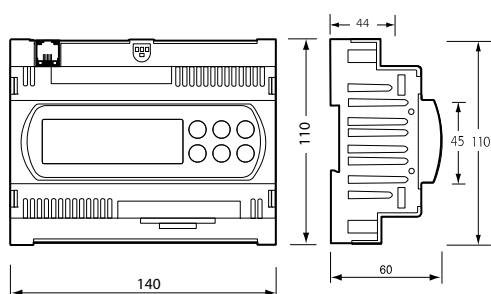

Fig. 2.g

## 2.7 pCO<sup>c</sup> controller

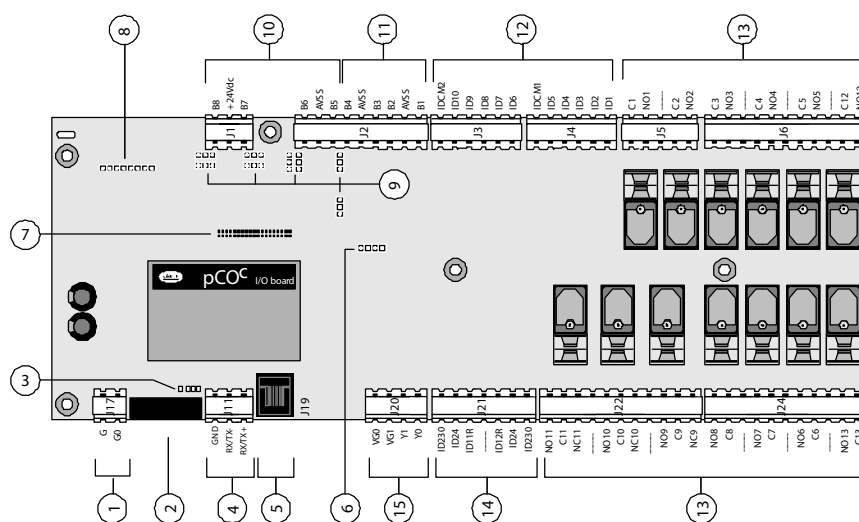

Fig. 2.h

### Key:

- |     |   |
|-----|---|
| 1.  | Connector for 24 Vac power supply, 50/60 Hz, 15 VA, or 24 Vdc, 10 W.                      |
| 2.  | 250 Vac, 2 A slow-blow fuse (T2A).  |
| 3.  | Yellow mains power LED and 3 status LEDs.   |
| 4.  | Connector for connecting the pCOC boards to the pLAN network (see paragraph 6.3).         |
| 5.  | Telephone connector for connecting a user terminal (PCOT*, PCOI*) or local network.       |
| 6.  | Connector for inserting the optional real time clock board PCO100CLK0.                    |
| 7.  | Connector for programming key PCO100KEY0.   |
| 8.  | Connector for inserting the optional supervision and/or telemaintenance boards.           |
| 9.  | Jumpers for selecting the analogue inputs: J14-J3=B5; J15-J10=B6; J28-J11=B7; J29-J12=B8. |
| 10. | Universal analogue inputs: NTC, 0/1V, 0/20 mA, 4/20 mA.                                   |
| 11. | Passive analogue inputs: NTC.   |
| 12. | Digital inputs at 24 Vac/Vdc.   |
| 13. | Relay digital outputs.  |
| 14. | 230 Vac or 24 Vac/Vdc digital inputs.   |
| 15. | 0 to 10 V analogue outputs.   |

### 2.7.1 Meaning of the pCO<sup>c</sup> board inputs/outputs

connector	signals	description
J17	G	power supply, +24 Vdc, 10 W or 24 Vac, 50/60 Hz, 15 VA
J17	G0	power supply reference
J11	RX+/TX+	RX+/TX+ connector for RS485 connection to the pLAN network - Note: different pin conf. from the pCO <sup>3</sup> /pCO <sup>s</sup> and pCO <sup>1</sup>
J11	RX-/TX-	RX-/TX- connector for RS485 connection to the pLAN network - Note: different pin conf. from the pCO <sup>3</sup> /pCO <sup>s</sup> and pCO <sup>1</sup>
J11	GND	GND connector for RS485 connection to the pLAN network
J19	Terminal	connector for terminal 6-pin telephone cable
J20	VG0	power to optically-isolated analogue output, 0 Vac
J20	VG1	power to optically-isolated analogue output, 24 Vac/Vdc
J20	Y1	analogue output 2
J20	Y0	analogue output 1
J21	ID230 Vac	digital input 11, 230 Vac
J21	ID24 Vac	digital input 11, 24 Vac/Vdc
J21	ID11R	common for digital input 11
J21	----	not connected
J21	ID12R	common for digital input 12
J21	ID24 Vac	digital input 12, 24 Vac/Vdc
J21	ID230 Vac	digital input 12, 230 Vac
J22	NO-11	normally open contact, relay 11
J22	C-11	common for relay 11
J22	NC-11	normally dosed contact, relay 11
J22	----	not connected
J22	NO-10	normally open contact, relay 10
J22	C10	common for relay 10
J22	NC-10	normally dosed contact, relay 10

J22	----	not connected
J22	NO-9	normally open contact, relay 9
J22	C9	common for relay 9
J22	NC-9	normally closed contact, relay 9
J24	NO-8	normally open contact, relay 8
J24	C8	common for relay 8
J24	----	not connected
J24	NO-7	normally open contact, relay 7
J24	C7	common for relay 7
J24	----	not connected
J24	NO-6	normally open contact, relay 6
J24	C6	common for relay 6
J24	----	not connected
J24	NO-13	normally open contact, relay 13
J24	C13	common for relay 13
J6	NO-12	normally open contact, relay 12
J6	C12	common for relay 12
J6	----	not connected
J6	NO-5	normally open contact, relay 5
J6	C5	common for relay 5
J6	----	not connected
J6	NO-4	normally open contact, relay 4
J6	C4	common for relay 4
J6	----	not connected
J6	NO-3	normally open contact, relay 3
J6	C3	common for relay 3
J5	NO-2	normally open contact, relay 2
J5	C2	common for relay 2
J5	----	not connected
J5	NO-1	normally open contact, relay 1
J5	C1	common for relay 1
J4	ID1	digital input 1
J4	ID2	digital input 2
J4	ID3	digital input 3
J4	ID4	digital input 4
J4	ID5	digital input 5
J4	IDCM1	common for digital inputs ID1-ID5
J3	ID6	digital input 6
J3	ID7	digital input 7
J3	ID8	digital input 8
J3	ID9	digital input 9
J3	ID10	digital input 10
J3	IDCM2	common for digital inputs ID6-ID10
J2	B1	analogue input 1 (NTC probe only)
J2	AVSS	common for analogue inputs
J2	B2	analogue input 2 (NTC probe only)
J2	B3	analogue input 3 (NTC probe only)
J2	AVSS	common for analogue inputs
J2	B4	analogue input 4 (NTC probe only)
J2	B5	analogue input 5 (active probe, 0/1 V or 4/20 mA or NTC)
J2	AVSS	common for analogue inputs
J2	B6	analogue input 6 (NTC, active probe, 0/1V or 4/20 mA)
J1	B7	analogue input 7 (NTC, active probe, 0/1V or 4/20 mA)
J1	+24 Vdc	24 Vdc power supply for external active probes (max. current 100 mA)
J1	B8	analogue input 8 (NTC, active probe, 0/1V or 4/20 mA)

## 2.8 pCO<sup>c</sup> technical specifications

### • pCO<sup>c</sup> analogue inputs

Analogue conversion	10-bit A/D converter embedded in CPU
Maximum number	8
Type	<i>Universal</i> : 4 (inputs B5, B6, B7, B8) -Carel NTC (-50T90°C; R/T 10KΩ at 25°C) -Voltage 0 to 1 V -Current 0 to 20 mA or 4 to 20 mA. Input resistance 100Ω Can be selected by jumper. <i>Passive</i> : 4 (inputs B1, B2, B3, B4) -Carel NTC (-50T90°C; R/T 10KΩ at 25°C)
Settling time	2 s
Input precision NTC	± 0.5 °C
Input precision 0-1V	± 3 mV
Input precision 0-20 mA	± 0.06 mA

**Warning:** for the power supply of any active probes, the 24 Vdc available at the +Vdc terminal (J1) can be used. The maximum current is 100 mA, protected against short-circuits.

On the pCO<sup>c</sup>, unlike the pCO<sup>b</sup>, the 0/1 Vdc signal is limited to the restricted 0-1 V range and therefore is not always compatible with the standard 10 mV/°C signal of the Carel probes (for temperatures below 0°C and above 100°C, a probe alarm may be generated). For the temperature signals, use 4/20 mA or NTC. This is also true for the pCO<sup>3</sup>, pCO<sup>1</sup> and pCO<sup>5</sup>.

### • pCO<sup>c</sup> digital inputs

Type	optically-isolated			
Maximum number		no. optically-isolated inputs at 24 Vac 50/60 Hz or 24Vdc	no. optically-isolated inputs at 24 Vac/Vdc or 230 Vac 50/60 Hz	Total
		10	2	12
Minimum digital input pulse detection time	Normally open (open-closed-open)		200 ms	
	Normally closed (closed-open-closed)		400 ms	
Power supply to the inputs	external	230 Vac or 24 Vac (50/60 Hz)	+10/-15%	
		24Vdc	+10/-20%	

#### Warnings:

- the two 230 Vac or 24 Vac/Vdc inputs at terminals J21 have the same common pole and consequently both must be set to the same voltage (230 Vac or 24 Vac/Vdc). There is primary insulation between the two inputs;
- for DC voltage inputs (24Vdc) connect the negative pole to the common terminal

### • pCO<sup>c</sup> analogue outputs

Type	optically-isolated	
Maximum number	2 outputs (Y1 and Y2), 0 to 10 Vdc	
Power supply	external	24 Vac/Vdc
Precision	outputs Y1-Y2	± 1% of full scale
Resolution	0.5%	
Settling time	outputs Y1-Y2	2s
Maximum load	1 kΩ (10mA)	

**Note:** unlike the pCO<sup>b</sup>, outputs Y1 and Y2 are not linked to digital outputs 12 and 13.

### • pCO<sup>c</sup> digital outputs

Insulation distance	The relay outputs have different features depending on the model of PCO <sup>c</sup> . The outputs can be divided into groups. There is double insulation between the groups (cells in the table) and consequently these may have different voltages. There is also double insulation between each terminal of the digital outputs and the rest of the controller. The relays belonging to the same group (individual cells in the table) have basic insulation and can therefore have the same power supply (24 Vac or 230 Vac).							
Makeup of the groups	Version	Reference of the relays with the same insulation						
		Group 1	Group 2	Group 3	Group 4	Group 5	Group 6	Group 7
	-	1 to 2	3 to 5, 12	6 to 8, 13	9 to 11			
	Type of relay	Type A	Type A	Type A	Type A			
Number of changeover contacts	3: outputs 9, 10 and 11							
Switchable power	Relay type A	Relay ratings	SPDT, 2000 VA, 250 Vac, 8 A resistive					
		pCO <sup>c</sup> approval	UL873	2.5 A resistive, 2 A FLA, 12 A LRA, 250 Vac (30,000 cycles)				
			EN 60730-1	2 A resistive, 2 A inductive, cosφ=0.6, 2(2)A (100,000 cycles)				
Maximum number of SSR outputs	-							

#### Warnings:

- The groups that the digital outputs are divided into have two common pole terminals to simplify wiring.
- Make sure that the current running through the common terminals does not exceed the rated current of an individual terminal, that is, 8 A.



• pCO<sup>c</sup> mechanical specifications

Mechanical dimensions

Electronic board only available, without plastic case: 108 x 292 x 25mm

• pCO<sup>c</sup> other features

Operating conditions	-10T60°C, 90% RH non-condensing	
Storage conditions	-20T70°C, 90% RH non-condensing	
Index of protection	IP20	
Environmental pollution	2	
Class according to protection against electric shock	to be integrated into Class 1 and/or 2 appliances	
PTI of the insulating materials	250 V	
Period of stress across the insulating parts	long	
Type of action	1C	
Type of disconnection or microswitching	microswitching, for all relay outputs	
Category of resistance to heat and fire	Category D	
Immunity against voltage surges	Category 1	
Ageing characteristics (operating hours)	80,000	
No. of automatic operating cycles	100,000 (EN 60730-1); 30,000 (UL 873)	
Software class and structure	Class A	
Category of immunity to voltage surges (IEC EN 61000-4-5)	Category 3	
Clock	clock with battery	standard
	precision	100 ppm
	Battery specifications	Lithium button battery, code CR2430, voltage 3 Vdc (dimensions 24x3 mm)

• pCO<sup>c</sup> electrical specifications

Power supply	24 Vac +10/-15% 50/60 Hz and 22 to 38Vdc +10/-20%
Maximum current with terminal connected	P=10 W
Type of insulation of the power supply from the rest of the controller	-
Terminal block	with male/female plug-in connectors (250 Vac max, 8 A max)
Cable cross-section	min 0.5 mm <sup>2</sup> – max 2.5 mm <sup>2</sup>
CPU	H8S2320, 16 bit, 14MHz
Program memory (FLASH MEMORY)	1 Mbyte, 16 bit
Data memory (RAM)	128 Kbyte, 8 bit
T memory, buffer (FLASH MEMORY)	4 Kbyte, 16 bit
P memory, parameters (EEPROM)	optional (32 Kbyte not available to the pLAN network)
Working cycle duration (application of average complexity)	0.5 s
Clock with battery	optional

• Procedure for selecting the analogue inputs by jumpers J3, J10, J11, J12, J14, J15, J28 and J29

Input B5, B6, B7 and B8:

	J14, J15, J28 and J29	
	1-2	2-3
J3, J10, J11 and J12	1-2	4÷20 mA (default)
	2-3	0÷1V
		NTC

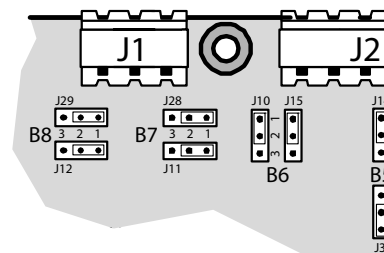

• pCO<sup>c</sup> dimensions ( in mm)

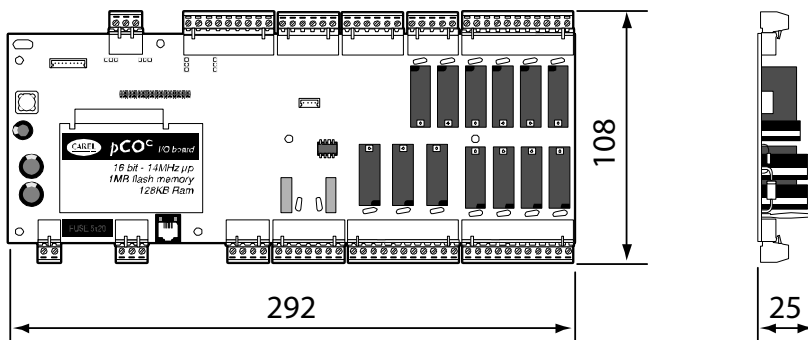

Fig. 2.h

Model	PCO3*S	PCO3*M	PCO3*L	PCO3*XL	PCO3*XL	PCO1*S	PCO1*M	PCO1*X	PCOC*
Maximum flash memory capacity	4 MB	4 MB	4 MB	4 MB	4 MB	2 MB	2 MB	2 MB	1 MB
NAND Flash	■	■	■	■	■				
Real Time Clock	●	●	●	●	●	■	■	■	■
pLAN	●	●	●	●	●	●	●	●	●
Opto-isolated pLAN	■	■	■	■	■				
tLAN	■	■	■	■	■	■	■	●	■
Accepts SMART KEY	●	●	●	●	●	●	●	●	●
PGD <sup>o</sup> built-in display	■	■	■	■	■				
PGD <sup>i</sup> built-in display	■	■	■	■	■				
4x20 built-in display								■	
LED display	■	■	■	■	■				
Serial port for I/O expansion	■	■	■	■	■	■	■	■	
Black box	●	●	●	●	●	■	■	■	
CAREL protocol	●	●	●	●	●	●	●	●	●
Metasys <sup>®</sup> compatible	●	●	●	●	●	●	●	●	●
Modbus <sup>®</sup> RTU protocol	●	●	●	●	●	●	●	●	●
LonWorks <sup>®</sup> protocol	■	■	■	■	■	■	■	■	■
BACnet™ Ethernet™ protocol	■	■	■	■	■	■	■	■	■
BACnet™ MS/TP protocol	■	■	■	■	■	■	■	■	■
HTTP/FTP/SNMP protocol	■	■	■	■	■	■	■	■	■
CANbus protocol	■	■	■	■	■	■	■	■	
Belimo MP-BUS	■	■	■	■	■	■	■	●	
Ready for modem, GSM modem, SMS	●	●	●	●	●	●	●	●	●
Max no. of analogue inputs	5	8	10	8	10	6	8	4	8
PT1000 inputs	2	2	4	2	4				
0 to 10 Vdc inputs	3	6	6	6	6				
0 to 1 Vdc inputs	3	6	6	6	6	4	4	2	4
4 to 20 mA or 0 to 20 mA inputs	3	6	6	6	6	4	4	2	4
NTC inputs	5	8	10	8	10	6	8	4	8
0 to 5 Vdc ratiometric inputs	3	6	6	6	6	4	4	4	
AIN selected via software	●	●	●	●	●			●	
AIN selected via dipswitch						●	●		●
Max no. of digital inputs	8	14	18	14	14	8	14	6	12
24 Vac/dc inputs	8	14	18	14	14	8	14		12
230 Vac/dc inputs		2	4	2	2	8	2		2
Inputs with voltage-free contacts	2	2	4	2	4	2	2	6	
Max no. of analogue outputs	4	4	6	4	4	4	4	3	2
0 to 10 Vdc outputs	4	4	6	4	4	2	2	2	2
PWM outputs (phase cutting)						2	2	1	
Max no. of digital outputs	8	13	18	29	27	8	13	5	13
SPST relay outputs	7	10	13	26	24	7	10	4	10
SPDT relay outputs	1	3	5	3	3	1	3	1	3
SPDT relay outputs SSR outputs	2	4	6	6	6	2	4	2	
48 Vdc power supply	■	■	■	■	■	■	■	●	■

- Standard
- Optional

## 3. USER TERMINALS

There are various types of user terminals, which differ in terms of:

- dimensions;
- liquid crystal display (LCD);
- number of buttons;
- number of LEDs;

### 3.1 pGD0/pGD1, pGD2/pGD3 graphic terminals

#### 3.1.1 pGD0 and pGD1 graphic displays

These are terminals, compatible with the previous PCOI/PCOT, which ensure complete management of the graphics by displaying icons (defined during the development of the application program) and the management of international fonts in two sizes: 5x7 and 11x15 pixels. The terminal does not require any additional software.

pGD0: is a monochromatic LCD graphic terminal with 120x32 pixel resolution and LED backlighting;

pGD1: is a monochromatic LCD graphic terminal with 132x64 pixel resolution and LED backlighting.

Version	PGD	Model codes	Instruction sheet
Built-in or panel version	PGD0	PGD0000F00	+050001040
Wall-mounted version	PGD0	PGD0000W00	
Built-in or panel version	PGD1	PGD1000F00	+050001050
Wall-mounted version	PGD1	PGD1000W00	
Built-in or panel version – white backlighting	PGD1	PGD1000FW0	+050001050
Built-in or panel version - white backlighting with buzzer	PGD1	PGD1000FX0	+050001050
Wall-mounted version – white backlighting	PGD1	PGD1000WW0	
Wall-mounted version- white backlighting with buzzer	PGD1	PGD1000WX0	
Panel installation	PGD0	PGD0000I00	+050001045
Panel installation (in PCOI case)	PGD1	PGD1000I00	+050001055
Panel installation - white backlighting (in PCOI case)	PGD1	PGD1000IW0	

Tab. 3.a

#### 3.1.2 pGD2 and pGD3 graphic displays

These are electronic devices designed as the user interface for the pCO family controllers (contact CAREL to find out the most suitable controller that supports the PGD2/3 for the specific application).

pGD<sup>2</sup> is a monochromatic (blue/white) LCD graphic terminal with 320x240 pixel resolution (code PGD2\*\*\*\*\*) and LED backlighting.

pGD<sup>3</sup> is a 256-colour LCD graphic terminal with 320x240 pixel resolution (code PGD3\*\*\*\*\*) and CCFL fluorescent backlighting.

Version	PGD	Model codes	Instruction sheet
Panel installation	PGD2	PGD200*F0*	+050001041
Wall-mounting	PGD2	PGD200*W0*	
Panel installation	PGD3	PGD300*F0*	
Wall-mounting	PGD3	PGD300*W0*	

Tab. 3.b

#### 3.1.3 PGD0000F00 terminal (built-in/panel)/PGD0000W00 pCO graphic display (wall)



Fig. 3.a

##### Display

Type:	FSTN graphic
Backlighting:	green LEDs (managed by "application program")
Graphic resolution:	120x32 pixels
Text modes:	4 rows x 20 columns (5x7 and 11x15 pixel fonts) 2 rows x 10 columns (11x15 pixel fonts) or mixed modes
Character height:	4.5 mm (5x7 pixel fonts) 9 mm (11x15 pixel fonts)
Size of the active area:	71.95x20.75 mm
Size of the display area:	76x25.2 mm

##### LEDs on keypad

- 2 programmable by "application program", red and orange (Prg and Alarm buttons);
- 4 green, for backlighting the LCD (↑ ↓ Enter and Esc buttons).

##### Power supply

Voltage: power supply from pCO via telephone connector or from external source  
18/30 Vdc protected by 250 mA external fuse.

Maximum power input: 0.8 W.

### 3.1.4 PGD1000F00 (built-in/panel) / PGD1000W00 pCO graphic display (wall)



Fig. 3.b

#### Display

Type: FSTN graphic  
 Backlighting: green or white LEDs (managed by "application program")  
 Graphic resolution: 132x64 pixel  
 Text modes: 8 rows x 22 columns (5x7 and 11x15 pixel fonts)  
 4 rows x 11 columns (11x15 pixel fonts)  
 or mixed modes

Character height: 3.5 mm (5x7 pixel fonts)  
 7.5 mm (11x15 pixel fonts)

Size of the active area: 66x32 mm

Size of the display area: 72x36 mm

#### LEDs on keypad

2 programmable by "application program", red and orange (Prg and Alarm buttons);

4 green, for backlighting the LCD (↑ ↓ Enter and Esc buttons).

#### Power supply

Voltage: power supply from pCO via telephone connector or from external source, 18/30 Vdc protected by 250 mA external fuse.

Maximum power input: 1.2 W

### 3.1.5 PGD0000I00 pCO graphic display (panel installation)



Fig. 3.c

#### Display

Type: FSTN graphic  
 Backlighting: green LEDs (managed by "application program")  
 Graphic resolution: 120x32 pixels  
 Text modes: 4 rows x 20 columns (5x7 and 11x15 pixel fonts)  
 2 rows x 10 columns (11x15 pixel fonts)  
 or mixed modes

Character height: 4.5 mm (5x7 pixel fonts)

9 mm (11x15 pixel fonts)

Size of the active area: 71.95x20.75 mm

Size of the display area: 76x25.2 mm

#### Keypad

15 buttons, the "ESC" button is replaced by the "MENU" button

#### Power supply

Voltage: power supply from pCO via telephone connector or from external source, 18/30 Vdc protected by external 250 mA fuse.

Maximum power input: 1.5 W

### 3.1.6 PGD1000I00 pCO graphic display (panel installation)



Fig. 3.d

#### Display

Type: FSTN graphic  
 Backlighting: green LEDs (managed by "application program")  
 Graphic resolution: 132x64 pixel  
 Text modes: 8 rows x 22 columns (5x7 and 11x15 pixel fonts)  
 4 rows x 11 columns (11x15 pixel fonts)  
 or mixed modes

Character height: 3.5 mm (5x7 pixel fonts)

7.5 mm (11x15 pixel fonts)

Size of the active area: 66x32 mm

Size of the display area: 72x36 mm

#### Keypad

15 buttons, the "ESC" button is replaced by the "MENU" button

#### Power supply

Voltage: power supply from pCO via telephone connector or from external source, 18/30 Vdc protected by external 250 mA fuse

Maximum power input: 1.8 W.

### 3.1.7 pGD2/3 - pCO graphic display



Fig. 3.e

#### Versions:

- Panel installation (code PGD\*00\*F0\*)
- Wall-mounting (code PGD\*00\*W0\*)

#### pGD<sup>2</sup>

- LCD colours: monochromatic (blue/white)
- resolution: 320x240 pixels
- backlighting: by LED.

#### pGD<sup>3</sup>

- LCD colours: 256 colours
- resolution: 320x240 pixel
- backlighting: by CCFL fluorescent light.
- protocols supported: pLAN protocol, "Local terminal" protocol (text mode only)
- LEDs: 2 controlled by application

#### Configuration:

pGD 2/3 is configured in the factory for the most common user requirements, nonetheless some settings can be changed to adapt it to specific needs.

#### Updating the firmware:

The firmware of the pGD2/3 terminal can be updated when new versions become available, using the "Display Firmware Update" function accessible from the "General Options" menu.

#### Power supply:

- power supply: 24 Vac  $\pm$  15%, 50/60 Hz or 30 Vdc  $\pm$  25%
- rated power: 10 W
- Use a class 2 safety transformer with a minimum rating of 15 VA.

### 3.1.8 Built-in display

The pCO<sup>KS</sup> and pCO<sup>3</sup> feature versions with a Built-In terminal: the display and keypad are incorporated directly into the plastic case. It is available for the pCO<sup>3</sup> specifically, a graphic LCD and in all versions (SMALL, MEDIUM, LARGE, EXTRALARGE NO, EXTRALARGE NC). The built-in terminal on the pCO<sup>KS</sup> does not have a graphic display.

#### Features

codes	PCO3000*S0, PCO3000*M0, PCO3000*L0, PCO3000*Z0, PCO3000*CO * = B, D, H	PCO3000*S0, PCO3000*M0, PCO3000*L0, PCO3000*Z0, PCO3000*CO * = E, F, I	PCO1000*S0 * = B, D
LCD	4x20, backlit (pGD0)	8x22, backlit (pGD1)	4x20, backlit
number of buttons	6	6	6
number of LEDs	4	4	4

Tab. 3.c

These versions with integrated LCD and keypad also support connection to all the pCO series terminals (the two displays, built-in and standard, work at the same time, displaying the same information).

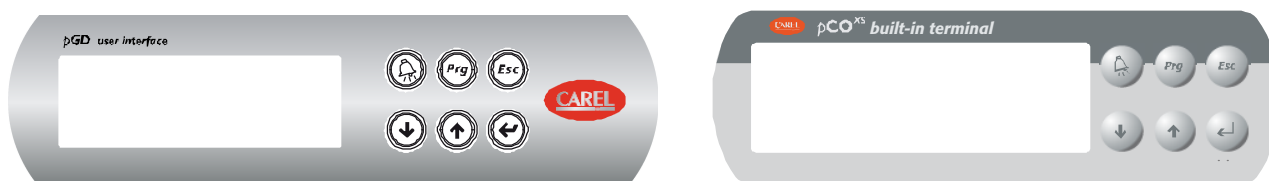

Fig. 3.f

The display contrast can be adjusted on this version of the terminal.

To do this :

1. press the Enter and Esc buttons together;
2. holding the two buttons, use UP or Down to adjust the contrast as required (increase or decrease respectively).

### 3.1.9 Connecting the user terminal to the pCO

The typical connection between the pGD terminal and the pCO is made using a 6-wire telephone cable supplied by Carel (code S90CONN00\*). To make the connection simply plug the cable into the 6-pin connector on the pCO (J10 for pCO3 and pCO1, J5 for pCO<sup>KS</sup>, J19 pCOC), so that it clicks into place. To remove the connector, lightly press the plastic tab and pull out the cable. The telephone connector provides both the data link and the power supply to the terminal, and is the simplest connection method; in more complex configurations, where more than one terminal is connected to the pCO or to cover lengths in excess of 50 m, a twisted-pair cable with shield is required (see the diagrams in chap. 5).

**!** Shielded cable must also be used if the pCO is installed in domestic or similar environments, and consequently subject to the requirements of IEC EN 55014-1 of 04/98) – (see paragraph 5.7).

When developing a pLAN network of pCO controllers and terminals, always remember that a pCO can only supply power to one pGD0/1 or old pCOT/1 terminal. If it is necessary to manage more than one terminal or the pGD2/3 versions, an independent power supply is required (see the diagrams in chap. 5). The DC voltage at Vterm (J24 for pCO<sup>3</sup>, J9 for pCO<sup>1</sup>) can supply an ARIA or PLD terminal with a maximum power input of 2 W. The pCO can operate perfectly without the terminal connected.

### 3.1.10 Maximum distance

The maximum distances between the pCO and the user terminal are shown in the following table.

type of cable	power supply distance	power supply
telephone	50 m	taken from pCO (150 mA)
AWG24 shielded cable	200 m	taken from pCO (150 mA)
AWG20/22 shielded cable	500 m	separate power supply via TCONN6J000

Tab. 3.d

The maximum distance between two pCO controllers with AWG20/22 shielded twisted pair cables is 500 m. When developing the network, use a bus layout with branches that do not exceed 5 m. For further information, see Chapter 5.

### User terminal/interface connection cables

length (m)	type	code
0.8	telephone connectors	S90CONN002
1.5	telephone connectors	S90CONN000
3	telephone connectors	S90CONN001
6	telephone connectors	S90CONN003

Tab. 3.e

### 3.1.11 Dimensioni display (in mm)

#### Remote terminal installation

accessories for electrical connections	code
board for remote terminal installation	TCONN6J000

#### Dimensions: PGD0/1

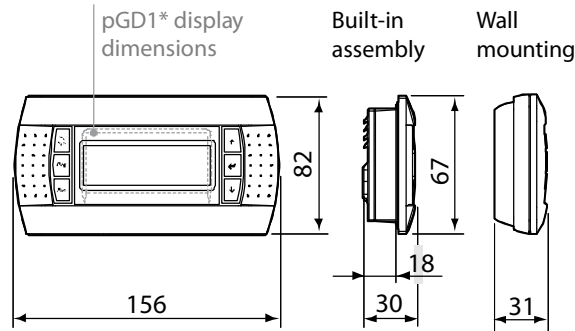

Fig. 3.g

#### Dimensions: PGD2/3

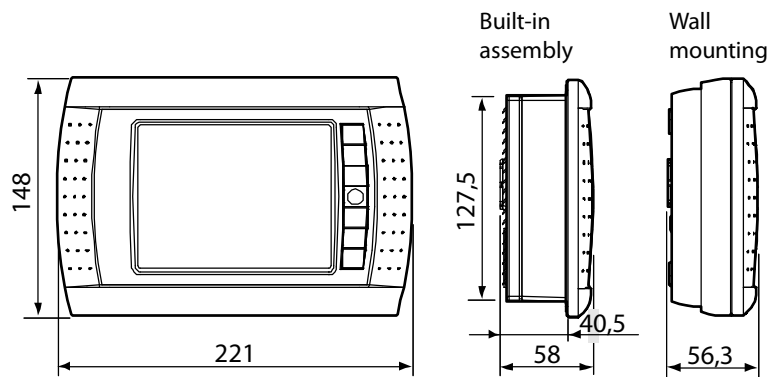

Fig. 3.h

#### Dimensions: PGDI

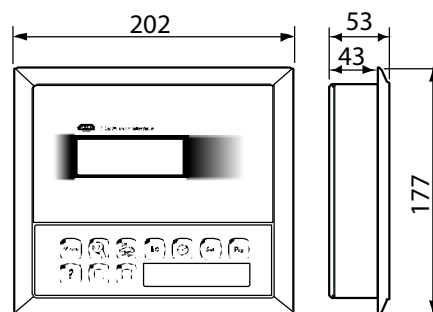

Fig. 3.i

## 4. INSTALLING THE pCO CONTROLLER

### 4.1 General installation instructions

#### 4.1.1 Installation procedure



##### **Environmental conditions**

Avoid assembling the pCO and the terminal in environments with the following situations:

- temperature and humidity that do not conform to the rated operating data of the product;
- strong vibrations or knocks;
- exposure to aggressive and polluting atmospheres (e.g.: sulphur and ammonia fumes, saline mist, smoke) so as to avoid corrosion and/or oxidation;
- strong magnetic and/or radio frequency interference (there avoid installing the units near transmitting antennae);
- exposure of the pCO to direct sunlight and to the elements in general;
- large and rapid fluctuations in the room temperature;
- environments containing explosives or mixes of flammable gases;
- exposure to dust (formation of corrosive patina with possible oxidation and reduction of insulation).

##### **Positioning the instrument inside the panel**

The instrument must be positioned inside the electrical cabinet so as to guarantee sufficient physical separation of the instrument from the power components (solenoids, contactors, inverters, ...) and the cables connected to these. Proximity to such devices may cause random malfunctions that are not immediately evident.

The panel must feature good ventilation for cooling.

#### 4.1.2 Wiring procedure



When laying the wires, "physically" separate the power from the control section. The proximity of the wiring of these two sections will, in most cases, cause problems of induced disturbance or, over time, malfunctions or damage to the components. The ideal condition involves running the two circuits in two separate cabinets. Sometimes, however, this is not possible, and consequently the power section and the control section need to be placed in two separate areas inside the same panel. For the control signals, use shielded cables with twisted wires.

If the control cables need to cross over the power cables, the point of crossing should have angles of intersection as near as possible to 90 degrees; never run the control cables parallel to the power cables.

CAREL suggests to pay attention to the following warnings:

- Use cable ends suitable for the corresponding terminals. Loosen each screw and insert the cable ends, then tighten the screws. When the operation is completed, slightly tug the cables to check they are sufficiently tight;
- separate as much as possible the probe and digital input signal cables from the cables carrying inductive loads and power cables to avoid possible electromagnetic disturbance. Never insert power cables (including the electrical cables) and probe signal cables in the same conduits. Do not install the probe cables in the immediate vicinity of power devices (contactors, circuit breakers or similar);
- reduce the path of the probe cables as much as possible, and avoid spiral paths that enclose power devices;
- avoid touching or nearly touching the electronic components fitted on the boards, so as to avoid electrostatic discharges (extremely dangerous) from the operator to the components;
- if the power transformer secondary is earthed, check that the earth wire corresponds to the wire that runs to the controller and enters terminal G0; this must be followed for all devices connected to the pCO;
- when fastening the cables to the terminals, do not push the screwdriver with excessive force, so as to avoid damaging the pCO;
- for applications subject to considerable vibrations (1.5 mm pk-pk 10/55 Hz), secure the cables connected to the pCO around 3 cm from the connectors using clamps;
- if the product is installed in industrial environments (application of the EN 61000-6-2 standard), the length of the connections must be less than 30m;
- all the very low voltage connections (analogue and digital inputs at 24 Vac/24Vdc, analogue outputs, serial bus connections, power) must have reinforced or double insulation from the mains;
- in residential environments, the connection cable between the pCO and the terminal must be shielded.
- there is no limit to the number of wires that can be connected to an individual terminal. The only limit concerns the maximum current running through the terminal: this must not exceed 8 A;
- the maximum cross-section of the wires connected to the terminals is 2.5 mm<sup>2</sup> (12 AWG);
- the maximum value of the twisting moment (or torque) for tightening the screws on the terminal (tightening torque) is 0.6 Nm.

#### 4.1.3 Warnings



- Installation must be performed according to the standards and legislation in force in the country where the appliance is used;
- for safety reasons, the appliance must be housed inside an electrical panel, so that the only accessible part is the display and the keypad;
- in the event of malfunctions, do not attempt to repair the appliance, but deliver the item directly to CAREL;

#### 4.1.4 Anchoring the pCO

The pCO should be installed on a DIN rail. To secure the controller to the DIN rail, simply rest the device on the rail and press lightly. The rear tabs click into place to fasten the device to the rail. To remove the device, use a screwdriver as a lever in the corresponding opening to lift the locking tabs. The tabs are held in the locked position by return springs.

## 4.2 Power supply

Power supply to the pCO<sup>3</sup>, pCO<sup>1</sup> and pCO<sup>c</sup> (controller with terminal connected): 28 to 36 Vdc +10/-20% or 24 Vac +10/-15% 50 to 60 Hz;  
Maximum current P= 15 W (Vdc power supply), P= 40 VA (Vac)

Power supply to the pCO<sup>s</sup>: 20/60 Vdc or 24 Vac ± 15% 50 to 60 Hz.  
Maximum current P=6.1 W (Vdc), P=8 VA (Vac)

- power supplies other than those specified may seriously damage the system;
- use a Class 2 safety transformer, rated to 50 VA in the installation to supply just one pCO<sup>3</sup>, pCO<sup>1</sup> and pCO<sup>c</sup> controller; for pCO<sup>s</sup> controller is used a same transformer of 25VA.
- separate the power supply to the pCO controller and the terminal (or multiple pCO controllers and terminals) from the power supply to the other electrical devices (contactors and other electromechanical components) inside the electrical panel;
- if the power transformer secondary is earthed, check that the earth wire is connected to terminal G0; this must be followed for all devices connected to the pCO;
- if more than one pCO board is connected in pLAN network, **make sure that G and G0 are always connected in the same way (G0 must be the reference for all the boards);**
- a yellow LED indicates when the pCO is powered.

## 4.3 Connecting the analogue inputs

The analogue inputs on the pCO can be configured for the most commonly used sensors on the market: NTC, PT1000, 0 to 1 V, 0 to 5 V ratiometric, 0 to 10 V, 0 to 20 mA, 4 to 20 mA. The type of sensor can be selected by setting a parameter on the user terminal (if featured by the application program) and from hardware selection for pCO<sup>1</sup> or pCO<sup>c</sup>

### 4.3.1 Connecting active temperature and humidity probes

The pCO can be connected to all CAREL AS\*2 series active temperature and humidity probes configured with 0 to 1 V or 4 to 20 mA signals. For the temperature probes, use the 4 to 20 mA or NTC configuration, as the 0/1 Vdc signal is limited to the restricted 0-1 V range and therefore is not always compatible with the standard 10 mV/°C signal of the CAREL probes (for temperatures below 0°C and above 100°C, a probe alarm may be generated). The inputs must be configured for 0 to 1 V or 4 to 20 mA signals by the application program resident in flash memory. The connection diagram is shown below:

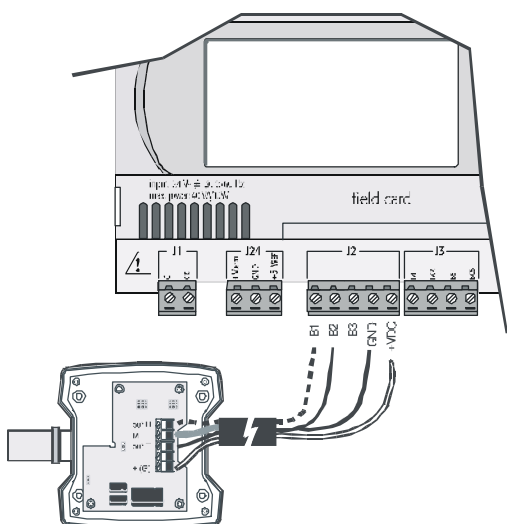

Fig. 4.a

Controller	pCO terminals	Probe terminals	Description
pCO <sup>3</sup>	GND	M	Reference
	+Vdc	+(G)	Power supply
	B1, B2, B3, B6, B7, B8	out H	Active humidity output
	B1, B2, B3, B6, B7, B8	out T	Active temperature output
pCO <sup>1</sup>	GND	M	Reference
	+Vdc	+(G)	Power supply
	B1, B2, B3, B4	out H	Active humidity output
	B1, B2, B3, B4	out T	Active temperature output
pCO <sup>s</sup>	GND	M	Reference
	+24Vdc	+(G)	Power supply
	B1, B2	out H	Active humidity output
	B1, B2	out T	Active temperature output
pCO <sup>c</sup>	GND	M	Reference
	+24Vdc	+(G)	Power supply
	B5, B6, B7, B8	out H	Active humidity output
	B5, B6, B7, B8	out T	Active temperature output

### 4.3.2 Connecting universal NTC temperature probes

All the analogue inputs are compatible with 2-wire NTC sensors. The inputs must be configured for NTC signals by the application program resident in flash memory. The connection diagram is shown below:

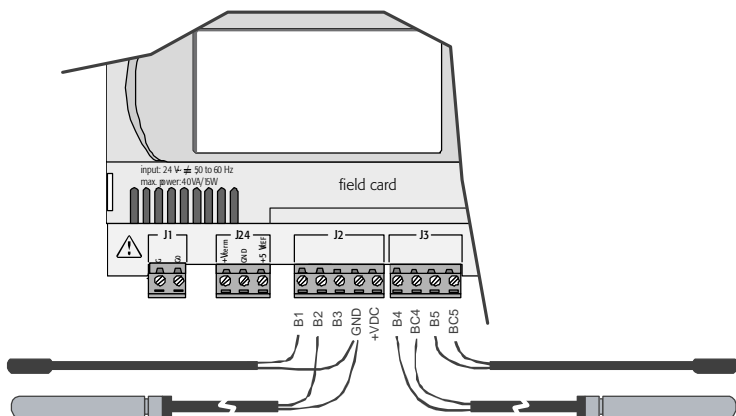

Fig. 4.b

Controller	pCO terminals	NTC probe wire
pCO <sup>3</sup>	GND, BC4, BC5, BC9, BC10	1
	B1, B2, B3, B4, B5, B6, B7, B8, B9, B10	2
pCO <sup>s</sup>	GND	1
	B1, B2, B3, B4,	2
pCO <sup>1</sup>	GND	1
	B1, B2, B3, B4, B5, B6, B7, B8	2
pCO <sup>c</sup>	AVSS	1
	B1, B2, B3, B4, B5, B6, B7, B8	2

Tab. 4.b

**Warning:** the two NTC probe wires are equivalent, as there is no polarity, therefore no special order needs to be followed when connecting to the terminal block.



### 4.3.3 Connecting PT1000 temperature probes

The pCO can be connected to 2-wire PT1000 sensors for all high temperature applications; the operating range is: -100 to 200 °C.

The inputs must be configured for PT1000 signals by the application program resident in flash memory.

The connection diagram is shown below:

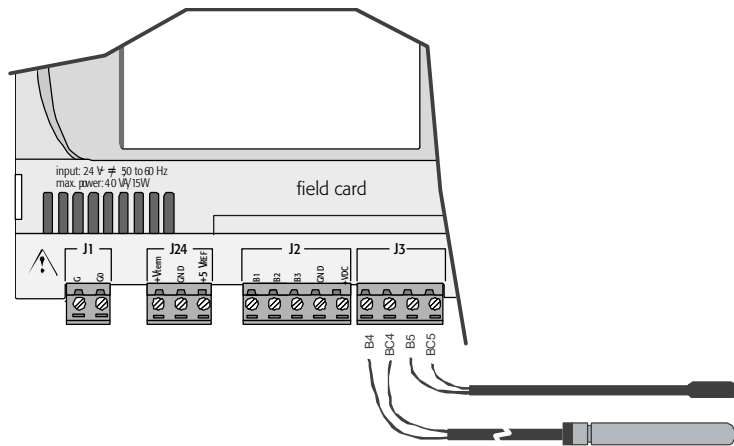

Fig. 4.c

Cont.					PT1000 probe wire
pCO <sup>3</sup>	probe 1	probe 2	probe 3	probe 4	
	BC4	BC5	BC9	BC10	1
	B4	B5	B9	B10	2
pCO <sup>5</sup>					not available
pCO <sup>1</sup>					not available
pCO <sup>c</sup>					not available

Tab. 4.c

#### Warnings:

- to ensure a correct measurement by the PT1000 sensor, each sensor wire must be connected to a separate terminal, as shown in Figure 4.c;
- the two PT1000 probe wires are equivalent, as there is no polarity, therefore no special order needs to be followed when connecting to the terminal block.

### 4.3.4 Connecting pressure probes with current signal

The pCO can be connected to all CAREL SPK\* series active pressure probes or any pressure sensor available on the market with a 0 to 20 mA or 4 to 20 mA signal.

The inputs must be configured for 0 to 20 mA or 4 to 20 mA signals by the application program resident in flash memory.

The connection diagram is shown below:

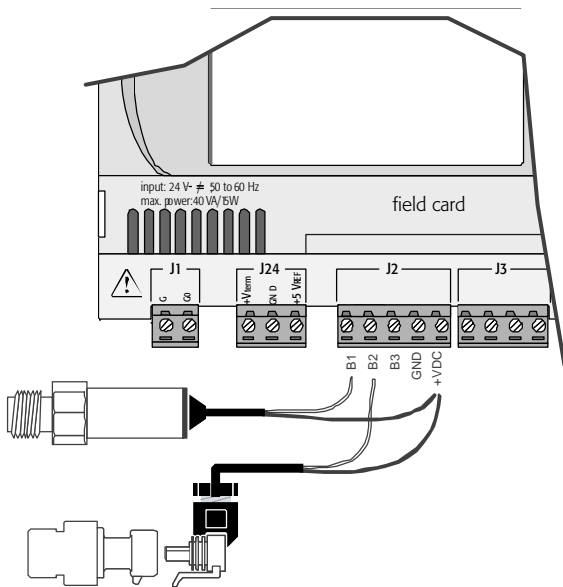

Fig. 4.d

Controller	pCO terminals	Probe wire colour	Description
pCO <sup>3</sup>	+Vdc	brown	power supply
	B1, B2, B3 B6, B7, B8	white	signal
pCO <sup>5</sup>	+Vdc	brown	power supply
	B1, B2,	white	signal
pCO <sup>1</sup>	+Vdc	brown	power supply
	B1, B2, B3, B4	white	signal
pCO <sup>c</sup>	+Vdc	brown	power supply
	B5, B6, B7, B8	white	signal

Tab. 4.d

### 4.3.5 Connecting 0/5 V ratiometric pressure probes

The pCO can be connected to all CAREL SPKT series active pressure probes or any pressure sensor available on the market with 0/5 V ratiometric signal. The inputs must be configured for 0/5V ratiometric signals by the application program resident in the memory.

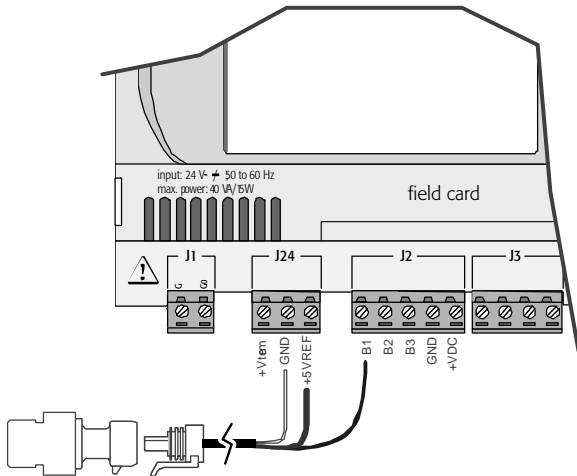

Fig. 4.e

Controller	pCO terminals	Probe wire colour	Description
pCO <sup>3</sup>	+5V Ref	black	power supply
	GND	green	power supply reference
	B1, B2, B3 B6, B7, B8	white	signal
pCO <sup>8</sup>	+5V Ref	black	power supply
	GND	green	power supply reference
	B1, B2	white	signal
pCO <sup>1</sup>	+5V Ref	black	power supply
	GND	green	power supply reference
	B1, B2, B3, B4	white	signal
pCO <sup>6</sup>	Not available		

### 4.3.6 Connecting active probes with 0 to 10 V output

The inputs must be configured for 0 to 10 V signals by the application program resident in flash memory.

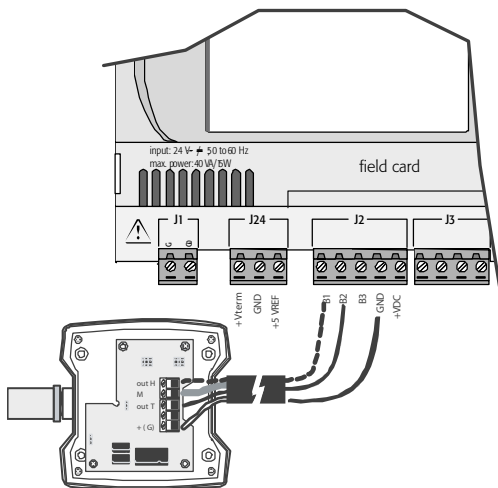

Fig. 4.f

Controller		0 to 10 V probe cable
pCO <sup>3</sup>	GND	reference
	B1, B2, B3, B6, B7, B8	signal
	+Vdc	brown Power supply (if used)
		Not available directly
pCO <sup>8</sup>		Not available directly
pCO <sup>1</sup>		Not available directly
pCO <sup>6</sup>	Not available	

Tab. 4.f

- Reading 0 to 10 V inputs with the pCO<sup>1</sup> and pCO<sup>8</sup>

**Warning:** the pCO<sup>1</sup> and pCO<sup>8</sup> cannot read 0 to 10 Volt inputs.

On both controllers, to read this type of input simply set it as 0-5 V at an application level and then fit a 20.5K $\Omega$ , 1/4W, 1% resistor in series with terminal Bn, as shown in the drawing below.

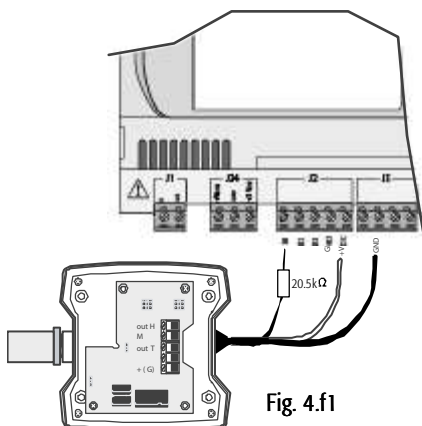

Fig. 4.f1

- In this way, for the pCO<sup>1</sup> a measurement error of approx 1.2% is introduced. This error can be easily overcome by modifying the reading of the analogue input by the application using a gain coefficient of 1.0125, or using two 10K resistors in series instead of one 20.5K.
- For the pCO<sup>8</sup>, the following formula must be applied to reading of the analogue input :  $X = (\text{value of } \text{AinpcO2} - 504) * 2.1$ .  
Where: "Value of AinpcO2" is the value of the input read by the software.

**Note:**

- the impedance of the pCO<sup>1</sup> input configured as 0 to 5 V is 20K $\Omega$ ;
- the impedance of the pCO<sup>8</sup> input configured as 0 to 5 V is 6.6K $\Omega$ .

The probe must have an **output resistance** that is much lower than the input resistance of the pCO as indicated above; otherwise the formula applied to the reading will need to be adjusted.

### 4.3.7 Connecting the analogue inputs selected as ON/OFF

A number of analogue inputs on the pCO can be configured as voltage-free digital inputs, not optoisolated. The inputs must be configured as voltage-free digital inputs by the application program resident in flash memory.

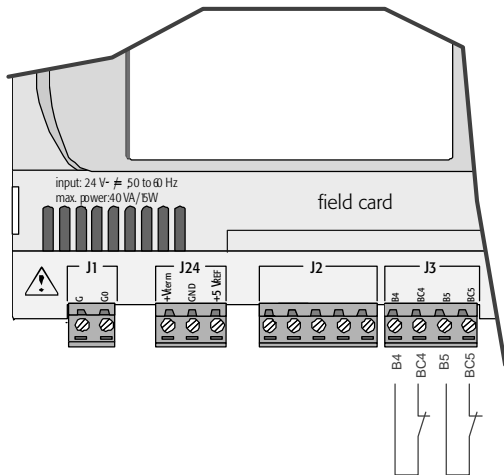

Fig. 4.g

Controller	pCO terminals				Digital input wire
pCO <sup>s</sup>	digit 1	digit 2	digit 3	digit 4	
	BC4	BC5	BC9	BC10	1
	B4	B5	B9	B10	2
pCO <sup>ss</sup>	Not available				
pCO <sup>l</sup>	B5	B6			1
	GND	GND			2
pCO <sup>c</sup>	Not available				

Tab. 4.g

**Warnings:** the maximum current available at the digital input is 5 mA (thus the rating of the external contact must be at least 5 mA).

### 4.3.8 Distance of the analogue inputs

The sizes of the cables used for connecting the analogue inputs over a distance are shown in the following table:

type of input	size (mm <sup>2</sup> ) for length up to 50 m	size (mm <sup>2</sup> ) for length up to 100 m
NTC	0.5	1.0
PT1000	0.75	1.5
I (current)	0.25	0.5
V (voltage)	0.25	0.5

Tab. 4.h

If the product is installed in industrial environments (application of the EN 61000-6-2 standard) the length of the connections must be less than 30m. In any case, this length should not be exceeded so as to prevent measurement errors.

## 4.4 Connecting the digital inputs

The pCO features digital inputs for connection to safety devices, alarms, device status indicators and remote control signals. These inputs are all optically-isolated from the other terminals and can operate at 24 Vac, 24 Vdc and some at 230 Vac.

**Note:** separate as much as possible the probe and digital input signal cables from the cables carrying inductive loads and power cables to avoid possible electromagnetic disturbance.

**IMPORTANT WARNINGS:** if the control voltage is taken in parallel from a battery, install a dedicated RC filter in parallel with the battery (the typical features are 100  $\Omega$ , 0.5  $\mu$ F, 630 V).

If connecting the digital inputs to safety systems (alarms), **remember that:** voltage across the contact must be considered as the normal operating condition, while no voltage must represent an alarm situation. In this way, any interruption (or disconnection) of the input will also be signalled. Do not connect the neutral to an open digital input. Always make sure that it is the line that is disconnected. The 24 Vac/Vdc digital inputs have a resistance of around 5 k $\Omega$ .

### 4.4.1 24 Vac digital inputs

For pCO<sup>3</sup>, pCO<sup>1</sup> and pCO<sup>6</sup>: all inputs can be 24 Vac.

The following figure represents one of the most common diagrams for connecting the 24 Vac digital inputs, for a pCO<sup>3</sup>.

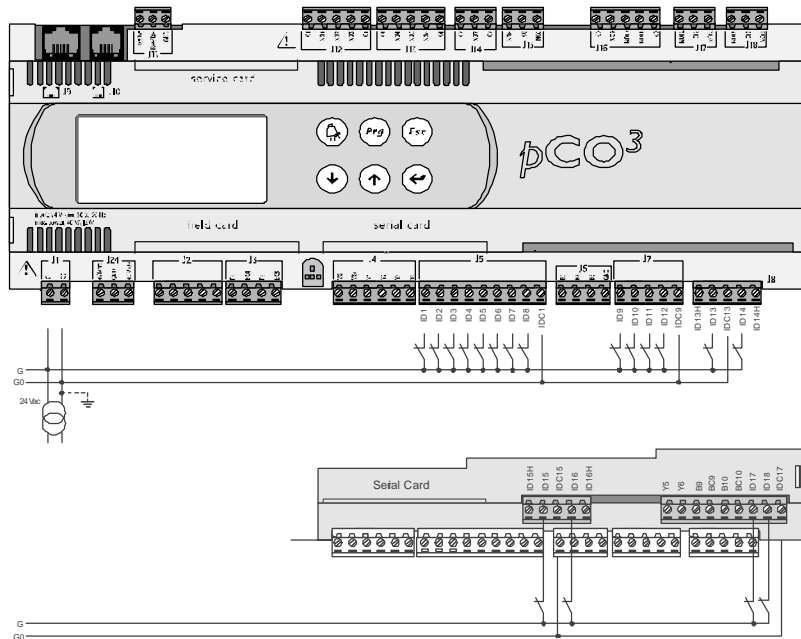

Fig. 4.h

### 4.4.2 24 Vdc digital inputs

For pCO<sup>3</sup>, pCO<sup>1</sup> and pCO<sup>6</sup>: all inputs can be 24Vdc.

The following figure represents one of the most common diagrams for connecting the 24 Vdc digital inputs, for a pCO<sup>3</sup>.

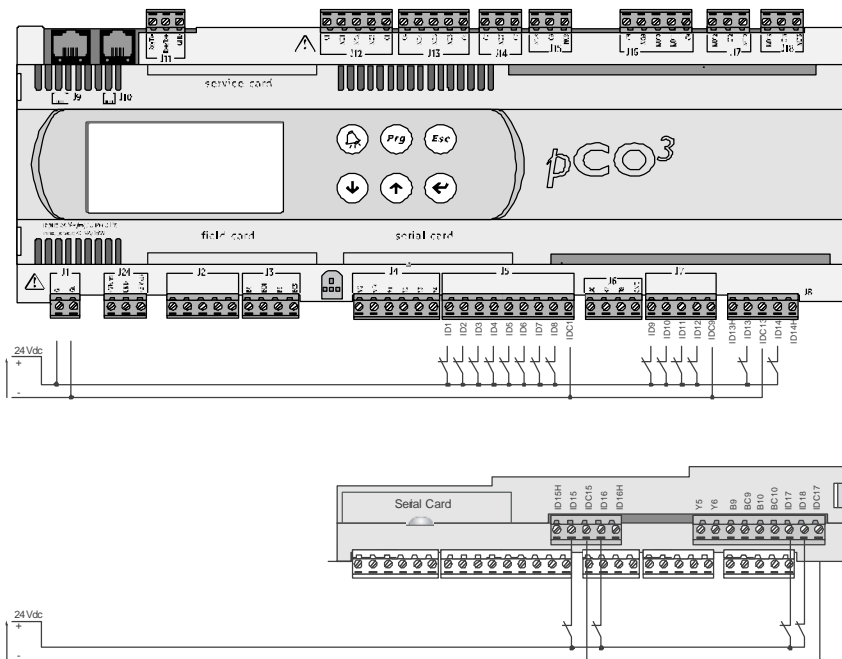

Fig.4.i

To maintain the optical isolation of the digital inputs, a separate power supply must be used just for the digital inputs; Figs. 4.h and 4.i show the connection diagrams for the versions: MEDIUM (extended) and LARGE (limited to the part regarding the terminals located inside, on the board). While being the more common and the simplest diagrams to complete, these do not exclude the possibility of powering the digital inputs independently from the power supply to the pCO. In any case, the inputs only have functional insulation from the rest of the controller.

**Note:** there are no digital inputs in the Extra Large zone.

### 4.4.3 Connecting the digital inputs to the pCOXS

The pCO<sup>XS</sup> features up to 6 not optoisolated digital inputs, with voltage-free contacts, for connection to safety devices, alarms, device status indicators and remote control signals, etc.

These operate at 24 Vdc (supplied by the pCO<sup>XS</sup>) with a guaranteed current at the contact of 6 mA.

**Warning:** separate as much as possible the probe and digital input signal cables from the cables carrying inductive loads and power cables to avoid possible electromagnetic disturbance.

The following figure shows the diagram for connecting the digital inputs.

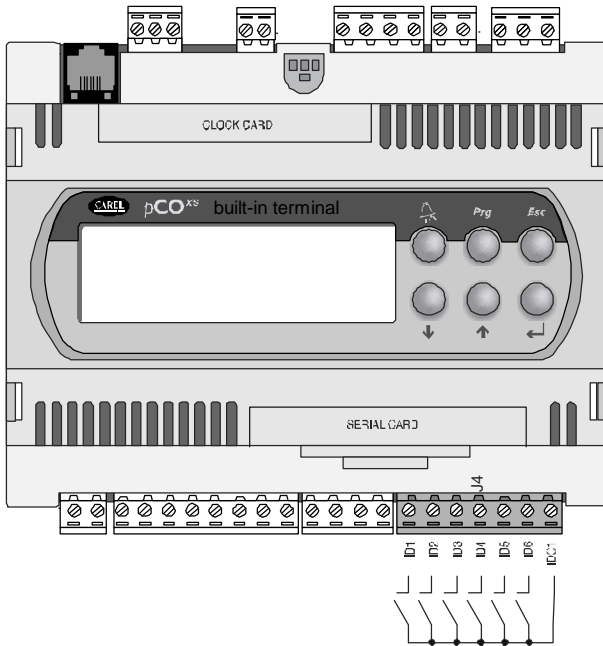

Fig. 4.l

### 4.4.4 230 Vac digital inputs

#### FOR PCO<sup>3</sup>, PCO<sup>1</sup> AND PCO<sup>C</sup> ONLY

There are up to two groups of 230 Vac inputs. Each group features two inputs and the groups have double insulation between them and therefore may have different reference voltages. The digital inputs cannot be independent within each group: for example, with reference to Fig. 4.m, inputs ID15 and ID16, due to the common terminal, must be powered at the same voltage to avoid dangerous short-circuits and/or 230 Vac being supplied to circuits operating at lower voltages. In any case the inputs have double insulation from the rest of the controller.

The following figure represents one of the most common diagrams for connecting the 230 Vac digital inputs.

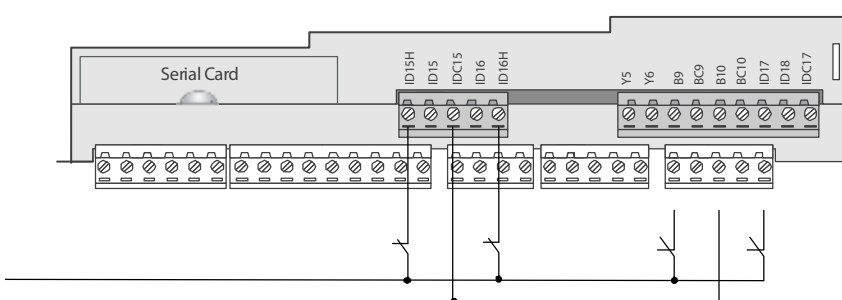

Fig. 4.m

The uncertainty of the switching threshold ranges from 43 to 90 Vac. It is recommended to use a 100 mA fuse in series with the digital inputs.

	input
pCO <sup>3</sup> terminals	13, 14, 15, 16
pCO <sup>XS</sup> terminals	Not available
pCO <sup>1</sup> terminals	13, 14
pCO <sup>C</sup> terminals	11, 12

Tab. 4.i

#### Warnings for the 230 Vac digital inputs:

- 230 Vac 50/60 Hz +10/-15 %;
- for each group, the two inputs, 24 Vac/Vdc or 230 Vac have the same common pole, the inputs will both work at the same voltage (24 Vac/Vdc or 230 Vac). Insulation is primary.

### 4.4.5 Distance of the digital inputs

**Important note:** do not connect other devices to the digital inputs.

The sizes of the cables used for connecting the digital inputs over a distance are shown in the following table:

size (mm <sup>2</sup> ) for length up to 50 m	size (mm <sup>2</sup> ) for length up to 100 m
0.25	0.5

If the product is installed in industrial environments (application of the EN 61000-6-2 standard) the length of the connections must be less than 30m. In any case, this length should not be exceeded so as to prevent reading errors.

## 4.5 Connecting the analogue outputs

### 4.5.1 Connecting the 0 to 10 V analogue outputs

The pCO provides 0-10V optically-isolated analogue outputs, powered externally at 24Vac/Vdc.

Fig. 4.n shows the electrical connection diagram; the 0 V (zero) of the power supply is also the reference for the output voltage.

The table below shows summarises the distribution of the analogue outputs according to the versions available.

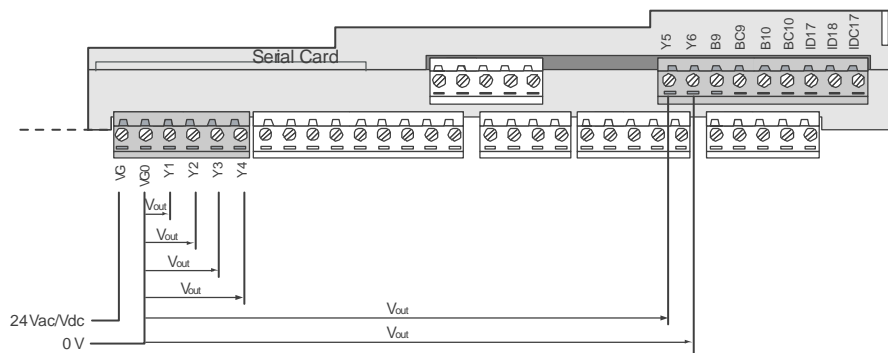

Fig. 4.n

	no. of analogue outputs	reference
<b>pCO<sup>3</sup> terminals</b>		
SMALL	Y1, Y2, Y3, Y4	VG0
MEDIUM	Y1, Y2, Y3, Y4	
LARGE	Y1, Y2, Y3, Y4, Y5, Y6	
XL NO	Y1, Y2, Y3, Y4	
XL NC	Y1, Y2, Y3, Y4	
<b>pCO<sup>5S</sup> terminals</b>	Y1, Y2	G0
<b>pCO<sup>1</sup> terminals</b>		
SMALL	Y1, Y2,	VG0
MEDIUM	Y1, Y2,	
<b>pCO<sup>c</sup> terminals</b>		VG0

Tab. 4.l

**Warning:** on the pCO<sup>5S</sup> the outputs are not optically-isolated. Also remember that the internal circuit of the power supply to the pCO<sup>5S</sup> is isolated.

### 4.5.2 Connecting the PWM analogue outputs

The pCO<sup>1</sup> and the pCO<sup>5S</sup> provide a PWM analogue output for phase cutting speed controllers. Fig.4.o shows the most common electrical connection diagrams.

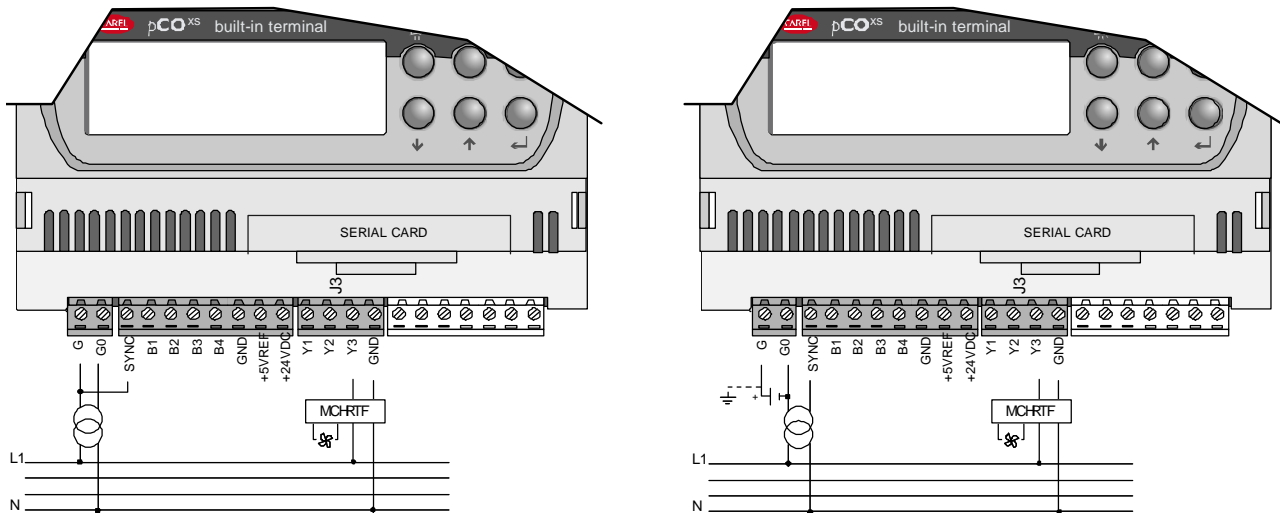

Fig. 4.o

	no. of analogue outputs	reference
<b>pCO<sup>3</sup> terminals</b>	not available	
<b>pCO<sup>5S</sup> terminals</b>	Y3	G0
<b>pCO<sup>1</sup> terminals</b>	Y3, Y4	VG0
<b>pCO<sup>c</sup> terminals</b>	not available	

Tab. 4.m

**Note:** the power supply to the circuit measuring the zero crossing is at terminal G on the pCO<sup>1</sup> and terminal SYNC on the pCO<sup>5S</sup>, and must be 24 Vac, in phase with the power supply to the actuator: for three-phase power supply, use the same phase to power the pCO<sup>5S</sup> and the actuator.

### 4.5.3 Optional modules

#### Module for converting a PWM output to a 0 to 10 V analogue output or 4 to 20 mA.

A special module is used to convert a PWM output (5 V pulses) into a linear 0 to 10 V or 4 to 20 mA analogue output (code CONV0/10A0).

The control signal (at the input terminals it is optically-isolated from the rest of the module) must have a maximum amplitude of 5 V and a period of between 8ms and 200 ms. The 0 to 10 V output can be connected to a maximum load of 2kΩ, with a maximum ripple of 100 mV, while the 4 to 20 mA current output can be connected to a maximum load of 280Ω, with a maximum overshoot of 0.3 mA.

The module measures 87x36x60 mm (2 DIN modules) and has IP20 index of protection.

#### Module for converting a 0 to 10 V analogue output to an SPDT digital output (code CONVONOFF0)

This module is used to convert a 0 to 10 V analogue output (Yn) to an ON/OFF relay output. The control signal Yn (at the input terminals it is optically-isolated from the rest of the module), to ensure the relay switches from OFF to ON, must have a minimum amplitude of 3.3 V. The relay is SPDT with a maximum current of 10 A and a maximum inductive load of 1/3 HP. The module measures 87x36x60 mm (2 DIN modules) and has IP20 index of protection.

#### Module for dividing the number of pulses at the digital input by 8 (code PCO208DI00)

This module is used to independently divide the frequency of two signals by a factor of 8. The two input signals (at the input terminals they are optically-isolated from the rest of the module) must have an amplitude of between 10 and 20V, a duration greater than 10 ms and a maximum frequency of 10 Hz.

The module measures 87x36x60 mm (2 DIN modules) and has IP20 index of protection.

## 4.6 Connecting the digital outputs

The pCO features digital outputs with electromechanical relays and for ease of installation, the common terminals of some of the relays have been grouped together. If a diagram in Fig. 4.p is used, the current at the common terminals must not exceed the rating (nominal current) of an individual terminal (8 A).

### 4.6.1 Electromechanical relay digital outputs

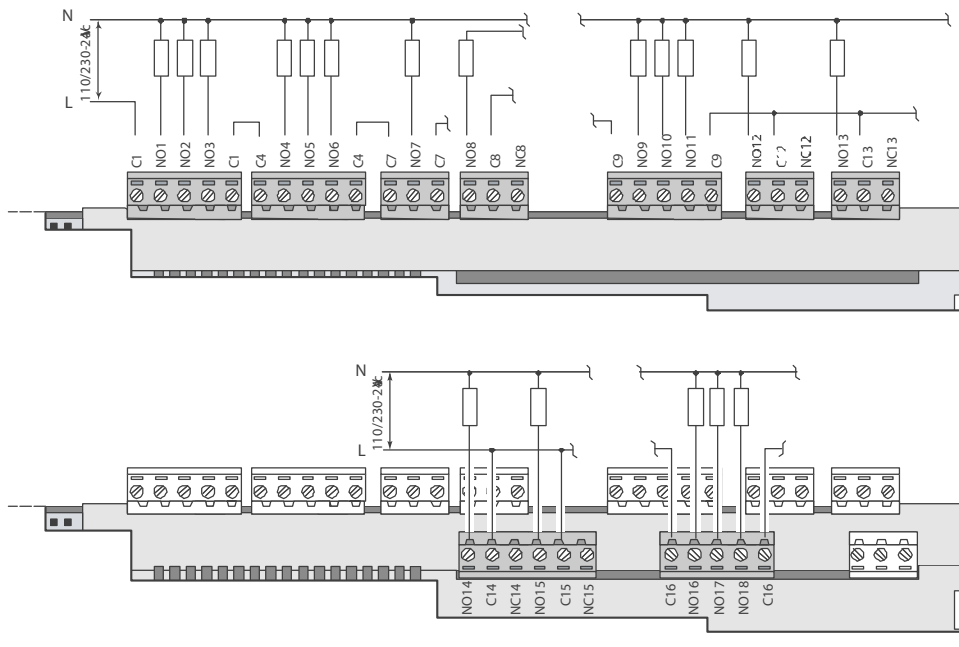

Fig. 4.p

The relays are divided into groups, according to the insulation distance. Inside each group, the relays have just basic insulation and thus must have the same voltage (generally 24Vac or 110-230Vac).

Between the groups, instead, there is double insulation and thus the groups can have different voltages. In any case there is double insulation from the rest of the controller.

### 4.6.2 Changeover outputs

Some relays feature changeover outputs:

	Relay changeover reference
pCO <sup>3</sup> terminals	8, 12, 13, 14,15
pCO <sup>RS</sup> terminals	5
pCO <sup>1</sup> terminals	8, 12, 13,
pCO <sup>E</sup> terminals	9, 10, 11

Tab. 4.n

### 4.6.3 Solid state relay (SSR) digital outputs

The pCO also features a version with solid state relays (SSR) for controlling devices which require an unlimited number of switching cycles and thus would not be supported by electromechanical versions. This outputs are dedicated to loads powered at 24Vac/Vdc with a maximum power  $P_{max} = 10W$ .

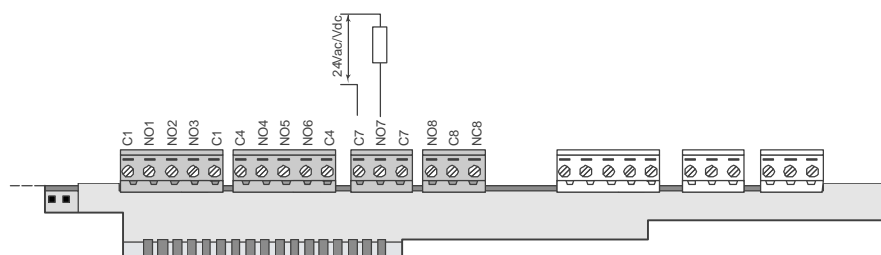

Fig. 4.p

	Relay changeover reference
<b>pCO<sup>3</sup> terminals</b>	
SMALL	7
MEDIUM	7, 12
LARGE	7, 12, 14
XL NO	7, 12
XL NC	7, 12
<b>pCO<sup>4S</sup> terminals</b>	4, 5
<b>pCO<sup>1</sup> terminals</b>	
SMALL	7, 8
MEDIUM	7, 8, 12, 13
<b>pCO<sup>c</sup> terminals</b>	not available

Tab. 4.o

**Warning:** the load of the SSR relay is powered at 24Vac/Vdc, thus all the other terminals in the group, from 1 to 6, must be powered with the same tension due to the absence of double insulation within the group. Moreover, terminals from 1 to 6 can be powered at 110 to 230 Vac using a safety transformer (Class 2).

### 4.6.4 Summary table of the digital outputs according to the versions available

	NO contacts	NC contacts	changeover reference	total no. outputs	SSR relay reference
<b>pCO<sup>3</sup> terminals</b>					
SMALL	7	-	1 (8)	8	1 (7)
MEDIUM	10	-	3 (8, 12, 13)	13	2 (7, 12)
LARGE	13	-	(8, 12, 13, 14, 15)	18	3 (7, 12, 14) o 4 (7, 12, 14, 15)
XL NO	26	-	(8, 12, 13)	29	7, 12
XL NC	10	14	(8, 12, 13)	27	7, 12
<b>pCO<sup>4S</sup> terminals</b>	4	-	(8, 12, 13)	5	4, 5
<b>pCO<sup>1</sup> terminals</b>					
SMALL	7	-	8	8	7, 8
MEDIUM	10	-	8, 12, 13	13	7, 8, 12, 13
<b>pCO<sup>c</sup> terminals</b>	10	-	9, 10, 11	13	---

Tab. 4.p

### 4.6.5 Distance of the digital outputs

The sizes of the cables used for connecting the digital outputs over a distance are shown in the following table:

AWG	Size (mm <sup>2</sup> )	Current
20	0.5	2
15	1.5	6
14	2.5	8

Tab. 4.q

If the product is installed in industrial environments (application of the EN 61000-6-2 standard) the length of the connections must be less than 30m. In any case, this length should not be exceeded so as to prevent measurement errors.



## 5. CONFIGURATION OF THE PLAN NETWORK

### 5.1 Introduction

All the pCO controllers can be connected together and to other Carel devices in a local network (pLAN), without requiring optional devices, thus allowing the communication of data and information from one location (node) to another.

The pCO terminals can display the variables (temperature, humidity, pressure, I/O, alarms) from one controller only at any one time. The terminal does not need to be connected to the pCO for the normal operation of the controller, however it can be used for the initial programming of the fundamental parameters.

If one or more terminals are disconnected or malfunctioning, the control program continues to operate correctly on each pCO board.

In general, the application program can monitor the status of the network and the terminals and respond in the event of malfunctions.

The figure below shows a possible pLAN network connection diagram.

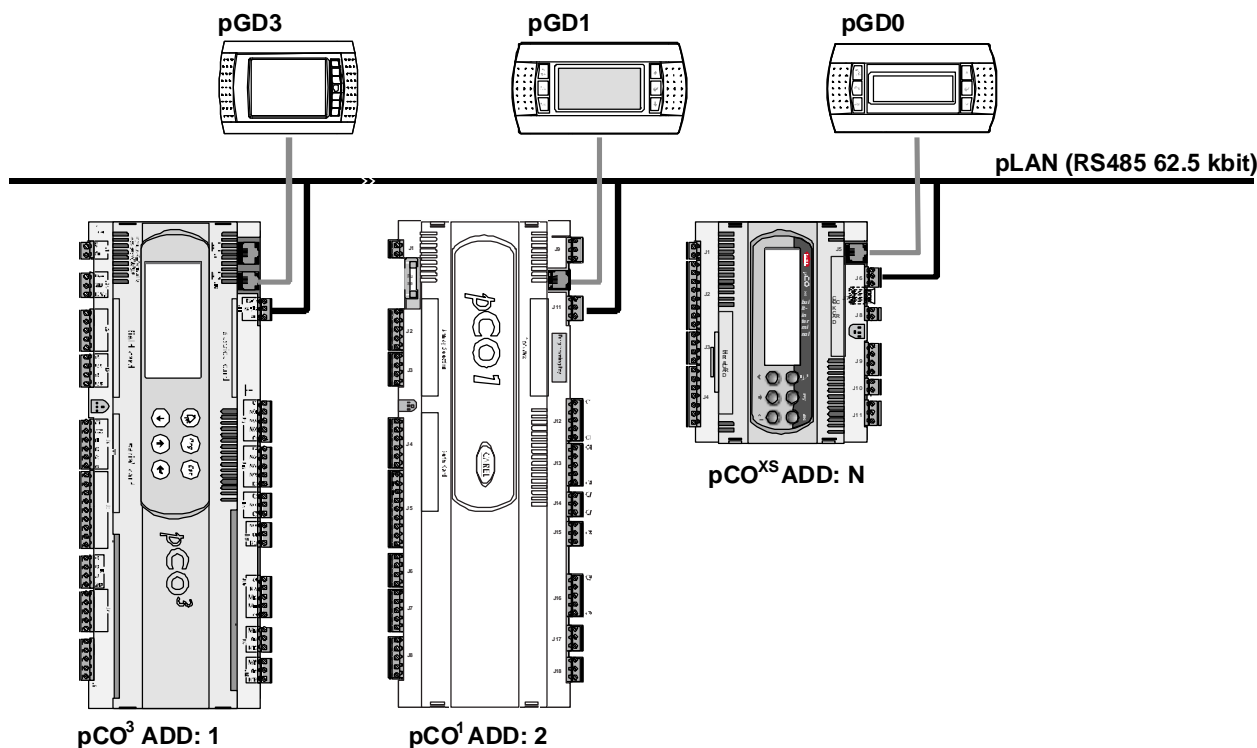

Fig. 5.a

The standard communication speed over the network is 62500 bps but some devices also support speeds of 115200 bps.

All the units in the network must in any case use the same speed.

A maximum of 32 units can be connected, including:

- pCO controllers, running the control program;
- boards that extend the I/O functions (such as the EVD200 driver);
- terminals (LED, 4x20 LCD and graphic).

Each unit in the pLAN is identified by a unique address, that is, a number between 1 and 32. Address 32 can only be assigned to a terminal.

The programs for the different applications (e.g.: standard chiller, standard air-conditioners, compressor racks, ...) cannot be automatically integrated into a local network: they must be configured considering the architecture of the system and using the developing CAREL tool.

Each pCO board connected to the network can manage up to 3 pLAN terminals at the same time. The values are displayed simultaneously and not independently on each terminal, as if they were connected in parallel: for this reason, the pCO cannot control different types of terminals at the same time (for example, one pGD<sup>1</sup> and one pGD<sup>3</sup>).

A terminal associated with a certain board is defined as:

- *private* ("Pr") if it exclusively displays the output of that board;
- *shared* ("Sh") if either automatically or from the keypad it can be switched between more than one board;
- *shared with printer* ("Sp") if, as well as being shared, it is fitted with a RS232 serial board for connecting a printer (only for the old PCOT and PCOI terminals, not the pGD).

Each pCO maintains constantly updates the display on the private terminals, while the shared terminals are only updated only if the pCO controller in question has control over the terminal at that moment.

From the logical point of view, the connections are shown in the following figure:

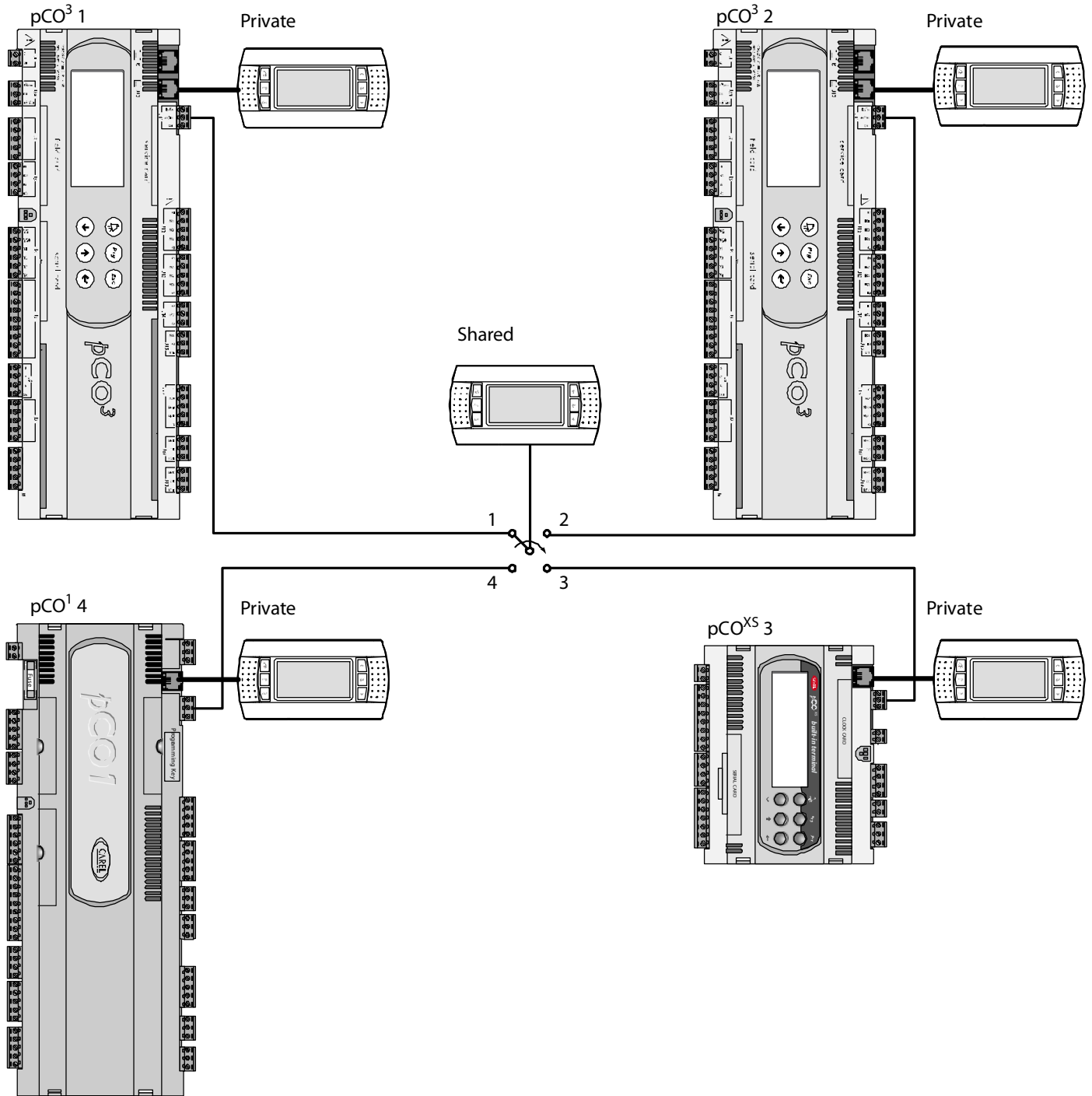

Fig. 5.b

In the example, the shared terminal is associated with 4 pCO<sup>c</sup> controllers, however currently only controller 1 can display data and receive commands from the keypad. The terminal is switched between the different controllers cyclically (1→2→3→4→1 ...) by pressing a predefined button. Switching can also occur automatically, managed directly by the program; in this case, in fact, a pCO controller can request control over the shared terminal to display new alarms or, vice-versa, give up control to the next pCO after a preset time (cyclical rotation).

The data corresponding to the number and type of terminals are established during the initial configuration of the network, and are saved in the permanent memory on each individual pCO controller. The details of the configuration are described below. The pLAN connection between two pCO controllers can only be made using an AWG20/22 shielded cable, made up of a twisted pair plus the shield. The terminal and the pCO can be connected using a 6-wire telephone cable or AWG20/22 shielded cable, depending on the model of terminal.

Further details on the installation of the terminals are provided in the section on **"pLAN electrical connections"**.

## 5.2 Installing the pGD0 and pGD1 terminals

The connection between the terminal and the pCO is made using a 6-wire telephone cable, supplied by CAREL (code S90CONN). To make the connection, simply plug the telephone connector into the RJ12 jack on the rear of the terminal, and in connector:

- J19 on the pCO<sup>2</sup>;
- J5 on the pCO<sup>XS</sup>;
- J10 on the pCO<sup>1</sup>, pCO<sup>3</sup>.

The address of the terminal can be set in the range between 0 and 32; addresses from 1 to 32 are used by the pLAN protocol, while address 0 identifies the **Local terminal protocol**, used for point-to-point connections without graphics and to configure the pCO. The default address is 32. The address can only be set after having powered up the terminal via the RJ12 connector. To access configuration mode, press the UP, DOWN and ENTER (  $\uparrow$ ,  $\downarrow$ ,  $\leftarrow$  ) buttons together for at least 5 seconds; the terminal will display a screen similar to the one shown below, with the cursor flashing in the top left corner:

```
Display address
setting.....:32

I/O Board
```

Fig. 5.d

To change the address of the terminal ("Display address setting"), proceed as follows.

Press the ENTER button once: the cursor will move to the "Display address setting" field.

Select the desired value using the UP and DOWN buttons, and confirm by pressing ENTER again.

If the value selected is different from the value previously saved, the following screen will be displayed and the new value will be saved to the permanent memory.

```
Display address
changed
```

Fig. 5.e

If the address field is set to 0, the terminal communicates with the pCO board using the Local terminal protocol and the "I/O Board address" field is no longer shown, as it has no meaning.

To change the list of terminals (private and shared) associated with a pCO board, proceed as follows:

- enter configuration mode (see above) by pressing the UP, DOWN and ENTER buttons together for at least 5 seconds.
- press the ENTER button twice: the cursor will move to the "I/O Board address" field.
- select the address of the desired pCO board and confirm by pressing ENTER.

The pCO will then enter the configuration procedure, showing a screen similar to the one below.

```
Terminal config
Press ENTER
to continue
```

Fig. 5.f

- 1) Press ENTER again: the configuration screen will be displayed, similar to the one below.

```
P:01 Adr
Priv/Shared
Trm1 32 Sh
Trm2 02 Pr
Trm3 -- --
```

Fig. 5.g

Change the configuration of the terminals as required. The ENTER button is used to move the cursor from one field to another, while the UP and DOWN buttons change the value of the current field. P:xx shows the address of the selected pCO board (in the example shown in the figure, this is board 1).

To exit the configuration procedure and save the data, select the "OK?" field, set "Yes" and confirm by pressing ENTER.

During the configuration procedure, if the terminal remains inactive (no button is pressed) for more than 30 seconds, the pCO board automatically exits the procedure without saving any changes.

**Important:** the pGD\* terminals cannot be configured as "Sp" (shared with printer) as they do not have the printer output. Selecting this mode has no effect on the management of the printed messages.

If during operation the terminal detects the inactivity of the pCO board whose output it is displaying, it cancels the display completely and then shows a message similar to one below.

```
I/O board 01 fault
```

Fig. 5.h

If the terminal detects the inactivity of the entire pLAN network, that is, it does not receive any message from the network for 10 consecutive seconds, it cancels the display completely and shows the following message:

```
NO LINK
```

Fig. 5.i

### 5.3 Installing the pGD2 and pGD3 terminals

The connection between the terminal and the pCO is made only using an AWG20/22 shielded cable, terminated with 3-pin plug-in connectors.

To make the connection, simply plug one of the connectors into the "RS485" jack on the terminal and the other to connector

- J6 on the pCO<sup>XS</sup>,
- J11 on the pCO<sup>1</sup>, pCO<sup>C</sup>, pCO<sup>3</sup>.

The pGD<sup>2</sup> and pGD<sup>3</sup> terminals can set the network address and communication speed from a menu. To access this menu, press any point on the touch screen together with the UP and PRG buttons; alternatively, access is also possible by pressing UP, DOWN, ENTER at the same time. In both cases, after 1 second a screen similar to the one below will be displayed:

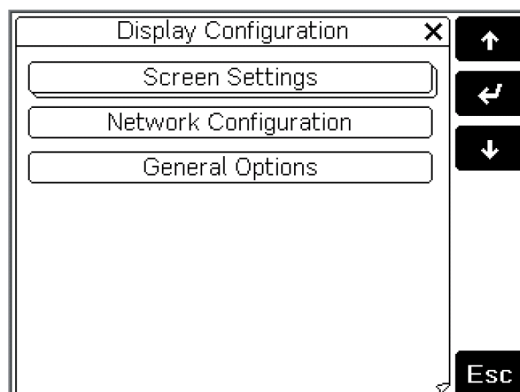

Fig. 5.l

To access a menu item, simply press the touch screen on the item or, alternatively, press the UP or DOWN button until selecting the item, then confirm with ENTER. To change the value of a field after having selected it (a field is selected when the cursor is flashing on the field), press the UP or DOWN button until reaching the desired value, then press ENTER to save the value. Pressing ESC before ENTER cancels the changes made to the field. The buttons available during the configuration phase are visible on the right-hand side of the display. The network configuration options are available under "Network Configuration". When selecting this item, the terminal will display a screen similar to the one below:

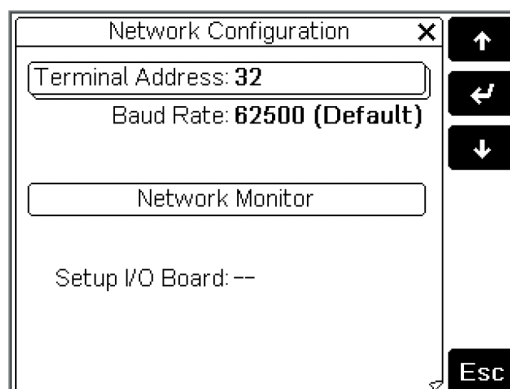

Fig. 5.m

The following options are available.

- **Terminal Address:** used to set the address of the terminal, from 1 to 32.  
If the value "--" is set (two dashes are displayed) the terminal will communicate with the pCO board using the Local terminal protocol (point-to-point) rather than pLAN: the "Baud Rate", "Network Monitor" and "Setup I/O Board" fields will no longer be displayed, as they have no meaning.
- **Baud Rate:** used to set the pLAN communication baud rate. The options are 62500 bps (default) and 115200 bps. The 115200 bps option must only be set if all the devices in the network are configured for this speed; note that not all pLAN support devices the 115200 bps setting.
- **Network Monitor:** used to display the network status. For further information, see the user manual for the pGD2/3 terminals.
- **Setup I/O Board:** used to modify the list of terminals associated with each individual pCO board. To do this, select the address of the desired board (only the boards that are effectively on line can be selected) and confirm by pressing ENTER: then press the "Setup" button on the display to start the configuration procedure already described for the pCOI/pCOT terminals.

**Important:** like all the pGD\* terminals, the pGD<sup>2</sup> and pGD<sup>3</sup> cannot be configured as "Sp" (shared with printer) as they have no printer output. Selecting this mode has no effect on the management of the printed messages. During operation, the terminal monitors special conditions of the pLAN network, and highlights these with messages on the display, as illustrated below.

- Message "Starting up, please wait ": the terminal has just been started and/or is initiating communication.
- Message "Please wait...": the procedure for assigning the private or shared terminals to a pCO has just ended and the terminal is awaiting the start of communication.
- Message "No network link: terminal alone": the pLAN protocol has been selected and no pCO is detected within 40 s from power-up, or alternatively the network is inactive (no package received) for at least 20 s during normal operation.
- Message "I/O board (at address xx) fault": the pLAN protocol has been selected and the terminal has lost communication with the pCO whose output it was displaying for more than least 8 s.
- Message "No I/O board configured for this terminal": the pLAN protocol has been selected and the terminal is not among those configured for the pCO in the network. The message is displayed 40 s after power-up or around 8 seconds after ending the procedure for assigning the terminals to a pCO.

## 5.4 Installing the Aria terminal

The connection between terminal and pCO is made using AWG20/22 shielded cable only. To connect the cable to the terminal, proceed as follows.

- 1) Disconnect power to the terminal.
- 2) Separate the front of the terminal from the bottom shell (for further details, see the user manual or the instruction sheet).
- 3) Fasten one end of the cable shield to the terminals marked "GND", "Rx/Tx+" and "Rx/Tx-" in the bottom shell.
- 4) Close the terminal again.

To connect the cable to the pCO, the end not connected to the Aria terminal must be terminated with a 3-pin plug-in connector, then plug this into connector:

- J6 on the pCO<sup>XS</sup>,
- J11 on the pCO<sup>I</sup>, pCO<sup>C</sup>, pCO<sup>3</sup>.

The Aria terminal communicates with the pCO boards by exchanging variables across pLAN. As the code that manages the terminal is resident in ROM, and therefore cannot be changed depending on the devices that make up the network (as normally occurs for pCO boards), the terminal can receive variables from any device in the network, but can only send data to one device, selected by the user. Overall, there are five parameters used to configure pLAN communication on the Aria terminal:

- **L1**: pLAN address of the Aria terminal (between 1 and 31);
- **L2**: pLAN address of the device the variables are sent to (between 1 and 31);
- **L3**: pLAN page (between 0 and 255);
- **L5**: used to selectively inhibit the reception of some variables;
- **L6**: communication protocol over RS485 line, selectable as pLAN or CAREL Slave.

For further information on the parameters and on the variables that can be exchanged, see to the user manual.

The Aria terminal parameters can be set on the keypad or by copying the settings from a hardware key programmed previously using a sample device. In the first case (programming by keypad), proceed as follows:

- 1) power up the terminal;
- 2) press the SET and MODE buttons together: the terminal will display a screen for entering the enabling code;
- 3) using UP or DOWN enter the code "22" and confirm by pressing SET: the terminal enters parameter configuration mode, showing a screen similar to the one below (the code at the bottom is the name of the parameter, while the number at the top is the value of the parameter).



- 4) Press the UP and DOWN buttons until the terminal shows the desired parameter.
- 5) Press SET to make the change: the selected parameter flashes.
- 6) Enter the desired value using the UP and DOWN buttons, then confirm by pressing SET.
- 7) Exit programming mode by pressing the HOLD button.

**Important:** after having changed the pLAN address (parameter L1), turn the terminal off and on again for the changes to take effect.

If wanting to set the parameters using a hardware key, first of all copy the parameters from the sample device as follows:

- 1) connect the key;
- 2) power up the sample device by pressing and holding SET and DOWN;
- 3) the device starts copying the data to the key: the display shows the message "EC";
- 4) at the end of the copy operation the message OK or NO is shown, depending on the outcome of the data transfer.

To then copy the parameters from the removable hardware key to the terminal, simply proceed as follows:

- 1) connect the key;
- 2) power up the terminal by pressing and holding the UP button;
- 3) the terminal starts copying the data from the key: the display shows the message "CE";
- 4) at the end of the copy operation the message OK or NO is shown, depending on the outcome of the data transfer.

## 5.5 Setting the pLAN address on the pCO<sup>1</sup>, pCO<sup>XS</sup>, pCO<sup>C</sup> and pCO<sup>3</sup>

The pCO<sup>1</sup>, pCO<sup>XS</sup>, pCO<sup>C</sup> and pCO<sup>3</sup> controllers do not have dipswitches for setting the pLAN network address: the pLAN address can be set from any terminal, pGD0, pGD1, pGD2, pGD3 or built-in on the models where fitted. To set the address from an external terminal (not built-in), proceed as follows.

- 1) Set address 0 on the terminal (see the previous sections for details on how to set this address).
- 2) Power down the pCO.
- 3) Remove any pLAN connections from the pCO to other controllers.
- 4) Connect the terminal to the pCO.
- 5) Power up the pCO, pressing the UP and ALARM buttons together on the terminal. After a few seconds, the pCO commences the start-up sequence, and the display shows a screen similar to the one below:

```
#####
selftest
please wait...
#####
```

Fig. 5.n

- 6) When this screen appears, wait 10 seconds and then release the buttons.
- 7) The pCO stops the start-up sequence and shows a configuration screen similar to the one below:

```
pLan address: 0
UP: increase
DOWN: decrease
ENTER: save & exit
```

Fig. 5.o

Then set the pLAN address using the UP and DOWN buttons on the terminal.

- 8) Confirm the address by pressing the ENTER button: the pCO completes the start-up sequence and uses the specified address.

**Note:** step 6) is only required for the pGD2 or pGD3 terminals. To modify the address from a Built-In terminal, steps 1) and 3) are not needed; the rest of the procedure is the same as described above.

## 5.6 pLAN electrical connections between the pCO controllers

The connection of the pCO controllers in the pLAN is carried out using an AWG20/22 shielded cable, twisted pair plus shield, with a capacitance between the wires of less than 90 pF/m.

**Maximum pLAN network length:** 500 m with AWG22 cable, twisted pair with shield.

The boards are connected in parallel with reference to plug-in connector J11.

**IMPORTANT:** observe the network polarity: RX/TX+ on one board must be connected to RX/TX+ on the other boards; the same is true for RX/TX-.

Fig. 5.p shows a diagram of a number of boards connected in a pLAN network and powered by the same transformer, typical for a number of boards connected inside the same electrical panel.

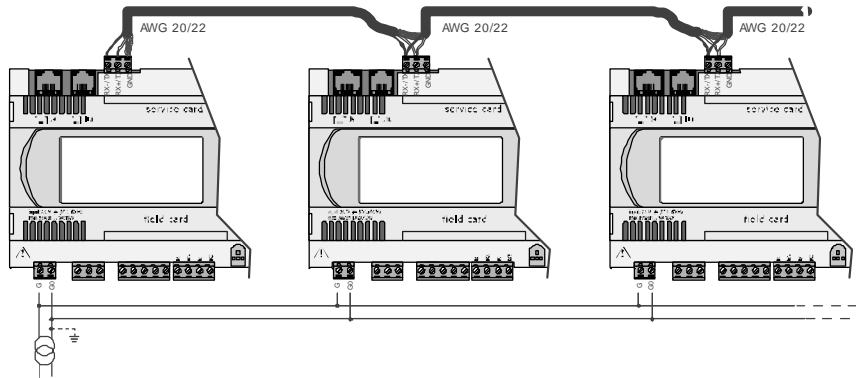

Fig. 5.p

Fig. 5.q shows a diagram of a number of boards connected in a pLAN network and powered by different transformers (with G0 not earthed), typical of a number of boards inside different electrical panels.

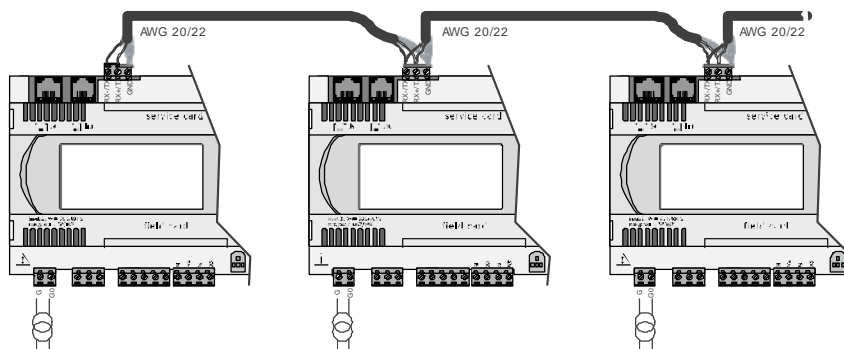

Fig. 5.q

Fig. Fig. 5.r shows a diagram of a number of boards connected in a pLAN network and powered by different transformers with the same earth; this is a typical application for a number of boards inside different electrical panels.

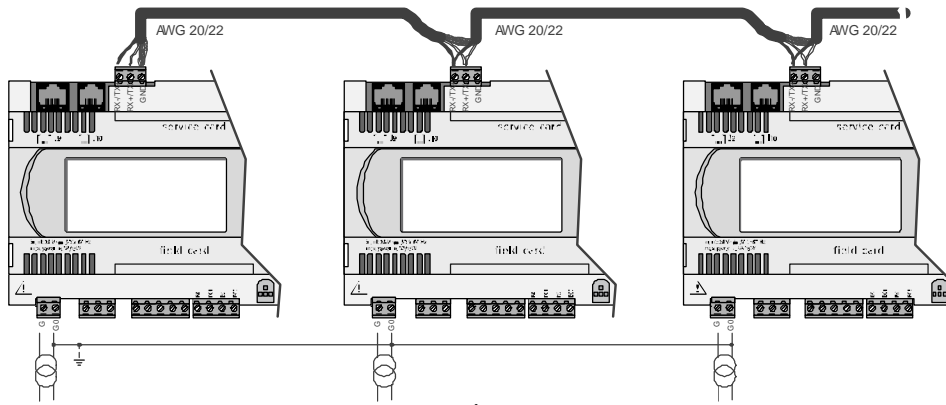

Fig. 5.r

**IMPORTANT WARNINGS:**

- the earth connection must be made to the same point in the earth line (same earth pole, for all the pCO boards)
- with these configurations (Figs. 5.e, 5.f and 5.g) Class 2 safety transformers must be installed.
- if the G0 terminals of the pCO controllers are connected together, connect the pLAN cable shield to one pCO only.

**5.7 Remote installation of a terminal in a pLAN network**

When the pCO boards are connected in a pLAN network, the terminal can be remotely-installed at a distance of up to 50 metres, if using a telephone cable, while it can be located at a distance of up to 500 metres if using a shielded cable, TCONN6J000 and a separate power supply.

**Note:** to reach the maximum length, use a bus layout with branches that do not exceed 5 m.

The following figures show the connection diagrams for the various configurations.

**If using the terminal in a residential environment, the cable must be always shielded.**

The maximum distance between the pCO and the user terminal is shown in the following table:

type of cable	power supply distance	power supply
telephone	50 m	taken from pCO (150 mA)
AWG24 shielded cable	200 m	taken from pCO (150 mA)
AWG20/22 shielded cable	500 m	separate power supply via TCONN6J000

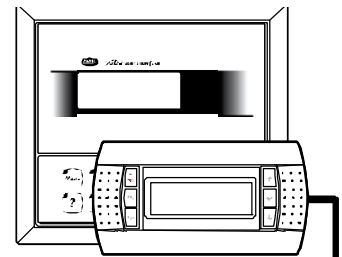

Tab. 5.a

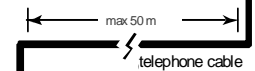

The maximum distance between two pCO<sup>3</sup> controllers with AWG20/22 shielded cable is 500 m.

**Important:** do not reverse the GND and +Vdc cables.

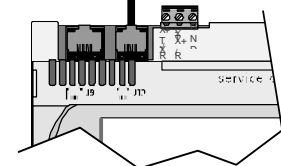

Fig. 5.s

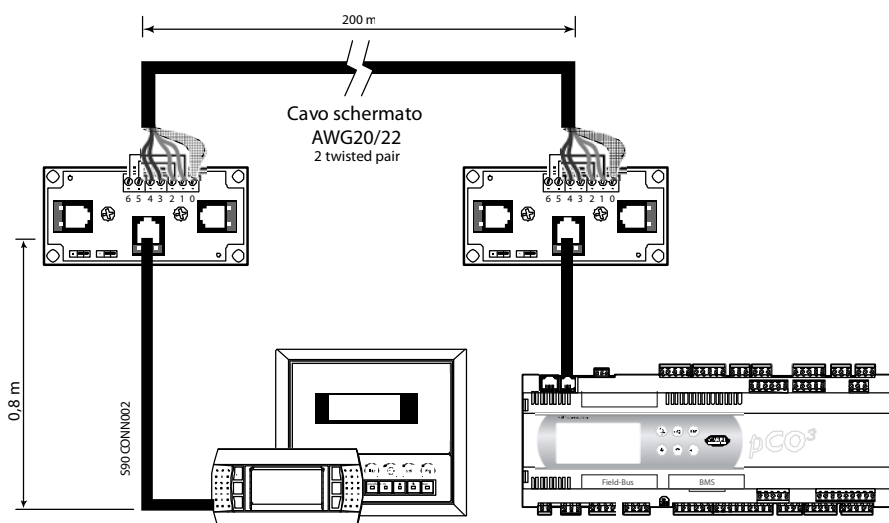
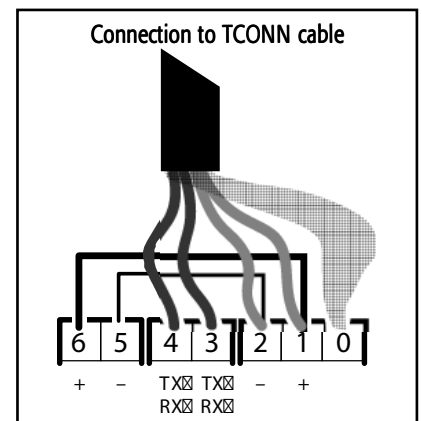

Fig. 5.s1



The Fig. 5.i represents the shunt code TCONN6J000, used in pairs for the remote installation of the pCO in the pLAN network with AWG20/22 shielded cable.

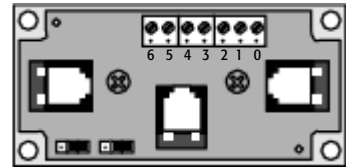

Fig. 5.i

**Cable AWG20/22 (with power supply)**

Terminal	Function	Cable connections
0	Earth	Shield
1	+VRL (H30 Vdc)	First pair A
2	GND	Second pair A
3	Rx/Tx-	Third pair A
4	Rx/Tx+	Third pair B
5	GND	Second pair B
6	+VRL (H30 Vdc)	First pair B

Tab. 5.b

**5.7.1 Remote installation of the terminal up to 500 m in pLAN network with AWG20/22 shielded cable**

This installation is shown in Fig. 5.l. It requires a separate power supply via TCONN6J000.

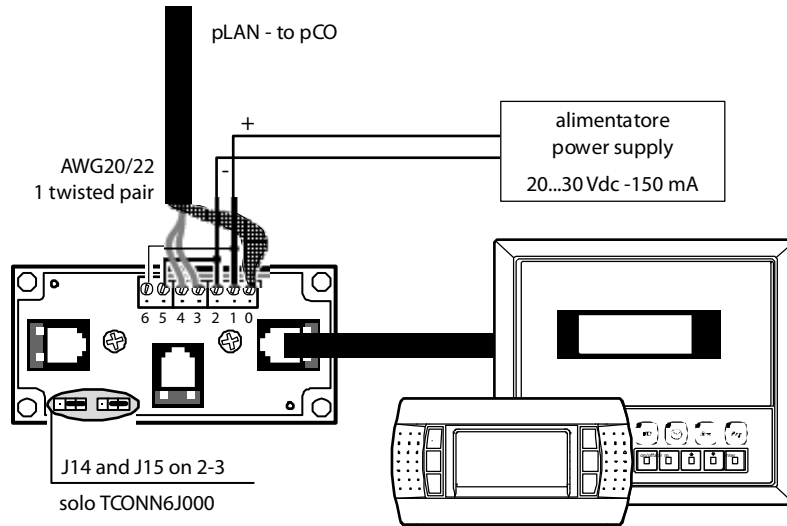

Fig. 5.u

**⚠ Important:** the overall length of the network must not exceed 500 m. Consequently if the terminal is also remote the length of the cable to the terminal is included in the calculation of the total length.

**⚠ The terminal cable** represents a branch of the network, and therefore if this is greater than 5 m in length it can only be connected to the first or the last pCO in the network.

**5.8 pLAN network technical specifications**

The technical specifications of the pLAN network are summarised in the following table:

description	characteristic
Standard communication	Asynchronous HALF DUPLEX RS485
Baud rate (kbit/s)	62.5 115.2 for pCO <sup>3</sup> (selected by software)
Protocol	Multimaster (CAREL proprietary protocol)
Maximum length of the network (m)	500

**5.8.1 Optically-isolated pLAN (pCO<sup>3</sup> only)**

The pCO<sup>3</sup> is also available with an optically-isolated serial pLAN. This simplifies installation, as the earthing requirements of the pCO<sup>3</sup> do not need to be observed. The pCO<sup>3</sup> controllers can be connected to earth points with different voltages without the shield carrying current.

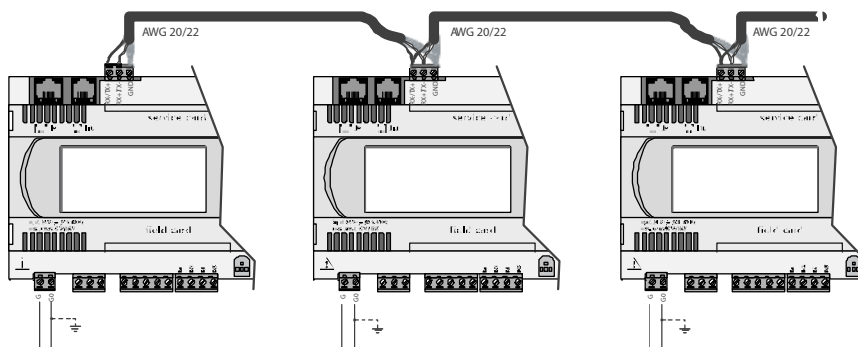

Fig. 5.v



## 6. OPTIONS AND EXTERNAL MODULES

CAREL has always offered its customers different to interface the pCO sistema controllers with the more commonly-used BMS (Building Management Systems).. Today in fact, with the expansion of BMS, the issue of communication between controllers made by different companies is increasingly important. CAREL has consequently developed compatibility with all the protocols that are emerging as the standards in HVAC/R and intelligent management systems, such as Modbus®, LonWorks®, BACnet™, SNMP.

As regards communication between controllers made by different companies, CAREL offers an excellent variety of solutions that allow the pCO family controllers to interface with controlled field devices, such as valves, VFD, serial sensors, Belimo actuators etc. In this way, the pCO controller does not just manage the single unit, but the entire air-conditioning / refrigeration system.

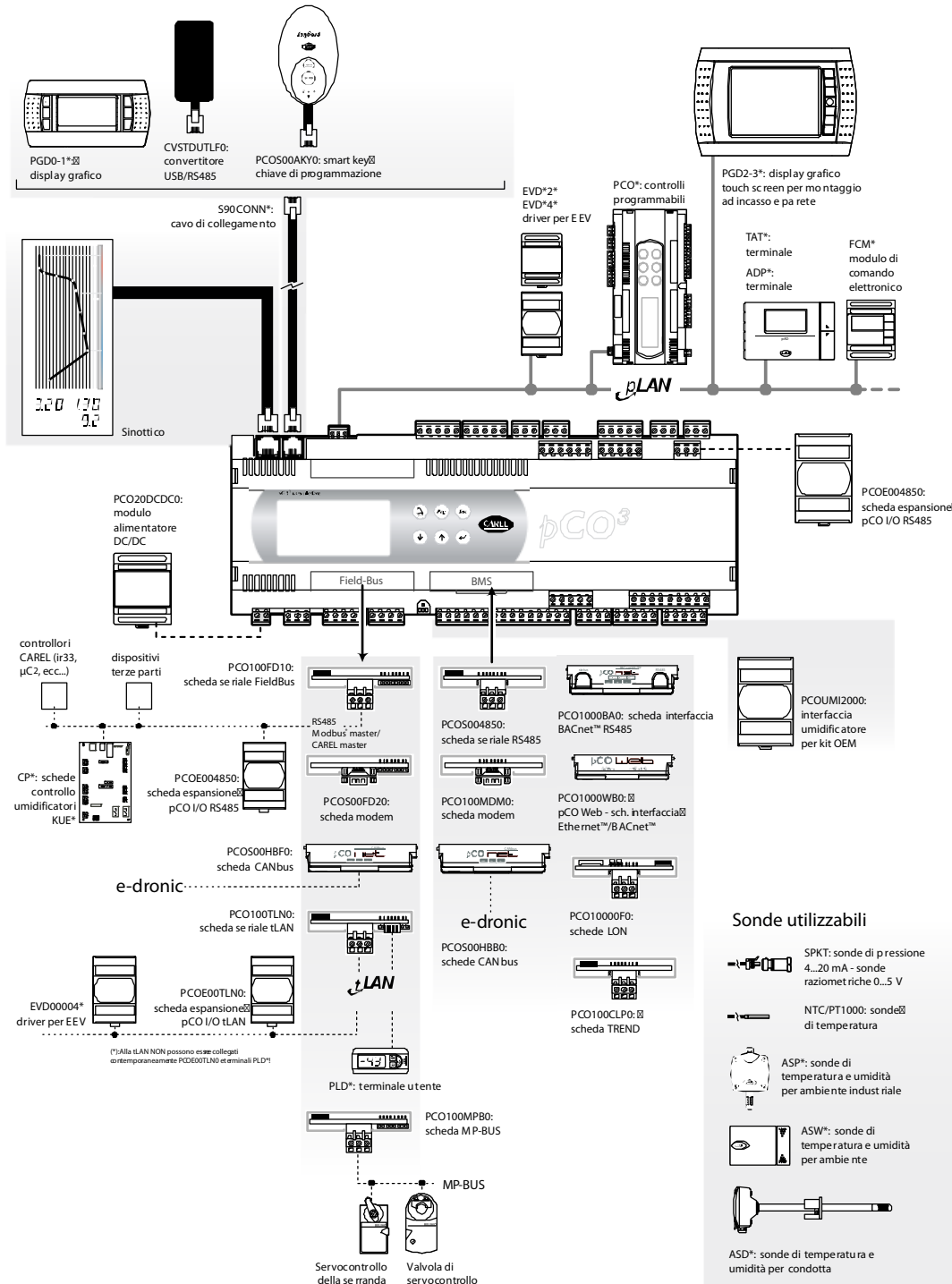

### Field Bus options

Optically isolated 485	PCO100FD10
tLAN	PCO100TLN0
Belimo MPbus	PCO100MPB0
modem	PCOS00DF20
CAN hydronic	PCOS00HBF0

### BMS options

CANbus	PCOS00HBB0
485/Modbus	PCOS004850
modem	PCO100MDM0
Trend board	PCO100CLP0
Ethernet board	PCO1000WB0 PCO1000BA0

### LonWorks

LonWorks	FTT10	PCO10000F0
LonWorks	FTT10 standard chiller profile	PCO10001F0

## 6.1 Connectors

Example of coding: PCO3CON\*\*0 see the following table for the description:

PCO3CON	*	*	0
	0= screw 1= spring	S= small M= medium L= large Z= extra large N.O. C= extra large N.C.	

## 6.2 Optional pCO sistema boards

### 6.2.1 Serial boards for supervision and telemaintenance

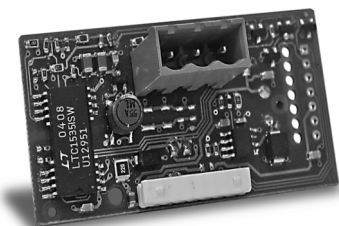

#### RS485: PCOS004850

The PCOS004850 board is an option for the pCO electronic controllers that is used to interface these with a RS485 network. It guarantees the optical isolation of the controller from the RS485 serial network. The maximum baud rate is 19200 baud (settable via software).

For the technical specifications and the meanings of the connections (pins), as well as details on the procedure for fitting the board, follow the instructions shown on the instruction sheet provided in the packaging (code +050003237).

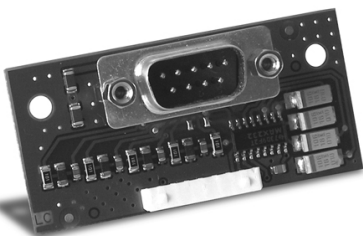

#### RS232 serial board for modem management: PCO100MDM0

The PCO100MDM0 is an option for the pCO electronic controllers that is used to interface these with a standard HAYES modem, managing the following:

- output, "request to send" (RTS) in parallel with "data terminal ready" (DTR);
- input, "carrier detect" (CD).

The maximum baud rate is 19200 baud. For the technical specifications and the meanings of the connections (pins), as well as details on the procedure for fitting the board, follow the instructions shown on the instruction sheet provided in the packaging (code +050003240).

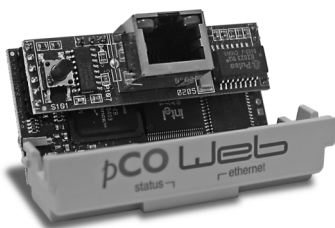

#### Ethernet serial board: PCO1000WB0

Used to interface the pCO controllers with the BACnet™ Ethernet™, IP, SNMP V1, 2, 3, FTP and HTTP protocols.



#### BACnet™ MSTP RS485 interface board (PCO1000BA0)

Used to interface the pCO controllers with the BACnet™ MSTP protocol, an emerging protocol in the HVAC market



#### CANbus serial board: PCOS00HB0

These devices allow the pCO controllers to be connected to CANbus networks, and more precisely, to the e-drofan controllers for fan coils, exploiting the potential of the e-dronic system. This ensures simpler management of the installation, optimising comfort, synergies between the controllers and running costs.

For the technical specifications and the meanings of the connections (pins), as well as details on the procedure for fitting the board, follow the instructions shown on the instruction sheet provided in the packaging (code +050000162).



#### LonWorks® serial board: PCO10000F0

The PCO10000F0 and PCO10000R0 optional boards for the pCO electronic controllers are used to interface these with a LonWorks network®.

**Warning:** in order to be operational, the interface board must be programmed based on the application installed on the pCO.

Information on the procedure for programming the board is provided in the manual code +030221960.

The program is resident in flash memory fitted on a socket, and can be programmed directly via the LonWorks® network, using the network installation and maintenance tools such as LonMaker™.

The boards differ based on the type of LonWorks® network interface and the type of electronic controller it can be fitted on:

- PCO\*0000F0 - interface to FTT-10A 78 kbs (TP/FT-10);
- PCO\*0000R0 - interface to RS485 39 kbs (TP/485-39).

The baud rate of the pCO must be set to 4800, while the pCO address is not significant, as this is automatically recognised by the board. An option already programmed with the standard chiller profile is also available: code PCO10001F0. For the technical specifications and the meanings of the connections (pins), as well as details on the procedure for fitting the board, follow the instructions shown on the instruction sheet provided in the packaging (code +050004040).

#### TREND board: PCO100CLP0

This is used for communication with the TREND interface, a building automation system that is very widespread in English-speaking countries.

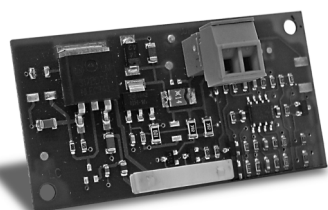

## 6.2.2 Serial boards for connection to a "field bus" network

The optional Field bus boards offer a serial interface that allows the pCO<sup>3</sup> and pCO<sup>1</sup> to communicate with other devices over various standards. In fact, the tLAN, MP bus and RS485 options interface the pCO to a network of devices including actuators, probes, expansions and terminals.

#### Electrically insulated RS485 serial board: PCO100FD10

The PCO100FD10 option is used to connect the pCO<sup>3</sup> and pCO<sup>1</sup>, via an electrically insulated interface, to an RS485 network, using the connector with plug-in terminals on the board. The controller consequently acts as the MASTER (i.e. supervisor), and therefore other pCO controllers or SLAVE devices can also be connected. The meaning of the pins on the connector are denoted by the screen printing on the board. A maximum of 207 connectable devices using this type of connection. If the optional board occupies the last position on the supervisor serial line and the line is longer than 100m, the line must be terminated by connecting a 120Ω - 1/4 W resistor to the terminal pins.

If the function set is SLAVE, on the other hand, only one pCO with this optional board can be connected to the network.

#### tLAN and PST board: PCO100TLN0

The PCO100TLN0 option is used to connect the pCO<sup>1</sup> to a tLAN network using two separate connectors.

The first connector is used to connect the pCO<sup>3</sup> and pCO<sup>1</sup> to a tLAN network. Using this connection and a suitably-configured application in tLAN MASTER mode, the pCO<sup>1</sup> can interact with the pCO I/O expansion (tLAN version - PCOE00TLN0) or with other pCO controllers fitted with a tLAN connection, configured in tLAN SLAVE mode.

A maximum of 5 connectable devices using this type of connection.

The second connector, on the other hand, is used to connect a PNT or PST terminal. Using this connection and a suitably-configured application, the pCO<sup>3</sup> and pCO<sup>1</sup> can interact with a PNT terminal. Both connections require a shielded cable with a maximum length of 10 m.

**Important:** the two connectors cannot be used at the same time.

#### MP-Bus board: PCO100MPB0

The PCO100MPB0 option is used to connect the pCO<sup>3</sup> and pCO<sup>1</sup> to an MP-Bus network made up of I/O devices according to the Belimo standard. Up to 8 actuators can be connected at the same time, over a maximum distance of 30 m. For the connection of a temperature sensor, active or passive, or a digital contact, see the specific Belimo documents ([www.belimo.ch](http://www.belimo.ch)).

As regards the procedure for setting the network addresses, these are described in the specific manuals on the individual applications. For the technical specifications and the meanings of the connections (pins), as well as details on the procedure for fitting the board, follow the instructions shown on the instruction sheet provided in the packaging (code +050003270).

#### RS232 serial board for modem management: PCOS00FD20

The PCOS00FD20 board is an option for the pCO<sup>1</sup>/pCO<sup>3</sup> electronic controllers to interface these directly with a standard HAYES modem. The board manages the "request to send" (RTS) in parallel with the "data terminal ready" (DTR).

For the technical specifications and the meanings of the connections (pins), as well as details on the procedure for fitting the board, follow the instructions shown on the instruction sheet provided in the packaging (code +050003295).

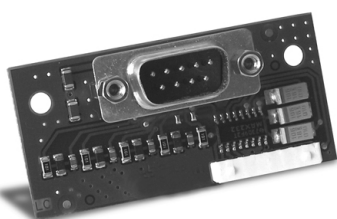

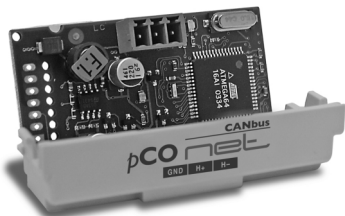

**CANbus serial board: PCOS00HBFO**

These devices allow the pCO controllers to be connected to CANbus networks, and more precisely, to the e-drofan controllers for fan coils, exploiting the potential of the e-dronic system. This ensures simpler management of the installation, optimising comfort, synergies between the controllers and running costs. For the technical specifications and the meanings of the connections (pins), as well as details on the procedure for fitting the board, follow the instructions shown on the instruction sheet provided in the packaging (code +050000162).

**6.2.3 Other types of optional boards**

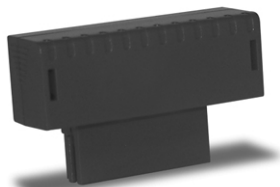

**Memory expansion PCO100CEFO**

If the flash memory is not sufficient for the application program or the logs, the capacity of the pCO<sup>1</sup> can be expanded by fitting an expansion board. This option also includes the clock board and 32 KB of E2PROM memory. Consequently, remove the PCO100CLK0 if the PCO100CEFO is used. For the technical specifications and details on how to insert the expansion board, carefully follow the instructions shown on the instruction sheet provided in the packaging. For information on the connections and the sequence of the operations, see the instruction sheet (code +050003245).



**Clock board PCO100CLK0**

For the pCO<sup>1</sup> and pCO<sup>3S</sup>, the PCO100CLK0 board option is used to manage the time and date, as well as providing an extra 52 bytes of RAM with battery backup. Do not fit this option on a pCO<sup>1</sup> that has been installed with the PCO100CEFO. For the technical specifications and the meanings of the connections (pins), as well as details on how to insert the expansion board, follow the instructions shown on the instruction sheet provided in the packaging. For information on the connections and the sequence of the operations, see the instruction sheet (code +050003230).

**IMPORTANT WARNINGS:** operator safety and precautions to be observed when handling the board/boards.

To safeguard operators and the boards, disconnect power before performing any operations.

Electrical damage may occur to the electronic components as a result of electrostatic discharges from the operator. Suitable precautions must be therefore be taken when handling these components. Specifically:

- before using any electronic component or board, touch an earthed object (simply not touching the board does not prevent discharges, as static electricity can produce a 10000V spike, which can form an arc of about 1cm);
- all components must be kept inside their original package as long as possible. If necessary, take the board from its package and place it into an antistatic bag, without touching the back of the board;
- absolutely avoid using non-antistatic plastic bags, polystyrene or sponge, and avoid passing the board directly to other operators (to prevent electrostatic induction and consequent discharges).

**6.2.4 External modules and interfaces**

**Interface for the OEM series humidifiers (PCOUMI2000)**

The PCOUMI2000 module is an interface for the pCO electronic controllers. This allows the control of the fundamental parameters of the OEM humidifiers manufactured by CAREL (level and conductivity of the water in the cylinder, TAM sensor for current input) directly from the pCO electronic microprocessor controller. The values measured by the sensors are converted into signals that can be read by the inputs on the pCO (for more information refer to the user manual for the application program).

The PCOUMI2000 interface differs from the PCOUMID000 interface due to:

- greater precision and immunity to disturbance both as regards the conductivity reading and the level sensor;
- the "high water level" signal can be managed either as a digital or analogue output.

Consequently, the controller can be connected to both the PCOUMID000 and the PCOUMI2000 board, with the only difference being the setting of the corresponding parameter, so as to tell the software to use the correct conductivity curve.

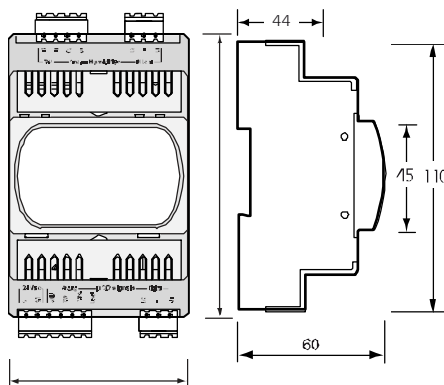

Fig. 6.b

For the technical specifications and the meanings of the connections (pins), as well as details on the procedure for fitting the board, follow the instructions shown on the instruction sheet provided in the packaging (code +050003210).



### DC/DC module (PCO20DCDC0)

The PCO20DCDC0 power supply module is an option for the pCO electronic controllers.

It stabilises the DC output voltage at  $24 \pm 1$  Vdc/0.7 A (pCO controller side) for input voltages (power source) from 21 to 58 Vdc (for example, from 48 Vdc storage batteries, typically used in telephone applications).

The maximum power delivered is 17 W, which can supply any pCO electronic controller. The input and output of the power supply module feature functional galvanic isolation.

For the technical specifications and the meanings of the connections (pins), as well as details on the procedure for fitting the board, follow the instructions shown on the instruction sheet provided in the packaging (code +050004020).



### SMART KEY (PCOS00AKY0 and PCOS00AKC0)

The PCOS00AKY0 key is an electronic device used to program and manage the pCO sistema family controllers. PCOS00AKY0 simplifies the transfer of data between the installed controllers and a personal computer, and features ample flash memory for storing software applications, Bios and variable logs. The key is connected to the pCO directly via the telephone connector using the cable supplied, while to transfer data to/from a personal computer, the USB adapter code PCOS00AKC0 is required (not optically-isolated converter, for the Smart Key only). The power supply can come either from the USB port on the PC or from the controller, therefore no external power supply is required. For the technical specifications and the meanings of the connections (pins as well as details on the procedure for fitting the board, follow the instructions shown on the instruction sheet provided in the packaging (code +050003420).



### USB/RS485 converter (CVSTDUMORO/CVSTDUTLFO)

The USB-RS485 converter is an electronic device that is used to interface a RS485 network with a personal computer via the USB port, to be used with WINLOAD. The converter is available in two versions: CVSTDUTLFO, fitted with a six-pin telephone connector, and CVSTDUMORO, fitted with a three-pin terminal block. These are optically-isolated and cannot be used with the Smart Key. For the technical specifications and the meanings of the connections (pins), as well as details on the procedure for fitting the board, follow the instructions shown on the instruction sheet provided in the packaging (code +050000590).

### pCO I/O expansion boards

The "PCOE000TLN0 and PCOE0004850" expansion boards are electronic devices that are part of the pCO sistema family and have been designed to increase the number of I/Os available for the pCO controllers. A maximum of 5 expansion boards can be connected to each pCO controller.

#### Versions available:

- PCOE00TLN0 tLAN version (CAREL proprietary protocol);
- PCOE004850 RS485 version (CAREL 3.0 supervisor protocol).

For the technical specifications and the meanings of the connections (pins), as well as details on the procedure for fitting the board, follow the instructions shown on the instruction sheet provided in the packaging (code +050003265).



### Driver for electronic expansion valves (EVD\*400)

The EVD0000400 module for electronic expansion valves with two-pole stepper motor is a controller that manages the expansion of the refrigerant in a refrigerant circuit. This function is achieved by optimising the opening of the valve using a PID algorithm and some special auxiliary control routines. The driver has a tLAN interface for connection to a Master unit, an RS485 adapter (featured in models \*410, \*411, \*420 and \*421) that allows connection to units with the supervisor protocol, from 4800 to 19200 baud, or with the pLAN protocol. The driver automatically recognises the protocol and the baud rate. Alternatively, the driver can operate in stand-alone mode.

As well as the serial connection, in any configuration described above, the driver can be accessed for configuration or monitoring via an auxiliary "service" serial port at 4800 baud with supervisor/tLAN protocol and network address = 1 (fixed). The USB converter CVSTDUTLFO is required to use the "service" serial port. This connection is for temporary use. If using the "service" serial port or the supervisor protocol on the main serial port, the EVD4UI program is available; this has a user-friendly graphic interface and is available on the KSA site.

### Phase control module

The controller works with two-pole stepper motors. It operates with a theoretical sinusoidal waveform, in micro-steps and with speeds from 5 to 1000 steps; the current and the control speed effectively achievable depend on the resistance and the inductance of the motor windings used. If the driver is connected to a pCO, it receives all the individual operating parameters for the motor from the pCO controller. The controller can manage motors with maximum positions of up to 32000 steps.

For connection use 4-wire shielded cables, AWG18/22, max length 9.5 m.

The shield should be connected to the closest possible earth point in the panel. For the technical specifications and the meanings of the connections (pins), as well as details on the procedure for fitting the board, follow the instructions shown on the instruction sheet provided in the packaging (code +050003875).

## 6.3 Signal LEDs and software updates

### Decoding the LED signals on the pCO board

The pCO boards feature 3 signal LEDs (red, yellow and green) that provide information on the operation of the pCO board itself and the status of the pLAN serial link, regardless of whether or not the built-in display is included.

**Note:** the following is valid for the pCO<sup>3</sup> and in certain cases for the pCO<sup>1</sup>, pCO<sup>6</sup> and pCO<sup>XS</sup>.

Corresponding to J23 is a LED that flashes to indicate traffic over the connection between the pCO LARGE and the I/O expansion network.

#### Key

○ LED off ● LED on ✨ LED flashing

RED LED	YELLOW LED	GREEN LED	
			<b>pCO<sup>2</sup> NOT in pLAN (address= 0)</b>
○	○	○	correct operation with or without local terminal.
			<b>pCO<sup>2</sup> pLAN address set</b>
●	○	○	application error or no pLAN table.
●	●	●	application error or no pLAN table. pCO ONLY connected to a terminal.
○	●	○	application with correct pLAN table.
○	●	●	correct pLAN operation.
			<b>pCO<sup>2</sup> in low level mode (*)</b>
○	✨	○	awaiting communication with WinLoad. check pCO address on WinLoad
○	✨ / ○	✨ / ○	(LED flashing alternately) invalid communication with WinLoad. Possible causes: - no power supply to the RS232/485 converter - wrong driver on the PC.
○	○	✨	communicating with WinLoad.
			<b>pCO<sup>2</sup> in normal operation</b>
○	✨	✨	communication with WinLoad suspended. After 20 s the original protocol is reset on the pCO.
✨	✨	✨	Winload not suitable or incorrect Software Protection Password.
○	●	✨	communicating with WinLoad.
			<b>pCO<sup>2</sup> used as I/O expansion</b>
○	○	●	CAREL supervisor protocol (slave) active on serial 0.

Tab. 6.a

#### 6.3.1 Cases in which the pCO enters "LOW LEVEL" status

- During start-up, the pCO sees that WinLoad is connected (only up to BIOS 3.57).
  - During start-up, the pCO detects an "Application corrupted.." (only up to BIOS 3.57).
  - During normal operation, the pCO runs a JMP atom that is missing the correct reference or refers backwards.
- After 20 seconds of Low level status without WinLoad connected, the pCO is reset automatically.

## 7. UPDATES, FIRMWARE AND LOGS FOR PCO CONTROLLERS

The following systems can be used to update and acquire the firmware and logs to/from the pCO controllers:

- Winload;
- SmartKey.

### 7.1 WINLOAD

In all CAREL 16-bit pCO sistema controllers the resident software can be updated from a PC. To do this, CAREL provides the WinLoad32.exe program and an RS485 serial converter for the pCO. The special driver needs to be installed on the PC, again supplied by CAREL.

WinLoad32.exe is included in the installation of the "Easy Tools" program suite, inside the pCO Manager program or alternatively is available separately at the site <http://ksa.carel.com> in the "download : support : software utilities" section.

The installation includes, as well as WinLoad32.exe, the user manual and the driver for the RS232-485 converter. The pCO controller can be connected directly to the PC via the RS485 serial port used for the "pLAN" connection, or alternatively via the optional BMS serial port used for the "supervisor" connection, with the RS485 serial board.

The BMS serial port and the optional RS232 serial port can be used to connect the pCO to an analogue (PSTN) or GSM modem and consequently establish a remote connection to WinLoad32.

Winload can communicate with all the pCO family programmable controllers.

The program is used in general to update and download to the PC the BOOT, BIOS, application, configuration files and logs, and in special cases, such as with the pCO<sup>3</sup>, also save files to the new NAND flash.

It should be stressed that updating the BOOT is generally **NOT RECOMMENDED** by Carel; Carel always loads the BOOT required for the correct operation of the unit directly during production. Only in very special cases will Carel ask the user to update the BOOT.

The BIOS can only be loaded using the pLAN serial connection. Updating the BIOS changes the unit operating mode to low level. In this mode, the data logs cannot be downloaded to the PC nor the application loaded in compressed format. To restore the unit to normal communication mode with Winload, reset the pCO after having successfully loaded the BIOS.

Winload is configured automatically for the unit connected, for example, certain versions of Bios can be loaded or are inhibited, the log configuration may or may not be available for download, the possibility of the unit to use the expanded RAM is recognised and therefore an application that uses all the RAM available may or may not be loaded.

In special cases, nonetheless, certain options need to be set, for example, the baud rate if the pCO is a pCO with 14.7 MHz or 16 MHz quartz, using the command line of a normal Windows connection with the Winload32.exe executable.

The on-line help and the "CHANGELOG" register file in any case provide help to the user.

In general, the sequence of operations for establishing communication between Winload in graphic mode and pCO is as follows:

- connect the serial converter or USB to the PC and to the pCO;
- open the Winload program on the PC, by double clicking the icon after having activated any options by command line;
- on the main screen, set the serial port on the PC that the serial converter is connected to and the pLAN address of the pCO in question;
- power up the pCO;
- wait for the controller to come online, as indicated at the bottom left of the main screen;
- then select the desired directory on the main page to perform the desired operation.

For "EASYWINLOAD" mode, used for automatic loading with the settings made before running the program, and for the remote connection via MODEM, see the online help in the Winload program.

The download options are listed in the tables below:

LOCAL	pLAN serial	BMS serial	FieldBus serial
Load Boot and Bios	YES	NO	NO
Load application and parameters	YES	YES	YES
Load/download logs	YES	YES	YES
Load/download NAND flash (pCO <sup>3</sup> )	YES	NO	NO

REMOTE	pLAN serial	BMS serial	FieldBus serial
Load Boot and Bios	NO – modem not connectable	NO	NO
Load application and parameters	NO – modem not connectable	YES	NO
Load/download logs	NO – modem not connectable	YES	NO
Load/download NAND flash (pCO <sup>3</sup> )	NO	NO	NO

All the WinLoad32 program functions are also available in the PcoManager tool, which includes the Commissioning Tool.

## 7.1.1 Commissioning Tool

Settings required to use the Commissioning Tool

Settings on the pCO for using the Commissioning Tool:

- 1) the application must feature a screen used to set the Winload protocol on the serial port where the PC with the Commissioning Tool is connected. Otherwise, there must be another possible procedure for selecting the protocol (e.g. from supervisor).
- 2) In the remote connection correctly set the system variables relating to the PSTN or GSM modem.
- 3) To run the operations made available with the commissioning tool, connect when the application is already running; this means that procedures must be available for setting in advance (screen in the application or supervisor) the Winload protocol after that the pCO has been powered up. If the pCO is directly connected via pLAN serial on power-up, it enters Winload mode and the operations relating to the commissioning tool cannot be managed.
- 4) If the firmware and the application are updated, the pCO must be reset before being able to use the Commissioning Tool.
- 5) Once the protocol has been set correctly on the desired serial port, the PC can be connected. IMPORTANT: if using the BMS or FIELDBUS serial port, once the pCO is disconnected by command from the PC (for example, when switching from the PCOLOAD window to the Commissioning Tool window and vice-versa) the pCO restores the protocol that was previously set on the serial port in question. If the application was previously updated, on the other hand, the pCO is automatically reset. To reconnect the pCO in these cases, restore the Winload protocol on the pCO.

### Memory limits:

The periodical monitoring of the variables in the application is limited to a maximum of 250 WORDS, which can be defined as desired from the entire memory available to the application. The application variable virtualisation function is limited to a maximum of 50 WORDS, which can be defined as desired from the entire memory available to the application.

There are no address setting limits to writing and reading the individual "one-shot" variables: all the memory addresses reserved for the application are available, in all types of memory on the pCO: X memory, T memory, P memory, E memory.

## 7.2 Smart Key

The new SMARTKEY programming key is used to emulate the operation of the parallel programming key on the models of pCO where this is not available (pCO<sup>XS</sup>, pCO<sup>3</sup>), with the exception of the BOOT, which is not loaded by the SMARTKEY. Specifically, the key can clone the contents of a pCO and then download these to another identical pCO using the telephone connector on the terminals (the pLAN must be disconnected). This function is obviously available for all the pCO controllers, even those with the parallel key. As well as this mode, the key can also copy the logged data from a series of pCO controllers and then copy the data to a PC.

Using a PC running the "SMARTKEY PROGRAMMER", the key can be configured to run certain operations: copy logs, program applications, program the Bios, etc. For further details, see the online help in the "SMARTKEY PROGRAMMER" and the SMARTKEY instruction sheet.

## 7.3 NAND FLASH memory

This type of memory is only available on the pCO3 versions with codes pCO3 \*\*\* C/D/F/G/H/I \*\*.

Using Winload version 3.37 and the new pCOLOAD routine in the pCOMANAGER program, any type of file can be loaded into the NAND FLASH memory, for example, source files of the application on the unit.

As well as this function, the IUP, BLB (or BIN) and DEV files, representing the files of parameters, the screens to be displayed in the various languages and the control logic, can also be loaded to the NAND flash and then selected from a screen on the terminal to be used as the current application on the pCO. This means that multiple applications, or multiple languages, or alternatively multiple parameter files can be loaded to the NAND flash memory and then the desired application, language or set of parameters can be selected and loaded to main flash memory. The files in NAND flash memory can be selected for copying the main flash from a screen managed directly by the Bios. The procedure is described in the following paragraph.

### Limits:

- Currently (Bios 4.01) the number of files that can be saved to NAND flash memory is limited to 40.
- The NAND flash memory can only be updated using the local Winload connection and via pLAN serial.
- The maximum overall capacity of the memory is in any case limited to 32 Mbytes.

## 7.4 Checking the software installed on the pCO and other information

The current program version can be checked at any time (CRC code expressed in hexadecimal format), as well as whether this is run from the key or resident. To do this, simply proceed as described below.

### 7.4.1 Screens managed by the BIOS

Press the ALARM and ENTER buttons together for 3 seconds to display the following screen.

>	S	Y	S	T	E	M	I	N	F	O	R	M	A	T	I	O	N
	L	O	G		D	A	T	A									
	O	T	H	E	R		I	N	F	O	R	M	A	T	I	O	N
	N	A	N	D			F	L	A	S	H		F	I	L	E	S



Each of the four rows displayed accesses further screens, managed by BIOS and therefore always present, regardless of the application loaded. To access the functions relating to a row, simply select the row by moving the cursor "<" using the UP and DOWN buttons, and then confirm by pressing the ENTER button. To exit the screen press the MENU or Esc button on the terminal, or wait around 40 seconds.

The screens provide various types of information.

1. **SYSTEM INFORMATION:** selecting this function displays information on the software loaded and on the size of the RAM and Flash installed. The screen displayed is similar to the one below.

B	O	O	T	V	4	.	0	0	1	0	/	0	1	/	0	6	
B	I	O	S	V	4	.	0	0	0	3	/	0	2	/	0	6	
>	2	+	2	M	B	<											
A	P	P	.	C	R	C	:		3	3	5	D			2	M	B

The first row displays the BOOT version and date. In the example shown in the figure, the pCO is working with BOOT 4.00 of 10 January 2006. The second row displays the BIOS version and date. In the example shown in the figure, the pCO is working with BIOS 4.00 of 3 February 2006. The third row indicates the size of the Flash on board and, on the pCO1 and pCO2, also the size of the Flash in the parallel key or on the expansion board, if featured. The ">" and "<" characters indicate the starting Flash used by the pCO: to the left if the pCO starts from the Flash on board, to the right if the pCO starts from the key. In the example, the pCO is running the BOOT, BIOS and application loaded on the board, and there is no key nor memory expansion. The fourth row displays the CRC of the application and the amount of Flash it occupied. In the example, the CRC of the application is 335D and it requires 2 MB of memory to run. If this row shows 1 MB, a pCO with 1 MB Flash can run the program. The CRC is a number that summarises the application loaded in the flash memory on the pCO, as well as some other system information. Consequently, the version of the application can be recognised using the corresponding screen.

2. **LOG DATA:** selecting this function shows the data on any logs loaded on the pCO. If no log is present, the following screen is displayed.

0																			
N	O		L	O	G		D	A	T	A									
					P	R	E	S	S										
					[	M	E	N	U	]		O	R		[	E	S	C	]

If, on the other hand, at least one log is present, the first screen that is displayed is similar to the following.

1					D	I	S	P	L	A	Y		L	O	G		D	A	T	A
					W	h	i	c	h		m	e	m	o	r	y		?		
I	N	T	E	R	N	A	L			M	E	M	O	R	Y					

Detailed information on the use of the screens relating to the logs is available in the WinLoad manual.

3. **OTHER INFORMATION:** selecting this function displays the ID number associated with the pCO. The ID number is a unique code for each pCO manufactured by CAREL; this will be used in future applications.

I	D		N	U	M	B	E	R	:											
	0	0	2	6	3			1	1	4	4	1		-	1	8	0	8	2	

Not all the CAREL pCO controllers have an ID number; if this is not present, the following screen informs the user of this situation.

I	D		N	U	M	B	E	R	:											
N	O	T		P	R	E	S	E	N	T										

4. **NAND FLASH FILES:** this row is only displayed on the pCO3 boards that have additional NAND flash memory. Selecting this function displays the names of the IUP, BLB, GRP and DEV files saved in the NAND memory; an application can also be copied from the NAND memory to the main flash memory on the pCO. Each file name is shown on a screen similar to the one below.

[	X	]																		
P	G	D	2	3	_	A	L	L	.	g	r	p								

To move from one file to the next simply press the UP and DOWN buttons. Press the ENTER button to select the current file and copy it to the main flash memory. The files selected for the copy operation are marked by an "X" on the first row of their screen; in the example shown in the figure, the file called "PGD23\_ALL.grp" is selected to be copied. To start the copy procedure, press the UP or DOWN button until reaching the following screen:

				P	r	e	s	s		E	n	t	e	r						
	t	o		s	t	a	r	t		c	o	p	y	i	n	g				

and then confirm by pressing ENTER. For further information on the use of the NAND memory, see the WinLoad manual.

To exit these two screens, press the Menu button on the local terminal or wait around 40 seconds.

# 8. GENERAL CONNECTION DIAGRAMS

pCO<sup>3</sup>

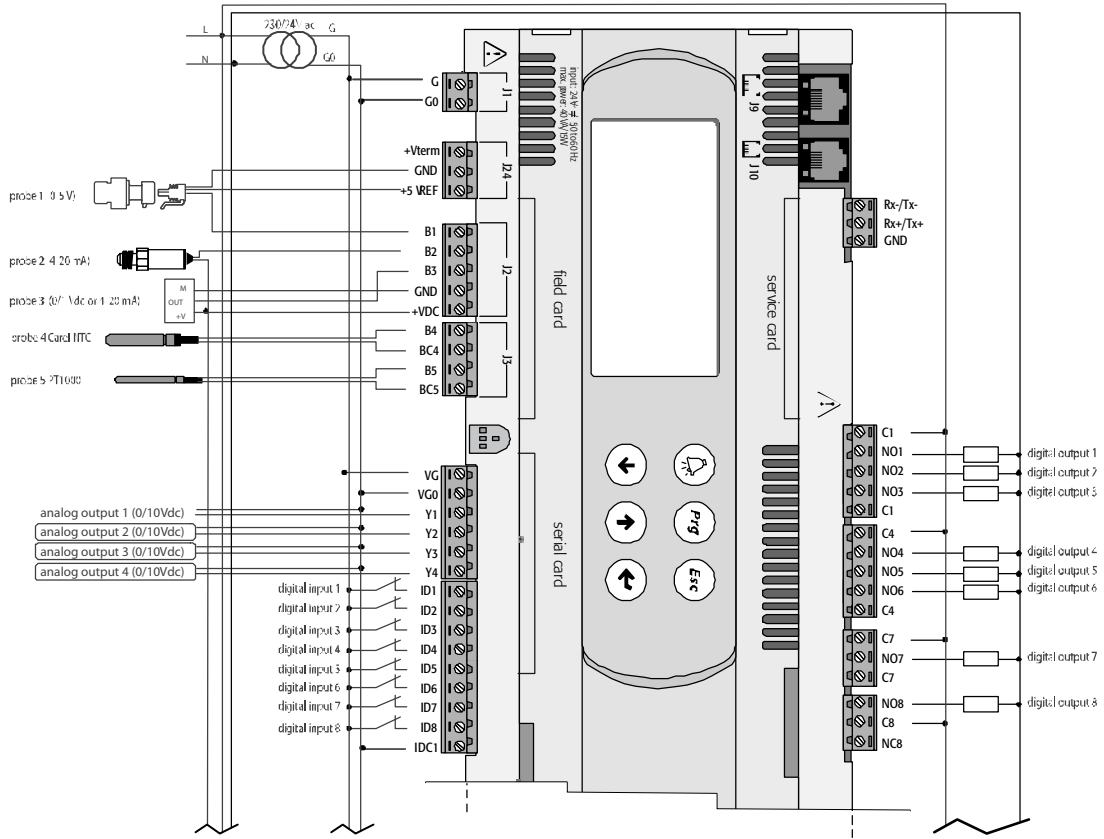

SMALL

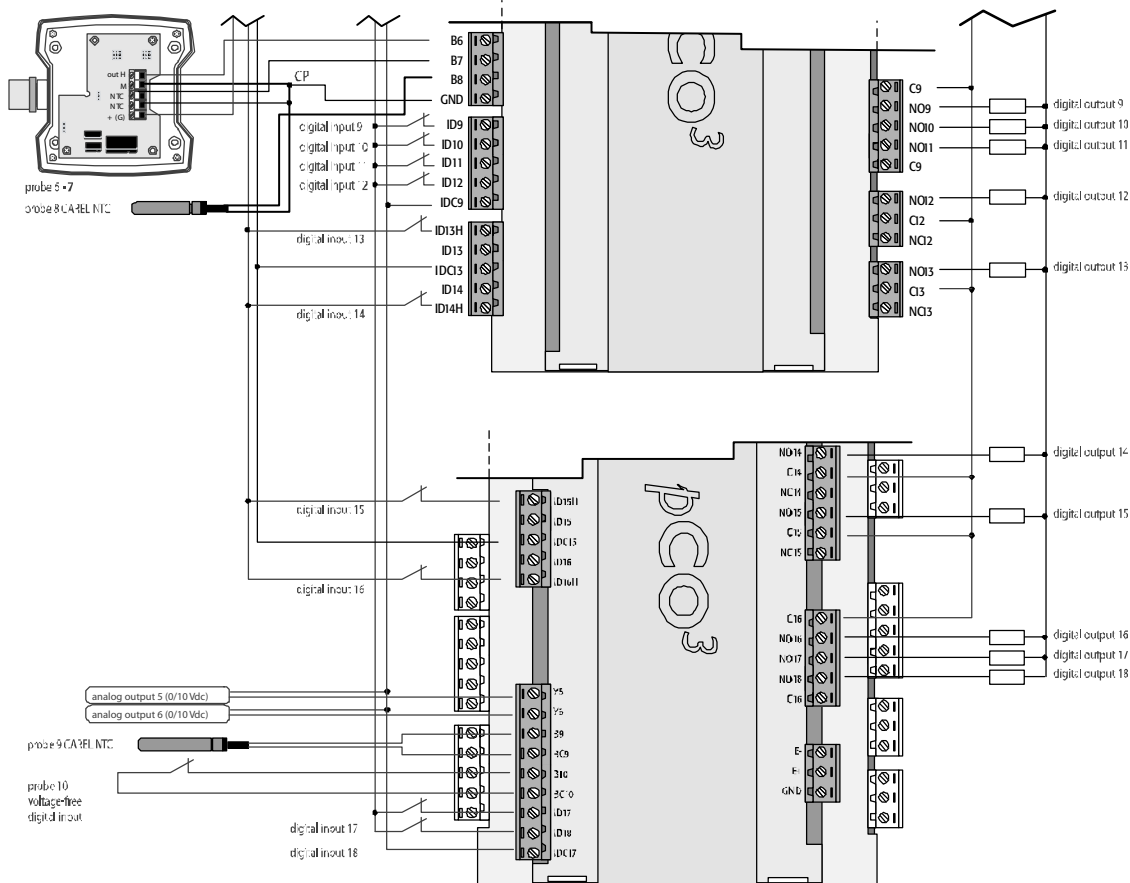

MEDIUM

LARGE

Fig. 8.a

pCO<sup>1</sup>

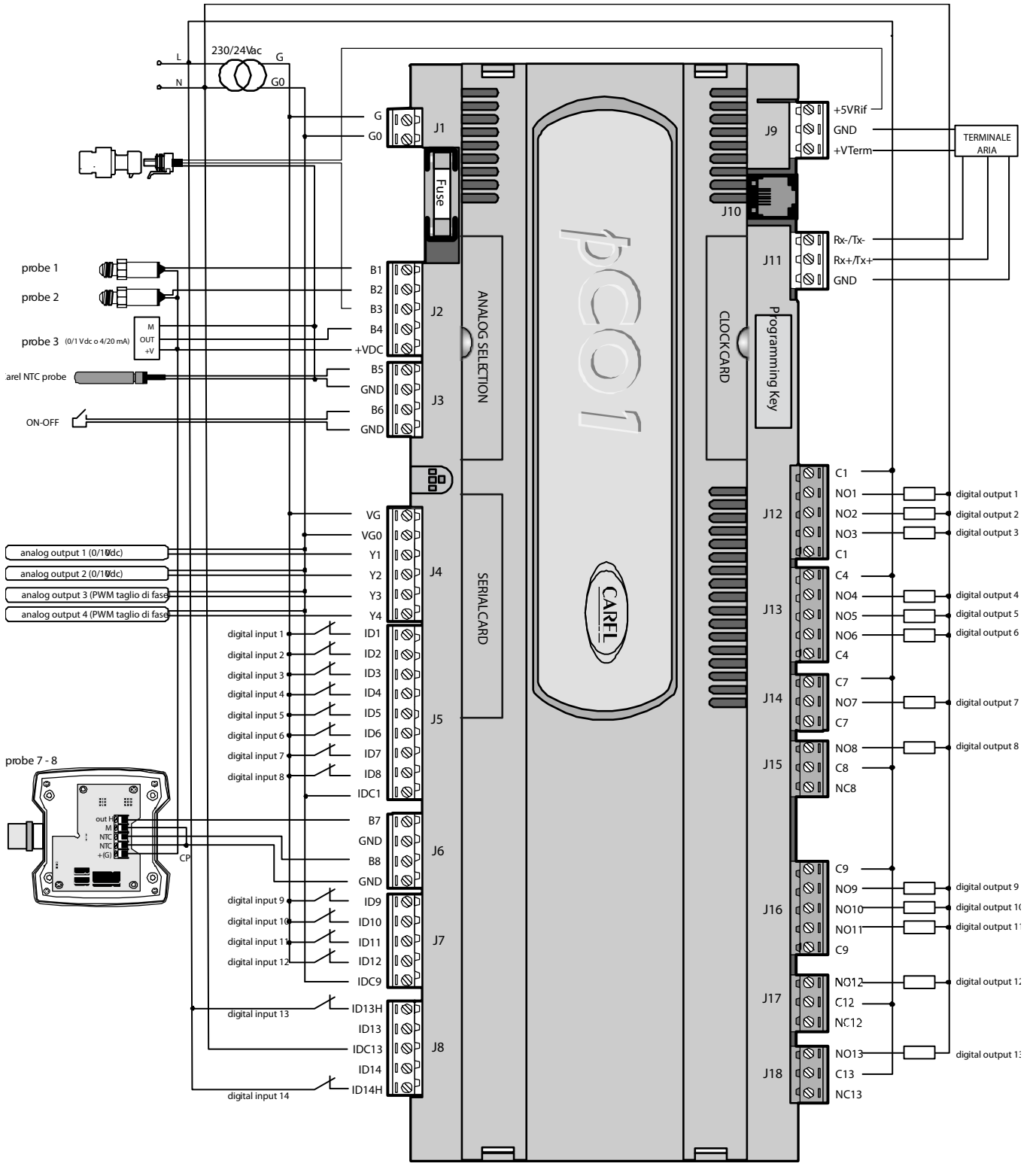

Fig. 8.b

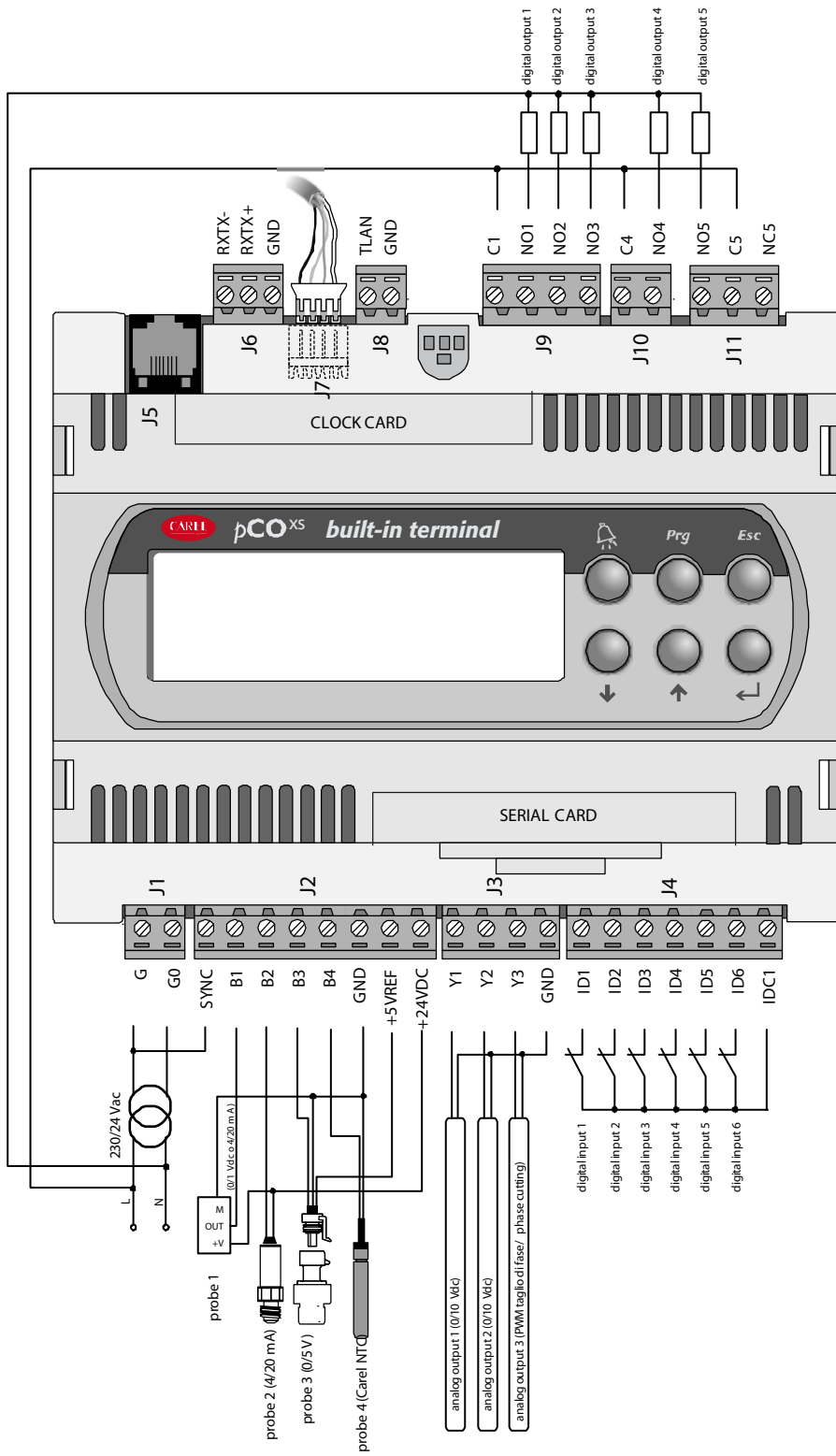

Fig. 8.c

pCO<sup>2</sup>

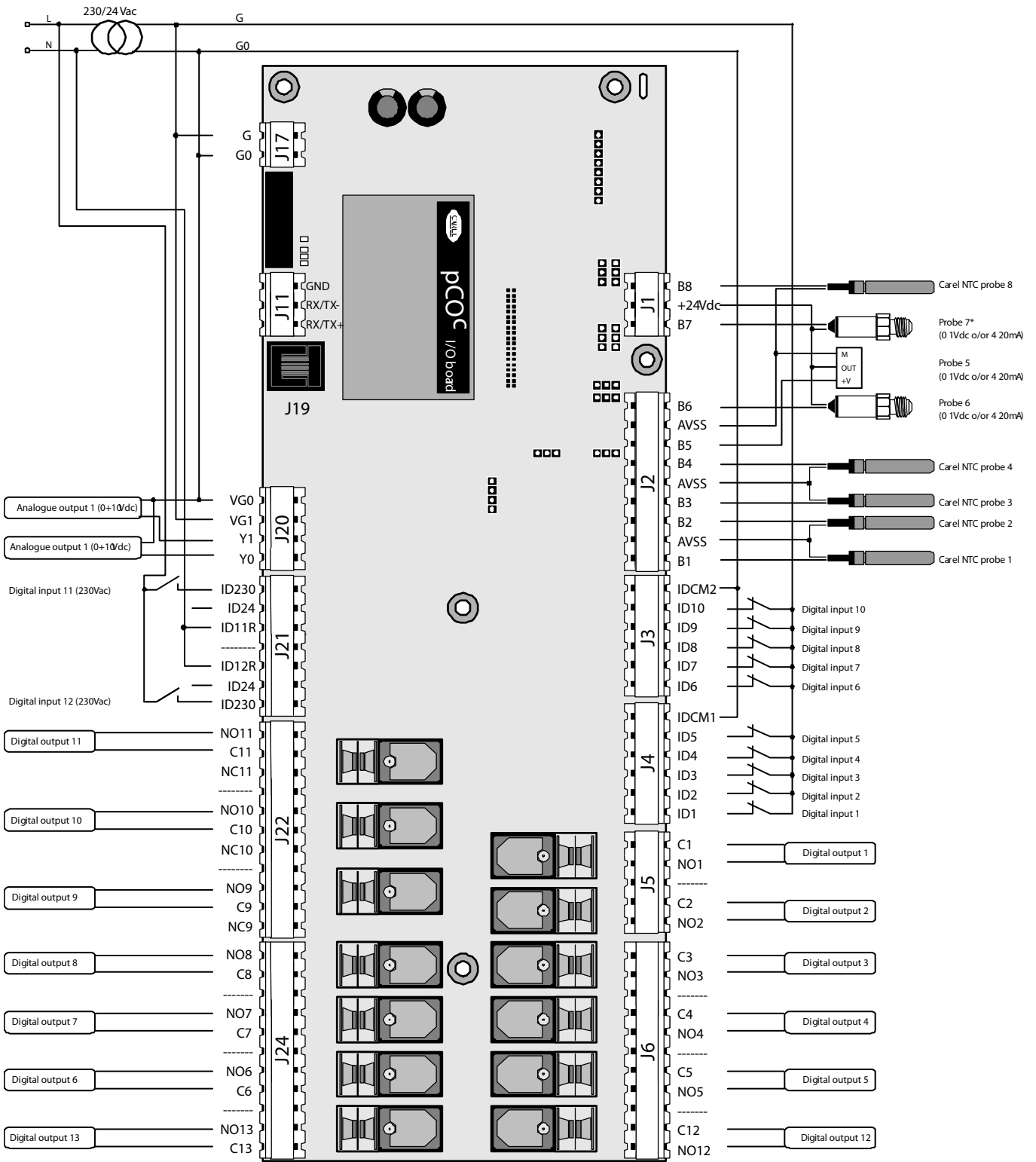

Fig. 8.d

## 9. TROUBLESHOOTING

- **The unit does not start (power LED off)**

Check:

1. the mains power supply;
2. that 24 Vac/Vdc is available downstream of the power transformer;
3. that the 24 Vac/Vdc power connector is plugged in correctly;
4. that the protection fuse is intact (if featured);

- **On power-up or during operation an error is signalled by the 3 LEDs: see chapter 6.3.**

- **On power-up various problems occur on the LCD (strange characters, blank display).**

Check:

1. correct software in the flash;
2. the pLAN address on the pCO and the terminal (compliant with the requirements of the application used);
3. if that the built-in display, is featured, is working correctly; the problem lies in the connection between the pCO and the terminal: make sure that the cable is plugged in correctly.

- **Incorrect reading of the input signals**

Check:

1. the correct power supply to the pCO;
2. the correct power supply to the probes: if the voltage (+Vdc > 20V) is near zero, disconnect the probe and measure the power supplied by the pCO. If this is still near zero, turn the controller off and wait a few minutes. If the problem persists, contact CAREL service; otherwise the connection that was removed was short-circuiting the power supply.
3. the separation of the power supply to the digital inputs from the power supply to the pCO. A 24 Vac/24 Vac transformer with a minimum rating of 5 VA can be used.
4. that the probe wires are connected according to the instructions;
5. that the probe wires are positioned a sufficient distance from possible sources of electromagnetic disturbance (power cable, contactors, cables with high voltages and running to devices with high peak current);
6. that there is not a high thermal resistance between the sensor and any probe socket that may be used. If necessary, place conductive paste or oil in the socket to ensure correct transfer of the temperature;
7. if there is a probe error or a conversion error on the pCO, the checks to be made depend on the type of probe.

- **Active humidity probes with 0 to 1 V signal:** use a voltmeter to check the probe signal between terminals Bn and GND and check that the voltage corresponds to the value: 1 mVdc corresponds to 0.1% RH

**Example:** reading 200 mVdc (0.2 Vdc), the probe sends a signal that corresponds to 20% RH

- **Pressure probes: if errors occur in the reading of these probes, check that:**

1. the analogue inputs used for the probes are set to accept 4 to 20 mA signals (in the application program);
2. the full scale set via software corresponds to the probes used;
3. the probe capillary is not blocked.
4. Measuring the voltage across terminals Bn and GND gives an indirect indication of the probe signal current, as the input has an impedance of 100Ω, applying the formula:  $I = V/R$  (2V = 20 mA).

The pressure value "Ps" that the probe is sending can be calculated as follows (FS = Full scale):

$$Ps = (V_{meas}/100 - 0.004) \times (FS_{max} - FS_{min}) / 0.016 + FS_{min}$$

Example: the probe used has FS<sub>min</sub> = -0.5 bar, FS<sub>max</sub> = 7 bar; the voltage read is equal to V<sub>meas</sub> = 1 Vdc.

The pressure Ps that the probe is measuring is equal to:  $Ps = (1/100 - 0.004) \times [7 - (-0.5)] / 0.016 + (-0.5) = 2.3$  bars.

- **NTC probes:** the probe signal is a resistance value that depends on the temperature.

Below are some resistance values at different temperatures. Disconnecting the probe from the input to the interface and measuring its resistance with a multimeter gives the corresponding temperature, based on the values in the table.

°C	KΩ	°C	KΩ	°C	KΩ
-20	67.71	0	27.28	20	12.09
-15	53.39	5	22.05	25	10.00
-10	42.25	17	17.96	30	8.31
-5	33.89	15	14.68	35	6.94

When measuring the voltage across terminals Bn and GND, with an NTC fitted, the voltage measured is equal to:

$$V_{in} = \frac{2.5 \times R_{NTC}}{10000 + R_{NTC}}$$

Example: inserting a 10 KΩ resistor in the input (corresponding to 25°C) gives:

$$V_{in} = \frac{2.5 \times 10000}{20000} = 1.25 \text{ V}$$

In the case of the pCO<sup>XS</sup>, the following formula is used:

$$V_{in} = \frac{5 \times R_P}{10000 + R_P} \quad \text{where } R_P \text{ is the resistance expressed in ohm of the parallel between the resistance of the NTC and } 20000 \text{ } \Omega$$

- **To check the settings of the probe inputs**

Switch off the pCO and make the following measurements using a tester between the probe input Bn and GND:

For inputs B1, B2, B3, B6, B7 and B8 the resistance should be around 150 K $\Omega$ .

For inputs B4, B5, B9 and B10 the resistance should be around 10 k $\Omega$ .

As the type of analogue input on the pCO is set via software, where featured by the application, a more accurate check can be performed by disconnecting the sensors and powering up the pCO.

Measure:

<u>probe type</u>	<u>voltage measured</u>
NTC	2.5 V (3.3 V for pCO <sup>65</sup> )
4/20 mA	0 V
PT1000	2.5 V
0 to 1 V or 0 to 10 V	0 V
0 to 5 V	0 V (3.3 V for pCO <sup>65</sup> )

- **Dubious alarm signal from digital input (pCO<sup>1</sup>, pCO<sup>c</sup> and pCO<sup>3</sup>)**

Check the voltage between the common terminal "IDC1" and the terminal of the digital input indicating the alarm "IDn", in the following conditions:

1. if there is voltage (24 Vac or 24 Vdc, depending on the power supply used for the digital inputs) the contact of the alarm device connected is closed;
2. if the voltage is less than around 10 Vac or 10 Vdc (see above) the contact is open;
3. if not specified otherwise, the controller signals an alarm when the contacts are open.

- **The pCO repeatedly goes into Watch-dog mode, that is, it switches off and on again for a few seconds as if there were a brief power failure or it activates some outputs at random (digital and/or analogue)**

Check:

1. that the power cable does not run near the pCO;
2. that the rating of the power transformer (not supplied by CAREL) is correct (see the paragraph on the POWER SUPPLY);
3. that the cables running to the probes and the digital inputs are kept separate from the other cables (multi-conduit panels).

- **The serial connection to the local supervisor does not work**

Check:

1. that the serial board code PCOS004850 is connected correctly
2. that the identification number of the pCO has been set correctly (see the manual for the application program);
3. that the serial cables are connected correctly according to the CAREL diagram shown in the documents corresponding to the supervisor network;

- **The user terminal is blocked (it does not respond to the buttons)**

Check:

1. that the terminal has not been disconnected and then reconnected to the pCO without waiting 5 seconds. In this case, turn the pCO off and on again with the terminal connected;
2. that the software on the pCO has been installed correctly using the SMARTKEY or from a PC using WinLoad;
3. see Chap. 5.

## 10. NETWORKS AND PROTOCOLS

### 10.1 pLAN protocol

All the components in the pCO sistema can exchange information across the pLAN local network. The pLAN protocol is a multimaster protocol that can be used to build, simply and reliably, a distributed system for the optimum control of HVAC/R equipment

pCO model	Serial port	How to select the protocol
pCO <sup>2</sup>	0 – pLAN	Set the pLAN address to a value other than 0
pCO <sup>1</sup>		
pCO <sup>3S</sup>		
pCO <sup>C</sup>		
pCO <sup>3</sup>		

Tab. 10.a

Connectable devices

**Management of the terminals:** Connectable terminals: pCOT – pCOI – pGD0 – pGD<sup>1</sup> – pGD<sup>2</sup> – pGD<sup>3</sup>.

**Exchange of variables with other devices:** Connectable devices: any pCO – graphic pCO – Aria – EVD200 – EVD400 – FCM.

**Exchangeable variables:** maximum 2048 per device

Specifications

Baud rate: 62500 bps on all models  
115200 bps on pCO<sup>3</sup> (selectable via software)

Maximum number of connectable terminals: 3

Maximum number of connectable devices: 32 in total (including the terminals)

For the type of cable and the maximum distance see chapter 5.

### 10.2 Local terminal protocol

This protocol can be used to simply manage the point-to-point connection of a terminal to a pCO controller. The protocol is used to assign the address to the pCO<sup>1</sup>, pCO<sup>2</sup>, pCO<sup>3S</sup> and pCO<sup>C</sup>.

pCO model	Serial port	How to select the protocol
pCO <sup>2</sup>	0 – pLAN	Set the pLAN address of the pCO and the terminal to 0
pCO <sup>1</sup>		
pCO <sup>3S</sup>		
pCO <sup>C</sup>		
pCO <sup>3</sup>		

Tab. 10.b

Connectable devices

Terminals: pCOT – pCOI – pGD0 – pGD<sup>1</sup> – pGD<sup>2</sup> – pGD<sup>3</sup> (4x20 alphanumeric mode only)

Specifications

Baud rate: 10416 bps

Maximum number of connectable terminals: 1

### 10.3 CAREL Slave protocol

The CAREL slave protocol is used to make the pCO sistema network variables available to one of the CAREL proprietary supervisors: PlantVisor, PlantWatch, PCGate, WebGate, pCOWEB, pCONET. Using a series of plug-in boards, the pCO controllers can also interface with the most commonly-used management and supervision systems available on the market: LON-Echelon, BACnet, TREND and SNMP. The FieldBus serial port features an additional security feature, that is, the calculation of the CRC, to ensure that communication is correct in all circumstances.

pCO model	Serial port	How to select the protocol
pCO <sup>2</sup>	0 – pLAN *	SERIAL0_PROTOCOL = 1
	1 – BMS	SERIAL1_PROTOCOL = 1
pCO <sup>1</sup>	0 – pLAN *	SERIAL0_PROTOCOL = 1
	1 – BMS	SERIAL1_PROTOCOL = 1
	2 – FieldBus	SERIAL2_PROTOCOL = 4
pCO <sup>3S</sup>	0 – pLAN *	SERIAL0_PROTOCOL = 1
	1 – BMS	SERIAL1_PROTOCOL = 1
	2 – FieldBus	SERIAL2_PROTOCOL = 4
pCO <sup>C</sup>	0 – pLAN *	SERIAL0_PROTOCOL = 1
	1 – BMS	SERIAL1_PROTOCOL = 1
pCO <sup>3</sup>	0 – pLAN *	SERIAL0_PROTOCOL = 1
	1 – BMS	SERIAL1_PROTOCOL = 1
	2 – FieldBus	SERIAL2_PROTOCOL = 4

Tab. 10.c

**Note for pCO<sup>2</sup>, pCO<sup>1</sup> 128KB, pCO<sup>3S</sup> 128KB, pCO<sup>C</sup>:** the protocol cannot be activated on more than one serial port at the same time. The protocol is incompatible with the following protocols: PSTN, GSM, Modbus Slave, tLAN Slave.

**Note for pCO<sup>1</sup> 512KB, pCO<sup>3S</sup> 512KB, pCO<sup>3</sup>:** the protocol can be activated at the same time on the BMS serial and FieldBus serial ports; in all other cases, the protocol can only be activated on one serial port. If CAREL Slave is active on the pLAN serial port the following protocols cannot be used: PSTN, GSM, Modbus Slave, tLAN Slave.

\* The CAREL SLAVE protocol may be slower on the 0-pLAN serial port than on serial 1-BMS or serial 2-FieldBus, where available



**Connectable devices**

Connectable supervisors: PlantVisor – PlantWatch – PCGate – WebGate – Gateway Modbus – Gateway BACnet – pCOWEB – pCONET – any pCO with CAREL

Master protocol.

Using plug-in boards: LON-Echelon, BACnet, TREND, SNMP supervisors

Specifications

Baud rate:

**Serial port** 0 – pLAN 1 – BMS 2 – FIELDBUS

**bps** 19200 1200 – 2400 – 4800 – 9600 – 19200

Exchangeable variables: 127 analogue – 127 integer – 199 digital

or 207 analogue – 207 integer – 207 digital settable with SUPERVISOR-EXTENSION system variable

Connectable devices: supervisor

Type of cable/ max. distance: on RS485 line: AWG 20/22 shielded cable / max 1000 m total

on LON line: according to LON standards

on TREND line: according to TREND standards

on Ethernet line: according to IEEE 802.3 specifications.

**10.4 CAREL Master protocol**

The CAREL Master protocol can be used to read and write variables from/to peripherals that use the CAREL Slave protocol. This protocol is used to talk to I/O expansions, drivers and fan coil controllers in a simple and economical manner. There are two versions of the CAREL Master protocol: both versions use a list allocated in the application RAM. The second version also uses atoms to simplify the development of the application and make the commands and the reading of the variables by the peripherals faster. Both versions allow the supervision of up to 207 devices and 207 variables per device. The limits depend on the availability of user memory.

pCO model	Serial port	How to select the protocol
pCO <sup>2</sup>	1 – BMS	Specify the address of the control list using the system variables CARELMASTER_POINTER_H , CARELMASTER_POINTER_L ; set the serial port required in the control list
pCO <sup>1</sup>	0 – pLAN	
	1 – BMS	
	2 – FieldBus	
pCO <sup>AS</sup>	0 – pLAN	Set the value of the corresponding SERIALX_PROTOCOL variable  (see EasyTools documents)
	1 – BMS	
pCO <sup>C</sup>	1 – BMS	
	0 – pLAN	
pCO <sup>3</sup>	1 – BMS	
	2 – FieldBus	

**Tab. 10.d**

The CAREL Master protocol is only available on the pLAN serial port in the second version (PCO\* with 512 KB RAM only).

**Connectable devices**

All CAREL devices that support the CAREL Slave protocol, for example: pCOe 485, Hydronic fan coil with CANbus, e-drofan, PCGate, Wireless probe, EVD300, EVD400, Energy<sup>2</sup>, IR33, MasterCase, MasterCella, PowerSplit, Power Compact, µC<sup>2</sup>, µC<sup>3</sup>, vAC, any pCO with CAREL Slave protocol.

Specifications

Baud rate: 1200 – 2400 – 4800 – 9600 – 19200 bps

Baud rate available with the second version : 1200, 2400, 4800, 9600, 19200, 38400 (where available ), 115200 (where available ) bps

Connectable slaves: 207 slaves

Exchangeable variables: 207 analogue – 207 integer – 207 digital

Type of cable/ max. distance: on RS485 line: AWG 20/22 shielded cable / max 1000 m total

on tLAN line: AWG 20/22 shielded cable / max 10 m total

on CANbus line: from [AWG 16 / max 1100 m] to [AWG 24 / max 200 m]

**10.5 CAREL Master 5 expansions protocol**

The CAREL Master 5 expansions protocol is a protocol that is optimised for reading and writing variables from/to peripherals that speak the CAREL Slave protocol and that act as I/O expansions, without intelligence.

pCO model	Serial port	How to select the protocol
pCO <sup>2</sup>	0 – pLAN	SERIAL0_PROTOCOL = 7
	3 – connector J23	no action required
pCO <sup>1</sup>	0 – pLAN	SERIAL0_PROTOCOL = 7
	2 – FieldBus	SERIAL2_PROTOCOL = 20
pCO <sup>AS</sup>	0 – pLAN	SERIAL0_PROTOCOL = 7
	2 – FieldBus	SERIAL2_PROTOCOL = 20
pCO <sup>C</sup>	0 – pLAN	SERIAL0_PROTOCOL = 7
	0 – pLAN	SERIAL0_PROTOCOL = 7
pCO <sup>3</sup>	2 – FieldBus	SERIAL2_PROTOCOL = 20
	3 – connector J23	no action required

**Tab. 10.e**

**Note:** the protocol cannot be activated on more than one serial port at the same time.

**Note for pCO<sup>2</sup> and pCO<sup>3</sup>:** connector J23 is only available in the Large and XL versions.

**Note for pCO<sup>AS</sup> and pCO<sup>C</sup>:** if the protocol is activated on the FieldBus serial port, PST or PLD terminals cannot be connected.

If the protocol is activated on the FIELDBUS serial port it cannot be activated on J23 and vice-versa.

**Connectable devices**

Any pCO with CAREL Slave protocol; pCOe 485 I/O expansions – pCOe tLAN; EVD300; EVD400;  $\mu C^2$  expansion.

Specifications

Baud rate: 1200 – 2400 – 4800 – 9600 – 19200 bps on FieldBus serial  
19200 bps on the other serial ports

Connectable slaves: maximum 5 slaves (addresses 1, 2, 3, 4, 5)

Exchangeable variables: for each slave: 20 analogue – 40 integer – 40 digital

Type of cable/ max. distance: on RS485 line: AWG 20/22 shielded cable / max 1000 m total  
on tLAN line: AWG 20/22 shielded cable / max 10 m total

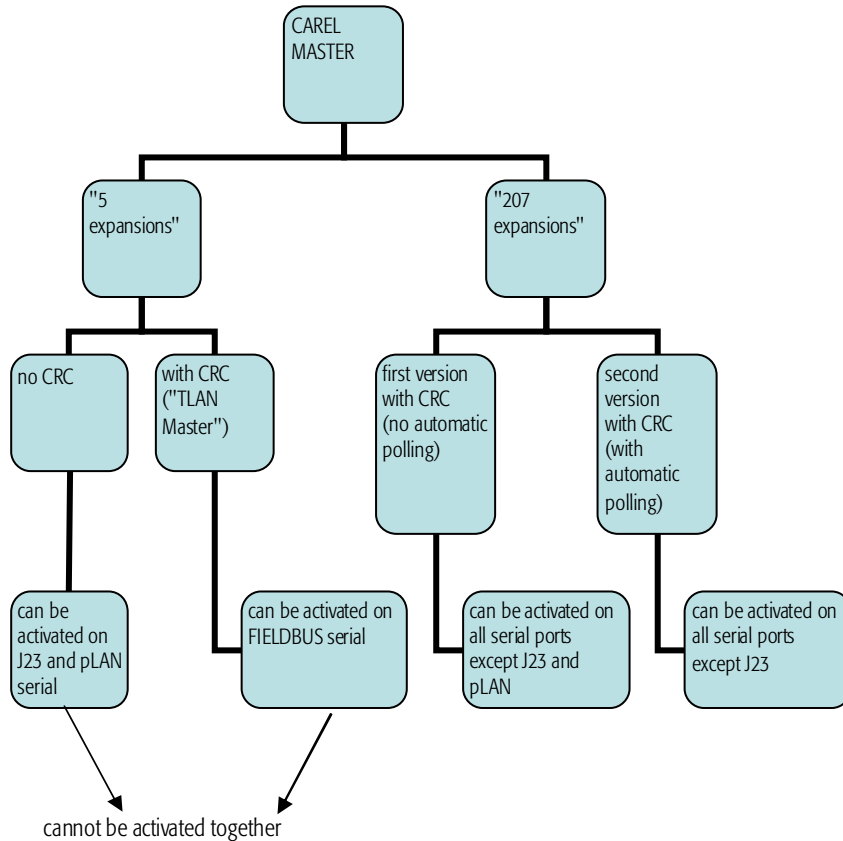

**Fig. 10.a**

**Note:** The same CAREL Master protocol (i.e. the same setting of the SERIAL\_PROTOCOL system variable) cannot be set on more than one serial port at the same time.

**10.6 WinLoad protocol**

The WinLoad protocol is used to create a point-to-point connection of pCO controllers using the WinLoad software, part of the EasyTools package. With WinLoad, the user can completely manage the unit in a simple and intuitive manner. Specifically:

- update the BOOT file;
- update the BIOS file;
- download the applications (\*.IUP – \*.BLB – flash1.BIN - \*.DEV files);
- update the files with the rules for acquiring the data log (\*.PVT – \*.LCT files);
- acquire the logged data;
- acquire the values of the parameters in the buffer memory.

Available on the following serial ports

pCO model	Serial port	How to select the protocol
pCO <sup>2</sup>	0 – pLAN	SERIAL0_PROTOCOL = 4
	1 – BMS	SERIAL1_PROTOCOL = 4
pCO <sup>1</sup>	0 – pLAN	SERIAL0_PROTOCOL = 4
	1 – BMS	SERIAL1_PROTOCOL = 4
	2 - FIELDBUS	SERIAL2_PROTOCOL = 16
pCO <sup>5</sup>	0 – pLAN	SERIAL0_PROTOCOL = 4
	1 – BMS	SERIAL1_PROTOCOL = 4
	2 - FIELDBUS	SERIAL2_PROTOCOL = 16
pCO <sup>C</sup>	0 – pLAN	SERIAL0_PROTOCOL = 4
	1 – BMS	SERIAL1_PROTOCOL = 4
pCO <sup>3</sup>	0 – pLAN	SERIAL0_PROTOCOL = 4
	1 – BMS	SERIAL1_PROTOCOL = 4
	2 - FIELDBUS	SERIAL2_PROTOCOL = 16

**Tab. 10.f**

**Note:** the protocol cannot be activated on more than one serial port at the same time.

**Connectable devices**

Connectable WinLoad versions:	WinLoad, Easy WinLoad
Other devices:	Smart Key (pLAN serial only)
Specifications	
Baud rate:	54211 bps for pCO2/pCO1/pCOC with Smart Key 83781 bps for pCO <sup>KS</sup> with Smart Key 115200 or 375000 bps for pCO <sup>3</sup> on pLAN serial 28800 bps in all other cases
Connectable devices:	1
Type of cable / max. distance:	on pLAN aerial only: telephone cable / max 5 m
on all serial ports:	AWG 20/22 shielded cable / max 1000 m total

**10.7 PST protocol**

The PST protocol is used to manage the PST and PLD family terminals with numeric LED displays, both with and without keypads.

pCO model	Serial port	How to select the protocol
pCO <sup>1</sup>	2 – FieldBus	SERIAL2_PROTOCOL = 3
pCO <sup>KS</sup>		
pCO <sup>2</sup>		

Tab. 10.g

**Connectable devices**

PST terminals code PST\*\*V\*\*\*\*, PST\*\*S\*\*\*\*, PST\*\*L\*\*\*\*.

PLD terminals code PLD\*\*S\*\*\*\*, PLD\*\*L\*\*\*\*.

Specifications

Baud rate: 4800 or 19200 bps for PST00LR200  
4800 bps for all other terminals

Connectable devices: 1  
Type of cable / max. distance: cables wired with 2 connectors in lengths 0.5 m – 1 m – 1.5 m – 3 m – 5 m  
cable wired with 1 connector / max length 10 m

**10.8 Modbus Slave protocol**

The Modbus Slave protocol is used to make the variables and configuration parameters of the pCO controllers available to a generic Modbus supervisory system.

It is available in two versions: normal (SERIAL\*\_PROTOCOL=3 or 5), extended (SERIAL\*\_PROTOCOL=30 or 50)

pCO model	Serial port	How to select the protocol
pCO <sup>2</sup>	1 – BMS	SERIAL1_PROTOCOL = 3
pCO1	0 – pLAN	SERIAL0_PROTOCOL = 3; 30
	1 – BMS	SERIAL1_PROTOCOL = 3; 30
	2 – FieldBus	SERIAL2_PROTOCOL = 5; 50
pCOXS	0 – pLAN	SERIAL0_PROTOCOL = 3; 30
	1 – BMS	SERIAL1_PROTOCOL = 3; 30
	2 – FieldBus	SERIAL2_PROTOCOL = 5; 50
pCOC	0 – pLAN	SERIAL0_PROTOCOL = 3
	1 – BMS	SERIAL1_PROTOCOL = 3
pCO3	0 – pLAN	SERIAL0_PROTOCOL = 3; 30
	1 – BMS	SERIAL1_PROTOCOL = 3; 30
	0 – pLAN	SERIAL2_PROTOCOL = 5; 50

**Note:** if used on serial 0-pLAN, set the pLAN address to 0

**Note:** the ModBus slave protocol cannot be selected at the same time on different serial ports.

**Note** for pCO1 128KB, pCOXS 128KB, pCOC, pCO2: the protocol is incompatible with CAREL Slave, PSTN, GSM.

**Note** for pCO1 512KB, pCOXS 512KB, pCO3: the protocol is incompatible with CAREL Slave only if the latter is activated on the pLAN serial port.

**Connectable devices**

One Modbus supervisor in RTU mode (REMOTE TERMINAL UNIT).

Specifications communication: 1 Start, 8 data, 2 Stop, no parity

Baud rate: 1200 – 2400 – 4800 – 9600 – 19200 bps (half duplex on RS232)

Exchangeable variables: see Tab. 10.a and 10.b (Analogue and integer mapped on Modbus “registers”, digital on Modbus “coils”)

Type of cable / max. distance: on RS485 line: AWG 20/22 shielded cable / max 1000 m total  
on RS232 line: RS232 cable / max 5 m

**Configuration of the connectable “supervisor” device**

Timeout and polling rate parameters

The timeout and polling rate parameters (WAIT, TREATMENTS, TURNAROUND DELAY, INTERPACKET DELAY) must be set correctly.

Typical values are as follows:

timeout: 1000ms or higher;  
turnarounds delay = from 100ms to 200ms.  
interpacket delay = turnarounds delay.

- Exchangeable variables in normal version:**

SERIAL1\_PROTOCOL = 3 or 5 (see Tab. 10.h)

SUPERVISOR_EXTENSION = 0			SUPERVISOR_EXTENSION = 1		
127 analogue	127 integer	199 digital	207 analogue	207 integer	207 digital

Tab. 10.i

- Exchanged variables in extended version:**

SERIAL1\_PROTOCOL = 30 or 50 (see Tab. 10.h)

5000 analogue	5000 integer	2048 digital
---------------	--------------	--------------

Tab. 10.l

## 10.9 Modbus Master protocol

The Modbus RTU full option protocol is optimised for acquiring and writing integer, analogue and digital variables from/to generic Modbus Slave devices.

pCO model	Serial port	How to select the protocol
pCO <sup>2</sup>	0 – pLAN	SERIAL0_PROTOCOL = 21; select address from control list
	1 – BMS	SERIAL1_PROTOCOL = 21; select address from control list
pCO <sup>1</sup> 512KB	0 – pLAN	SERIAL0_PROTOCOL = 21; select address from control list
	1 – BMS	SERIAL1_PROTOCOL = 21; select address from control list
	2 – FieldBus	SERIAL2_PROTOCOL = 21; select address from control list
pCO <sup>5S</sup>	0 – pLAN	SERIAL0_PROTOCOL = 21; select address from control list
	1 – BMS	SERIAL1_PROTOCOL = 21; select address from control list
	2 – FieldBus	SERIAL2_PROTOCOL = 21; select address from control list
pCO <sup>C</sup>	0 – pLAN	SERIAL0_PROTOCOL = 21; select address from control list
	1 – BMS	SERIAL1_PROTOCOL = 21; select address from control list
pCO <sup>3</sup>	0 – pLAN	SERIAL0_PROTOCOL = 21; select address from control list
	1 – BMS	SERIAL1_PROTOCOL = 21; select address from control list
	2 – FieldBus	SERIAL2_PROTOCOL = 21; select address from control list

Tab. 10.m

**Note:** the protocol cannot be activated on more than one serial port at the same time.

### Connectable devices

CAREL devices: any pCO with Modbus Slave protocol, pCOe Modbus,  $\mu C^2$ ,  $\mu C^3$ , e-drofan.

Other devices: any device that uses the Modbus Slave protocol (RTU mode) at baud rate specified below.

Specifications: communication: 1 Start, 8 data, selectable Stop bits (def. 1), selectable parity (def. no)

Baud rate: 1200 – 2400 – 4800 – 9600 – 19200 bps;

some baud rates may not be supported by all the devices

Connectable devices: Max 247 in Unicast mode (devices with address different from 0)

Exchangeable variables: Modbus variables: 65533 analogue/integer (“registers”) – 65533 digital (“coils”)

Type of cable / max. distance: AWG 20/22 shielded cable / max 1000 m total

The acquisition time for all the variables on a slave device depends on the consecutiveness of the Modbus addresses of the device variables and the management software (application). Typically, at 19200 bps a read command requested by the application is executed by the Bios on the pCO in around 60 to 80 ms regardless of the number of variables read.

As the read commands are requested by the application, the acquisition of all the variables on a slave device depends not only on how many there are and whether they are consecutive, but also on the structure of the application.

## 10.10 Modbus Master protocol - Benschaw

This protocol has been specifically developed for the control and management of the Benschaw VFD. This communication protocol can be used to interface directly with these devices, set the configuration parameters and read the operating values.

pCO model	Serial port	How to select the protocol
pCO <sup>2</sup>	1 – BMS	SERIAL1_PROTOCOL = 9
pCO1		
pCOXS		
pCOC		
pCO <sup>3</sup>		

Tab 10.n

Connectable devices

Maximum of two Benschaw devices.

Specifications

Baud rate: 1200 – 2400 – 4800 – 9600 – 19200 bps

Connectable devices: 2 (addresses 1 and 2)

Exchangeable variables: Modbus variables: 64 registers

Type of cable / max. distance: AWG 20/22 shielded cable / max 1000 m total

## 10.11 PSTN protocol (modem)

The PSTN protocol allows the pCO controllers to automatically connect to a remote CAREL supervisor and be called by a remote CAREL supervisor or by a remote WinLoad application (see note after Tab. 10.o). A series of analogue, integer and digital variables can be exchanged across the connection to a remote CAREL supervisor. The connection to the remote WinLoad application can be used to completely manage the unit, including updating the application files, updating the rules for the logs, acquiring the logged data (see below for further details on the operations that are available).

pCO model	Serial port	How to select the protocol
pCO <sup>2</sup>	1 – BMS	SERIAL1_PROTOCOL = 2
pCO <sup>1</sup> 128KB	1 – BMS	SERIAL1_PROTOCOL = 2
pCO <sup>5S</sup> 128KB		
pCO <sup>1</sup> 512KB	1 – BMS	SERIAL1_PROTOCOL = 2
pCO <sup>5S</sup> 512KB	2 – FieldBus	SERIAL2_PROTOCOL = 12
pCO <sup>C</sup>	1 – BMS	SERIAL1_PROTOCOL = 2
	1 – BMS	SERIAL1_PROTOCOL = 2
pCO <sup>3</sup>	1 – BMS	SERIAL1_PROTOCOL = 2
	2 – FieldBus	SERIAL2_PROTOCOL = 12

Tab 10.o

**Note for pCO<sup>1</sup> and pCO<sup>3</sup>:** the protocol cannot be activated on more than one serial port at the same time and is incompatible with the GSM protocol and the Winload protocol.

**Note for pCO<sup>2</sup>, pCO<sup>1</sup> 128KB, pCO<sup>5S</sup> 128KB, pCO<sup>C</sup>:** the protocol is also incompatible with CAREL Slave and Modbus.

**Note for pCO<sup>1</sup> 512KB, pCO<sup>5S</sup> 512KB, pCO<sup>3</sup>:** if set on the BMS serial port the protocol is incompatible with the CAREL Slave set on the pLAN serial port. When the protocol is set on the FieldBus serial port, the remote WinLoad connection is not possible.

**Note for pCO<sup>1</sup> 512KB, pCO<sup>5S</sup> 512KB, pCO<sup>3</sup>:** the remote WinLoad connection is not possible on the FieldBus serial port.

**Connectable devices**

Remote CAREL supervisor or remote WinLoad.

**Specifications**

The following variables can be exchanged across the connection to a remote CAREL supervisor:

127 analogue – 127 integer – 199 digital. If the system variable BMS\_EXTENSION= 0

207 analogue – 207 integer – 207 digital. If the system variable BMS\_EXTENSION= 1

The following operations can be performed across the remote WinLoad connection:

- update the application files (\*.IUP – \*.BLB – flash1.BIN - \*.DEV);
- update the log files (\*.PVT – \*.LCT);
- acquire the logged data;
- acquire the parameters in buffer memory.

**10.12 GSM protocol (GSM modem)**

The GSM protocol allows the pCO controllers to automatically connect to a remote CAREL supervisor and be called by a remote CAREL supervisor or by a remote WinLoad application (see note after Tab. 10.p). All the supervision and management operations already described for the PSTN protocol can thus be performed. In addition to these functions, the GSM protocol is used to send and receive SMS messages over the GSM network using the wireless modems that support this function; the SMS messages are sent upon certain events or alarms, according to rules that are established in the application program.

pCO model	Serial port	How to select the protocol
pCO <sup>2</sup>	1 – BMS	SERIAL1_PROTOCOL = 10 for Kyocera (not GSM): SERIAL1_PROTOCOL = 11
pCO <sup>1</sup>	1 – BMS	SERIAL1_PROTOCOL = 10 for Kyocera (not GSM): SERIAL1_PROTOCOL = 11
	2 – FieldBus	SERIAL2_PROTOCOL = 10 for Kyocera (not GSM): SERIAL2_PROTOCOL = 11
pCO <sup>6</sup>	1 – BMS	SERIAL1_PROTOCOL = 10 for Kyocera (not GSM): SERIAL1_PROTOCOL = 11
pCO <sup>c</sup>	1 – BMS	SERIAL1_PROTOCOL = 10 for Kyocera (not GSM): SERIAL1_PROTOCOL = 11
pCO <sup>3</sup>	1 – BMS	SERIAL1_PROTOCOL = 10 for Kyocera (not GSM): SERIAL1_PROTOCOL = 11
	2 – FieldBus	SERIAL2_PROTOCOL = 10 for Kyocera (not GSM): SERIAL2_PROTOCOL = 11

**Tab 10.p**

**Note for pCO<sup>1</sup> and pCO<sup>3</sup>:** the protocol cannot be activated on more than one serial port at the same time.

**Note for pCO<sup>1</sup> and pCO<sup>3</sup>:** the protocol cannot be activated on more than one serial port at the same time and is incompatible with the PSTN protocol and the Winload protocol.

**Note for pCO<sup>2</sup>, pCO<sup>1</sup> 128KB, pCO<sup>6</sup> 128KB, pCO<sup>c</sup>:** the protocol is also incompatible with CAREL Slave and Modbus.

**Note for pCO<sup>1</sup> 512KB, pCO<sup>6</sup> 512KB, pCO<sup>3</sup>:** if set on the BMS serial the protocol is incompatible with CAREL Slave only if the latter is set on the pLAN serial port.

**Note for pCO<sup>1</sup> 512KB, pCO<sup>6</sup> 512KB, pCO<sup>3</sup>:** the remote WinLoad connection is not possible on the FieldBus serial port.

**Note:** with the Kyocera wireless modem (not GSM) only the remote supervisor connection is possible.

**Connectable devices**

Remote CAREL supervisor or remote WinLoad.

To establish the connection to the supervisor or WinLoad, connect the pCO to a GSM modem; recommended models are Wavecom WMOD2B\*, FALCOM A2D\* or Siemens TC35\*.

**Specifications**

The following variables can be exchanged across the connection to a remote CAREL supervisor:

127 analogue – 127 integer – 199 digital. If the system variable BMS\_EXTENSION= 0

207 analogue – 207 integer – 207 digital. If the system variable BMS\_EXTENSION= 1

The following operations can be performed across the remote WinLoad connection:

- update the application files (\*.IUP – \*.BLB – flash1.BIN - \*.DEV);
- update the log files (\*.PVT – \*.LCT);
- acquire the logged data;
- acquire the parameters in buffer memory.

In addition, SMS messages can be exchange, as follows:

- send the pCO a suitably formatted SMS to set the supervisor variables;

- send, from the pCO, SMS messages in the desired format to signal alarms or any other information specified by the application.

**10.13 MP-Bus protocol**

The MP-Bus protocol is used to manage the BELIMO series actuators, exchanging variables, writing the configuration parameters and reading the values of any probes connected to the actuators.

pCO model	Serial port	How to select the protocol
pCO <sup>1</sup>	2 – FieldBus	SERIAL2_PROTOCOL = 1
pCO <sup>6</sup>		
pCO <sup>3</sup>		

**Connectable devices**

Maximum 8 Belimo actuators.

**Specifications**

Baud rate: 1200 bps

Exchangeable variables: specific commands for the actuator used

Connectable devices: 8

Type of cable / max. distance: AWG 20/22 shielded cable / max 30 m total

## 10.14 Serial printer protocol

The Serial printer protocol is used to connect the pCO to any printer fitted with an RS232 interface; this allows paper copies to be generated of particularly important information, for example the trend in the temperature in a cold room over time. The information to be printed can be completely configured in the application. Instead of the printer, other devices with RS232 serial interface can be connected, for example a terminal emulator or a PC with a program that saves the data received via the serial link to the hard disk.

Available on the following serial ports

pCO model	Serial port	How to select the protocol
pCO <sup>2</sup>	1 – BMS	SERIAL1_PROTOCOL = 14
pCO <sup>1</sup>	1 – BMS	SERIAL1_PROTOCOL = 14
	2 – FieldBus	SERIAL2_PROTOCOL = 14
pCO <sup>8S</sup>	1 – BMS	SERIAL1_PROTOCOL = 14
pCO <sup>C</sup>	1 – BMS	SERIAL1_PROTOCOL = 14
pCO <sup>3</sup>	1 – BMS	SERIAL1_PROTOCOL = 14
	2 – FieldBus	SERIAL2_PROTOCOL = 14

**Note for pCO<sup>1</sup> and pCO<sup>3</sup>:** the protocol cannot be activated on more than one serial port at the same time.

Connectable devices: one serial printer or any other device fitted with RS232 interface.

Specifications

Baud rate: 1200 bps  
 Communication mode: 8 data bits, no parity, 1 stop bit, no flow control  
 Connectable devices: 1  
 Type of cable / max. distance: RS232 cable / max 5m

## Devices that can be connected to the pCOC

Device	serial 0 - pLAN		serial 1 - BMS										Protocol active on the pCO	Notes	
	connector J11	connector J19	PCO1004850	PCOS004850	PCO100MDMC	PCO10000F0	PCO10000R0	PCO100CLP0	PCO1000WB0	PCO1000BA0	PCOS00HBB0				
pCOT - pCOI terminal	X													Local terminal or pLAN	
pGD0 - pGD1 terminal	X													Local terminal or pLAN	With Local terminal the pGD* works in pCOT emulation mode
pGD2 - pGD3 terminal	X													Local terminal or pLAN	
Aria terminal	X														
pCO in pLAN	X													pLAN	
FCM series controllers	X														
EVD200	X														
EVD400	X													pLAN or CAREL Master or CAREL Master 5 expansions	Can only be activated on one serial port
CAREL Slave devices (RS485)	X		X	X										CAREL Master or CAREL Master 5 exp.	CAREL Master: can only be activated on BMS serial. CAREL Master 5 expansions: can only be activated on pLAN serial
pCOexp 485	X		X	X										CAREL Master	
Hydronic fan coil and CANbus													X		
PlantVisor local	X		X	X											
PlantWatch	X		X	X											
PCGate	X		X	X											
WebGate	X		X	X											
GATEWAY**0	X		X	X											
LON - Echelon RS485							X							CAREL Slave	Incompatible with protocols PSTN GSM Modbus Slave
LON - Echelon FTT10						X									
TREND								X							
HTTP client									X						
BACnet/Ethernet									X						
BACnet/IP									X						
BACnet/MSTP (RS485)										X					
SNMP v1, SNMP v2C										X					
SNMP v3										X					For SNMP v3 special pCOWEB software is used
Modbus supervisor (RTU)	X		X	X										Modbus Slave	Incompatible with CAREL Slave, PSTN, GSM
Modbus Slave devices	X		X	X										Modbus Master	Can only be activated on one serial port
pCOexp Modbus	X		X	X											
BenShaw devices			X	X										Modbus Master - Benshaw	Maximum of two Benshaw devices
WinLoad local	X	X	X	X										WinLoad	Can only be activated on 1 serial. Incompatible with PSTN & GSM
WinLoad remote, analogue modem					X									PSTN	Incompatible with CAREL Slave and Winload
PlantVisor remote, analogue modem					X										
WinLoad remote, GSM modem					X										
PlantVisor remote, GSM modem					X									GSM	Incompatible with CAREL Slave and Winload
Send and receive SMS					X										
Serial printer					X									Serial printer	







## Devices that can be connected to the pCO1 512KB

Device	serial 0 - pLAN		serial 1 - BMS							serial 2 - FieldBus					Protocol active on the pCO	Notes	
	connector J11	connector J10	PCO1004850	PCOS004850	PCO100MDMD0	PCO10000F0	PCO10000R0	PCO100CLP0	PCO1000WB0	PCO1000BA0	PCOS00HB0	PCO100FD10	PCOS00FD20	PCO100TLN0			PCO100MPB0
PST terminal																X	Incompatible with CAREL Master 5 exp.
PLD terminal																X	
pCOT - pCOI terminal		X															
pGD0 - pGD1 terminal		X															
pGD2 - pGD3 terminal	X																
Aria terminal	X																
pCO in pLAN	X																
FCM series controllers	X																
EVD200	X																
EVD400	X													X			
CAREL Slave devices (tLAN)														X			
CAREL Slave devices (485)	X		X	X								X					
pCOexp 485	X		X	X							X						
pCOexp tLAN													X				
µChiller2 expansion													X				
Hydronic fan coil and CANbus										X							X
PlantVisor local	X		X	X							X						
PlantWatch	X		X	X							X						
PCGate	X		X	X							X						
WebGate	X		X	X							X						
GATEWAY**0	X		X	X							X						
LON - Echelon RS485						X											
LON - Echelon FTT10					X												
TREND							X										
HTTP client								X									
BACnet/Ethernet								X									
BACnet/IP								X									
BACnet/MSTP (RS485)									X								
SNMP v1, SNMP v2C									X								
SNMP v3									X								
Modbus supervisor (RTU)	X		X	X							X						
Modbus Slave devices	X		X	X							X						
pCOexp Modbus	X		X	X							X						
BenShaw devices			X	X													
WinLoad local	X	X	X	X							X	X					
WinLoad remote, analogue modem					X												
PlantVisor remote, analogue modem					X							X					
WinLoad remote, GSM modem					X												
PlantVisor remote, GSM modem					X							X					
Send and receive SMS					X							X					
Belimo devices															X		
Serial printer				X								X					
pLAN																	
pLAN or CAREL Master or CAREL Master 5 exp.																	Can only be activated on one serial port. CAREL Master 5 exp.: incompatible with PST terminal
CAREL Master or CAREL Master 5 exp.																	Can only be activated on one serial port. CAREL Master 5 exp.: incompatible with PST terminal
CAREL Master or CAREL Master 5 exp.																	CAREL Master: can only be activated on one port, BMS serial or FieldBus serial or pLAN. CAREL Master 5 exp.: can only be activated on one port, pLAN serial or FieldBus serial
CAREL Master 5 exp.																	Can only be activated on one serial port; incompatible with PST terminal
CAREL Master																	Can only be activated on one serial port
CAREL Slave																	Can only be activated on one serial port; at the same time, BMS or FieldBus  If active on pLAN serial, these protocols cannot be used PSTN GSM Modbus Slave on BMS serial  For SNMP v3 special pCOWEB software is used
Modbus Slave																	
Modbus Master																	Can only be activated on one serial port
Modbus Master - Benshaw																	Maximum of two Benshaw devices
WinLoad																	Can only be activated on one serial port; on FieldBus serial from Bios 4.00
PSTN																	Can only be activated on one serial port Incompatible with the GSM protocol; if activated on BMS serial is incompatible with Carel Slave set on pLAN serial
GSM																	Can only be activated on one serial port.  Incompatible with the protocol PSTN; if activated on BMS serial is incompatible with Carel Slave set on pLAN serial
MP-Bus																	Maximum of 8 devices
Serial printer																	Can only be activated on one serial port



Devices that can be connected to the pCO3

Device	serial 0 - pLAN		serial 1 - BMS								serial 2 - FieldBus				serial 3 (L & XL)	serial 5		
	connector J11	connector J10	PCO1004850	PCOS004850	PCO100MDM0	PCO10000F0	PCO10000R0	PCO100CLP0	PCO1000WB0	PCO1000BA0	PCOS00HBB0	PCO100FD10	PCOS00FD20	PCO100TLN0	PCO100MPB0	PCOS00HBF0	connector J23	connector J9
Display panel																		X
PST terminal													X					
PLD terminal												X						
pCOT - pCOI terminal		X																
pGD0 - pGD1 terminal		X																
pGD2 - pGD3 terminal	X																	
Aria terminal	X																	
pCO in pLAN	X																	
FCM series controllers	X																	
EVD200	X																	
EVD400	X												X					
CAREL Slave devices (tLAN)													X					
CAREL Slave devices (485)	X		X	X							X						X	
pCOexp 485	X		X	X							X						X	
pCOexp tLAN													X					
µChiller2 expansion													X					
Hydronic fan coil and CANbus										X						X		
PlantVisor local	X		X	X							X							
PlantWatch	X		X	X							X							
PCGate	X		X	X							X							
WebGate	X		X	X							X							
GATEWAY**0	X		X	X							X							
LON - Echelon RS485							X											
LON - Echelon FTT10						X												
TREND								X										
HTTP client									X									
BACnet/Ethernet									X									
BACnet/IP									X									
BACnet/MSTP (RS485)									X	X								
SNMP v1, SNMP v2C									X									
SNMP v3									X									
Modbus supervisor (RTU)	X		X	X							X							
Modbus Slave devices	X		X	X							X							
pCOexp Modbus	X		X	X							X							
BenShaw devices			X	X														
WinLoad local	X	X	X	X							X	X						
WinLoad remote, analogue modem					X													
PlantVisor remote, analogue modem						X							X					
WinLoad remote, GSM modem						X												
PlantVisor remote, GSM modem					X								X					
Send and receive SMS						X							X					
Belimo devices														X				
Serial printer					X							X						

Protocol active on the pCO	Notes
Display panel	
PST terminal	Incompatible with CAREL Master 5 exp.
Local terminal or pLAN	
Local terminal or pLAN	With Local terminal the pGD* works in pCOT emulation mode
Local terminal or pLAN	
pLAN	
pLAN or CAREL Master or CAREL Master 5 exp.	Can only be activated on one serial port. CAREL Master 5 exp.: incompatible with PST terminal
CAREL Master or CAREL Master 5 exp.	Can only be activated on one serial port. CAREL Master 5 exp.: incompatible with PST terminal. If the protocol is activated, other devices cannot be supervised on J23.
CAREL Master or	CAREL Master: can only be activated on one port, BMS serial or FieldBus serial or pLAN.
CAREL Master 5 exp.	CAREL Master 5 exp.: can only be activated on one port, pLAN serial or FieldBus serial. Activating the protocol on FieldBus serial deactivates the protocol on J23.
CAREL Master 5 exp.	Can only be activated on one serial port; incompatible with PST terminal
CAREL Master	Can only be activated on one serial port
CAREL Slave	Can only be activated on one serial port; at the same time, BMS or FieldBus  If active on pLAN serial, these protocols cannot be used PSTN GSM Modbus Slave on BMS serial  For SNMP v3 special pCOWEB software is used
Modbus Slave	
Modbus Master	Can only be activated on one serial port
Modbus Master - Benshaw	Maximum of two Benshaw devices
WinLoad	Can only be activated on one serial port; on FieldBus serial from Bios 4.00
PSTN	Can only be activated on one serial port Incompatible with the GSM protocol; if activated on BMS serial is incompatible with Carel Slave set on pLAN serial
GSM	Can only be activated on one serial port.  Incompatible with the protocol PSTN; if activated on BMS serial is incompatible with Carel Slave set on pLAN serial
MP-Bus	Maximum of 8 devices
Serial printer	Can only be activated on one serial port

## Devices that can be connected to the pCO2



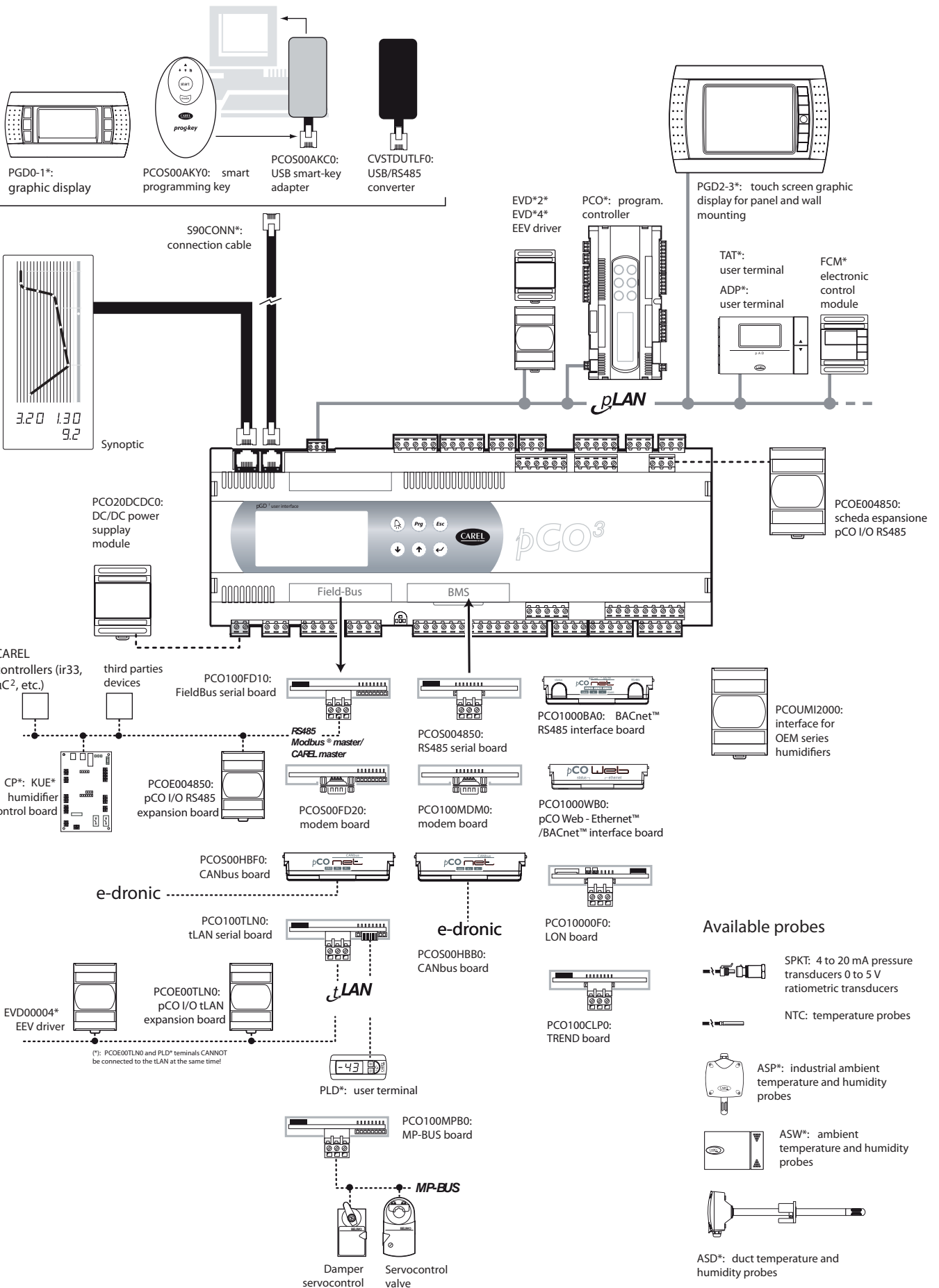

Device	serial 0 - pLAN		serial 1 - BMS								serial 3 (L & XL)	serial 5	
	connector J11	connector J10	PCO2004850	PCOS004850	PCO200MDM0	PCO2000F0	PCO2000R0	PCO100CLP0	PCO1000WB0	PCO1000BA0	PCOS00HBB0	connector J23	connector J9
Display panel													X
pCOT - pCOI terminal		X											
pGD0 - pGD1 terminal		X											
pGD2 - pGD3 terminal	X												
Aria terminal	X												
pCO in pLAN	X												
FCM series controllers	X												
EVD200	X												
EVD400	X												
CAREL Slave devices (RS485)	X		X	X									X
pCOexp 485	X		X	X									X
Hydronic fan coil and CANbus											X		
PlantVisor local	X		X	X									
PlantWatch	X		X	X									
PCGate	X		X	X									
WebGate	X		X	X									
GATEWAY**0	X		X	X									
LON - Echelon RS485							X						
LON - Echelon FTT10							X						
TREND								X					
HTTP client									X				
BACnet/Ethernet									X				
BACnet/IP									X				
BACnet/MSTP (RS485)										X			
SNMP v1, SNMP v2C									X				
SNMP v3									X				
Modbus supervisor (RTU)			X	X									
Modbus Slave devices	X		X	X									
pCOexp Modbus	X		X	X									
BenShaw devices			X	X									
WinLoad local	X	X	X	X									
WinLoad remote, analogue modem					X								
PlantVisor remote, analogue modem					X								
WinLoad remote, GSM modem					X								
PlantVisor remote, GSM modem					X								
Send and receive SMS					X								
Serial printer					X								

Protocol active on the pCO	Notes
Display panel	
Local terminal or pLAN	
Local terminal or pLAN	With Local terminal the pGD* works in pCOT emulation mode
Local terminal or pLAN	
pLAN	
CAREL Master or CAREL Master 5 exp.	CAREL Master: can only be activated on BMS serial CAREL Master 5 exp.: can only be activated on pLAN serial
CAREL Master	
CAREL Slave	Can only be activated on one serial port  Incompatible with protocols PSTN GSM Modbus Slave  For SNMP v3 special pCOWEB software is used
Modbus Slave	Incompatible with CAREL Slave, PSTN, GSM
Modbus Master	Can only be activated on one serial port
Modbus Master - Benshaw	Maximum of two Benshaw devices
WinLoad	Can only be activated on 1 serial. Incompatible with PSTN & GSM
PSTN	Incompatible with CAREL Slave and Modbus Slave
GSM	Incompatible with CAREL Slave and Modbus Slave
Serial printer	

# pCO<sup>3</sup>

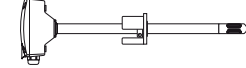

## Available probes

-  SPKT: 4 to 20 mA pressure transducers 0 to 5 V ratiometric transducers
-  NTC: temperature probes
-  ASP\*: industrial ambient temperature and humidity probes
-  ASW\*: ambient temperature and humidity probes
-  ASD\*: duct temperature and humidity probes



# pCO<sup>XS</sup>

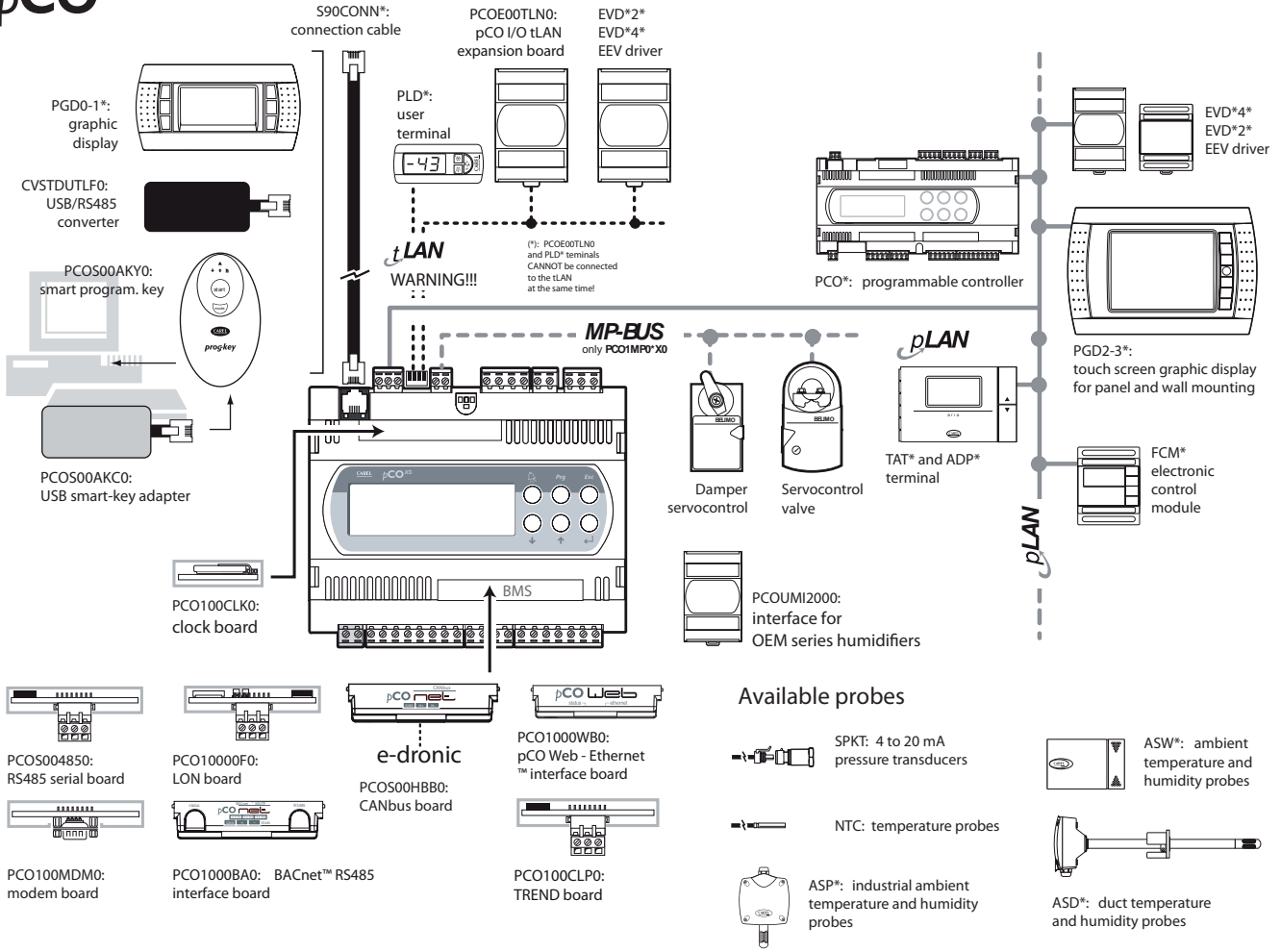

# pCO<sup>C</sup>

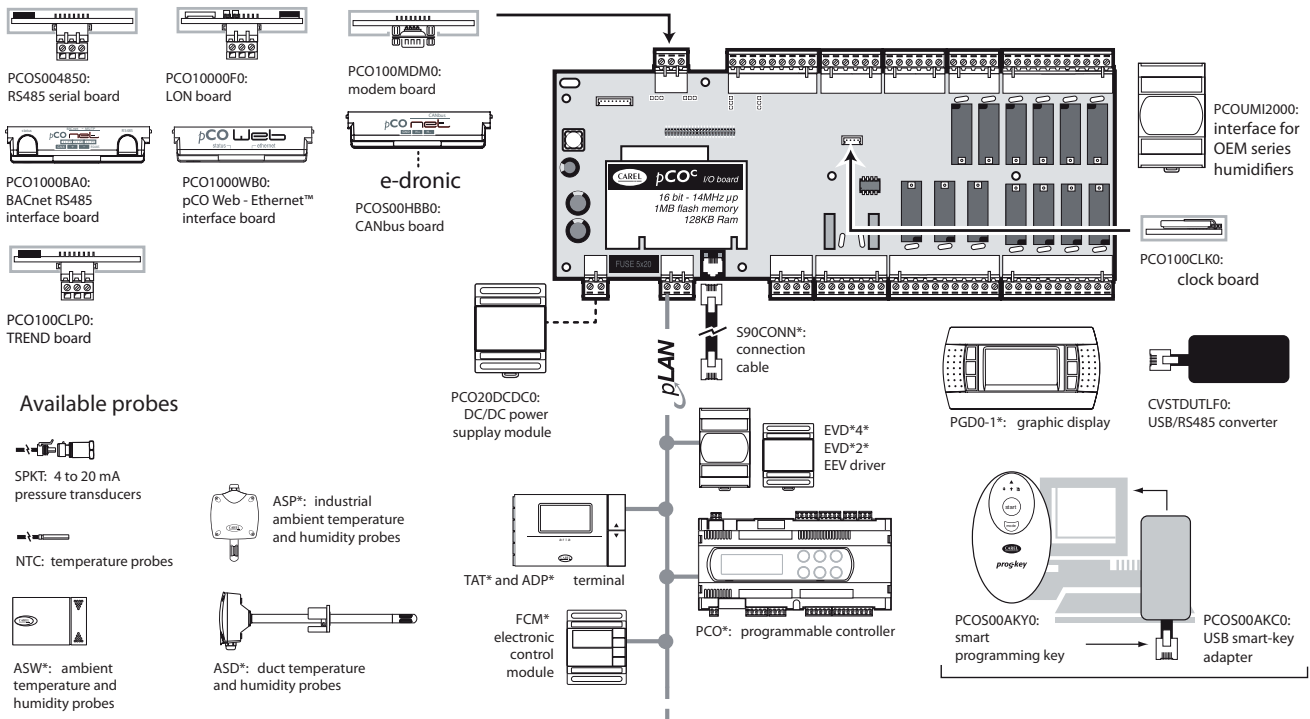









# CAREL

**CAREL INDUSTRIES - HQs**

Via dell'Industria, 11 - 35020 Brugine - Padova (Italy)

Tel. (+39) 049.9716611 Fax (+39) 049.9716600

[www.carel.com](http://www.carel.com) - e-mail: [carel@carel.com](mailto:carel@carel.com)

Agency:

code +030220336 rel. 1.5 - 22/12/2010