

Restricted

Serial N^o 9564

MODEL RAK-7
RADIO RECEIVING EQUIPMENT

CLASS IA, A-C OPERATED

Range: 15-600 Kilocycles

INSTRUCTIONS

Manufactured for

NAVY DEPARTMENT—BUREAU OF SHIPS

by

RCA VICTOR DIVISION OF RADIO CORPORATION OF AMERICA

Camden, New Jersey, U. S. A.

CONTRACT NX₈₈-19101

DATED: Dec. 5, 1942

**Sub-Contractor: Andrea Radio Corporation, Long Island
City, N. Y.**

**Radio Receivers (Serials 1251 through 2000)
Rectifier Power Units (Serials 2501 through 4000)
Control Units (Serials 1251 through 2000)**

NOTICE

Radio Receivers (Serials 1251 through 2000), Rectifier Power Units (Serials 2501 through 4000), and Control Units (Serials 1251 through 2000) have been manufactured under sub-contract by the Andrea Radio Corporation. The Navy Type Designation for all such units carries the prefix CND. The equipments are, in all other respects, identical with those bearing the prefix CRV. Throughout the instruction book the prefix CND should replace the prefix CRV for the equipments listed above.

In some cases it has been found necessary to make substitutions of original materials. However, all necessary factors have been maintained, so that replacements can be made, and wherever spare parts are involved in the substitutions, the spares are interchangeable with the parts mounted in the equipment. If it is found that the latter cannot be met, special instructions will be issued and supplied for all shipments affected.

ERRATA

in

IB-38219

MODEL RAK-7 RECEIVING EQUIPMENT

To be inserted in: Preliminary Instruction Book

TABLE II

- C-104—Description should bemmfd $\pm 2\%$,
C-108 A & B—Description should bemfd $\pm 10\%$,
Drawing should beP721074-57
C-114 A & B—Description should bemfd $\pm 10\%$,
C-139—Description should bemmfd $\pm 2\%$,
C-201—Description should bemica, 0.01 mfd. . . .
R-102—Description should be2 watts. . . .
Add to miscellaneous:
Function—Lamp, for possible use with Item 52b
Description—Bayonet base, clear, 6-8 v, 0.25 amp.
Mfr.—18
Dwg. No.—K-61114-15

TABLE IV—EQUIPMENT SPARES

- Add Item 2a:
Quantity—2
Description—Lamp, bayonet base, clear, 6-8 v, 0.25 amp., for possible use with Item 52b
Mfr.—18
Dwg. No.—K-61114-15
Item 5—Cat. No. should be changed to 20902-CZ
Item 28a—Quantity should be changed to 2. Add * to Item No. 28a.
Page iii, add footnote:—* If Item 28a is not available, the same quantity of Item 11 may be substituted
Item 49—Description should beohms $\pm 10\%$, $\frac{1}{2}$ watt. . . .
Item 53—Description should be $\pm 10\%$, 2 watts. . . .
Item 55—Description should be $\pm 10\%$, 2 watts. . . .

TABLE IV—BASE SPARES

- Add Item 57a:
Quantity—6
Description—Lamp, bayonet base, clear, 6-8 v, 0.25 amp., for possible use with Item 52b
Mfr.—18
Dwg. No.—K-61114-15
Add Item 57b:
Quantity—1
Description—Adapter assembly
Mfr.—1
Dwg. No.—K-883492-501
(In the event Item No. 58 (M101) is not available, Item No. 57b is to be substituted. Item No. 58 shall be furnished at a later date.)
Page ii—Item No. 64 should be changed to 64a

TABLE VI—LIST OF MANUFACTURERS

Code No. 73—Address should be: Andrea Radio Corp., 43-20 34th St., Long Island City, N. Y.

RCA VICTOR DIVISION

OF

RADIO CORPORATION OF AMERICA

Camden, New Jersey, U. S. A.

CONTRACT: NX_{ss}-19101

DATED:

IB-38219-e
431022

ERRATA
IN IB-38219

MODEL RAK-7 RECEIVING EQUIPMENT

To be inserted in: Instruction Book
Equipment Spare Parts List

(This errata supplements errata e)

TABLE II

R-202 - Description should be changed to ... ohms $\pm 10\%$
Navy Type No. should be changed to -631629-10
Under Miscellaneous -
Description for lamp should be changed to ... with
item 57b

TABLE III

R-202 - Navy Type No. should be changed to -631629-10

TABLE IV - EQUIPMENT SPARES

Item 2a - Description should be changed to ... with item 57b
Item 57 - Navy Type No. should be changed to -631629-10
Description should be changed to ... ohms 10%

RADIO CORPORATION OF AMERICA - RCA VICTOR DIVISION
Camden, New Jersey, U.S.A.

CONTRACT: NXss-19101
DATED:

IB-38219-h
431129

RESTRICTED

SERIAL NO. 9564

INSTRUCTIONS
for
MODEL RAK-7
RADIO RECEIVING EQUIPMENT
CLASS IA, A-C. OPERATED
Range: 15-600 Kilocycles

The RCA Victor Division of Radio Corporation of America, guarantees all parts and spare parts used in this equipment (with the exception of vacuum tubes) and specifically agrees to replace, at its own expense and without delay, all items found to be defective in design, material, workmanship or manufacture, within the service period of one year. This guarantee shall not obligate the manufacturer as to the replacement of defective items for more than two years, after delivery to the Government, of the items so failing, and further provided that

THIS PERIOD OF TWO YEARS AND THE SERVICE PERIOD OF ONE YEAR SHALL NOT INCLUDE ANY PORTION OF THE TIME THAT THE EQUIPMENT FAILS TO GIVE SATISFACTORY PERFORMANCE DUE TO DEFECTIVE ITEMS AND THE NECESSITY FOR REPLACEMENT THEREOF; PROVIDED ALSO THAT ANY REPLACEMENT PARTS SHALL BE GUARANTEED TO GIVE ONE YEAR OF SERVICE.

Report of failure of any part of this equipment during its service life shall be made to the Bureau of Engineering in accordance with current instructions. The report shall cover all details of the failure and shall give the date of installation of the equipment. For report of failures during the specified guarantee period, see Bureau of Engineering Circular Letter No. 40, dated 26 March, 1936, or any subsequent revision thereof.

Manufactured for
NAVY DEPARTMENT—BUREAU OF SHIPS
by
RCA VICTOR DIVISION OF RADIO CORPORATION OF AMERICA
Camden, New Jersey, U. S. A.

CONTRACT NX_{ss}-19101
DATED: Dec. 5, 1942

IB-38219

INDEX

| <i>Subject</i> | <i>Page</i> |
|--|-------------|
| Title Page..... | 1 |
| Index..... | 2 |
| Frontispiece..... | 4 |
| I. Introduction..... | 5 |
| II. Equipment..... | 5 |
| III. Tube Complement..... | 6 |
| IV. Power Requirements..... | 6 |
| 4.1 Normal Operation..... | 6 |
| 4.2 Emergency Battery Operation..... | 6 |
| V. Antenna Requirements..... | 7 |
| VI. Installation..... | 7 |
| 6.1 Receiver Mounting..... | 7 |
| 6.2 Power Unit Mounting..... | 8 |
| 6.3 Control Unit Mounting..... | 8 |
| 6.4 Wiring..... | 8 |
| VII. Tube Locations..... | 9 |
| 7.1 Power Unit CRV-20131..... | 9 |
| 7.2 Receiver Unit CRV-46155..... | 9 |
| VIII. Construction..... | 10 |
| 8.1 Dimensions and Weight..... | 10 |
| 8.2 Receiver Unit CRV-46155..... | 10 |
| 8.3 Power Unit CRV-20131..... | 11 |
| 8.4 Control Unit CRV-23073..... | 11 |
| IX. Circuit Description..... | 11 |
| 9.1 Circuit Arrangement..... | 11 |
| 9.2 Antenna..... | 11 |
| 9.3 Sensitivity and Selectivity..... | 11 |
| 9.4 Audio System..... | 12 |
| 9.5 Power Unit..... | 13 |
| 9.6 Control Unit..... | 15 |
| 9.7 Interference Reduction..... | 15 |
| X. Operation..... | 15 |
| 10.1 Controls of Receiver Unit CRV-46155..... | 15 |
| 10.2 Controls of Power Unit CRV-20131..... | 17 |
| 10.3 Controls of Control Unit CRV-23073..... | 17 |
| 10.4 CW Reception..... | 18 |
| 10.5 ICW or Modulated Signal Reception..... | 20 |
| XI. Performance..... | 21 |
| 11.1 Sensitivity..... | 21 |
| 11.2 Maximum Noise..... | 21 |
| 11.3 Selectivity and Overload Selectivity..... | 21 |
| 11.4 Calibration..... | 22 |
| XII. Maintenance—Trouble Location and Remedy..... | 22 |
| 12.1 General..... | 22 |
| 12.2 Equipment..... | 22 |
| 12.3 Dead Receiver..... | 22 |
| 12.4 Weak Signals with Receiver Noise Level Normal..... | 22 |
| 12.5 Weak Signals with Detector Failing to Oscillate on All Bands..... | 22 |
| 12.6 Weak Signals with Detector Oscillating Normally..... | 26 |

INDEX—(Continued)

| <i>Subject</i> | <i>Page</i> |
|---|-------------|
| 12.7 Failure of Detector to Oscillate on Some Bands; Other Bands Normal..... | 26 |
| 12.8 Weak signals on some Bands; Other Bands Normal—Detector Oscillating Normally on All Bands..... | 26 |
| 12.9 Panel Trimmer Controls..... | 26 |
| 12.10 Power Supply..... | 27 |
| 12.11 Audio Amplifier..... | 27 |
| 12.12 R-F Amplifier..... | 27 |
| 12.13 Tube Characteristics..... | 28 |
| 12.14 Tube Socket Voltages..... | 29 |
| 12.15 Circuit Continuity..... | 30 |
| 12.16 Frequency Band Switch..... | 31 |
| 12.17 Receiver Alignment..... | 32 |
| 12.18 Lubrication..... | 33 |
| 12.19 Cleaning..... | 33 |
| XIII. Parts Lists..... | 35 |

Illustrations

| <i>Figure</i> | <i>Page</i> |
|--|-------------|
| Frontispiece—Model RAK Equipment mounted with a Model RAL Equipment..... | 4 |
| 1—Power Unit CRV-20131 (Top View of Chassis)..... | 9 |
| 2—Receiver Unit CRV-46155 (Top View of Chassis)..... | 10 |
| 3—Receiver Unit CRV-46155 (Top View of Chassis—Covers Removed)..... | 12 |
| 4—Power Unit CRV-20131 (Top View of Chassis—Covers Removed)..... | 14 |
| 5—Control Unit CRV-23073 (Rear View of Panel)..... | 16 |
| 6—Receiver Unit CRV-46155 (Bottom View of Chassis—Covers Removed)..... | 16 |
| 7—Power Unit CRV-20131 (Bottom View of Chassis)..... | 18 |
| 8—Sensitivity Curve..... | 19 |
| 9—Maximum Noise Curve..... | 19 |
| 10—Average Selectivity (CW Interference)..... | 23 |
| 11—Average Selectivity and Overload Selectivity..... | 24 |
| 12—Average Frequency Calibration Curves..... | 25 |
| 13—Receiver Unit CRV-46155 (Bottom View of Chassis)..... | 31 |

Drawings

| <i>Figure</i> | <i>Page</i> |
|--|-------------|
| 14—Outline and Installation (P-720164)..... | 66 |
| 15—External Cable Connection Diagram (P-721267)..... | 67 |
| 16—Schematic Diagram, Receiver Unit CRV-46155 (T-621283)..... | 68 |
| 17—Schematic Diagram, Power Unit CRV-20131 (M-422922)..... | 69 |
| 18—Schematic Diagram, Control Unit CRV-23073 (M-407021)..... | 70 |
| 19—Connection Diagram, Receiver Unit CRV-46155 (W-306617)..... | 71 |
| 20—Connection Diagram, Power Unit CRV-20131 (T-620092)..... | 73 |
| 21—Connection Diagram, Control Unit CRV-23073 (P-714101)..... | 74 |
| 22—Tube Socket Connections (K-850992)..... | 75 |

Frontispiece—Model RAK Equipment mounted with a Model RAL Equipment

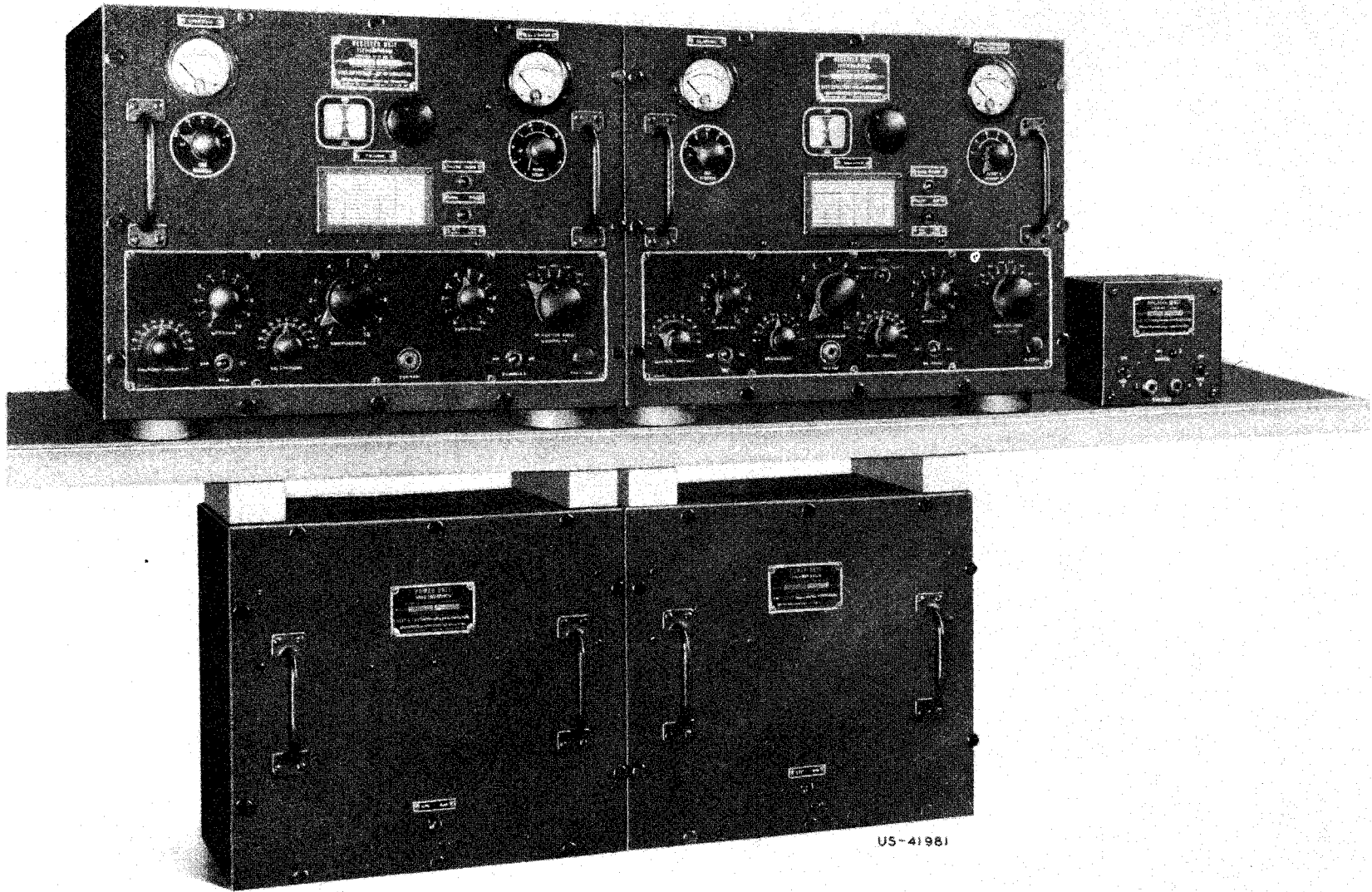

RESTRICTED

This instruction book is furnished for the information of commissioned, warranted, enlisted and civilian personnel of the Navy whose duties involve design, instruction, operation and installation of radio and sound equipment. The word "RESTRICTED" as applied to this instruction book, signifies that this instruction book is to be read only by the above personnel, and that the contents of it should not be made known to persons not connected with the Navy.

I

INTRODUCTION

- 1.1 THESE INSTRUCTIONS SHOULD BE READ AND STUDIED WITH GREAT CARE BEFORE THE INSTALLATION OR OPERATION OF THIS EQUIPMENT IS ATTEMPTED IN ORDER THAT OPTIMUM PERFORMANCE MAY BE OBTAINED.
- 1.2 These instructions cover the installation, operation, and servicing of the Model RAK-7 Radio Receiving Equipment. This receiving equipment is designed for a-c operation, being equipped with a power unit for supplying all operating voltages required from an a-c source of 110, 115, or 120 volts, 60 cycles.
- 1.3 This equipment covers the frequency range of 15-600 kilocycles and is designed for optimum performance for the reception of pure, modulated or interrupted CW or damped radio telegraph signals. Voice-modulated reception is not recommended due to the r-f and a-f selectivity provided in these receivers. The output circuit is designed for use with one pair of 600-ohm phones.
- 1.4 The RAK Series equipment is designed for independent operation but is so designed with respect to size, shape and mechanical arrangement as to permit installation adjacent to an RAL Series equipment, forming a complete two-channel equipment suitable for guarding two frequencies simultaneously by one operator. A separate control unit, Type CRV-23073, may be used for this installation to provide flexibility of operation. This unit is described in a subsequent section of this instruction book.

II

EQUIPMENT

- 2.1 Each equipment consists of the following major component units:
 - (a) Receiver Unit, Type CRV-46155.
 - (b) Power Unit, Type CRV-20131.The Control Unit, Type CRV-23073, which is employed when a Model RAK is combined with a Model RAL, is shipped together with the latter equipment only. Both a-c supply cables (W-301) also are furnished only with the Model RAL Equipment.
- 2.2 In addition to the major units, each complete equipment includes the following items:
 - (a) Spare parts box, containing spares for major units.
 - (b) Cables, as follows:

| <i>Item</i> | <i>Quan.</i> | <i>Description</i> | <i>Dwg. No.</i> |
|-------------|--------------|--------------------------------------|-----------------|
| W-101 | 1 | Cable, output, 2-conductor, shielded | P-701688-505* |
| W-102 | 1 | Cable, output of filter to receiver | K-871377-501 |
| W-201 | 1 | Cable, power, 4-conductor, shielded | P-701688-504* |

NOTE: The cables listed above, marked with an asterisk*, may be replaced on some equipments by a substitute cable. These cables may be used interchangeably and are listed below:

| <i>Symbol No.</i> | <i>Regular Cable</i> | <i>Alternate Cable</i> |
|-------------------|----------------------|------------------------|
| W-101 | P-701688-505 | T-722270-503 |
| W-201 | P-701688-504 | T-722270-501 |
| W-301 | P-701688-503 | T-722270-502 |

(c) Shock absorbers, as follows:

| Item | Quan. | Description | Dwg. No. |
|-----------|-------|---|------------|
| SA-101 {A | 4 | Shock absorber, upper portion, 1 1/8" thick | K-806699-5 |
| SA-101 {B | 4 | Shock absorber, lower portion, 1/2" thick | K-806699-4 |

(d) Miscellaneous mounting hardware, as follows:

| Item | Quan. | Description | Dwg. No. |
|---------|-------|--|------------|
| H-101 | 4 | Bolt, 1/2"-13, 3 1/2" long, hex. head | K-806306-3 |
| H-102 | 4 | Washer, flat, 2" O.D., 9/16" I.D., 0.1285" thick | K-806304-1 |
| H-103 | 8 | Nut, 1/2"-13, hexagonal | K-59149-33 |
| * H-104 | 3 | Cap screw, 5/16"-18, 3/4" long, hex. head | K-59286-53 |
| * H-105 | 6 | Washer, flat, 7/8" O.D., 11/32" I.D., 0.064" thick | K-57428-74 |
| * H-106 | 3 | Spacer, 11/16" O.D., 0.327" I.D., 0.125" thick | K-59294-38 |
| * H-107 | 3 | Lockwasher, 5/16", split type | K-59048-36 |
| * H-108 | 3 | Nut, 5/16"-18, hexagonal | K-57435-59 |
| † H-201 | 4 | Cap screw, 1/4"-20, 3/4" long, hex. head | K-59285-53 |
| † H-202 | 8 | Washer, flat, 11/16" O.D., 0.260" I.D., 0.051" thick | K-57428-73 |
| † H-203 | 4 | Spacer, 11/16" O.D., 0.265" I.D., 0.125" thick | K-59294-37 |
| † H-204 | 4 | Lockwasher, 1/4", split type | K-59048-35 |
| † H-205 | 4 | Nut, 1/4"-20, hexagonal | K-57435-58 |

* Parts for interlocking receiver units of Models RAK and RAL.

† Parts for interlocking power units of Models RAK and RAL.

III

TUBE COMPLEMENT

3.1 The following Navy standard vacuum tubes are required for each equipment:

- | | |
|--|--------------------------------|
| 4—Type -6D6 RF Amplifiers, Detector and Audio. | 1—Type -5Z3 Rectifier. |
| 2—Type -41 Output and AVC. | 1—Type -874 Voltage Regulator. |
| | 1—Type -876 Current Regulator. |

IV

POWER REQUIREMENTS

4.1 Normal Operation.

- 4.1-1 The receiver is designed to operate from a 110-, 115-, or 120-volt, 60-cycle, single-phase, a-c supply, with a fast and slow voltage variation not exceeding $\pm 10\%$.
- 4.1-2 The total power consumption of the RAK Series equipment is approximately 60 watts when the current-regulator tube in the power unit is not used, and approximately 200 watts when the current-regulator tube is in the circuit (see paragraphs 9.5-6 and 10.2-3).

4.2 Emergency Battery Operation.

- 4.2-1 The filament supply may be obtained from a 6-volt storage battery. The current drain is approximately 2 amperes.
- 4.2-2 A single "B" potential of 180 volts is required. This supply may be either a storage battery or a suitable combination of dry cell batteries. The current drain is approximately 45 milliamperes. No "C" batteries are required.

V

ANTENNA REQUIREMENTS

- 5.1 This equipment is primarily designed for operation with a separate antenna not used for other equipment. However, the Model RAK Equipment may be operated on an antenna common with the Model RAL Equipment as an emergency measure. The antennas should be spaced at least 6 feet from any parallel stay, mast or stack, must be well insulated and erected as high as possible. The length of antenna should be approximately 50 feet in the clear. A $\frac{1}{2}$ -megohm static-drain resistor should be permanently installed between each antenna and ground. If a particularly long antenna installation is desirable, or if the lead-in arrangement obtains particularly high capacity to ground, the link across C-101 on the antenna terminal board should be operated. The removal of this link from the circuit will place C-101 in series with the antenna. It is preferable to operate the receiver with the link across the capacitor. If, however, particularly on Bands "1" and "2," resonance can not be obtained with the antenna trimmer, this should be taken as evidence that the link across C-101 should be opened.

NOTE: NO OTHER RECEIVER SHOULD BE USED ON THE SAME ANTENNA WITH THIS EQUIPMENT EXCEPT AS AN EMERGENCY MEASURE.

- 5.2 The receiver antenna receptacle is designed to be used with a Navy Type -49121 concentric line plug. Connection to the antenna may be made with any suitable insulated conductor, terminated in the Navy Type -49121 plug. Where the installation may be subject to interference from local r-f fields, the antenna should be connected to the receiver by means of a length of shielded transmission line, terminated in the Navy Type -49121 plug. The shielding should be bonded to the plug and to the antenna trunk shield.
- 5.3 When it is necessary to operate this equipment from an antenna common to an RAL equipment, the shorting link across decoupling capacitor C-101 should be opened. This link is located on the antenna terminal board, inside the receiver cabinet, at the left rear corner of the receiver chassis. Use of a $\frac{1}{2}$ megohm static drain resistor, connected between antenna and ground, is recommended when the link is open for common antenna operation.
- 5.4 The ground connection should be made to some grounded metal portion of the ship, as specified under "Wiring (paragraph 6.4-2) and should be soldered, if practicable, to prevent variable- or high-resistance contact due to corrosion.
- 5.5 The use of bonded stays is equally as desirable with this equipment as with other Navy receivers to eliminate noises arising from variable contacts or grounds on such stays.

VI

INSTALLATION

6.1 Receiver Unit Mounting.

- 6.1-1 It is essential that the receiver unit be secured to its table by means of the rubber shock absorber mounting provided. Figure 14 illustrates in detail the manner in which these receivers are to be installed, including dimensions for drilling the operating table or desk. In planning this installation, care should be exercised to provide for a clearance of at least three inches or more from the back of the receivers to the bulkhead or nearest obstruction in order to permit movement of cables when withdrawing the chassis from the cabinets for servicing. Should these receivers be operated in pairs, the cabinets must be bolted together and in place after the chassis have been removed. To remove the receiver chassis, it is necessary to loosen the thumb screws holding the front panel to the cabinet. (These thumb screws do not come clear of the panel.) If the equipment has been previously set up, it will be necessary to disconnect the cables to the auxiliary equipments. Using the handles provided on the front panel, remove the chassis completely from the cabinet. **CARE SHOULD BE TAKEN TO SET THE CHASSIS ON A FLAT SURFACE FREE FROM ANY OBJECTS WHICH MIGHT DAMAGE THE SHIELDING.**
- 6.1-2 The several cables of this equipment should be fed through the holes in the rear of the cabinet and connected as shown in Figure 15. The large shielded cable (W-201) connects the receiver unit to the power unit. A smaller shielded cable (W-101) connects the control unit (its use being optional) to the receiver unit, while another cable (W-301) connects the power unit to the control unit. Should only one receiver and no control unit be used, refer to Figure 15 for the power cord connections.
- 6.1-3 Using a one-inch drill, pierce the top of the desk in accordance with the dimensions given in Figure 14. Place one rubber shock absorber (SA-101A) in each of these

holes. Locate the cabinets in their proper positions on the desk top so that their mounting holes coincide with the holes in the shock absorbers and insert the mounting bolts. Next, place the bottom shock-absorber (SA-101B), a metal washer, nut and lock nut on each bolt as shown in Figure 14, but do not tighten the nuts. In case two receivers are used together, bolt the adjacent sides by means of the short bolts provided. Place these bolts in the holes inside the cabinets. Place washers under the heads and washers, lockwashers and nuts on the opposite end of the bolt. Before tightening these nuts, carefully align the cabinets both horizontally and vertically. When the cabinets have been secured to each other, tighten the mounting bolts just sufficient to slightly compress the rubber shock absorbers.

6.2 Power Unit Mounting.

6.2-1 The power unit cabinet should be mounted beneath the operating table by means of four bolts, washers and lockwashers (not supplied). It should be spaced a minimum of $1\frac{1}{2}$ inches from the bottom of the table by cleats or other means so as to allow ample ventilation. The details of the installation and the drilling plan for these mounting bolts are also shown in Figure 14. Remove the power unit from the cabinet by first loosening the panel thumb screws and then withdraw by means of the two handles provided on the panel. If the equipment has been previously set up, it will be necessary to remove the cable connections from the terminal board at the right side of the power unit, just in back of the panel. For further details, see Figure 15.

6.3 Control Unit Mounting.

6.3-1 The control unit cabinet, when used, should be mounted at any convenient place on the operating table by means of two bolts through two holes provided in the bottom of the cabinet and fastened securely with lockwashers and nuts. To remove the chassis, loosen the four screws in the panel. Use of the control unit is optional with this equipment, its operation being described in paragraph 9.6.

6.4 Wiring.

6.4-1 The wiring between units is shown in Figure 15. At installation, the supply voltage should be measured or otherwise ascertained and the primary taps of the power transformer (T-201) shifted if necessary to comply with the nominal line rating. These taps are connected at the factory for 115 volts as indicated by the marking "115" adjacent to the terminals to which the *red* wires from toggle switch S-202 is connected (see Figures 1, 4 and 20). If the supply voltage is nearer 110 or 120 volts than 115 volts, shift these *red* wires to one of the two other pairs of terminals (marked "110" and "120," respectively) as required. To eliminate as much a-c hum and other electrical interference as possible, the 110-, 115-, or 120-volt, a-c supply should be connected to the power unit by a shielded twisted pair of wires (No. 14 or larger), or run in grounded conduit as far as the bulkhead adjacent to the power unit and terminated in a junction box. In no case should transformers or other a-c equipment be located in close proximity to the receiver.

6.4-2 Grounds should be made to some grounded metal portion of the ship. Contact surfaces must be scraped free from paint. Pipes should be avoided since they are a questionable ground aboard ship.

NOTE: THE IMPORTANCE OF SECURING A GOOD GROUND WITH A SHORT, DIRECT, LOW RESISTANCE GROUND LEAD CANNOT BE OVER-EMPHASIZED. THIS IS OF PARTICULAR IMPORTANCE IN MINIMIZING PICKUP AND INTERFERENCE FROM NEARBY TRANSMITTERS.

6.4-3 Sufficient slack should be left in sections of cables external to cabinets to permit withdrawal of chassis from cabinets for service checking with voltages applied.

6.4-4 Emergency Battery Operation.

Referring to Figure 15, Cable W-101 is used to connect the receiver output to the output line or to the control unit if used. In an emergency, should it be desired to operate the receiver on batteries, Cable W-201 connects the receiver to a battery terminal block (not supplied). The battery terminal block must be arranged to supply screw terminals for connection to the spade terminals of Cable W-201. Wiring from the batteries to the terminal block should be run in grounded conduit and the filament wiring should be of sufficient size to offer negligible voltage drop (each receiver draws approximately 2 amperes filament current).

VII TUBE LOCATIONS

7.1 Power Unit CRV-20131.

7.1-1 The tube locations are shown in Figures 1 and 15.

- (a) Type -5Z3 rectifier, left front of chassis.
- (b) Type -874 voltage regulator, right front of chassis.
- (c) Type -876 current regulator, center rear (not used if line regulation is within $\pm 10\%$; see paragraph 9.5-6).

7.2 Receiver Unit CRV-46155.

7.2-1 The tube locations are shown in Figures 2 and 15.

- (a) Type -6D6 first r-f, rear left of chassis.
- (b) Type -6D6 2nd r-f, rear center of chassis.
- (c) Type -6D6 detector, rear right of chassis.
- (d) Type -41 output limiter, left front of chassis.
- (e) Type -41 audio output, center front of chassis.
- (f) Type -6D6 first audio, right front of chassis.

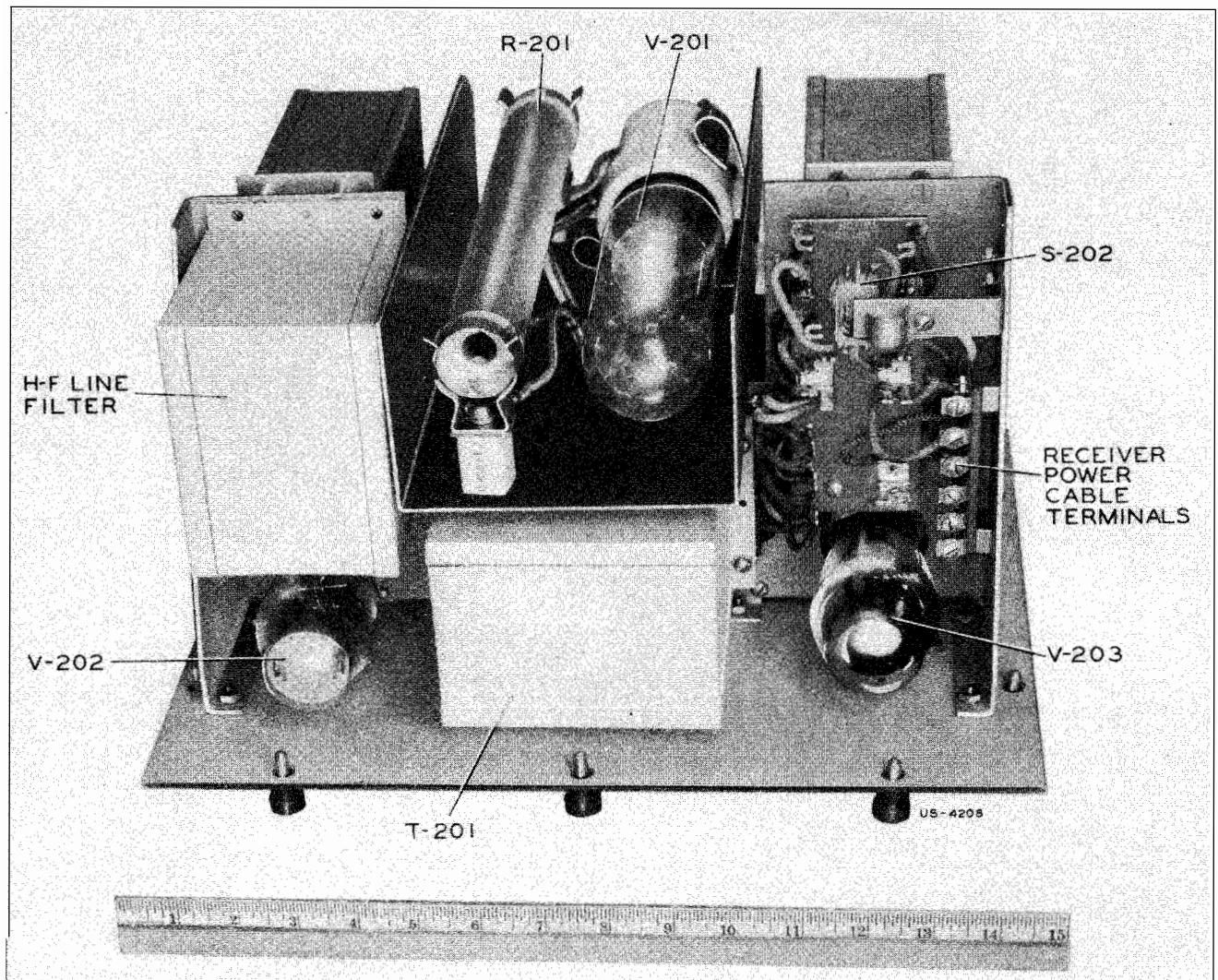

Figure 1—Power Unit CRV-20131 (Top View of Chassis)

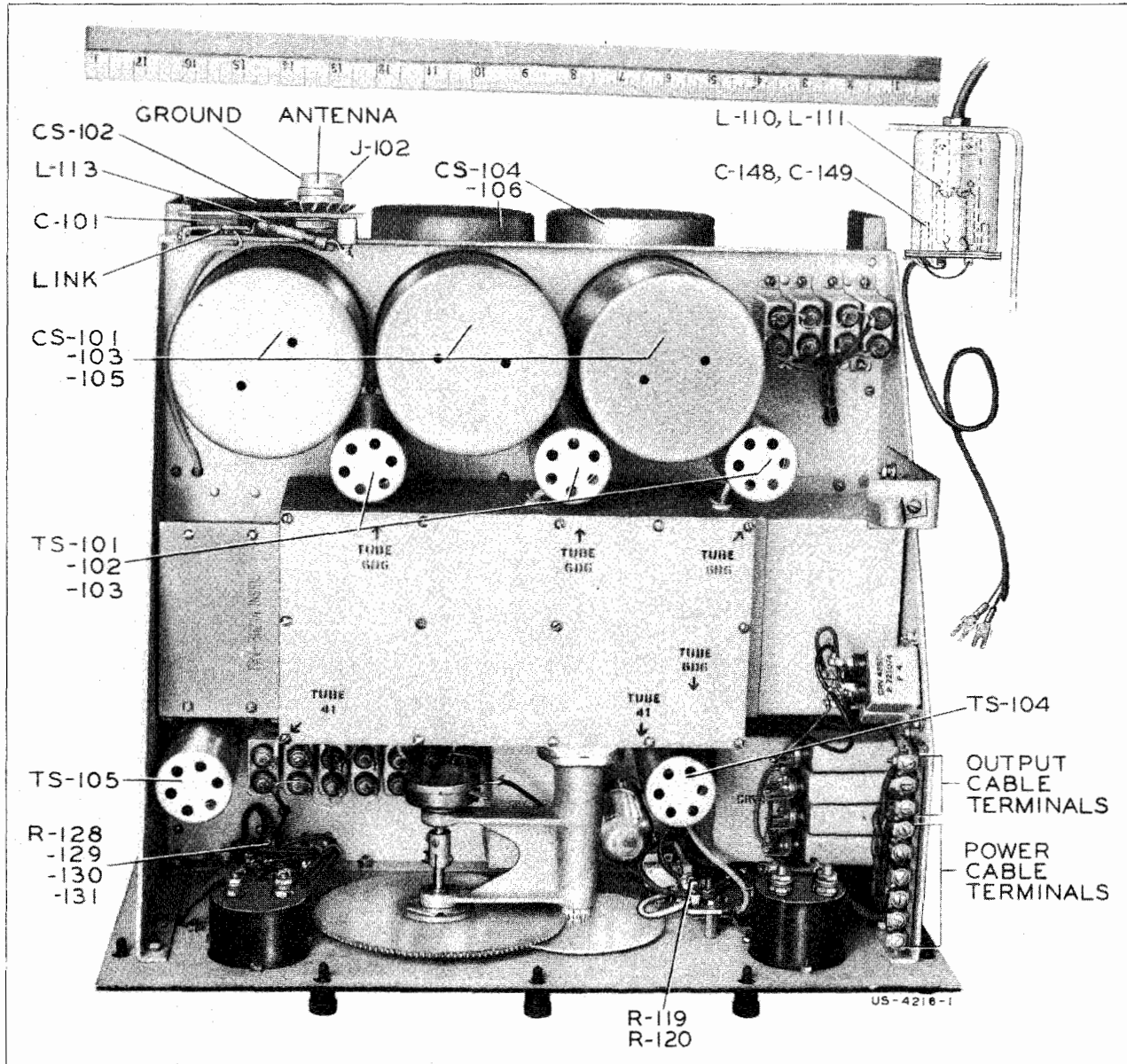

Figure 2—Receiver Unit CRV-46155 (Top View of Chassis)

VIII

CONSTRUCTION

8.1 Dimensions and Weights.

8.1-1 Figure 14 illustrates the overall dimensions of the RAK and RAL equipments as arranged for installation. The weights of the units are as follows:

- (a) Type CRV-46155 Receiver Unit. . . . 74 lbs.
- (b) Type CRV-20131 Power Unit. . . . 41 lbs.
- (c) Type CRV-23073 Control Unit. . . . 2 lbs.

8.2 Receiver Unit CRV-46155.

8.2-1 As indicated in Figure 14, the receiver unit is designed for table mounting. The cabinet may be permanently fastened to the table and the chassis is removable for access

to tubes, for servicing and for cable connections. All components are mounted on the chassis or panel forming a single assembly (see Figures 2, 3, and 6). Audio and AVC components are mounted directly behind the panel with filter and audio tuning units at the right, the first audio and output tubes in the center, and the AVC circuit at the left. Audio wiring, resistors, etc. are located beneath the chassis. The tuning capacitor assembly is located just back of the audio components. The top plate on the capacitor assembly is removable for inspection. At the rear of the chassis are located the r-f and detector tubes and the r-f coils, which are protected and shielded by screw cans. The power terminals are located at the right of the chassis and the antenna and ground terminals at the left. The band switch, r-f components and wiring are located beneath the chassis in a fabricated shield box. The large cover plate on the bottom of the receiver is removable for inspection and access to these parts.

8.3 Power Unit CRV-20131.

8.3-1 The power unit is designed for mounting underneath a table (see Figure 14). The cabinet may be permanently mounted, the chassis being removable for access to tubes, for servicing, and for cable connections. All components are mounted on the chassis or panel forming a single assembly (see Figures 1, 4, and 7). On top of the chassis from left to right are located the rectifier tube, h-f line filter shield, power transformer, voltage regulator tube, resistor board, and power terminals. The line filter shield at the left rear is removable for access to the line input terminals and fuses. In the center at the rear is located the current-regulator tube. Beneath the chassis from left to right are located the l-f line filter, ripple filter reactors, and ripple filter capacitor pack.

8.4 Control Unit CRV-23073.

8.4-1 The control unit contains output jacks, mixer switch, and power switches mounted on the panel. (See Figure 5.) Fuses and terminal boards are mounted on a bracket secured to the panel. The case may be permanently mounted to any flat surface (see Figure 14).

IX

CIRCUIT DESCRIPTION

9.1 The schematic diagram of the receiver unit (Figure 16) shows the arrangement of the radio- and audio-frequency circuits.

9.2 The antenna is capacitively coupled to the first tuned circuit, the coupling being fixed to give optimum energy transfer in order to secure the best possible signal-to-noise ratio. When it is necessary to operate this receiver from the same antenna as that of an RAL equipment (see Paragraph 5.2) looser coupling is desirable. A link has been provided upon the antenna terminal board, the removal of which link will place a capacitor (C-101) in series with the antenna and the antenna coupling capacitor (C-103).

9.3 The requisite sensitivity and selectivity at the signal frequency is obtained by the use of two r-f stages and a regenerative detector stage. Uni-control is accomplished by means of a 3-gang variable capacitor, tuning the two r-f stages and the detector.

9.3-1 The frequency range of 15 to 600 kilocycles is covered in six bands by means of coil switching as shown on the schematic diagram. The necessary inductances are wound on two sets of coil bodies. Unused portions of the coils are grounded or short circuited where they would otherwise cause undesirable losses to be placed in the tuned circuit.

9.3-2 Two Type -6D6 tubes are used as r-f amplifiers and a third Type -6D6 is used as a regenerative detector.

9.3-3 In order to hold the sensitivity of the receiver essentially constant over the wide frequency range employed, and to improve selectivity, the plate circuits of the two r-f amplifier stages are tapped down on their tuning impedances. In addition, a rheostat connected to the main tuning dial is arranged to increase the bias on the r-f tubes as the tuning capacitor is rotated toward the high-frequency end of the band. This rheostat automatically obtains uniform sensitivity over a given band as the tuning dial is rotated.

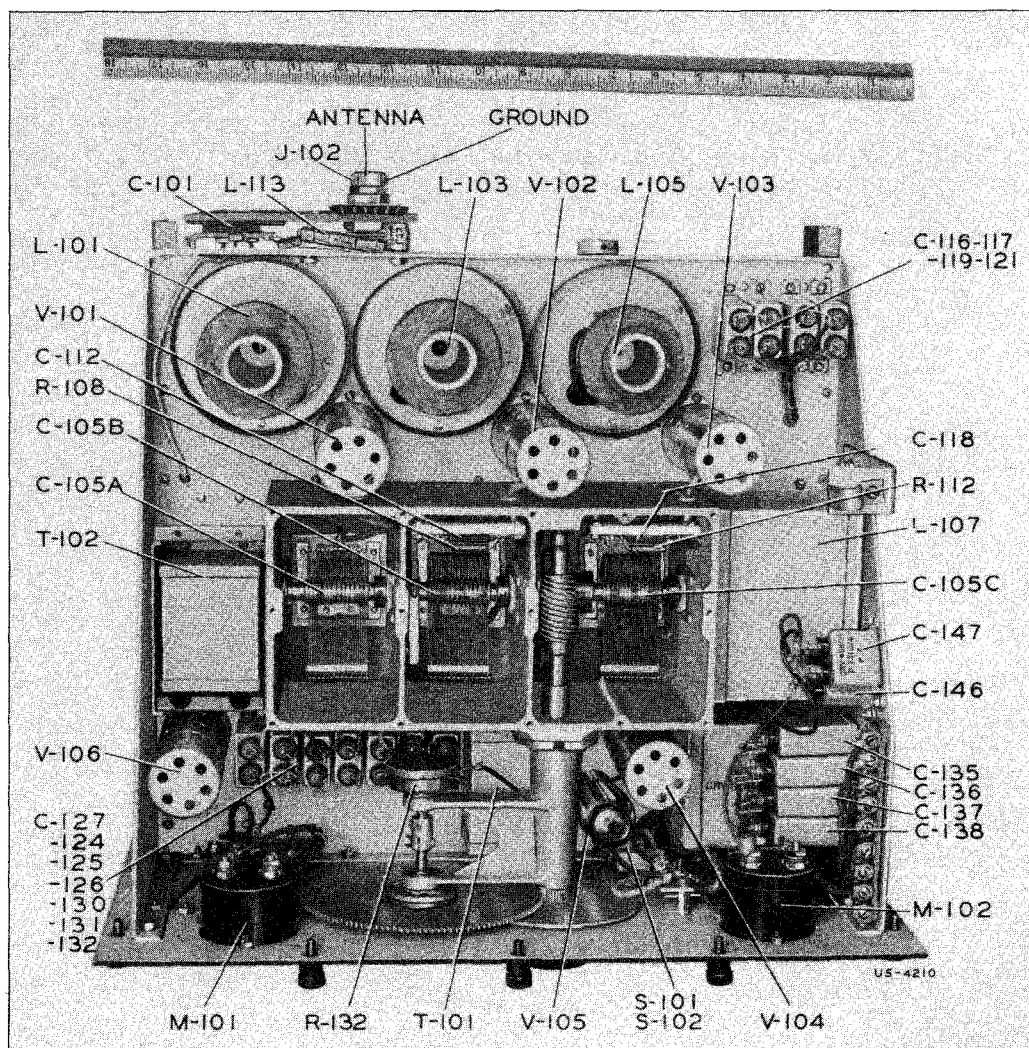

Figure 3—Receiver Unit CRV-46155 (Top View of Chassis—Covers Removed)

- 9.3-4 CW reception and improved sensitivity and selectivity is accomplished by the use of a specially-designed autodyne detector circuit. This detector employs the familiar electron coupling with the resultant minimizing of reaction in all circuit switching in the audio system. A very high degree of frequency stability is inherent in this type of circuit. The particular design obviates the necessity for frequent adjustment of the "Regeneration" control and renders it possible to obtain the desired performance characteristics of this detector without critical adjustment of the controls.
- 9.3-5 Sensitivity is controlled by varying the cathode potential of the two r-f stages with respect to the grid potential of those stages.
- 9.3-6 In order to obtain optimum performance of the equipment under all service conditions, small trimmer capacitors adjustable from the front panel are provided on the first and second r-f tuned circuits.
- 9.3-7 The receiver unit is completely shielded both internally and externally to minimize cross talk between receivers. All power leads are filtered with resistance-capacity filters. Inter-stage shielding is provided to increase selectivity and stability and to minimize reaction.
- 9.4 The audio system includes two stages of amplification and an output limiter. Filters are provided which increase the effective CW selectivity and improve the signal-to-noise ratio.

- 9.4-1 A low-pass filter immediately follows the detector circuit. This filter provides attenuation of less than 6 db at 1200 cycles and more than 40 db at frequencies above 1600 cycles.
 - 9.4-2 A variable audio-frequency attenuator which may be switched in or out of the circuit by means of a panel control follows the low-pass filter. This attenuator operates over the range of 450-1300 cycles (this indicates "acceptance" of the frequency to which the attenuator is adjusted and "attenuation" of other frequencies). A choice of resonant frequency is afforded by means of a 10-position switch and a 2-position range switch. Schematically, this attenuator is a tuned circuit inserted in parallel with the grid of the first audio stage.
 - 9.4-3 A Type -6D6 tube is used in the first audio-frequency amplifier stage.
 - 9.4-4 The first audio stage is resistance coupled to a Type -41 output stage which, in turn, is transformer coupled for use with an output impedance of approximately 600 ohms. The output transformer employs an electrostatic shield and a center-tapped output winding to obtain a balanced output circuit.
 - 9.4-5 A switch operated from the front panel permits an audio limiter tube (Type -41) to operate on the plate circuit of the output stage. The switch connects the output limiter transformer in parallel with the primary of the output transformer. The output limiter transformer has a high voltage step-up ratio and feeds the Type -41 tube which is connected as a biased rectifier. When the receiver output reaches a certain level (determined by an adjustable bias on the rectifier), the rectifier starts drawing grid current and the rectifier grid resistance decreases. This resistance reflected through the high-ratio transformer results in a low effective impedance load in the receiver output stage plate circuit and thus limits the output voltage to a certain value. Since the AVC is operated by audio output only, it is not affected by strong CW signals which do not produce an audio beat note. The output level to which the signal is limited may be varied by adjustment of the rectifier bias from the control on the front panel.
- NOTE:** THIS CONTROL IS NOT INTENDED FOR USE ON VOICE-MODULATED SIGNALS SINCE IT INTRODUCES HARMONICS OF THE AUDIBLE NOTE AND PRODUCES PROHIBITIVE DISTORTION.
- 9.4-6 A rectifier type DB output meter and range switch are provided on the front panel. This meter indicates the audio level delivered to the headphones.
 - 9.4-7 A voltmeter which indicates filament voltage is provided on the front panel.
 - 9.4-8 Normally, the a-c power is controlled either from the control unit or the power unit. In addition, a d-c power "On-Off" switch is provided on the receiver panel for use only in the event the receiver in an emergency is operated on batteries. *If this switch is opened when the receiver is normally operated on a.c., the load is removed from the power unit and overloading and damage of certain of its parts may result.* For this reason, shorting links are provided behind the panel (see Figure 6) which permanently close this switch circuit. If it is desired in an emergency to operate the receiver on batteries, these links should be opened.
- 9.5 Power Unit CRV-20131, shown schematically in Figure 17, has been very carefully designed in order to maintain an accurate calibration of the receiver and a high degree of frequency stability. Several special features are embodied in the design in order to afford very constant voltage on the screen grid of the autodyne detector which is the element primarily affected by power supply voltage variation. The power supply circuit consists essentially of r-f filters in the a-c supply line, a Type -876 current regulator (used when required), an electrostatically-shielded power transformer, a Type -5Z3 rectifier tube, a specially developed two-stage filter, a Type -874 voltage regulator, and a protective bleeder.
- 9.5-1 The r-f filter unit has been very carefully designed substantially to eliminate cross talk between several equipments operating from one power supply system and to reduce interference which may be present on the a-c line.
 - 9.5-2 The power transformer has been designed for operation from a 110-, 115-, or 120-volt, 60-cycle supply, and taps are provided on the primary to accommodate any of these nominal voltages. The total power consumption of this transformer under normal operation is approximately 60 watts. Filament supply is obtained from a center-tapped winding on this transformer.
 - 9.5-3 The Type -5Z3 rectifier tube and bleeder provide a plate source of good regulation.

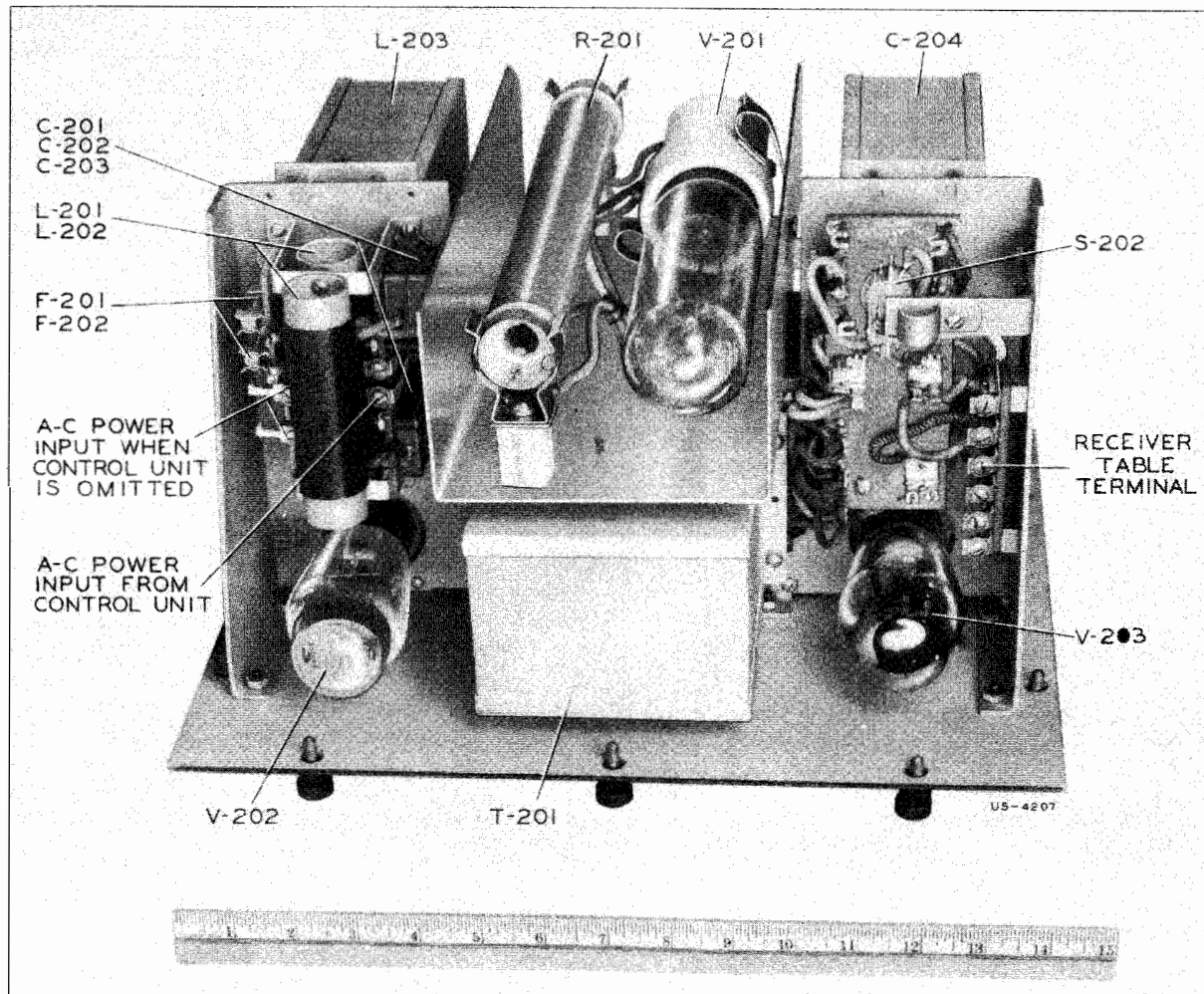

Figure 4--Power Unit CRV-20131 (Top View of Chassis - Covers Removed)

- 9.5-4 The screen voltage of the autodyne detector is stabilized by means of a Type -874 regulator tube.
- 9.5-5 A power switch is provided on the front panel of this unit for turning the equipment on and off when no control unit is employed.
- 9.5-6 In order to make this power unit interchangeable with the one used in the RAL Series equipment, a socket is provided for a Type -876 current-regulator tube. Since this equipment operates at relatively low frequencies, the additional freedom from effect of line voltage variation obtained from the current-regulator tube is not needed if the line regulation is within ± 10 percent. In the interest of conserving primary supply current, its use with this equipment is not recommended under normal circumstances. A switch, therefore, is provided inside the unit (see Figures 1 and 4) which accomplishes the changes in circuit necessary for operation without this tube. This switch disconnects the current-regulator tube and switches the power transformer primary for operation directly connected to the line filter. (See paragraph 10.2-3.)
- 9.5-7 Referring to Figure 15, it will be observed that four terminals are provided for connecting the 110-, 115-, or 120-volt, 60-cycle supply to the power unit. When this equipment is used with the control unit, the power connection from the control unit to the power unit is made to the two right-hand terminals. When no control unit is employed, the connection is made to the left-hand terminals. Connecting to the two right-hand terminals removes the power switch on the panel from the circuit. (See Figure 4.)

- 9.6 Control Unit CRV-23073 (see Figure 5) is shown schematically in Figure 18. The use of this control unit makes possible the guarding of two channels simultaneously. The output of each receiver feeds into the control unit where a 3-position switch is provided which makes available, in the two headphone jacks, signals from either or both of the receivers. Two power switches also are provided on the control unit panel for controlling the power to each receiver independently. The a-c power supply feeds into the control unit and each side of the line is fused. The two supply cables connect to suitable terminals on the power units, which terminals are arranged to omit from the circuit the switch and the fuses in the power unit.
- 9.7 In order to reduce interference from neighboring transmitters several filter circuits have been introduced as follows:
- 9.7-1 For the reduction of U.H.F. interference, a choke coil (L-113) is mounted on the concentric connector board. Normally, this choke coil is shorted by a bus; this bus should be cut if interference is reduced by temporarily disconnecting the antenna, see Figure 16.
 - 9.7-2 A filter assembly connected to the output jack J101 and consisting of coils L112A and L112B and by-pass capacitors C150 and C151 eliminates signal pick-up on the phone leads. The shield around the phone jack prevents direct radiation from the jack itself. See Figure 6.
 - 9.7-3 An output cable filter assembly consisting of series coils L110 and L111 and by-pass capacitors C148 and C149 prevents signal pick-up on the phone leads and output cable connecting the control box to the receiver. It is mounted in a shielded can which prevents any direct radiation when assembled inside the receiver cabinet. This filter unit is mounted in the cabinet and is illustrated in Figure 2.
 - 9.7-4 A grounding wiper is provided for the main tuning shaft to reduce radiation inside of the receiver.
 - 9.7-5 Grounding clamps are provided on the Receiver and Power Supply Unit cases for grounding the braided shielding of the output and power supply cables. (W101 and W201.)

X

OPERATION

- 10.1 Controls of Receiver Unit CRV-46155.
- 10.1-1—Antenna Connection: For normal operation from a separate antenna, connection should be made as directed in Paragraph 5.2. The shorting link across C-101 should be closed. For operation in conjunction with the RAL series equipment from a common antenna, the shorting link across C-101 should be open (see Paragraph 5.3).
 - 10.1-2 "FREQUENCY BAND" Selector Control: This control serves as a means for changing the required inductance for the various radio-frequency bands. The switch pointer should be set on the band number falling between the frequencies which establish the desired frequency range. Frequencies are marked in kilocycles.
 - 10.1-3 "TUNING" Control: The tuning control varies the setting of the three-gang variable tuning capacitor. The scale increases with frequency.
 - 10.1-4 "ANTENNA TRIMMER" Control: This control is a variable trimmer capacitor for the antenna tuning stage (1st R-F grid circuit). In general, it is adjusted once for each band, preferably at the high-frequency end.
 - 10.1-5 "RF TRIMMER" Control: This control is a variable trimmer capacitor for the first r-f tuned grid circuit. In general, it is adjusted once for each band, preferably at the high-frequency end.
 - 10.1-6 "FIL. VOLTS": The filament voltmeter indicates when the power is turned "On" and should read approximately 6 volts when the equipment is operating properly.
 - 10.1-7 "AVC OFF-ON" Switch: This switch when in the "On" position, places the automatic volume control in operation; when in the "Off" position, it disconnects the automatic volume control. The automatic volume control is *not* intended for use on voice-modulated signals.

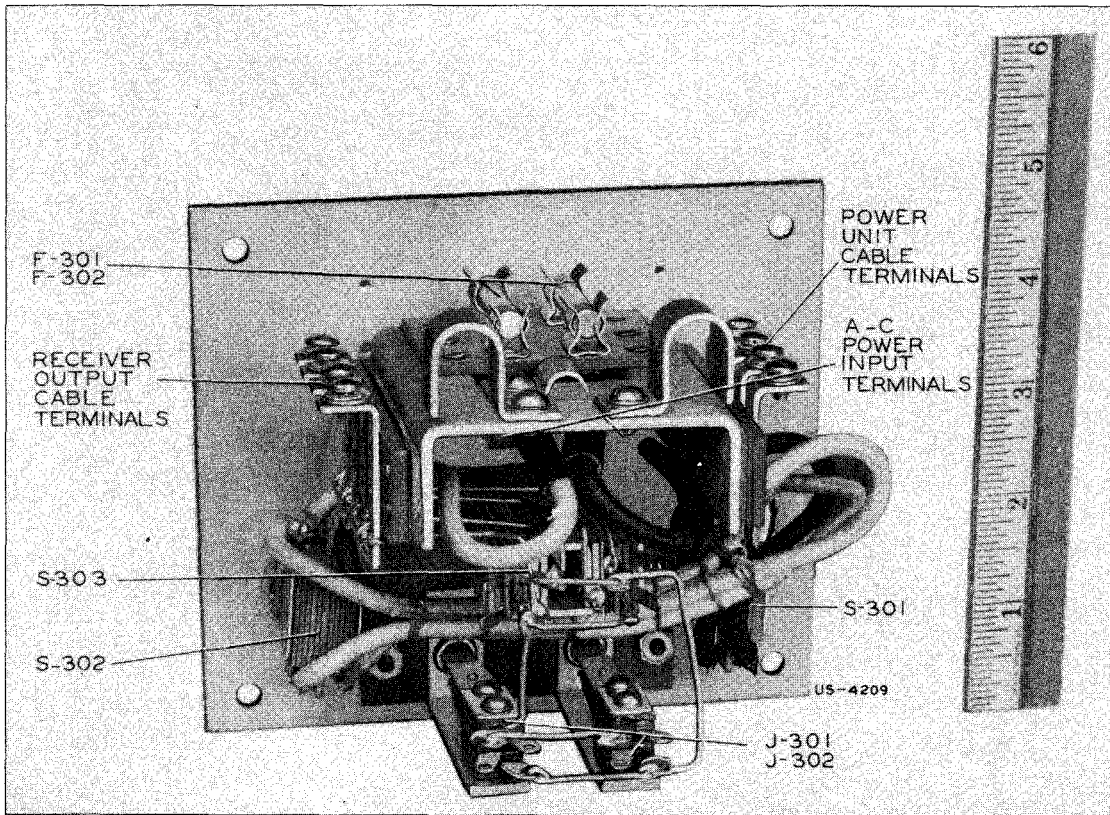

Figure 5—Control Unit CRV-23073 (Rear View of Panel)

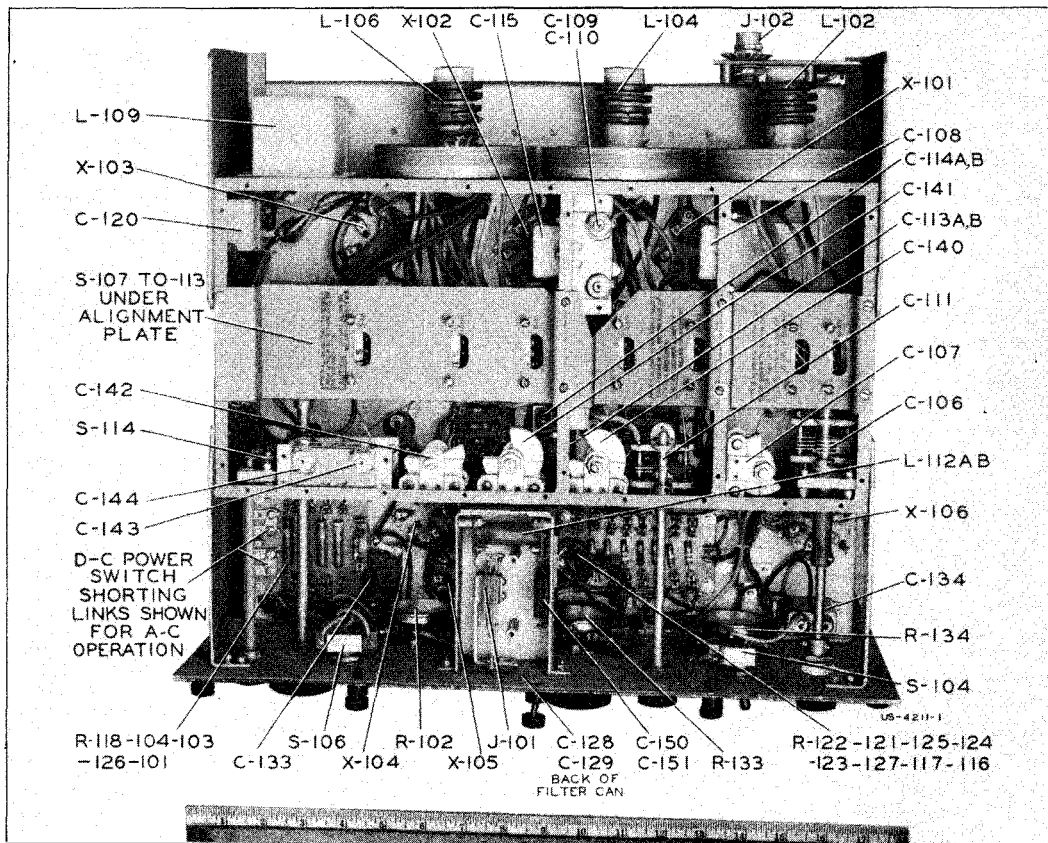

Figure 6—Receiver Unit CRV-46155 (Bottom View of Chassis—Covers Removed)

- 10.1-8 "AVC LEVEL" Control: This control varies the bias on the AVC tube and thereby sets the volume level when the "AVC Off-On" switch is in the "On" position.
- 10.1-9 "REGENERATION" Control: This control varies with the screen-grid potential of the autodyne detector thus regulating the degree of feedback required for oscillation.
- 10.1-10 "SENSITIVITY" Control: This control varies the cathode potential of the two r-f tubes with respect to their grid potentials.
- 10.1-11 "AUDIO TUNING" Control: This 10-position switch selects the proper inductance in the audio-frequency variable attenuator circuit to permit this circuit to pass frequencies in the range of 450 to 770 or 770 to 1300 cycles depending upon the position of the audio tuning range switch (see 10.1-13.) The switch positions are numbered to increase with respect to frequency.
- 10.1-12 Audio Tuning "OFF-ON": This switch places the audio-frequency variable attenuator in or out of the circuit.
- 10.1-13 Audio Tuning "450-770" or "770-1300" Switch: This switch selects the range of frequency in cycles throughout which the ten-position "Audio Tuning" control is operable.
- 10.1-14 "OUTPUT" Meter: This rectifier type a-c meter indicates the audio-frequency output level delivered to the headphones. It is calibrated in decibels above and below zero level, which is 6 milliwatts of audio output.
- 10.1-15 "ADD DECIBELS" Switch: This range switch is used to read "Add Decibels" (algebraically) in connection with the output meter. Five positions are provided: "Off," "15," "10," "5," and "0" in a clockwise direction.
- 10.1-16 "OSC. TEST" Button: This push button is connected from the detector cathode to ground. When it is depressed, it stops the detector from oscillating and produces a definite double click in the headphones. In many cases, the detector enters and leaves oscillation so gradually that it is necessary to use this button in order to determine whether or not the detector is oscillating.
- 10.1-17 "D.C. POWER OFF-ON" Switch: This switch is not used in the normal operation of this equipment and is accordingly wired out of the circuit by short-circuiting links located under the chassis (see Figure 6).
NOTE: HOWEVER, SHOULD OCCASION ARISE, THIS EQUIPMENT MAY BE OPERATED FROM A BATTERY SUPPLY CONSISTING OF SUITABLE FILAMENT AND PLATE BATTERIES. THIS METHOD OF OPERATION WILL REQUIRE OPENING OF THE SHORT-CIRCUITING LINKS (SEE FIGURES 6 AND 19) AND CONNECTION OF CABLE W-201, AS INDICATED BY THE DOTTED LINES IN FIGURE 15. OPERATION OF THE RECEIVER WILL THEN BE CONTROLLED BY THE "DC POWER" SWITCH ON THE FRONT PANEL.
- 10.1-18 "PHONES" Jack: This jack provides termination for a pair of low-impedance (600-ohm) headphones.
- 10.2 Controls of Power Unit CRV-20131.
- 10.2-1 "OFF-ON" Switch: This switch located on the front panel controls all power to the power unit, when not used in conjunction with a control unit.
- 10.2-2 Reference to Figure 15 shows that when the power unit is used in conjunction with the control unit, connection is made to the right-hand input terminals of the power unit. With this connection, the panel switch and the power unit fuses are disconnected from the circuit.
- 10.2-3 Current Regulator Switch: This switch is located under a terminal board at the right rear top of the chassis (see Figures 1, 4 and 20) and should be thrown to the "Out" position for this equipment. In this position, the proper primary connections to the transformer are made for operation without current regulation.
- 10.3 Controls of Control Unit CRV-23073.
- 10.3-1 For operation of Receiver No. 1, place the "On-Off 1" Switch in the "On" position, the "1"- "mixed"- "2" switch in the "1" position and the "On-Off 2" switch in the "Off" position. The headphones should be plugged into one of the phone jacks on the control unit.
- 10.3-2 For operation of Receiver No. 2, proceed as in 10.3-1 above except that all switches should be thrown to the "2" position.

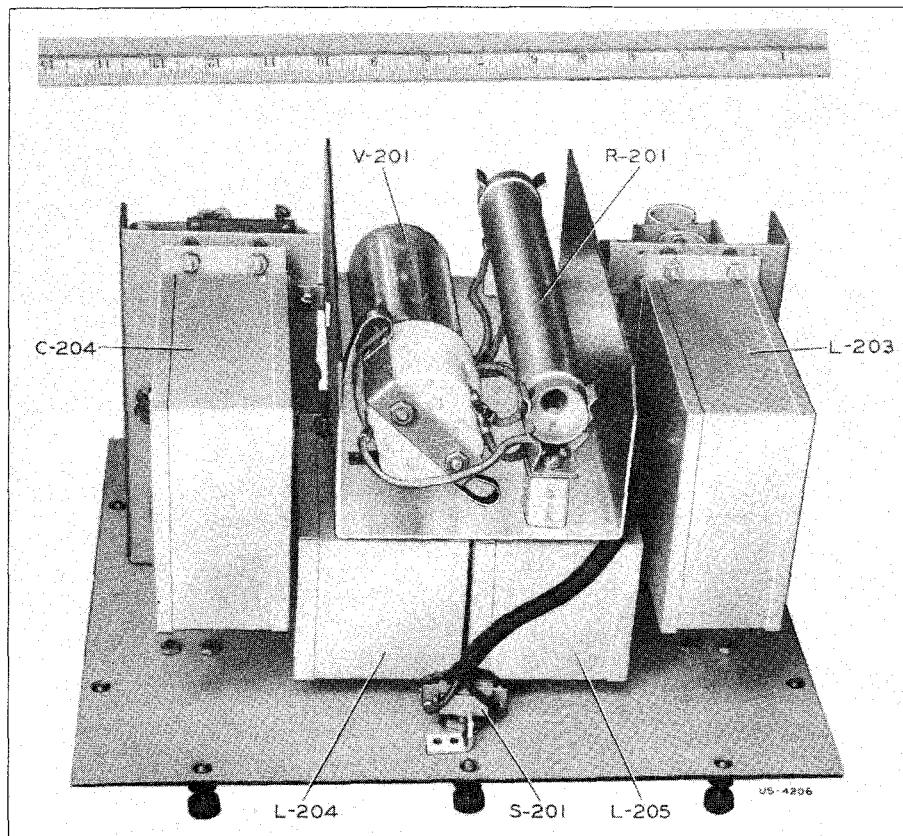

Figure 7—Power Unit CRV-20131 (Bottom View of Chassis)

10.3-3 For simultaneous monitoring of the output from two receivers, both No. 1 and No. 2 "On-Off" switches should be placed in the "On" position and the "1"- "Mixed"- "2" switch should be placed in the "mixed" position. The headphones should be plugged into one of the jacks on the control unit. (The phone jacks on the receiver units are not controlled by the "1"- "Mixed"- "2" switch.) Two phone jacks are provided to permit simultaneous monitoring or operation by two operators.

10.4 CW Reception.

10.4-1 To place power on the equipment, the proper "Off-On" switch should be thrown to the "On" position. The filament voltmeter should indicate approximately 6 volts. Allow sufficient time for the tube heaters to reach their operating temperature. This time will probably be not less than 30 seconds.

(a) When using a single RAK Series equipment, the "On-Off" switch on the power unit controls the power to the receiver.

(b) When using this equipment in combination with an RAL Series equipment, the proper "Off-On" switch on the control unit controls the power to the desired receiver.

10.4-2 To receive a signal whose frequency is known, throw the Audio Tuning and AVC "Off-On" switches to the "Off" positions.

10.4-3 Set the "Frequency Band" switch to the band number corresponding to the frequency range which includes the frequency of the station desired.

10.4-4 The "Tuning" control should be set to the desired frequency by reference to the calibration chart and the "Sensitivity" control should be advanced until a perceptible noise level is obtained. The "Antenna Trimmer" and the "RF Trimmer" should be adjusted for *maximum* noise output.

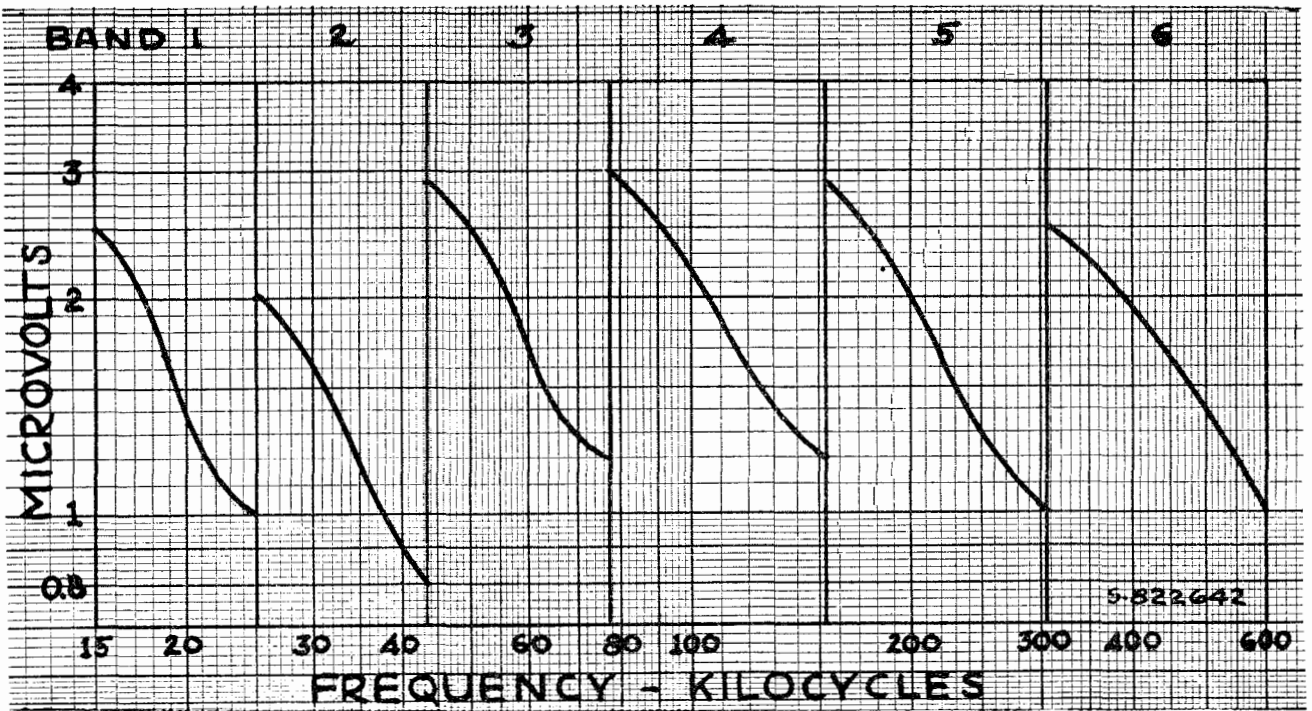

Figure 8—Sensitivity (microvolts for 6/05 M.W. Signal/Noise Ratio)

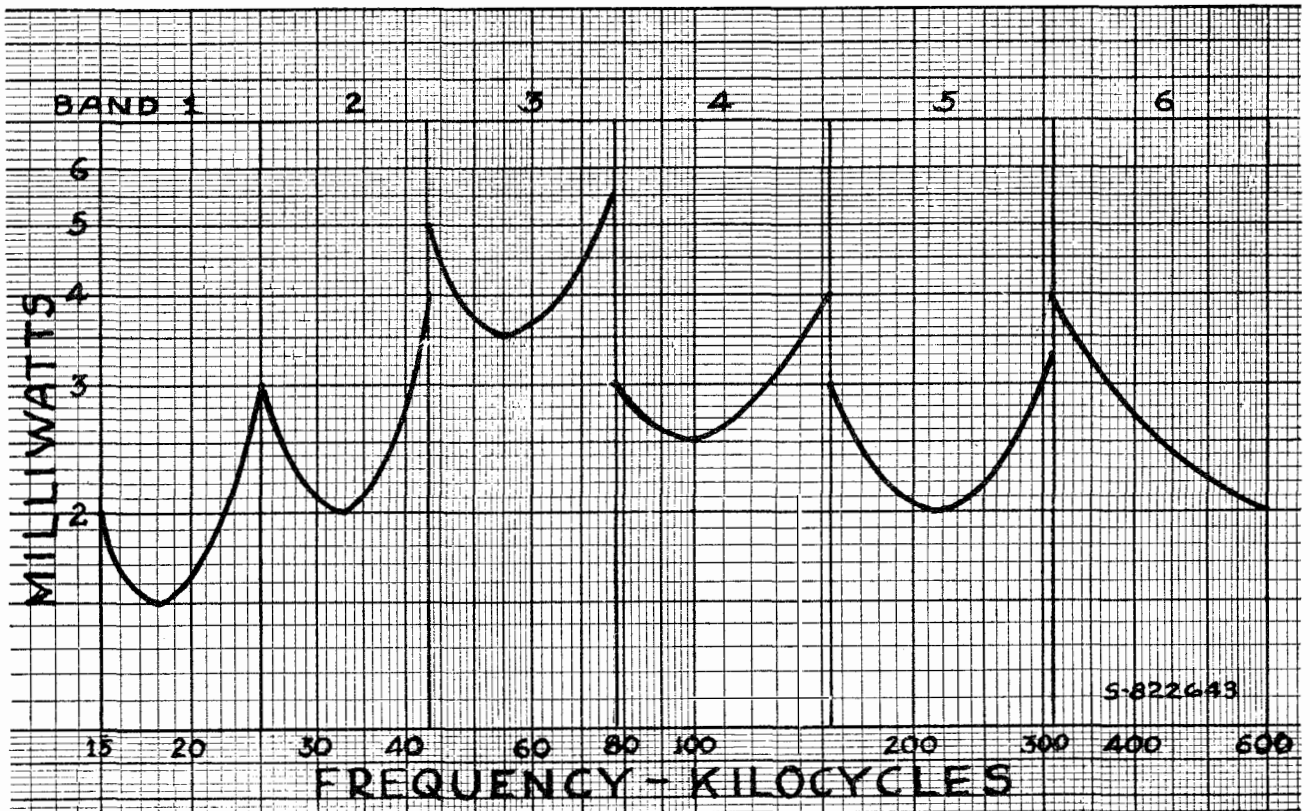

Figure 9—Maximum Noise

CAUTION: KEEP "SENSITIVITY" CONTROL RETARDED. Due to the high degree of sensitivity incorporated in the equipment, the "Sensitivity" control can only be used near maximum under ideal conditions of low external noise level. For ordinary operating conditions, it is necessary to retard the "Sensitivity" control in order to avoid **OVERLOADING THE RECEIVER WITH NOISE**, thereby masking the desired signal.

- 10.4-5 The "Regeneration" control should be set so that the detector is oscillating as evidenced by a double click heard in the headphones when the "Osc. Test" button is pressed and released.
- 10.4-6 The "Tuning" control should now be adjusted until the desired signal is heard and finally set to produce a 1000-cycle beat note as nearly as possible. The receiver should be tuned so that the beat note is obtained on the high-frequency side of zero beat. Finally, adjust the "Antenna Trimmer" and "RF Trimmer" for maximum signals.
- 10.4-7 In cases where the frequency of the signal is not known (such as when searching), excellent advantage may be taken of the uni-control feature, exercising care to keep the "Sensitivity" control to such a point as not to overload the receiver with noise.
- 10.4-8 The "AVC Level" control will maintain a substantially constant output signal level for wide fluctuation in the field intensity of the receiver signal and materially assist in copying signals through heavy static, because the static peaks are held to such a low value that the operator's attention is not distracted from copying the signals. To utilize this control, advance the "Sensitivity" control until the noise level is perceptible (not in excess of -10 db), then throw the "AVC Off-On" switch to the "On" position and adjust the "AVC Level" control until a copyable signal is obtained.
NOTE: TO USE THE "AVC LEVEL" CONTROL TO BEST ADVANTAGE, THE SIGNAL SHOULD BE HELD TO AS LOW A VALUE AS WILL PERMIT GOOD COPY.
- 10.4-9 Throwing the Audio Tuning "Off-On" switch to the "On" position will result in increased selectivity and reduced noise level permitting of improved reception. The desired signal may be tuned to produce any beat note within the range of 450 to 1300 cycles and audio tuning adjusted to produce a maximum response at this beat frequency. The following table shows an approximate calibration of the "Audio Tuning" control:

TABLE A—AUDIO TUNING

| <i>Audio Tuning Switch 450-770</i> | | | <i>Audio Tuning Switch 770-1300</i> | | |
|------------------------------------|-----------|--------|-------------------------------------|-----------|--------|
| Tap | Frequency | | Tap | Frequency | |
| 1 | 450 | cycles | 1 | 800 | cycles |
| 2 | 475 | " | 2 | 845 | " |
| 3 | 500 | " | 3 | 890 | " |
| 4 | 530 | " | 4 | 940 | " |
| 5 | 565 | " | 5 | 990 | " |
| 6 | 600 | " | 6 | 1040 | " |
| 7 | 640 | " | 7 | 1100 | " |
| 8 | 680 | " | 8 | 1160 | " |
| 9 | 725 | " | 9 | 1225 | " |
| 10 | 770 | " | 10 | 1300 | " |

0.5 ICW or Modulated Signal Reception.

- 10.5-1 The procedure is the same as outlined above with the exception that the "Regeneration" control should be maintained slightly below the setting which produces oscillation. There should not be a pronounced double click as the "Osc. Test" button is pressed and released.
- 10.5-2 Particularly on the higher frequencies, a considerable improvement in both sensitivity and selectivity results when the "Regeneration" control is set reasonably near but below the condition of oscillation.
- 10.5-3 This equipment *has not* been designed for reception of voice-modulated signals. If it is desired to receive voice-modulated signals in the range of 300 to 600 KC, these signals should be tuned in on other receiving equipment as may be available and suitable for voice reception. The low-pass filter permanently connected in the circuit does not respond to frequencies appreciably higher than 1200 cycles, which is inadequate for the proper reproduction of speech.
- 10.5-4 When receiving ICW, the "Audio Tuning" control may be used for the reception of a 450 to 1300-cycle modulated signal and the Audio Tuning "Off-On" switch should be thrown to the "Off" position except for this condition.

XI PERFORMANCE

11.1 Sensitivity.

11.1-1 Figure 8 gives approximate normal sensitivities for the various bands. The procedure and conditions of measurement are as follows: with "AVC-Off", "Audio Tuning-Off", and with a 600-ohm non-inductive resistance at receiver output terminals, pure CW is applied from a signal generator to the receiver input through a standard dummy antenna (200 mmf., 20 microhenries, 25 ohms). The output beat note is held at 1000 cycles (receiver tuned 1 kilocycle higher than signal). The "Regeneration" control is set at standard oscillation (increased beyond critical oscillation to the point where the output drops 3 db or from 2.68 V. in 600 ohms at critical oscillation to 1.9 V. at standard oscillation). The "Sensitivity" control is set for 50 microwatts (0.173 V. in 600 ohms) noise output with no signal input. The microvolts input then required to produce 6 mw. output (1.9 V. in 600 ohms) is measured.

NOTE: THE CRITICAL OSCILLATION POINT IS THAT ADJUSTMENT OF THE "REGENERATION" CONTROL PRODUCING THE MOST FEEBLE OSCILLATIONS, RESULTING IN MAXIMUM OUTPUT. THIS CONDITION IS USUALLY TOO CRITICAL TO EMPLOY AS AN OPERATING ADJUSTMENT BUT IS A REFERENCE SETTING FOR STANDARD AND MEASUREMENT COMPARISON.

11.2 Maximum Noise.

11.2-1 Figure 9 shows approximate values of maximum receiver noise level for the various bands. These data will be found useful for a rough check on sensitivity. The method of measurement is to adjust the receiver as for sensitivity (see 11.1), switch off the signal generator, increase the "Sensitivity" control to maximum and measure the output noise voltage. The measured values of noise may be expected to vary considerably due to atmospheric conditions, tube characteristics, external noise conditions, etc. so that unless the noise output is definitely low, no attempt should be made to improve performance and, in any case, the sensitivity should first be accurately checked as explained in paragraph 11.1.

11.2-2 If measuring equipment is not available, an approximate measurement may be made by adjusting the "Regeneration" control to critical oscillation and all other controls for maximum noise output. The antenna terminal should be connected to ground through a standard dummy antenna or a 200 mmfd. capacitor inside the receiver cabinet (to eliminate external noise pickup). In this case the noise output should be approximately 3 db higher than the values shown in Figure 9. (This is twice the value of milliwatts shown therein.)

11.3 Selectivity and Overload Selectivity.

11.3-1 Figure 10 shows CW selectivity characteristics for bands 1, 2, and 3. The curves correspond closely with actual conditions at the middle of the band and represent an average for the band. These data are taken by first adjusting the receiver as for sensitivity measurements (par. 11.1) with 6 mw. output at resonance. The input (CW) signal frequency is then varied and the ratios of input off resonance (required to produce 6 mw. output) to the normal (resonant) input is noted. The break in the curve denotes the point where the signal is at zero beat with the autodyne detector.

11.3-2 Figure 11 shows selectivity and overload ratios for bands 4, 5, and 6. Curves (1) show the selectivity to 100% modulated interference when the receiver is operated for CW reception. They correspond closely with actual conditions at the middle of the band and represent an average for the band. This data is taken by first adjusting the receiver as for sensitivity measurement (par. 11.1) with 6 mw. output at resonance. The signal is then modulated 30% and the frequency varied. The ratios of inputs off resonance (required to produce 6 mw. output) to the normal (resonant) input are noted and the data corrected to simulate 100% modulated interference.

11.3-3 Curves (2) of Figure 11 show the overload selectivity characteristics for bands 4, 5 and 6. The curves correspond closely with actual conditions at the middle of the band and represent an average for the band. This data is taken by first adjusting the receiver for sensitivity measurement (par. 11.1). With the resonant signal being received, a CW interfering signal is applied at various frequencies off resonance and the ratios of inputs off resonance (required to reduce the resonant signal output by 3 db) to the normal (resonant) input are noted.

11.4 Calibration.

11.4-1 Figure 12 shows average frequency calibration curves and band coverage of this equipment. Table B shows the nominal frequency range of each band.

| Band | Frequency Range (Kilocycles) |
|------|------------------------------|
| 1 | 15-25 |
| 2 | 25-43.5 |
| 3 | 43.5-77.5 |
| 4 | 77.5-153 |
| 5 | 153-308 |
| 6 | 308-600 |

XII

MAINTENANCE—TROUBLE LOCATION AND REMEDY

12.1 General.

12.1-1 This equipment has been carefully adjusted at the factory for optimum performance and is designed to maintain this adjustment for long periods of time. If any major adjustments or repairs become necessary it is recommended that such adjustments and repairs be made in a well equipped laboratory where the proper tools and measuring equipment are available. Before making any changes in receiver adjustment it should be definitely ascertained that the difficulty being experienced is not the result of external or normal deteriorating influences such as worn out vacuum tubes, improper operating voltages, blown fuses, external noises, etc.

NOTE: IN TESTING OR INSPECTING CIRCUITS IN THIS EQUIPMENT, CARE MUST BE EXERCISED NOT TO DISARRANGE R-F WIRING.

12.2 Equipment.

12.2-1 Where standard laboratory equipment is not available, the following equipment is recommended for use in locating troubles.

12.2-2 Radio Receiver Analyzing Equipment, Model OE (or equivalent), consisting of one Type CV-22193 DC Voltmeter/Milliammeter/Ohmmeter; one Type CV-22194 AC Voltmeter/Capacity Meter; one Type CV-60001 Vacuum Tube Circuit Selector Unit.

12.2-3 Calibrated Test Oscillator—frequency range 15 to 600 kilocycles.

12.3 Dead Receiver.

12.3-1 With "AVC-Off," "Audio Tuning-Off," and "Sensitivity" control at maximum, increase the "Regeneration" control setting from minimum to maximum, depressing the "Osc. Test" button at intervals. If no clicks or noises are heard in the phones on any band, the following procedure may be followed for location of trouble:

12.3-2 Check the vacuum tubes, particularly the detector tube.

12.3-3 Check the power supply (see 12.10).

12.3-4 Test the head phones and the output circuit wiring for short- or open-circuits.

12.3-5 Test the audio amplifier (see 12.11).

12.4 Weak Signals With Receiver Noise Level Normal.

12.4-1 If the receiver operates in a normal manner as indicated by the characteristic noise output (see 11.2) and no signals are in evidence, inspect the external antenna circuit.

12.4-2 Withdraw the chassis partially from the cabinet and inspect the antenna connections.

12.5 Weak Signals With Detector Failing to Oscillate on All Bands.

12.5-1 With "AVC-Off," and "Audio Tuning-Off," set the "Sensitivity" control at maximum, advance the "Regeneration" control and depress the "Osc. Test" button, noting whether the detector oscillates. If the detector fails to oscillate or oscillates with the "Regeneration" control near maximum on all bands, the following procedure should be followed:

12.5-2 Check the power supply (see 12.10).

12.5-3 Test the detector tube (see 12.13).

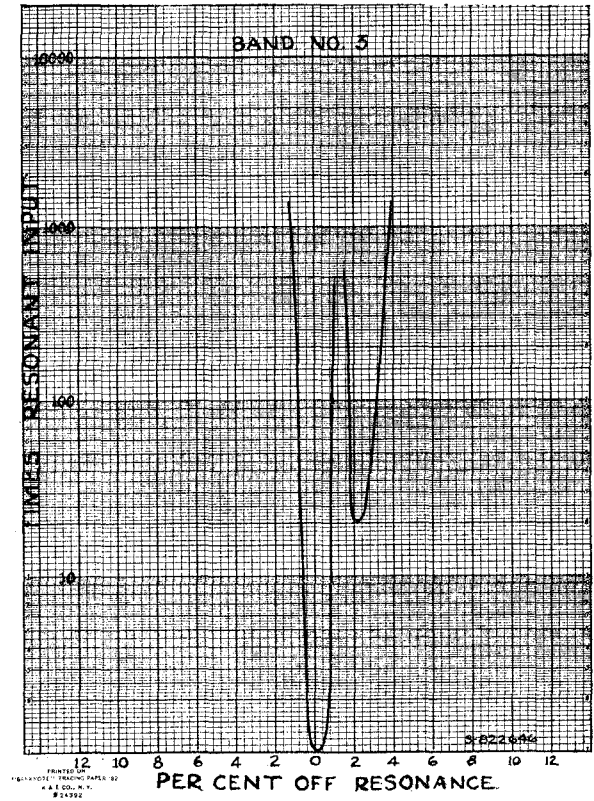
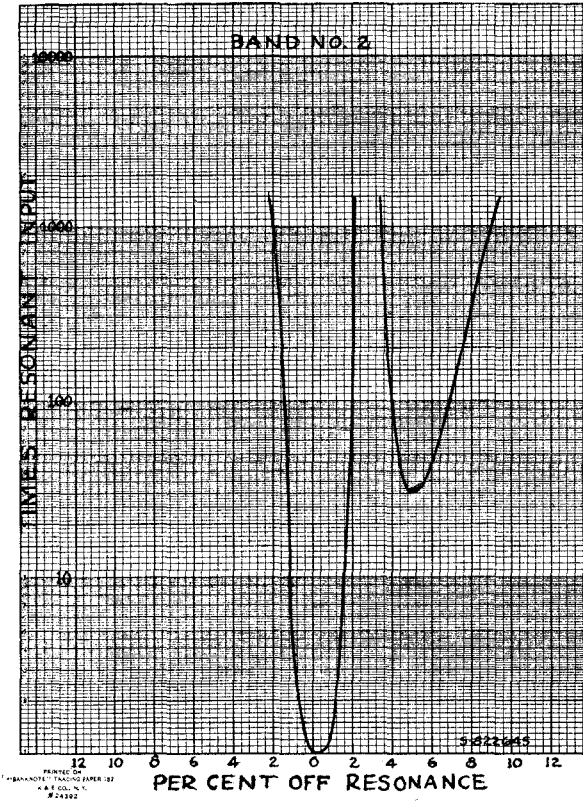
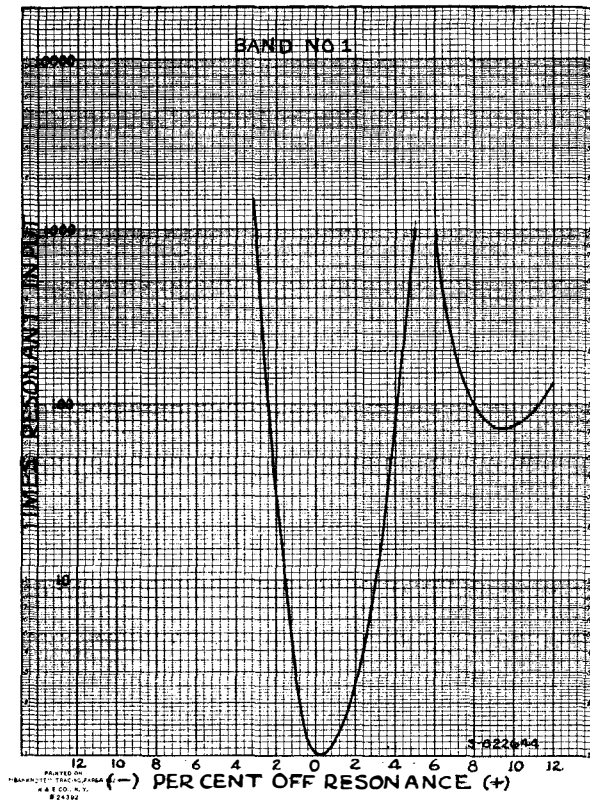

Figure 10—Average Selectivity Curve—CW Interference—Bands 1, 2 and 3

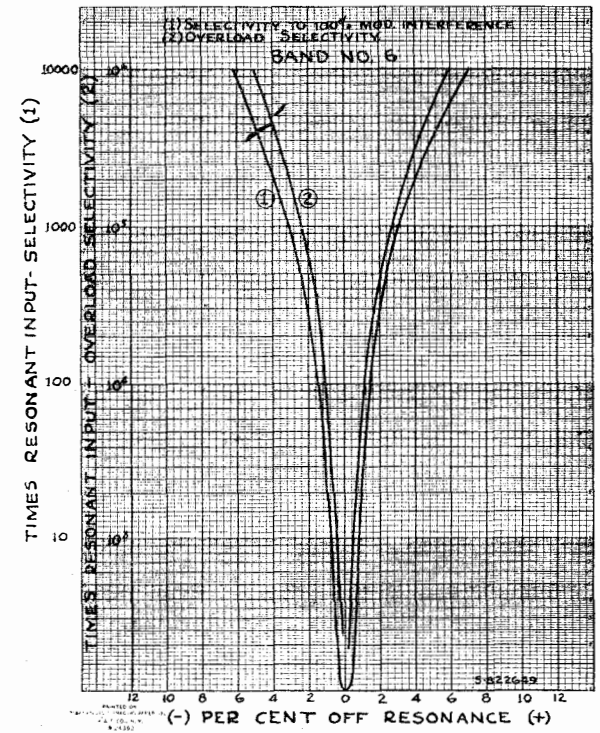
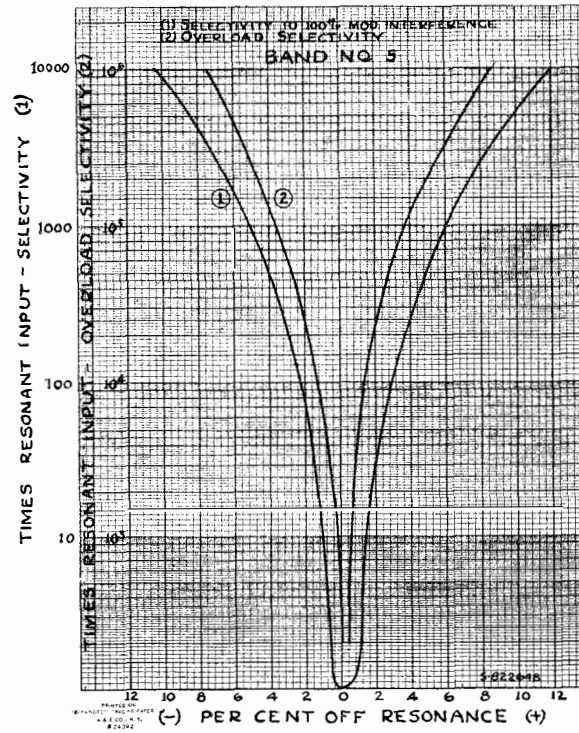
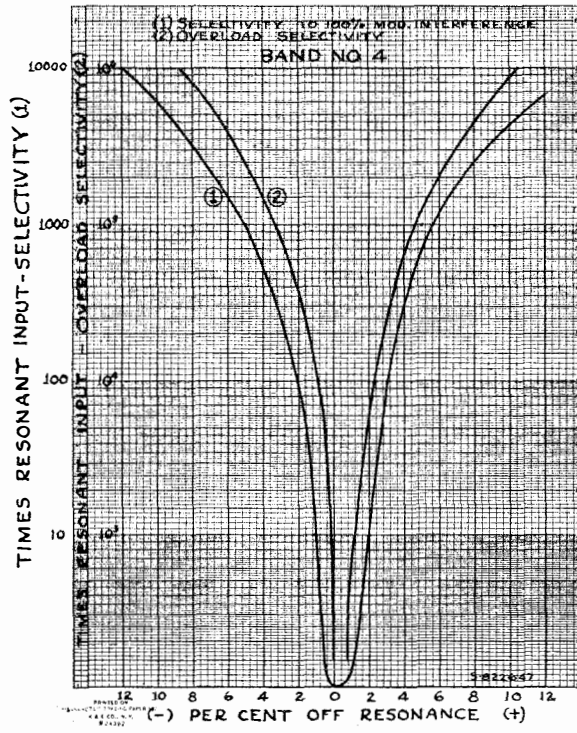

Figure 11—Average Selectivity and Overload Selectivity
 (1) Selectivity to 100% Mod. Interference; (2) Overload Selectivity

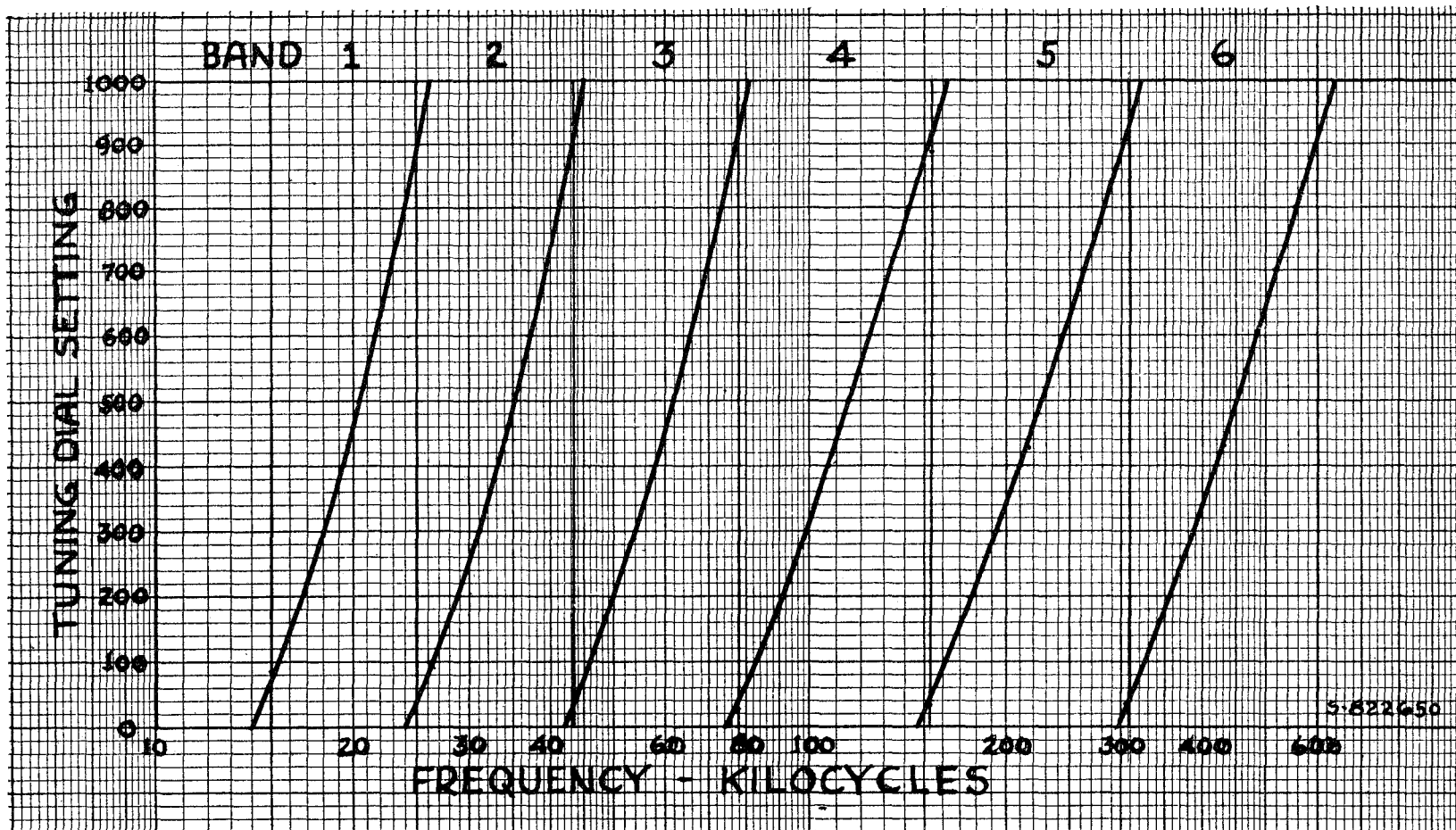

Figure 12—Average Frequency Calibration Curves

- 12.5-4 Test the detector tube socket voltages (see 12.14).
 - 12.5-5 Test the detector circuit wiring (see 12.15).
 - 12.5-6 Test the switch contacts (see 12.16).
- 12.6 Weak Signals with Detector Oscillating Normally.
- 12.6-1 Test the power supply (see 12.10).
 - 12.6-2 Test the tubes (see 12.13).
 - 12.6-3 If the power supply and the tubes are satisfactory and the receiver noise level is definitely low (see 11.2), the trouble may be located in the output circuit audio amplifier or r-f amplifier.
 - 12.6-4 Test the output circuit and the headphones for short-and open-circuits. (If one side of the output circuit is grounded, the output will be reduced.)
 - 12.6-5 Test the audio amplifier (see 12.11).
 - 12.6-6 Test the r-f amplifier (see 12.12).
- 12.7 Failure of Detector to Oscillate on Some Bands; Other Bands Normal.
- 12.7-1 If the detector oscillates normally on part of the bands, it may be assumed that the power supply and the tubes are satisfactory and that the trouble is due to faulty band switch contacts or failure in the wiring between the band switch and portion of circuits used in the inoperative bands.
 - 12.7-2 Test the r-f (plate) and detector tube socket voltages, switching the "Frequency Band" switch on and off of the inoperative bands (see 12.14).
 - 12.7-3 Test the detector circuit wiring on inoperative bands (see 12.15).
- 12.8 Weak Signals on Some Bands; Other Bands Normal—Detector Oscillating Normally on All Bands.
- 12.8-1 If normal operation is obtained on part of the bands as indicated by normal receiver noise level (see 11.2) and if the detector oscillates normally on all bands, the trouble is localized in the portion of the r-f circuits connecting to the band switch in the inoperative bands.
 - 12.8-2 Test the r-f tube socket voltages, switching the "Frequency Band" switch on and off of the inoperative bands (see 12.14).
 - 12.8-3 Test the r-f circuit wiring on inoperative bands (see 12.15).
- 12.9 Panel Trimmer Controls.
- 12.9-1 Operation of these controls may be used as an indication of proper functioning of the associated tuned circuits.
 - 12.9-2 In general, the settings for maximum response will vary for different bands and, in the case of the "Antenna Trimmer," for different antenna constants. These controls are designed to take care of normal minor variations in receiver alignment which occur over a period of time. A few divisions variation will normally occur over a given band due to slight mismatch of the inductances.
 - 12.9-3 Failure of these controls to resonate the circuits as indicated by maximum response on a signal (with 1000-cycle beat note; receiver tuned 1 kilocycle higher than signal) on all bands indicates a defect in the respective circuit. Test the associated tube (see 12.13), tube socket voltages (see 12.14), and circuit continuity (see 12.15).
 - 12.9-4 Failure of these controls to resonate the circuits on a particular band (other bands operating normally) indicates defects in the portion of the respective circuits connecting to the band switch on the particular band. Test the tube socket voltages (see 12.14), switching the "Frequency Band" switch on and off of the inoperative band. If the voltages and circuit continuity are correct, the receiver alignment should be investigated (see 12.17).
 - 12.9-5 An abnormally large change in either trimmer setting over a given band or failure to resonate at only one end of a band indicates that the tuning capacitor section or the inductance used in the particular circuit and band has been damaged. If both

trimmer settings change in the same direction over a band, this may indicate that the detector tuning capacitor or inductance is at fault. (Refer to 12.17).

12.10 Power Supply.

- 12.10-1 If trouble is traced to the power supply, the following procedure may be followed:
- 12.10-2 Note the receiver panel voltmeter reading. This meter should read approximately 6 V. for normal operation and indicates the filament voltage which is obtained from a winding on the power transformer in the power unit. This also indicates that power is being supplied to the power unit and thus serves as a "power on" indicator.
- 12.10-3 If no voltage is indicated (assuming that the meter is not defective), test the a-c line voltage and fuses in the a-c line, control unit and power unit. Refer to Figure 15.
- 12.10-4 Partially remove the receiver from the cabinet and check the voltage at the power terminal board. Refer to Figure 15. The terminals are numbered from 1 to 9, No. 1 being nearest the panel. These voltages should measure approximately as follows:

TABLE C—RECEIVER TERMINAL VOLTAGES

| <i>Terminal</i> | <i>Voltage</i> |
|-----------------|----------------|
| 1 or 9 to 6 | 180 V. D.C. |
| 1 or 9 to 5 | 90 V. D.C. |
| 2 to 3 | 6 V. A.C. |

- 12.10-5 If voltages fail to check, test the a-c power supply voltage. Partially remove the power unit from its case and measure the power unit terminal voltages. Refer to Figure 15. The power unit terminals are numbered from 1 to 6, No. 1 being nearest the panel. These voltages should measure approximately as follows:

TABLE D

POWER UNIT TERMINAL VOLTAGES

| <i>Terminal</i> | <i>Voltage</i> |
|-----------------|----------------|
| 1 to 5 | 180 V. D.C. |
| 1 to 4 | 90 V. D.C. |
| 2 to 3 | 6.3 V. A.C. |

- 12.10-6 If the above voltages fail to check and the line input voltage and fuses are operative, test the power unit tubes (see 12.13).
 - 12.10-7 Test the power unit circuits for continuity (see 12.15).
- #### 12.11 Audio Amplifier.
- 12.11-1 To determine if the audio amplifier is operating, partially withdraw the receiver from the cabinet and touch the grids of the detector and first a-f tubes. Pronounced clicks should be heard in the phones.
 - 12.11-2 If the above test indicates a defect in the amplifier circuit with satisfactory power supply (see 12.10) and output circuit connections (see 12.3-3), the audio tubes should be checked (see 12.13) and the audio circuits tested (see 12.15).
 - 12.11-3 If in the test of 12.11-1, a pronounced click is obtained when the first audio grid is touched, but touching the detector grid gives no indication, the trouble is located in the portion of the circuit between these two points.
 - 12.11-4 If measuring equipment is available, the audio gain may be checked by application of 1000 cycles input to the first audio grid. The input required for zero level (6 milliwatts) output should be approximately 0.04 volt.

12.12 R-F Amplifier.

- 12.12-1 A defective r-f amplifier may be detected by abnormal operation of the trimmer controls (see 12.9), "Sensitivity" control, or by first ascertaining that the remainder of the circuit is operative.

- 12.12-2 With the "Sensitivity" control at minimum, a barely audible hum should be noted and it should be possible to hear the detector go into oscillation if the "Regeneration" control is advanced rapidly. With the detector oscillating, the characteristic double click should be heard when the "Osc. Test" button is depressed. Further tests indicating normal operation of detector output and audio amplifier circuits are noted under 12.11.
- 12.12-3 If a fault is located in the r-f amplifier by the above methods with normal power supply (see 12.10) and antenna connections (see 12.4-2), it should be determined whether the trouble exists on all bands or on only one or more particular bands.
- 12.12-4 If the trimmer operation is not normal, refer to paragraph 12.9.
- 12.12-5 If the trimmer operation is normal and low sensitivity is indicated by the tests outlined in paragraph 11.1 is obtained on all bands, test the r-f amplifier tubes (see 12.13), socket voltages (see 12.14) and circuit continuity (see 12.15).
- 12.12-6 If trouble is located on a particular band or bands with other bands operating normally, check the socket voltages (see 12.14) and circuit continuity (see 12.15), switching the "Frequency Band" switch on and off the inoperative band. Check the "Frequency Band" switch (see 12.16).
- 12.12-7 Before making extensive circuit tests, an attempt should be made to localize the trouble in the first or second amplifier stage. This may be done by applying input from a test oscillator to the respective grids.

12.13 Tube Characteristics.

- 12.13-1 If trouble is traced to tubes in a portion of the circuit, the trouble may be quickly checked by replacing the doubtful tube with a tube of known characteristics and rechecking the performance of the equipment.
- 12.13-2 Tubes may be tested for open heaters or shorts between elements by use of a continuity meter or click test with the precaution that the rated heater voltage is not exceeded.
- 12.13-3 Tubes will be found to deteriorate gradually with use, resulting in a gradual reduction in performance of the equipment. It is therefore advisable to replace tubes after 1000 hours of service or to measure them at regular intervals to determine if the limit of serviceability has been reached. Table E gives standard characteristics for the tubes used in this equipment and low limits of "emission" and "transconductance." Test of "emission" is usually sufficient to indicate the condition of a tube, but a better correlation between test results and actual conditions is obtained by measurement of "transconductance." Actual operating voltages on the tubes as used in this equipment are appreciably lower than the ratings shown in the table, so that extended tube life is assured.

TABLE E—TUBE CHARACTERISTICS

| Tube Type | Fil. Volts | Fil. Current (Amps.) | Plate Volts | Screen Volts | Grid Bias Volts | Plate Current (MA.) | *Emission Current (MA.) | Screen Current (MA.) | AC Plate Resistance (Ohms) | Ampl. Factor | Average Transcond. (Micromhos) |
|-----------|---|----------------------|-------------|--------------|-----------------|---------------------|-------------------------|---------------------------|----------------------------|--------------|--------------------------------|
| -6D6 | 6.3 | 0.3 | 250 | 100 | -3 | 8.2 | 100 | 2.0 | 800,000 | 1280 | 1600 |
| -41 | 6.3 | 0.4 | 250 | 250 | -18 | 32 | 200 | 5.5 | 68,000 | 150 | 2200 |
| -874 | .. | .. | 90 | .. | .. | 30 | .. | (striking voltage 125 V.) | | | |
| -876 | 50.0 | 1.7 | .. | .. | .. | .. | .. | .. | | | |
| -5Z3 | 5.0 | 3.0 | .. | .. | .. | .. | 240 | .. | | | |
| -5Z3 | (AC voltage per plate 500 RMS—Max. DC Output Current 250 MA.) | | | | | | | | | | |

| Tube Type | Low Limits | |
|-----------|-----------------|------------------------------|
| | *Emission (MA.) | Transconductance (Micromhos) |
| -6D6 | 50 | 1200 |
| -41 | 70 | 1300 |
| -876 | .. | |
| -874 | .. | |
| -5Z3 | 190 | |

* For "emission" tests, all grids are connected to the plate and are 50 volts positive with respect to the cathode (or filament), except the Type -5Z3 tube on which a potential of 40 volts is used with both plates connected together.

- 12.13-4 Measurement of "emission" and "transconductance" is not always an absolute indication of the condition of tubes for their various applications, particularly in the case of detector and AVC tubes. An unsatisfactory detector tube is best indicated by its oscillating properties. A tube which does not function properly in the detector stage

may often be used in an amplifier stage without loss in performance. A low output tube may often be utilized in the AVC position.

12.14 Tube Socket Voltages.

12.14-1 Measurement of socket voltages may be used as a check on power supply and receiver circuit connections.

12.14-2 The following table gives average tube socket voltages for this equipment. These are not operating voltages and will vary considerably with different types of voltmeters. The values stated below apply for the Model OE Radio Receiver Analyzing Equipment.

TABLE F—TUBE SOCKET VOLTAGES

Due to the change in load when one tube is removed, the voltages measured at the tube sockets are somewhat higher than the corresponding voltages of Tables C and D.

| Tube Type | Function | Plate | Screen | Supp. | Cath. | Grid | Heater |
|-----------|----------|-------|--------|-------|-------|------|--------|
| -6D6 | 1st RF | 190 | 94 | 5 | 5 | 0 | 6 |
| -6D6 | 2nd RF | 180 | 94 | 5 | 5 | 0 | 6 |
| -6D6 | Detector | 170 | 45 | 0 | 0 | 0 | 6 |
| -6D6 | Audio | 190 | 180 | 0 | 0 | 0 | 6 |
| -41 | Output | 200 | 200 | ∴ | 0 | 0 | 6 |
| -41 | AVC | 0 | 0 | ∴ | 190 | 0 | 6 |

In making the above measurements, the receiver should be operated at normal supply voltage and allowed to warm up for approximately 10 minutes before taking readings. Readings are taken by removing one tube at a time and measuring voltages between the socket terminals and ground. Set "Frequency Band" switch on "6," "Tuning—1000," "Audio Tuning—Off," "AVC-Off," "Sensitivity—10" and "AVC Level—10," Figure 22 shows socket terminal arrangements.

TABLE G—TUBE OPERATING VOLTAGES AND CURRENTS

| Tube | Function | Plate | Plate | Screen | Screen | Cathode | Supp. | Heater | Note | |
|------|-----------|-----------------------------------|---------|--------|---------|---------|--------|----------|----------|--|
| | | E | MA. | E | MA. | E | E | E | | |
| -6D6 | 1st RF | 150 | 3.0 | 70 | 0.7 | 3.5-45 | 3.5-45 | 5.6 (AC) | 1 | |
| -6D6 | 2nd RF | 105 | 3.5 | 73 | 0.8 | 3.0-45 | 3.0-45 | 5.6 (AC) | 1 | |
| -6D6 | Detector | 20-140 | 0.0-1.0 | 0-40 | 0.0-0.3 | 0 | 0 | 5.6 (AC) | 2 | |
| -6D6 | Audio | 25 | 1.3 | 35 | 0.35 | 1.6 | 1.6 | 5.6 (AC) | | |
| -41 | Output | 110 | 11.0 | 120 | 1.7 | 7.8 | — | 5.6 (AC) | | |
| -41 | AVC | 0 | 0 | 0 | 0 | 175 | — | 5.6 (AC) | 3 | |
| -5Z3 | Rectifier | 230 AC— from each plate to ground | | | | | | | 4.8 (AC) | |

The above are average operating voltage and current values as obtained by measurement with a Model OE Radio Receiver Analyzing Equipment. Readings were taken under the following test conditions: Receiving Equipment in normal operative condition, antenna disconnected, line voltage 115, current-regulator tube out, "AVC-Off," "Sensitivity" control on 10 (see Note 1), "Regeneration" control on 5 (see Note 2), "Frequency Band" switch on "1", and "Tuning" control on 0-0. DC voltages measured to heater (ground).

Note 1. Cathode to heater voltage varies with position of "Sensitivity" control. Average limits are shown.

Note 2. Detector voltages and currents vary with position of "Regeneration" control. Average limits are shown.

Note 3. Cathode to heater voltage measured with "AVC Level" control at maximum.

For the above measurements with Model OE Radio Receiver Analyzing Equipment, the lowest possible voltmeter scale should be used, as follows:

| Voltages | Meter | Resistance | Voltages | Meter | Resistance |
|----------|-------|------------|----------|-------|------------|
| 0/1 | 0/1 | 20,000 | 10/25 | 0/25 | 500,000 |
| 1/2.5 | 0/2.5 | 50,000 | 25/50 | 0/50 | 1,000,000 |
| 2.5/5 | 0/5 | 100,000 | 50/100 | 0/100 | 2,000,000 |
| 5/10 | 0/10 | 200,000 | 100/250 | 0/250 | 5,000,000 |

12.14-3 If trouble exists on a particular band, the tube socket voltages should be measured on both the inoperative band and on an operative band to indicate which portion of the circuit is at fault.

12.14-4 If a source of trouble is localized in a particular portion of the circuit by the above analysis, this portion of the circuit should be tested for continuity and inspected (see 12.15).

12.15 Circuit Continuity.

12.15-1 After tracing a fault to a particular portion of the circuit by the foregoing tests, the circuit should be systematically inspected, tested for continuity, short circuits, ground or failure of component parts, with power off. Refer to following drawings:

| <i>Diagram</i> | <i>Figure</i> |
|-------------------------------|---------------|
| Receiver Unit Schematic..... | 16 |
| Receiver Unit Connection..... | 19 |
| Power Unit Schematic..... | 17 |
| Power Unit Connection..... | 20 |

12.15-2 If an ohmmeter is available, point-to-point resistance measurements will be useful in locating faults. The following tables indicate the approximate resistances in this equipment.

TABLE H—RECEIVER UNIT POINT-TO-POINT RESISTANCES

| <i>Points</i> | <i>Resistance</i> | <i>Condition</i> |
|-------------------------|-----------------------------------|----------------------|
| Terminal No. 6 to | 1st RF plate..... 10,500 ohms | |
| “ “ | 2nd RF plate..... 20,500 ohms | |
| “ “ | Detector plate..... 120,000 ohms | |
| “ “ | Audio plate..... 120,000 ohms | |
| “ “ | Output plate..... 5,125 ohms | “AVC-Off” |
| “ “ | Output plate..... 4,800 ohms | “AVC-On” |
| Terminal No. 6 to | AVC cathode..... 0 ohms | “AVC Level — 10” |
| “ “ | AVC cathode..... 9,200 ohms | “AVC Level — 0” |
| “ “ | 1st RF screen..... 20,000 ohms | |
| “ “ | 2nd RF screen..... 20,000 ohms | |
| “ “ | 1st AF screen..... 390,000 ohms | |
| “ “ | Ground..... 9,200 ohms | |
| Terminal No. 5 to | Detector screen..... 28,800 ohms | “Regeneration — 10” |
| Ground to | Detector screen..... 10,000 ohms | “Regeneration — 0” |
| “ “ | 1st RF grid..... 230 ohms | “Frequency Band — 1” |
| “ “ | 2nd RF grid..... 4.7 megohms | |
| “ “ | Detector grid..... 4.7 megohms | |
| “ “ | Audio grid..... 1.1 megohms | |
| “ “ | Output grid..... 1.0 megohms | |
| “ “ | AVC-screen-grid plate. 3,500 ohms | |
| Terminal No. 7 to No. 8 | 40 ohms | “Add Decibels-Off” |
| Ground to No. 7 | 20 ohms | “Add Decibels-Off” |
| “ “ “ 8 | 20 ohms | “Add Decibels-Off” |

The above values apply for receiver unit alone—external cables disconnected, all tubes out of sockets and receiver set on “Frequency Band—1,” and “Tuning—0.”

12.15-3 Power unit point-to-point resistances are approximately as noted in the following table:

**TABLE I
POWER UNIT POINT-TO-POINT RESISTANCES**

| <i>Points</i> | <i>Resistance</i> | <i>Condition</i> |
|------------------------------------|-------------------|-----------------------|
| Terminal No. 2 to No. 3..... | 1.0 ohms | |
| Terminal No. 1 to No. 5..... | 20,000 ohms | |
| Terminal No. 1 to No. 4..... | 23,000 ohms | |
| -5Z3 socket (fil. to fil.) | 0.15 ohms | |
| -5Z3 socket (plate to plate) | 250 ohms | |
| R-H power line terminals..... | Infinite | “On-Off” Switch—“Off” |
| R-H power line terminals..... | 7.0 ohms | “On-Off” Switch—“On” |
| Power terminal to ground..... | Infinite | |

Above values apply for the power unit alone (external cables and wiring disconnected) with all tubes in sockets and with current-regulator tube out (the condition of operation of the power unit with this equipment).

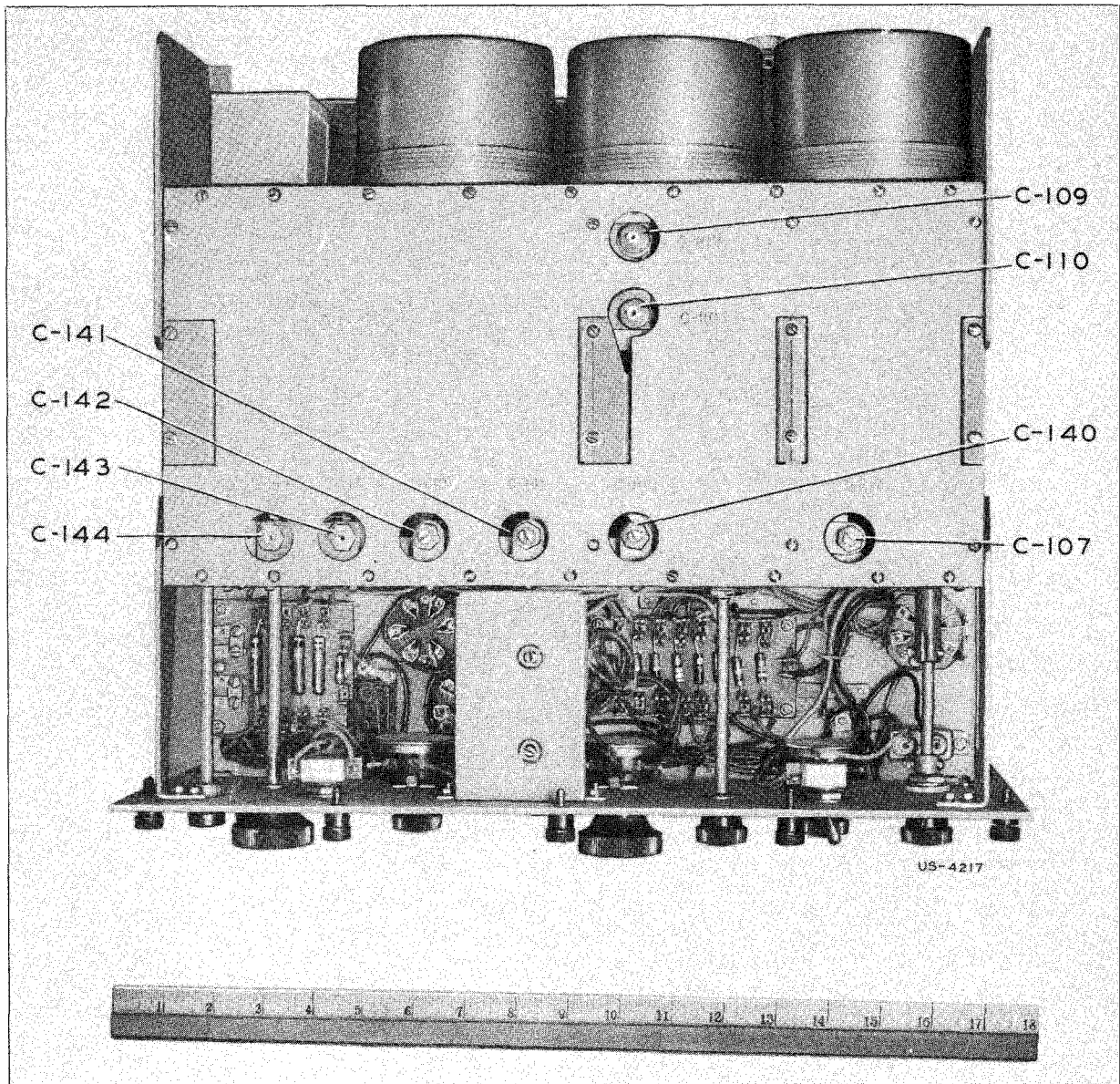

Figure 13—Receiver Unit CRV-46155 (Bottom View of Chassis)

12.15-4 Component parts may be identified by cross reference from the item numbers in Figures 16 and 17.

12.16 "Frequency Band" Switch.

12.16-1 To inspect the "Frequency Band" switch and circuit connections, the large plate on the bottom of the chassis may be removed. This switch has been carefully aligned at the factory, the four contacts on each section being accurately adjusted for equalized pressure and maximum contact area. Readjustments of the switch should rarely be found necessary.

IF ANY MAJOR REPAIRS ON THE SWITCH ASSEMBLY ARE FOUND NECESSARY, SUCH REPAIRS SHOULD BE MADE IN A WELL EQUIPPED LABORATORY SINCE SERIOUS MECHANICAL MISALIGNMENT OF THE CONTACTS OR MISALIGNMENT OF HIGH-FREQUENCY INDUCTANCES DUE TO DERANGEMENT OF R-F WIRING MAY RESULT.

In order to readjust or replace switch parts and for access to switch wiring, it will be necessary to remove the switch retaining brackets mounted inside the switch compartments at the bottom of the chassis. After removal of the large plate on the bottom of the chassis, the switch retaining bracket for a particular compartment may be removed without removing the brackets for other compartments. The brackets are mounted by means of screws at the partition shields.

When the switch retaining bracket is replaced, the switch stator sections must be first accurately positioned so that the movable contacts exactly center on the fixed contacts when the switch is set to positions determined by the detent. The retaining bracket is then mounted in position with the adjusting screws backed off. Finally, the adjusting screws must be screwed in to just touch the stators, then backed off to leave a very slight clearance (approximately .005 in.), then locked by means of the lock nuts. UNDER NO CONDITION SHOULD SCREWS EXERT FORCE AGAINST THE STATORS AS THIS WILL CAUSE BENDING WITH CONSEQUENT BINDING OF THE SWITCH SHAFT.

CAUTION: DO NOT ALIGN BY MEANS OF SCREWS.

- 12.16-2 Switch contacts may be tested by pressing the movable contact down on its fixed contact with a tool of insulating material. Associated circuits should be checked for loose contacts before disturbing the switch assembly.
- 12.16-3 The switch is self-cleaning and should wipe itself clean if rotated back and forth over the questionable contact several times. Should further cleaning become necessary, the rotating member may be pressed down against the fixed member far enough to permit disengaging the "C" washer from its slot in the rotating hub at the back of the fixed member. If the "C" washer is removed, the rotating member may be slid along the shaft away from the fixed member permitting access to the contacts. Care must be taken not to compress the springs farther than necessary or they will require readjustment.
- 12.16-4 Should necessity of replacing a switch section arise, the switch shaft must be removed, the switch section connections unsoldered at the switch plate, the new section inserted, connections soldered, and switch shaft replaced. Receiver alignment should then be checked (see 12.17). To remove switch shaft, remove taper pin fastening the bevel gear to the switch shaft. Remove the bearing bushing at the end of the shaft opposite the drive and slide the shaft out, taking care that none of the switch sections are binding on the shaft. When replacing the shaft, see that the bevel gears are properly meshed to provide alignment between switch position and position indicated by the panel control before pinning.

12.17 Receiver Alignment.

- 12.17-1 Receiver alignment may be readily checked by observing operation of the panel trimmers (see paragraph 12.9 and Figure 6). These trimmers should resonate the respective tuned circuits (with 1000-cycle beat note output; receiver tuned 1 kilocycle higher than the signal) over the complete range. For accurate alignment check, the receiver must be adjusted as for sensitivity measurements (see 11.1). This adjustment may be approximated with sufficient accuracy for most purposes by setting the "Sensitivity" control at "9" and the "Regeneration" control at approximately $\frac{1}{2}$ division above critical oscillation. The beat note may be set at approximately 1000 cycles by switching the Audio Tuning "On," using the "770-1300" range (tap 5), and tuning for maximum output.
- 12.17-2 Bands 4, 5 and 6: With receiver adjustments as noted above, set "Tuning—905," "Frequency Band—6," apply a 600-kc signal from test oscillator of such strength as to produce approximately 6 mw. output and adjust trimmer C-141 to produce 1000-cycle beat note (receiver 1 kilocycle higher than signal). Adjust trimmer C-140 to bring the panel "RF Trimmer" settings for the high-frequency ends of Bands 4, 5 and 6 as near zero as possible. Adjust trimmer C-107 to bring panel "Antenna Trimmer" settings for the high-frequency ends of Bands 4, 5 and 6 as near "-10" as possible, but not exceeding the limits "-7" to "-20" ("-50" being the minimum capacity setting).
- 12.17-3 Band 3: With "Tuning—906.5," apply 77.5 kc input. Adjust detector trimmer C-142 to produce 1000-cycle beat note (receiver 1 kilocycle higher than signal). With the panel "RF Trimmer" set at zero, adjust r-f trimmer C-110 for maximum response.

- 12.17-4 Band 2: With "Tuning—915" apply 43.5 kc input. Adjust detector trimmer C-143 to produce 1000-cycle beat note (receiver 1 kilocycle higher than signal). Adjust r-f trimmer C-109 to bring the panel "RF Trimmer" settings at the high-frequency ends of Bands 1 and 2 as near zero as possible.
- 12.17-5 Band 1: With "Tuning—891" apply 25 kc input. Adjust detector trimmer C-144 to produce 1000-cycle beat note (receiver 1 kilocycle higher than signal).
- 12.17-6 The following table gives nominal frequencies and approximate dial settings which should be used in aligning the receiver.

TABLE J
ALIGNING FREQUENCIES

| <i>Band</i> | <i>Nominal Frequency (KC)</i> | <i>Dial Setting (Approx.)</i> |
|-------------|-------------------------------|-------------------------------|
| 1 | 15 -25 | 89-891 |
| 2 | 25 -43.5 | 55-915 |
| 3 | 43.5-77.5 | 49-906.5 |
| 4 | 77.5-153 | 40-915 |
| 5 | 153 -307 | 49-925.5 |
| 6 | 307 -600 | 45-905 |

- 12.17-7 As noted in paragraph 12.9-5, an abnormal change in either trimmer setting over a given band or failure to resonate at one end of a band indicates that the tuning capacitor section or the inductance used in the particular circuit and band has been damaged. If both trimmer settings change in the same direction over a band, this may indicate that the detector tuning capacitor or inductance is at fault.

UNLESS THESE CONDITIONS SERIOUSLY IMPAIR OPERATION, NO ATTEMPT SHOULD BE MADE TO REPAIR INDUCTANCE OR TUNING CAPACITOR ALIGNMENT OR REPLACE COILS. THESE OPERATIONS SHOULD VERY RARELY BECOME NECESSARY AND SHOULD BE DONE ONLY IN A WELL EQUIPPED LABORATORY.

12.18 Lubrication.

- 12.18-1 Mechanical moving parts such as the tuning capacitor drive mechanism, band switch drive mechanism, and bearings should be periodically inspected and, if necessary, lightly greased with a non-fluid mineral oil or light grease such as grade A of Navy Department specification 14G 1. Lubrication of electrical contacting surfaces is not advisable unless tendency for cutting appears; when required, a light grease such as vaseline should be used very sparingly, all surplus grease being removed.

12.19 Cleaning.

- 12.19-1 ABRASIVE SUBSTANCES SUCH AS EMERY CLOTH, STEEL WOOL, ETC., SHOULD NEVER BE USED FOR CLEANING IN OR NEAR ANY PART OF THIS EQUIPMENT.

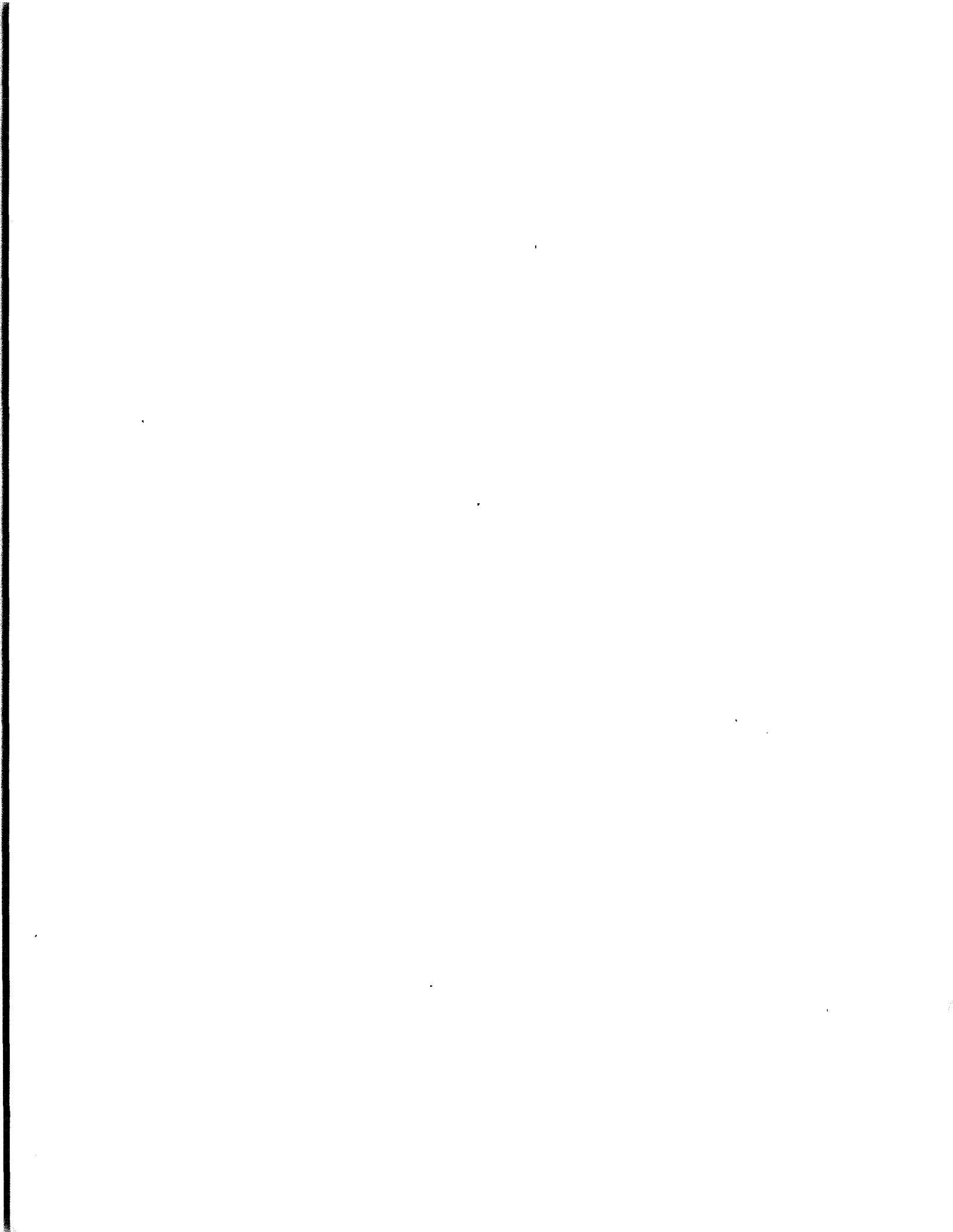

TABLE I
LIST OF MAJOR UNITS
FOR MODEL RAK-7 RADIO RECEIVING EQUIPMENT

| QUAN- TITY | SYMBOL GROUP | NAVY TYPE DESIGNATION | NAME OF MAJOR UNIT | ASSEMBLY DRAWING NUMBER |
|---------------|--------------|--------------------------|--------------------|----------------------------|
| 1 | 101-199 | CRV-46155 | RECEIVER UNIT | |
| 1 | 201-299 | CRV-20131 | POWER UNIT | |
| 1 | 301-399 | CRV-23073 | CONTROL UNIT | |

100

100

100

100

100

100

TABLE II
PARTS LIST BY SYMBOL DESIGNATION
FOR MODEL RAK-7 RADIO RECEIVING EQUIPMENT

| SYMBOL DESIG. | FUNCTION | DESCRIPTION | NAVY TYPE NUMBER | NAVY DRAWING OR SPEC. | MFR. | MFR. DESIG. | SPECIAL TOLER- ANCE, RATING OR MODIFICATION | RCA DRAWING NUMBER |
|------------------|---|--|---------------------|--------------------------|---------|--------------|---|--------------------------|
| CAPACITORS | | | | | | | | |
| *C-101 | Antenna Series Capacitor Used with "COMMON" Antenna Connection | Fixed, molded, mica, 300 mmfd $\pm 10\%$, 500 v d.c. working, phenolic case | -48558 | RE 48A 154 | 2 34 | 1468S MOW | For Replace- ment Use CM20 400-K | P-720592-35 |
| *C-102 | Antenna Coupling Capacitor on Band 2 | Fixed, molded, mica, 1190 mmfd $\pm 5\%$, 500 v d.c. working | -48572 | | 1 | Model H | | M-86016-507 |
| *C-103 | Antenna Coupling Capacitor on Band 1 | Fixed, molded, mica, 805 mmfd $\pm 5\%$, 500 v d.c. working | -48568 | | 1 | Model H | | M-86016-503 |
| *C-104 | Antenna Coupling Capacitor on Band 3 | Fixed, molded, mica, 62 mmfd $\pm 5\%$, 500 v d.c. working | -48569 | | 1 | Model H | | M-86016-504 |
| C-105A | Main Tuning Capacitor on 1st R-F Stage | Variable, air, 3 gang; 26.3 ± 1 to 467 ± 14 mmfd per section | | | 19 | | | T-601410-1 |
| B | Main Tuning Capacitor on 2nd R-F Stage | | | | | | | |
| C | Main Tuning Capacitor on Detector Stage | | | | | | | |
| C-106 | "ANTENNA TRIMMER" on Capacitor on 1st R-F Stage | Variable, air trimmer, 6 to 60 mmfd $\pm 10\%$ | -48578 | | 19 | | | K-815736-5 |
| C-107 | Capacitor in Series with C-106 for 1st R-F Fixed Alignment on H-F Bands 4,5 and 6 | Variable, air trimmer, 6 to 50 mmfd $\pm 10\%$ | -48577 | | 19 | | | K-815736-4 |
| *C-108A | Cathode R-F Filter By-pass Capacitor on 1st R-F Tube | Fixed, paper, oil filled, 2 section, 0.5/0.5 mfd $+10\%$ -3% , 250 v max. d.c., 125 v peak a.c., 250 v d.c. working | -48556 | RE 13A 488 | 1 | | | P-721074-7 |
| B | Screen R-F Filter By-pass Capacitor on 1st R-F Tube | | | | | | | |
| C-109 | Aligning Capacitor for Bands 1 and 2 on 2nd R-F Stage | Variable, air trimmer, 6 to 80 mmfd, 15 plate | -48580 | | 31 | | | K-875420-3 |
| C-110 | Aligning Capacitor for Band 3 on 2nd R-F Stage | Same as C-109 | -48580 | | | | | |
| C-111 | "R-F TRIMMER" Capacitor on 2nd R-F Stage | Variable air trimmer, 5.3 to 27 mmfd $\pm 5\%$, 4 plates | -48575 | | 19 | | | K-815736-2 |

* EQUIPMENT SPARE PARTS FURNISHED, refer to TABLE IV, EQUIPMENT SPARES, for quantities.

For IB-38219
Series AB

TABLE II (Continued)
PARTS LIST BY SYMBOL DESIGNATION
FOR MODEL RAK-7 RADIO RECEIVING EQUIPMENT

| SYMBOL DESIG. | FUNCTION | DESCRIPTION | NAVY TYPE NUMBER | NAVY DRAWING OR SPEC. | MFR. | MFR. DESIG. | SPECIAL TOLERANCE, RATING OR MODIFICATION | RCA DRAWING NUMBER |
|------------------------|---|--|------------------|-----------------------|---------------------|----------------------------------|---|--------------------|
| CAPACITORS (Continued) | | | | | | | | |
| *C-112 | Grid Coupling Capacitor between 1st and 2nd R-F Stages | Fixed, molded, mica, 500 mmfd $\pm 10\%$, low loss case, 500 v d.c. working | -48591-D10 | RE 48A 154 | 2,29 16,13 34 | 1459, PO M7K500, 5RS MOSDW | | P-720473-8 |
| *C-113A | Plate Supply By-pass Capacitor on 1st R-F Tube | Same as C-108A&B | -48555 | | | | | |
| B | Plate Supply By-pass Capacitor on 1st R-F Tube | | | | | | | |
| *C-114A | Plate Supply By-pass Capacitor on 1st R-F Tube | Fixed, paper, oil filled, 2 sections, 0.5/0.5 mfd $\pm 10\%$ -3%, 250 v max. d.c., 125 v peak a.c., 250 v d.c. working | -48554 | | 1 | | | P-721074-53 |
| B | Plate Supply By-pass on 2nd R-F Tube | | | | | | | |
| *C-115A | Cathode R-F Filter By-pass Capacitor on 2nd R-F Tube | Same as C-108A&B | -48555 | | | | | |
| B | Screen R-F Filter By-pass Capacitor on 2nd R-F Tube | | | | | | | |
| *C-116 | Cathode By-pass Capacitor on 2nd R-F Tube | Fixed, paper, oil filled, 1 mfd $\pm 10\%$, 400 v d.c. working (one clamp, item 2, to be used & packed with each capacitor) | -48595A | RE 13A 488 | 1 | | | P-720555-52 |
| *C-117 | 2nd R-F Plate Supply By-pass Capacitor | Same as C-116 | -48595A | | | | | |
| *C-118 | Grid Coupling Capacitor between 2nd R-F and Detector Stages | Same as C-112 | -48591-D10 | | | | | |
| *C-119 | Detector Screen Filter By-pass Capacitor | Same as C-116 | -48595A | | | | | |
| *C-120 | Detector Screen R-F Filter By-pass Capacitor | Same as C-108A&B | -48555 | | | | | |
| *C-121 | Detector Plate Filter By-pass Capacitor | Same as C-116 | -48595A | | | | | |
| *C-122 | Coupling Capacitor between Detector Plate and Low-pass Filter L-107 | Fixed, molded, mica, 0.01 mfd $\pm 10\%$, 500 v d.c. working | -48341 | | 2 | 1455 | | K-30090-3 |
| *C-123 | R-F By-pass Capacitor on Grid of 1st Audio Tube | Fixed, mica, 100 mmfd $\pm 5\%$, 500 v d.c. working | -48549 | | 1 | Model T Special Type | | P-32170-518 |

* EQUIPMENT SPARE PARTS FURNISHED, refer to TABLE IV, EQUIPMENT SPARES, for quantities.

TABLE II (Continued)
PARTS LIST BY SYMBOL DESIGNATION
FOR MODEL RAK-7 RADIO RECEIVING EQUIPMENT

| SYMBOL DESIG. | FUNCTION | DESCRIPTION | NAVY TYPE NUMBER | NAVY DRAWING OR SPEC. | MFR. | MFR. DESIG. | SPECIAL TOLER- ANCE, RATING OR MODIFICATION | RCA DRAWING NUMBER |
|------------------------|--|---|---------------------|--------------------------|------|-------------|---|--------------------------|
| CAPACITORS (Continued) | | | | | | | | |
| *C-124 | Cathode By-pass Capacitor on 1st Audio Tube | Same as C-116 | -48595A | | | | | |
| *C-125 | Screen By-pass Capacitor on 1st Audio Tube | Same as C-116 | -48595A | | | | | |
| *C-126 | Screen and Plate By-pass Capacitor on Output Tube | Same as C-116 | -48595A | | | | | |
| *C-127 | Plate Filter By-pass Capacitor on 1st Audio Tube | Same as C-116 | -48595A | | | | | |
| *C-128 | Plate By-pass Capacitor on 1st Audio Tube | Fixed, molded, mica. 0.001 mfd $\pm 10\%$, 500 v d.c. working, phenolic case | -48557 | | 2 | 1455 | | K-30090-10 |
| *C-129 | Coupling Capacitor between 1st Audio and Output Tubes | Fixed, molded, mica, 0.002 mfd $\pm 10\%$, 500 v d.c. working, phenolic case | -48543 | | 2 | 1455 | | K-30090-5 |
| *C-130 | Cathode By-pass Capacitor on Output Tube | Same as C-116 | -48595A | | | | | |
| *C-131 | Cathode By-pass Capacitor on Output Tube | Same as C-116 | -48595A | | | | | |
| *C-132 | Cathode By-pass Capacitor on Output Tube | Same as C-116 | -48595A | | | | | |
| *C-133 | Plate By-pass Capacitor on Output Tube | Same as C-122 | -48341 | | | | | |
| *C-134 | Cathode By-pass Capacitor on AVC Tube | Same as C-116 | -48595A | | | | | |
| *C-135 | Input Filter By-pass Capacitor on 90-Volt "B" Supply | Same as C-116 | -48595A | | | | | |
| *C-136 | Input Filter By-pass Capacitor on 180-Volt "B" Supply | Same as C-116 | -48595A | | | | | |
| *C-137 | Input Filter By-pass Capacitor on 6-Volt Positive Supply | Same as C-116 | -48595A | | | | | |

* EQUIPMENT SPARE PARTS FURNISHED, refer to TABLE IV, EQUIPMENT SPARES, for quantities.

TABLE II (Continued)
PARTS LIST BY SYMBOL DESIGNATION
FOR MODEL RAK-7 RADIO RECEIVING EQUIPMENT

| SYMBOL DESIG. | FUNCTION | DESCRIPTION | NAVY TYPE NUMBER | NAVY DRAWING OR SPEC. | MFR. | MFR. DESIG. | SPECIAL TOLER- ANCE, RATING OR MODIFICATION | RCA DRAWING NUMBER |
|------------------------|---|--|---------------------|--------------------------|------------------|-------------------------------|---|--------------------------|
| CAPACITORS (Continued) | | | | | | | | |
| *C-138 | Input Filter By-pass Capacitor on 6 Volt Negative Supply | Same as C-116 | -48595A | | | | | |
| *C-139 | Antenna Coupling Capacitor on H-F Bands 4,5 and 6 | Fixed, molded, mica, 45.4 mmfd $\pm 5\%$, 500 v d.c. working, composition covered | -48570 | | 1 | Model H | | M-86016-505 |
| C-140 | 2nd R-F Fixed Aligning Capacitor on H-F Bands 4,5 and 6 | Same as C-107 | -48577 | | | | | |
| C-141 | Detector Aligning Capacitor on H-F Bands 4,5 and 6 | Variable, air trimmer, 7.5 to 80 mmfd $\pm 10\%$, 11 plate | -48579 | | 19 | | | K-815736-6 |
| C-142 | Detector Aligning Capacitor on Band 3 | Same as C-141 | -48579 | | | | | |
| C-143 | Detector Aligning Capacitor on Band 2 | Variable, air trimmer, 9 to 125 mmfd 23 plate | -48581 | | 31 | | | K-875420-1 |
| C-144 | Detector Aligning Capacitor on Band 1 | Same as C-143 | -48581 | | | | | |
| *C-145 | Detuning Capacitor across L-F Coil on Band 5 | Fixed, molded, mica, 900 mmfd $\pm 10\%$, 500 v d.c. working, composition covered | -48562 | | 1 | Model H | | M-86016-533 |
| *C-146 | Series Tuning Capacitor Used with Variable Attenuator | Fixed, paper, oil filled, 0.025 mfd $+10\%$ -3% , 600 v d.c. working | -48806 | | 1 | | | P-721074-4 |
| *C-147 | Series Tuning Capacitor Used with Variable Attenuator L-108 | Fixed, paper, oil filled, 0.075 mfd $+10\%$ -3% , 600 v d.c. working | -48807 | | 1 | | | P-721074-5 |
| *C-148 | Output Cable Filter By-pass Capacitor | Mica, molded, fixed, 10,000 mmfd $\pm 10\%$, 300 v d.c. working | -48938-10 | RE 48A 154 | 2,13 29 34 | 1441, 3WS R MLW-3-11-10 | | P-720473-15 |
| *C-149 | Output Cable Filter By-pass Capacitor | Same as C-148 | -48938-10 | | | | | |
| *C-150 | Output Jack Filter By-pass Capacitor | Same as C-148 | -48938-10 | | | | | |

* EQUIPMENT SPARE PARTS FURNISHED, refer to TABLE IV, EQUIPMENT SPARES, for quantities.

TABLE II (Continued)
PARTS LIST BY SYMBOL DESIGNATION
FOR MODEL RAK-7 RADIO RECEIVING EQUIPMENT

| SYMBOL DESIG. | FUNCTION | DESCRIPTION | NAVY TYPE NUMBER | NAVY DRAWING OR SPEC. | MFR. | MFR. DESIG. | SPECIAL TOLER- ANCE, RATING OR MODIFICATION | RCA DRAWING NUMBER |
|-------------------------------|--|---|---------------------|--------------------------|------|-------------|---|--------------------------|
| CAPACITORS (Continued) | | | | | | | | |
| *C-151 | Output Jack Filter By-pass Capacitor | Same as C-148 | 48938-10 | | | | | |
| *C-201 | R-F By-pass Capacitor on A-C Input Power Leads | Fixed, molded, mica, 0.10 mfd $\pm 10\%$, 600 v d.c. working | | RE 48A 154 | 2 | K-850913 | For Replace- ment Use CM-45A-103K | P-720567-22 |
| *C-202 | R-F By-pass Capacitor on A-C Input Power Leads | Same as C-201 | | | | | | |
| *C-203 | R-F By-pass Capacitor on A-C Input Power Leads | Same as C-201 | | | | | | |
| *C-204 | Main Voltage Filter Capacitor | Fixed, paper, oil filled, 3 sections, 3/3/3 mfd $\pm 10\%$, 400 v max. d.c., 200 v peak a.c., 400 v d.c., 400 v d.c. working | 48540 A | | 1 | | | P-72014-507 |
| COIL SHIELDS | | | | | | | | |
| CS-101 | Coil Shield for L-101 | Copper, threaded, 4" dia., 5-1/4" long | | | 1 | | | M-401466-4 |
| CS-102 | Coil Shield for L-102 | Copper, threaded, 4" dia., 3" long | | | 1 | | | M-401466-3 |
| CS-103 | Coil Shield for L-103 | Same as CS-101 | | | | | | |
| CS-104 | Coil Shield for L-104 | Same as CS-102 | | | | | | |
| CS-105 | Coil Shield for L-105 | Same as CS-101 | | | | | | |
| CS-106 | Coil Shield for L-106 | Same as CS-102 | | | | | | |
| PROTECTIVE DEVICES | | | | | | | | |
| *F-201 | Fuse Used in A-C Input Line | Cartridge type, glass body, 3 amps. up to 250 v | | 17-F-2e | 26 | Cat. #1043 | | K-811485-12 |
| *F-202 | Fuse Used in A-C Input Line | Same as F-201 | | | | | | |

* EQUIPMENT SPARE PARTS FURNISHED, refer to TABLE IV, EQUIPMENT SPARES, for quantities.

TABLE II (Continued)
PARTS LIST BY SYMBOL DESIGNATION
FOR MODEL RAK-7 RADIO RECEIVING EQUIPMENT

| SYMBOL DESIG. | FUNCTION | DESCRIPTION | NAVY TYPE NUMBER | NAVY DRAWING OR SPEC. | MFR. | MFR. DESIG. | SPECIAL TOLER- ANCE, RATING OR MODIFICATION | RCA DRAWING NUMBER |
|--------------------------------|---|--|---------------------|--------------------------|------|-------------|---|--------------------------|
| PROTECTIVE DEVICES (Continued) | | | | | | | | |
| F-301 | Fuse Used in Input Line | Glass, cartridge type, 5 amps., 250 v | | | 121 | | | K-55544-36 |
| F-302 | Fuse Used in Input Line | Same as F-301 | | | | | | |
| JACKS | | | | | | | | |
| J-101 | Head Telephone Connection Jack | 4 spring, 2 circuit | -49021 | RF 13A 481D | 28 | P-113567 | | K-833982-1 |
| J-301 | Output Jack | Same as J-101 | -49021 | | | | | |
| J-302 | Output Jack | Same as J-101 | -49021 | | | | | |
| INDUCTANCES | | | | | | | | |
| L-101 | 1st R-F Tuned Circuit Inductance for L-F Bands 1, 2 and 3 | R-F coil, consisting of: 3 universal windings on steatite ceramic tube 1-1/4" dia. x 4-3/4" long with four terminals, each section wound with 10 strands AWG #41 EDS litz wire using 2 crosses per turn; spacing 1-31/32" from terminal end of tube to 1st section and 1/4" between sections 1st section: 810 turns, 3/8" wire traverse 2nd section: 910 turns, 3/8" wire traverse 3rd section: 1640 turns, 9/16" wire traverse | | | 1 | | | T-601403-501 |
| L-102 | 1st R-F Tuned Circuit Inductance for H-F Bands 4, 5 and 6 | R-F coil, consisting of: 4 universal windings on steatite ceramic tube 1" dia. x 2-5/8" long with 4 terminals; each section wound with 10 strands AWG #41 EDS litz wire using 4 crosses per turn and 5/32" wire | | | 1 | | | P-701641-501 |

* EQUIPMENT SPARE PARTS FURNISHED, refer to TABLE IV, EQUIPMENT SPARES, for quantities.

† BASE SPARE PARTS FURNISHED, refer to TABLE IV, BASE SPARES, for quantities.

TABLE II (Continued)
PARTS LIST BY SYMBOL DESIGNATION
FOR MODEL RAK-7 RADIO RECEIVING EQUIPMENT

| SYMBOL DESIG. | FUNCTION | DESCRIPTION | NAVY TYPE NUMBER | NAVY DRAWING OR SPEC. | MFR. | MFR. DESIG. | SPECIAL TOLER- ANCE, RATING OR MODIFICATION | RCA DRAWING NUMBER |
|-------------------------|---|---|---------------------|--------------------------|------|-------------|---|--------------------------|
| INDUCTANCES (Continued) | | | | | | | | |
| L-102 | (Continued) | <p>traverse, spacing 1-9/32" from terminal end of tube to 1st section and 1/8" between sections</p> <p>1st section: 130 turns 2nd section: 180 turns 3rd section 195 turns 4th section: 175 turns</p> | | | | | | |
| L-103 | 2nd R-F Tuned Circuit Inductance for L-F Bands 1,2 and 3 | R-F coil, same as L-101 except each winding tapped: 1st section at 160 turns, 2nd section at 250 turns and 3rd section at 400 turns; taps connected to 3 additional terminals, making total of 7 terminals on coil tube | | | 1 | | | T-601403-502 |
| L-104 | 2nd R-F Tuned Circuit Inductance for H-F Bands 4,5 and 6 | R-F coil, same as L-102 except 1st section tapped at 50 turns; tap connected to additional terminal, making total of 5 terminals on coil tube | | | 1 | | | P-701641-502 |
| L-105 | Detector Tuned Circuit Inductance and Regenerative Windings for L-F Bands 1,2 and 3 | <p>R-F coil, consisting of: 5 universal windings on steatite ceramic tube 1-1/4" dia. x 4-3/4" long with 11 terminals; 1st and 5th sections wound with AWG #30 ES wire, 2nd, 3rd and 4th sections same as L-101 except as noted below, spacing 1/4" between 1st and 2nd sections and 15/32" between 4th and 5th sections</p> <p>1st section: 35 turns, 2 crosses per turn, 3/8" wire traverse, tapped at 17 turns</p> <p>2nd section: same as 1st section of L-101 except tapped at 200 turns</p> | | | 1 | | | T-601403-503 |
| L-106 | Detector Tuned Circuit Inductance and Regenerative Windings for L-F Bands 4,5 and 6 | R-F coil, consisting of: 5 universal windings on steatite ceramic tube 1" dia. x 2-5/8" long with 11 terminals, 1st section wound with AWG #30 | | | 1 | | | P-701641-503 |

TABLE II (Continued)
PARTS LIST BY SYMBOL DESIGNATION
FOR MODEL RAK-7 RADIO RECEIVING EQUIPMENT

| SYMBOL DESIG. | FUNCTION | DESCRIPTION | NAVY TYPE NUMBER | NAVY DRAWING OR SPEC. | MFR. | MFR. DESIG. | SPECIAL TOLERANCE, RATING OR MODIFICATION | RCA DRAWING NUMBER |
|-------------------------|---|---|------------------|-----------------------|------|-------------|---|--------------------|
| INDUCTANCES (Continued) | | | | | | | | |
| L-106 | (Continued) | <p>ES wire using 4 crosses per turn and 5/32" wire traverse; 2nd, 3rd, 4th and 5th sections same as L-102 except as noted below, spacing 3/16" between 1st and 2nd sections</p> <p>1st section: 20 turns, tapped as 10 and 15 turns</p> <p>2nd section: same as 1st section of L-102 except tapped at 50 turns</p> <p>3rd section: same as 2nd section of L-102 except tapped at 50 turns</p> <p>4th section: same as 3rd section of L-102</p> <p>5th section: same as 4th section of L-102 except tapped at 50 turns</p> | | | | | | |
| †L-107 | Low-pass Filter between Detector and 1st Audio Tubes to Attenuate Audio Output at Frequencies above 1200 Cycles | <p>Impregnated and sealed in can, assembly consisting of: 4 iron core reactors connected in series, and seven capacitors five of which form legs of filter; from input to output side reactors are 22.8 henries, 13.2 henries, 13.2 henries and 13.2 henries respectively, the five capacitors forming legs are from input to output side: 1150 mmfd, 1800 mmfd, 1300 mmfd, 1300 mmfd and 650 mmfd, one 650 mmfd capacitor is connected across each of two center reactors, each capacitor 500 v d.c. working</p> | -53031 | | 1 | RT-346 | | P-72402-501 |
| †L-108 | Variable Attenuator Used Optionally across Grid Circuit of 1st Audio Stage for Audio Tuning | <p>Reactor, impregnated and sealed in can consisting of: 2500 turns AWG #29 E wire with taps located as follows from input to output side: 1360, 1460, 1560, 1670, 1780, 1910, 2040, 2180 and 2340 turns, coil traverse 1-1/4" d-c resistance 86 ohms</p> | -30343 | | 1 | RT-528 | | P-72397-502 |

† BASE SPARE PARTS FURNISHED. refer to TABLE IV. BASE SPARES. for quantities.

TABLE II (Continued)
PARTS LIST BY SYMBOL DESIGNATION
FOR MODEL PAK-7 RADIO RECEIVING EQUIPMENT

| SYMBOL DESIG. | FUNCTION | DESCRIPTION | NAVY TYPE NUMBER | NAVY DRAWING OR SPEC. | MFR. | MFR. DESIG. | SPECIAL TOLER- ANCE, RATING OR MODIFICATION | RCA DRAWING NUMBER |
|-------------------------|--|--|---------------------|--------------------------|-------|-------------|---|--------------------------|
| INDUCTANCES (Continued) | | | | | | | | |
| *L-109 | Choke Used as Filter in Cathode Bias Supply to 1st and 2nd R-F Tubes | Reactor, iron core, impregnated and sealed in can consisting of: 5500 turns AWG #35 E wire, coil traverse 31/32", impedance 3800 ohms at 3 v, 50 cycles with 0.012 amp. d.c., d-c resistance 220 ohms $\pm 7.5\%$ | -30243 | | 1 | RT-351 | | M-80157-501 |
| †L-110 | Output Cable Filter | R-F choke, single layer wound on steatite core 1000 ma rating, inductance 5.5 microhenries, d-c resistance 0.85 ohms | | | 32,20 | Z1 | | K-871304-1 |
| †L-111 | Output Cable Filter | Same as L-110 | | | | | | |
| †L-112A B | Output Jack Filter Output Jack Filter | R-F choke dual assembly consisting of: 2 single layer, R.H., close wound windings of 30 turns of #28 wire each, wound together in bifilar on laminated phenolic form 1/2" dia. x 1-5/8" long, coil mounted between 2-1/16" thick laminated phenolic terminal boards 1" wide x 1-1/4" long each having 2 brass open terminals | | | 1 | | | K-865413-501 |
| †L-113 | Antenna Series Choke for U-H-F Signal Pick-up Suppression | Same as L-110 | | | | | | |
| †L-201 | R-F Choke Used in Series with A-C Input | R-F choke assembly consisting of: single layer, 69 turns AWG #18 E copper wire wound on 1" dia. phenolic tube | | | 1 | | | M-407170-501 |
| †L-202 | R-F Choke Used in Series with A-C Input | Same as L-201 | | | | | | |
| †L-203 | Line Filter on A-C Input | R-F, 2 iron core reactors and 2 capacitors impregnated and sealed in can; reactors 0.073 and 0.084 ohms resistance approx., 2 to 12 millihenries inductance, capacitors 1.0 mfd $\pm 10\%$, 300 v d.c. working | -30248 | | 1 | RT-347 | | P-705254-503 |

* EQUIPMENT SPARE PARTS FURNISHED, refer to TABLE IV, EQUIPMENT SPARES, for quantities.

† BASE SPARE PARTS FURNISHED, refer to TABLE IV, BASE SPARES, for quantities.

TABLE II (Continued)
PARTS LIST BY SYMBOL DESIGNATION
FOR MODEL RAK-7 RADIO RECEIVING EQUIPMENT

| SYMBOL DESIG. | FUNCTION | DESCRIPTION | NAVY TYPE NUMBER | NAVY DRAWING OR SPEC. | MFR. | MFR. DESIG. | SPECIAL TOLER- ANCE, RATING OR MODIFICATION | RCA DRAWING NUMBER |
|----------------------------------|---|--|---------------------|--------------------------|----------------|------------------------|---|--------------------------|
| INDUCTANCES (Continued) | | | | | | | | |
| †L-204 | Filter Reactor Used as 1st Section of Main Filter on D-C Output, End Section in Series with Middle Filter Capacitor Acts as Tuned Low Impedance to Ripple Frequency | Tapped, iron core, impregnated and sealed, d-c resistance 210 ohms $\pm 7.5\%$, 5200 ohms at 3 v, 50 cycles, 0.08 amp. d.c., 3 leads | -30247 | | 1 | RT-350 | | M-406261-504 |
| †L-205 | Filter Reactor Used as 2nd Section of Main Filter on D-C Output | Same as L-204 except 2 leads | -30245 | | 1 | RT-349 | | M-406261-503 |
| ELECTRICAL MEASURING INSTRUMENTS | | | | | | | | |
| †M-101 | Meter Connected across Output | Range, -10 to +5 db $\pm 5\%$, with divisions each 2db on minus side and each 1db on plus side, calibration accuracy $\pm 5\%$, d-c resistance 5000 ohms $\pm 5\%$, reference output impedance 500 ohms | -22152 | 17-I-12A | 18 38 39 | 8DW-45 NC-33 506 | | M-420279-5 |
| †M-102 | Voltmeter Connected across Heater Leads | AC/DC, calibration accuracy $\pm 2\%$ over full scale for a.c. 15-100 cycles, and $\pm 2\%$ from 5-7 v d.c. | -22245 | 17-I-12A | 18 38 39 | 8AW-41 NA-33 517 | | M-420279-5 |
| RESISTORS | | | | | | | | |
| *R-101 | Resistor in Parallel with Gain Equalizer | Composition, 550 ohms $\pm 10\%$, 1/2 watt, pigtail, insulated | -63360 | | 21 | BT-1/2 | | K-850981-59 |
| *R-102 | Grid Bias Potentiometer on 1st and 2nd R-F Tubes ("SENSITIVITY") | Wire wound, 5000 ohms $\pm 10\%$, 1.5 watts, linear | -63430 | | 40 | | | K-806741-8 |
| *R-103 | Part of R-F Screen Voltage Divider | Composition, 5100 ohms $\pm 5\%$, 1 watt, pigtail, insulated | -63291 | | 21 | BT-1 | | K-844314-176 |
| *R-104 | Part of R-F Screen Voltage Divider | Composition, 10,000 ohms $\pm 10\%$, 1 watt, pigtail, insulated | -63288 | | 21 | BT-1 | | K-844314-74 |

* EQUIPMENT SPARE PARTS FURNISHED, refer to TABLE IV, EQUIPMENT SPARES, for quantities.

† BASE SPARE PARTS FURNISHED, refer to TABLE IV, BASE SPARES, for quantities.

TABLE II (Continued)
PARTS LIST BY SYMBOL DESIGNATION
FOR MODEL RAK-7 RADIO RECEIVING EQUIPMENT

| SYMBOL DESIG. | FUNCTION | DESCRIPTION | NAVY TYPE NUMBER | NAVY DRAWING OR SPEC. | MFR. | MFR. DESIG. | SPECIAL TOLER- ANCE, RATING OR MODIFICATION | RCA DRAWING NUMBER |
|-----------------------|--|--|---------------------|--------------------------|------|-------------|---|--------------------------|
| RESISTORS (Continued) | | | | | | | | |
| *R-105 | Cathode Bias Resistor on 1st R-F Tube | Composition, 510 ohms $\pm 5\%$, 1/2 watt, pigtail, insulated | -63355 | | 21 | BT-1/2 | | K-850981-152 |
| *R-106 | Screen Filter Resistor on 1st R-F Tube | Composition, 10,000 ohms $\pm 10\%$, 1/2 watt, pigtail, insulated | -63360 | | 21 | BT-1/2 | | K-850981-74 |
| *R-107 | Plate Filter Resistor on 1st R-F Tube | Same as R-106 | -63360 | | | | | |
| *R-108 | Grid Resistor on 2nd R-F Tube | Composition, 4.7 megohms $\pm 10\%$, 1/2 watt, pigtail, insulated | -63360 | | 21 | BT-1/2 | | K-850981-106 |
| *R-109 | Cathode Bias Resistor on 2nd R-F Tube | Composition, 270 ohms $\pm 10\%$, 1/2 watt, pigtail, insulated | -63360 | | 21 | BT-1/2 | | K-850981-55 |
| *R-110 | Screen Filter Resistor on 2nd R-F Tube | Same as R-106 | -63360 | | | | | |
| *R-111 | Plate Filter Resistor on 2nd R-F Tube | Same as R-106 | -63360 | | | | | |
| *R-112 | Grid Leak Resistor on Detector Tube | Same as R-108 | -63360 | | | | | |
| *R-113 | Screen Filter Resistor on Detector Tube | Same as R-106 | -63360 | | | | | |
| *R-114 | Plate Load Resistor on Detector Tube | Composition, 100,000 ohms $\pm 10\%$, 1/2 watt, pigtail, insulated | -63360 | | 21 | BT-1/2 | | K-850981-86 |
| *R-115 | Plate Filter Resistor on Detector Tube | Same as R-106 | -63360 | | | | | |
| *R-116 | Part of Detector Screen Voltage Divider | Composition, 24,000 ohms $\pm 5\%$, 1/2 watt, pigtail, insulated | -63355 | | 21 | BT-1/2 | | K-850981-192 |
| *R-117 | Part of Detector Screen Voltage Divider | Composition, 51,000 ohms $\pm 5\%$, 1/2 watt, pigtail, insulated | -63355 | | 21 | BT-1/2 | | K-850981-200 |
| *R-118 | Plate Filter Resistor on 2nd R-F and Detector Tubes | Same as R-104 | -63288 | | | | | |

* EQUIPMENT SPARE PARTS FURNISHED. refer to TABLE IV, EQUIPMENT SPARES, for quantities.

TABLE II (Continued)
PARTS LIST BY SYMBOL DESIGNATION
FOR MODEL RAK-7 RADIO RECEIVING EQUIPMENT

| SYMBOL DESIG. | FUNCTION | DESCRIPTION | NAVY TYPE NUMBER | NAVY DRAWING OR SPEC. | MFR. | MFR. DESIG. | SPECIAL TOLER- ANCE, RATING OR MODIFICATION | RCA DRAWING NUMBER |
|-----------------------|--|--|---------------------|--------------------------|------|-------------|---|--------------------------|
| RESISTORS (Continued) | | | | | | | | |
| *R-119 | Grid Filter Resistor on 1st Audio Tube | Composition, 1.0 megohm $\pm 10\%$, 1/2 watt, pigtail, insulated | -63360 | | 21 | BT-1/2 | | K-850981-98 |
| *R-120 | Grid Resistor on 1st Audio Tube | Same as R-114 | -63360 | | | | | |
| *R-121 | Plate Load Resistor on 1st Audio Tube | Same as R-114 | -63360 | | | | | |
| *R-122 | Grid Resistor on Output Tube | Same as R-119 | -63360 | | | | | |
| *R-123 | Cathode Bias Resistor on 1st Audio Tube | Composition, 1000 ohms $\pm 10\%$, 1/2 watt, pigtail, insulated | -63360 | | 21 | BT-1/2 | | K-850981-62 |
| *R-124 | Screen Filter Resistor on 1st Audio Tube | Composition, 390,000 ohms $\pm 5\%$, 1/2 watt pigtail, insulated | -63355 | | 21 | BT-1/2 | | K-850981-221 |
| *R-125 | Plate Filter Resistor on 1st Audio Tube | Composition, 20,000 ohms $\pm 5\%$, 1/2 watt, pigtail, insulated | -63355 | | 21 | BT-1/2 | | K-850981-190 |
| *R-126 | Screen and Plate Filter Resistor on Output Tube | Composition, 4700 ohms $\pm 10\%$, 1 watt, pigtail, insulated | -63288 | | 21 | BT-1 | | K-844314-70 |
| *R-127 | Cathode Bias Resistor on Output Tube | Composition, 620 ohms $\pm 5\%$, 1/2 watt, pigtail, insulated | -63355 | | 21 | BT-1/2 | | K-850981-154 |
| *R-128 | Part of Output Meter Multiplier | Composition, 12,000 ohms $\pm 5\%$, 1/2 watt, pigtail, insulated | -63355 | | 21 | BT-1/2 | | K-850981-185 |
| *R-129 | Part of Output Meter Multiplier | Composition, 11,000 ohms $\pm 5\%$, 1/2 watt, pigtail, insulated | -63355 | | 21 | BT-1/2 | | K-850981-184 |
| *R-130 | Part of Output Meter Multiplier | Same as R-129 | -63355 | | | | | |
| *R-131 | Part of Output Meter Multiplier | Composition, 3900 ohms $\pm 5\%$, 1/2 watt, pigtail, insulated | -63355 | | 21 | BT-1/2 | | K-850981-173 |
| *R-132 | Gain Equalizer Potentiometer Ganged with Main Tuning Control | Wire wound, 1000 ohms, $\pm 10\%$, 2 watts, linear, continuously rotatable | -63427 | | 28 | SPO #7151 | Modified | K-815823-1 |
| *R-133 | Detector Tube Screen Voltage Control ("REGENERATION") | Potentiometer, wire wound, 25,000 ohms $\pm 15\%$, 2 watts, linear | -63247 | | 40 | | | K-805741-2 |

* EQUIPMENT SPARE PARTS FURNISHED, refer to TABLE IV. EQUIPMENT SPARES, for quantities.

TABLE II (Continued)
PARTS LIST BY SYMBOL DESIGNATION
FOR MODEL RAK-7 RADIO RECEIVING EQUIPMENT

| SYMBOL DESIG. | FUNCTION | DESCRIPTION | NAVY TYPE NUMBER | NAVY DRAWING OR SPEC. | MFR. | MFR. DESIG. | SPECIAL TOLER- ANCE, RATING OR MODIFICATION | RCA DRAWING NUMBER |
|-----------------------|---|--|---------------------|--------------------------|------|----------------|---|--------------------------|
| RESISTORS (Continued) | | | | | | | | |
| *R-134 | Grid Bias Potentiometer on AVC Tube ("AVC LEVEL") | Wire wound, 20,000 ohms $\pm 10\%$, 2 watts, with 1st quarter, turn clockwise 1000 ohms | -63429 | | 40 | | | K-806741-7 |
| *R-201 | Drop Resistor on Series with Current Regulator Lamp across AC Input | Vitreous enamel, 80 ohms, $\pm 10\%$, 200 watts, ferrule type, 9-5/8" long | -63184 | RE 13A-372G | 37 | | | K-806810-2 |
| *R-202 | Bleeder Resistor across H-V Output | Composition, 20,000 ohms $\pm 5\%$, 4 watts, pigtail | -631629-5 | | 617 | | | K-880984-2 |
| *R-203 | Voltage Divider in Series with Voltage Regulator Tube across H-V Output to Supply 90 Volts D.C. | Composition, 6200 ohms $\pm 5\%$, 4 watts, pigtail | -631628-5 | | 617 | | | K-880984-1 |
| R-204 | Used in Parallel with R-203 | Same as R-203 | -631628-5 | | | | | |
| SWITCHES | | | | | | | | |
| *S-101 | Switch Connecting "AUDIO TUNING" Variable Attenuator (L-108) across Grid Circuit of 1st Audio Tube | Toggle, S.P.S.T., rated 1 amp. at 250 v d.c., 3 amps. at 125 v d.c. | -24000 | RE 24AA 118A | 7 | Cat. #20994-ET | | M-420278-1 |
| *S-102 | Switch Connecting either High or Low Frequency "AUDIO TUNING" Variable Attenuator across Grid Circuit of 1st Audio Tube | Toggle, D.P.D.T., rated 1 amp. at 250 v d.c., 3 amps. at 125 v d.c. | -24003 | RE 24AA 118A | 7 | Cat. #20905-EP | | M-420278-4 |
| S-103 | Switch Used to change Taps on Variable Attenuator | Rotary, single wafer: 11 points, stop adjusted for 10 positions | -24029 | | 28 | 1211 modified | | K-850187-1 |
| *S-104 | Switch Connecting AVC Transformer (T-102) across Plate Circuit of Output Tube | Same as S-101 | -24000 | | | | | |

* EQUIPMENT SPARE PARTS FURNISHED, refer to TABLE IV, EQUIPMENT SPARES, for quantities.

TABLE II (Continued)
PARTS LIST BY SYMBOL DESIGNATION
FOR MODEL RAK-7 RADIO RECEIVING EQUIPMENT

| SYMBOL DESIG. | FUNCTION | DESCRIPTION | NAVY TYPE NUMBER | NAVY DRAWING OR SPEC. | MFR. | MFR. DESIG. | SPECIAL TOLER- ANCE, RATING OR MODIFICATION | RCA DRAWING NUMBER |
|----------------------|--|---|---------------------|--------------------------|------|----------------|---|--------------------------|
| SWITCHES (Continued) | | | | | | | | |
| S-105 | Switch Used to Change Resistance in Series with Output "DB" Meter | Same as S-103 except stop adjusted for 5 positions | -24029 | | | | | |
| *S-106 | Switch Breaking +A and +B Supply on Battery Operated Equipment | Toggle, D.P.S.T., rated, 1 amp. at 250 v, d.c., 3 amps. at 125 v d.c. | -24001 | RF 24AA 118A | 7 | Cat. #20902-CZ | | M-420278-3 |
| S-107 | 1st R-F Circuit Band Switch Section | 12 silver contacts on steatite plates | | | 1 | | | T-601407-501 |
| S-108 | 1st R-F Circuit Band Switch Section | Same as S-107 except for contact wiring | | | 1 | | | T-601407-502 |
| S-109 | 2nd R-F Circuit Band Switch Section | Same as S-107 except for contact wiring | | | 1 | | | T-601407-503 |
| S-110 | 2nd R-F Circuit Band Switch Section | Same as S-107 except for contact wiring | | | 1 | | | T-601407-504 |
| S-111 | Detector Circuit Band Switch Section | Same as S-107 except for contact wiring | | | 1 | | | T-601407-505 |
| S-112 | Detector Circuit Band Switch Section | Same as S-107 except for contact wiring | | | 1 | | | T-601407-506 |
| S-113 | Detector Circuit Band Switch Section | Same as S-107 except for contact wiring | | | 1 | | | T-601407-507 |
| S-114 | Switch Connecting Detector Cathode to Ground to Stop Oscillation | "OSC. TEST" push button, spring contact, isolantite base | | | 1 | | | K-815759-501 |
| *S-201 | Switch Used to Break Both Sides of A-C Input | Same as S-106 | -24001 | | | | | |
| *S-202 | Switch Used to Disconnect Current-Regulated A-C Supply from Power Transformer Primary Tap and to Connect A-C Supply Directly Across Full Primary Winding, Switch to be Thrown Only With Current-Regulator Tube (V-201) Removed | Same as S-102 | -24003 | | | | | |

* EQUIPMENT SPARE PARTS FURNISHED, refer to TABLE IV. EQUIPMENT SPARES, for quantities.

TABLE II (Continued)
PARTS LIST BY SYMBOL DESIGNATION
FOR MODEL RAK-7 RADIO RECEIVING EQUIPMENT

| SYMBOL DESIG. | FUNCTION | DESCRIPTION | NAVY TYPE NUMBER | NAVY DRAWING OR SPEC. | MFR. | MFR. DESIG. | SPECIAL TOLER- ANCE, RATING OR MODIFICATION | RCA DRAWING NUMBER | | | | | | | | | | | | | | | | | | | | | | | | |
|----------------------|---|---|-----------------------------|--------------------------|-------------------------|-----------------------------|---|--------------------------|--|------|--------|--|--|-------|-------|--------|--------|-------|-----------|---------------|----------|-----|----------|---------------|-----------|------|--------|--|---|---------|--|--------------|
| SWITCHES (Continued) | | | | | | | | | | | | | | | | | | | | | | | | | | | | | | | | |
| S-301 | Power Switch | Same as S-106 | -24001 | | | | | | | | | | | | | | | | | | | | | | | | | | | | | |
| S-302 | Power Switch | Same as S-106 | -24001 | | | | | | | | | | | | | | | | | | | | | | | | | | | | | |
| S-303 | Switch Used to Connect Output of Either Receiver Unit of Both to Telephone Jacks | Mixer, low capacity, 4 pole, 3 position | | | 637 | 172A modified | | K-855530-2 | | | | | | | | | | | | | | | | | | | | | | | | |
| TRANSFORMERS | | | | | | | | | | | | | | | | | | | | | | | | | | | | | | | | |
| *T-101 | Output Transformer Coupling Plate Circuit of Output Tube to Telephone Jack; Secondary Mid-tapped to Ground; 600 Ohms Output Impedance | Output, consisting of: primary and secondary with midtap ratio 3.94 to 1; d-c resistance 427 ohms primary, 41.7 ohms secondary, impregnated and sealed in can | -30242A | | 1 | RT-354 | | M-80158-501 | | | | | | | | | | | | | | | | | | | | | | | | |
| *T-102 | AVC Transformer Used Optionally across Plate Circuit of Output Tube to Feed Grid of AVC Tube | AVC, ratio 1 to 12.5; d-c resistance 57 ohms primary, 3540 ohms secondary impregnated and sealed in can | -30244 | | 1 | RT-355 | | M-80159-501 | | | | | | | | | | | | | | | | | | | | | | | | |
| †T-201 | Power Transformer, Main High and Low Voltage H-C Supply | Power, impregnated and sealed in can, hi-pot 2500 v max. core loss 5.0 watts, max. exciting current 0.3 amp. at 120 v 60 cycles, induced voltage 480 v, 500 cycles <table style="margin-left: auto; margin-right: auto; border-collapse: collapse;"> <thead> <tr> <th></th> <th>No Load Voltage</th> <th>Full Load Voltage</th> <th>Rated Current (Amps.)</th> </tr> </thead> <tbody> <tr> <td>Pri.#1</td> <td></td> <td></td> <td>1.08</td> </tr> <tr> <td>Pri.#2</td> <td></td> <td></td> <td>0.615</td> </tr> <tr> <td>Plate</td> <td>498±15</td> <td>460±14</td> <td>0.085</td> </tr> <tr> <td>Rect.Fil.</td> <td>5.57± 0.17</td> <td>5.0±0.15</td> <td>3.0</td> </tr> <tr> <td>Amp.Fil.</td> <td>7.16± 0.21</td> <td>6.5±0.195</td> <td>2.12</td> </tr> </tbody> </table> | | No Load Voltage | Full Load Voltage | Rated Current (Amps.) | Pri.#1 | | | 1.08 | Pri.#2 | | | 0.615 | Plate | 498±15 | 460±14 | 0.085 | Rect.Fil. | 5.57± 0.17 | 5.0±0.15 | 3.0 | Amp.Fil. | 7.16± 0.21 | 6.5±0.195 | 2.12 | -30444 | | 1 | XT-2986 | | K-900536-501 |
| | No Load Voltage | Full Load Voltage | Rated Current (Amps.) | | | | | | | | | | | | | | | | | | | | | | | | | | | | | |
| Pri.#1 | | | 1.08 | | | | | | | | | | | | | | | | | | | | | | | | | | | | | |
| Pri.#2 | | | 0.615 | | | | | | | | | | | | | | | | | | | | | | | | | | | | | |
| Plate | 498±15 | 460±14 | 0.085 | | | | | | | | | | | | | | | | | | | | | | | | | | | | | |
| Rect.Fil. | 5.57± 0.17 | 5.0±0.15 | 3.0 | | | | | | | | | | | | | | | | | | | | | | | | | | | | | |
| Amp.Fil. | 7.16± 0.21 | 6.5±0.195 | 2.12 | | | | | | | | | | | | | | | | | | | | | | | | | | | | | |

* EQUIPMENT SPARE PARTS FURNISHED, refer to TABLE IV. EQUIPMENT SPARES, for quantities.

† BASE SPARE PARTS FURNISHED, refer to TABLE IV. BASE SPARES, for quantities.

TABLE II (Continued)
PARTS LIST BY SYMBOL DESIGNATION
FOR MODEL RAK-7 RADIO RECEIVING EQUIPMENT

| SYMBOL DESIG. | FUNCTION | DESCRIPTION | NAVY TYPE NUMBER | NAVY DRAWING OR SPEC. | MFR. | MFR. DESIG. | SPECIAL TOLER- ANCE, RATING OR MODIFICATION | RCA DRAWING NUMBER |
|---------------------------------|----------------------------|---|---------------------|--------------------------|------|-------------|---|--------------------------|
| TRANSFORMERS (Continued) | | | | | | | | |
| T-201 | (Continued) | Wind- Wire ing Size Turns Taps Res. (Ohms) Pri. #1 #21 342 311 2.0 326 Pri. #2 #23 260 210 3.03 236 Plate #31 2500 1250 250 Rec. #15 36 Fil. Amp. #17 36 18 Fil. | | | | | | |
| TUBE SHIELDS | | | | | | | | |
| TS-101A | Tube Shield Body for V-101 | Aluminum, chimney type, 1-37/64" dia., 3-27/32" long | | | 82 | Special | | K-850358-1 |
| TS-101B | Tube Shield Cap for V-101 | Aluminum, 1-5/8" dia., 2-1/16" long | | | 82 | S-618 | | K-855779-1 |
| TS-102A | Tube Shield Body for V-102 | Same as TS-101A | | | | | | |
| TS-102B | Tube Shield Cap for V-102 | Same as TS-101B | | | | | | |
| TS-103A | Tube Shield Body for V-103 | Same as TS-101A | | | | | | |
| TS-103B | Tube Shield Cap for V-103 | Same as TS-101B | | | | | | |
| TS-104A | Tube Shield Body for V-104 | Same as TS-101A | | | | | | |
| TS-104B | Tube Shield Cap for V-104 | Same as TS-101B | | | | | | |
| TS-105A | Tube Shield Body for V-105 | Same as TS-101A | | | | | | |
| TS-105B | Tube Shield Cap for V-105 | Same as TS-101B | | | | | | |
| VACUUM TUBES | | | | | | | | |
| *V-101 | 1st R-F Amplifier Tube | Triple-grid super-control amplifier, small metal cap, small 6 pin base, heater: 6.3 v a.c. or d.c. at 0.3 amp. | 6D6 | RE 13A 600A | 1a | -6D6 | | |

* EQUIPMENT SPARE PARTS FURNISHED, refer to TABLE IV, EQUIPMENT SPARES, for quantities.

TABLE II (Continued)
PARTS LIST BY SYMBOL DESIGNATION
FOR MODEL RAK-7 RADIO RECEIVING EQUIPMENT

| SYMBOL DESIG. | FUNCTION | DESCRIPTION | NAVY TYPE NUMBER | NAVY DRAWING OR SPEC. | MFR. | MFR. DESIG. | SPECIAL TOLER- ANCE, RATING OR MODIFICATION | RCA DRAWING NUMBER |
|---------------------------|---------------------------------------|--|---------------------|--------------------------|-----------|-----------------|---|--------------------------|
| *VACUUM TUBES (Continued) | | | | | | | | |
| *V-102 | 2nd R-F Amplifier Tube | Same as V-101 | -6D6 | | | | | |
| *V-103 | Detector Tube | Same as V-101 | -6D6 | | | | | |
| *V-104 | 1st Audio Amplifier Tube | Same as V-101 | -6D6 | | | | | |
| *V-105 | 2nd Audio Amplifier Tube | Power amplifier, pentode, small 6 pin base, heater: 6.3 v a.c. or d.c. at 0.4 amp. | -41 | RE 13A 600A | 1a | -41 | | |
| *V-106 | AVC Tube | Same as V-105 | -41 | | | | | |
| *V-201 | Current Regulator Tube | Mogul screw base, voltage range 40 to 60 v, operating current 1.7 amps., ambient temperature 150° F. | -876 | RE 13A 600A | 1a | -876 | | |
| *V-202 | Rectifier Tube | Full wave, high vacuum rectifier, medium 4 pin base, heater: 5.0 v a.c. at 3.0 amps. | -5Z3 | RE 13A 600A | 1a | -5Z3 | | |
| *V-203 | Voltage Regulator Tube | Medium 4 pin bayonet base, rated voltage 90 v d.c., operating current 10 to 50 d.c. ma | -874 | RE 13A 600A | 1a | -874 | | |
| SOCKETS | | | | | | | | |
| *X-101 | Receptacle for 1st R-F Tube | 6 contacts, wafer type, ceramic base | -49318 | RE 13A 317G | 19 690 | S-6 modified | Less spacers and washers | K-856996-3 |
| *X-102 | Receptacle for 2nd R-F Tube | Same as X-101 | -49318 | | | | | |
| *X-103 | Receptacle for Detector Tube | Same as X-101 | -49318 | | | | | |
| *X-104 | Receptacle for 1st Audio Tube | 6 contacts, wafer type, phenolic base | -49308 | | 1 690 | | | M-401806-503 |
| *X-105 | Receptacle for 2nd Audio Tube | Same as X-104 | -49308 | | | | | |
| *X-106 | Receptacle for AVC Tube | Same as X-104 | -49308 | | | | | |
| X-201 | Receptacle for Current Regulator Tube | Mogul size, enclosed in porcelain | | | 8 | 4062 | | K-850876-1 |
| *X-202 | Receptacle for Rectifier Tube | 4 contacts, wafer type, phenolic base with shock mounting and supports | -49311A | | 1 | | | M-401485-502 |
| *X-203 | Receptacle for Voltage Regulator Tube | Same as X-202 | -49311A | | | | | |

* EQUIPMENT SPARE PARTS FURNISHED, refer to TABLE IV, EQUIPMENT SPARES, for quantities.

TABLE II (Continued)
PARTS LIST BY SYMBOL DESIGNATION
FOR MODEL RAK-7 RADIO RECEIVING EQUIPMENT

| SYMBOL DESIG. | FUNCTION | DESCRIPTION | NAVY TYPE NUMBER | NAVY DRAWING OR SPEC. | MFR. | MFR. DESIG. | SPECIAL TOLER- ANCE, RATING OR MODIFICATION | RCA DRAWING NUMBER |
|------------------|---|---|---------------------|--------------------------|----------|-------------|---|--------------------------|
| MISCELLANEOUS | | | | | | | | |
| * | Wrench | Spanner, assembly consisting of: 2 brass pins 5/32" dia. and brass handle 0.064" thick with 1/2" dia. hole | -10012 | | 1, 73 | | | K-815970-501 |
| * | Clamp to be Used with C-116,117, 119,121,124,125,126,127,130, 131,132,134,135,136,137,138 | Brass, 1.8125" long | | | 1 | | | K-90545-1 |
| | Lamp | Bayonet base, clear, 6-8 v, 0.25 amp. | | | 18 | | | K-61114-15 |
| | Adapter | Assembly | | | 1 | | | K-883492-501 |

* EQUIPMENT SPARE PARTS FURNISHED, refer to TABLE IV, EQUIPMENT SPARES, for quantities.

B

TABLE III
PARTS LIST BY NAVY TYPE NUMBERS
FOR MODEL RAK-7 RADIO RECEIVING EQUIPMENT

| QUAN- TITY | NAVY TYPE NUMBER | ALL SYMBOL DESIGNATIONS INVOLVED | QUAN- TITY | NAVY TYPE NUMBER | ALL SYMBOL DESIGNATIONS INVOLVED | QUAN- TITY | NAVY TYPE NUMBER | ALL SYMBOL DESIGNATIONS INVOLVED |
|---|---------------------|-------------------------------------|---|---------------------|-------------------------------------|-----------------------------------|---------------------|--|
| MISCELLANEOUS (CLASS 10) | | | A-F TRANSFORMERS & REACTORS (CLASS 30) (Continued) | | | CAPACITORS (CLASS 48) (Continued) | | |
| 3 | | CS-101, 103, 105 | 1 | -30244 | T-102 | 1 | -48554 | C-114A&B |
| 3 | | CS-102, 104, 105 | 1 | -30246 | L-205 | 4 | -48556 | C-108A&B, 113A&B, 115A&B, 120 |
| 5 | | TS-101A, 102A, 103A, 104A, 105A | 1 | -30247 | L-204 | 1 | -48557 | C-128 |
| 5 | | TS-101B, 102B, 103B, 104B, 105B | 1 | -30248 | L-203 | 1 | -48558 | C-101 |
| ELECTRICAL MEASURING INSTRUMENTS (CLASS 22) | | | 1 | -30343 | L-108 | 1 | -48562 | C-145 |
| 1 | -22152 | M-101 | 1 | -30444 | T-201 | 1 | -48568 | C-103 |
| 1 | -22246 | M-102 | VACUUM TUBES (CLASS 38) | | | 1 | -48569 | C-104 |
| SWITCHES (CLASS 24) | | | 4 | -6D6 | V-101, 102, 103, 104 | 1 | -48570 | C-139 |
| 2 | -24000 | S-101, 104 | 1 | -5Z3 | V-202 | 1 | -48572 | C-102 |
| 4 | -24001 | S-106, 201, 301, 302 | 2 | -41 | V-105, 106 | 1 | -48575 | C-111 |
| 2 | -24003 | S-102, 202 | 1 | -874 | V-203 | 2 | -48577 | C-107, 140 |
| 2 | -24029 | S-103, 105 | 1 | -876 | V-201 | 1 | -48578 | C-106 |
| 1 | | S-107 | R-F INDUCTANCES (CLASS 47) | | | 2 | -48579 | C-141, 142 |
| 1 | | S-108 | 1 | | L-101 | 2 | -48580 | C-109, 110 |
| 1 | | S-109 | 1 | | L-102 | 2 | -48581 | C-143, 144 |
| 1 | | S-110 | 1 | | L-103 | 16 | -48595A | C-116, 117, 119, 121, 124, 125, 126, 127, 130, 131, 132, 134, 135, 136, 137, 138 |
| 1 | | S-111 | 1 | | L-104 | 2 | -48691-D10 | C-112, 118 |
| 1 | | S-112 | 1 | | L-105 | 1 | -48806 | C-146 |
| 1 | | S-113 | 1 | | L-106 | 1 | -48807 | C-147 |
| 1 | | S-114 | 3 | | L-110, 111, 113 | 4 | -48938-10 | C-148, 149, 150, 151 |
| 1 | | S-303 | 1 | | L-112A&B | 1 | | C-105A, B&C |
| PROTECTIVE DEVICES (CLASS 28) | | | 2 | | L-201, 202 | 3 | | C-201, 202, 203 |
| 2 | | F-201, 202 | CAPACITORS (CLASS 48) | | | JACKS & SOCKETS (CLASS 49) | | |
| 2 | | F-301, 302 | 2 | -48341 | C-122, 133 | 3 | -49021 | J-101, 301, 302 |
| A-F TRANSFORMERS & REACTORS (CLASS 30) | | | 1 | -48540A | C-204 | 3 | -49308 | X-104, 105, 106 |
| 1 | -30242A | T-101 | 1 | -48543 | C-129 | 2 | -49311A | X-202, 203 |
| 1 | -30243 | L-109 | 1 | -48549 | C-123 | 3 | -49318 | X-101, 102, 103 |
| | | | | | | 1 | | X-201 |

TABLE III (Continued)
PARTS LIST BY NAVY TYPE NUMBERS
FOR MODEL RAK-7 RADIO RECEIVING EQUIPMENT

| QUAN- TITY | NAVY TYPE NUMBER | ALL SYMBOL DESIGNATIONS INVOLVED | QUAN- TITY | NAVY TYPE NUMBER | ALL SYMBOL DESIGNATIONS INVOLVED | QUAN- TITY | NAVY TYPE NUMBER | ALL SYMBOL DESIGNATIONS INVOLVED |
|----------------------|---------------------|-------------------------------------|----------------------------------|---------------------|-------------------------------------|---------------|---------------------|-------------------------------------|
| FILTERS (CLASS 53) | | | RESISTORS (CLASS 63) (Continued) | | | | | |
| 1 | -53031 | I-107 | 1 | -63429 | R-134 | | | |
| RESISTORS (CLASS 63) | | | 1 | -63430 | R-102 | | | |
| 1 | -63184 | R-201 | 2 | -631628-5 | R-203,204 | | | |
| 1 | -63247 | R-133 | 1 | -631629-5 | R-202 | | | |
| 2 | -63288 | R-104,118 | | | | | | |
| 1 | -63288 | R-126 | | | | | | |
| 1 | -63291 | R-103 | | | | | | |
| 1 | -63355 | R-105 | | | | | | |
| 1 | -63355 | R-116 | | | | | | |
| 1 | -63355 | R-117 | | | | | | |
| 1 | -63355 | R-124 | | | | | | |
| 1 | -63355 | R-125 | | | | | | |
| 1 | -63355 | R-127 | | | | | | |
| 1 | -63355 | R-128 | | | | | | |
| 2 | -63355 | R-129,130 | | | | | | |
| 1 | -63355 | R-131 | | | | | | |
| 1 | -63360 | R-101 | | | | | | |
| 6 | -63360 | R-106,107,110,111,113,115 | | | | | | |
| 2 | -63360 | R-108,112 | | | | | | |
| 1 | -63360 | R-109 | | | | | | |
| 3 | -63360 | R-114,120,121 | | | | | | |
| 2 | -63360 | R-119,122 | | | | | | |
| 1 | -63360 | R-123 | | | | | | |
| 1 | -63426 | R-202 | | | | | | |
| 2 | -63426 | R-203,204 | | | | | | |
| 1 | -63427 | R-132 | | | | | | |

TABLE IV
SPARE PARTS LIST BY NAVY TYPE NUMBERS
FOR MODEL RAK-7 RECEIVING EQUIPMENT
EQUIPMENT SPARES

CONTRACT NXss-19101

| ITEM | BOX NO. | QUAN-TITY | NAVY TYPE NUMBER | ALL SYMBOL DESIGNATIONS INVOLVED | DESCRIPTION | NAVY DRAWING OR SPEC. | MFR. | MFR. DESIG. | SPECIAL TOLER-ANCE, RATING OR MODIFICATION | RCA DRAWING NUMBER |
|---|---------|-----------|------------------|----------------------------------|---|-----------------------|----------|------------------------|--|--------------------|
| MISCELLANEOUS (CLASS 10) | | | | | | | | | | |
| 1 | | 1 | -10012 | | Wrench, spanner, assembly consisting of 2 brass pins 5/32" dia. and brass handle 0.064" thick with 1/2" dia. hole | | 1 73 | | | K-815970-501 |
| 2 | | 8 | | | Clamp, brass, 1.8125" long, used & packed with C-116, 117, 119, 121, 124, 125, 126, 127, 130, 131, 132, 134, 135, 136, 137, 138 | | 1 | | | K-90545-1 |
| 3 | | 1 | | | Spare parts box | | 1 405 | | | P-722263-1 |
| SWITCHES (CLASS 24) | | | | | | | | | | |
| 4 | | 1 | -24000 | S-101, 104 | Switch, toggle, S.P.S.T., rated 1 amp. at 250 v d.c. and 3 amps. at 125 v d.c. | | 7 | Cat. #20994-ET | | M-420278-1 |
| 5 | | 2 | -24001 | S-106, 201 | Switch, toggle, D.P.S.T., rated 1 amp. at 250 v d.c. and 3 amps. at 125 v d.c. | | 7 | Cat. #20902-C | | M-420278-3 |
| 6 | | 2 | -24003 | S-102, 202 | Switch, toggle, D.P.D.T., rated 1 amp. at 250 v d.c. and 3 amps. at 125 v d.c. | | 7 | Cat. #20905-EP | | M-420278-4 |
| PROTECTIVE DEVICES (CLASS 28) | | | | | | | | | | |
| 7 | | 1 | | F-201, 202 | Fuse, glass body, 3 amps. up to 250 v | 17-F-2e | 26 | Cat. #1043 Type 3AG | | K-811485-12 |
| TRANSFORMERS & REACTORS (CLASS 30) | | | | | | | | | | |
| 8 | | 1 | -30242A | T-101 | Transformer, output, consisting of primary and secondary with midtap | | 1 | Type RT-354 | | M-80158-501 |
| 9 | | 1 | -30243 | L-109 | Reactor, impregnated and sealed in can | | 1 | Type RT-351 | | M-80157-501 |
| 10 | | 1 | -30244 | T-102 | Transformer, AVC, consisting of primary and 2 secondaries | | 1 | Type RT-355 | | M-80159-501 |
| *VACUUM TUBES (CLASS 38) | | | | | | | | | | |
| 68 | | 4 | -6D6 | V-101, 102, 103, 104 | Vacuum tube, triple-grid super-control amplifier, small metal cap, small 6 pin base, heater: 6.3 v a.c. or d.c. at 0.3 amp. | RE 13A 600A | 1a | -6D6 | | |
| 69 | | 1 | -5Z3 | V-202 | Vacuum tube, full-wave, high vacuum rectifier, medium 4 pin base, heater: 5.0 v a.c. at 3.0 amps. | RE 13A 600A | 1a | -5Z3 | | |
| 70 | | 2 | -41 | V-105, 106 | Vacuum tube, power amplifier pentode, small 6 pin base, heater: 6.3 v a.c. or d.c. at 0.4 amp. | RE 13A 600A | 1a | -41 | | |

* To be packed separately.

For IB-38219
Series ABC

TABLE IV (Continued)
 SPARE PARTS LIST BY NAVY TYPE NUMBERS
 FOR MODEL RAK-7 RECEIVING EQUIPMENT
 EQUIPMENT SPARES

| ITEM | BOX NO. | QUANTITY | NAVY TYPE NUMBER | ALL SYMBOL DESIGNATIONS INVOLVED | DESCRIPTION | NAVY DRAWING OR SPEC. | MFR. | MFR. DESIG. | SPECIAL TOLERANCE, RATING OR MODIFICATION | RCA DRAWING NUMBER |
|---|---------|----------|------------------|----------------------------------|--|-----------------------|---------|--------------|---|--------------------|
| *VACUUM TUBES (CLASS 38) (Continued) | | | | | | | | | | |
| 71 | | 1 | -874 | V-203 | Vacuum tube, voltage regulator, medium 4 pin bayonet base, rated voltage 90 v d.c., operating current 10 to 50 d.c. ma | RE 13A 600A | 1a | -874 | | |
| 72 | | 1 | -876 | V-201 | Vacuum tube, current regulator, mogul screw base, voltage range 40 to 60 v, operating current 1.7 amps., ambient temperature 150° F. | RE 13A 600A | 1a | -876 | | |
| CAPACITORS (CLASS 48) | | | | | | | | | | |
| 11 | | 1 | -48341 | C-122,133 | Capacitor, molded, fixed, bakelite, 0.01 mfd $\pm 10\%$, 500 v d.c. working | | 2 | Type #1455 | | K-30090-3 |
| 12 | | 1 | -48540A | C-204 | Capacitor, fixed, paper, oil filled, 3 sections, 3/3/3 mfd $\pm 10\%$, 400 v d.c. working | | 1 | | | P-72014-507 |
| 13 | | 1 | -48543 | C-129 | Capacitor, molded, fixed, bakelite, 0.002 mfd $\pm 10\%$, 500 v d.c. working | | 2 | Type #1455 | | K-30090-5 |
| 14 | | 1 | -48549 | C-123 | Capacitor, fixed, mica, 0.0001 mfd $\pm 5\%$, 500 v d.c. working | | 1 | | | P-32170-518 |
| 15 | | 1 | -48554 | C-114A&B | Capacitor, fixed, oil filled, 2 sections, 0.5/0.5 mfd $\pm 10\%$, 250 v d.c. working | | 1 | | | P-721074-53 |
| 16 | | 2 | -48556 | C-108A&B, 113A&B, 115A&B, 120A&B | Capacitor, fixed, oil filled, 2 sections, 0.5/0.5 mfd $\pm 10\%$, 250 v d.c. working | RE 13A 488 | 1 | | | P-721074-57 |
| 17 | | 1 | -48557 | C-128 | Capacitor, molded, fixed, bakelite, 0.001 mfd $\pm 10\%$, 500 v d.c. working | | 2 | Type #1455 | | K-30090-10 |
| 18 | | 1 | -48558 | C-101 | Capacitor, molded, fixed, mica, 300 mmfd $\pm 10\%$, 500 v d.c. working | RE 48A 154 | 2 34 | 1468S MOW | | P-720592-35 |
| 19 | | 1 | -48562 | C-145 | Capacitor, molded, fixed, mica, 900 mmfd $\pm 10\%$, 500 v d.c. working | RE 48A 154 | 1 | | | M-86016-533 |
| 20 | | 1 | -48568 | C-103 | Capacitor, molded, fixed, mica, 805 mmfd $\pm 5\%$, 500 v d.c. working | RE 48A 154 | 1 | | | M-86016-503 |
| 21 | | 1 | -48569 | C-104 | Capacitor, molded, fixed, mica, 62 mmfd $\pm 2\%$, 500 v d.c. working | RE 48A 154 | 1 | | | M-86016-504 |

* To be packed separately.

C

TABLE IV (Continued)
SPARE PARTS LIST BY NAVY TYPE NUMBERS
FOR MODEL RAK-7 RECEIVING EQUIPMENT
EQUIPMENT SPARES

| ITEM | BOX NO. | QUANTITY | NAVY TYPE NUMBER | ALL SYMBOL DESIGNATIONS INVOLVED | DESCRIPTION | NAVY DRAWING OR SPEC. | MFR. | MFR. DESIG. | SPECIAL TOLERANCE, RATING OR MODIFICATION | RCA DRAWING NUMBER |
|--|---------|----------|------------------|--|--|-----------------------|-----------|-------------------|---|--------------------|
| CAPACITORS (CLASS 48) (Continued) | | | | | | | | | | |
| 22 | | 1 | -48570 | C-139 | Capacitor, molded, fixed, mica. 45.4 mmfd $\pm 2\%$, 500 v d.c. working | | 1 | | | M-86016-505 |
| 23 | | 1 | -48572 | C-102 | Capacitor, molded, fixed, mica, 1190 mmfd $\pm 5\%$, 500 v d.c. working | | 1 | | | M-86016-507 |
| 24 | | 8 | -48595A | C-116, 117, 119, 121, 124, 125, 126, 127, 130, 131, 132, 134, 135, 136, 137, 138 | Capacitor, fixed, oil filled, 1.00 mfd $\pm 10\%$, 400 v d.c. working, (one clamp, item 2, to be used and packed with each capacitor) | RE 13A 488 | 1 | | | P-720555-52 |
| 25 | | 1 | -48691-D10 | C-112, 118 | Capacitor, molded, fixed, mica, 500 mmfd $\pm 10\%$, 500 v d.c. working | RE 48A 154 | 13 2 | 5RS Type #1469 | | P-720473-8 |
| 26 | | 1 | -48806 | C-146 | Capacitor, fixed, oil filled, 0.025 mfd -3% $+10\%$, 600 v d.c. working | | 1 | | | P-721074-4 |
| 27 | | 1 | -48807 | C-147 | Capacitor, fixed, oil filled, 0.075 mfd -3% $+10\%$, 600 v d.c. working | | 1 | | | P-721074-5 |
| 28 | | 2 | -48938-10 | C-148, 149, 150, 151 | Capacitor, molded, fixed, mica, 10,000 mmfd $\pm 10\%$, 300 v d.c. working | RE 48A 154 | 13 2 | 3WS | | P-720473-15 |
| *28a | | 2 | | C-201, 202, 203 | Capacitor, fixed, molded, mica, 0.01 mfd $\pm 10\%$, 600 v d.c. working | | 2 | | For Replacement Use CM-45A-103K | P-720567-22 |
| SOCKETS (CLASS 49) | | | | | | | | | | |
| 29 | | 2 | -49308 | X-104, 105, 106 | Socket, tube, 6 contacts | | 1 690 | | | M-401806-503 |
| 30 | | 1 | -49311A | X-202, 203 | Socket, tube, 4 contacts, wafer type, phenolic base with shock mounting end supports | | 1 | | | M-401485-502 |
| 31 | | 2 | -49318 | X-101, 102, 103 | Socket, tube, 6 contacts, wafer type, ceramic base | RE 13A 317B | 19 690 | S-1 | Less spacers and washers | K-856936-3 |
| RESISTORS (CLASS 63) | | | | | | | | | | |
| 32 | | 1 | -63184 | R-201 | Resistor, vitreous enamel, 80 ohms $\pm 10\%$, 200 watts | RE 13A 372G | 37 | | | K-806810-2 |
| 33 | | 1 | -63247 | R-133 | Potentiometer, 25,000 ohms $\pm 15\%$, 2 watts | | 40 | | | K-806741-2 |
| 34 | | 1 | -63288 | R-126 | Resistor, composition, 4700 ohms $\pm 10\%$, 1 watt, insulated | | 21 | Type BT-1 | | K-844314-70 |
| 35 | | 1 | -63288 | R-104, 118 | Resistor, composition, 10,000 ohms $\pm 10\%$, 1 watt, insulated | | 21 | Type BT-1 | | K-844314-74 |

* If Item 28a is not available, the same quantity of Item 11 may be substituted.

BC

TABLE IV (Continued)
 SPARE PARTS LIST BY NAVY TYPE NUMBERS
 FOR MODEL RAK-7 RECEIVING EQUIPMENT
 EQUIPMENT SPARES

| ITEM | BOX NO. | QUANTITY | NAVY TYPE NUMBER | ALL SYMBOL DESIGNATIONS INVOLVED | DESCRIPTION | NAVY DRAWING OR SPEC. | MFR. | MFR. DESIG. | SPECIAL TOLERANCE, RATING OR MODIFICATION | RCA DRAWING NUMBER |
|---|---------|----------|------------------|----------------------------------|---|-----------------------|------|-------------|---|--------------------|
| RESISTORS (CLASS 63) (Continued) | | | | | | | | | | |
| 36 | | 1 | -63291 | R-103 | Resistor, composition, 5100 ohms $\pm 5\%$, 1 watt, insulated | | 21 | Type BT-1 | | K-844314-176 |
| 37 | | 1 | -63355 | R-105 | Resistor, composition, 510 ohms $\pm 5\%$, 1/2 watt, insulated | | 21 | Type BT-1/2 | | K-850981-152 |
| 38 | | 1 | -63355 | R-127 | Resistor, composition, 620 ohms $\pm 5\%$, 1/2 watt, insulated | | 21 | Type BT-1/2 | | K-850981-154 |
| 39 | | 1 | -63355 | R-131 | Resistor, composition, 3900 ohms $\pm 5\%$, 1/2 watt, insulated | | 21 | Type BT-1/2 | | K-850981-173 |
| 40 | | 1 | -63355 | R-129,130 | Resistor, composition, 11,000 ohms $\pm 5\%$, 1/2 watt, insulated | | 21 | Type BT-1/2 | | K-850981-184 |
| 41 | | 1 | -63355 | R-128 | Resistor, composition, 12,000 ohms $\pm 5\%$, 1/2 watt, insulated | | 21 | Type BT-1/2 | | K-850981-185 |
| 42 | | 1 | -63355 | R-125 | Resistor, composition, 20,000 ohms $\pm 5\%$, 1/2 watt, insulated | | 21 | Type BT-1/2 | | K-850981-190 |
| 43 | | 1 | -63355 | R-116 | Resistor, composition, 24,000 ohms $\pm 5\%$, 1/2 watt, insulated | | 21 | Type BT-1/2 | | K-850981-192 |
| 44 | | 1 | -63355 | R-117 | Resistor, composition, 51,000 ohms $\pm 5\%$, 1/2 watt, insulated | | 21 | Type BT-1/2 | | K-850981-200 |
| 45 | | 1 | -63355 | R-124 | Resistor, composition, 390,000 ohms $\pm 5\%$, 1/2 watt, insulated | | 21 | Type BT-1/2 | | K-850981-221 |
| 46 | | 1 | -63360 | R-109 | Resistor, composition, 270 ohms $\pm 10\%$, 1/2 watt, insulated | | 21 | Type BT-1/2 | | K-850981-55 |
| 47 | | 1 | -63360 | R-101 | Resistor, composition, 560 ohms $\pm 10\%$, 1/2 watt, insulated | | 21 | Type BT-1/2 | | K-850981-59 |
| 48 | | 1 | -63360 | R-123 | Resistor, composition, 1000 ohms $\pm 10\%$, 1/2 watt, insulated | | 21 | Type BT-1/2 | | K-850981-62 |
| 49 | | 3 | -63360 | R-106,107,110,111,113,115 | Resistor, composition, 10,000 ohms 1/2 watt, insulated | | 21 | Type BT-1/2 | | K-850981-74 |

TABLE IV (Continued)
 SPARE PARTS LIST BY NAVY TYPE NUMBERS
 FOR MODEL RAK-7 RECEIVING EQUIPMENT
 EQUIPMENT SPARES

| ITEM | BOX NO. | QUAN- TITY | NAVY TYPE NUMBER | ALL SYMBOL DESIGNATIONS INVOLVED | DESCRIPTION | NAVY DRAWING OR SPEC. | MFR. | MFR. DESIG. | SPECIAL TOLER- ANCE, RATING OR MODIFICATION | RCA DRAWING NUMBER |
|---|---------|------------|------------------|----------------------------------|--|-----------------------|------|-------------|---|--------------------|
| RESISTORS (CLASS 63) (Continued) | | | | | | | | | | |
| 50 | | 2 | -63360 | R-114,120,121 | Resistor, composition, 100,000 ohms $\pm 10\%$, 1/2 watt, insulated | | 21 | Type BT-1/2 | | K-850981-86 |
| 51 | | 1 | -63360 | R-119,122 | Resistor, composition, 1.0 megohm $\pm 10\%$, 1/2 watt, insulated | | 21 | Type BT-1/2 | | K-850981-98 |
| 52 | | 1 | -63360 | R-108,112 | Resistor, composition, 4.7 megohms $\pm 10\%$, 1/2 watt, insulated | | 21 | Type BT-1/2 | | K-850981-106 |
| 53 | | 1 | -63427 | R-132 | Potentiometer, 1000 ohms $\pm 10\%$ | | 28 | SPO #7151 | | K-815823-1 |
| 54 | | 1 | -63429 | R-134 | Potentiometer, 20,000 ohms $\pm 10\%$, 2 watts | | 40 | | | K-806741-7 |
| 55 | | 1 | -63430 | R-102 | Potentiometer, 5000 ohms $\pm 10\%$ | | 40 | | | K-806741-8 |
| 56 | | 1 | -631628-5 | R-203,204 | Resistor, composition, 6200 ohms $\pm 5\%$, 4 watts | | 617 | | | K-880984-1 |
| 57 | | 1 | -631629-5 | R202 | Resistor, composition, 20,000 ohms $\pm 5\%$, 4 watts | | 617 | | | K-880984-2 |

TABLE IV
SPARE PARTS LIST BY NAVY TYPE NUMBERS
FOR MODEL RAK-7 RECEIVING EQUIPMENT
BASE SPARES

CONTRACT NXss-19101

| ITEM NO. | BOX NO. | QUANTITY | NAVY TYPE NUMBER | ALL SYMBOL DESIGNATIONS INVOLVED | DESCRIPTION | NAVY DRAWING OR SPEC. | MFR. | MFR. DESIG. | SPECIAL TOLERANCE, RATING OR MODIFICATION | RCA DRAWING NUMBER | | | | | | | | | | | | | | | | | | | | | | | | | | | | | | | | | | | | | | | | |
|--|--------------|-----------------|------------------|----------------------------------|--|-----------------------|----------|-----------------|---|--------------------|------|------|---------|-----|---------|---------|---------|---------|--|--|------|-----------|--|--|-------|-------|--------------|--------------|-------|------------|------|----------------|-----|--|------------|--|--|-----------|------|-----------------|------|--|------------|--|--|--|--|--|--|--|
| MISCELLANEOUS (CLASS 10) | | | | | | | | | | | | | | | | | | | | | | | | | | | | | | | | | | | | | | | | | | | | | | | | | | |
| 57a | | 6 | | | Lamp, bayonet base, clear, 6-8 v, 0.25 amp. | | 18 | | | K-61114-15 | | | | | | | | | | | | | | | | | | | | | | | | | | | | | | | | | | | | | | | | |
| 57b | | 1 | | | Adapter assembly | | 1 | | | K-883492-501 | | | | | | | | | | | | | | | | | | | | | | | | | | | | | | | | | | | | | | | | |
| ELECTRICAL MEASURING DEVICES (CLASS 22) | | | | | | | | | | | | | | | | | | | | | | | | | | | | | | | | | | | | | | | | | | | | | | | | | | |
| 58 | | 1 | -22152 | M-101 | Meter, output, range -10.0 to +5 db with divisions each 2 db on minus side and each 1 db on plus side, calibration accuracy $\pm 5\%$, impedance 600 ohms, d-c resistance 5000 ohms $\pm 5\%$ | 17-I-12a | 18 38 | 8DW-46 NC-33 | | M-420279-5 | | | | | | | | | | | | | | | | | | | | | | | | | | | | | | | | | | | | | | | | |
| 59 | | 1 | -22246 | M-102 | Voltmeter, A.C./D.C., calibration accuracy $\pm 2\%$ over full scale for a.c. 15-100 cycles, and $\pm 2\%$ from 5-7 v d.c. | 17-I-12a | 18 38 | 8AW-41 NA-33 | | M-420279-6 | | | | | | | | | | | | | | | | | | | | | | | | | | | | | | | | | | | | | | | | |
| TRANSFORMERS & REACTORS (CLASS 30) | | | | | | | | | | | | | | | | | | | | | | | | | | | | | | | | | | | | | | | | | | | | | | | | | | |
| 60 | | 1 | -30246 | L-205 | Reactor, filter, assembly | | 1 | | | M-406261-503 | | | | | | | | | | | | | | | | | | | | | | | | | | | | | | | | | | | | | | | | |
| 61 | | 1 | -30247 | L-204 | Reactor, filter, assembly | | 1 | | | M-406261-504 | | | | | | | | | | | | | | | | | | | | | | | | | | | | | | | | | | | | | | | | |
| 62 | | 1 | -30248 | I-203 | Filter reactor, impregnated and sealed in can | | 1 | RT-347 | | P-705254-503 | | | | | | | | | | | | | | | | | | | | | | | | | | | | | | | | | | | | | | | | |
| 63 | | 1 | -30343 | L-108 | Attenuator, A-F variable, assembly | | 1 | RT-528 | | P-72397-502 | | | | | | | | | | | | | | | | | | | | | | | | | | | | | | | | | | | | | | | | |
| 64 | | 1 | -30444 | T-201 | Transformer, power, impregnated and sealed in can, hi-pot 2500 v max. core loss 5.0 watts, max. exciting current 0.3 amp. at 120 v 60 cycles, induced voltage 480 v, 500 cycles | | 1 | | | K-900536-501 | | | | | | | | | | | | | | | | | | | | | | | | | | | | | | | | | | | | | | | | |
| | | | | | <table style="margin-left: 40px;"> <tr> <td></td> <td>No</td> <td>Rated</td> <td></td> </tr> <tr> <td>Wind-</td> <td>Load</td> <td>Load</td> <td>Current</td> </tr> <tr> <td>ing</td> <td>Voltage</td> <td>Voltage</td> <td>(Amps.)</td> </tr> <tr> <td>Pri. #1</td> <td></td> <td></td> <td>1.08</td> </tr> <tr> <td>Pri. #1&2</td> <td></td> <td></td> <td>0.615</td> </tr> <tr> <td>Plate</td> <td>498\pm15</td> <td>460\pm14</td> <td>0.085</td> </tr> <tr> <td>Rect. Fil.</td> <td>5.57</td> <td>5.0\pm0.15</td> <td>3.0</td> </tr> <tr> <td></td> <td>\pm0.17</td> <td></td> <td></td> </tr> <tr> <td>Amp. Fil.</td> <td>7.16</td> <td>6.5\pm0.195</td> <td>2.12</td> </tr> <tr> <td></td> <td>\pm0.21</td> <td></td> <td></td> </tr> </table> | | No | Rated | | Wind- | Load | Load | Current | ing | Voltage | Voltage | (Amps.) | Pri. #1 | | | 1.08 | Pri. #1&2 | | | 0.615 | Plate | 498 \pm 15 | 460 \pm 14 | 0.085 | Rect. Fil. | 5.57 | 5.0 \pm 0.15 | 3.0 | | \pm 0.17 | | | Amp. Fil. | 7.16 | 6.5 \pm 0.195 | 2.12 | | \pm 0.21 | | | | | | | |
| | No | Rated | | | | | | | | | | | | | | | | | | | | | | | | | | | | | | | | | | | | | | | | | | | | | | | | |
| Wind- | Load | Load | Current | | | | | | | | | | | | | | | | | | | | | | | | | | | | | | | | | | | | | | | | | | | | | | | |
| ing | Voltage | Voltage | (Amps.) | | | | | | | | | | | | | | | | | | | | | | | | | | | | | | | | | | | | | | | | | | | | | | | |
| Pri. #1 | | | 1.08 | | | | | | | | | | | | | | | | | | | | | | | | | | | | | | | | | | | | | | | | | | | | | | | |
| Pri. #1&2 | | | 0.615 | | | | | | | | | | | | | | | | | | | | | | | | | | | | | | | | | | | | | | | | | | | | | | | |
| Plate | 498 \pm 15 | 460 \pm 14 | 0.085 | | | | | | | | | | | | | | | | | | | | | | | | | | | | | | | | | | | | | | | | | | | | | | | |
| Rect. Fil. | 5.57 | 5.0 \pm 0.15 | 3.0 | | | | | | | | | | | | | | | | | | | | | | | | | | | | | | | | | | | | | | | | | | | | | | | |
| | \pm 0.17 | | | | | | | | | | | | | | | | | | | | | | | | | | | | | | | | | | | | | | | | | | | | | | | | | |
| Amp. Fil. | 7.16 | 6.5 \pm 0.195 | 2.12 | | | | | | | | | | | | | | | | | | | | | | | | | | | | | | | | | | | | | | | | | | | | | | | |
| | \pm 0.21 | | | | | | | | | | | | | | | | | | | | | | | | | | | | | | | | | | | | | | | | | | | | | | | | | |

TABLE V
 APPLICABLE COLOR CODES
 FOR MODEL RAK-7 RADIO RECEIVING EQUIPMENT

RMA COLOR CODES FOR CAPACITORS (MMFD)

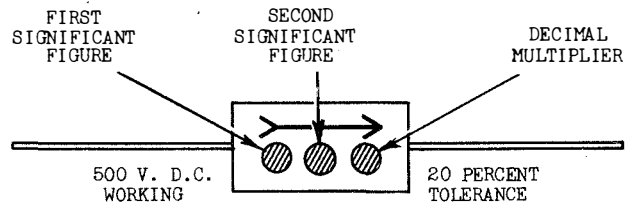

| COLOR | NUMERAL | VOLTS | MULTIPLIER | TOLERANCE |
|----------|---------|-------|---------------|-----------|
| BLACK | 0 | | 1 | |
| BROWN | 1 | 100 | 10 | 1% |
| RED | 2 | 200 | 100 | 2% |
| ORANGE | 3 | 300 | 1,000 | 3% |
| YELLOW | 4 | 400 | 10,000 | 4% |
| GREEN | 5 | 500 | 100,000 | 5% |
| BLUE | 6 | 600 | 1,000,000 | 6% |
| VIOLET | 7 | 700 | 10,000,000 | 7% |
| GRAY | 8 | 800 | 100,000,000 | 8% |
| WHITE | 9 | 900 | 1,000,000,000 | 9% |
| GOLD | | 1000 | 0.1 | 5% |
| SILVER | | 2000 | 0.01 | 10% |
| NO COLOR | | 500 | | 20% |

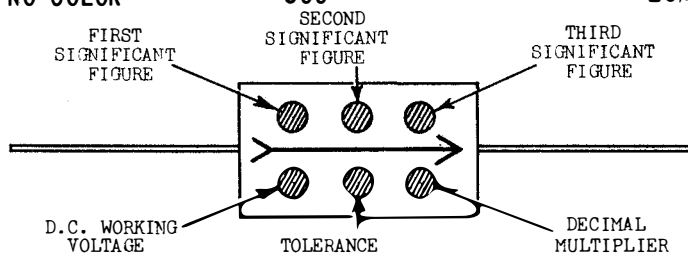

RADIO CORP. OF AMERICA COLOR CODE FOR CAPACITORS

CAPACITY VALUES IN MMFD. ARE MARKED IN COLORS DESIGNATING TOLERANCE, THUS:
 YELLOW = 20%
 BLUE = 10% BLACK = 5% GREEN = 2.5%

RMA COLOR CODE FOR RESISTORS (OHMS)

| COLOR | A 1ST DIGIT | B 2ND DIGIT | C MULTIPLIER |
|--------|----------------|----------------|-----------------|
| SILVER | | | 0.01 |
| GOLD | | | 0.1 |
| BLACK | | 0 | 1.0 |
| BROWN | 1 | 1 | 10 |
| RED | 2 | 2 | 100 |
| ORANGE | 3 | 3 | 1,000 |
| YELLOW | 4 | 4 | 10,000 |
| GREEN | 5 | 5 | 100,000 |
| BLUE | 6 | 6 | 1,000,000 |
| PURPLE | 7 | 7 | 10,000,000 |
| GRAY | 8 | 8 | 100,000,000 |
| WHITE | 9 | 9 | |

D - TOLERANCE CODE:

GOLD = 5% SILVER = 10% NO COLOR = 20%

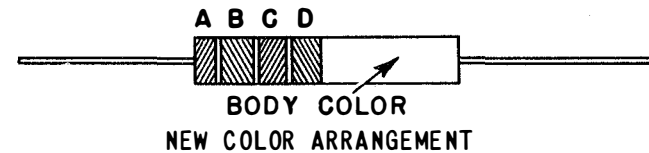
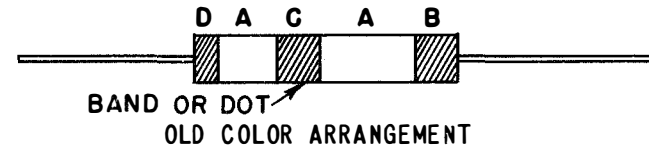

BODY COLOR (NEW COLOR ARRANGEMENT ONLY) INDICATES TYPE OF RESISTOR, AS FOLLOWS:-

- BLACK - COMPOSITION, NON-INSULATED
- TAN, OLIVE OR WHITE - COMPOSITION, INSULATED
- DARK BROWN - WIRE-WOUND, INSULATED

TABLE VI
LIST OF MANUFACTURERS
FOR MODEL RAK-7 RADIO RECEIVING EQUIPMENT

| CODE NUMBER | MFR. PREFIX | NAME | ADDRESS | CODE NUMBER | MFR. PREFIX | NAME | ADDRESS |
|-------------|-------------|---|--|-------------|-------------|---|---|
| 1 | CRV | Radio Corporation of America | Camden, N.J. | 39 | CV | Weston Electric Instrument Co. | Newark, N.J. |
| 1a | CRC | Radio Corporation of America | Harrison, N.J. | 40 | CWC | Wirt Co. | 5221 Greene Street, Philadelphia, Pa. |
| 2 | CAW | Aerovox Wireless Corp. | 742 Belleville Avenue, New Bedford, Mass. | 73 | CND | Andrea Radio Corp. | 48-02 - 48th Avenue, Woodside, Long Island, N.Y. |
| 7 | CHH | Arrow-Hart & Hegeman Electric Co. | 102 Hawthorne Street, Hartford, Conn. | 82 | | Aluminum Goods Mfg. Co. | Manitowoc, Wis. |
| 8 | | Bryant Electric Co. | Bridgeport, Conn. | 121 | CFA | Bussman Mfg. Co. | 2538 University Street, St. Louis, Mo. |
| 13 | CD | Cornell-Dubilier Electric Corp. | 1000 Hamilton Blvd., S. Plainfield, N.J. | 405 | | Karp Mfg. Co. | 120 - 30th Street, Brooklyn, N.Y. |
| 16 | CER | Erie Resistor Corp. | 644 W. 12th Street, Erie, Pa. | 617 | CPQ | Speer Resistor Corp. | Theresa Street, St. Mary's, Pa. |
| 18 | CG | General Electric Co. | Schenectady, N.Y. | 637 | CCT | Stromberg-Carlson Telephone Mfg. Co. | 100 Carlson Road, Rochester, N.Y. |
| 19 | CHC | Hammarlund Mfg. Co. | 460 W. 34th Street, New York, N.Y. | 690 | CUF | Ucinite Co., Division of United Can Fastener Co. | 1 Nevada Street, Newtonville, Mass. |
| 20 | CHD | Hardwick Hindle, Inc. | 40 Hermon Street, Newark, N.J. | | | | |
| 21 | CIR | International Resistance Corp. | 401 N. Broad Street, Philadelphia, Pa. | | | | |
| 26 | CLF | Littelfuse Lab. | 4757 N. Ravenswood Avenue, Chicago, Ill. | | | | |
| 28 | CMA | P.R. Mallory & Co., Inc. (Yaxley Division) | 3029 E. Washington Street, Indianapolis, Ind. | | | | |
| 29 | CMR | Micamold Radio Corp. | 1087 Flushing Avenue, Brooklyn, N.Y. | | | | |
| 31 | COC | Oak Mfg. Co. | 1200 N. Clybourne Avenue, Chicago, Ill. | | | | |
| 32 | COM | Ohmite Mfg. Co. | 4837 W. Flournoy Street, Chicago, Ill. | | | | |
| 34 | CSL | Solar Mfg. Co. | 588 Avenue A, Bayonne, N.J. | | | | |
| 37 | CAO | Ward Leonard Electric Co. | 6 South Street, Mt. Vernon, N.Y. | | | | |
| 38 | CAY | Westinghouse Electric & Mfg. Co. | 3001 Walnut Street, Philadelphia, Pa. | | | | |

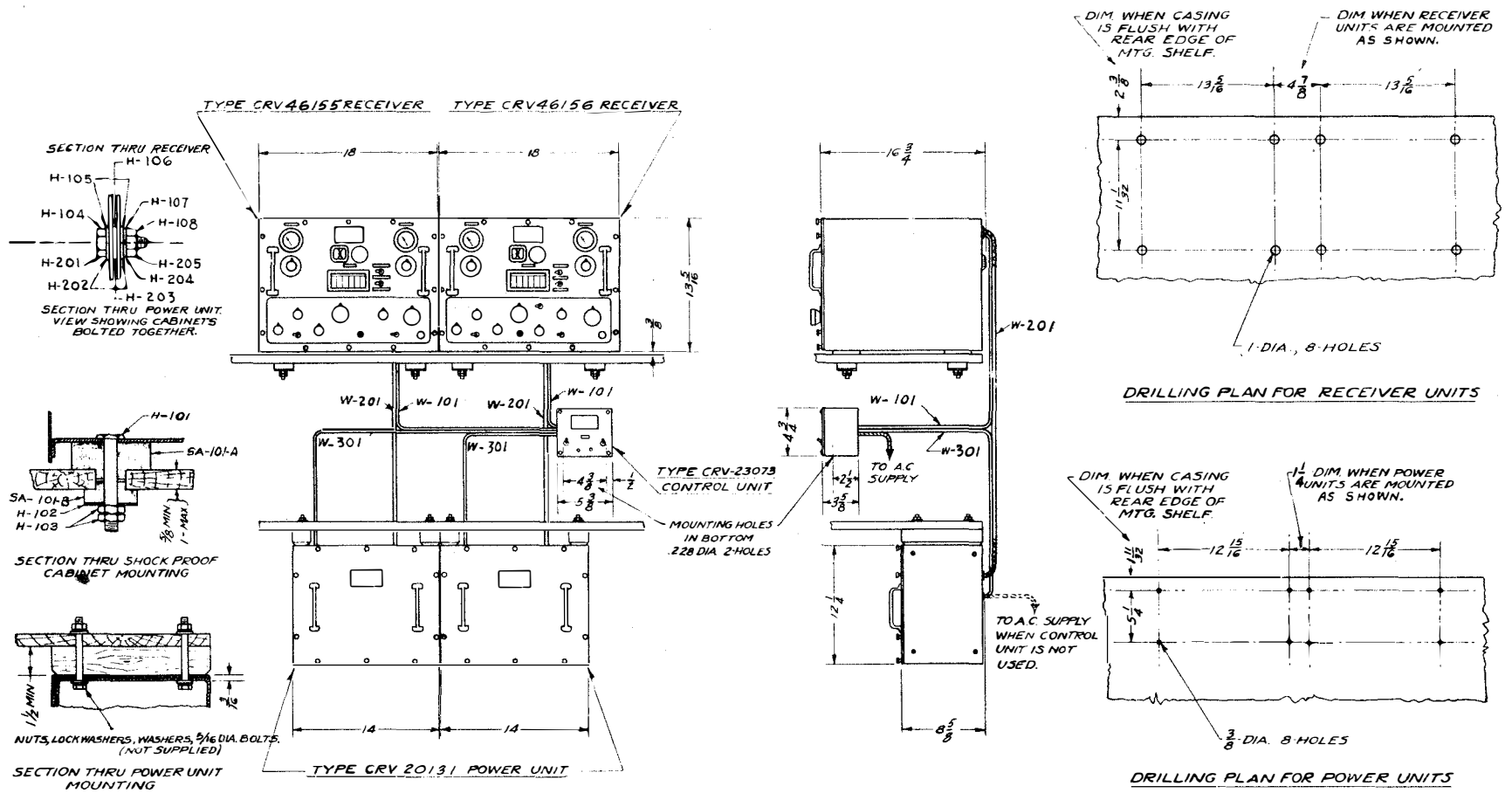
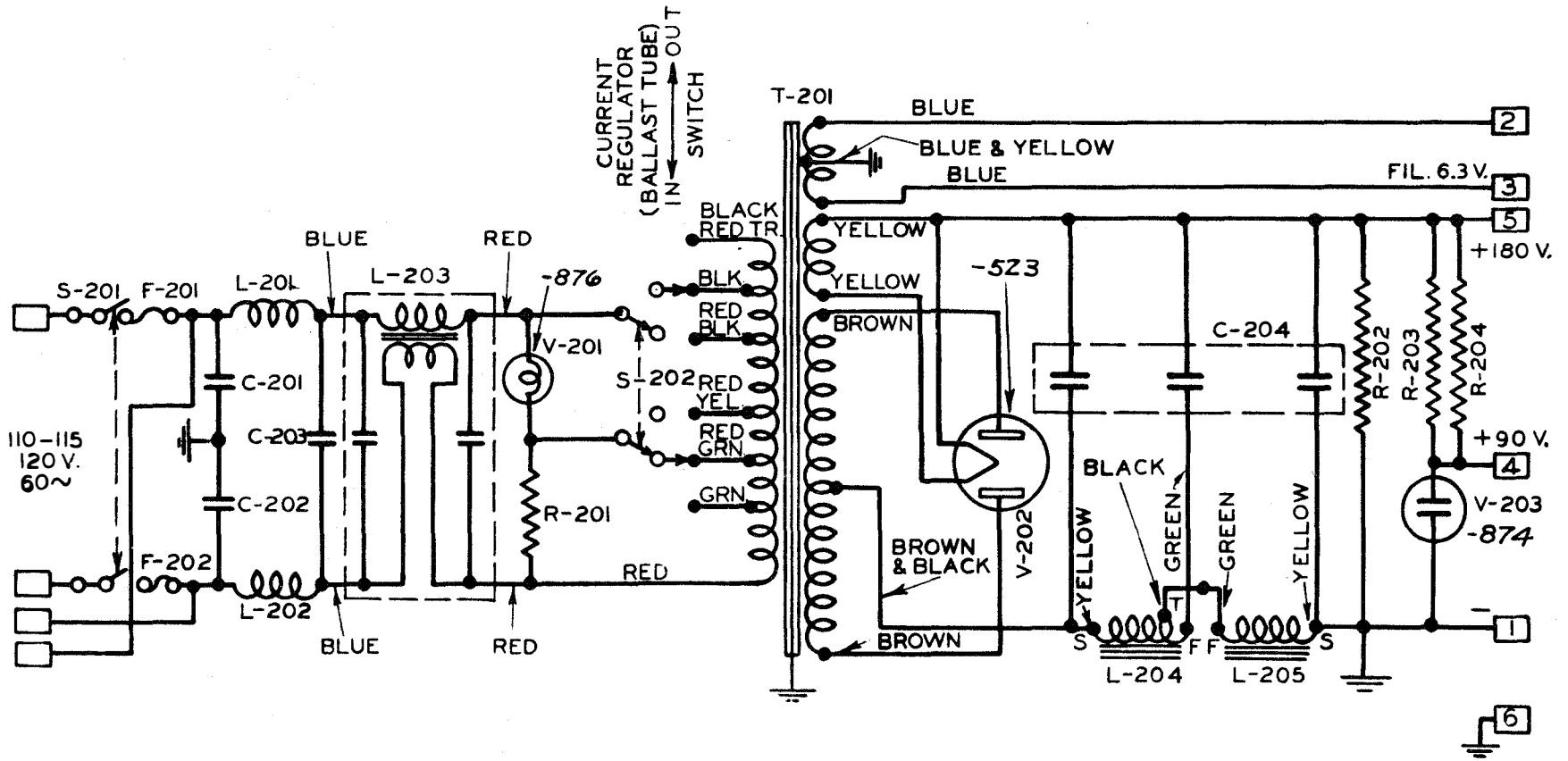

Figure 14—Outline and Installation
(P-720164)

Figure 17—Schematic Diagram,
Power Unit CRV-20131 (M-422922)



CURRENT
REGULATOR
(BALLAST TUBE)
IN ← SWITCH → OUT

FIL. 6.3V.

+180 V.

+90 V.

V-203
-874

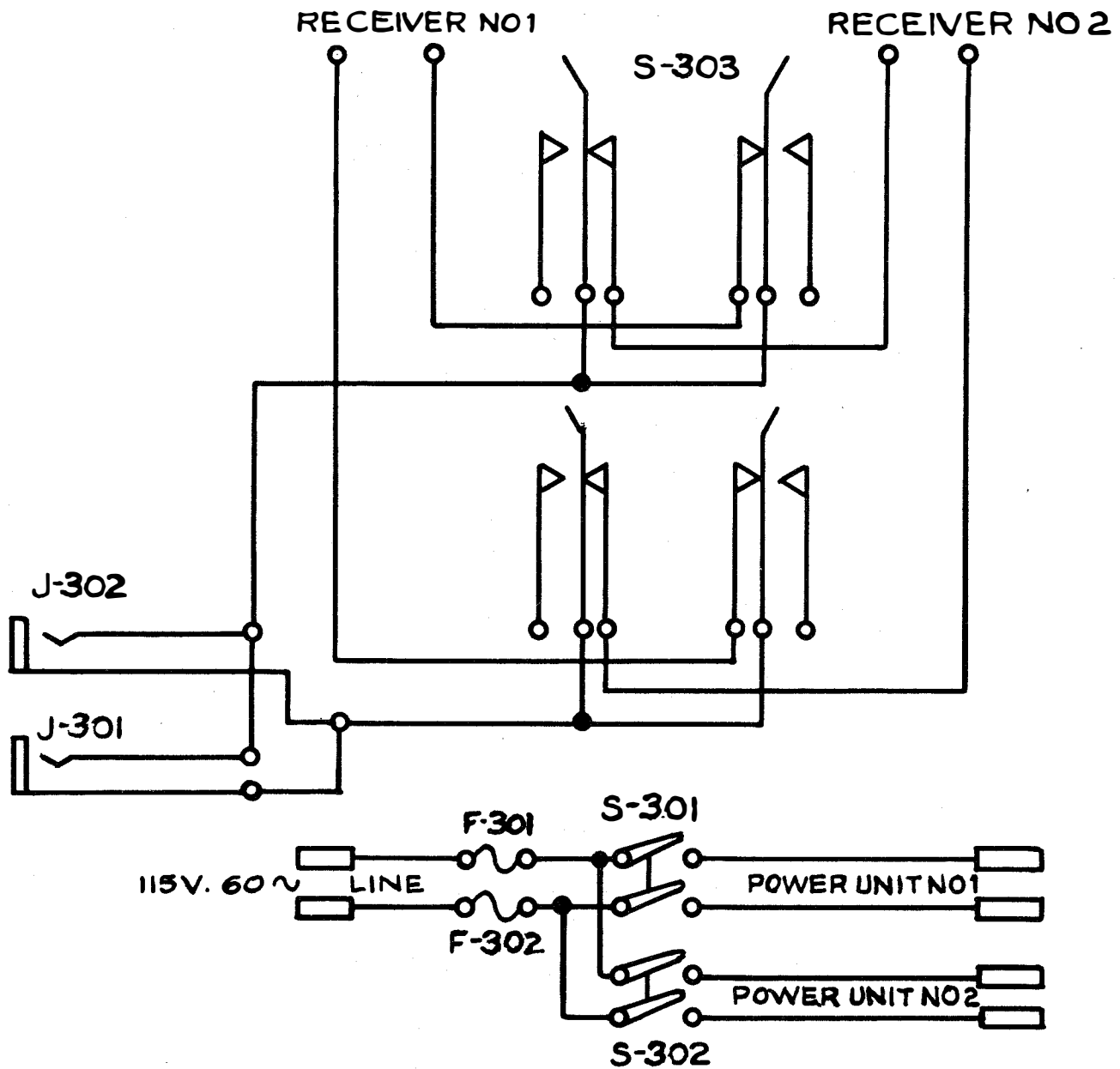

Figure 18—Schematic Diagram,
Control Unit CRV-23073 (M-407021)

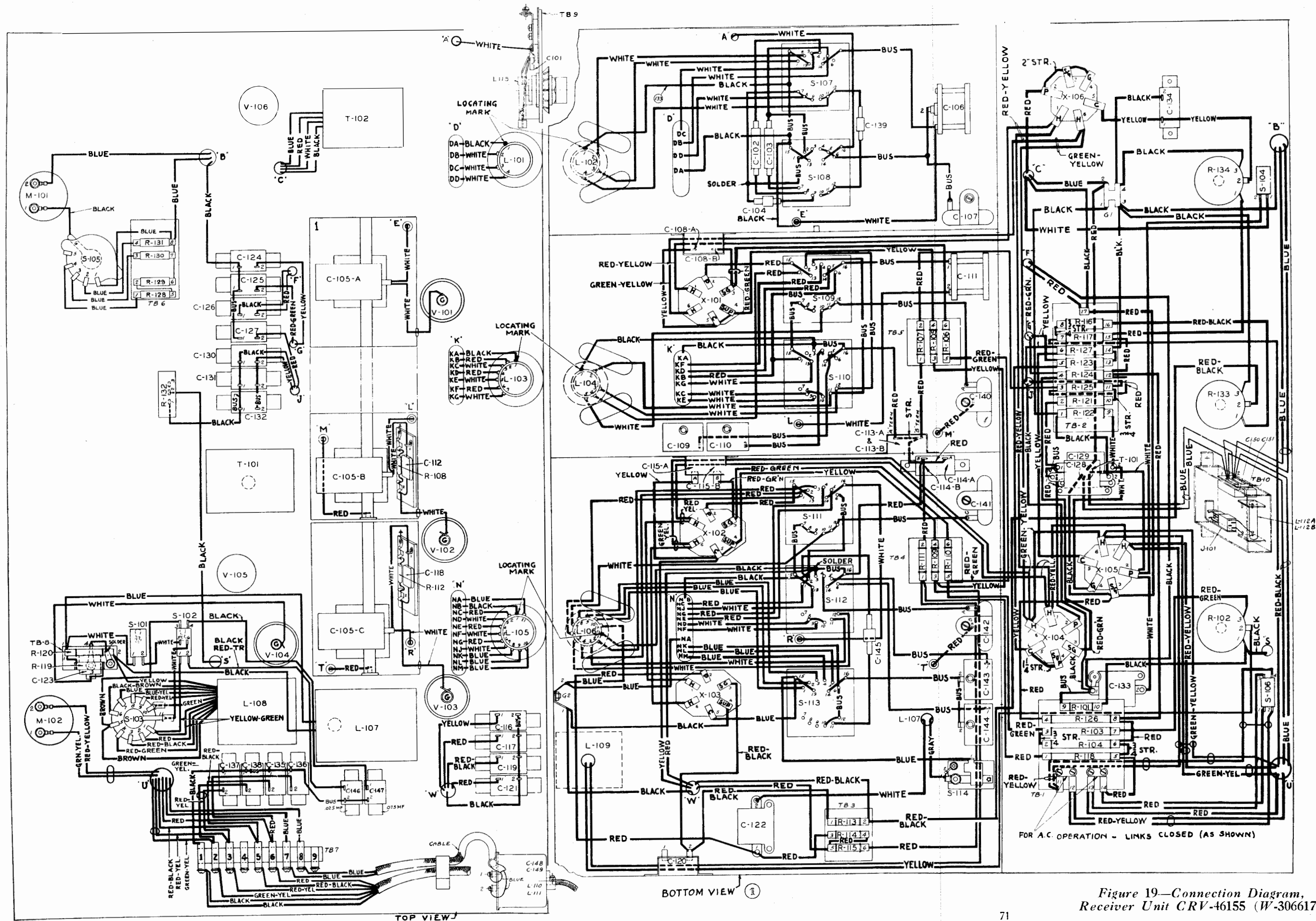

Figure 19—Connection Diagram, Receiver Unit CRV-46155 (W-306617)



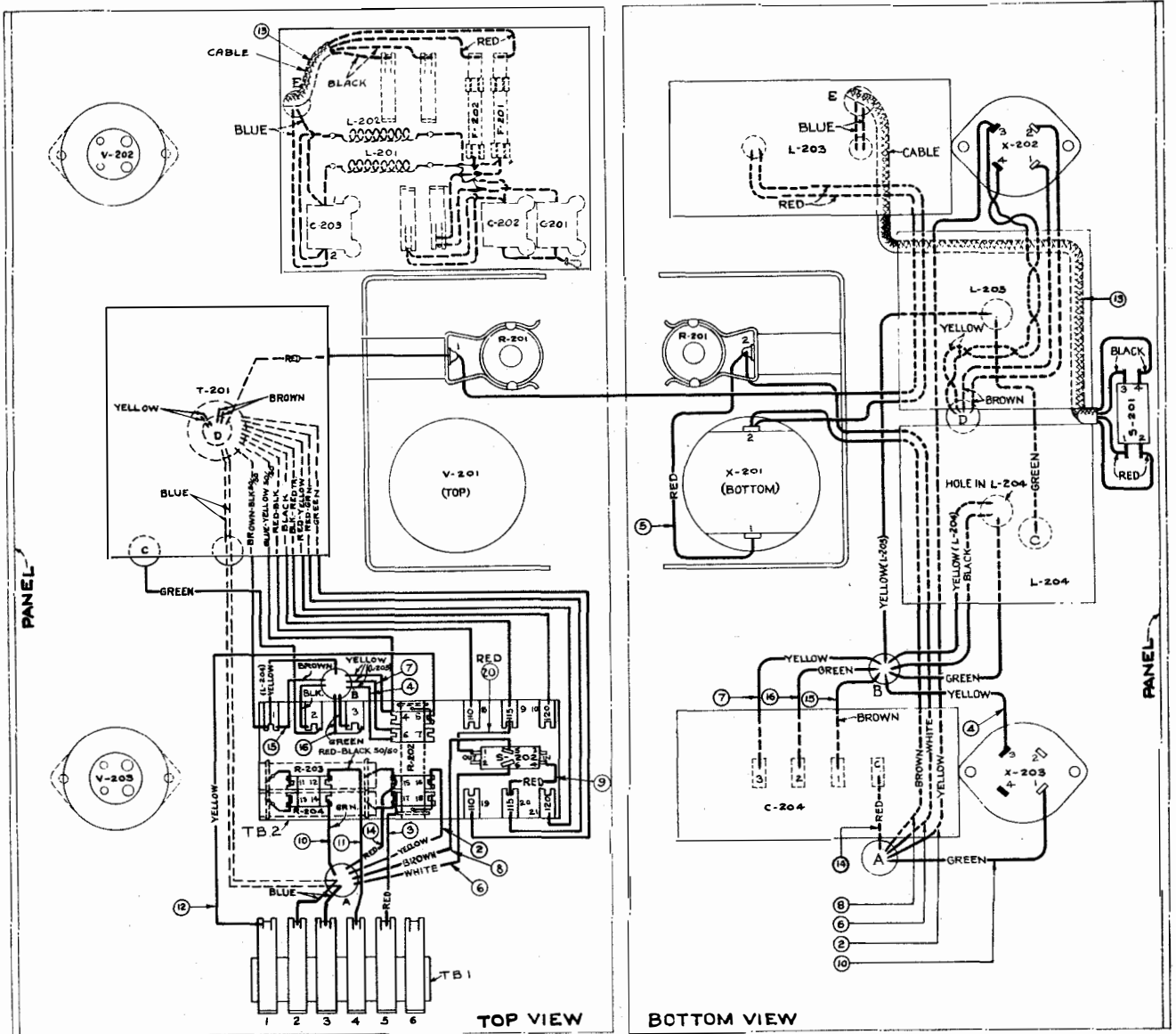

Figure 20—Connection Diagram,
Power Unit CRV-20131 (T-620092)

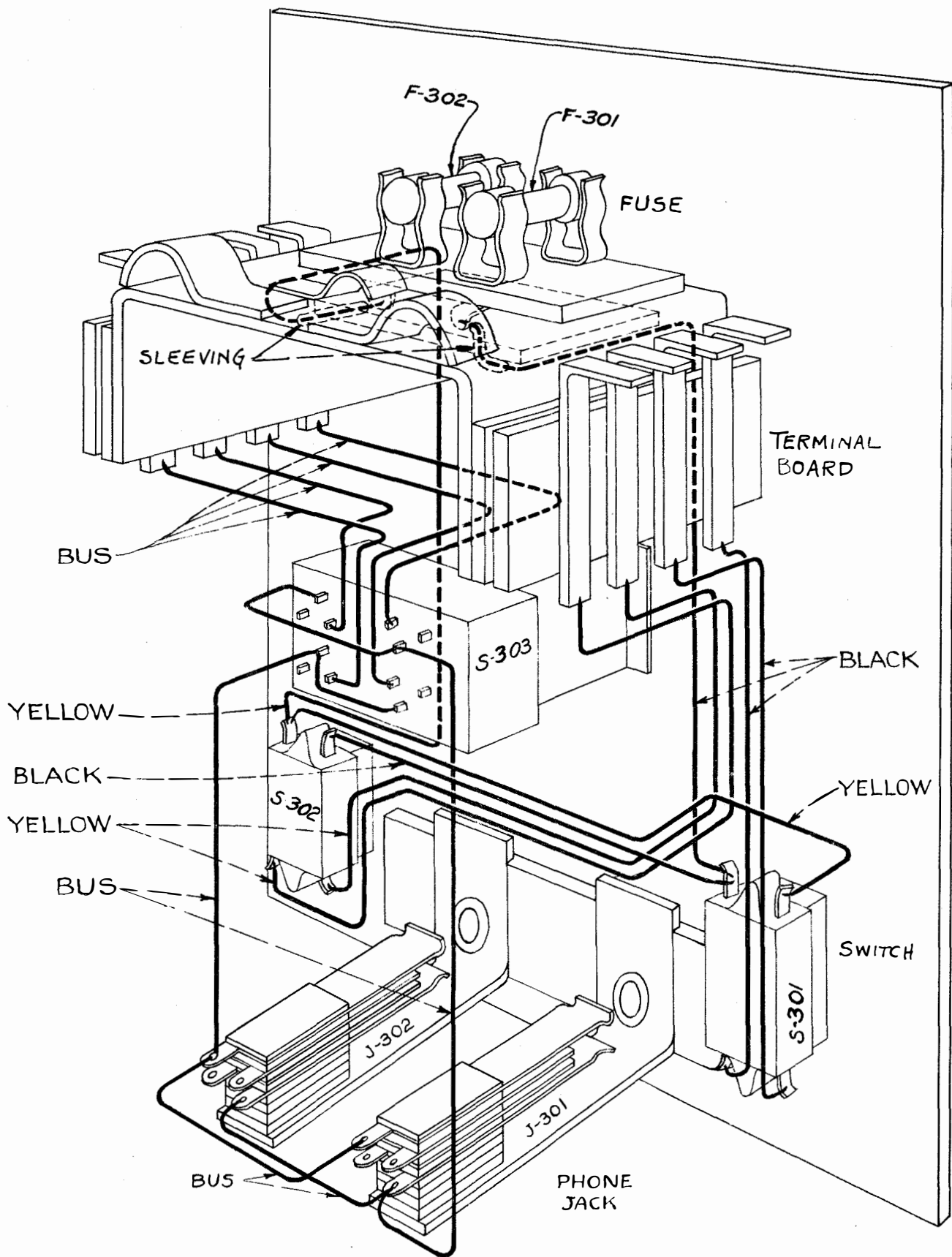

Figure 21—Connection Diagram.
Control Unit CRV-23073 (P-714101)

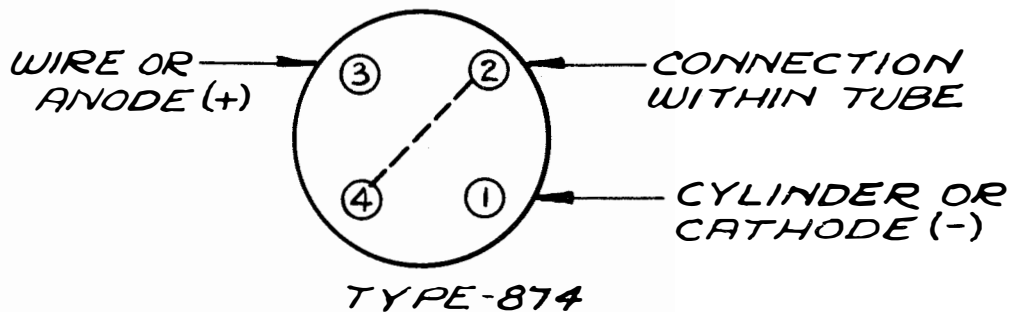
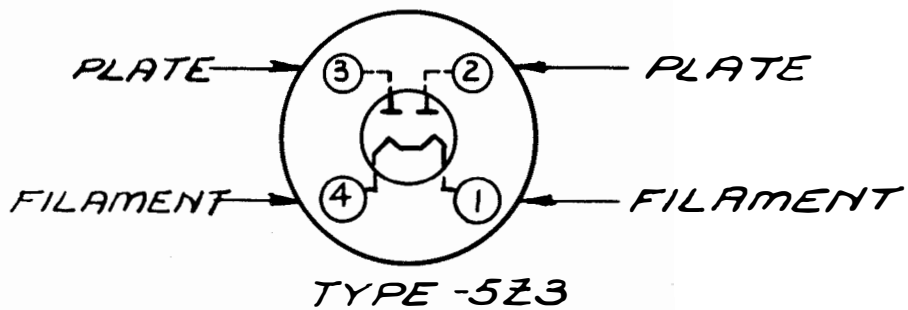
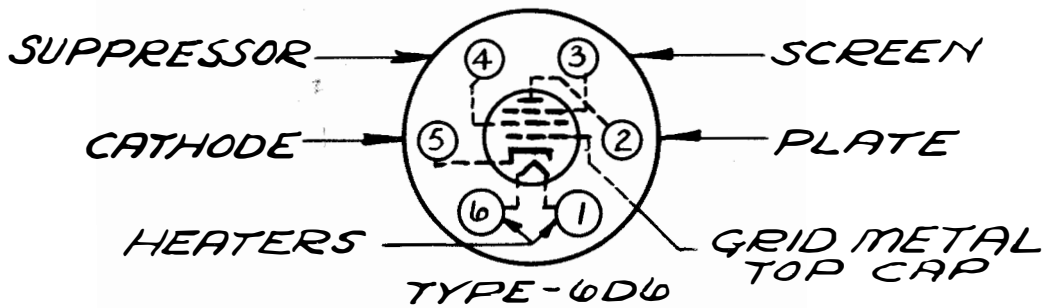
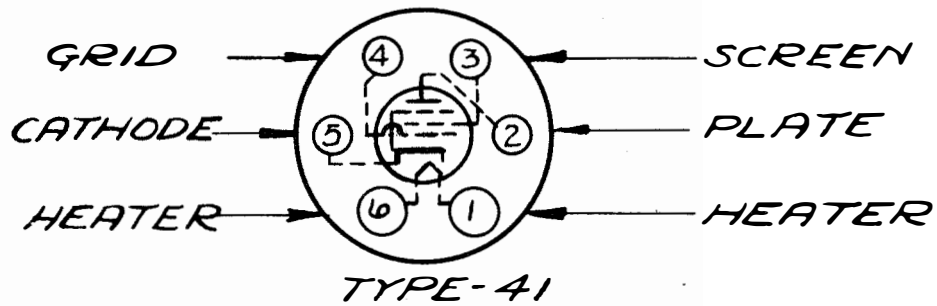

Figure 22—Tube Socket Connections
(K-850992-Sub. 3)

