

2010 COMPASS

USER GUIDE

Jeep®



THE MORE YOU EXPERIENCE

IMPORTANT: This User Guide is intended to familiarize you with the important features of your vehicle. The DVD enclosed contains your Owner's Manual, Navigation/Media Center Manuals, Warranty Booklets, Tire Warranty and 24-Hour Towing Assistance (new vehicles purchased in the U.S.) or Roadside Assistance (new vehicles purchased in Canada) in electronic format. We hope you find it useful. If you are the first registered owner of your vehicle, you may obtain a printed copy of the Owner's Manual, Navigation/Media Center Manuals or Warranty Booklet by calling 1-877-426-5337 (U.S.) or 1-800-387-1143 (Canada) or by contacting your dealer. Replacement DVD kits may be purchased by visiting www.techauthority.com. Jeep® is a registered trademark of Chrysler Group LLC. Copyright © 2010 Chrysler Group LLC.

TABLE OF CONTENTS

INTRODUCTION/WELCOME

WELCOME FROM CHRYSLER GROUP LLC	2
--	---

CONTROLS AT A GLANCE

DRIVER COCKPIT	4
INSTRUMENT CLUSTER	6

GETTING STARTED

KEY FOB	8
THEFT ALARM	9
SEAT BELT	9
CHILD RESTRAINTS	9
FRONT SEATS	11
REAR SEATS	13
HEATED SEATS	14
TILT STEERING COLUMN	15
PROGRAMMABLE FEATURES	15

OPERATING YOUR VEHICLE

TURN SIGNAL/LIGHTS LEVER	18
WIPER/WASHER LEVER	19
SPEED CONTROL LEVER	20
CONTINUOUSLY VARIABLE AUTOMATIC TRANSMISSION (CVT)	21
MANUAL CLIMATE CONTROLS	21
AUTOMATIC TEMPERATURE CONTROLS (ATC)	22
POWER SUNROOF	22
WIND BUFFETING	23

ELECTRONICS

NON-TOUCH-SCREEN RADIOS	24
TOUCH-SCREEN RADIOS	27
REMOTE AUDIO CONTROLS	31
UNIVERSAL CONSUMER INTERFACE	32
ELECTRONIC VEHICLE INFORMATION CENTER (EVIC)	32
UNIVERSAL GARAGE DOOR OPENER (HOMELINK®)	33
POWER INVERTER	34
POWER OUTLET	35
UCONNECT™ PHONE	35
VOICE COMMAND	37

OFF-ROAD CAPABILITIES

FOUR-WHEEL DRIVE OPERATION	38
--------------------------------------	----

UTILITY

TRAILER TOWING WEIGHTS (MAXIMUM TRAILER WEIGHT RATINGS)	39
RECREATIONAL TOWING (BEHIND MOTORHOME, ETC.)	40
BRAKE/TRANSMISSION INTERLOCK MANUAL OVERRIDE SYSTEM	40

WHAT TO DO IN EMERGENCIES

24-HOUR TOWING ASSISTANCE - U.S. ONLY	41
INSTRUMENT CLUSTER WARNING LIGHTS	41
IF YOUR ENGINE OVERHEATS	44
AUTOMATIC TRANSMISSION OVERHEATING	45
JACKING AND TIRE CHANGING	45
JUMP-STARTING	49
TOWING A DISABLED VEHICLE	52
FREEDING A STUCK VEHICLE	53
EVENT DATA RECORDER (EDR)	54

MAINTAINING YOUR VEHICLE

OPENING THE HOOD	55
ENGINE COMPARTMENT	56
FLUIDS AND CAPACITIES	58
MAINTENANCE CHART	60
FUSES	62
TIRE PRESSURES	63
WHEEL AND WHEEL TRIM CARE	64
EXTERIOR BULBS	64

CONSUMER ASSISTANCE

CHRYSLER GROUP LLC CUSTOMER CENTER	65
CHRYSLER CANADA INC. CUSTOMER CENTER	65
ASSISTANCE FOR THE HEARING IMPAIRED	65
PUBLICATIONS ORDERING	65
REPORTING SAFETY DEFECTS IN THE 50 UNITED STATES AND WASHINGTON, D.C.	66
TIRE WARRANTY	66

MOPAR ACCESSORIES

MOPAR® ACCESSORIES	69
------------------------------	----

INTRODUCTION/WELCOME

WELCOME FROM CHRYSLER GROUP LLC

Congratulations on selecting your new Chrysler Group LLC vehicle. Be assured that it represents precision workmanship, distinctive styling, and high quality - all essentials that are traditional to our vehicles.

This guide illustrates and describes the operation of features and equipment that are either standard or optional on this vehicle. This guide may also include a description of features and equipment that are no longer available or were not ordered on this vehicle. Please disregard any features and equipment described in this guide that are not available on this vehicle. Chrysler Group LLC reserves the right to make changes in design and specifications and/or make additions to or improvements to its products without imposing any obligation upon itself to install them on products previously manufactured.

For complete owner information, refer to the DVD in the owner's kit provided at the time of new vehicle purchase. For your convenience, the information contained on the DVD may also be printed and saved for future reference.

Chrysler Group LLC is committed to protecting our environment and natural resources. By converting from paper to electronic delivery for the majority of the user information for your vehicle, together we greatly reduce the demand for tree-based products and lessen the stress on our environment.

Vehicles Sold In Canada

With respect to any Vehicles sold in Canada, the name Chrysler Group LLC shall be deemed to be deleted and the name Chrysler Canada Inc. used in substitution therefore.

Driving And Alcohol

Drunken driving is one of the most frequent causes of accidents.



Your driving ability can be seriously impaired with blood alcohol levels far below the legal minimum. If you are drinking, don't drive. Ride with a designated non-drinking driver, call a cab, a friend, or use public transportation.

WARNING!

Driving after drinking can lead to an accident. Your perceptions are less sharp, your reflexes are slower, and your judgment is impaired when you have been drinking. Never drink and then drive.

INTRODUCTION/WELCOME

Rollover Warning

⚠ WARNING: HIGHER ROLLOVER RISK		
	<p>Avoid Abrupt Maneuvers and Excessive Speed.</p> <p>Always Buckle Up.</p> <p>See Owner's Manual For Further Information</p>	

WARNING!

Never use the 'PARK' position as a substitute for the parking brake. Always apply the parking brake fully when parked to guard against vehicle movement and possible injury or damage.

CAUTION!

Never park your vehicle over dry grass or other combustible materials. The heat from your vehicle exhaust system could cause a fire.

CHRYSLER, DODGE, JEEP, ATF+4, MOPAR and Uconnect are registered trademarks of Chrysler Group LLC.

COPYRIGHT ©2010 CHRYSLER GROUP LLC



CONTROLS AT A GLANCE

DRIVER COCKPIT



CONTROLS AT A GLANCE

Wiper/Washer
Lever (behind
steering wheel)

Audio System
(non-touch-screen
radio shown)

Climate Controls

Power Outlet/Cigar Lighter

Transmission Gear Selector

Speed
Control
Lever*

SWITCH PANEL
Heated Seats*
Electronic Stability Control*
Hazard Switch

*If Equipped

CONTROLS AT A GLANCE



INSTRUMENT CLUSTER

Warning Lights



- Low Fuel Warning Light



- Charging System Light**



- Oil Pressure Warning Light**



- Anti-Lock Brake (ABS) Light**



- Airbag Warning Light**



- Electronic Throttle Control (ETC) Light



- Tire Pressure Monitoring System (TPMS) Light



- Engine Temperature Warning Light



- Transmission Temperature Warning Light



- Seat Belt Reminder Light

BRAKE

- Brake Warning Light**



- Malfunction Indicator Light (MIL)**



- Electronic Stability Control (ESC) Activation/Malfunction Indicator Light**

4WD!

- 4WD System Fault Indicator Light**

CONTROLS AT A GLANCE



Indicators



- Turn Signal Indicators



- High Beam Indicator



- Front Fog Light Indicator



- Vehicle Security Indicator*

4WD

- 4WD Indicator



- Electronic Stability Control (ESC) Off Indicator

CRUISE

- Cruise Indicator

Odometer Messages

gASCAP - Fuel Cap Fault

door - Door Ajar

gate - Gate Ajar

Lo tlrE - Low Tire Pressure

CHANGe OIL* - Change Engine Oil

* If equipped

** Bulb Check with Key On

GETTING STARTED

KEY FOB



Locking And Unlocking The Doors/Liftgate

- Press the LOCK button once to lock all the doors and the liftgate. Press the UNLOCK button once to unlock the driver's door only and twice within five seconds to unlock all the doors and liftgate.
- All doors can be programmed to unlock on the first press of the UNLOCK button. Refer to Programmable Features in this guide.

WARNING!

Leaving unattended children in a vehicle is dangerous for a number of reasons. A child or others could be severely injured or killed. Children should be warned not to touch the parking brake, brake pedal, or the shift lever. Do not leave the key in the ignition. A child could operate power windows, other controls, or move the vehicle.

Remote Start

NOTE: The vehicle must be equipped with an automatic transaxle to be equipped with Remote Start.

- Press the REMOTE START button  twice within five seconds. Pressing the REMOTE START button a third time shuts the engine off.
- To drive the vehicle, press the UNLOCK button, insert the key in the ignition and turn to the ON/RUN position.
- With remote start, the engine will only run for 15 minutes (timeout) unless the ignition key is placed in the ON/RUN position.
- The vehicle must be started with the key after two consecutive timeouts.

WARNING!

- Do not start or run an engine in a closed garage or confined area. Exhaust gas contains Carbon Monoxide (CO) which is odorless and colorless. Carbon Monoxide is poisonous and can cause serious injury or death when inhaled.
- Keep Key Fob transmitters away from children. Operation of the Remote Start System, windows, door locks or other controls could cause serious injury or death.

GETTING STARTED

Panic Alarm

- Press the PANIC button once to turn the panic alarm on.
- Wait approximately three seconds and press the button a second time to turn the panic alarm off.

THEFT ALARM

To Arm

- Press the Key Fob LOCK button or the power door lock switch while the door is open.

To Disarm

- Press the Key Fob UNLOCK button and turn the ignition to the ON/RUN position.

SEAT BELT

- Be sure everyone in your vehicle is in a seat and using a seat belt properly.

WARNING!

In a collision, you and your passengers can suffer much greater injuries if you are not properly buckled up. You can strike the interior of your vehicle or other passengers, or you can be thrown out of the vehicle. Always be sure you and others in your vehicle are buckled up properly.

CHILD RESTRAINTS

- Children 12 years and under should ride properly buckled up in a rear seat, if available. According to crash statistics, children are safer when properly restrained in the rear seats rather than in the front.
- Every state in the United States and all Canadian provinces require that small children ride in proper restraint systems. This is the law, and you can be prosecuted for ignoring it.

WARNING!

In a collision, an unrestrained child, even a tiny baby, can become a projectile inside the vehicle. The force required to hold even an infant on your lap could become so great that you could not hold the child, no matter how strong you are. The child and others could be severely injured or killed. Any child riding in your vehicle should be in a proper restraint for the child's size.

Installing The LATCH - Compatible Child Restraint System

- Your vehicle's second row passenger seats are equipped with the child restraint anchorage system called LATCH, which stands for Lower Anchors and Tether for Children. LATCH child restraint anchorage systems are installed at all three rear seating positions.

GETTING STARTED

- Child seats with fixed lower attachments must be installed in the outboard positions only. Child seats with flexible lower attachments can be used in all three seating positions.
- NEVER install LATCH-compatible child seats such that two seats share a common lower anchorage.

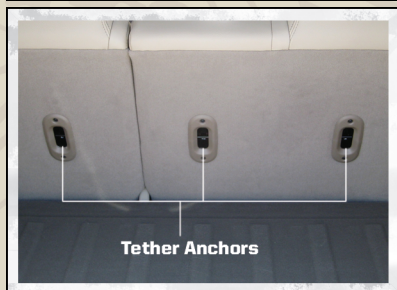
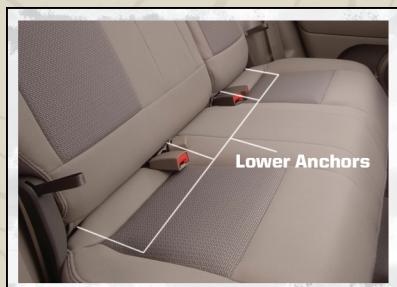

- Loosen the adjusters on the lower straps and tether straps so that you can attach the hook or connector to the lower and tether anchorages more easily.
- Attach the lower hooks or connectors over the top of the seatcover material.
- The top tether strap should be routed over the center of the head restraint and attached to the top tether anchor on the rear of the seatback.
- Tighten all three straps as you push the child restraint rearward and downward into the seat.

WARNING!

- Improper installation of a child restraint to the LATCH anchorages can lead to failure of an infant or child restraint. The child could be severely injured or killed. Follow the manufacturer's directions exactly when installing an infant or child restraint.
- An incorrectly anchored tether strap could lead to increased head motion and possible injury to the child. Use only the anchor positions directly behind the child seat to secure a child restraint top tether strap.

Installing The Child Restraint Using The Vehicle Seat Belts

- To install a child restraint, first, pull enough of the seat belt webbing from the retractor to route it through the belt path of the child restraint and slide the latch plate into the buckle.
- Next, extract all the seat belt webbing out of the retractor and then allow the belt to retract into the retractor. Finally, pull on any excess webbing to tighten the lap portion around the child restraint. Any seat belt system will loosen with time, so check the belt occasionally, and pull it tight if necessary.

GETTING STARTED

- Once you have completed securing the child restraint with the seat belt, secure the top tether strap. The tether strap should be routed over the center top of the head restraint.

WARNING!

Rearward-facing child seats must **NEVER** be used in the front seat of a vehicle with a front passenger airbag. An airbag deployment could cause severe injury or death to infants in this position.

FRONT SEATS

WARNING!

Adjusting a seat while the vehicle is moving is dangerous. The sudden movement of the seat could cause you to lose control. The seat belt might not be properly adjusted, and you could be severely injured or killed. Only adjust a seat while the vehicle is parked.

Manual Seat Adjustment

Forward/Rearward



- Lift up on the adjusting bar located at the front of the seat near the floor and release at the desired position.

GETTING STARTED

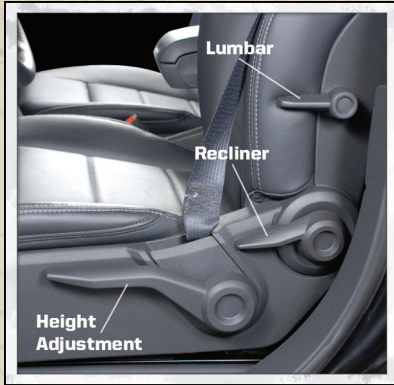

Recliner

- Lift the recliner lever located on the outboard side of the seat. lean back and release at the desired position.

Driver's Seat Height Adjustment

- The height adjustment lever is located on the outboard side of the seat. Raise the lever to raise the seat. Lower the lever to lower the seat.

Lumbar Support

- The lumbar lever is on the outboard side of the seatback. Rotate the lumbar lever downward to increase the lumbar support or upward to decrease the lumbar support as desired.

WARNING!

Do not ride with the seatback reclined so that the seat belt is no longer resting against your chest. In a collision, you could slide under the seat belt and be severely injured or killed. Use the recliner only when the vehicle is parked.

Six-Way Power Seats

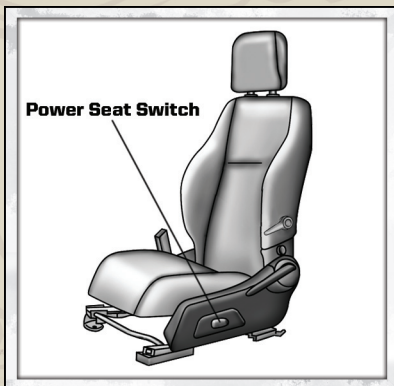

- The power seat switch is located on the outboard side of the seat near the floor. Use the switch to move the seat up, down, forward, rearward, or to tilt the seat.

GETTING STARTED

CAUTION!

DO NOT place any article under a power seat or impede its ability to move as it may cause damage to the seat controls. Seat travel may become limited if movement is stopped by an obstruction in the seat's path.

Fold-Flat Front Passenger Seat



- The front passenger seat can be folded flat. Pull up on the recliner handle, to the full upward position, to fold down the seatback.

REAR SEATS



Folding Rear Seatback

- To fold each rear seatback, pull the strap forward to move the seatback forward and flat.

Reclining Rear Seatback

- To recline each rear seatback, pull the strap forward just enough to release the seatback latch. Then push the seatback to a reclined position, approximately 35 degrees maximum, and release the strap.

GETTING STARTED

HEATED SEATS

Front Heated Seats



- The controls for the front heated seats are located on the center instrument panel area.
- Press the switch once to select High-level heating. Press the switch a second time to select Low-level heating. Press the switch a third time to shut the heating elements Off.

WARNING!

- Persons who are unable to feel pain to the skin because of advanced age, chronic illness, diabetes, spinal cord injury, medication, alcohol use, exhaustion or other physical conditions must exercise care when using the seat heater. It may cause burns even at low temperatures, especially if used for long periods of time.
- Do not place anything on the seat that insulates against heat, such as a blanket or cushion. This may cause the seat heater to overheat. Sitting in a seat that has been overheated could cause serious burns due to the increased surface temperature of the seat.

CAUTION!

Repeated overheating of the seat could damage the heating element and/or degrade the material of the seat.

GETTING STARTED

TILT STEERING COLUMN



- The tilt lever is located on the steering column, below the turn signal lever.
- Push down on the lever to unlock the steering column.
- With one hand firmly on the steering wheel, move the steering column up or down as desired.
- Pull upward on the lever to lock the column firmly in place.

WARNING!

Do not adjust the steering column while driving. Adjusting the steering column while driving, or driving with the steering column unlocked, could cause the driver to lose control of the vehicle. Be sure the steering column is locked before driving your vehicle. Failure to follow this warning may result in severe injury or death.

PROGRAMMABLE FEATURES

Electronic Vehicle Information Center (EVIC) - If Equipped



- Press the EVIC button, located below the speedometer, until Personal Settings is displayed on the EVIC. Use the EVIC button to select one of the following, then press and hold the EVIC button to select either "ON" or "OFF".

GETTING STARTED

- Language
- Auto Door Locks
- Auto Unlock On Exit
- Sound Horn With Remote Key Lock
- Illuminated Approach
- Headlamp Off Delay
- RKE Unlock (Remote Key Unlock)
Driver's Door 1st
- Key-Off Power Delay
- Display Units of Measure In
- Confirmation of Voice Commands
- Automatic Compass Calibration
- Compass Variance
- Manual Compass Calibration
- Flash Lamps With Lock (Flashing
Lights with Remote Key Lock)

Key Fob Programmable Features

- The following features may also be programmed using the Key Fob transmitter or the ignition switch and driver's door lock switch.

NOTE: Pressing the LOCK button while you are inside the vehicle will activate the Vehicle Security Alarm. Opening a door with the Vehicle Security Alarm activated will cause the alarm to sound. Press the UNLOCK button to deactivate the Vehicle Security Alarm.

Unlock On First Press

- To unlock either the driver's side, or all doors, on the first press of the UNLOCK button:
 - Press and hold the LOCK button for at least 4 seconds, but no longer than 10 seconds. Then, press and hold the UNLOCK button while still holding the LOCK button.
 - Release both buttons at the same time.

Auto Unlock Doors On Exit

- To have all of the vehicle doors unlock when any door is opened:
 - Enter your vehicle and close all the doors.
 - Within 15 seconds, cycle the ignition switch from the LOCK position to the ON position a minimum of four times, ending in the LOCK position (do not start the engine).
 - Within 30 seconds, press the driver's door lock switch in the UNLOCK direction. A single chime will indicate that programming is complete.

Auto Door Lock

- To have the doors lock automatically when the vehicle's speed exceeds 15 mph (24 km/h):
 - Enter your vehicle and close all the doors.
 - Within 15 seconds, cycle the ignition switch from the LOCK position to the ON position a minimum of four times, ending in the LOCK position (do not start the engine).
 - Within 30 seconds, press the driver's door lock switch in the LOCK direction. A single chime will indicate that programming is complete.

GETTING STARTED

Sound Horn With Lock

- To turn the horn chirp on or off when the doors are locked:
 - Press the LOCK button for at least 4 seconds, but no longer than 10 seconds. Then, press the PANIC button while still holding the LOCK button.
 - Release both buttons at the same time.

Flashing Lights With Lock



- The turn signal lights flashing, when the doors are locked or unlocked, feature can be turned on or off. To turn this feature on or off:
 - Press and hold the UNLOCK button for at least 4 seconds, but no longer than 10 seconds. Then, press and hold the LOCK button while still holding the UNLOCK button.
 - Release both buttons at the same time.

OPERATING YOUR VEHICLE

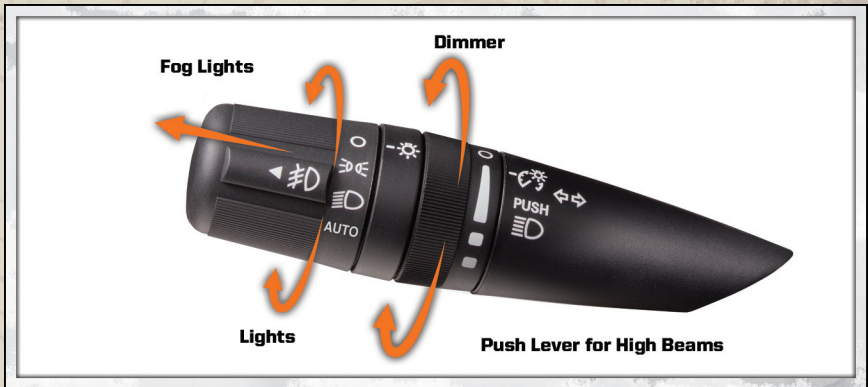
TURN SIGNAL/LIGHTS LEVER



Headlights/Parking Lights

- Rotate the end of the lever to the first detent for parking lights  and to the second detent for headlights .

Instrument Panel Dimmer

- Rotate the center portion of the lever to the extreme bottom position to fully dim the instrument panel lights and prevent the interior lights from illuminating when a door is opened.
- Rotate the center portion of the lever up to increase the brightness of the instrument panel lights when the parking lights or headlights are on.
- Rotate the center portion of the lever upward to the next detent position to brighten the odometer and radio controls when the parking lights or headlights are on.
- Rotate the center portion of the lever upward to the last detent to turn on the interior lighting.

Flash To Pass

- Pull the lever toward you to activate the high beams. The high beams will remain on until the lever is released.

High Beam Operation

- Push the lever forward to activate the high beams.

NOTE: For safe driving, turn off high beams when oncoming traffic is present to prevent headlight glare and as a courtesy to other motorists.

Fog Lights

- Turn on the parking lights or low beam headlights and pull out the end of the lever.

OPERATING YOUR VEHICLE

Turn Signals/Lane Change Assist

- Tap the lever up or down once and the turn signal (right or left) will flash three times and automatically turn off.

WIPER/WASHER LEVER

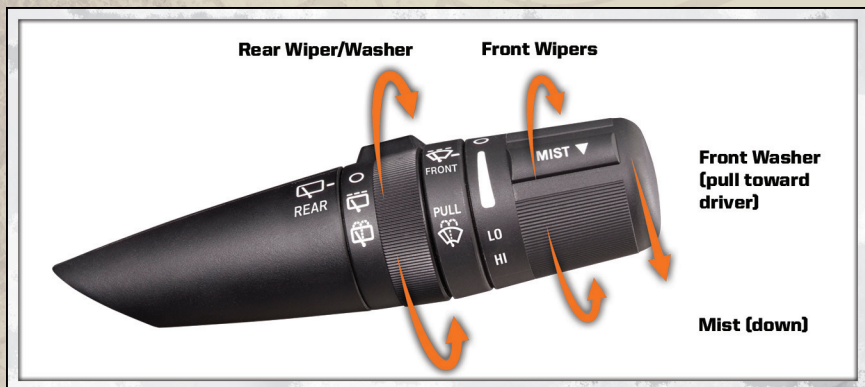

Front Wipers

Intermittent, Low And High Operation

- Rotate the end of the lever to the first detent position for one of five intermittent settings, the second detent for low wiper operation and the third detent for high wiper operation.

Washer Operation

- Pull the lever toward you and hold for as long as spray is desired.

Mist

- Pull down on the lever and release when a single wipe is desired.

Rear Wiper

Wiper Operation

- Rotate the center portion of the lever forward to the first detent for rear wiper operation.

Washer Operation

- Rotate the center portion of the lever past the first detent to activate the rear washer.

OPERATING YOUR VEHICLE

SPEED CONTROL LEVER



Cruise ON/OFF

- Push the ON/OFF button to activate the Speed Control.
- CRUISE will appear on the instrument cluster to indicate the Speed Control is on.
- Push the ON/OFF button a second time to turn the system off.

WARNING!

Leaving the Electronic Speed Control system on when not in use is dangerous. You could accidentally set the system or cause it to go faster than you want. You could lose control and have an accident. Always leave the Electronic Speed Control system off when you are not using it.

Set

- With Speed Control on, push down and release the lever to set a desired speed.

WARNING!

Electronic Speed Control can be dangerous where the system cannot maintain a constant speed. Your vehicle could go too fast for the conditions, and you could lose control. An accident could be the result. Do not use Electronic Speed Control in heavy traffic or on roads that are winding, icy, snow-covered or slippery.

Accel/Decel

- Push and hold the lever up to accelerate or down to decelerate the vehicle; release the lever to save the new set speed.
- Once a speed is set, tapping the lever up or down will increase or decrease the set speed approximately 1 mph (2 km/h).

Resume

- To resume a previously selected speed in memory, push the lever up and release.

Cancel

- Pull the lever toward you, push the clutch pedal or apply the brakes to cancel the set speed and maintain the set speed in memory.
- Push the ON/OFF button to turn the system off and erase the set speed memory.

OPERATING YOUR VEHICLE

CONTINUOUSLY VARIABLE AUTOMATIC TRANSMISSION (CVT)

- While conventional automatic transmissions typically have 4, 5 or 6 speeds, the Continuously Variable Transmission (CVT) has an infinite number of speeds. This allows it to adjust to exactly the right ratio to optimize performance and fuel economy.
- Under hard acceleration, you may hear more engine noise than with a conventional transmission. The CVT may also occasionally feel like it is “shifting.” These characteristics are perfectly normal and contribute to the CVT’s efficiency.

MANUAL CLIMATE CONTROLS

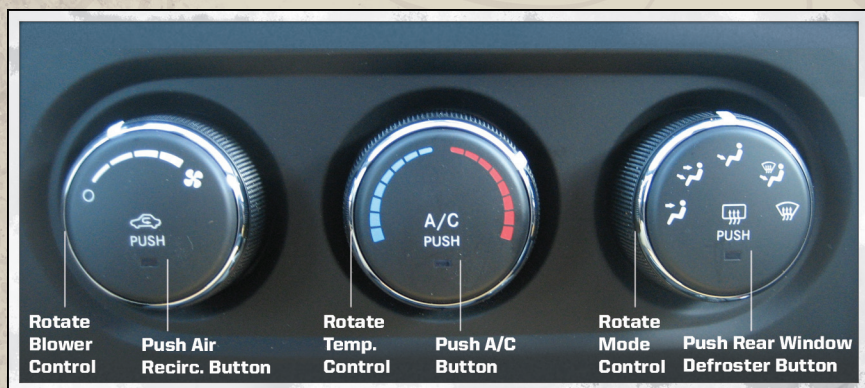

Air Recirculation

- Use recirculation for maximum A/C operation.
- For window defogging, turn the recirculation button off.
- Recirculation is not allowed in defrost, floor, defrost/floor (mix) modes.

OPERATING YOUR VEHICLE

AUTOMATIC TEMPERATURE CONTROLS (ATC)

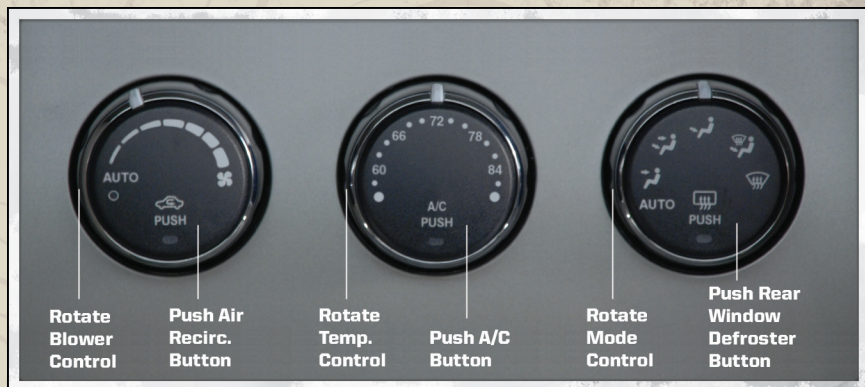

Automatic Operation

- Turn the Mode and Blower Controls to the AUTO position.
- Select the desired temperature by rotating the Temperature Control.
- The system will maintain the set temperature automatically.

Air Conditioning

- If the air conditioning button is pressed while in the AUTO mode, the indicator light may flash three times to indicate the cabin air is being controlled automatically.

Air Recirculation

- Use recirculation for maximum A/C operation.
- For window defogging, turn the air recirculation button off.
- If the recirculation button is pressed while in the AUTO mode, the indicator light may flash three times to indicate the cabin air is being controlled automatically.

POWER SUNROOF

- The power sunroof switch is located on the overhead console.

WARNING!

- Never leave children in a vehicle with the key in the ignition switch. Occupants, particularly unattended children, can become entrapped by the power sunroof while operating the power sunroof switch. Such entrapment may result in serious injury or death.
- In an accident, there is a greater risk of being thrown from a vehicle with an open sunroof. You could also be severely injured or killed. Always fasten your seat belt properly and make sure all passengers are properly secured too.

(Continued)

OPERATING YOUR VEHICLE

WARNING! (Continued)

- Do not allow small children to operate the sunroof. Never allow your fingers, other body parts, or any object to project through the sunroof opening. Injury may result.

Opening Sunroof

Express

- Press the switch rearward and release. The sunroof will fully open and stop automatically.

Closing Sunroof

Express

- Press the switch forward and release. The sunroof will close automatically from any position.

Manual Open/Close

- Press and hold the switch rearward to open or forward to close the sunroof. Any release of the switch will stop the movement, and the sunroof will remain in a partially open or closed position until the switch is pressed again.

Venting Sunroof

- Press and release the "VENT" button, and the sunroof will open to the vent position. This is called "Express Vent" and will occur regardless of sunroof position. During Express Vent operation, any movement of the switch will stop the sunroof.

Pinch Protection Feature

- This feature will detect an obstruction in the opening of the sunroof during Express Close operation. If an obstruction in the path of the sunroof is detected, the sunroof will automatically return to the open position.

NOTE: Pinch protection is disabled while the switch is pressed and held during manual opening and closing of the sunroof.

WIND BUFFETING

- Wind buffeting can be described as a helicopter-type percussion sound. If buffeting occurs with the rear windows open, adjust the front and rear windows together.
- If buffeting occurs with the sunroof open, adjust the sunroof opening, or adjust any window. This will minimize buffeting.

ELECTRONICS

NON-TOUCH-SCREEN RADIOS

Media Center 130 (RES)

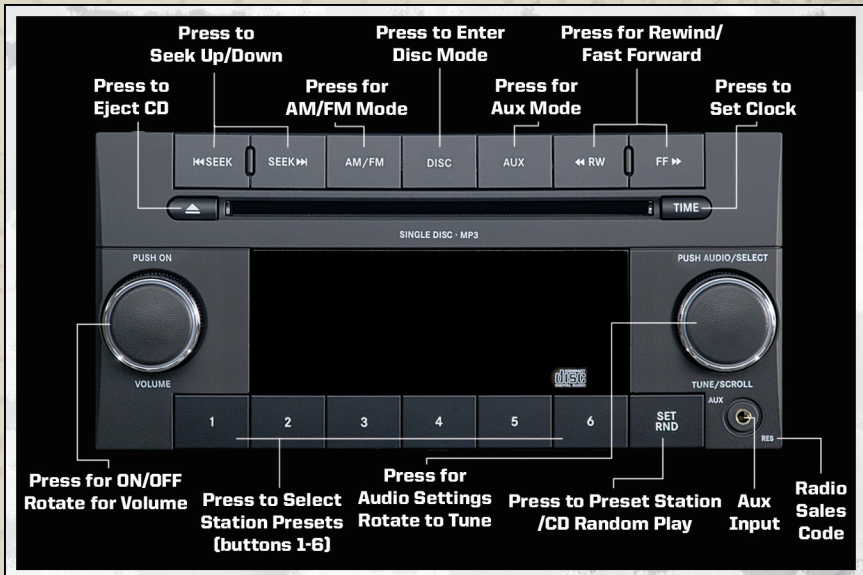

Media Center 130 (RES/RSC)

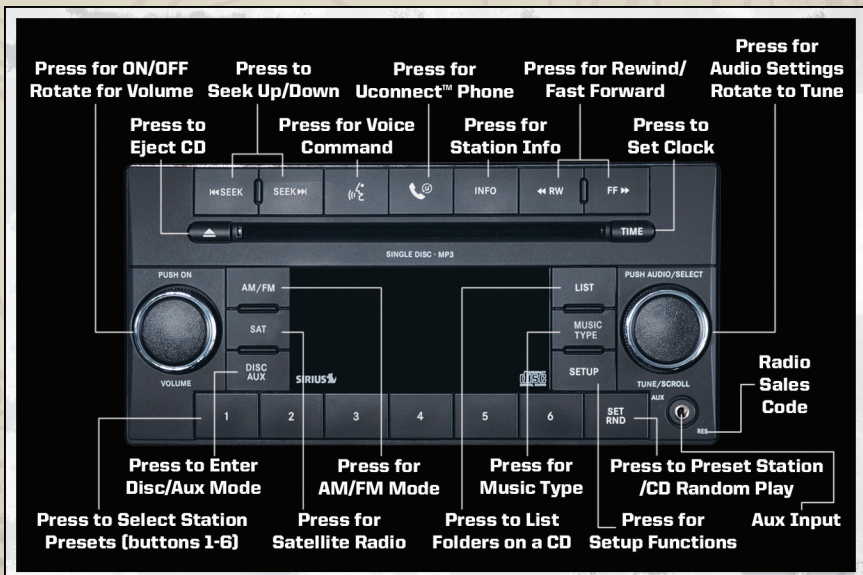

Media Center 230 (REQ)



NOTE: Uconnect™ Phone and Voice Command are vehicle options which must be ordered separately. The buttons on the radio will only be active if the vehicle has been equipped with the option.

- Your radio has many features that add to the comfort and convenience of you and your passengers. Some of these radio features should not be used when driving because they take your eyes from the road or your attention from driving.
- The radio sales code is located on the lower right side of the radio faceplate.
- Unless otherwise noted, the information provided on the operation and functionality of the radios in this section is common to all non-touch-screen radios.

Seek Up/Down Buttons

- Press to seek through radio stations in AM, FM or SAT bands. Seek through tracks in CD.
- Holding either button will bypass stations without stopping.

Audio Settings

- Press the TUNE/SCROLL control knob and BASS, MID, TREBLE, BALANCE and FADE will display. Rotate the TUNE/SCROLL control knob to select the desired setting.

ELECTRONICS

Auxiliary Mode

- The auxiliary (AUX) jack allows a portable device, such as an MP3 player or a cassette player, to be plugged into the radio and utilize the vehicle's audio system to amplify the source and play through the vehicle speakers.
- Pressing the AUX button will change the mode to auxiliary device if the AUX jack is connected.
- The control of the external device cannot be provided by the radio; use the device controls instead.

Clock Setting

- Press and hold the TIME button until the hours blink; turn the TUNE/SCROLL control knob to set the hours.
- Press the TUNE/SCROLL control knob until the minutes begin to blink; turn the TUNE/SCROLL control knob to set the minutes.
- Press the TUNE/SCROLL control knob to save the time change.
- To exit, press any button/knob or wait five seconds.

Station Presets

- Press the SET/RND button once and SET 1 will show in the display. Then select the button (1–6).
- A second station may be added to each push button. Press the SET/RND button twice and SET 2 will show in the display, then select button (1–6).

How To Load Multiple CDs/DVDs

REQ Radio Only

- Press the LOAD button and then press the button with the corresponding number (1–6) where the CD is being loaded. The radio will display PLEASE WAIT and prompt when to INSERT DISC.
- After the radio displays INSERT DISC, insert the CD into the player. The radio display will show LOADING DISC when the disc is loading and "READING DISC" when the radio is reading the disc.
- Press the eject button and then the corresponding number (1–6) to eject the desired disc.

TOUCH-SCREEN RADIOS

Media Center 430 (REN)

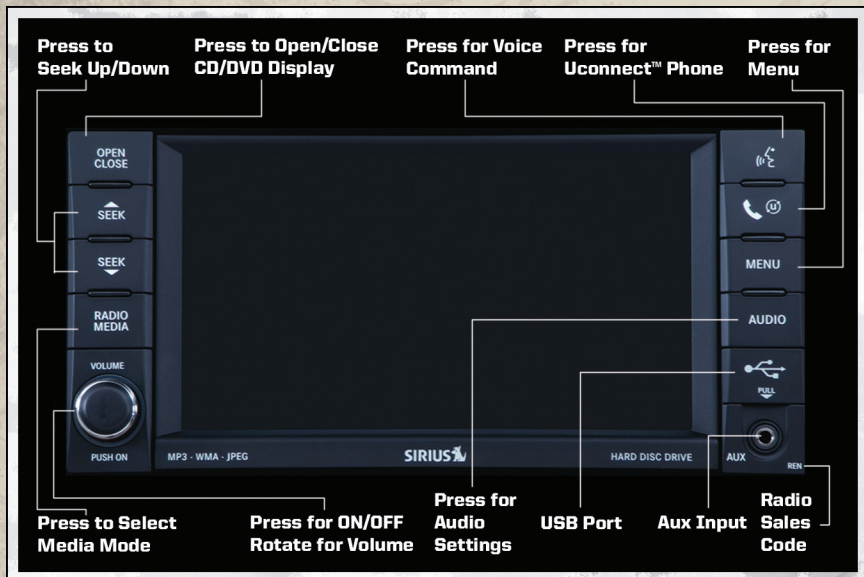

Media Center 730N (RER)

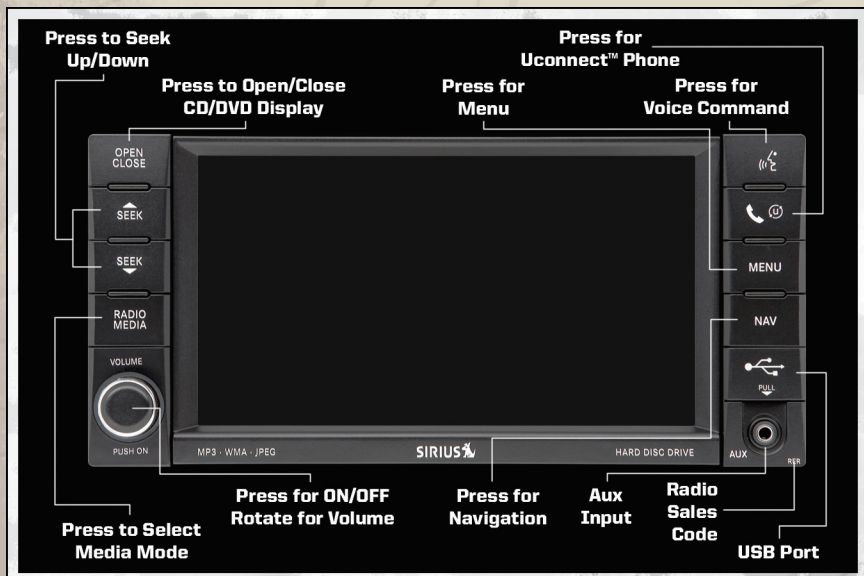

ELECTRONICS

Media Center 430 (RBZ)

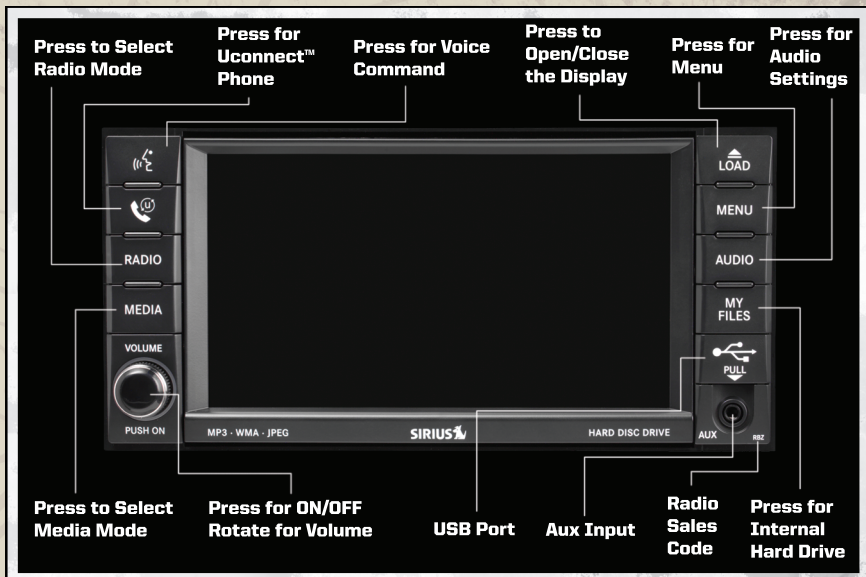

NOTE: Uconnect™ Phone and Voice Command are vehicle options which must be ordered separately. The buttons on the radio will only be active if the vehicle has been equipped with the option.

- The radio sales code is located on the lower right side of the radio faceplate.
- Unless otherwise noted, the information provided on the operation and functionality of the radios in this section is common to all touch-screen radios.

Seek Up/Down

- REN and RER Radios – Press the SEEK hard-key to seek through radio stations in AM, FM, or SAT bands. Seek through tracks in CD or iPod® modes or through songs in the HDD playlist.
- RBZ Radio – Touch the SCAN soft-key, right or left arrow soft-keys to change the currently playing station in AM, FM or SAT bands.

Auxiliary Mode

- The auxiliary (AUX) jack allows a portable device, such as an MP3 player or a cassette player, to be plugged into the radio and utilize the vehicle's audio system and play through the vehicle speakers.

Clock Setting

- Turn the radio on, then touch the screen where the time is displayed.
- Touch the USER CLOCK soft-key (Navigation radio only).

- To adjust the hours, touch either the HOUR FORWARD or HOUR BACKWARD soft-key.
- To adjust the minutes, touch either the MINUTE FORWARD or MINUTE BACKWARD soft-key.
- To save the new time setting, touch the screen where the word "Save" is displayed.

Store Radio Presets

- REN and RER Radios – Press the RADIO/MEDIA hard-key repeatedly until AM FM SAT is displayed in the upper left corner of the screen.
- RBZ Radio – Press the RADIO hard-key to display AM FM SAT in the upper left corner of the screen.
- Select the radio band by touching either the AM, FM, or SAT soft-key.
- Find the station to store by either pressing the SEEK UP/DOWN hard-key (REN and RER), touching the right and left arrow soft-keys (RBZ), touching the SCAN soft-key, or by using the DIRECT TUNE soft-key.
- Once the station is found, touch and hold one of the PRESET soft-keys in the list to the right, until you hear a confirmation beep.

Hard Disk Drive Operation

Copy Complete Audio Disc To Hard-Drive

- REN and RER Radios – Press the OPEN/CLOSE hard-key.
- RBZ Radio – Press the LOAD hard-key.
- Insert a disc and then press the MENU hard-key.
- Touch the MY FILES soft-key, then select MY MUSIC.
- Touch the IMPORT MUSIC soft-key, then touch the FROM DISC soft-key in the next screen to start the process.

Copying From USB

- Insert a USB device, then select MY MUSIC.
- Touch the IMPORT MUSIC FILES soft-key, then touch the FROM USB soft-key in the next screen.
- Select the folders or titles you would like to copy, then touch the DONE soft-key to start the copy process.

Copy Pictures To The Hard-Drive

- Insert either a CD or a USB device containing your pictures.
- Touch the MY FILES soft-key, then go to the MANAGE MY FILES screen.
- Touch the MY PICTURES soft-key to get an overview of the currently stored images.
- Touch one of the ADD PICTURES soft-keys, then select the type of media inserted.
- Use the PAGE soft-keys to page through a list of pictures and press the picture you would like to import.
- Confirm your selection by touching the YES soft-key. The imported picture is now available in the MANAGE MY PICTURES screen.

ELECTRONICS

- In order to display the imported picture in the radio screen, touch the desired picture soft-key.
- Select this picture by pressing the PICTURE VIEW soft-key. A check mark indicates the currently used picture.

Cleaning Your Touch-Screen Radio

- Do not spray any liquid or caustic chemicals directly on the screen. Use a clean and dry micro fiber lens cleaning cloth in order to clean the touch-screen.
- If necessary, use a lint-free cloth dampened with a cleaning solution such as isopropyl alcohol or an isopropyl alcohol and water solution ratio of 50:50. Be sure to follow the solvent manufacturer's precautions and directions.

Navigation

Navigation Radio – RER Only

- Navigation radios require digital data from a navigation database. The data in the navigation database is licensed from Navigation Technologies®. Not all roads are digitized.
- For software updates, visit <http://www.chrysler.com/en/owners/mygig/> website, visit <http://www.navteq.com> website, or contact your authorized dealer for the latest available software.

NOTE: Many features of this radio are speed dependent. For your own safety, it is not possible to use the touch-screen keyboard to enter a name (e.g., street name) while the vehicle is in motion. Pull over at a safe location to complete your task.

- The Navigation system receives GPS signals from satellites to display the position of your vehicle.

New Destination

- Press the NAV hard-key to access the Navigation Main Menu.
- Touch the NEW DESTINATION soft-key to program a destination, then select the destination soft-key of your choice.

Program/Storing Home Address

- Press the NAV hard-key to access the Navigation Main Menu.
- Touch the GUIDE ME HOME soft-key, then touch the STREET ADDRESS soft-key.
- Touch the STATE soft-key, then enter your state name into the speller; select your state from the list and press the CHANGE soft-key.
- Touch the INPUT STREET NAME soft-key and enter your street name into the speller.
- Touch the CONTINUE soft-key and enter your address into the speller; touch the CONTINUE soft-key again.
- Touch the city name and touch the SAVE soft-key to complete programming.

Change Stored Home Address

- Press the MENU hard-key, then touch the MY FILES soft-key.
- Touch the MY ADDRESS BOOK soft-key, then touch the HOME soft-key.
- In the Home Address Information screen, touch the EDIT CONTACT soft-key, then touch the CHANGE ADDRESS soft-key in the next screen.
- Touch the INPUT STREET NAME soft-key and enter your street name into the speller.
- Touch the CONTINUE soft-key and enter your address into the speller; touch the CONTINUE soft-key again.
- Touch the city name and touch the SAVE soft-key to complete programming.

Guide Me Home

- Press the NAV hard-key to access the Navigation Main Menu.
- Touch the GUIDE ME HOME soft-key to route you back to your home destination from your current location. Touch the GO soft-key to start your trip.

Map

- Press the NAV hard-key to access the Navigation Main Menu.
- Touch the MAP soft-key to display a map of your current position.

REMOTE AUDIO CONTROLS



- The remote audio controls are located on the rear surface of the steering wheel.

Right Switch

- Press the switch up or down to increase or decrease the volume.
- Press the button in the center to change modes AM/FM/CD/SAT.

Left Switch

- Press the switch up or down to search for the next listenable station or select the next or previous CD track.
- Press the button in the center to select the next preset station (radio) or to change CDs if equipped with a CD Changer.

ELECTRONICS

UNIVERSAL CONSUMER INTERFACE

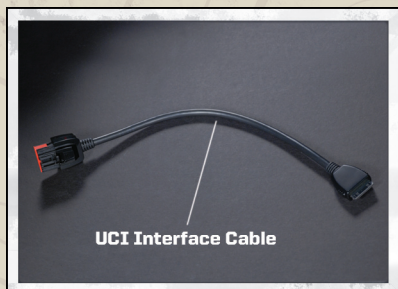

- This feature allows you to plug an iPod® into the vehicle's sound system through a 16-pin connector using the provided interface cable.
- The 16-pin connector port is located in the glove box or on the center console. Location may vary. To get into the UCI (iPod®) mode from a non-touch-screen radio, press the AUX button on the radio faceplate. From touch-screen radios, press the MEDIA hard-key, then touch the iPod® soft-key. When connected to this feature:
 - UCI supports Mini, 4G, Photo, Nano, 5G iPod® and iPhone® devices. Some iPod® software versions may not fully support the UCI features. Please visit Apple's website for software updates.
 - The iPod® audio can be played on the vehicle's sound system.
 - The iPod® can be controlled using the radio buttons to Play, Browse, and List the iPod® contents. Refer to the Owner's Manual on the DVD for details.
 - The iPod® battery charges when plugged into the UCI connector.

WARNING!

Do not plug in or remove the iPod® while driving. Failure to follow this warning could result in an accident.

ELECTRONIC VEHICLE INFORMATION CENTER (EVIC)



- The EVIC features a driver interactive display that is located in the instrument cluster. For additional information, refer to Programmable Features in this guide.
- Press the EVIC button, located below the speedometer, until one of the following functions is displayed on the EVIC:
 - Compass/Temperature/Audio
 - Average Fuel Economy
 - Distance To Empty (DTE)
- Elapsed Time
- Tire Pressure Monitor (TPM)
- Personal Settings
- Pressing and holding the EVIC button once will clear the function currently being displayed.

- To reset all resettable functions, press and release the EVIC button a second time within three seconds of resetting the currently displayed function. Reset ALL will be displayed during this three-second window.

UNIVERSAL GARAGE DOOR OPENER (HomeLink®)

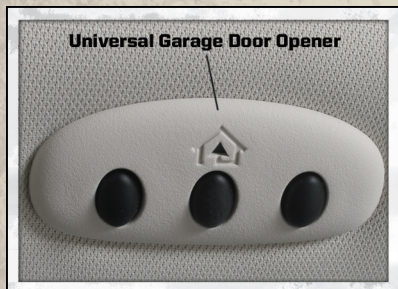

Programming HomeLink®

Begin Programming

- The HomeLink® buttons are located in the headliner.
 - Erase all channels before you begin programming by holding the two outside buttons for up to 20 seconds until the red indicator flashes.
- Park your vehicle outside of the garage and turn the ignition switch to the ON/RUN position.
 - Place the handheld transmitter 1 to 3 in (3 to 8 cm) from the HomeLink® buttons while keeping the indicator light in view.
 - Simultaneously, press and hold both the chosen HomeLink® button and the handheld transmitter button until the HomeLink® indicator flash rate changes from a slow to a rapidly blinking light, then release both the HomeLink® and the handheld transmitter buttons. This may take up to 30 seconds, or longer in rare cases.
 - Press and hold the just-programmed HomeLink® button; if the indicator light stays on constantly, programming is complete and the garage door should open.

WARNING!

- Your motorized door or gate will open and close while you are programming the universal transceiver. Do not program the transceiver if people or pets are in the path of the door or gate. Only use this transceiver with a garage door opener that has a "stop and reverse" feature as required by Federal safety standards. This includes most garage door opener models manufactured after 1982. Do not use a garage door opener without these safety features. Call toll-free 1-800-355-3515 or, on the Internet, at www.HomeLink.com for safety information or assistance.
- Do not run your vehicle in a closed garage or confined area while programming the transceiver. Exhaust gas from your vehicle contains Carbon Monoxide (CO) which is odorless and colorless. Carbon Monoxide is poisonous and can cause serious injury or death when inhaled.

NOTE: If you are having difficulty programming your HomeLink® and your garage door opener was manufactured after 1995, you may have a rolling code. Follow the steps below for Programming A Rolling Code System.

ELECTRONICS

Programming A Rolling Code System

- At the garage door opener motor (in the garage), locate the “learn” or “programming” button. This can usually be found where the hanging antenna wire is attached to the garage door opener motor (it is not the button normally used to open and close the door).
- Firmly press and release the “learn” or “programming” button then, within 30 seconds, return to the vehicle and press the programmed HomeLink® button twice (holding the button for two seconds each time). If the device is plugged in and activates, programming is complete.
- If the device does not activate, press the button a third time (for two seconds) to complete the programming.

Using HomeLink®

- To operate, simply press and release the programmed HomeLink® button and the programmed device will operate.
- Refer to your Owner’s Manual on the DVD for further details. If you have any problems programming HomeLink®, or require assistance, please call toll-free 1-800-355-3515 or, on the Internet, at www.HomeLink.com.

POWER INVERTER



- A 115 Volt, 150 Watt AC power inverter is located on the front of the center console.
- This outlet can power cellular phones, electronics and other low power devices requiring power up to 150 Watts.

NOTE: The power inverter is designed with built-in overload protection. If the power rating of 150 Watts is exceeded, the power inverter will automatically shut down. Once the electrical device has been removed from the outlet, the inverter should automatically reset. If the power rating exceeds approximately 170 Watts, the power inverter may have to be reset manually. To reset the inverter manually, unplug the device and plug it in again. To avoid overloading the circuit, check the power ratings on electrical devices prior to using the inverter.

WARNING!

To avoid serious injury or death: Do not use a three-prong adaptor. Do not insert any objects into the receptacles. Do not touch with wet hands. Close the lid when not in use. If this outlet is mishandled, it may cause an electric shock and failure.

POWER OUTLET

- The power outlet is located on the instrument panel below the climate control and is powered when the ignition switch is in the ON/RUN position.
- The outlet can operate a conventional cigar lighter unit or power accessories designed for use with a standard power outlet adapter.

NOTE: Do not exceed the maximum power of 160 Watts (13 Amps) at 12 Volts. If the 160 Watt (13 Amp) power rating is exceeded the fuse protecting the system will need to be replaced.

Uconnect™ Phone

- The Uconnect™ Phone is a voice-activated, hands-free, in-vehicle communications system.
- The Uconnect™ Phone allows you to dial a phone number with your cellular phone using simple voice commands.
- For vehicles equipped with Video Entertainment System (VES)™, refer to the Uconnect™ Phone section of the Uconnect™ User's Manual on the DVD for further details.
- For vehicles not equipped with VES™, refer to your vehicle Owner's Manual on the DVD for further details.

WARNING!

- Any voice commanded system should be used only in safe driving conditions following local laws and phone use. All attention should be kept on the roadway ahead. Failure to do so may result in an accident causing you and others to be severely injured or killed.
- In an emergency to use Uconnect™ Phone, your cellular phone must be:
 - turned on,
 - paired to Uconnect™ Phone,
 - and have network coverage.

NOTE: The Uconnect™ Phone requires a cellular phone equipped with the Bluetooth® Hands-Free Profile, Version 0.96 or higher. For Uconnect™ customer support, call 1-877-855-8400.

ELECTRONICS

Phone Pairing

NOTE: Pairing is a one-time initial setup before using the phone. You will also need to follow the Bluetooth® instructions in your cell phone user guide to complete the phone pairing setup.

- Press the Phone button  to begin.
- Wait for the “ready” prompt and beep.
- (After the BEEP), say “Uconnect setup”.
- (After the BEEP), say “phone pairing”.
- (After the BEEP), say “pair a phone”.
- Follow the audible prompts.
- You will be asked to enter a four-digit Personal Identification Number (PIN), which you will later need to enter into your cellular phone. You can enter any four-digit PIN. You will not need to remember this PIN after the initial pairing process.
- You will then be prompted to give the phone pairing a name (each phone paired should have a unique name).
- Next you will be asked to give this new pairing a priority of 1 thru 7 (up to seven phones may be paired).



Making A Phone Call

- Press the Phone button .
- (After the BEEP), say “dial” (or “call” to a name).
- (After the BEEP), say number (or name).

Phonebook (Uconnect™ Local) Edit

- Press the Phone button .
- (After the BEEP), say “phonebook”.
- (After the BEEP), say “new entry” or “list names” or “delete”.
- Follow the prompts.

Receiving A Call – Accept (And End)

- When an incoming call rings/is announced on Uconnect™, press the Phone button .
- To end a call, press the Phone button .

Mute (Or Unmute) Microphone During Call

- During a call, press the Voice Command button  VR .
- (After the BEEP), say “mute on” (or “mute off”).

Transfer Ongoing Call Between Handset And Vehicle



- During a call, press the Voice Command button  VR .
- (After the BEEP), say “transfer call”.

Changing The Volume

- Start a dialogue by pressing the Phone button  , then adjust the volume during a normal call.
- Use the radio ON/OFF VOLUME rotary knob to adjust the volume to a comfortable level while the Uconnect™ system is speaking. Please note the volume setting for Uconnect™ is different than the audio system.

NOTE: To access the tutorial, press the Uconnect™ hard-key. After the BEEP, say “tutorial”. Press any hard-key or touch the display to cancel the tutorial.

VOICE COMMAND

- The Voice Command system allows you to control your AM, FM radio, satellite radio, disc player, Uconnect™ Phone and a memo recorder.
- When you press the Voice Command button  VR located on the radio face plate or steering wheel, you will hear a beep. The beep is your signal to give a command. If you do not say a command within a few seconds, the system will present you with a list of options. If you ever wish to interrupt the system while it lists options, press the Voice Command button  VR , listen for the BEEP, and say your command.
- For vehicles equipped with Video Entertainment System (VES)™, refer to the Voice Command section of the Uconnect™ User’s Manual on the DVD for further details.
- For vehicles not equipped with VES™, refer to your vehicle Owner’s Manual on the DVD for Voice Command information.

Changing The Volume

- Start a dialogue by pressing the Voice Command button  VR , then say a command (for example, “tutorial”).
- Use the radio ON/OFF VOLUME rotary knob to adjust the volume to a comfortable level while the Voice Command system is speaking. The volume setting for Voice Command is different than the audio system.

WARNING!

Any voice commanded system should be used only in safe driving conditions following local laws and phone use. All attention should be kept on the roadway ahead. Failure to do so may result in an accident causing you and others to be severely injured or killed.

NOTE: To access the tutorial, press the Voice Command button  VR . After the BEEP, say “tutorial”. Press any hard-key or touch the display to cancel the tutorial.

OFF-ROAD CAPABILITIES

FOUR-WHEEL DRIVE OPERATION

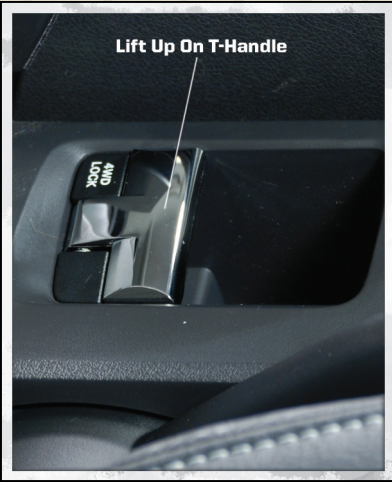

- This feature provides full time, on-demand, four-wheel drive (4WD).
- To activate, pull the T-handle, located in between the front driver and passenger seats, up once and release. The "4WD Indicator Light" will come on in the cluster.
- This can be done on the fly, at any vehicle speed. To deactivate, simply pull on the T-handle one more time. The "4WD Indicator Light" will then go out.

TRAILER TOWING WEIGHTS (MAXIMUM TRAILER WEIGHT RATINGS)

Engine/Transmission	Frontal Area	Max. GTW (Gross Trailer Wt.)	Max. Tongue Wt. (See Note)
2.0L Auto/Man	22 sq ft (2.04 sq m)	1,000 lbs (450 kg)	150 lbs (50 kg)
2.4L Auto/Man	22 sq ft (2.04 sq m)	1,000 lbs (450 kg)	150 lbs (50 kg)
2.4L Auto/Man with Trailer Tow Prep Package (AHC)	32 sq ft (3.0 sq m)	2,000 lbs (907 kg)	300 lbs (136 kg)

Refer to local laws for maximum trailer towing speeds.

Note: The trailer tongue weight must be considered as part of the combined weight of occupants and cargo, and should never exceed the weight referenced on the Tire and Loading Information placard.

UTILITY

RECREATIONAL TOWING (BEHIND MOTORHOME, ETC.)

Towing This Vehicle Behind Another Vehicle (Flat Towing With All Four Wheels On The Ground)

Recreational Towing Condition	Manual Transmission Vehicles	Automatic Transmission Vehicles
Four Wheel Flat Tow (All Wheels on Ground)	Yes	Never
Two Wheel Dolly Tow (Front or Rear Wheels on Ground)	Never	Never
Flat Bed Tow (All Wheels on Bed of Truck)	Yes	Yes

NOTE: Vehicles equipped with manual transaxles may be recreationally towed (flat towed) at any legal highway speed, for any distance, if the manual transmission is in NEUTRAL and the ignition key is in the ACC position.

CAUTION!

- DO NOT flat tow any vehicle equipped with an automatic transmission. Damage to the drivetrain will result. If these vehicles require towing, make sure all four wheels are off the ground.
- Front or rear wheel lifts should not be used. Internal damage to the transmission will occur if a front or rear wheel lift is used when recreational towing.

BRAKE/TRANSMISSION INTERLOCK MANUAL OVERRIDE SYSTEM

- The manual override may be used in the event that the shift lever should fail to move from PARK with the Key Fob in the ON/RUN position and the brake pedal pressed.

- To operate the shift lock manual override, perform the following steps:
 - Locate and remove the removable plug in the right side of the shift lever housing.
 - Turn the ignition switch to the ACC or ON/RUN position without starting the engine.
 - Firmly set the parking brake.
 - Press and maintain firm pressure on the brake pedal.
 - Using your finger, press and hold the override tab through the access port.
 - Move the shift lever into the NEUTRAL position and start the vehicle.
 - Reinstall the removable plug.
 - Release the parking brake.
- Have your vehicle inspected by your local authorized dealer immediately if the shift lock manual override has been used.

WHAT TO DO IN EMERGENCIES

24-HOUR TOWING ASSISTANCE - U.S. ONLY

- Dial toll-free 1-800-521-2779 or 1-800-363-4869 for Canadian residents.
- Provide your name, vehicle identification number and license plate number.
- Provide your location, including telephone number, from which you are calling.
- Briefly describe the nature of the problem and answer a few simple questions.
- You will be given the name of the service provider and an estimated time of arrival. If you feel you are in an "unsafe situation", please let us know. With your consent, we will contact local police or safety authorities.

INSTRUMENT CLUSTER WARNING LIGHTS

- Electronic Stability Control (ESC) Activation/Malfunction Indicator Light

- If the "ESC Activation/Malfunction Indicator Light" comes on continuously with the engine running, a malfunction has been detected in the ESC system. If this light remains on after several ignition cycles, and the vehicle has been driven several miles (kilometers) at speeds greater than 30 mph (48 km/h), we recommend you do not operate the vehicle. Have the vehicle serviced immediately.
- The "ESC Activation/Malfunction Indicator Light" starts to flash as soon as the tires lose traction and the ESC system becomes active. If the light begins to flash during acceleration, ease up on the accelerator and apply as little throttle as possible. Be sure to adapt your speed and driving to the prevailing road conditions. The light also flashes when TCS is active. To improve the vehicle's traction when starting off in deep snow, sand or gravel, it may be desirable to switch the ESC system to Partial Off mode by momentarily pressing the ESC Off  switch.

- Tire Pressure Monitoring System (TPMS) Light

- Each tire, including the spare (if provided), should be checked monthly, when cold and inflated to the inflation pressure recommended by the vehicle manufacturer on the vehicle placard or tire inflation pressure label. (If your vehicle has tires of a different size than the size indicated on the vehicle placard or tire inflation pressure label, you should determine the proper tire inflation pressure for those tires.)
- As an added safety feature, your vehicle has been equipped with a Tire Pressure Monitoring System (TPMS) that illuminates a low tire pressure telltale when one or more of your tires is significantly under-inflated. Accordingly, when the low tire pressure telltale illuminates, you should stop and check your tires as soon as possible, and inflate them to the proper pressure. Driving on a significantly under-inflated tire causes the tire to overheat and can lead to tire failure. Under-inflation also reduces fuel efficiency and tire tread life, and may affect the vehicle's handling and stopping ability.
- Please note that the TPMS is not a substitute for proper tire maintenance, and it is the driver's responsibility to maintain correct tire pressure, even if under-inflation has not reached the level to trigger illumination of the TPMS low tire pressure telltale.

WHAT TO DO IN EMERGENCIES

- Your vehicle has also been equipped with a TPMS malfunction indicator to indicate when the system is not operating properly. The TPMS malfunction indicator is combined with the low tire pressure telltale. When the system detects a malfunction, the telltale will flash for approximately one minute and then remain continuously illuminated. This sequence will continue upon subsequent vehicle start-ups as long as the malfunction exists.
- When the malfunction indicator is illuminated, the system may not be able to detect or signal low tire pressure as intended. TPMS malfunctions may occur for a variety of reasons, including the installation of replacement or alternate tires or wheels on the vehicle that prevent the TPMS from functioning properly. Always check the TPMS malfunction telltale after replacing one or more tires or wheels on your vehicle, to ensure that the replacement or alternate tires and wheels allow the TPMS to continue to function properly.

CAUTION!

The TPMS has been optimized for the original equipment tires and wheels. TPMS pressures and warning have been established for the tire size equipped on your vehicle. Undesirable system operation or sensor damage may result when using replacement equipment that is not of the same size, type, and/or style. Aftermarket wheels can cause sensor damage. Do not use tire sealant from a can, or balance beads if your vehicle is equipped with a TPMS, as damage to the sensors may result.

- Engine Temperature Warning Light

- This light warns of an overheated engine condition.
- If the light turns on and a warning chime sounds while driving, safely pull over and stop the vehicle. If the A/C system is on, turn it off. Also, shift the transmission into NEUTRAL and idle the vehicle. If the temperature reading does not return to normal, turn the engine off immediately.
- We recommend that you do not operate the vehicle or engine damage will occur. Have the vehicle serviced immediately.

WARNING!

A hot engine cooling system is dangerous. You or others could be badly burned by steam or boiling coolant. You may want to call an authorized service center for service if your vehicle overheats.

BRAKE - Brake Warning Light

- The Brake Warning light illuminates when there is either a system malfunction or the parking brake is applied. If the light is on and the parking brake is not applied, it indicates a possible brake hydraulic malfunction, brake booster problem or an Anti-Lock Brake System problem.
- We recommend you drive to the nearest service center and have the vehicle serviced immediately.

WHAT TO DO IN EMERGENCIES

WARNING!

Driving a vehicle with the red brake light on is dangerous. Part of the brake system may have failed. It will take longer to stop the vehicle. You could have an accident. Have the vehicle checked immediately.

- Malfunction Indicator Light (MIL)

- Certain conditions, such as a loose or missing gas cap, poor fuel quality, etc., may illuminate the MIL after engine start. The vehicle should be serviced if the light stays on through several typical driving cycles. In most situations, the vehicle will drive normally and not require towing.
- If the MIL flashes when the engine is running, serious conditions may exist that could lead to immediate loss of power or severe catalytic converter damage. We recommend you do not operate the vehicle. Have the vehicle serviced immediately.

- Charging System Light

- This light shows the status of the electrical charging system. If the charging system light remains on, it means that the vehicle is experiencing a problem with the charging system.
- We recommend you do not continue driving if the charging system light is on. Have the vehicle serviced immediately.

- Oil Pressure Warning Light

- This light indicates low engine oil pressure. If the light turns on while driving, stop the vehicle and shut off the engine as soon as possible. A chime will sound for four minutes when this light turns on.
- We recommend you do not operate the vehicle or engine damage will occur. Have the vehicle serviced immediately.

- Anti-Lock Brake (ABS) Light

- This light monitors the Anti-Lock Brake System (ABS).
- If the light is not on during starting, stays on, or turns on while driving, we recommend you drive to the nearest service center and have the vehicle serviced immediately.

- Electronic Throttle Control (ETC) Light

- This light informs you of a problem with the Electronic Throttle Control (ETC) system.
- If a problem is detected, the light will come on while the engine is running. Cycle the ignition when the vehicle has completely stopped and the shift lever is placed in the PARK position; the light should turn off.
- If the light remains lit with the engine running, your vehicle will usually be drivable; however, see an authorized service center immediately. If the light is flashing when the engine is running, immediate service is required and you may experience reduced performance, an elevated/rough idle or engine stall and your vehicle may require towing.

WHAT TO DO IN EMERGENCIES

- Airbag Warning Light

- If the light is not on during starting, stays on, or turns on while driving, have the vehicle serviced by an authorized service center immediately.

4WD! - 4WD System Fault Indicator Light

- When lit solid: There is a 4WD system fault. The 4WD performance will be at a reduced level. We recommend you do not operate the vehicle. Have the vehicle serviced immediately.
- When blinking: The 4WD system is temporarily disabled due to overload condition.

- Transmission Temperature Warning Light

- This light indicates that there is excessive transmission fluid temperature that might occur with severe usage such as trailer towing. If this light turns on, you will experience reduced vehicle performance until the automatic transmission cools down. If the overheating continues, stop the vehicle and run the engine at idle, with the transmission in NEUTRAL, until the light turns off. Once the light turns off, you may continue to drive normally.

Fuel Cap/Loose Gas Cap Message

- If a “gas cap” message (shown as gASCAP) appears, tighten the gas cap until a “clicking” sound is heard.
- Press the odometer reset button, located below the tachometer, to turn the message off.
- If the message continues to appear for more than three days after tightening the gas cap, see your authorized service center.

Oil Change Indicator

Message

- If an “oil change” message (shown as CHAnGE OIL) appears and a single chime sounds, it is time for your next required oil change.

Resetting The Light After Servicing

- Turn the ignition switch to the ON/RUN position (do not start engine).
- Fully depress the accelerator pedal three times within 10 seconds.
- Turn the ignition switch to the OFF/LOCK position.

IF YOUR ENGINE OVERHEATS

- In any of the following situations, you can reduce the potential for overheating by taking the appropriate action.
 - On the highways — slow down.
 - In city traffic — while stopped, shift transmission into NEUTRAL, but do not increase engine idle speed.

NOTE: There are steps that you can take to slow down an impending overheat condition:

- If your air conditioner (A/C) is on, turn it off. The A/C system adds heat to the engine cooling system and turning the A/C off can help remove this heat.

WHAT TO DO IN EMERGENCIES

- You can also turn the Temperature Control to maximum heat, the Mode Control to floor and the Fan Control to high. This allows the heater core to act as a supplement to the radiator and aids in removing heat from the engine cooling system.
- If the temperature reading does not return to normal, turn the engine off immediately.
- We recommend that you do not operate the vehicle or engine damage will occur. Have the vehicle serviced immediately.

CAUTION!

Driving with a hot cooling system could damage your vehicle. If the temperature gauge reads HOT (H), pull over and stop the vehicle. Idle the vehicle with the air conditioner turned off until the pointer drops back into the normal range. If the pointer remains on HOT (H), and you hear continuous chimes, turn the engine off immediately and call for service.

WARNING!

You or others can be badly burned by hot engine coolant (antifreeze) or steam from your radiator. If you see or hear steam coming from under the hood, do not open the hood until the radiator has had time to cool. Never try to open a cooling system pressure cap when the radiator or coolant bottle is hot.

AUTOMATIC TRANSMISSION OVERHEATING

- During sustained high speed driving or trailer towing up long grades on hot days, the automatic transmission oil may become too hot.
- When the transmission overheat warning light  turns on, you will experience reduced performance until the automatic transmission cools down. Once the transmission has cooled down and the light turns off, you may continue to drive normally. If the high speed is maintained, the overheating will continue to occur.
- If the overheating continues, it may become necessary to stop the vehicle and run the engine at idle with the transmission in NEUTRAL until the light turns off.

JACKING AND TIRE CHANGING

WARNING!

- Do not attempt to change a tire on the side of the vehicle close to moving traffic. Pull far enough off the road to avoid the danger of being hit when operating the jack or changing the wheel.
- Getting under a jacked-up vehicle is dangerous. The vehicle could slip off the jack and fall on you. You could be crushed. Never get any part of your body under a vehicle that is on a jack. If you need to get under a raised vehicle, take it to a service center where it can be raised on a lift.

(Continued)

WHAT TO DO IN EMERGENCIES

WARNING! (Continued)

- The jack is designed to use as a tool for changing tires only. The jack should not be used to lift the vehicle for service purposes. The vehicle should be jacked on a firm, level surface only. Avoid ice or slippery areas.

WARNING!

- The compact spare tire is for emergency use only. Installation of this compact spare tire affects vehicle handling.
- Do not drive more than 50 mph (80 km/h) with a compact spare tire.
- Keep the compact spare tire inflated to the cold tire inflation pressure, listed on either your tire placard or limited use spare tire and wheel assembly.
- Replace (or repair) the original tire at the first opportunity and reinstall it on your vehicle. Failure to do so could result in loss of vehicle control.
- A loose tire or jack, thrown forward in an accident or hard stop, could endanger the occupants of the vehicle. Always stow the jack parts and spare tire in the places provided.

Jack Location



- The jack and jack-handle are stowed under the load floor in the trunk.

Spare Tire Stowage

- The compact spare tire is stowed under the rear load floor in the trunk.
- To remove the spare tire, lift up the load floor cover and remove the hold down.

Preparations For Jacking

- Park on a firm, level surface. Avoid ice or slippery areas.

WARNING!

Do not attempt to change a tire on the side of the vehicle close to moving traffic. Pull far enough off the road to avoid being hit when operating the jack or changing the wheel.

WHAT TO DO IN EMERGENCIES

- Set the parking brake and shift the automatic transmission into PARK, or a manual transmission into REVERSE.
- Turn the ignition to LOCK and turn on the Hazard Warning flasher.

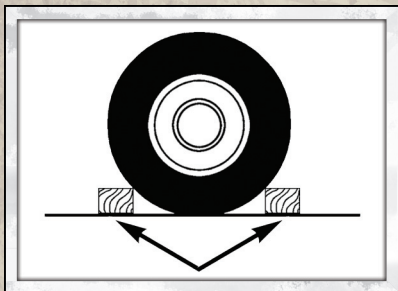

- Block both the front and rear of the wheel diagonally opposite of the jacking position. For example, if changing the right front tire, block the left rear wheel.

NOTE: Passengers should not remain in the vehicle when the vehicle is being jacked.

Jacking And Tire Changing Instructions

WARNING!

Carefully follow these tire changing procedures to help prevent personal injury or damage to your vehicle: Always park on a firm, level surface as far from the edge of the roadway as possible before raising the vehicle.

- Remove the scissors jack and lug wrench from the spare wheel as an assembly. Turn the jack screw counterclockwise to loosen the lug wrench, and remove the wrench from the jack assembly.

NOTE: The jack handle attaches to the side of the jack with two attachment points. When the jack is partially expanded, the tension between the two attachment points holds the jack handle in place.

- Loosen (but do not remove) the wheel lug nuts by turning them counterclockwise one turn while the wheel is still on the ground.
- Assemble the jack and jacking tools. Connect the jack handle driver to the extension, then to the lug wrench.
- Place the jack underneath the lift area (triangular cutout) that is closest to the flat tire. Turn the jack screw clockwise to firmly engage the jack saddle with the lift area of the sill flange.

WHAT TO DO IN EMERGENCIES

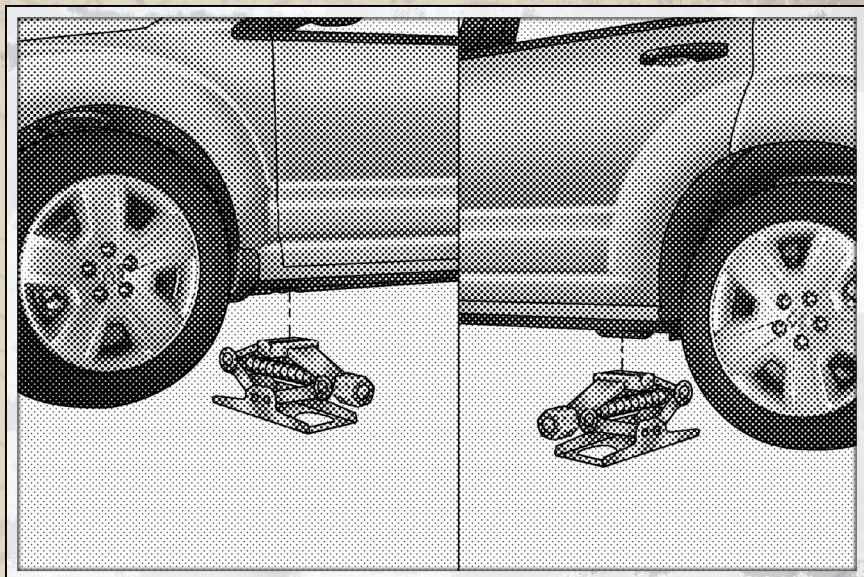

- Raise the vehicle by turning the jack screw clockwise. Raise the vehicle only until the tire just clears the surface and enough clearance is obtained to install the spare tire.

WARNING!

Raising the vehicle higher than necessary can make the vehicle less stable and cause an accident. It could slip off the jack and hurt someone near it. Raise the vehicle only enough to remove the tire.

- Remove the lug nuts, wheel cover (if equipped) and wheel.
- Position the spare wheel/tire on the vehicle and install the lug nuts with the cone-shaped end toward the wheel. Do NOT attempt to install a center cap or wheel cover on the compact spare. Lightly tighten the lug nuts clockwise. To avoid the risk of forcing the vehicle off the jack, do not tighten the nuts fully until the vehicle has been lowered.
- Lower the vehicle by turning the jack screw counterclockwise, and remove the jack and wheel blocks.
- Finish tightening the lug nuts. Push down on the wrench while tightening for increased leverage. Alternate nuts until each one has been tightened twice. The correct wheel nut tightness is 100 ft lbs (135 N•m). If in doubt about the correct tightness, have them checked with a torque wrench by your authorized dealer or at a service station.

WHAT TO DO IN EMERGENCIES

WARNING!

A loose tire or jack, thrown forward in an accident or hard stop, could endanger the occupants of the vehicle. Always stow the jack parts and the spare tire in the places provided.

- Secure the tire, jack, and tools in their proper locations.

JUMP-STARTING

- If your vehicle has a discharged battery it can be jumpstarted using a set of jumper cables and a battery in another vehicle or by using a portable battery booster pack.
- Jump-starting can be dangerous if done improperly so please follow the procedures in this section carefully.

NOTE: When using a portable battery booster pack follow the manufacturer's operating instructions and precautions.

CAUTION!

Do not use a portable battery booster pack or any other booster source with a system voltage greater than 12 Volts or damage to the battery, starter motor, alternator or electrical system may occur.

WARNING!

When temperatures are below the freezing point, electrolyte in a discharged battery may freeze. Do not attempt jump-starting because the battery could rupture or explode and cause personal injury. Battery temperature must be brought above the freezing point before attempting a jump-start.

Preparations for Jump-Start

- The battery in your vehicle is located in the front of the engine compartment below the air intake duct. To access the battery remove the air intake duct by turning the two finger screws, located on the radiator support.

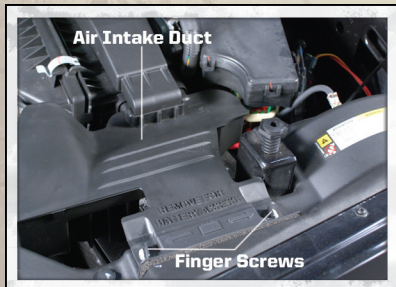

WHAT TO DO IN EMERGENCIES

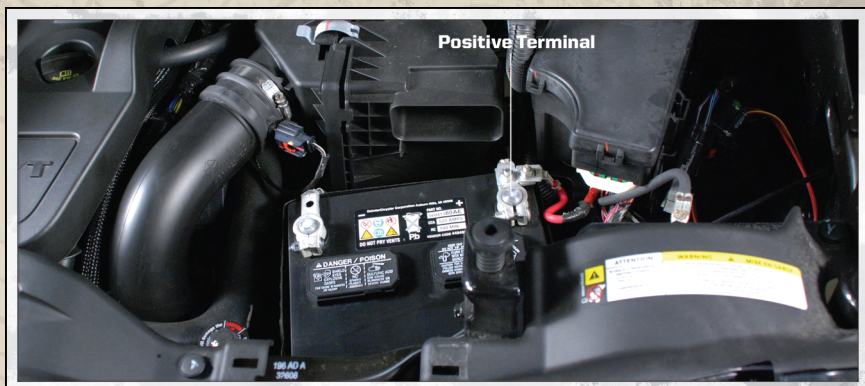

WARNING!

- Take care to avoid the radiator cooling fan whenever the hood is raised. It can start anytime the ignition switch is on. You can be injured by moving fan blades.
 - Remove any metal jewelry, such as watch bands or bracelets, that might make an inadvertent electrical contact. You could be severely injured.
 - Batteries contain sulfuric acid that can burn your skin or eyes and generate hydrogen gas which is flammable and explosive. Keep open flames or sparks away from the battery.
- Set the parking brake, shift the automatic transmission into PARK and turn the ignition to LOCK.
 - Turn off the heater, radio, and all unnecessary electrical accessories.
 - If using another vehicle to jump-start the battery, park the vehicle within the jumper cables reach, set the parking brake and make sure the ignition is OFF.

WARNING!

Do not allow vehicles to touch each other as this could establish a ground connection and personal injury could result.

Jump-Starting Procedure

WARNING!

Failure to follow this procedure could result in personal injury or property damage due to battery explosion.

WHAT TO DO IN EMERGENCIES

CAUTION!

Failure to follow these procedures could result in damage to the charging system of the booster vehicle or the discharged vehicle.

- Connect the positive (+) end of the jumper cable to the positive (+) post of the discharged vehicle.
- Connect the opposite end of the positive (+) jumper cable to the positive (+) post of the booster battery.
- Connect the negative end (-) of the jumper cable to the negative (-) post of the booster battery.
- Connect the opposite end of the negative (-) jumper cable to a good engine ground (exposed metal part of the discharged vehicle's engine) away from the battery and the fuel injection system.

WARNING!

Do not connect the cable to the negative post (-) of the discharged battery. The resulting electrical spark could cause the battery to explode and could result in personal injury.

- Start the engine in the vehicle that has the booster battery, let the engine idle a few minutes, and then start the engine in the vehicle with the discharged battery.
Once the engine is started, remove the jumper cables in the reverse sequence:
- Disconnect the negative (-) jumper cable from the engine ground of the vehicle with the discharged battery.
- Disconnect the negative end (-) of the jumper cable from the negative (-) post of the booster battery.
- Disconnect the opposite end of the positive (+) jumper cable from the positive (+) post of the booster battery.
- Disconnect the positive (+) end of the jumper cable from the positive (+) post of the discharged vehicle.
- Reinstall the air intake duct.
- If frequent jump-starting is required to start your vehicle you should have the battery and charging system inspected at your authorized dealer.

CAUTION!

Accessories that can be plugged into the vehicle power outlets draw power from the vehicle's battery, even when not in use (i.e., cellular phones, etc.). Eventually, if plugged in long enough, the vehicle's battery will discharge sufficiently to degrade battery life and/or prevent the engine from starting.

WHAT TO DO IN EMERGENCIES

TOWING A DISABLED VEHICLE

Model	Flat Towing (all four wheels on the ground)	Flatbed Towing (all four wheels suspended OFF the ground)	Front Wheels Raised, Rear Wheels on the Ground	Rear Wheels Raised, Front Wheels on the Ground
FWD Without a Key	NOT Permitted	Recommended Method	May Be Used	NOT Permitted
FWD Automatic Transmission With a Key	NOT Permitted	Recommended Method	May Be Used	NOT Permitted
FWD Manual Transmission With a Key	May be Used with the transmission in *NEUTRAL	Recommended Method	May Be Used	NOT Permitted
AWD Without a Key	NOT Permitted	Recommended Method	NOT Permitted	NOT Permitted
AWD Automatic Transmission With a Key	NOT Permitted	Recommended Method	NOT Permitted	NOT Permitted
AWD Manual Transmission With a Key	May be Used with the transmission in *NEUTRAL	Recommended Method	NOT Permitted	NOT Permitted

*To shift to NEUTRAL, there is a removable plug in the right side of the shift lever housing that allows you to insert your finger to override the system. The ignition key must be in the ON/RUN position to use the override lever.

WHAT TO DO IN EMERGENCIES

FREING A STUCK VEHICLE

- If your vehicle becomes stuck in mud, sand or snow, it can often be moved by a rocking motion. Turn your steering wheel right and left to clear the area around the front wheels. Then move the shift lever back and forth between REVERSE and DRIVE. Using minimal accelerator pedal pressure to maintain the rocking motion, without spinning the wheels, is most effective.

NOTE: To improve the vehicle's traction when starting off in deep snow, sand or gravel, it may be desirable to switch the Electronic Stability Control (ESC) to "Partial Off" mode by momentarily pressing the ESC Off  switch. For further information on ESC, refer to the Owner's Manual on the DVD.

WARNING!

Fast spinning tires can be dangerous. Forces generated by excessive wheel speeds may cause tire damage or failure. A tire could explode and injure someone. Do not spin your vehicle's wheels faster than 30 mph (48 km/h) when you are stuck. Do not let anyone near a spinning wheel, no matter what the speed.

CAUTION!

- When "rocking" a stuck vehicle by moving between 1st and REVERSE, do not spin the wheels faster than 15 mph (24 km/h), or drivetrain damage may result.
- Revving the engine or spinning the wheels too fast may lead to transmission overheating and failure. It can also damage the tires. Do not spin the wheels above 30 mph (48 km/h) while in gear (no transmission shifting occurring).

WHAT TO DO IN EMERGENCIES

EVENT DATA RECORDER (EDR)

- This vehicle is equipped with an event data recorder (EDR). The main purpose of an EDR is to record, in certain crash or near crash-like situations, such as an air bag deployment or hitting a road obstacle, data that will assist in understanding how a vehicle's systems performed. The EDR is designed to record data related to vehicle dynamics and safety systems for a short period of time, typically 30 seconds or less. The EDR in this vehicle is designed to record such data as:
 - How various systems in your vehicle were operating;
 - Whether or not the driver and passenger safety belts were buckled/fastened;
 - How far (if at all) the driver was depressing the accelerator and/or brake pedal; and,
 - How fast the vehicle was traveling.
- These data can help provide a better understanding of the circumstances in which crashes and injuries occur.

NOTE: EDR data are recorded by your vehicle only if a non-trivial crash situation occurs; no data are recorded by the EDR under normal driving conditions and no personal data (e.g. name, gender, age, and crash location) are recorded. However, other parties, such as law enforcement, could combine the EDR data with the type of personally identifying data routinely acquired during a crash investigation.

- To read data recorded by an EDR, special equipment is required, and access to the vehicle or the EDR is needed. In addition to the vehicle manufacturer, other parties such as law enforcement, that have the special equipment, can read the information if they have access to the vehicle or the EDR.

MAINTAINING YOUR VEHICLE

OPENING THE HOOD

- Pull the release lever located below the instrument panel and in front of the driver's door.
- Raise the hood and locate the safety latch, in the middle of the hood opening.
- Move the safety latch while lifting the hood at the same time.
- Insert the support rod into the slot on the hood.
- To close the hood, remove the support rod and place it in the retaining clip, then lower the hood slowly.

WARNING!

Be sure the hood is fully latched before driving your vehicle. If the hood is not fully latched, it could open when the vehicle is in motion and block your vision. Failure to follow this warning could result in serious injury or death.

MAINTAINING YOUR VEHICLE

ENGINE COMPARTMENT

2.0L Engine

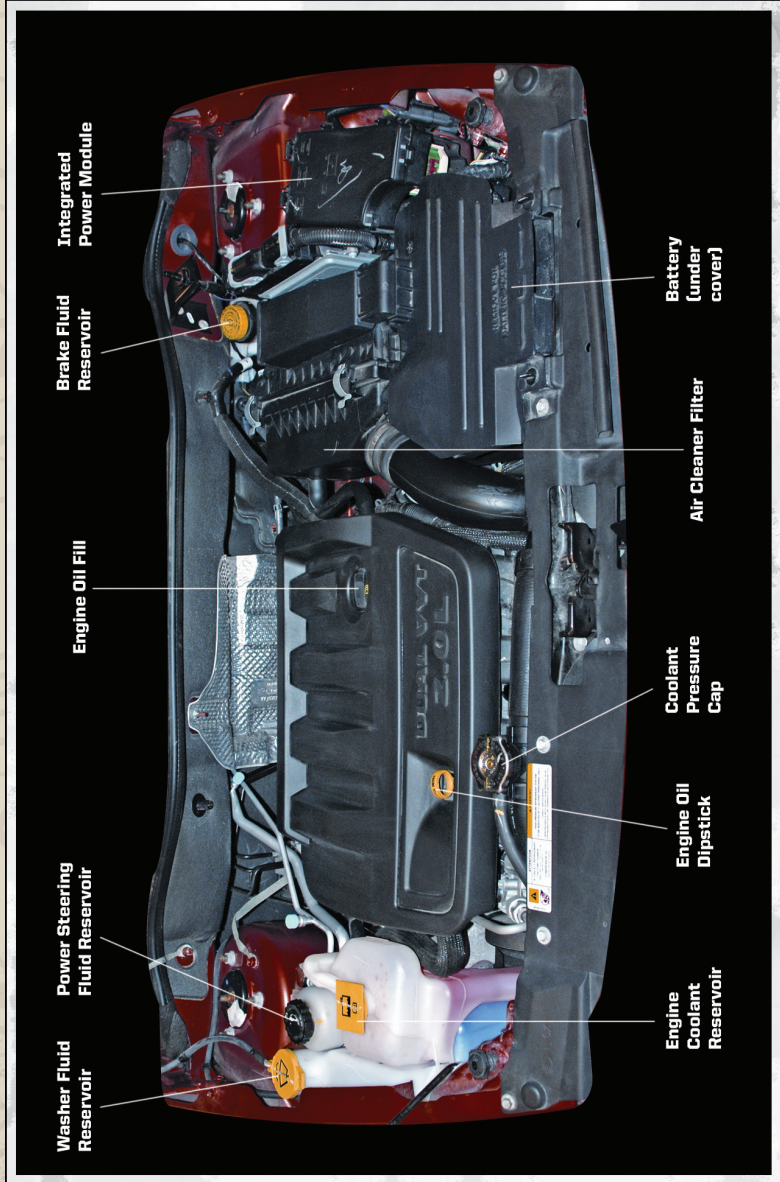

MAINTAINING YOUR VEHICLE

2.4L Engine

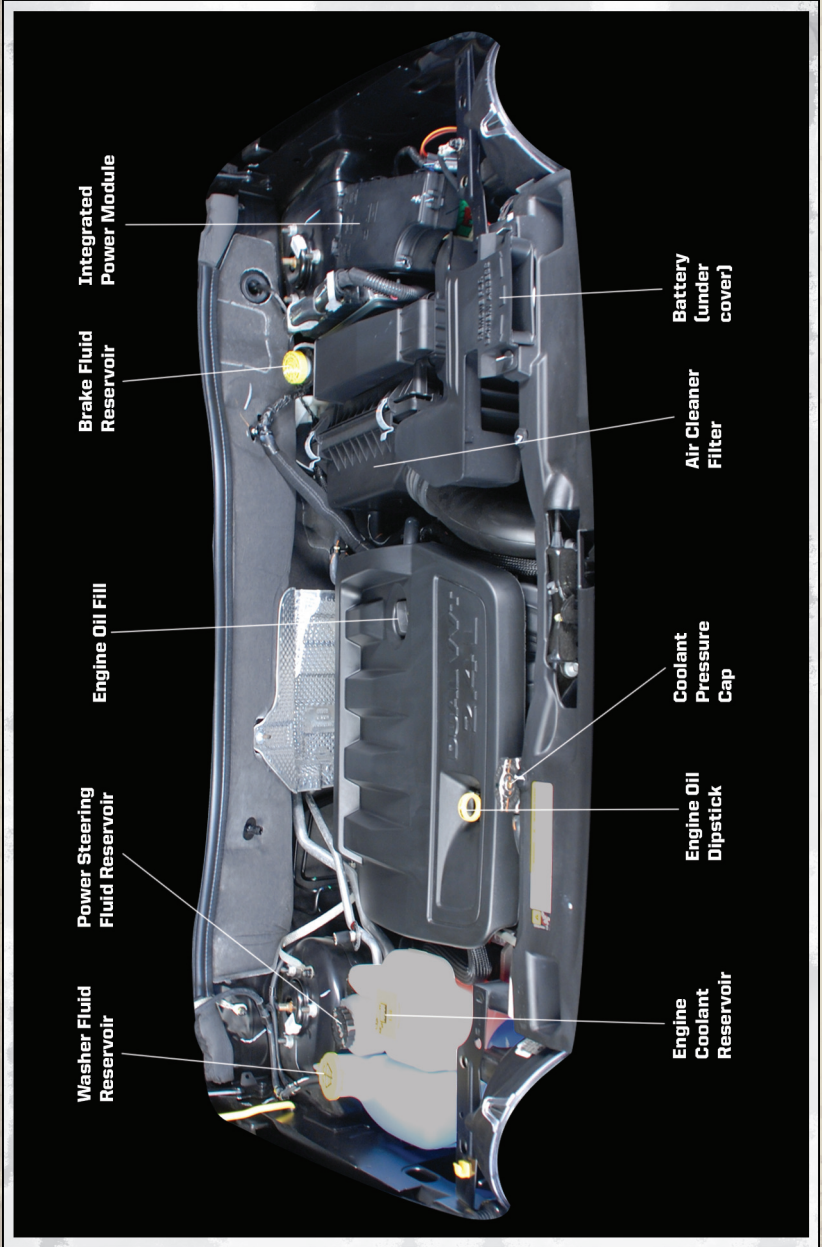

MAINTAINING YOUR VEHICLE

FLUIDS AND CAPACITIES

Component	Fluid, Lubricant, or Genuine Part	Capacities
Engine Coolant 2.0L, 2.4L	MOPAR® Antifreeze/Coolant Five Year/100,000 Mile Formula HOAT (Hybrid Organic Additive Technology) or equivalent.	7.2 Quarts (6.8 Liters) Includes heater and coolant recovery bottle filled to MAX level.
Engine Oil with Filter 2.0L, 2.4L	API Certified SAE 5W-20 engine oil, meeting the requirements of Chrysler Material Standard MS-6395. Refer to the engine oil filler cap for correct SAE grade.	4.5 Quarts (4.26 Liters)
Fuel Selection 2.0L, 2.4L	87 Octane	13.6 Gallons (51.5 Liters)
Engine Oil Filter 2.0L, 2.4L	MOPAR® Engine Oil Filter or equivalent.	—
Spark Plugs 2.0L, 2.4L	ZFR5F-11 (Gap 0.043 in [1.11 mm])	—
Automatic Transmission (CVT)	MOPAR® CVTF + 4® Automatic Transmission Fluid.	—
Manual Transmission	MOPAR® ATF+4® Automatic Transmission Fluid or equivalent licensed ATF+4® product.	—
Rear Drive Assembly (RDA)	MOPAR® Gear & Axle Lubricant SAE 80W-90 API GL 5 or equivalent non-synthetic product.	—
Power Transfer Unit (PTU)	MOPAR® Gear & Axle Lubricant SAE 80W-90 API GL 5 or equivalent non-synthetic product.	—
Brake Master Cylinder	MOPAR® DOT 3 and SAE J1703 should be used or equivalent. If DOT 3 is not available, then DOT 4 is acceptable. Use only recommended brake fluids or equivalent.	—

MAINTAINING YOUR VEHICLE

Component	Fluid, Lubricant, or Genuine Part	Capacities
Power Steering Reservoir	MOPAR [®] Power Steering Fluid +4 or MOPAR [®] ATF+4 [®] Automatic Transmission Fluid or equivalent licensed ATF+4 [®] product.	—

MAINTAINING YOUR VEHICLE

MAINTENANCE CHART

Miles:	6,000	12,000	18,000	24,000	30,000	36,000	42,000	48,000	54,000	60,000	66,000	72,000	78,000
Or Months:	6	12	18	24	30	36	42	48	54	60	66	72	78
Or Kilometers:	10,000	20,000	30,000	40,000	50,000	60,000	70,000	80,000	90,000	100,000	110,000	120,000	130,000
Change the engine oil and filter.	X	X	X	X	X	X	X	X	X	X	X	X	X
Rotate the tires.	X	X	X	X	X	X	X	X	X	X	X	X	X
If using your vehicle for any of the following: dusty or off-road conditions. Inspect the engine air cleaner filter; replace if necessary.		X		X		X		X				X	
Inspect the brake linings; replace if necessary.		X		X		X		X		X		X	
Replace the air conditioning filter.		X		X		X		X		X		X	
Inspect the CV joints. Perform the first inspection at 12,000 miles (20,000 km) or 12 months.		X		X		X		X				X	
Inspect the exhaust system. Perform the first inspection at 12,000 miles (20,000 km) or 12 months.		X		X		X		X				X	
Inspect the front suspension, tie rod ends and boot seals for cracks or leaks and all parts for damage, wear, improper looseness or end play; replace if necessary.		X		X		X		X		X		X	
Replace the engine air cleaner filter.					X					X			
Adjust the parking brake on vehicles equipped with four-wheel disc brakes.					X					X			
Change the manual transmission fluid if using your vehicle for any of the following: trailer towing, snow plowing, heavy loading, taxi, police, delivery service (commercial service), off road, desert operation or more than 50% of your driving is at sustained speeds during hot weather, above 90°F (32°C).								X					
Change the automatic transmission fluid & filter if using your vehicle for any of the following: police, taxi, fleet, or frequent trailer towing.										X			

• Refer to the Owner's Manual on the DVD for the complete maintenance schedule.

MAINTAINING YOUR VEHICLE

Maintenance Record

	Odometer	Date	Signature, Authorized Service Center
6,000 Miles (10,000 km) or 6 Months			
12,000 Miles (20,000 km) or 12 Months			
18,000 Miles (30,000 km) or 18 Months			
24,000 Miles (40,000 km) or 24 Months			
30,000 Miles (50,000 km) or 30 Months			
36,000 Miles (60,000 km) or 36 Months			
42,000 Miles (70,000 km) or 42 Months			
48,000 Miles (80,000 km) or 48 Months			
54,000 Miles (90,000 km) or 54 Months			
60,000 Miles (100,000 km) or 60 Months			
66,000 Miles (110,000 km) or 66 Months			
72,000 Miles (120,000 km) or 72 Months			
78,000 Miles (130,000 km) or 78 Months			

MAINTAINING YOUR VEHICLE

FUSES

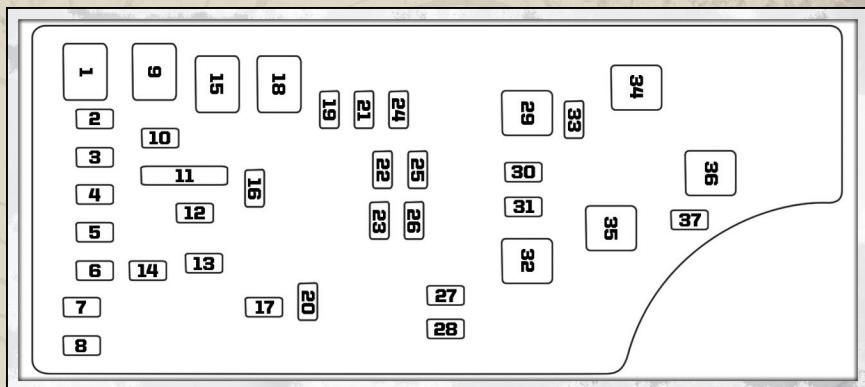

Integrated Power Module (IPM)

- The Integrated Power Module (IPM) is located in the engine compartment near the air cleaner assembly. This center contains cartridge fuses and mini-fuses.

Cavity	Cartridge Fuse	Mini-Fuse	Description
1	Empty		Empty
2		15 Amp Lt Blue	AWD/4WD ECU Feed
3		10 Amp Red	CHMSL Brake Switch Feed
4		10 Amp Red	Ignition Switch Feed/OCM
5		20 Amp Yellow	Trailer Tow
6		10 Amp Red	IOD Sw/Pwr Mir/Steering Cntrl Sdar/Hands-Free Phone
7		30 Amp Green	IOD Sense1
8		30 Amp Green	IOD Sense2
9	40 Amp Green		Power Seats
10		20 Amp Yellow	CCN Power Locks/Interior Lighting
11		15 Amp Lt Blue	Power Outlet
12		20 Amp Yellow	Ign Run/Acc Inverter
13		20 Amp Yellow	Pwr Run/Acc Outlet RR/Dome Lamp/Cigar Lighter
14		10 Amp Red	IOD CCN
15	40 Amp Green		RAD Fan Relay Battery Feed
16		15 Amp Lt Blue	IGN Run/ACC Dome Lamp/Sunroof/Rear Wiper Motor/ACC Inverter
17		10 Amp Red	IOD Feed Mod-Wcm
18	40 Amp Green		ASD Relay Contact PWR Feed
19		20 Amp Yellow	PWR Amp 1 & Amp 2 Feed
20		15 Amp Lt Blue	IOD Feed Radio

MAINTAINING YOUR VEHICLE

Cavity	Cartridge Fuse	Mini-Fuse	Description
21		10 Amp Red	IOD Feed Intrus Mod/Siren (If Equipped)
22		10 Amp Red	IGN RUN Heat/AC/Compass Sensor
23		15 Amp Lt Blue	ENG ASD Relay Feed 3
24		15 Amp Lt Blue	Power Sunroof Feed
25		10 Amp Red	Heated Mirror (If Equipped)
26		15 Amp Lt Blue	ENG ASD Relay Feed 2
27		10 Amp Red	IGN RUN Only ORC Feed
28		10 Amp Red	IGN RUN ORC/OCM Feed
29			Hot Car (No Fuse Required)
30		20 Amp Yellow	Heated Seat (If Equipped)
31		10 Amp Red	Headlamp Washer Relay Control (If Equipped)
32	30 Amp Pink		ENG ASD Control Feed 1
33		10 Amp Red	ABS MOD/J1962 Conn/PCM
34	30 Amp Pink		ABS Valve Feed
35	40 Amp Green		ABS Pump Feed
36	30 Amp Pink		Headlamp/Washer Control/Smart Glass (If Equipped)
37		25 Amp Natural	Diesel Fuel Heater (If Equipped)

TIRE PRESSURES

- Check the inflation pressure of each tire, including the spare tire, at least monthly and inflate to the recommended pressure for your vehicle.
- The tire pressures recommended for your vehicle are found on the “Tire and Loading Information” label located on the driver’s side door opening.

NOTE: Refer to the Owner’s Manual on the DVD for more information regarding tire warnings and instructions.

WARNING!

Overloading of your tires is dangerous. Overloading can cause tire failure, affect vehicle handling, and increase your stopping distance. Use tires of the recommended load capacity for your vehicle. Never overload them.

MAINTAINING YOUR VEHICLE

WARNING!

Improperly inflated tires are dangerous and can cause accidents. Under-inflation is the leading cause of tire failure and may result in severe cracking, component separation, or "blow out". Over-inflation reduces a tire's ability to cushion shock. Objects on the road and chuck holes can cause damage that results in tire failure. Unequal tire pressures can cause steering problems. You could lose control of your vehicle. Over-inflated or under-inflated tires can affect vehicle handling and can fail suddenly, resulting in loss of vehicle control.

WHEEL AND WHEEL TRIM CARE

- All wheels and wheel trim, especially aluminum and chrome plated wheels, should be cleaned regularly with a mild soap and water to prevent corrosion.
- To remove heavy soil and/or excessive brake dust, use MOPAR® Wheel Cleaner or equivalent or select a non-abrasive, non-acidic cleaner.

CAUTION!

Do not use scouring pads, steel wool, a bristle brush, or metal polishes. Do not use oven cleaner. These products may damage the wheel's protective finish. Avoid automatic car washes that use acidic solutions or harsh brushes that may damage the wheel's protective finish. Only MOPAR® Wheel Cleaner or equivalent is recommended.

EXTERIOR BULBS

LIGHT BULBS – Exterior	Bulb Number
Backup Lamp	W16W (921)
Center High-Mounted Stop Lamp (CHMSL)	LED (*)
Fog Lamp	PSX24W
Front Park/Turn Signal/Side Marker Lamp	3757AK
Rear Tail/Stop Lamp	3157
Rear Turn Lamp	3157AK or 3157A
Low Beam/High Beam Headlamp	H13
License Lamp	W5W
Off-Road Lamp	H3

* CHMSL is not serviceable. It is a LED lamp. To replace the LED, the entire CHMSL assembly must be replaced.

CONSUMER ASSISTANCE

CHRYSLER GROUP LLC CUSTOMER CENTER

P.O. Box 21-8004

Auburn Hills, MI 48321-8004

Phone: 1-877-426-5337

CHRYSLER CANADA INC. CUSTOMER CENTER

P.O. Box 1621

Windsor, Ontario N9A 4H6

Phone: 1-800-465-2001

ASSISTANCE FOR THE HEARING IMPAIRED

- To assist customers who have hearing difficulties, the manufacturer has installed special TDD (Telecommunication Devices for the Deaf) equipment at its customer center. Any hearing or speech impaired customer, who has access to a TDD or a conventional teletypewriter (TTY) in the United States, can communicate with the manufacturer by dialing 1-800-380-CHRY. Canadian residents with hearing difficulties that require assistance can use the special needs relay service offered by Bell Canada. For TTY teletypewriter users, dial 711 and for Voice callers, dial 1-800-855-0511 to connect with a Bell Relay Service operator.

WARNING!

Engine exhaust, some of its constituents, and certain vehicle components contain, or emit, chemicals known to the State of California to cause cancer and birth defects, or other reproductive harm. In addition, certain fluids contained in vehicles and certain products of component wear contain, or emit, chemicals known to the State of California to cause cancer and birth defects, or other reproductive harm.

PUBLICATIONS ORDERING

- If you are the first registered retail owner of your vehicle, you may obtain one free printed copy of the Owner's Manual, Warranty Booklet or Radio Manuals on your DVD by calling 1-877-426-5337 (U.S.) or 1-800-387-1143 (Canada) or by contacting your dealer.
- Replacement User Guides or DVDs or, if you prefer, additional printed copies of the Owner's Manual, Warranty Booklet or Radio Manuals may be purchased by visiting www.techauthority.com or by calling 1-800-890-4038 (U.S.) or 1-800-387-1143 (Canada). Visa, Master Card, American Express and Discover orders are accepted. If you prefer mailing your order, please call the above numbers for an order form.

NOTE: A street address is required when ordering manuals (no P.O. Boxes).

CONSUMER ASSISTANCE

NOTE:

- The Owner's Manual and User Guide electronic files are also available on the Chrysler, Jeep and Dodge websites.
- Click on the "For Owners" tab, select "Owner/Service Manuals", then select your desired model year and vehicle from the drop down lists.

REPORTING SAFETY DEFECTS IN THE 50 UNITED STATES AND WASHINGTON, D.C.

- If you believe that your vehicle has a defect that could cause a crash or cause injury or death, you should immediately inform the National Highway Traffic Safety Administration (NHTSA) in addition to notifying the manufacturer.
- If NHTSA receives similar complaints, it may open an investigation, and if it finds that a safety defect exists in a group of vehicles, it may order a recall and remedy campaign. However, NHTSA cannot become involved in individual problems between you, your authorized dealer, and the manufacturer.
- To contact NHTSA, you may either call the Auto Safety Hotline toll free at 1-888-327-4236 (TTY: 1-800-424-9153), or go to <http://www.safercar.gov>; or write to: Administrator, NHTSA, 1200 New Jersey Avenue, SE., West Building, Washington, D.C. 20590. You can also obtain other information about motor vehicle safety from <http://www.safercar.gov>.

In Canada

- If you believe that your vehicle has a safety defect, you should contact the Customer Service Department immediately. Canadian customers who wish to report a safety defect to the Canadian government should write to: Transport Canada, Motor Vehicle Defect Investigations and Recalls, 2780 Sheffield Road, Ottawa, Ontario K1B 3V9.

TIRE WARRANTY

Tire Limited Warranty And Adjustment Policy

- When a tire is removed from service due to a covered warranty condition under a tire manufacturer's "Limited Warranty Program", you may be eligible for a free tire replacement or a comparable new tire on a "prorated basis".
- Certain conditions, such as irregular wear or tire damage due to road hazards, collision, improper inflation, intentional alteration, and misuse, are excluded from the Limited Warranty Program. The Limited Warranty Program expires when your tires either wear to a specified tread depth, and/or after a period of time from the date of purchase, as stated in the Tire Warranty on the DVD.

NOTE: Refer to the Tire Warranty on the DVD for specific information relating to the manufacturer's limited warranty for the tires installed on your vehicle. If you have any questions regarding the limited tire warranty coverage, contact your local authorized dealer or your local authorized tire dealer.

CONSUMER ASSISTANCE

Disclaimer:

- THE TIRE MANUFACTURER'S LIMITED WARRANTY PROGRAM, THE DETAILS OF WHICH CAN BE FOUND ON THE OWNERS MANUAL DVD, THE TIRE MANUFACTURER'S WEBSITE OR AT ANY AUTHORIZED SERVICE CENTER ARE IN LIEU OF ALL OTHER REMEDIES OR WARRANTIES, EXPRESS OR IMPLIED, ARISING BY LAW OR OTHERWISE, INCLUDING FITNESS FOR A PARTICULAR PURPOSE OR MERCHANTABILITY. THE TIRE MANUFACTURER EXPRESSLY DISCLAIMS LIABILITY FOR INDIRECT, SPECIAL, INCIDENTAL OR CONSEQUENTIAL DAMAGES, LOST PROFIT, LOSS OF BUSINESS, LOSS OF GOODWILL, LOSS OF REPUTATION, PUNITIVE OR ANY OTHER DAMAGE, COST OR LOSS OF ANY KIND. SOME STATES AND PROVINCES DO NOT ALLOW THE EXCLUSION OR LIMITATION OF INCIDENTAL OR CONSEQUENTIAL DAMAGES, SO THE ABOVE LIMITATION OR EXCLUSION MAY NOT APPLY TO YOU.

WARNING!

NOTE: Refer to the Owner's Manual on the DVD for complete warning information that could prevent accidents, injuries and even deaths.

WARNING!

Death, serious injury and/or property damage may result from:

- Tire failure due to impact damage and/or improper maintenance.

(Continued)

WARNING! (Continued)

- Tires should be inspected regularly by a qualified technician for signs of damage, such as punctures, impacts, under-inflation or overloading.
- Progressive air loss may result from punctures, cuts, curbing, impacts or partial bead unseating.

Some fitment causes for air loss are:

- Incomplete bead seating.
- Bead tearing caused by a machine tool due to insufficient lubrication or improper adjustment.
- Leaking valve core or rubber valve components (these should be replaced when problems are detected and whenever tires are replaced).
- Tire failure due to improper repairs.
- See Rubber Manufacturer's Association (RMA) established repair procedures at www.rma.org for information on proper repair procedures. Never perform a temporary repair or use an inner tube as a substitute for a proper repair. Only qualified persons should repair tires.
- Explosion of tire/rim assembly due to improper mounting.
- Only specially trained persons should mount tires.
- Failure to mount tires on approved rims.
- Failure to deflate single or dual assemblies completely before demounting.

CONSUMER ASSISTANCE

Using Lift Kits

- Use of lift kits with some vehicle/tire combinations can cause instability or loss of control. When changing tire sizes, always consult an installer for optimum rim width and carefully check vehicle/tire clearances.

Check Your Tires For Damage

- Frequent (at least monthly) inspection of your tires for signs of damage, uneven tread wear and their general condition is important for safety. Impacts, penetrations, cracks, knots, bulges or air loss always require tire removal and expert inspection.

Tire Service Life

- The service life of a tire is dependent upon varying factors including, but not limited to, your driving style, tire pressure and distance driven.

WARNING!

Tires and the spare tire should be replaced after six years, regardless of the remaining tread. Failure to follow this warning can result in sudden tire failure. You could lose control and have an accident resulting in serious injury or death.

- Keep dismantled tires in a cool, dry place with as little exposure to the light as possible.
- Protect tires from contact with oil, grease, and gasoline.

NOTE: All tire warranties are made by the tire manufacturer. Tires are not covered under your Chrysler New Vehicle Limited Warranty.

MOPAR ACCESSORIES

MOPAR® ACCESSORIES

- The following highlights just some of the authentic Jeep Accessories by MOPAR® that have been engineered to customize your Jeep Compass.
- To see the full line of accessories, stop by your Jeep dealer or visit MOPAR.com.

CHROME:

- Mirror Covers
- Fuel Filler Door
- Taillamp guards

EXTERIOR:

- Driving Lights
- Sunroof Air Deflector
- Front Air Deflector
- Hitch Receiver
- Front End and Hood Cover
- Molded Splash Guards

INTERIOR:

- Premium Carpet Floor Mats
- Door Sill Guards
- Bright Pedal Kit
- Slush Mats
- Ambient Light Kit
- Heated Seats

ELECTRONICS:

- Portable Navigation Systems
- Uconnect™ Web (WiFi)
- Uconnect™ Phone
- iPod® Adapter
- Media Center 430 (RBZ Multimedia Radio)
- DVD Rear Seat Video™
- Kicker® Sound System
- Media Center 730N (RER Navigation Radio)
- Remote Start

CARRIERS:

- Hitch-mount Bike Carrier
 - Roof Mount Bike Carrier
 - Roof Box Cargo Carrier
 - Roof Mount Ski and Snowboard Carrier
 - Roof Mount Water Sports Carrier
 - Roof Mount Canoe Carrier
- iPod® is a registered trademark of Apple, Inc.
- Kicker® is a registered trademark of Stillwater Designs and Audio, Inc.

A vertical photograph of a dense forest. The trees are tall and thin, with their trunks running vertically. Sunlight filters through the green canopy, creating a dappled light effect. The overall tone is bright and natural.

**THE MORE
THERE IS TO EXPLORE**

This guide has been prepared to help you get quickly acquainted with your new Jeep and to provide a convenient reference source for common questions. However, it is not a substitute for your Owner's Manual.

For complete operational instructions, maintenance procedures and important safety messages, please consult your Owner's Manual, Navigation/Media Center Manuals and other Warning Labels in your vehicle.

Not all features shown in this guide may apply to your vehicle. For additional information on accessories to help personalize your vehicle, visit www.mopar.com or your local Jeep dealer.



JEEP.com

10MK49-926-AA
Compass
Third Printing
User Guide

