

marantz®

Network Receiver **M-CR510**

You can print more than one page of a PDF onto a single sheet of paper.

[Front panel](#)[Rear panel](#)[Remote](#)[Index](#)

Owner's Manual

Contents

Accessories	5
Inserting the batteries.....	6
Operating range of the remote control unit.....	6
Features	7
Multiple music formats are supported, all in a compact form factor.....	7
Easy operation.....	7

Part names and functions

Front panel	8
Rear panel	10
Remote control unit	12

Connections

Speaker connection	16
Connecting the speaker cables.....	16
Connection the subwoofer.....	17
Speaker connection.....	17
Connecting an analog device	18
Connecting a digital device	18
Connecting an iPod or USB memory device to the USB port	19
Connecting to a home network (LAN)	21
Wired LAN.....	21
Wireless LAN.....	22
Connecting the power cord	23

Playback

Basic operation	25
Turning the power on.....	25
Selecting the input source.....	25
Adjusting the master volume.....	26
Turning off the sound temporarily.....	26
Listening to Internet Radio	27
Listening to Internet Radio.....	28
Playing the last played Internet Radio station.....	29
Using vTuner to add Internet Radio stations to favorites.....	29
Playing back files stored on a PC and NAS	30
Applying media sharing settings.....	31
Playing back files stored on a PC and NAS.....	32
Listening to Pandora®	34
Listening to Pandora®.....	35
Creating a new station.....	35
Listening to an existing station.....	36
Play random songs from your stations (Quick Mix).....	36
Giving Feedback and Managing Stations.....	37
Sign Out.....	37
Listening to SiriusXM Internet Radio	38
Listening to SiriusXM Internet Radio.....	39
Sign Out.....	39
Listening to Spotify	40
Listening to Spotify.....	40



Favorite function	<u>43</u>
Registering stations or files to the favorites list	<u>44</u>
Calling stations or files from the favorites list	<u>44</u>
To switch between registered stations and files during playback	<u>44</u>
Deleting stations or files from the favorite list	<u>44</u>
Playing iPod	<u>45</u>
Listening to music on an iPod	<u>46</u>
Setting operation mode (Remote iPod Mode)	<u>47</u>
Charging the iPod/iPhone	<u>48</u>
Playing a USB memory device	<u>49</u>
Playing files stored on USB memory devices	<u>50</u>
Listening to ANALOG IN	<u>51</u>
Listening to DIGITAL IN	<u>51</u>
AirPlay function	<u>52</u>
Streaming music stored in iPhone, iPod touch, or iPad directly to the unit	<u>52</u>
Playing iTunes music with this unit	<u>53</u>
Selecting multiple speakers (devices)	<u>53</u>
Perform iTunes playback operations with the remote control unit of this unit	<u>54</u>
Remote play function	<u>55</u>
Settings required for each device	<u>56</u>
Web control function	<u>57</u>
Controlling the unit from a web control	<u>57</u>
Other functions	<u>62</u>
Adjusting the tone	<u>63</u>
Sleep timer function	<u>64</u>
Checking the current time	<u>64</u>
Switching the display's brightness	<u>64</u>

Settings

Menu map	<u>65</u>
Menu operation	<u>67</u>
Inputting characters	<u>68</u>
Using the number buttons	<u>68</u>
Using the cursor buttons	<u>68</u>
General	<u>69</u>
Alarm	<u>69</u>
Clock	<u>70</u>
Speaker Response	<u>70</u>
Language	<u>71</u>
Auto-Standby	<u>71</u>
Firmware	<u>71</u>
Network	<u>74</u>
Network Information	<u>74</u>
Network Control	<u>74</u>
Friendly Name	<u>74</u>
Settings	<u>75</u>



Tips

Contents	<u>78</u>
Tips.....	<u>79</u>
Troubleshooting	<u>80</u>
Resetting factory settings	<u>89</u>

Appendix

Playing back USB memory devices.....	<u>90</u>
Playing back Internet Radio	<u>91</u>
Playing back files stored on PC or NAS.....	<u>92</u>
Last function memory.....	<u>92</u>
Explanation of terms	<u>93</u>
Trademark information.....	<u>97</u>
Specifications	<u>98</u>
Index	<u>101</u>
License	<u>103</u>



Thank you for purchasing this Marantz product. To ensure proper operation, please read this owner's manual carefully before using the product. After reading this manual, be sure to keep it for future reference.

Accessories

Check that the following parts are supplied with the product.

① Quick Setup Guide

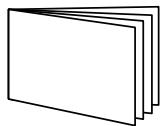

② CD-ROM (Owner's Manual)

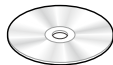

③ Safety Instructions

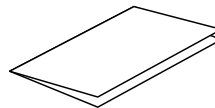

④ Warranty
(for USA)
(for CANADA)

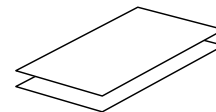

⑤ Notes on radio

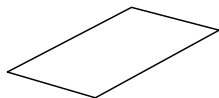

⑥ Power cord

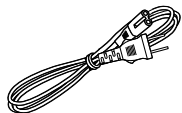

⑦ Remote control unit (RC010CR)

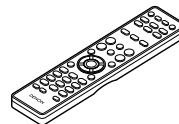

⑧ R03/AAA batteries



Inserting the batteries

- 1 Remove the rear lid in the direction of the arrow and remove it.

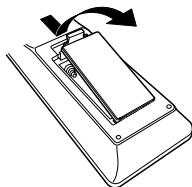

- 2 Load the two batteries properly as indicated by the ⊕ and ⊖ marks in the battery compartment.

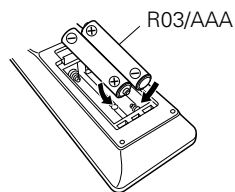

- 3 Put the rear cover back on.

NOTE

- When inserting the batteries, be sure to do so in the proper direction, following the ⊕ and ⊖ marks in the battery compartment.
- To prevent damage or leakage of battery fluid:
 - Do not use a new battery together with an old one.
 - Do not use two different types of batteries.
- Remove the batteries from the remote control unit if it will not be in use for long periods.
- If the battery fluid should leak, carefully wipe the fluid off the inside of the battery compartment and insert new batteries.

Operating range of the remote control unit

Point the remote control unit at the remote sensor when operating it.

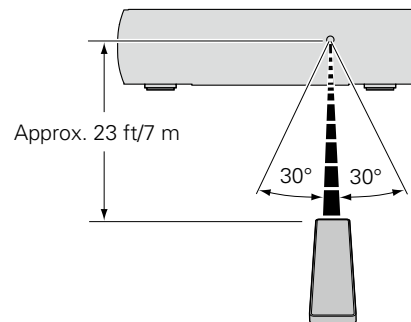

Features

Multiple music formats are supported, all in a compact form factor

- **Supports Internet Radio and music streaming**
Supports AirPlay® (👉 [page 52](#))
You can enjoy a wide variety of content, including listening to Internet Radio, playing audio files stored on your PC.
This unit also supports Apple AirPlay which lets you stream your music library from an iPhone®, iPad®, iPod touch® or iTunes®.
- **DLNA ver. 1.5 support for audio networks**
- **Supports online music, including Pandora®, SiriusXM, Spotify**
- **Support for High Quality Audio playback**
WAV/FLAC/ALAC (Apple Lossless Audio Codec)
- **Support for Gapless playback**
Playback with no gap between music files (for WAV/FLAC only)
- **Wi-Fi network capability with built-in diversity antenna, and is certified under WMM (Wi-Fi Multi Media) for efficient wireless connectivity**

Easy operation

- **Easy wireless connection is possible by pressing the Wi-Fi CONNECT button (WPS and Wi-Fi Sharing)**
See the separate “Quick Setup Guide”.
- **iPod auto detect charges your device even after the unit switches to standby mode**
- **Compatible with “Marantz Remote App” for performing basic operations of the unit with an iPad, iPhone or Android* smartphone**
“Marantz Remote App” is application software that allows you to perform basic operations with an iPad, iPhone, Android smartphone or Android tablet such as turning the unit ON/OFF, controlling the volume, and switching the source.
* Download the appropriate “Marantz Remote App” for iOS and Android devices. This unit needs to be connected to your LAN and the iPad, iPhone, Android smartphone, Android tablet or other device needs to be connected to the same network by Wi-Fi (wireless LAN).
- **3 Line OLED (Organic Light Emitting Diode) display**
- **Auto Standby mode for energy savings**



Part names and functions

Front panel

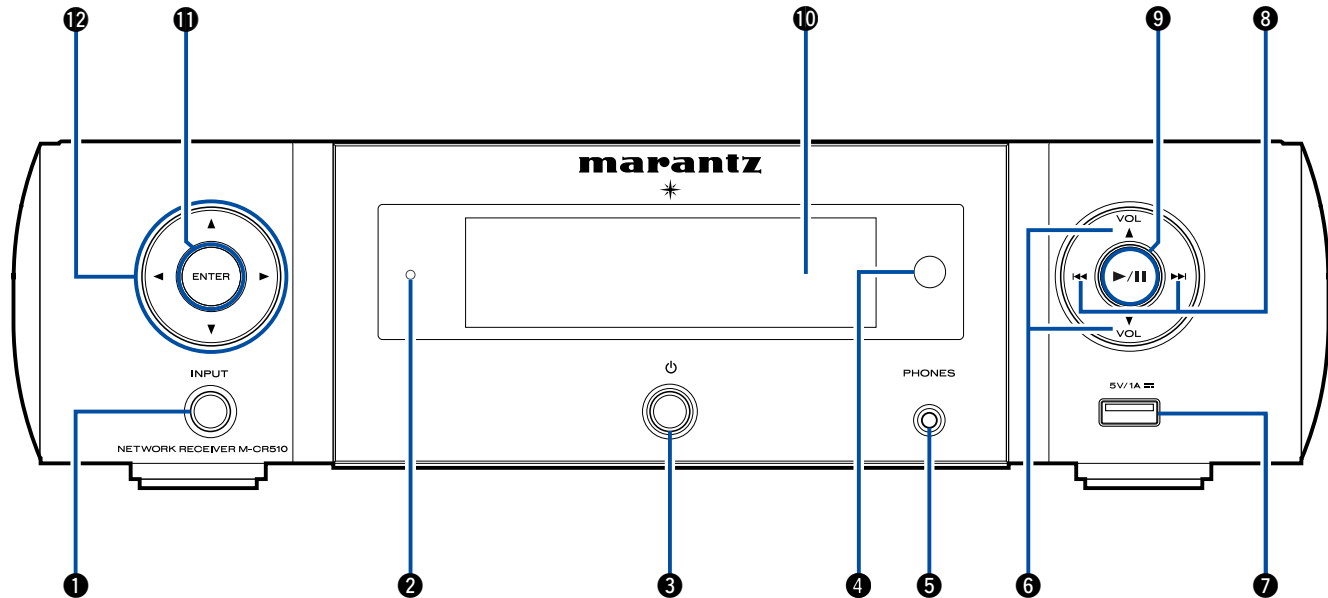

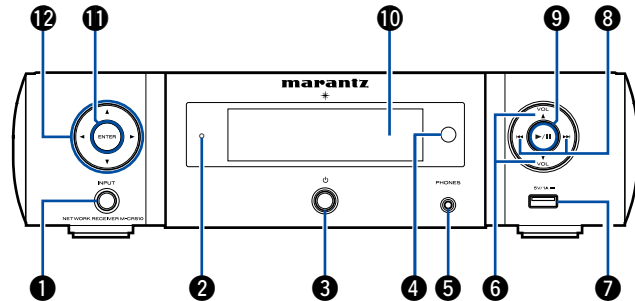

1 INPUT button

Selects the input source.

2 Standby indicator

The standby indicator changes as shown below according to the status of the unit.

- Power on : Off
- Standby : Off
- When "Network Control" is set to "On" : Red (☞ page 74)
- iPod charge standby : Red (☞ page 48)
- Alarm standby : Orange (☞ page 69)
- Display off : Green (☞ page 64)

3 Power operation button (⏻)

Turns power to this unit on and off (standby).

4 Remote control sensor

This receives signals from the remote control unit (☞ page 6).

5 Headphones jack (PHONES)

Used to connect headphones.

When the headphones are plugged into this jack, audio will no longer be output from the connected speakers.

NOTE

- To prevent hearing loss, do not raise the volume level excessively when using headphones.

6 Volume up/down button (VOLUME ▲▼)

Adjusts the audio volume.

7 USB port (Front)

Used to connect iPod or USB memory devices (☞ page 19).

8 Reverse-skip/Forward-skip buttons (◀◀, ▶▶)

9 Play/Pause button (▶/⏸)

10 Display

Various information is displayed here.

11 ENTER button

This determines the selection.

12 Cursor button (△▽◀▶)

These select items.



Rear panel

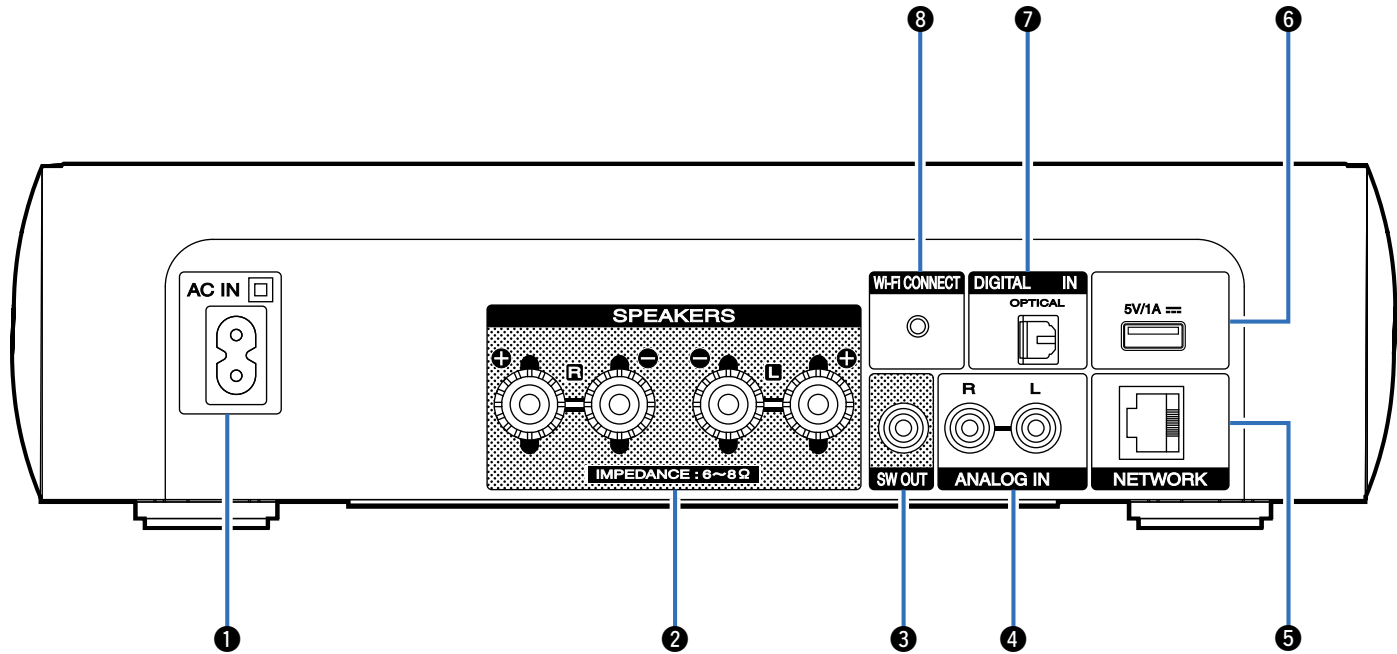

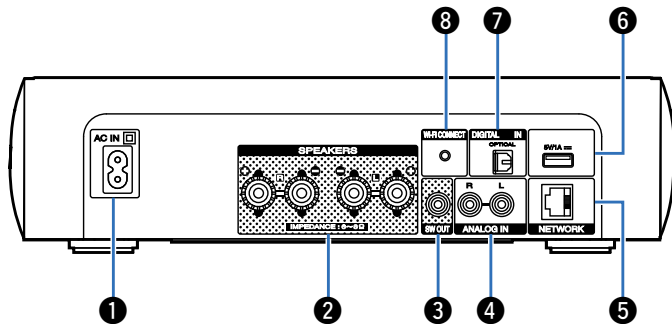

1 AC inlet (AC IN)

Used to connect the power cord (🔗 page 23).

2 Speaker terminals (SPEAKERS)

Used to connect speakers (🔗 page 16, 17).

3 SW OUT connector

Used to connect a subwoofer with a built-in amplifier (🔗 page 17).

4 ANALOG IN connectors

Used to connect devices equipped with analog audio connectors (🔗 page 18).

5 NETWORK connector

Used to connect this unit to the network (🔗 page 21).

6 USB port (Rear)

Used to connect iPod or USB memory devices (🔗 page 19).

7 DIGITAL IN connector

Used to connect devices equipped with digital audio connector (🔗 page 18).

8 Wi-Fi CONNECT button

Used to connect to the wireless LAN.
(See the separate “Quick Setup Guide”.)



Remote control unit

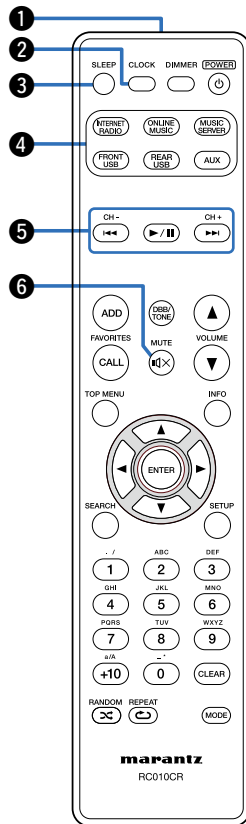

1 Remote control signal transmitter

This transmits signals from the remote control unit (🔗 page 6).

2 CLOCK button

The current time appear on the unit (🔗 page 70).

3 SLEEP button

This sets the sleep timer (🔗 page 64).

4 Input source select buttons

These select the input source (🔗 page 25).

5 System buttons

These perform playback related operations (🔗 page 28, 32, 34, 38, 40, 47, 50).

- Previous / Next buttons (⏮, ⏭)
- Play/pause button (▶/⏸)

Channel buttons (CH +, -)

These operate the Favorite function (🔗 page 43).

6 MUTE button (🔇)

This mutes the output audio (🔗 page 26).



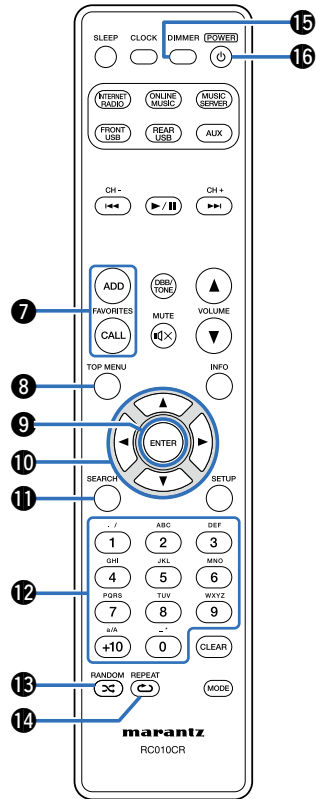

7 FAVORITES ADD / CALL buttons

- To add radio stations or files to the favorite list, press ADD.
- To call up a radio station or file registered in the favorite list, press CALL (☞ page 43).

8 TOP MENU button

To back to the top of the menu (☞ page 67).

9 ENTER button

This determines the selection (☞ page 67).

10 Cursor buttons (△▽◀▶)

These select items (☞ page 67).

11 SEARCH button

This displays the search menu (☞ page 28, 50).

12 Number buttons (0 – 9, +10)

These enter letters or numbers into the unit (☞ page 68).

13 RANDOM button

Switches the random playback.

14 REPEAT button

Switches the repeat playback (☞ page 32, 40, 47, 50).

15 DIMMER button

Adjust the display brightness of this unit (☞ page 64).

16 POWER button (⏻)

This turns the power on/standby (☞ page 25).

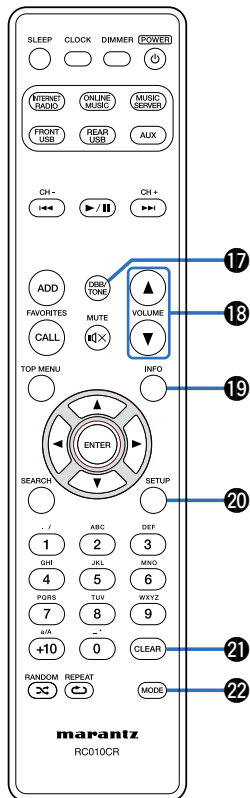

**17 DBB/TONE button**

Adjusting the tone (☞ page 63).

18 VOLUME buttons (▲▼)

These adjust the volume level (☞ page 26).

19 Information button (INFO)

This switches display items such as the album name and title name in the playback screen (☞ page 32, 34, 39, 47, 49).

20 SETUP button

This displays the setup menu on the display (☞ page 67).

21 CLEAR button

This cancels the settings (☞ page 44, 68).

22 MODE button

Switching the operation mode (☞ page 47).



Connections

Speaker connection (👉 page 16)

Connecting an analog device (👉 page 18)

Connecting a digital device (👉 page 18)

Connecting an iPod or USB memory device to the USB port (👉 page 19)

Connecting to a home network (LAN) (👉 page 21)

Connecting the power cord (👉 page 23)

NOTE

- Do not plug in the power cord until all connections have been completed.
- Do not bundle power cords together with connection cables. Doing so can result in noise.

■ Cables used for connections

Provide necessary cables according to the devices you want to connect.

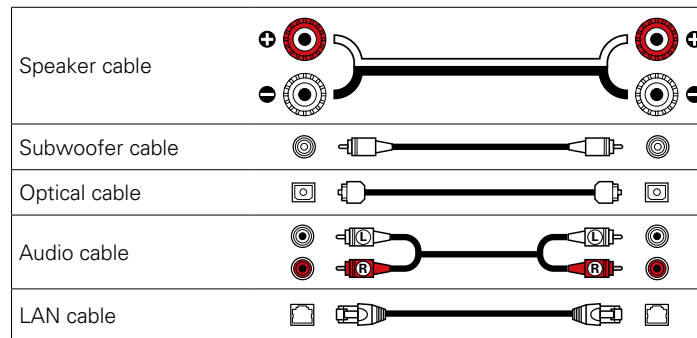

Speaker connection

Here we connect the speakers in the room to this unit.
This section explains how to connect them using typical examples.

NOTE

- Disconnect this unit's power plug from the power outlet before connecting the speakers. Also, turn off the subwoofer.
- Connect so that the speaker cable core wires do not protrude from the speaker terminal. The protection circuit may be activated if the core wires touch the rear panel or if the + and – sides touch each other (see page 95 "Protection circuit").
- Never touch the speaker terminals while the power cord is connected. Doing so could result in electric shock.
- Use speakers with an impedance of 6 – 8 Ω /ohms. The protection circuit may be activated if speakers with an impedance other than specified are used.

Connecting the speaker cables

Carefully check the left (L) and right (R) channels and + (red) and – (black) polarities on the speakers being connected to this unit, and be sure to connect the channels and polarities correctly.

1 Peel off about 3/8 inch (10 mm) of sheathing from the tip of the speaker cable, then either twist the core wire tightly or terminate it.



2 Turn the speaker terminal counterclockwise to loosen it.

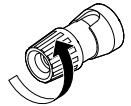

3 Insert the speaker cable's core wire to the hilt into the speaker terminal.

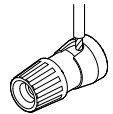

4 Turn the speaker terminal clockwise to tighten it.

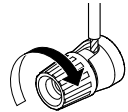

Connection the subwoofer

Use a subwoofer cable to connect the subwoofer.

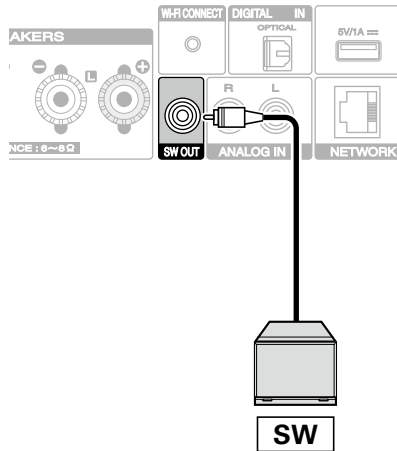

Speaker connection

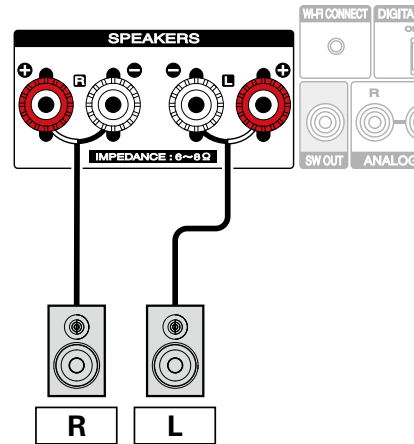

Connecting an analog device

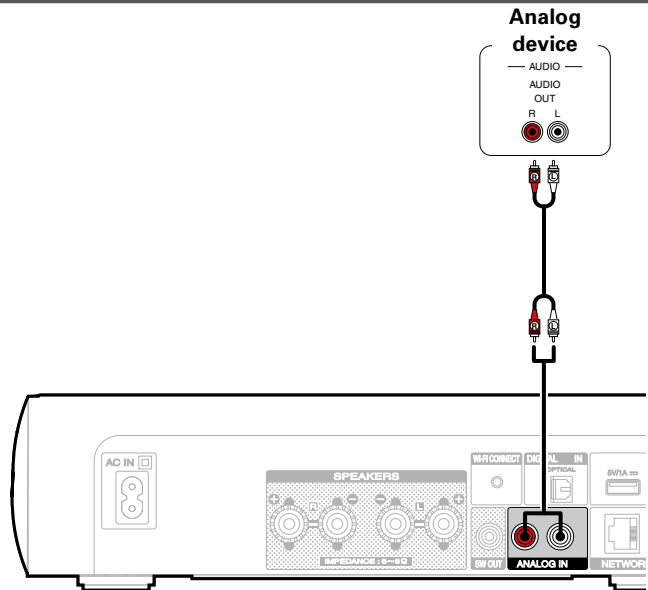

Connecting a digital device

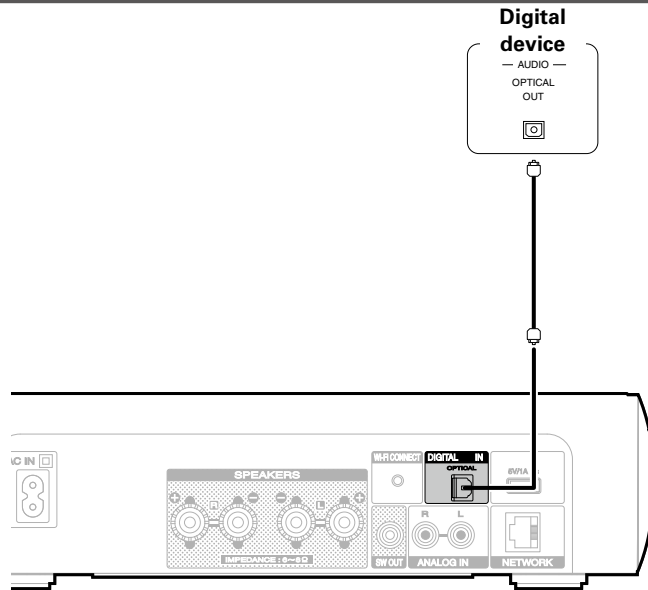

Connecting an iPod or USB memory device to the USB port

To connect an iPod to this unit, use the USB adapter cable that was supplied with the iPod.

For operating instructions see “Playing iPod” (🔗 page 45) or “Playing a USB memory device” (🔗 page 49).

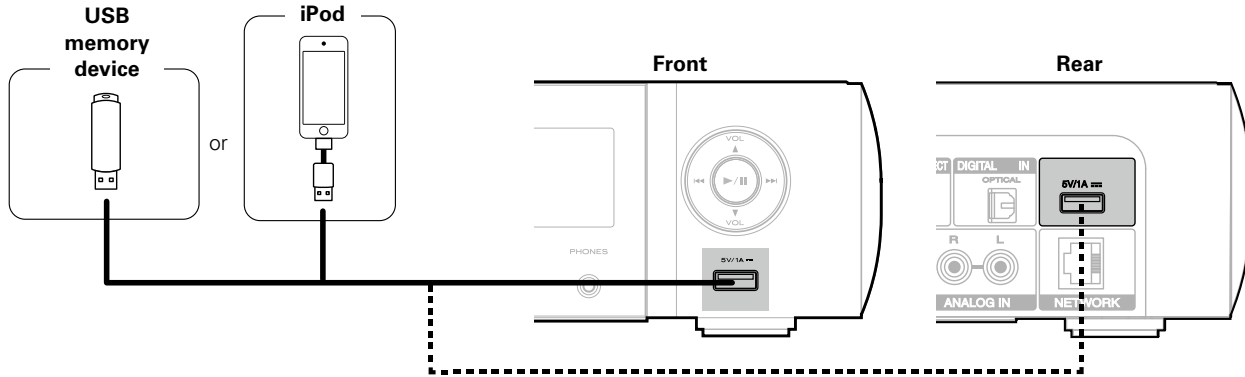

- Marantz does not guarantee that all USB memory devices will operate or receive power. When using a portable USB hard disk drive (HDD) which came with an AC adapter, use that device's supplied AC adapter.

NOTE

- USB memory devices will not work via a USB hub.
- It is not possible to use this unit by connecting the unit's USB port to a PC via a USB cable.
- Do not use an extension cable when connecting a USB memory device. This may cause radio interference with other devices.



■ Supported iPod / iPhone models

• iPod classic



iPod classic
80GB



iPod classic
160GB (2007)



iPod classic
160GB (2009)

• iPod nano



iPod nano
3rd generation
(video)
4GB 8GB



iPod nano
4th generation (video)
8GB 16GB



iPod nano
5th generation (video camera)
8GB 16GB



iPod nano
6th generation
8GB 16GB



iPod nano
7th generation
16GB

• iPod touch



iPod touch
1st generation
8GB 16GB 32GB



iPod touch
2nd generation
8GB 16GB 32GB



iPod touch
3rd generation
32GB 64GB



iPod touch
4th generation
8GB 32GB 64GB



iPod touch
5th generation
32GB 64GB

• iPhone



iPhone
4GB 8GB 16GB



iPhone 3G
8GB 16GB



iPhone 3GS
8GB 16GB 32GB



iPhone 4
8GB 16GB 32GB



iPhone 4S
16GB 32GB 64GB



iPhone 5
16GB 32GB 64GB



Connecting to a home network (LAN)

You can connect this unit to your home network (LAN) to perform various types of playbacks and operations as follows.

- Playback of network audio such as Internet Radio and from your media server(s)
- Playback of music content from online streaming services
- Using the Apple AirPlay function
- Operation on this unit via the network
- Firmware Update

Wired LAN

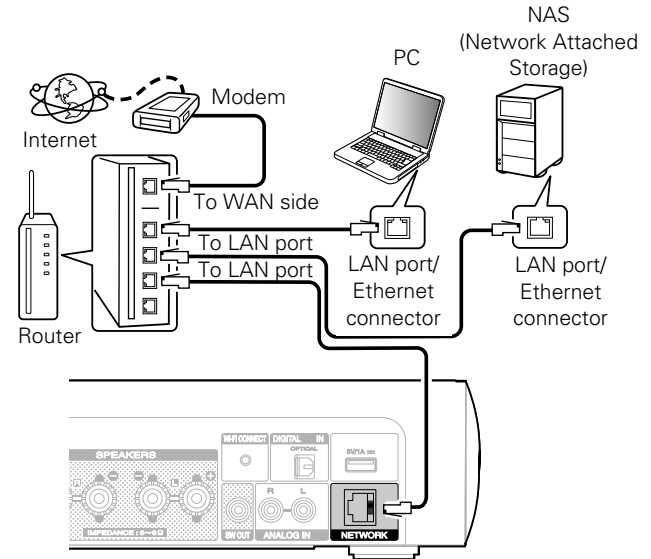

For connections to the Internet, contact an ISP (Internet Service Provider) or a computer shop.



Wireless LAN

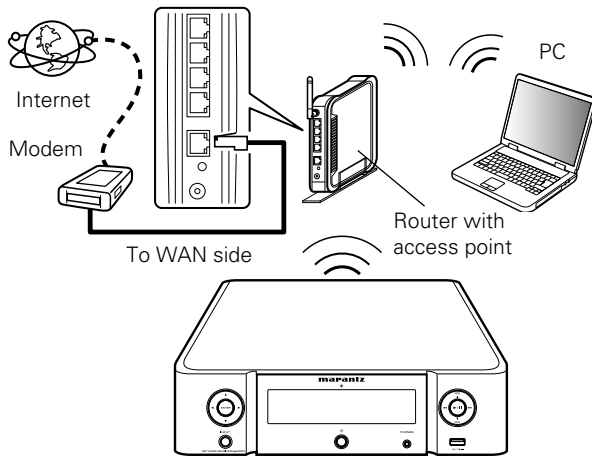

* This unit comes with a built-in Wi-Fi antenna.



- With this unit, it is possible to use the DHCP and Auto IP functions to make the network settings automatically.
- When using this unit with the broadband router's DHCP function enabled, this unit automatically performs the IP address setting and other settings. When using this unit connected to a network with no DHCP function, make the settings for the IP address, etc., at "Network" (☞ page 74).
- When using this unit, we recommend you use a router equipped with the following functions:
 - Built-in DHCP server
This function automatically assigns IP addresses on the LAN.
 - Built-in 100BASE-TX switch
When connecting multiple devices, we recommend a switching hub with a speed of 100 Mbps or greater.
- Use only a shielded STP or ScTP LAN cable which is easily available at electronics stores (CAT-5 or greater recommended).
- The normal shielded-type LAN cable is recommended. If a flat-type cable or unshielded-type cable is used, other devices could be affected by noise.
- When using a WPS (Wi-Fi Protected Setup) compatible router, easy wireless connection is possible by pressing this unit's Wi-Fi CONNECT button. (See the separate "Quick Setup Guide".)

NOTE

- The types of routers that can be used depend on the ISP. Contact your ISP or a computer shop for details.
- This unit is not compatible with PPPoE. A PPPoE-compatible router is required if you have a contract for a type of line set by PPPoE.
- Do not connect an NETWORK connector directly to the LAN port/ Ethernet connector on your computer.



Connecting the power cord

After completing all the connections, insert the power plug into the power outlet.

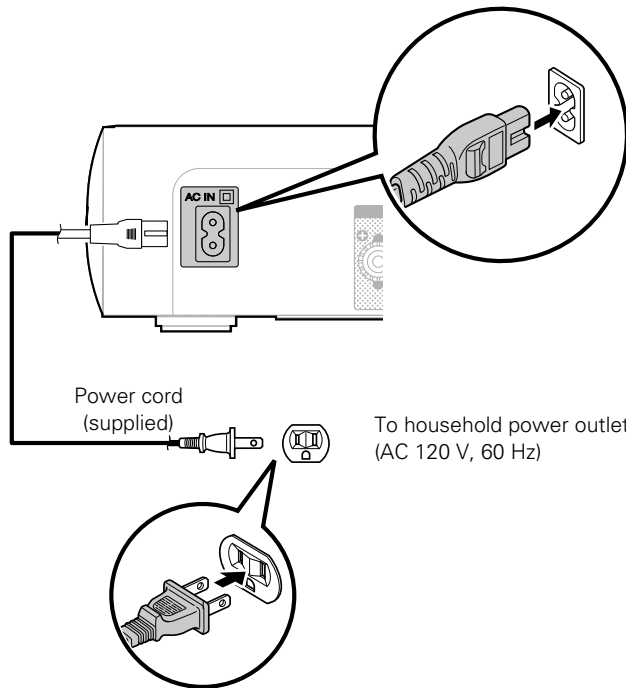

Playback

Turning the power on (👉 page 25)

Selecting the input source (👉 page 25)

Adjusting the master volume (👉 page 26)

Turning off the sound temporarily (👉 page 26)

Listening to Internet Radio (👉 page 27)

Playing back files stored on a PC and NAS (👉 page 30)

Listening to Pandora® (👉 page 34)

Listening to SiriusXM Internet Radio (👉 page 38)

Listening to Spotify (👉 page 40)

Favorite function (👉 page 43)

Playing iPod (👉 page 45)

Playing a USB memory device (👉 page 49)

Listening to ANALOG IN (👉 page 51)

Listening to DIGITAL IN (👉 page 51)

AirPlay function (👉 page 52)

Remote play function (👉 page 55)

Web control function (👉 page 57)

Adjusting the tone (👉 page 63)

Sleep timer function (👉 page 64)

Checking the current time (👉 page 64)

Switching the display's brightness (👉 page 64)



Basic operation

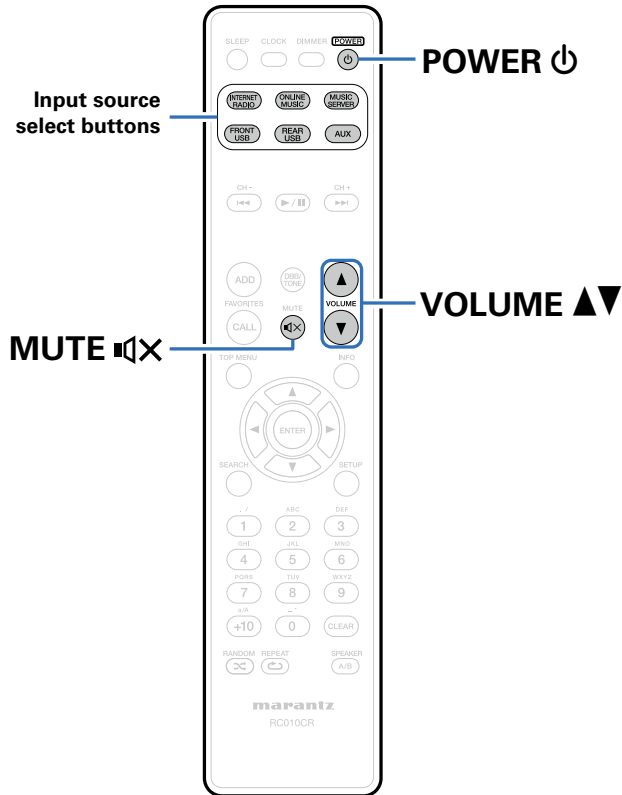

Turning the power on

1 Press **POWER** to turn on power to the unit.



- You can also switch the power to standby by pressing on the main unit.

Selecting the input source

1 Press the **input source select button** to be played back.
The desired input source can be selected directly.



- Press the **AUX** again to switch between Analog In / Digital In.
- You can also select the input source by pressing **INPUT** on the main unit.



Adjusting the master volume

1 Use **VOLUME ▲▼** to adjust the volume.

The volume level is displayed.



- You can also adjust the master volume by turning **VOLUME ▲▼** on the main unit.

Turning off the sound temporarily

1 Press **MUTE** .

The “MUTING” is displayed.



- To cancel, press **MUTE**  again.



Listening to Internet Radio

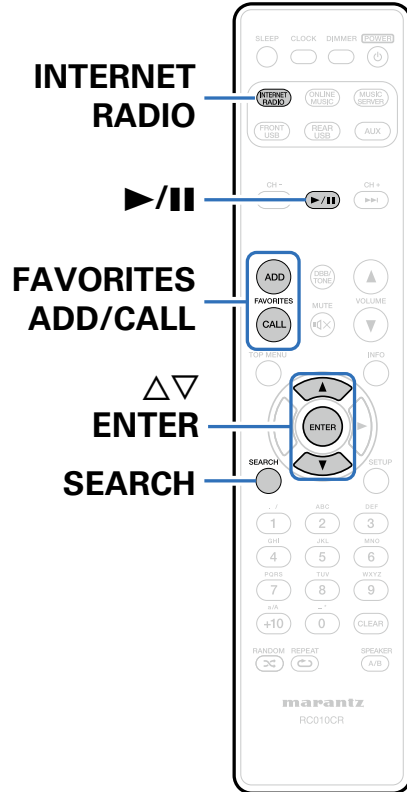

- Internet Radio refers to radio broadcasts distributed over the Internet. Internet Radio stations from around the world can be received.
- The broadcast station types and specifications supported by this unit for playback are as follows.
 - **WMA** (Windows Media Audio)
 - **MP3** (MPEG-1 Audio Layer-3)
 - **MPEG-4 AAC**



Listening to Internet Radio

This unit memorizes the last played Internet Radio station. If you press INTERNET RADIO to switch to the Internet Radio function from another input source, the last Internet Radio station you listened to is played.

1 Prepare for playback.

- Check the network environment, then turn on this unit's power (☞ page 21 "Connecting to a home network (LAN)").

2 Press INTERNET RADIO.

3 Use Δ / ∇ to select the you want to play, then press ENTER.

***** (Country name) :

- Displays typical Internet Radio stations your country.

Search Stations :

- Displays all Internet Radio stations that this unit can tune in to.

Search Podcasts :

- Displays Internet Radio stations in the podcasts that this unit can tune in to.

Recommended Stations :

- Displays recommended Internet Radio stations.

radiomarantz.com :

- Displays Internet Radio stations added to favorites in vTuner. For instructions on how to add to favorites in vTuner, see "Using vTuner to add Internet Radio stations to favorites" (☞ page 29).

Recently Played :

- Displays recently played Internet Radio stations. Up to 20 stations can be stored in "Recently Played".

Search by Keyword :

- Displays Internet Radio stations searched by keyword. For character input, see page 68.

4 Use Δ / ∇ to select the station, then press ENTER.

Playback starts once buffering reaches "100%".

Operation buttons	Function
\blacktriangleright / \parallel	Playback / Stop
FAVORITES CALL	Call from the Favorite list
FAVORITES ADD	Registration to the Favorite list
	Character search
SEARCH	<ul style="list-style-type: none"> • If the list is not in alphabetical order, you may not be able to perform a character search.
INTERNET RADIO	Last played Internet Radio station
INFO	Switching the file type/ bit rate and radio station name etc. display



- Any characters that cannot be displayed are replaced with "." (period).

NOTE

- The radio station database service may be suspended or be otherwise unavailable without notice.





Playing the last played Internet Radio station

- 1 **Press INTERNET RADIO.**
The source switches to "Internet Radio" and the last played radio station plays.

Using vTuner to add Internet Radio stations to favorites

There are many Internet Radio stations in the world, and this unit can tune into these stations. But finding the radio station you want to hear may be difficult, because there are too many stations. If this is the case, then please use vTuner, an Internet Radio station search website specifically designed for this unit. You can use your PC to search Internet Radio stations and add them as your favorites. This unit can play radio stations added to vTuner.

- 1 **Check the MAC address of this unit** ( [page 74](#) "Network Information").
 - The MAC address is necessary when you create an account for vTuner.
- 2 **Use your PC to access the vTuner website** (<http://www.radiomarantz.com>).

- 3 **Enter the MAC address of this unit, then click "Go".**
- 4 **Enter your E-mail address and a password of your choice.**
- 5 **Select the search criteria (genre, region, language, etc.) of your choice.**
 - You can also enter a keyword to search for a station you want to hear.
- 6 **Select the radio station of your choice from the list, and then click the Add to Favorites icon.**
- 7 **Enter the name of the favorite group, then click "Go".**
A new favorite group that includes the selected radio station is created.
 - Internet Radio stations added to favorites in vTuner can be played from "radiomarantz.com" ( [page 28](#)) with this unit.

■ Files that can be played back

See "Playing back Internet Radio" ( [page 91](#)).



Playing back files stored on a PC and NAS

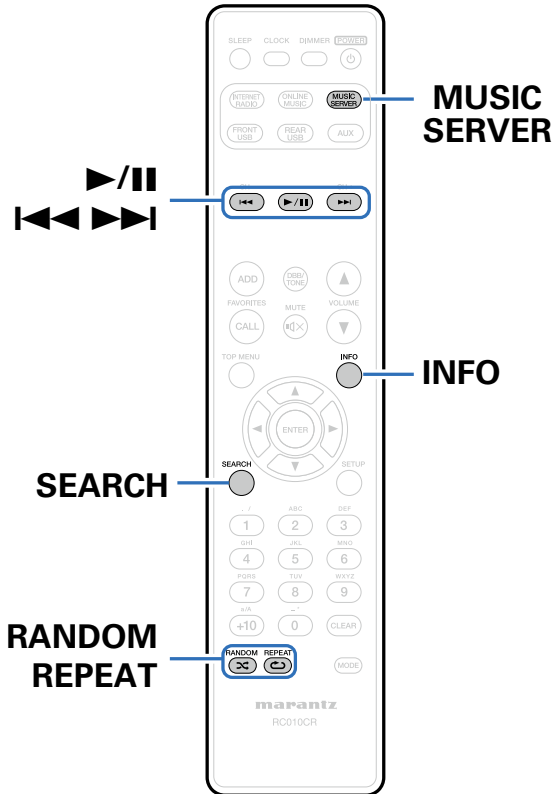

- This unit can play back music files and playlists (m3u, wpl) stored on a PC and on Network Attached Storage (NAS) that supports DLNA.
- The network audio playback function of this unit connects to the server using technologies shown below.
 - Windows Media Player Network Sharing Service
 - Windows Media DRM10
- This unit can play back the following files.
 - **WMA** (Windows Media Audio)
 - **MP3** (MPEG-1 Audio Layer-3)
 - **WAV**
 - **MPEG-4 AAC**
 - **FLAC** (Free Lossless Audio Codec)
 - **ALAC** (Apple Lossless Audio Codec)



Applying media sharing settings

Here, we apply the settings to share music files stored on a PC and NAS on the network.

If you are using a Media Server, be sure to apply this setting first.

■ When using Windows Media Player 12 (Windows 7 / Windows 8)

- 1 Start up Windows Media Player 12 on the PC.
- 2 Select "More streaming options..." in the "Stream".
- 3 Select "Allowed" in the drop-down list for "M-CR510".
- 4 Select "Allowed" in the drop-down list for "Media programs on this PC and remote connections...".
- 5 Click "OK" to finish.

■ When using Windows Media Player 11

- 1 Start up Windows Media Player 11 on the PC.
- 2 Select "Media Sharing" in the "Library".
- 3 Click the "Share my media" check box, select "M-CR510", and then click "Allow".
- 4 As you did in step 3, select the icon of the device (other PCs and mobile devices) you want to use as a media controller, and then click "Allow".
- 5 Click "OK" to finish.

■ Sharing media stored on a NAS device

Change settings on the Network Attached Storage (NAS) device to allow this unit and other devices (PCs and mobile devices) used as media controllers to access the NAS. For details, see the owner's manual that came with the NAS.



Playing back files stored on a PC and NAS

Use this procedure to play music files or playlists.



1 Prepare for playback.

- ① Check the network environment, then turn on this unit's power (☞ page 21 "Connecting to a home network (LAN)").
- ② Prepare the computer (☞ Computer's operating instructions).

2 Press MUSIC SERVER.

3 Use Δ / ∇ to select the server including the file to be played, then press ENTER.

4 Use Δ / ∇ to select the file, then press ENTER. Playback starts once buffering reaches "100%".

Operation buttons	Function
	Playback / Pause (Press and hold) Stop
	Previous / Next (Press and hold) Fast-reverse / Fast-forward*
FAVORITES CALL	Call from the Favorite list
FAVORITES ADD	Registration to the Favorite list
SEARCH	Character search • If the list is not in alphabetical order, you may not be able to perform a character search.
RANDOM	Random playback
REPEAT	Repeat playback • Switching between Single-track repeat and All-track repeat.
INFO	Switching the file type/bit rate, artist name, and album title

* This function is available while an MP3 / WAV / AAC / FLAC file is being played back.

■ Files that can be played back

See "Playing back files stored on PC or NAS" (☞ page 92).





- WMA Lossless files can be played when using a server supporting transcoding, such as Windows Media Player Ver. 11 or later.

NOTE

- When playing back music files with your PC or NAS connected through wireless LAN, audio may be interrupted depending on your wireless LAN environment. In this case, play back music files with your PC or NAS connected through wired LAN.
- The order in which the tracks/files are displayed depends on the server specifications. If the tracks/files are not displayed in alphabetical order due to the server specifications, searching by the first letter may not work properly.



Listening to Pandora®

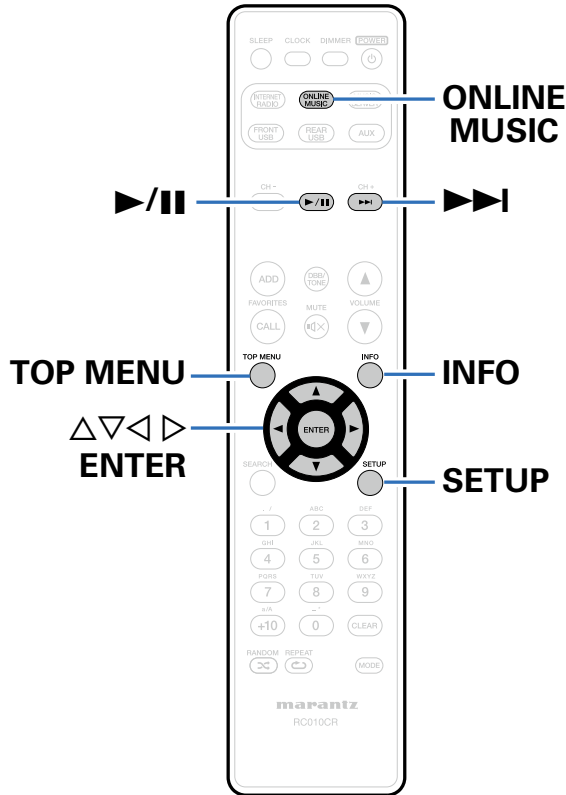

Pandora is free, personalized internet radio that plays music and comedy you'll love. Just start with the name of one of your favorite artists, songs, comedians, or composers and Pandora will create a custom station that plays similar tracks.

To listen to Pandora, use your Pandora log-in information, or register for a free account at www.pandora.com or from the Pandora smartphone application.

It is necessary to associate this machine with a Pandora account by visiting <http://www.pandora.com/marantz> from your PC.



Listening to Pandora®



- 1 Prepare for playback.**
Check the network environment, then turn on this unit's power (see [page 21](#) "Connecting to a home network (LAN)").
 - If you already have a Pandora account, you do not need to obtain a new account. Use your existing Pandora account.
- 2 Press ONLINE MUSIC to switch the input source to "Pandora".**
- 3 If you have a Pandora account, use $\Delta\nabla$ to select "I have a Pandora account", then press ENTER.**
 - If you do not have a Pandora account, press ∇ to select "I am new to Pandora", then press ENTER.
The URL of Pandora and activation code are displayed. Browse to the Pandora activation URL from your PC and follow the on-screen instructions for creating a new account.
- 4 Input "Email address" and "Password".**
 - For character input, see [page 68](#).
- 5 After inputting the "Email address" and "Password", select "Login", then press ENTER.**
If the "Email address" and "Password" match, the top menu for Pandora is displayed.

Creating a new station

You can create up to 100 personalized radio stations.

- 1 Use $\Delta\nabla$ to select "New Station", then press ENTER.**
- 2 Input a track or artist name, then press ENTER.**
- 3 Use $\Delta\nabla$ to select "Search by Artist" or "Search by Track", then press ENTER.**
You can search and display a list by track or artist.
- 4 Use $\Delta\nabla$, select the artist or track (e.g. Music2 Radio) from the list, and press ENTER.**
"Radio" is added to the end of a filename, and your new station is created (e.g. Music2 Radio).



Operation buttons	Function
	Playback / Pause (Press and hold) Stop
	Skips the current track
	Cursor operation / Auto search (cue, ▽)
SETUP	Menu
TOP MENU	Canceling the input
INFO	Switching the file type, artist name and album name.



- Your new station will play music with similar qualities to the artist or track you entered.
- You can Skip up to 6 Tracks that are being played back within 1 hour.

Listening to an existing station

- 1 Use Δ ∇ and select the radio station (“Music2 Radio”) that you want to listen to, and press ENTER.

Play random songs from your stations (Quick Mix)

- 1 Use Δ ∇ to select “Quick Mix”, then press ENTER.
Quick Mix provides a more diverse mix of music by randomly playing songs from the stations in your list.
To turn off Quick Mix, simply select a station to listen to from your station list.



Giving Feedback and Managing Stations

You can personalize your stations by providing feedback.

1 Press while a track is playing.

The Pandora menu screen is displayed.

I like this track :

- Press when you like the track that is being played.
- It will return to the Play Screen. And  (Thumbs up) icon is displayed. (The icon is not displayed on the next track.)

I don't like this track :

- Press when you don't like the track that is being played.
- It will return to the Play Screen. And  (Thumbs down) icon is displayed. (The icon is not displayed on the next track.)

Create station :

- Creates a Station for the Track or Artist being played.

Bookmark this artist :

- Bookmarks the artist currently being played.
- You can check on a computer.
- For details, see the Pandora web page.

Bookmark this track :

- Bookmarks the track currently being played.
- You can check on a computer.
- For details, see the Pandora web page.

Delete this station :

- Press when you want to delete the station that is being played.



- You can create up to 100 Stations (radio stations).

Sign Out

Disassociate this unit from your Pandora account.

1 While the Pandora top menu is displayed, use to select "Sign Out", then press ENTER.

2 When the popup menu appears, use to select "Yes", then press ENTER.



Listening to SiriusXM Internet Radio

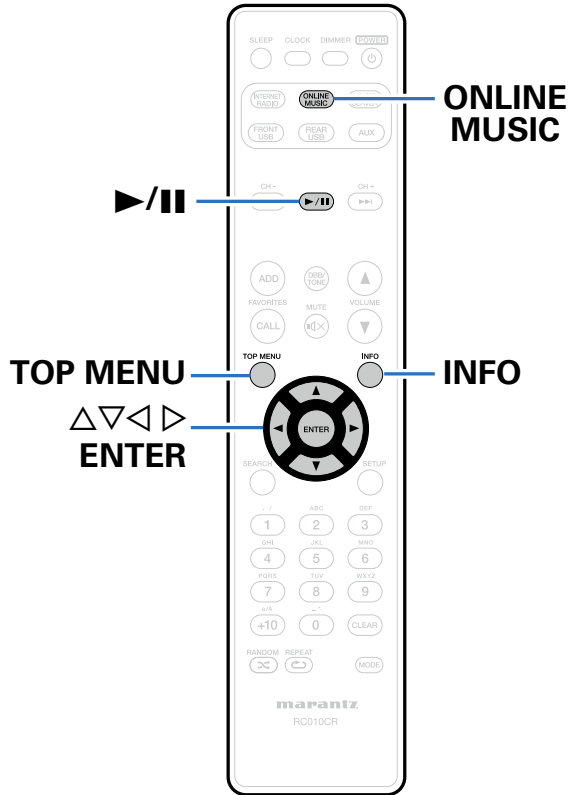

Enjoy anywhere access to the unparalleled content of SiriusXM. Whether on your computer, smartphone, tablet, Lynx Portable Enjoy anywhere access to the unparalleled content of SiriusXM. Whether on your computer, smartphone, tablet, Lynx Portable Radio, or compatible Internet-connected device, you don't need to be in your vehicle to enjoy SiriusXM. For details, see the SiriusXM homepage. <http://www.siriusxm.com>



Listening to SiriusXM Internet Radio

Over 120-channels of the SiriusXM programming you love, including commercial-free music plus sports, talk, news and entertainment. Listen anywhere on your computer or smartphone.

1 Prepare for playback.

- ① Check the network environment, then turn on this unit's power (☞ [page 21](#) "Connecting to a home network (LAN)").
- ② Access the following website from your PC and obtain a SiriusXM account.
<http://www.siriusxm.com>
 - If you already have a SiriusXM account, you do not need to obtain a new account. Select "Sign in" in step 3, and enter your existing SiriusXM account.

2 Press ONLINE MUSIC to switch the input source to "SiriusXM".

3 Select "Sign in", then press ENTER.

4 Input the "Username" and "Password".

- For character input, see [page 68](#).

5 Select the "Sign in", and then press ENTER.

The top menu of SiriusXM is displayed.

6 Use Δ / ∇ to select the genre, then press ENTER.

7 Use Δ / ∇ to select the file, and then press ENTER.

The selected file is displayed.

Operation buttons

Function

\blacktriangleright / \parallel	Playback / Stop
SETUP	Menu
INFO	Switching the file type/bit rate, station name and album name

Sign Out

Disassociate this unit from your SiriusXM account.

1 Use Δ / ∇ to select "Sign Out", then press ENTER.

2 When the popup menu appears, use Δ / ∇ to select "Yes", then press ENTER.



Listening to Spotify

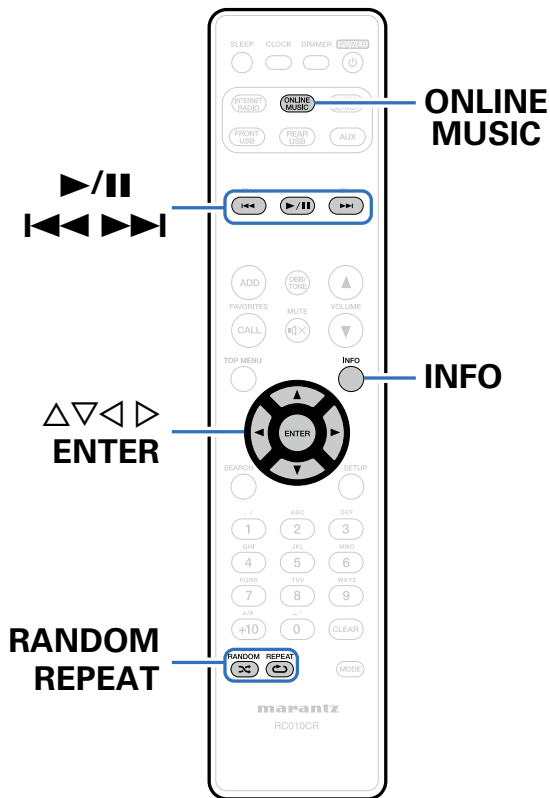

Introduce your Marantz Network Receiver to a whole new world of music. With Spotify, you can enjoy instant access to millions of songs. A Spotify Premium subscription is required. For details, see the Spotify homepage. <http://www.spotify.com>

Listening to Spotify

- 1 Prepare for playback.**
 - ① Check the network environment, then turn on this unit's power (see page 21 "Connecting to a home network (LAN)").
 - ② Complete step 4 and obtain a Spotify account.
 - If you already have a Spotify account, you do not need to obtain a new account. Use your existing Spotify account.
- 2 Press ONLINE MUSIC to switch the input source to "Spotify".**
- 3 If you have a Spotify account, then press ENTER.**



9 When you press during playback, the following menu appears.

Star this track :

- Adds a star to the selected track.

Unstar this track :



- Unregister a star to the selected track.

Browse "Artist name" :

- Displays the list of albums by the artist of the track that is being played back.

Browse "Album name" :

- Displays the list of tracks on the album that is being played back.

Operation buttons	Function
	Playback / Pause (Press and hold) Stop
	Previous / Next (Press and hold) Fast-reverse / Fast-forward
RANDOM	Random playback
REPEAT	Repeat playback
INFO	Switching the artist name and album name



Favorite function

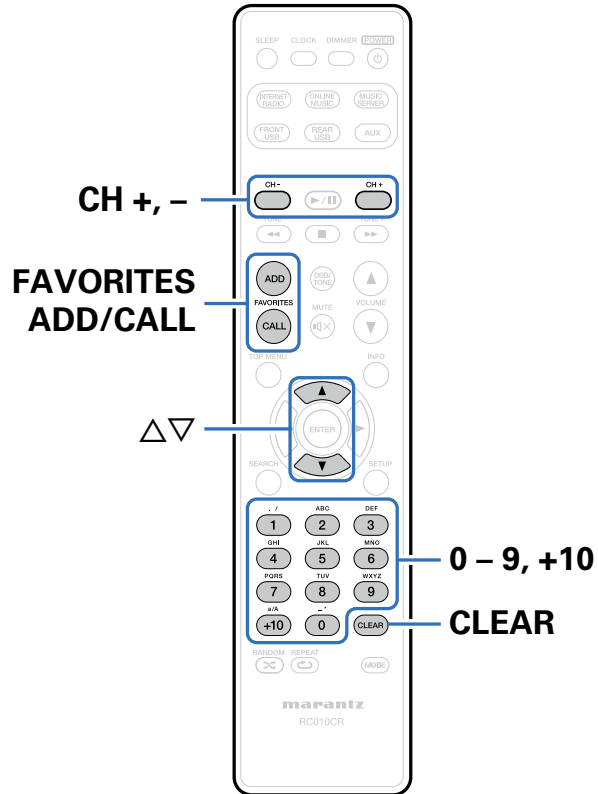

This section provides information on the Favorite function.

- The Favorite function allows you to register your favorite broadcast stations and files in the Favorite List in advance so that you can call and listen to the stations or files right away, whenever you want.
- The contents that you can register and call are Internet radio station, music server.
- Up to 50 items can be stored in the Favorite List.



Registering stations or files to the favorites list

- 1 Press **FAVORITES ADD** while the Internet radio station or file to register is played back.
- 2 Use $\Delta\nabla$ to select a number to register the station or file, and press **ENTER**.
"Add to Favorite" is displayed and the registration is completed.

Calling stations or files from the favorites list

- 1 Press **FAVORITES CALL**.
- 2 Use **CH+**, **CH-** or $\Delta\nabla$ to select the station or file that you want to call, and press **ENTER**.
The respective function starts up and playback starts.



- Press 0 – 9, +10 to call files registered to the Favorite list by number.

To switch between registered stations and files during playback

- 1 Use **CH+**, **CH-** or $\Delta\nabla$.

Deleting stations or files from the favorite list

- 1 Press **FAVORITES CALL**.
- 2 Use $\Delta\nabla$ to select the station or file that you want to delete, and press **CLEAR**.
- 3 When the prompt "**Delete?**" appears, press **ENTER**.
"Deleted" is displayed and the deletion is completed.



- Press \triangleleft to cancel the operation.

Operation buttons	Function
FAVORITES ADD	Registration to the Favorite list
FAVORITES CALL	Call from the Favorite list
CH+, CH- $\Delta\nabla$	Switch between track or file (When playing back Favorite)
0 – 9, +10	Direct call (When Favorite list is displayed)
CLEAR	Delete (When Favorite list is displayed)



Listening to music on an iPod

- 1 Connect the iPod to the USB port (👉 page 19).**
When you connect iPod to the Front USB port, the input source automatically switches to "Front USB".
- 2 Press FRONT USB or REAR USB to switch the input source to "Front USB" or "Rear USB".**
"Direct iPod" is displayed on the display of this unit.
- 3 Operate iPod itself directly while seeing the iPod screen to play back music.**



- The iPod display modes include "Direct iPod" and "Remote iPod".
By default, "Direct iPod", where you directly operate the iPod itself while looking at the iPod screen, is set.
- To change to "Remote iPod", where you perform operations while having the iPod information displayed on the body. See "Setting operation mode (Remote iPod Mode)" (👉 page 47).

NOTE

- Depending on the type of iPod and the software version, some functions may not operate.
- Note that Marantz will accept no responsibility whatsoever for any problems arising with the data on an iPod when using this unit in conjunction with the iPod.

■ Playing the AirPlay (👉 page 52)



Setting operation mode (Remote iPod Mode)



In this mode, various lists and screens during playback on the iPod are displayed on the body.

This section describes the steps up to playing back tracks on the iPod in "Remote iPod".

- 1 Press **MODE** and display "Remote iPod".
- 2 Use Δ / ∇ to select the file to be played, then press **ENTER**. Playback starts.

Display mode		Direct iPod	Remote iPod
Playable files	Music file	✓	✓
	Video file	*	
Active buttons	Remote control unit (This unit)	✓	✓
	iPod	✓	

* Only the sound is played.

Operation buttons	Function
	Playback / Pause (Press and hold) Stop
	Previous / Next (Press and hold) Fast-reverse / Fast-forward
RANDOM	Random playback
REPEAT	Repeat playback <ul style="list-style-type: none"> • Switching between Single-track repeat and All-track repeat.
MODE	Switching between Remote iPod and Direct iPod.
INFO	Switching the artist name and album title



- 1st generation iPod nano and iPod video do not have Direct Mode support.

NOTE

- Marantz will accept no responsibility whatsoever for any loss of iPod data.
- Depending on the type of iPod and the software version, some functions may not operate.



Charging the iPod/iPhone

You can charge your iPod/iPhone by connecting it to USB port.

■ Standby charging

If the unit enters power standby mode while the iPod/iPhone is charging, the unit will switch to standby charging mode, and the iPod/iPhone will continue to be charged. When in standby charging mode, the power display light turns red.

When the iPod/iPhone is fully charged, the unit automatically stops supplying power for charging and enters normal power standby mode, and the power display light turns off.



Playing a USB memory device

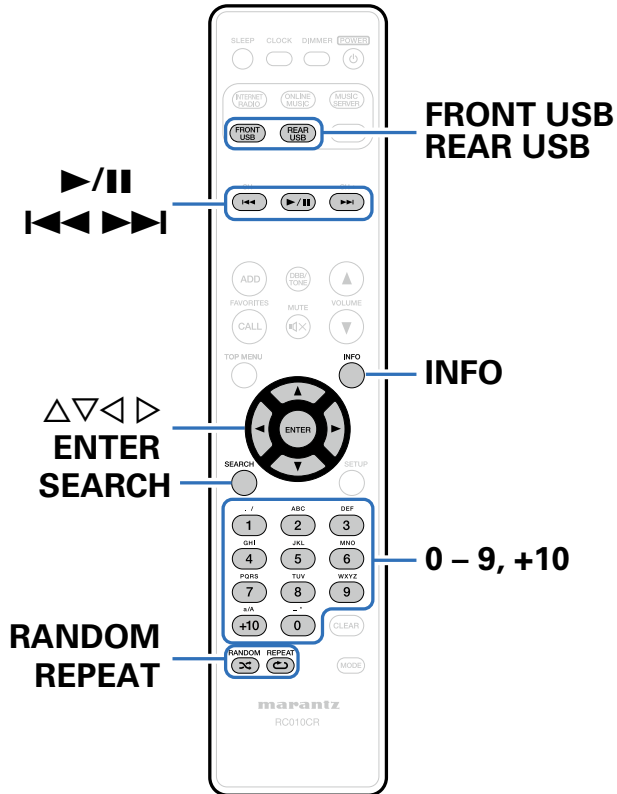

- Playing back music stored on a USB memory device.
- Only USB memory devices conforming to mass storage class and MTP (Media Transfer Protocol) standards can be played on this unit.
- This unit is compatible with USB memory devices in "FAT16" or "FAT32" format.
- This unit can play back the following files.
 - **WMA** (Windows Media Audio)
 - **MP3** (MPEG-1 Audio Layer-3)
 - **WAV**
 - **MPEG-4 AAC**
 - **FLAC** (Free Lossless Audio Codec)
 - **ALAC** (Apple Lossless Audio Codec)





Playing files stored on USB memory devices

1 Connect the USB memory device to the USB port (☞ page 19).

When you connect USB memory device to the Front USB port, the input source automatically switches to “Front USB”.

2 Press FRONT USB or REAR USB to switch the input source to “Front USB” or “Rear USB”.

3 Use Δ / ∇ to select the file to be played, then press ENTER. Playback starts.

Operation buttons	Function
	Playback / Pause (Press and hold) Stop
	Previous / Next (Press and hold) Fast-reverse / Fast-forward*
RANDOM	Random playback
REPEAT	Repeat playback • Switching between Single-track repeat and All-track repeat.
SEARCH	Character search • If the list is not in alphabetical order, you may not be able to perform a character search.
INFO	Switching the artist name and album title

* This function is available while an MP3 / WAV / AAC / FLAC file is being played back.

NOTE

- Note that Marantz will accept no responsibility whatsoever for any problems arising with the data on a USB memory device when using this unit in conjunction with the USB memory device.

■ Files that can be played back

See “Playing back USB memory devices” (☞ page 90).



Listening to ANALOG IN

- 1 Prepare for playback.**
Check the connection, then turn on this units.
- 2 Press AUX to select "Analog In".**
- 3 Play the component connected to this unit.**

Listening to DIGITAL IN

- 1 Prepare for playback.**
Check the connection, then turn on this units.
- 2 Press AUX to select "Digital In".**
- 3 Play the component connected to this unit.**

NOTE

- Only 2 channel linear PCM digital audio signals can be inputted through the DIGITAL IN connector of this unit.



- Press the AUX again to switch between Analog In / Digital In.



AirPlay function

Enjoy music from your iTunes library with high quality sound anywhere in your home.

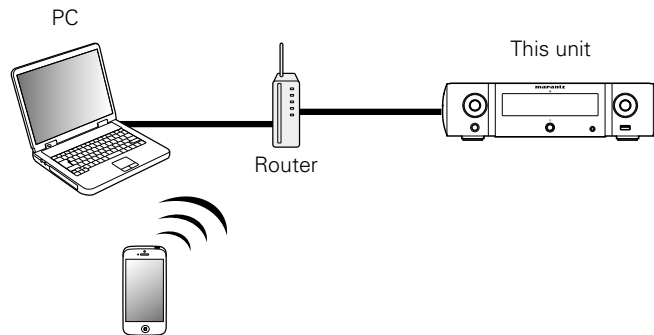

Streaming music stored in iPhone, iPod touch, or iPad directly to the unit

If you update your "iPhone/iPod touch/iPad" to iOS 4.2.1 or later, you can stream music stored in your "iPhone/iPod touch/iPad" directly to this unit.

- 1 Make the Wi-Fi settings for iPhone, iPod touch, or iPad.**
 - For details, see your device's manual.
- 2 Startup iPhone, iPod touch, or iPad music.**
 - ☑ is displayed on the iPhone, iPod touch or iPad screen.
- 3 Tap the AirPlay icon ☑.**
- 4 Select the speaker you want to use.**

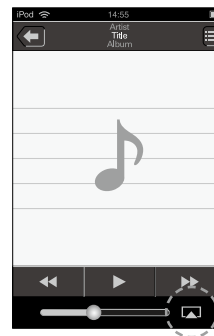

Playing iTunes music with this unit

- 1 Install iTunes 10, or later, on a Mac or Windows PC that is connected to the same network as this unit.**
- 2 Turn this unit ON.**
Set "Network Control" (🔌 page 74) to "On" for this unit.
- 3 Launch iTunes and click the AirPlay icon  displayed the window and select this unit from the list.**



- 4 Choose a song and click play in iTunes.**
The music will stream to this unit.

Selecting multiple speakers (devices)

It is possible to play iTunes songs on your home's AirPlay compatible speakers (devices) other than those of this unit.

- 1 Click the AirPlay icon  and select "Multiple".**
- 2 Check the speakers you want to use.**

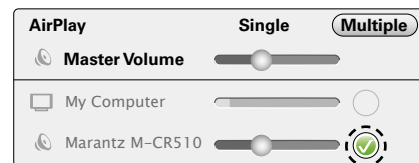

NOTE

- In playback using the AirPlay function, the sound is output at the iPhone, iPod touch, iPad or iTunes volume setting level.
- You should turn down the iPhone, iPod touch, iPad or iTunes volume prior to playback and then adjust it to a suitable level.



Perform iTunes playback operations with the remote control unit of this unit

With this unit's remote control unit, you can perform iTunes song play, pause, and auto search (cue) operations.

- 1 Select "Edit" – "Preferences..." on the menu.
- 2 Select "Devices" in the iTunes setting window.
- 3 Check "Allow iTunes audio control from remote speakers", and then click "OK".



- Source input will be switched to "AirPlay" when AirPlay playback is started.
- You can stop AirPlay playback by pressing < or choosing other input source.
- To see artist name or album title together, press INFO.
- For information about how to use iTunes, also see the Help for iTunes.
- The screen may differ depending on the OS and software versions.

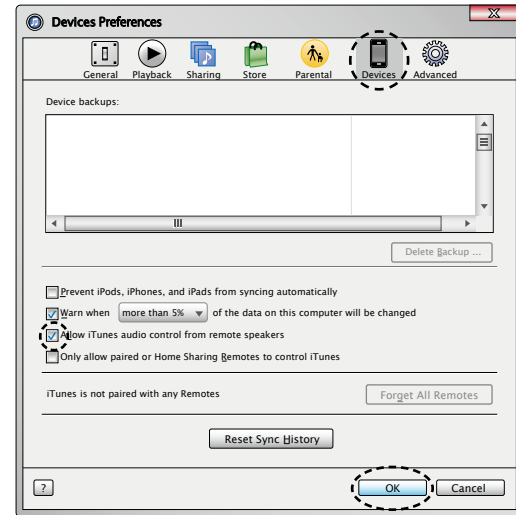

Remote play function

You can use your home network to play back with this unit music files stored on PC, NAS, mobile phones and portable audio players. In this case, you use PC, mobile phones and portable audio players for operations.



- The relevant devices should comply with the DLNA (Digital Living Network Alliance) Ver. 1.5 standard.
- A wireless LAN environment is required for playing back music files on mobile phones or portable audio players.
- For some mobile phones, you must install an application for DLNA music playback.

■ Roles each device plays

The following devices are used for Remote Play. As specified in the DLNA standard, these devices are called DMC, DMS or DMR according to their role.

Name	Device example	Role
DMC (Digital Media Controller)	<ul style="list-style-type: none"> • PC • Mobile phone • Portable audio player • Marantz Remote App 	Performs Remote Play operations. DMC can also play back music files stored on these devices.
DMS (Digital Media Server)	<ul style="list-style-type: none"> • PC • NAS (Network Attached Storage) 	Stores music files. Music files stored on these devices are played back with DMC.
DMR (Digital Media Renderer)	<ul style="list-style-type: none"> • This unit 	Outputs audio of music files played back through Remote Play from speakers. DMR cannot perform playback operations.

■ Files that can be played back

See "Playing back files stored on PC or NAS" ([page 92](#)).



Settings required for each device

You must make settings on DMC and DMS for Remote Play. Make the following settings. Also see the owner's manual of each device for settings.

■ Settings on PC and NAS

Make settings on PC and NAS to exchange data with DMR devices. For settings, see "Applying media sharing settings" ( [page 31](#)).

■ Settings on mobile phones

You must install an application for DLNA music playback on your mobile phone to perform operations on DMS and this unit (DMR) with your mobile phone. The applicable application differs according to your mobile phone.





- Some mobile phones support DLNA music playback with the factory settings. See the owner's manual of your mobile phone.

■ Settings on portable audio players

Make settings so that this unit (DMR) can play back music files stored on your portable audio player. For settings, see the owner's manual of your portable player.

■ Settings on this unit

Connect this unit to the DLNA network. You do not need to make other settings.

For the network connection, see the provided Quick Setup Guide, "Connecting to a home network (LAN)" ( [page 21](#)) and "Settings" ( [page 75](#)).

■ Remote Play operations

Operations are different for each device, but the procedures for preparing for Remote Play are the same. The preparation procedures are shown below.

1 Turn on this unit.

- Make sure that this unit is connected to the network.

2 Display the music file playback screen on DMC.

- For PC, open Windows Media Player 12, etc.
- For mobile phones, switch to the music file playback mode.

3 Select the friendly name of this unit for the item that sets the playback device on the playback screen.

- The default friendly name of this unit is "Marantz M-CR510".

4 Start playing back a music file on DMC.

- The function on this unit automatically switches to Music Server and the Remote Play mark  appears on the display. Remote Play starts.



- Press < to exit Remote Play mode.

NOTE

- During Remote Play, you cannot perform playback operations with this unit. Use the DMC device for these operations.



Web control function

You can control this unit from a web control screen on a web browser.

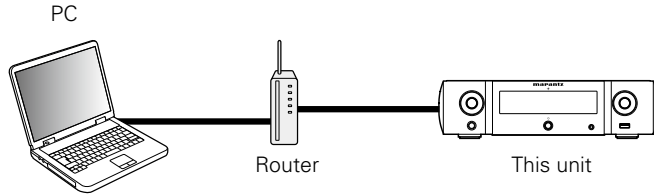

- This unit and the Computer need to be connected to the network properly (☞ [page 21](#) "Connecting to a home network (LAN)") in order to use the web control function.
- Depending on the settings of your security-related software, you may not be able to access this unit from your PC. If this is the case, then change the settings of the security-related software.

Controlling the unit from a web control

- 1 Switch the "Network Control" (☞ [page 74](#)) setting to "On".
- 2 Check the IP address of this unit with "Network Information" (☞ [page 74](#)).

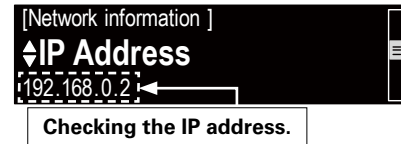

- 3 Start up the web browser.



4 Enter the IP address of this unit in browser's address box.

For example, if the IP address of this unit is "192.168.0.2", enter "http://192.168.0.2".

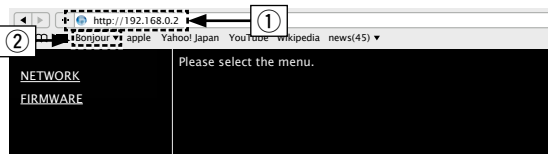

- ① Entering the IP address.
- ② If you are using the Safari web browser, you can select "Bonjour" and directly access the unit's web control screen from the overview section.



- By adding this unit's IP address to the browser's bookmark, you can display the web control screen using the bookmark function the next time you use the browser. If you are using a DHCP server and "Network Control" (🔗 [page 74](#)) is set to "Off", turning the power on/off changes the IP address.

5 When the top menu is displayed, click on the menu item you want to operate.

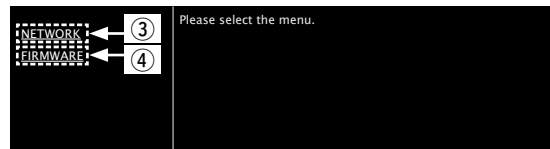

- ③ Click when you setup network settings.
(🔗 **Example 1**)
- ④ Click when you update firmware (🔗 [page 71](#))



6 Operate.

[Example 1] Network Setting 1

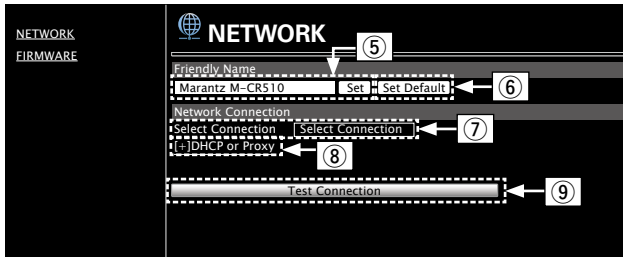

□ Friendly Name setting

- ⑤ To change the Friendly Name, enter the new name in the text box and click “Set”.
- ⑥ To reset the Friendly Name, click “Set Default”.

□ Network connection settings

- ⑦ Click to change the network connection method. If you select “Wi-Fi”, a new item will appear on-screen.
(☞ [Example 2])
- ⑧ Click to change DHCP/proxy settings.
(☞ [Example 2])
- ⑨ Click to connect using the newly applied settings.



- To apply network connection settings, click “Test Connection” after making changes.

[Example 2] Network Setting 2

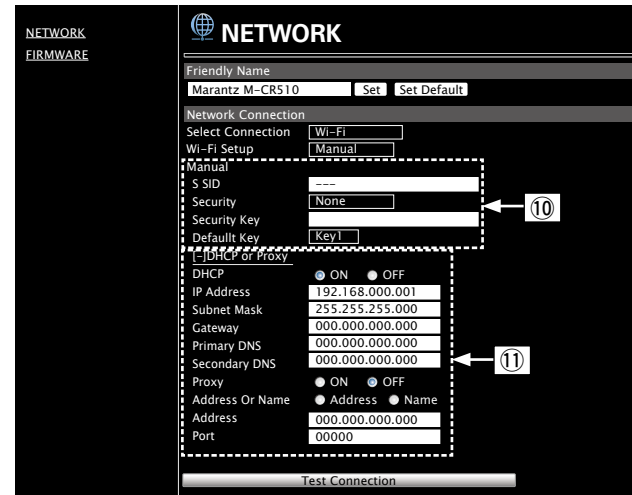

❏ Network connection settings

⑩ Various items will be displayed if you selected “Wi-Fi” in Example 1. Select or input items as necessary, and then click “Test Connection” to apply the changes.

- Items displayed may vary depending on selected items and connection status.
- After selecting each item, wait a moment for the display to be updated.

⑪ Displayed if “DHCP” or “Proxy” is selected in Example 1. When changing DHCP/proxy settings, input or select for each item.



- To apply network connection settings, click “Test Connection” after making changes.

■ Update on web screen

Firmware can be updated using the “Web control function” (☞ page 57).

“Web control function” (☞ page 57) settings must be completed in advance on a PC belonging to the same network.

For information on obtaining update files, please contact our customer service center.

1 Click ④ from step 5 for the “Web control function” (☞ page 57).

The PC will display the following screen.

Wait for approximately 1 minute.

You can also gain access by entering the IP address shown by the unit into a web browser.

[The web display]

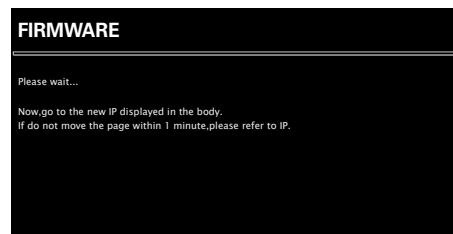

[The unit's display]



- 2** When the following screen is displayed by the PC, click the “Choose File” (①) button, select the update file, and click the “Upload” (②) button.

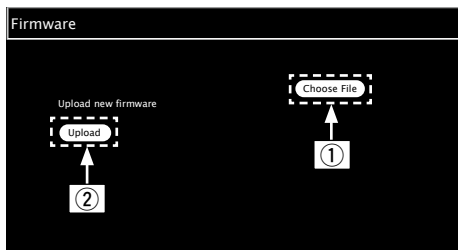

- 3** When the following screen is displayed, click the “OK” (③) button.

Updating will begin.

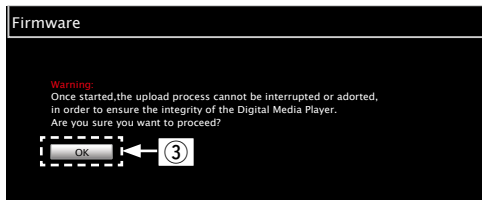

NOTE

- Do not operate the unit while updating is in progress.

- 4** When the following screen is displayed, updating is complete.

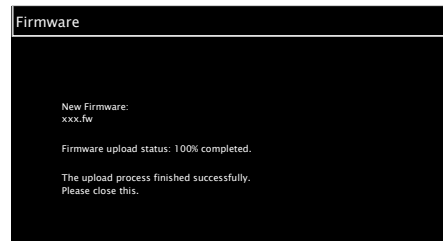

- Button names may vary depending on the OS language used on your computer.



Other functions

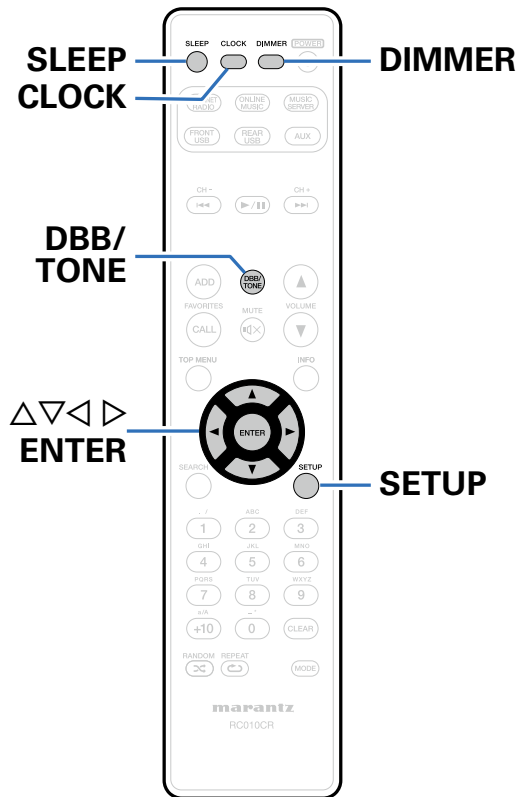

Adjusting the tone (👉 page 63)

Sleep timer function (👉 page 64)

Checking the current time (👉 page 64)

Switching the display's brightness (👉 page 64)



Adjusting the tone

1 Press **DBB/TONE** to select the tone parameter to be adjusted.

2 Use Δ ∇ to adjust the “**Dynamic Bass Boost**”, “**Bass**”, “**Treble**”, “**Balance**” or “**Source Direct**”.

- To make other tone adjustments at this time, press **DBB/TONE**.

Dynamic Bass Boost

Emphasizes the bass sound with 10dB boost.

On / Off (Default)

Bass

Adjusts the bass sound.

-10dB – +10dB (Default : 0dB)

Treble

Adjusts the treble sound.

-10dB – +10dB (Default : 0dB)

Balance

Use \triangleleft \triangleright to adjust the left/right volume balance.

Source Direct

The tone is not adjusted.

On / Off (Default)



- “**Dynamic Bass Boost**”, “**Bass**”, “**Treble**” or “**Speaker Response**” settings are disabled when the audio source has a sampling frequency over 176.4 kHz.



Sleep timer function

You can have the power automatically switched to standby once a set time has elapsed. This is convenient for listening while going to sleep.

1 Press SLEEP and display the time you want to set.

- The  indicator on the display lights.
- You can set the sleep timer in the range from 10 to 90 minutes in steps of 10 minutes.

■ To cancel the sleep timer

Press SLEEP to set "Sleep ► Off".

The  indicator on the display turns off.



- The sleep timer is also cancelled when this unit is set to the standby mode.
- To check the time remaining until the sleep timer is activated, press SLEEP.

Checking the current time

■ Checking the current time when the power is on

Press CLOCK.

- Press once more and the display returns to its original condition.

■ Checking the current time when the power is set to standby

Press CLOCK.

- When "Network Control" ( page 74) is set to "On", the current time is displayed during standby.

Press CLOCK again, and the current time disappears.

- When Network Standby is set to "Off", the current time is displayed for approximately 30 seconds, and then automatically disappears.

NOTE

- The time cannot be set when in the standby mode. Turn on the power first.

Switching the display's brightness

1 Press DIMMER.

- The display brightness is adjusted each time DIMMER is pressed.

100% (Default) / 75% / 50% / 25% / Off



- If you operate the buttons when the display's brightness is set to "Off", the display temporarily lights at the 25% brightness level.



Settings

Menu map

For menu operations, see the following page.

By default, this unit has recommended settings defined. You can customize this unit based on your existing system and your preferences.

■ Quick Setup

Setting items	Description	Page
Quick Setup	Performs the network settings using a Wizard style window. For details on the operations, see the separate "Quick Setup Guide".	–

■ General

Setting items	Description	Page
Alarm	Sets the timer playback.	69
Clock	Sets the current time.	70
Speaker Response	Set the output frequency characteristics.	70
Language	Sets the language for display the menu.	71
Auto-Standby	Sets the unit power to standby when the unit is not in use.	71
Firmware	Set whether or not to check for firmware update, update the firmware, and display update and upgrade notifications.	71
Update	Update the firmware of Marantz Network Receiver.	71
Notifications	Set the Update, Upgrade and Alerts notification on/off.	72
Add New Feature	Display new features that can be downloaded to this unit and perform an upgrade.	72



■ Network

Setting items	Description	Page
Network Information	Displays various information about the network.	74
Network Control	Performs the ON/OFF settings for the network function when in standby mode.	74
Friendly Name	Edits a name displayed on the Internet.	74
Settings	Performs the settings for a wired or wireless LAN.	75
When making wired connection	Performs the settings for a wired LAN.	75
DHCP (On) or DHCP (Off)	Performs the DHCP setting.	75
IP Address*	Performs the IP address setting.	75
Subnet Mask*	Performs the subnet mask setting.	75
Gateway*	Performs the gateway setting.	75
Primary DNS*	Performs the primary DNS setting.	75
Secondary DNS*	Performs the secondary DNS setting.	75
Proxy	Performs the proxy setting.	75
Test Connection	Performs the wired LAN connection.	75
When making Wi-Fi connection	Performs the wireless LAN connection setting.	76
Auto-Scan	Selects and sets the wireless connections from the access point list.	76
WPS (Wi-Fi Protected Setup)	Sets the wireless connection using WPS (Wi-Fi Protected Setup).	76
Web Browser Setup	Sets the wireless connection using web browser.	76
Manual	Sets the wireless connection manually.	77

* Displayed when the “DHCP” setting is “Off” (☞ [page 75](#)).



Menu operation

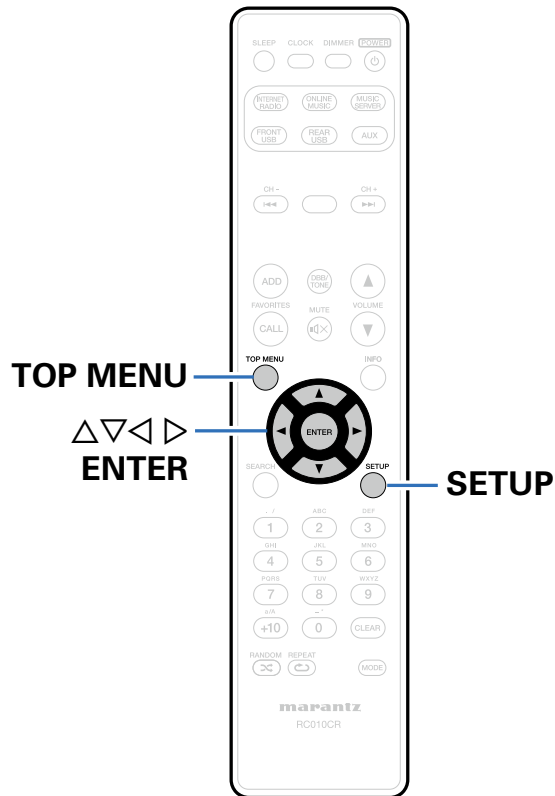

- 1 Press SETUP.**
The menu is displayed.
- 2 Use $\Delta \nabla \triangleleft \triangleright$ to select the menu to be set or operated, then press ENTER.**
- 3 Use $\Delta \nabla$ to change to desired setting.**
- 4 Press ENTER to enter the setting.**
 - To return to the previous item, press \triangleleft .
 - Exiting the Menu, press SETUP while the menu is displayed. The menu display disappears.
 - To back to the top of the menu, during menu operation, press TOP MENU.



Inputting characters

On this unit, you can change the name displayed on the following menu to the names that you prefer.

- Character Search (🔍 page 28, 32, 50)
- Friendly Name (🔍 page 74)
- Character input for the network functions (🔍 page 28, 35, 39, 40)

Using the number buttons

- 1 Display the menu for inputting characters.
- 2 Use ◀ ▶ to move the cursor to the character you want to change.
- 3 Press +10 to select the character type (upper case, lower case, or numeric characters).
- 4 Press 0 – 9, +10 until the desired character is displayed.
 - The types of characters that can be input are as shown below.

1 ., /	1 . @ - _ / : ~	6 MNO	m n o M N O 6
2 ABC	a b c A B C 2	7 PQRS	p q r s P Q R S 7
3 DEF	d e f D E F 3	8 TUV	t u v T U V 8
4 GHI	g h i G H I 4	9 WXYZ	w x y z W X Y Z 9
5 JKL	j k l J K L 5	0 _.	0 (Space) ! " # \$ % & ' () * + , ; < = > ? [\] ^ ` { } ~

- 5 Repeat steps 2 – 4 to change the name then press ENTER to register it.

Using the cursor buttons

- 1 Display the menu for inputting characters.
- 2 Use ◀ ▶ to move the cursor to the character you want to change.
- 3 Use △ ▽ to change the character.
 - The types of characters that can be input are as shown below.

[Lower case characters]
abcdefghijklmnopqrstuvwxyz
[Upper case characters]
ABCDEFGHIJKLMNOPQRSTUVWXYZ
[Symbols] ! " # \$ % & ' () * + , - . / : ; < = > ? @ [\] ^ _ ` { | } ~
[Numbers] 0123456789 (Space)

- 4 Repeat steps 2 and 3 to change the name then press ENTER to register it.



- Press CLEAR to delete the character.
- Press ▶▶ to insert a space.



General

Make various other settings.

Alarm

Set the once alarm and everyday alarm.

■ Once

Time display : Set the once alarm to on.

Off : Set the once alarm to off.

■ Everyday

Time display : Set the everyday alarm to on.

Off : Set the everyday alarm to off.

■ Edit Alarm

Edit the once alarm and everyday alarm.

- 1 Use $\Delta \nabla$ to select the alarm mode, then press ENTER.
- 2 Use $\Delta \nabla$ to setting for the alarm start time, then press ENTER.
- 3 Use $\Delta \nabla$ to select the input source, then press ENTER.
- 4 Use $\Delta \nabla$ to select the volume level "00 – 60", then press ENTER.

The display shows "Complete!!" and the setting is completed.

- The standby indicator lights orange when the unit is switched to standby mode in this state.



- If the unit or remote control is not operated for 90 minutes or more when the alarm is set to on, the standby mode is activated.



Clock

■ Set the current time

You can automatically adjust the clock of this unit using the Internet.



- To use this function, the unit must be connected to the Internet.

- Use Δ ∇ to select your time zone, then press ENTER.
- Use Δ ∇ to select the DST (Daylight Saving Time), then press ENTER.

On : Set the DST (Daylight Saving Time) to on.

Off (Default) : Set the DST (Daylight Saving Time) to off.

Speaker Response

Set the output frequency characteristics.

Flat (Default) : Properties are flat.

Response 1 : Cuts low frequencies 60 Hz or under by -12 dB/oct.

Response 2 : Cuts low frequencies 100 Hz or under by -12 dB/oct.

Response 3 : Cuts low frequencies 60 Hz or under by -12 dB/oct. Also, raises the 400 Hz region by 3 dB.

Response 4 : Cuts low frequencies 100 Hz or under by -12 dB/oct. Also, raises the 400 Hz region by 3 dB.



- Speaker Response setting values are not reflected in headphone out or subwoofer out.



Language

Set the language for display on the menu.

English (Default) / **Français** / **Español**

Auto-Standby

When this unit is in the stop state and there is no input signal and operation for 15 minutes, it automatically enters the standby mode.

For the input source "Analog In" and "Direct iPod" only, when no operation is performed for eight hours, this unit automatically enters the standby mode.

On : The unit goes into standby after 15 minutes.

Off (Default) : The unit does not go into standby automatically.

Firmware

Set whether or not to check for firmware update, update the firmware, and display update, upgrade and alert notifications.

■ Update

Update the firmware of Marantz Network Receiver.

Check for Update : Check for firmware updates. You can also check approximately how long it will take to complete an update.

Update Start : Execute the update process.



- If updating fails, the set automatically retries.



■ Notifications

Notification messages are displayed in the screen when the power is switched on when new firmware can be used, or when there are other notification messages.

Update

On (Default) : Display update message.

Off : Do not display update message.

Upgrade

On (Default) : Display upgrade message.

Off : Do not display upgrade message.

Notification Alerts

On (Default) : Displays notification messages from Marantz in the popup menu.

Off : Does not display notification messages from Marantz in the popup menu.

■ Add New Feature

Display new features that can be downloaded to this unit and perform an upgrade.

Upgrade Package : Display the items to be upgraded.

Upgrade Status : Display a list of the additional functions provided by the upgrade.

Upgrade Start : Execute the upgrade process. When the upgrade starts, the display is shut down. During the upgrade, the amount of upgrade time which has elapsed is displayed.

Upgrade ID : The ID number shown on the display is needed when carrying out the procedure.



- See the Marantz website for details about upgrades.
- When the procedure is complete, "Registered" is displayed in this menu and upgrades can be carried out. If the procedure has not been carried out, "Not Registered" is displayed.



Notes concerning use of “Update” and “Add New Feature”

- In order to add new functions, the environment and settings required for connecting to broadband internet are needed (refer page 21).
- Perform the add new feature operation after at least 2 minutes has elapsed since turning this unit’s power on.
- Do not turn off the power until updating or upgrading is completed.
- Even with a broadband connection to the Internet, approximately 20 minutes is required for the updating/upgrading procedure to be completed.
- Once updating/upgrade starts, normal operations on this unit cannot be performed until updating/upgrading is completed.
- Furthermore, updating/upgrading the firmware may reset the backup data for the parameters, etc. set for this unit.
- When the update or upgrade failed with a message such as “Update failed” and “Download failed”, remove and re-insert the power cord. “Update Retry” appears on the display and update restarts from the point at which update failed. If the error continues despite this, check the network environment.



- Information regarding the “Update” function and “Add New Feature” will be announced on the Marantz web site each time related plans are defined.



Network

To use this unit by connecting it to a home network (LAN), you must configure network settings.

If you set up your home network via DHCP, set “DHCP” to “On” (use the default setting). This allows this unit to use your home network.

If you assign an IP address for each device, you must use the “IP Address” setting to assign an IP address to this unit and enter the information about your home network such as the gateway address and subnet mask.

Network Information

Display network information.

Friendly Name / DHCP On or Off / IP Address / MAC Address / SSID*

* This is displayed only while a Wi-Fi connection is enabled.

Network Control

Enables network communication in standby power mode.

On : Network is on during standby. Main unit operable with a network compatible controller.

Off (Default) : Suspend network function during standby.



- Set to “On” when using the web control function or a network compatible controller.

NOTE

- When “Network Control” is set to “On”, it consumes more standby power.

Friendly Name

The Friendly Name (personalized name) is the name of this unit displayed on the network.

Select Name

Selects Friendly Name from the list.

AV Room / Bedroom / Dining Room / Family Room / Guest Room / Kids Room / Kitchen / Living Room / Office / Marantz M-CR510 (Default) / **Other**

* When you select “Other”, you can change the Friendly Name according to your preferences.



- The default Friendly Name on first use is “Marantz M-CR510”.
- Up to 63 characters can be input.
- For character input, see [page 68](#).



Settings

You can make detailed settings for the network.

To change the network environment, perform “Quick Setup”. (For details on the operations, see the separate “Quick Setup Guide”.)

- If you are using a broadband router (DHCP function), there is no need to make the settings at “IP Address” and “Proxy”, since the DHCP function is set to “On” in this unit’s default settings.
- Only set “Settings” when connecting to a network without a DHCP function.

■ When making wired connection

DHCP

Selects how to connect to the network.

On (Default) : Configure the network settings automatically from your router.

Off : Configure the network settings manually.

IP Address

Set the IP address within the ranges shown below.

- The Network Audio function cannot be used if other IP addresses are set.

CLASS A: 10.0.0.1 – 10.255.255.254

CLASS B: 172.16.0.1 – 172.31.255.254

CLASS C: 192.168.0.1 – 192.168.255.254

Subnet Mask

When connecting an xDSL modem or connector adapter directly to this unit, input the subnet mask indicated in the documentation supplied by your provider. Normally input 255.255.255.0.

Gateway

When connected to a gateway (router), input its IP address.

Primary DNS, Secondary DNS

If there is only one DNS address indicated in the documentation supplied by your provider, input it at “Primary DNS”. If two or more DNS are provided by your provider, enter both “Primary DNS” and “Secondary DNS”.

Proxy

Make this setting when connecting to the Internet via a proxy server. Make the proxy settings only when you connect to the Internet via a proxy server that is on your internal network or provided by your provider, etc.

Proxy (Off) or **Proxy (On)** : Set the proxy server.

Proxy (Address) or **Proxy (Name)** : Select when inputting by address or domain name.

Address or **Name** : Inputting address or domain name. Up to 38 characters can be input.

Port : Enter port number.



- If you cannot connect to the Internet, recheck “Connecting to a home network (LAN)” (page 21).
- If you do not understand about Internet connection, contact your ISP (Internet Service Provider) or the store from which you purchased your computer.



■ When making Wi-Fi connection

In this menu, Wi-Fi settings and connections can be made using any of the four connection methods.

Auto Scan / WPS(PIN) / Web Browser Setup / Manual



- If a LAN cable is connected, remove it.
- See the Quick Setup Guide for details on how to connect to Wi-Fi using the Wi-Fi CONNECT button on the rear panel.

□ Auto-Scan

This automatically searches for networks.

1 From the list of the networks, select the one you want to connect to.

When the network you want to connect to is not detected, select "Rescan".

2 Make the following settings.

Default Key : Select the default key.

- When connecting to a "WEP" encrypted network, "Default Key" menu is displayed.

Password : Input the password.

DHCP / Proxy : Make settings for DHCP / Proxy ( page 75).

Test Connection : Test the connection.

□ WPS (PIN code method)

1 From the list of the networks, select the one you want to connect to.

When the network you want to connect to is not detected, select "Rescan".

2 Set this PIN code to the register.

□ Web Browser Setup

Use a web browser to set up Wi-Fi.

A Wi-Fi device that can perform web browse operations is required.

1 Select Web Browser Setup.

2 Press ENTER.

3 Select Wi-Fi network called "Marantz M-CR510" from your Wi-Fi device.

The IP address appears on the unit.

4 See Step 4 of the Web Control function (page 58).



□ Manual

Sets the wireless connection manually.

SSID : Input the name of the wireless network (SSID).

Security : Select the encryption method according to the encryption setting of the access point you are using.

Password : Input the password.

Default Key : Select the default key.

- When connecting to a “WEP” encrypted network, “Default Key” menu is displayed.

DHCP / Proxy : Make settings for DHCP / Proxy ([☞ page 75](#)).

Test Connection : Test the connection.



Tips

Contents

■ Tips	(79)	■ Troubleshooting	(80)
Simple operations in the power off state	(79)	Power does not turn on / Power is turned off	(80)
Simple operations for iPod/USB	(79)	Indicator is flashing.....	(80)
I only want to recharge my iPod.....	(79)	Operations cannot be performed through the remote control unit.....	(81)
Specifying the iPod track with the alarm function.....	(79)	Display on this unit shows nothing	(81)
Specifying the desired track with the alarm function	(79)	No sound comes out.....	(82)
Change to the DST (Daylight Saving Time)	(79)	Desired sound does not come out.....	(83)
Changing or resetting the network environment	(79)	Sound is interrupted or noise occurs.....	(83)
I want to set the optimized listening environment after changing the configuration/position of the speakers or changing a speaker to a new one	(79)	iPod cannot be played back.....	(84)
		USB memory devices cannot be played back	(85)
		File names on the iPod/USB memory device are not displayed properly	(86)
		The Internet radio cannot be played back	(86)
		Music files on PC or NAS cannot be played back.....	(87)
		Cannot connect by Wi-Fi	(88)



Tips

Simple operations in the power off state

- When an input source select buttons or FAVORITES CALL button is pressed, the operation is performed at the same time as the unit switches on (🔗 [page 25, 43](#)).
- When the Network Control function is set to “On”, you can perform playback, or other operations through AirPlay, App or the web control function (🔗 [page 52, 57, 74](#)).

Simple operations for iPod/USB

- When connected to the Front USB, the Input Source automatically changes and playback begins (🔗 [page 46, 50](#)).

I only want to recharge my iPod

- Connect the iPod to this unit when the unit power is on. Then turn the unit power off, and the iPod will continue to charge until fully charged (🔗 [page 48](#)).
- When connected to the rear USB, the iPod can be charged without the current Input Source changing (🔗 [page 46](#)).

Specifying the iPod track with the alarm function

- In the power off state after setting the alarm, pause the iPod playback of the track you want to use (🔗 [page 69](#)).
- When using alarm playback on an iPod touch or iPhone, set the iPod touch or iPhone to “Sleep” mode. If the power is switched off using the power off operation, alarm playback cannot be used.

Specifying the desired track with the alarm function

- After registering the desired track in NAS, etc., register the track in the favorites and then specify the track in the alarm settings (🔗 [page 69](#)).

Change to the DST (Daylight Saving Time)

- Select Setup – “General” – “Clock” and configure the settings (🔗 [page 70](#)).

Changing or resetting the network environment

- Prepare the provided Quick Setup Guide, and run Setup – “Quick Setup”. For detailed settings, run Setup – “Network” – “Settings” (🔗 [page 75](#)).

I want to set the optimized listening environment after changing the configuration/position of the speakers or changing a speaker to a new one.

- Select Setup – “General” – “Speaker Response” (🔗 [page 70](#)).



Troubleshooting

If a problem should arise, first check the following:

1. Are the connections correct?
2. Is the set being operated as described in the owner's manual?
3. Are the other devices operating properly?

If this unit does not operate properly, check the items listed in the table below. Should the problem persist, there may be a malfunction. In this case, disconnect the power immediately and contact your store of purchase.

■ Power does not turn on / Power is turned off

Symptom	Cause/Solution	Page
Power does not turn on.	<ul style="list-style-type: none"> • Check whether the power plug is correctly inserted into the power outlet. 	23
Power automatically turns off.	<ul style="list-style-type: none"> • The sleep timer is set. Turn on the power again. • "Auto Standby" is set. "Auto Standby" is triggered when there is no operation for a set amount of time. To disable "Auto Standby", set "Auto Standby" on the menu to "Off". 	64 71

■ LED is flashing

Symptom	Cause/Solution	Page
Flashing red	<ul style="list-style-type: none"> • The amplifier circuit in the unit has malfunctioned. Disconnect the power and contact the repair center. 	23
Flashing orange	<ul style="list-style-type: none"> • The clock is incorrect because the AC was temporarily switched off, etc. Check the network connection and adjust the clock. 	70



■ Operations cannot be performed through the remote control unit

Symptom	Cause/Solution	Page
Operations cannot be performed through the remote control unit.	• Batteries are worn out. Replace with new batteries.	<u>6</u>
	• Operate the remote control unit within a distance of about 23 ft/7 m from this unit and at an angle of within 30°.	<u>6</u>
	• Remove any obstacle between this unit and the remote control unit.	–
	• Insert the batteries in the proper direction, checking the ⊕ and ⊖ marks.	<u>6</u>
	• The set's remote control sensor is exposed to strong light (direct sunlight, inverter type fluorescent bulb light, etc.). Move the set to a place in which the remote control sensor will not be exposed to strong light.	–
	• When using a 3D video device, the remote control unit of this unit may not function due to effects of infrared communications between units (such as TV and glasses for 3D viewing). In this case, adjust the direction of units with the 3D communications function and their distance to ensure they do not affect operations from the remote control unit of this unit.	–

■ Display on this unit shows nothing

Symptom	Cause/Solution	Page
Display is off.	• Press DIMMER on the remote control, and change the setting to anything other than "Display Off".	<u>64</u>



■ No sound comes out

Symptom	Cause/Solution	Page
No sound comes out of speakers.	• Check the connections for all devices.	16 , 18 , 19 , 21
	• Insert connection cables all the way in.	–
	• Check that input connectors and output connectors are not reversely connected.	–
	• Check cables for damage.	–
	• Check that speaker cables are properly connected. Check that cable core wires come in contact with the metal part on speaker terminals. Also, securely tighten speaker terminals. Check speaker terminals for looseness.	16
	• Check that a proper input source is selected.	25
	• Adjust the master volume.	26
	• Cancel the mute mode.	26
	• Check that the correct input source is selected when audio is being input to this unit from an external device.	51 , 53
	• Check the digital audio output settings of the connected device. The initial settings may be off depending on the device.	51
• Only 2-channel linear PCM can be input as the digital audio signal to the DIGITAL IN connector of this unit.	51	
• No sound is output from the speakers when headphones are connected.	9	



■ Desired sound does not come out



Symptom	Cause/Solution	Page
Left/right volume balance is unbalanced	<ul style="list-style-type: none"> Press the DBB/TONE button on the remote control to adjust the balance. 	63
No sound from the sub woofer.	<ul style="list-style-type: none"> Check the sub woofer connections. Switch the sub woofer power on. 	17 –
Set values are not reflected in “Dynamic Bass Boost”, “Bass”, “Treble” or “Speaker Response”.	<ul style="list-style-type: none"> “Dynamic Bass Boost”, “Bass”, “Treble” or “Speaker Response” settings are disabled when the audio source has a sampling frequency over 176.4 kHz. “Speaker Response” setting values are not reflected in headphone out or subwoofer out. “Dynamic Bass Boost”, “Bass” or “Treble” setting values are not reflected in subwoofer out. 	63 – –

■ Sound is interrupted or noise occurs

Symptom	Cause/Solution	Page
During playback from the Internet radio or USB memory device, sound is occasionally interrupted.	<ul style="list-style-type: none"> When the transfer speed of the USB memory device is slow, sound may occasionally be interrupted. The network communication speed is slow or the radio station is busy. 	– –
When making a call on iPhone, noise occurs in audio output on this unit.	<ul style="list-style-type: none"> When making a call, keep a distance of 8 inch (20 cm) or longer between iPhone and this unit. 	–
Sound cuts out when using Wi-Fi connection.	<ul style="list-style-type: none"> If nearby devices cause playback to cut out due to electronic interference, switch to a wired LAN connection. Particularly when you play back large music files, depending on your wireless LAN environment, the playback sound may be interrupted. In this case, make the wired LAN connection. 	21 , 22 , 75 75



■ iPod cannot be played back

Symptom	Cause/Solution	Page
iPod cannot be connected.	<ul style="list-style-type: none"> When using iPod by connecting it to the USB port, some iPod variations are not supported. When iPod is connected by using a USB cable other than the genuine cable, iPod may not be recognized. Use a genuine USB cable. 	<p>20</p> <p>–</p>
The AirPlay icon  is not displayed on iTunes / iPhone / iPod touch / iPad.	<ul style="list-style-type: none"> This unit and PC / iPhone / iPod touch / iPad are not connected to the same network (LAN). Connect it to the same LAN as this unit. The firmware on iTunes / iPhone / iPod touch / iPad is not compatible with AirPlay. Update the firmware to the latest version. 	<p>21</p> <p>–</p>
Audio is not output.	<ul style="list-style-type: none"> The volume on iTunes / iPhone / iPod touch / iPad is set to the minimum level. The volume on iTunes / iPhone / iPod touch / iPad is linked with the volume on this unit. Set a proper volume level. The AirPlay playback is not performed, or this unit is not selected. Click the AirPlay icon  on the iTunes / iPhone / iPod touch / iPad screen and select this unit. 	<p>–</p> <p>52</p>
Audio is interrupted during the AirPlay playback on iPhone / iPod touch / iPad.	<ul style="list-style-type: none"> Quit the application running in the background of the iPhone/iPod touch/iPad, and then play using AirPlay. Some external factors may be affecting the wireless connection. Modify the network environment by taking measures such as shortening the distance from the wireless LAN access point. 	<p>–</p> <p>–</p>
iTunes cannot be played back through the remote control unit.	<ul style="list-style-type: none"> Enable the “Allow iTunes control from remote speakers” setting on iTunes. Then, you can perform playback, pause, and skip operations through the remote control unit. 	<p>–</p>



■ USB memory devices cannot be played back

Symptom	Cause/Solution	Page
"No Connection" is displayed.	<ul style="list-style-type: none"> • The set cannot recognize a USB memory device. Disconnect and reconnect the USB memory device. • USB memory devices of a mass storage class or those compatible with MTP are supported. • This unit does not support a connection through a USB hub. Connect the USB memory device directly to the USB port. • The USB memory device must be formatted to FAT16 or FAT32. • Not all USB memory devices are guaranteed to work. Some USB memory devices are not recognized. When using a type of portable hard disc drive compatible with the USB connection that requires power from an AC adapter, use the AC adapter that came with the drive. 	<p><u>19</u></p> <p>–</p> <p>–</p> <p>–</p> <p>–</p>
Files on the USB memory device are not displayed.	<ul style="list-style-type: none"> • Files of a type not supported by this unit are not displayed. • This unit can display a file structure with up to 8 levels and up to 5000 subfolders and files in total. Modify the folder structure of the USB memory device. • When multiple partitions exist on the USB memory device, only files on the first partition are displayed. 	<p><u>49</u></p> <p>–</p> <p>–</p>
Files on a USB memory device cannot be played.	<ul style="list-style-type: none"> • Files are created in a format that is not supported by this unit. Check the formats supported by this unit. • You are attempting to play a file that is copyright protected. Files that are copyright protected cannot be played on this unit. 	<p><u>90</u></p> <p>–</p>



■ File names on the iPod/USB memory device are not displayed properly

Symptom	Cause/Solution	Page
The file names are not displayed properly ("...", etc.).	<ul style="list-style-type: none"> Characters that cannot be displayed are used. This is not a malfunction. On this unit, characters that cannot be displayed are replaced with a "." (period). 	–

■ The Internet radio cannot be played back

Symptom	Cause/Solution	Page
The broadcasting station list is not displayed.	<ul style="list-style-type: none"> The LAN cable is not properly connected, or the network is disconnected. Check the connection status. 	<u>21</u>
Internet Radio cannot be played.	<ul style="list-style-type: none"> The selected radio station is broadcasting in a format that is not supported by this unit. Formats that can be played back in this unit are MP3, WMA and AAC. The firewall function is enabled on the router. Check the firewall setting. The IP address is not properly set. Check the power of the router is on. To obtain the IP address automatically, enable the DHCP server function on the router. Also, set the DHCP setting to "On" on this unit. To obtain the IP address manually, set the IP address and proxy on this unit. Some radio stations broadcast silently during some time period. In this case, no audio is output. Wait for a while and select the same radio station, or select another radio station. 	<u>91</u> – <u>75</u> – <u>75</u> – <u>75</u> <u>28</u>
Cannot connect to favorite radio stations.	<ul style="list-style-type: none"> Radio station is not currently in service. Register radio stations in service. 	–
For some radio stations, "Connection down" is displayed and station cannot be connected to.	<ul style="list-style-type: none"> The selected radio station is not in service. Select a radio station in service. 	–



■ Music files on PC or NAS cannot be played back

Symptom	Cause/Solution	Page
Files stored on a computer cannot be played.	<ul style="list-style-type: none"> Files are stored in a non-compatible format. Record in a compatible format. You are attempting to play a file that is copyright protected. Files that are copyright protected cannot be played on this unit. Set and computer are connected by USB cable. The set's USB port cannot be used for connection to a computer. Media sharing settings are not correct. Change media sharing settings so that the unit can access the folders on your computer. 	<p>92</p> <p>–</p> <p>–</p> <p>31</p>
Server is not found, or it is not possible to connect to the server.	<ul style="list-style-type: none"> The computer's or router's firewall is activated. Check the computer's or router's firewall settings. Computer's power is not turned on. Turn on the power. Server is not running. Launch the server. Set's IP address is wrong. Check the set's IP address. 	<p>–</p> <p>–</p> <p>–</p> <p>74</p>
Music files on PC cannot be played back.	<ul style="list-style-type: none"> Even if PC is connected to the USB connector on this unit, music files on it cannot be played back. Connect PC or NAS to this unit through the network. 	21
Files on PC or NAS are not displayed.	<ul style="list-style-type: none"> Files of a type not supported by this unit are not displayed. 	92
Music stored on a NAS cannot be played.	<ul style="list-style-type: none"> If you use a NAS in conformity with the DLNA standard, enable the DLNA server function in the NAS setting. If you use a NAS that does not conform with the DLNA standard, play the music via a PC. Set Windows Media Player's media sharing function and add NAS to the selected play folder. If connection is restricted, set audio equipment as the connection target. 	<p>–</p> <p>31</p> <p>–</p>



■ Cannot connect by Wi-Fi

Symptom	Cause/Solution	Page
Cannot connect to the network.	<ul style="list-style-type: none"> • The network name and password (WEP, etc.) settings are wrong. Configure the network settings according to the setting details of this unit. • Reduce the distance between the wireless LAN access point and this unit, remove any obstructions and make sure the view to the access point is unobstructed before trying to connect again. Also, install microwave ovens and other network access points as far away as possible. • Check the router power supply. • This unit is compatible with IEEE 802.11b/g. • Configure the access point channel settings away from channels that are being used by other networks. • This unit is not compatible with WEP (TSN). 	<p><u>77</u></p> <p>–</p> <p>–</p> <p>–</p> <p>–</p>
Cannot connect to WPS.	<ul style="list-style-type: none"> • Check that the WPS mode of the router is operating. • Within 2 minutes, press and hold the Wi-Fi Connect button on the unit for three seconds. • A router/settings that are compatible with WPS 2.0 standards are required. Set the encryption time to “None”, “WPA-PSK (AES)” or “WPA2-PSK (AES)”. • If the router encryption method is WEP/WPA-TKIP/WPA2-TKIP, you cannot connect by using the Wi-Fi CONNECT button. In this case, use the “Auto-Scan” or “Manual” method to connect. 	<p>–</p> <p>–</p> <p><u>75</u></p> <p><u>76, 77</u></p>
Cannot connect to the network using iPhone/iPod touch/iPad	<ul style="list-style-type: none"> • Update the iPhone/iPod touch/iPad firmware to the latest version. 	–



Resetting factory settings

Perform this procedure if the display is abnormal or if operations cannot be performed.

When the microprocessor is reset, all the settings are reset to their default values and all previously stored custom settings will have to be manually restored.

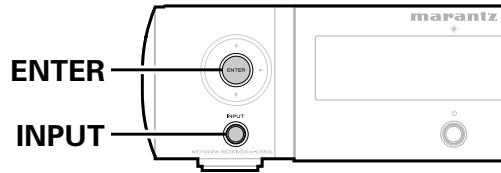

- 1 Pull the power cord out of the power outlet.**
- 2 Plug the power cord into a power outlet while pressing ENTER and INPUT on the main unit.**
- 3 When the power indicator lights green, release the buttons.**
"Initialized" appears in the display.



- If "Initialized" does not display in step 3, start over from step 1.



Appendix

Playing back USB memory devices

- This unit is compatible with MP3 ID3-Tag (Ver. 2) standard.
- This unit can show the artwork that was embedded by using MP3 ID3-Tag Ver. 2.3 or 2.4.
- This unit is compatible with WMA META tags.
- If the image size (pixels) of an album artwork exceeds 500 × 500 (WMA/MP3/WAV/FLAC) or 349 × 349 (MPEG-4 AAC), then music may not be played back properly.

Compatible formats

	Sampling frequency	Bit rate	Bit length	Extension
WMA (Windows Media Audio) *1	32/44.1/48 kHz	48 – 192 kbps	–	.wma
MP3 (MPEG-1 Audio Layer-3)	32/44.1/48 kHz	32 – 320 kbps	–	.mp3
WAV	32/44.1/48/88.2/96/176.4/192 kHz	–	16 / 24 bit	.wav
MPEG-4 AAC *2	32/44.1/48 kHz	16 – 320 kbps	–	.aac/ .m4a/ .mp4
FLAC (Free Lossless Audio Codec)	32/44.1/48/88.2/96/176.4/192 kHz	–	16 / 24 bit	.flac
ALAC (Apple Lossless Audio Codec) *3	32/44.1/48/88.2/96 kHz	–	16 / 24 bit	.m4a

- *1 Copyright-protected files can be played on certain portable players compatible with MTP.
- *2 Only files that are not protected by copyright can be played on this unit. Content downloaded from pay sites on the Internet are copyright protected. Also, files encoded in WMA format when ripped from a CD, etc. on a computer may be copyright protected, depending on the computer's settings.
- *3 Copyright [2012] [D&M Holdings, Inc.]
Licensed under the Apache License, Version 2.0 (the "License"); you may not use this file except in compliance with the License. You may obtain a copy of the License at <http://www.apache.org/licenses/LICENSE-2.0>



■ Maximum Number of Playable Files and Folder

The limits on the number of folders and files that can be displayed by this unit are as follows.

Item	Media	USB memory devices
Memory capacity		FAT16 : 2 GB, FAT32 : 2 TB
Number of folder directory levels *1		8 levels
Number of folders		500
Number of files *2		5000

*1 The limited number includes the root folder.

*2 The allowable number of files may differ according to the USB memory device capacity and the file size.

Playing back Internet Radio

■ Playable broadcast station specifications

	Sampling frequency	Bit rate	Extension
WMA (Windows Media Audio)	32/44.1/48 kHz	48 – 192 kbps	.wma
MP3 (MPEG-1 Audio Layer-3)	32/44.1/48 kHz	32 – 320 kbps	.mp3
MPEG-4 AAC	32/44.1/48 kHz	16 – 320 kbps	.aac/ .m4a/ .mp4



Playing back files stored on PC or NAS

- This unit is compatible with MP3 ID3-Tag (Ver. 2) standard.
- This unit can show the artwork that was embedded by using MP3 ID3-Tag Ver. 2.3 or 2.4.
- This unit is compatible with WMA META tags.
- If the image size (pixels) of an album artwork exceeds 500 × 500 (WMA/MP3/WAV/FLAC) or 349 × 349 (MPEG-4 AAC), then music may not be played back properly.
- A server or server software compatible with distribution in the corresponding formats is required to play music files via a network.

■ Playback file specifications

	Sampling frequency	Bit rate	Bit length	Extension
WMA (Windows Media Audio)	32/44.1/48 kHz	48 – 192 kbps	–	.wma
MP3 (MPEG-1 Audio Layer-3)	32/44.1/48 kHz	32 – 320 kbps	–	.mp3
WAV	32/44.1/48/88.2/96/176.4/192 kHz	–	16 / 24 bit	.wav
MPEG-4 AAC *1	32/44.1/48 kHz	16 – 320 kbps	–	.aac/ .m4a/ .mp4
FLAC (Free Lossless Audio Codec)	32/44.1/48/88.2/96/176.4/192 kHz	–	16 / 24 bit	.flac
ALAC (Apple Lossless Audio Codec) *2	32/44.1/48/88.2/96 kHz	–	16 / 24 bit	.m4a

- *1 Only files that are not protected by copyright can be played on this unit. Content downloaded from pay sites on the Internet are copyright protected. Also, files encoded in WMA format when ripped from a CD, etc. on a computer may be copyright protected, depending on the computer's settings.
- *2 Copyright [2012] [D&M Holdings. Inc.] Licensed under the Apache License, Version 2.0 (the "License"); you may not use this file except in compliance with the License. You may obtain a copy of the License at <http://www.apache.org/licenses/LICENSE-2.0>.



- Particularly when you play back large music files, depending on your wireless LAN environment, the playback sound may be interrupted. In this case, make the wired LAN connection.

Last function memory

This stores the settings as they were immediately before going into the standby mode.

When the power is turned back on, the settings are restored to as they were immediately before going into the standby mode.



Explanation of terms

A

AES (Advanced Encryption Standard)

This is a next generation standard encryption method replacing the current DES and 3DES, and because of its high security it is expected to be applied widely to wireless LANs in the future. It uses the "Rijndael" algorithm developed by two Belgian cryptographers to divide the data into blocks of fixed lengths and encrypt each block. It supports data lengths of 128, 192 and 256 bits and key lengths of 128, 192 and 256 bits as well, offering extremely high encryption security.

AirPlay

AirPlay sends (plays) contents recorded in iTunes or on an iPhone/iPod touch to a compatible device via the network.

ALAC (Apple Lossless Audio Codec)

This is a codec for lossless audio compression method developed by Apple Inc. This codec can be played back on iTunes, iPod or iPhone. Data compressed to approximately 60 – 70% can be decompressed to exactly the same original data.

B

Bit rate

This expresses the read amount per 1 second of video/audio data recorded in a disc. A larger number means higher sound quality, but also means a larger file size.

D

DLNA

DLNA and DLNA CERTIFIED are trademarks and/or service marks of Digital Living Network Alliance. Some contents may not be compatible with other DLNA CERTIFIED® products.

F

FLAC

FLAC stands for Free lossless Audio Codec, and is a lossless free audio file format. Lossless means that the audio is compressed without any loss in quality.

The FLAC license is as shown below.

Copyright (C) 2000, 2001, 2002, 2003, 2004, 2005, 2006, 2007, 2008, 2009 Josh Coalson

Redistribution and use in source and binary forms, with or without modification, are permitted provided that the following conditions are met:

- Redistributions of source code must retain the above copyright notice, this list of conditions and the following disclaimer.
- Redistributions in binary form must reproduce the above copyright notice, this list of conditions and the following disclaimer in the documentation and/or other materials provided with the distribution.
- Neither the name of the Xiph.org Foundation nor the names of its contributors may be used to endorse or promote products derived from this software without specific prior written permission.



THIS SOFTWARE IS PROVIDED BY THE COPYRIGHT HOLDERS AND CONTRIBUTORS "AS IS" AND ANY EXPRESS OR IMPLIED WARRANTIES, INCLUDING, BUT NOT LIMITED TO, THE IMPLIED WARRANTIES OF MERCHANTABILITY AND FITNESS FOR A PARTICULAR PURPOSE ARE DISCLAIMED. IN NO EVENT SHALL THE FOUNDATION OR CONTRIBUTORS BE LIABLE FOR ANY DIRECT, INDIRECT, INCIDENTAL, SPECIAL, EXEMPLARY, OR CONSEQUENTIAL DAMAGES (INCLUDING, BUT NOT LIMITED TO, PROCUREMENT OF SUBSTITUTE GOODS OR SERVICES; LOSS OF USE, DATA, OR PROFITS; OR BUSINESS INTERRUPTION) HOWEVER CAUSED AND ON ANY THEORY OF LIABILITY, WHETHER IN CONTRACT, STRICT LIABILITY, OR TORT (INCLUDING NEGLIGENCE OR OTHERWISE) ARISING IN ANY WAY OUT OF THE USE OF THIS SOFTWARE, EVEN IF ADVISED OF THE POSSIBILITY OF SUCH DAMAGE.

I

IEEE 802.11b

This is one wireless LAN standard set by the 802 working group that establishes LAN technology standards at the IEEE (Institute of Electrical and Electronics Engineers) of the United States. It uses the 2.4 GHz band usable freely without a radio frequency license (ISM band), enabling communications at a maximum speed of 11 Mbps.

- The value indicated above is the maximum theoretical value for the wireless LAN standard, and does not indicate the actual data transfer rate.

IEEE 802.11g

This is another wireless LAN standard set by the 802 working group that establishes LAN technology standards at the IEEE (Institute of Electrical and Electronics Engineers) of the United States, and is compatible with IEEE 802.11b. It also uses the 2.4 GHz band, but enables communications at a maximum speed of 54 Mbps.

- The value indicated above is the maximum theoretical value for the wireless LAN standard, and does not indicate the actual data transfer rate.

iTunes

iTunes is the name of the multimedia player provided by Apple Inc. It enables management and playback of multimedia contents including music and movies. iTunes supports many main file formats including AAC, WAV, and MP3.

M

MP3 (MPEG Audio Layer-3)

This is an internationally standardized audio data compression scheme, using the "MPEG-1" video compression standard. It compresses the data volume to about one eleventh its original size while maintaining sound quality equivalent to a music CD.

MPEG (Moving Picture Experts Group), MPEG-2, MPEG-4

These are the names for digital compression format standards used for the encoding of video and audio. Video standards include "MPEG-1 Video", "MPEG-2 Video", "MPEG-4 Visual", "MPEG-4 AVC". Audio standards include "MPEG-1 Audio", "MPEG-2 Audio", "MPEG-4 AAC".

N

Network Names (SSID: Security Set Identifier)

When forming wireless LAN networks, groups are formed to prevent interference, data theft, etc. This grouping is done by "SSID" or "Security Set Identifiers". For further security, a WEP key is set and signal transfer is not possible unless the SSID and WEP key match.



P

Protection circuit

This is a function to prevent damage to devices within the power supply when an abnormality such as an overload, excess voltage occurs or over temperature for any reason.

In this unit, the standby indicator blinks and the unit enters standby mode when an abnormality occurs.

S

Sampling frequency

Sampling involves taking a reading of a sound wave (analog signal) at regular intervals and expressing the height of the wave at each reading in digitized format (producing a digital signal).

The number of readings taken in one second is called the “sampling frequency”. The larger the value, the closer the reproduced sound is to the original.

Speaker impedance

This is an AC resistance value, indicated in Ω (ohms). Low impedance speakers will draw more power from this unit. Be sure that the impedance of the speakers is compatible with this unit to prevent activation of the protection circuit.

T

TKIP (Temporal Key Integrity Protocol)

This is a network key used for WPA. The encryption algorithm is RC4, the same as for WEP, but the security level is increased by changing the network key used for encryption for each packet.

V

vTuner

This is a free online content server for Internet Radio. Note that usage fees are included in upgrade costs.

For inquiries about this service, visit the vTuner site below.

vTuner website: <http://www.radiomarantz.com>

This product is protected by certain intellectual property rights of Nothing Else Matters Software and BridgeCo. Use or distribution of such technology outside of this product is prohibited without a license from Nothing Else Matters Software and BridgeCo or an authorized subsidiary.

W

WEP Key (Network Key)

This is key information used for encrypting data when conducting data transfer. On this unit, the same WEP key is used for data encryption and decryption, so the same WEP key must be set on both devices in order for communications to be established between them.

Wi-Fi[®]

Wi-Fi Certification assures tested and proven interoperability by the Wi-Fi Alliance, a group certifying interoperability among wireless LAN devices.



Windows Media DRM

This is a copyright protection technology developed by Microsoft. Content providers are using the digital rights management technology for Windows Media contained in this device (WM-DRM) to protect the integrity of their content (Secure Content) so that their intellectual property, including copyright, in such content is not misappropriated. This device uses WM-DRM software to play Secure Content (WM-DRM Software). If the security of the WM-DRM Software in this device has been compromised, owners of Secure Content (Secure Content Owners) may request that Microsoft revoke the WM-DRM Software's right to acquire new licenses to copy, display and/or play Secure Content. Revocation does not alter the WM-DRM Software's ability to play unprotected content. A list of revoked WM-DRM Software is sent to your device whenever you download a license for Secure Content from the Internet or from a PC. Microsoft may, in conjunction with such license, also download revocation list onto your device on behalf of Secure Content Owners.

Windows Media Player Ver.11 or later

This is a media player distributed free of charge by Microsoft Corporation. It can play playlists created with Ver.11 or later of Windows Media Player, as well as WMA, DRM WMA, WAV, and other files.

WMA (Windows Media Audio)

This is audio compression technology developed by Microsoft Corporation. WMA data can be encoded using Windows Media® Player. To encode WMA files, only use applications authorized by Microsoft Corporation. If you use an unauthorized application, the file may not work properly.

WPA (Wi-Fi Protected Access)

This is a security standard established by the Wi-Fi Alliance. In addition to the conventional SSID (network name) and WEP key (network key), it also uses a user identification function and encrypting protocol for stronger security.

WPA2 (Wi-Fi Protected Access 2)

This is a new version of the WPA established by the Wi-Fi Alliance, compatible with more secure AES encryption.

WPA-PSK/WPA2-PSK (Pre-shared Key)

This is a simple authentication system for mutual authentication when a preset character string matches on the wireless LAN access point and client.

WPS (Wi-Fi Protected Setup)

This is a standard drawn up by the Wi-Fi Alliance to ease the task of setting up wireless LAN connections and configuring security.

There are two methods: push-button and PIN (Personal Identification Number) code.



Trademark information

Made for



iPod



iPhone



AirPlay

“Made for iPod” and “Made for iPhone” mean that an electronic accessory has been designed to connect specifically to iPod, or iPhone, respectively, and has been certified by the developer to meet Apple performance standards.

Apple is not responsible for the operation of this device or its compliance with safety and regulatory standards. Please note that the use of this accessory with iPod, or iPhone, may affect wireless performance.

AirPlay, the AirPlay logo, iPad, iPhone, iPod, iPod classic, iPod nano, iPod shuffle and iPod touch are trademarks of Apple Inc., registered in the U.S. and other countries.

- Individual users are permitted to use iPhone, iPod, iPod classic, iPod nano, iPod shuffle, and iPod touch for private copy and playback of non-copyrighted contents and contents whose copy and playback is permitted by law. Copyright infringement is prohibited by law.



Windows Media and the Windows logo are trademarks or registered trademarks of Microsoft Corporation in the United States and/or other countries.



Adobe, the Adobe logo and Reader are either registered trademarks or trademarks of Adobe Systems Incorporated in the United States and/or other countries.



Specifications

■ Audio section

• Audio amplifier

Rated output:

2-channel driving

50 W + 50 W (6 Ω /ohms, 1 kHz, THD+N 0.7 %)**Dynamic power:**60 W + 60 W (6 Ω /ohms, 1 kHz, THD+N 10 %)**Output terminals:**Speaker 6 – 8 Ω /ohms

Suited for headphones/stereo headphones

Input sensitivity/impedance:Analog In : 200 mV/22 k Ω /kohms**THD+N (1 kHz, 5 W, 6 Ω /ohms):**

Analog In : 0.1 %

S/N ratio (10 W, 6 Ω /ohms, IHF-A):

Analog In : 86 dB

Tone control:

Dynamic Bass Boost : 100 Hz +8 dB

BASS : 100 Hz \pm 10 dBTREBLE : 10 kHz \pm 10 dB**Frequency response:**Analog In : 5 Hz – 22 kHz (\pm 3dB)

■ Wireless LAN

Network type (wireless LAN standards):

Conforming to IEEE 802.11b
Conforming to IEEE 802.11g
(Conforming to Wi-Fi®)*

Transfer rate:

DS-SS: 11 / 5.5 / 1 Mbps (Automatic switching)
OFDM: 54 / 48 / 36 / 24 / 18 / 12 / 9 / 6 Mbps (Automatic switching)

Security:

SSID (Network name)
WEP key (network key) (64/128 bits)
WPA-PSK (TKIP/AES)
WPA2-PSK (TKIP/AES)

Used frequency range:

2.412 GHz – 2.462 GHz

No. of channels:

Conforming to IEEE 802.11b : 11ch (DS-SS) (Of which 1 channel used)
Conforming to IEEE 802.11g : 11ch (OFDM) (Of which 1 channel used)

* Wi-Fi® conformity indicates tested and proven interoperability by the “Wi-Fi Alliance”, a group certifying interoperability among wireless LAN devices.



■ Clock/Alarm

Clock type:

Power line frequency synchronized method (Within ± 60 seconds per month)

Alarm:

Everyday alarm / Once alarm : One system each
Sleep timer : Max. 90 minutes

■ General

Power supply:

AC 120 V, 60 Hz

Power consumption:

55 W

Power consumption in standby mode:

0.3 W

Power consumption in

“Network Control” – “On” mode:

3 W

For purposes of improvement, specifications and design are subject to change without notice.



Index

A

Accessories.....	5
Add New Feature.....	72
Adjusting the master volume.....	26
AES.....	93
AirPlay.....	52, 93
ALAC.....	93
Alarm.....	69
Auto-Standby.....	71

B

Bit length.....	90, 92
Bit rate.....	90, 91, 92, 93

C

Cable.....	15
Audio cable.....	15
LAN cable.....	15
Optical cable.....	15
Speaker cable.....	15, 16
Subwoofer cable.....	15
USB adapter cable.....	19
Characters.....	41, 68
Charging the iPod/iPhone.....	48
Checking the current time.....	64
Clock.....	70
Connection	
Analog device.....	18
Digital device.....	18
Home network (LAN).....	21
iPod (USB).....	19
Power cord.....	23
Speaker.....	17
USB memory device.....	19

D

Direct iPod.....	47
DLNA.....	93

E

Extension.....	90, 91, 92
----------------	------------

F

Firmware.....	71
FLAC.....	93
Friendly Name.....	74
Front panel.....	8

I

IEEE 802.11b.....	94
IEEE 802.11g.....	94
Inputting characters.....	68
iTunes.....	94

L

Language.....	71
Last function memory.....	92









M

Menu map.....	65
General.....	65, 69
Network.....	66, 74
Quick Setup.....	65
MP3 (MPEG Audio Layer-3).....	94
MPEG.....	94

N

Network Control.....	74
Network Information.....	74
Network Names (SSID).....	94
Network settings.....	74
Notifications.....	72



 P		 R		 U	
Pandora®.....	35	Random playback.....	32, 42, 47, 50	Update.....	71
Playback		Rear panel.....	10		
ALAC.....	30, 49	Remote control unit.....	12	 V	
ANALOG IN.....	51	Inserting the batteries.....	6	vTuner.....	29, 95
DIGITAL IN.....	51	Remote iPod.....	47		
FLAC.....	30, 49	Repeat playback.....	32, 42, 47, 50	 W	
Internet Radio.....	27	Resetting factory settings.....	89	Web control.....	57
iPod (USB).....	45			WEP Key.....	95
MP3.....	27, 30, 49	 S		Wi-Fi.....	95
MPEG-4 AAC.....	27, 30, 49	Sampling frequency.....	90, 91, 92, 95	Windows Media DRM.....	95, 96
NAS.....	30	Selecting the input source.....	25	Windows Media Player.....	96
Pandora®.....	35	SiriusXM.....	39	WMA.....	96
PC.....	30	Sleep timer.....	64	WPA.....	96
SiriusXM.....	39	Speaker impedance.....	95	WPA2.....	96
Spotify.....	40	Speaker Response.....	70	WPA-PSK/WPA2-PSK.....	96
USB memory device.....	49	Spotify.....	40	WPS.....	96
WAV.....	30, 49	Switching the display's brightness.....	64		
WMA.....	27, 30, 49			 Q	
Protection circuit.....	95	 T		Quick Setup.....	65
		Tips.....	79		
		TKIP.....	95		
		Troubleshooting.....	80		
		Turning off the sound temporarily.....	26		
		Turning the power on.....	25		



License

This section describes software license used for this unit. To maintain the correct content, the original (English) is used.

□ Boost

<http://www.boost.org/>

Boost Software License - Version 1.0 - August 17th, 2003

Permission is hereby granted, free of charge, to any person or organization obtaining a copy of the software and accompanying documentation covered by this license (the "Software") to use, reproduce, display, distribute, execute, and transmit the Software, and to prepare derivative works of the Software, and to permit third-parties to whom the Software is furnished to do so, all subject to the following:

The copyright notices in the Software and this entire statement, including the above license grant, this restriction and the following disclaimer, must be included in all copies of the Software, in whole or in part, and all derivative works of the Software, unless such copies or derivative works are solely in the form of machine-executable object code generated by a source language processor.

THE SOFTWARE IS PROVIDED "AS IS", WITHOUT WARRANTY OF ANY KIND, EXPRESS OR IMPLIED, INCLUDING BUT NOT LIMITED TO THE WARRANTIES OF MERCHANTABILITY, FITNESS FOR A PARTICULAR PURPOSE, TITLE AND NON-INFRINGEMENT. IN NO EVENT SHALL THE COPYRIGHT HOLDERS OR ANYONE DISTRIBUTING THE SOFTWARE BE LIABLE FOR ANY DAMAGES OR OTHER LIABILITY, WHETHER IN CONTRACT, TORT OR OTHERWISE, ARISING FROM, OUT OF OR IN CONNECTION WITH THE SOFTWARE OR THE USE OR OTHER DEALINGS IN THE SOFTWARE.

□ Expat

<http://www.jclark.com/xml/expat.html>

Expat License. Copyright (c) 1998, 1999, 2000 Thai Open Source Software Center Ltd

Permission is hereby granted, free of charge, to any person obtaining a copy of this software and associated documentation files (the "Software"), to deal in the Software without restriction, including without limitation the rights to use, copy, modify, merge, publish, distribute, sublicense, and/or sell copies of the Software, and to permit persons to whom the Software is furnished to do so, subject to the following conditions:

The above copyright notice and this permission notice shall be included in all copies or substantial portions of the Software.

THE SOFTWARE IS PROVIDED "AS IS", WITHOUT WARRANTY OF ANY KIND, EXPRESS OR IMPLIED, INCLUDING BUT NOT LIMITED TO THE WARRANTIES OF MERCHANTABILITY, FITNESS FOR A PARTICULAR PURPOSE AND NON-INFRINGEMENT. IN NO EVENT SHALL THE AUTHORS OR COPYRIGHT HOLDERS BE LIABLE FOR ANY CLAIM, DAMAGES OR OTHER LIABILITY, WHETHER IN AN ACTION OF CONTRACT, TORT OR OTHERWISE, ARISING FROM, OUT OF OR IN CONNECTION WITH THE SOFTWARE OR THE USE OR OTHER DEALINGS IN THE SOFTWARE.

□ FastDelegate

<http://www.codeproject.com/KB/cpp/FastDelegate.aspx>

THE WORK (AS DEFINED BELOW) IS PROVIDED UNDER THE TERMS OF THIS CODE PROJECT OPEN LICENSE ("LICENSE"). THE WORK IS PROTECTED BY COPYRIGHT AND/OR OTHER APPLICABLE LAW. ANY USE OF THE WORK OTHER THAN AS AUTHORIZED UNDER THIS LICENSE OR COPYRIGHT LAW IS PROHIBITED.

BY EXERCISING ANY RIGHTS TO THE WORK PROVIDED HEREIN, YOU ACCEPT AND AGREE TO BE BOUND BY THE TERMS OF THIS LICENSE. THE AUTHOR GRANTS YOU THE RIGHTS CONTAINED HEREIN IN CONSIDERATION OF YOUR ACCEPTANCE OF SUCH TERMS AND CONDITIONS. IF YOU DO NOT AGREE TO ACCEPT AND BE BOUND BY THE TERMS OF THIS LICENSE, YOU CANNOT MAKE ANY USE OF THE WORK.

1. Definitions.

- a. "Articles" means, collectively, all articles written by Author which describes how the Source Code and Executable Files for the Work may be used by a user.
- b. "Author" means the individual or entity that offers the Work under the terms of this License.
- c. "Derivative Work" means a work based upon the Work or upon the Work and other pre-existing works.
- d. "Executable Files" refer to the executables, binary files, configuration and any required data files included in the Work.
- e. "Publisher" means the provider of the website, magazine, CD-ROM, DVD or other medium from or by which the Work is obtained by You.
- f. "Source Code" refers to the collection of source code and configuration files used to create the Executable Files.



- g. “Standard Version” refers to such a Work if it has not been modified, or has been modified in accordance with the consent of the Author, such consent being in the full discretion of the Author.
- h. “Work” refers to the collection of files distributed by the Publisher, including the Source Code, Executable Files, binaries, data files, documentation, whitepapers and the Articles.
- i. “You” is you, an individual or entity wishing to use the Work and exercise your rights under this License.
2. Fair Use/Fair Use Rights. Nothing in this License is intended to reduce, limit, or restrict any rights arising from fair use, fair dealing, first sale or other limitations on the exclusive rights of the copyright owner under copyright law or other applicable laws.
3. License Grant. Subject to the terms and conditions of this License, the Author hereby grants You a worldwide, royalty-free, non-exclusive, perpetual (for the duration of the applicable copyright) license to exercise the rights in the Work as stated below:
- You may use the standard version of the Source Code or Executable Files in Your own applications.
 - You may apply bug fixes, portability fixes and other modifications obtained from the Public Domain or from the Author. A Work modified in such a way shall still be considered the standard version and will be subject to this License.
 - You may otherwise modify Your copy of this Work (excluding the Articles) in any way to create a Derivative Work, provided that You insert a prominent notice in each changed file stating how, when and where You changed that file.
 - You may distribute the standard version of the Executable Files and Source Code or Derivative Work in aggregate with other (possibly commercial) programs as part of a larger (possibly commercial) software distribution.
- e. The Articles discussing the Work published in any form by the author may not be distributed or republished without the Author’s consent. The author retains copyright to any such Articles. You may use the Executable Files and Source Code pursuant to this License but you may not repost or republish or otherwise distribute or make available the Articles, without the prior written consent of the Author.
- Any subroutines or modules supplied by You and linked into the Source Code or Executable Files this Work shall not be considered part of this Work and will not be subject to the terms of this License.
4. Patent License. Subject to the terms and conditions of this License, each Author hereby grants to You a perpetual, worldwide, non-exclusive, no-charge, royalty-free, irrevocable (except as stated in this section) patent license to make, have made, use, import, and otherwise transfer the Work.
5. Restrictions. The license granted in Section 3 above is expressly made subject to and limited by the following restrictions:
- You agree not to remove any of the original copyright, patent, trademark, and attribution notices and associated disclaimers that may appear in the Source Code or Executable Files.
 - You agree not to advertise or in any way imply that this Work is a product of Your own.
 - The name of the Author may not be used to endorse or promote products derived from the Work without the prior written consent of the Author.
 - You agree not to sell, lease, or rent any part of the Work. This does not restrict you from including the Work or any part of the Work inside a larger software distribution that itself is being sold. The Work by itself, though, cannot be sold, leased or rented.
- e. You may distribute the Executable Files and Source Code only under the terms of this License, and You must include a copy of, or the Uniform Resource Identifier for, this License with every copy of the Executable Files or Source Code You distribute and ensure that anyone receiving such Executable Files and Source Code agrees that the terms of this License apply to such Executable Files and/or Source Code. You may not offer or impose any terms on the Work that alter or restrict the terms of this License or the recipients’ exercise of the rights granted hereunder. You may not sublicense the Work. You must keep intact all notices that refer to this License and to the disclaimer of warranties. You may not distribute the Executable Files or Source Code with any technological measures that control access or use of the Work in a manner inconsistent with the terms of this License.
- f. You agree not to use the Work for illegal, immoral or improper purposes, or on pages containing illegal, immoral or improper material. The Work is subject to applicable export laws. You agree to comply with all such laws and regulations that may apply to the Work after Your receipt of the Work.



6. Representations, Warranties and Disclaimer. THIS WORK IS PROVIDED "AS IS", "WHERE IS" AND "AS AVAILABLE", WITHOUT ANY EXPRESS OR IMPLIED WARRANTIES OR CONDITIONS OR GUARANTEES. YOU, THE USER, ASSUME ALL RISK IN ITS USE, INCLUDING COPYRIGHT INFRINGEMENT, PATENT INFRINGEMENT, SUITABILITY, ETC. AUTHOR EXPRESSLY DISCLAIMS ALL EXPRESS, IMPLIED OR STATUTORY WARRANTIES OR CONDITIONS, INCLUDING WITHOUT LIMITATION, WARRANTIES OR CONDITIONS OF MERCHANTABILITY, MERCHANTABLE QUALITY OR FITNESS FOR A PARTICULAR PURPOSE, OR ANY WARRANTY OF TITLE OR NON-INFRINGEMENT, OR THAT THE WORK (OR ANY PORTION THEREOF) IS CORRECT, USEFUL, BUG-FREE OR FREE OF VIRUSES. YOU MUST PASS THIS DISCLAIMER ON WHENEVER YOU DISTRIBUTE THE WORK OR DERIVATIVE WORKS.
7. Indemnity. You agree to defend, indemnify and hold harmless the Author and the Publisher from and against any claims, suits, losses, damages, liabilities, costs, and expenses (including reasonable legal or attorneys' fees) resulting from or relating to any use of the Work by You.
8. Limitation on Liability. EXCEPT TO THE EXTENT REQUIRED BY APPLICABLE LAW, IN NO EVENT WILL THE AUTHOR OR THE PUBLISHER BE LIABLE TO YOU ON ANY LEGAL THEORY FOR ANY SPECIAL, INCIDENTAL, CONSEQUENTIAL, PUNITIVE OR EXEMPLARY DAMAGES ARISING OUT OF THIS LICENSE OR THE USE OF THE WORK OR OTHERWISE, EVEN IF THE AUTHOR OR THE PUBLISHER HAS BEEN ADVISED OF THE POSSIBILITY OF SUCH DAMAGES.
9. Termination.
- This License and the rights granted hereunder will terminate automatically upon any breach by You of any term of this License. Individuals or entities who have received Derivative Works from You under this License, however, will not have their licenses terminated provided such individuals or entities remain in full compliance with those licenses. Sections 1, 2, 6, 7, 8, 9, 10 and 11 will survive any termination of this License.
 - If You bring a copyright, trademark, patent or any other infringement claim against any contributor over infringements You claim are made by the Work, your License from such contributor to the Work ends automatically.
 - Subject to the above terms and conditions, this License is perpetual (for the duration of the applicable copyright in the Work). Notwithstanding the above, the Author reserves the right to release the Work under different license terms or to stop distributing the Work at any time; provided, however that any such election will not serve to withdraw this License (or any other license that has been, or is required to be, granted under the terms of this License), and this License will continue in full force and effect unless terminated as stated above.
10. Publisher. The parties hereby confirm that the Publisher shall not, under any circumstances, be responsible for and shall not have any liability in respect of the subject matter of this License. The Publisher makes no warranty whatsoever in connection with the Work and shall not be liable to You or any party on any legal theory for any damages whatsoever, including without limitation any general, special, incidental or consequential damages arising in connection to this license. The Publisher reserves the right to cease making the Work available to You at any time without notice
11. Miscellaneous
- This License shall be governed by the laws of the location of the head office of the Author or if the Author is an individual, the laws of location of the principal place of residence of the Author.
 - If any provision of this License is invalid or unenforceable under applicable law, it shall not affect the validity or enforceability of the remainder of the terms of this License, and without further action by the parties to this License, such provision shall be reformed to the minimum extent necessary to make such provision valid and enforceable.
 - No term or provision of this License shall be deemed waived and no breach consented to unless such waiver or consent shall be in writing and signed by the party to be charged with such waiver or consent.
 - This License constitutes the entire agreement between the parties with respect to the Work licensed herein. There are no understandings, agreements or representations with respect to the Work not specified herein. The Author shall not be bound by any additional provisions that may appear in any communication from You. This License may not be modified without the mutual written agreement of the Author and You.



<http://www.xiph.org/ogg/>

Copyright (c) 2002, Xiph.org Foundation

Redistribution and use in source and binary forms, with or without modification, are permitted provided that the following conditions are met:

- Redistributions of source code must retain the above copyright notice, this list of conditions and the following disclaimer.



- Redistributions in binary form must reproduce the above copyright notice, this list of conditions and the following disclaimer in the documentation and/or other materials provided with the distribution.
- Neither the name of the Xiph.org Foundation nor the names of its contributors may be used to endorse or promote products derived from this software without specific prior written permission.

THIS SOFTWARE IS PROVIDED BY THE COPYRIGHT HOLDERS AND CONTRIBUTORS "AS IS" AND ANY EXPRESS OR IMPLIED WARRANTIES, INCLUDING, BUT NOT LIMITED TO, THE IMPLIED WARRANTIES OF MERCHANTABILITY AND FITNESS FOR A PARTICULAR PURPOSE ARE DISCLAIMED. IN NO EVENT SHALL THE FOUNDATION OR CONTRIBUTORS BE LIABLE FOR ANY DIRECT, INDIRECT, INCIDENTAL, SPECIAL, EXEMPLARY, OR CONSEQUENTIAL DAMAGES (INCLUDING, BUT NOT LIMITED TO, PROCUREMENT OF SUBSTITUTE GOODS OR SERVICES; LOSS OF USE, DATA, OR PROFITS; OR BUSINESS INTERRUPTION) HOWEVER CAUSED AND ON ANY THEORY OF LIABILITY, WHETHER IN CONTRACT, STRICT LIABILITY, OR TORT (INCLUDING NEGLIGENCE OR OTHERWISE) ARISING IN ANY WAY OUT OF THE USE OF THIS SOFTWARE, EVEN IF ADVISED OF THE POSSIBILITY OF SUCH DAMAGE.

libvorbis

<http://www.xiph.org/vorbis/>

Copyright (c) 2002-2004 Xiph.org Foundation

Redistribution and use in source and binary forms, with or without modification, are permitted provided that the following conditions are met:

- Redistributions of source code must retain the above copyright notice, this list of conditions and the following disclaimer.
- Redistributions in binary form must reproduce the above copyright notice, this list of conditions and the following disclaimer in the documentation and/or other materials provided with the distribution.
- Neither the name of the Xiph.org Foundation nor the names of its contributors may be used to endorse or promote products derived from this software without specific prior written permission.

THIS SOFTWARE IS PROVIDED BY THE COPYRIGHT HOLDERS AND CONTRIBUTORS "AS IS" AND ANY EXPRESS OR IMPLIED WARRANTIES, INCLUDING, BUT NOT LIMITED TO, THE IMPLIED WARRANTIES OF MERCHANTABILITY AND FITNESS FOR A PARTICULAR PURPOSE ARE DISCLAIMED. IN NO EVENT SHALL THE FOUNDATION OR CONTRIBUTORS BE LIABLE FOR ANY DIRECT, INDIRECT, INCIDENTAL, SPECIAL, EXEMPLARY, OR CONSEQUENTIAL DAMAGES (INCLUDING, BUT NOT LIMITED TO, PROCUREMENT OF SUBSTITUTE GOODS OR SERVICES; LOSS OF USE, DATA, OR PROFITS; OR BUSINESS INTERRUPTION) HOWEVER CAUSED AND ON ANY THEORY OF LIABILITY, WHETHER IN CONTRACT, STRICT LIABILITY, OR TORT (INCLUDING NEGLIGENCE OR OTHERWISE) ARISING IN ANY WAY OUT OF THE USE OF THIS SOFTWARE, EVEN IF ADVISED OF THE POSSIBILITY OF SUCH DAMAGE.

Tremolo

<http://wss.co.uk/pinknoise/tremolo>

Copyright (C) 2002-2009 Xiph.org Foundation Changes
Copyright (C) 2009-2010 Robin Watts for Pinknoise Productions Ltd

Redistribution and use in source and binary forms, with or without modification, are permitted provided that the following conditions are met:

- Redistributions of source code must retain the above copyright notice, this list of conditions and the following disclaimer.
- Redistributions in binary form must reproduce the above copyright notice, this list of conditions and the following disclaimer in the documentation and/or other materials provided with the distribution.
- Neither the name of the Xiph.org Foundation nor the names of its contributors may be used to endorse or promote products derived from this software without specific prior written permission.

THIS SOFTWARE IS PROVIDED BY THE COPYRIGHT HOLDERS AND CONTRIBUTORS "AS IS" AND ANY EXPRESS OR IMPLIED WARRANTIES, INCLUDING, BUT NOT LIMITED TO, THE IMPLIED WARRANTIES OF MERCHANTABILITY AND FITNESS FOR A PARTICULAR PURPOSE ARE DISCLAIMED. IN NO EVENT SHALL THE FOUNDATION OR CONTRIBUTORS BE LIABLE FOR ANY DIRECT, INDIRECT, INCIDENTAL, SPECIAL, EXEMPLARY, OR CONSEQUENTIAL DAMAGES (INCLUDING, BUT NOT LIMITED TO, PROCUREMENT OF SUBSTITUTE GOODS OR SERVICES; LOSS OF USE, DATA, OR PROFITS; OR BUSINESS INTERRUPTION) HOWEVER CAUSED AND ON ANY THEORY OF LIABILITY, WHETHER IN CONTRACT, STRICT LIABILITY, OR TORT (INCLUDING NEGLIGENCE OR OTHERWISE) ARISING IN ANY WAY OUT OF THE USE OF THIS SOFTWARE, EVEN IF ADVISED OF THE POSSIBILITY OF SUCH DAMAGE.



❏ Tremor

<http://wiki.xiph.org/index.php/Tremor>

Copyright (c) 2002, Xiph.org Foundation

Redistribution and use in source and binary forms, with or without modification, are permitted provided that the following conditions are met:

- Redistributions of source code must retain the above copyright notice, this list of conditions and the following disclaimer.
- Redistributions in binary form must reproduce the above copyright notice, this list of conditions and the following disclaimer in the documentation and/or other materials provided with the distribution.
- Neither the name of the Xiph.org Foundation nor the names of its contributors may be used to endorse or promote products derived from this software without specific prior written permission.

THIS SOFTWARE IS PROVIDED BY THE COPYRIGHT HOLDERS AND CONTRIBUTORS "AS IS" AND ANY EXPRESS OR IMPLIED WARRANTIES, INCLUDING, BUT NOT LIMITED TO, THE IMPLIED WARRANTIES OF MERCHANTABILITY AND FITNESS FOR A PARTICULAR PURPOSE ARE DISCLAIMED. IN NO EVENT SHALL THE FOUNDATION OR CONTRIBUTORS BE LIABLE FOR ANY DIRECT, INDIRECT, INCIDENTAL, SPECIAL, EXEMPLARY, OR CONSEQUENTIAL DAMAGES (INCLUDING, BUT NOT LIMITED TO, PROCUREMENT OF SUBSTITUTE GOODS OR SERVICES; LOSS OF USE, DATA, OR PROFITS; OR BUSINESS INTERRUPTION) HOWEVER CAUSED AND ON ANY THEORY OF LIABILITY, WHETHER IN CONTRACT, STRICT LIABILITY, OR TORT (INCLUDING NEGLIGENCE OR OTHERWISE) ARISING IN ANY WAY OUT OF THE USE OF THIS SOFTWARE, EVEN IF ADVISED OF THE POSSIBILITY OF SUCH DAMAGE.

❏ Mersenne Twister

<http://www.math.sci.hiroshima-u.ac.jp/~m-mat/MT/MT2002/CODES/mt19937ar.c>

Copyright (C) 1997 - 2002, Makoto Matsumoto and Takuji Nishimura,
All rights reserved.

Redistribution and use in source and binary forms, with or without modification, are permitted provided that the following conditions are met:

1. Redistributions of source code must retain the above copyright notice, this list of conditions and the following disclaimer.

2. Redistributions in binary form must reproduce the above copyright notice, this list of conditions and the following disclaimer in the documentation and/or other materials provided with the distribution.
3. The names of its contributors may not be used to endorse or promote products derived from this software without specific prior written permission.

THIS SOFTWARE IS PROVIDED BY THE COPYRIGHT HOLDERS AND CONTRIBUTORS "AS IS" AND ANY EXPRESS OR IMPLIED WARRANTIES, INCLUDING, BUT NOT LIMITED TO, THE IMPLIED WARRANTIES OF MERCHANTABILITY AND FITNESS FOR A PARTICULAR PURPOSE ARE DISCLAIMED. IN NO EVENT SHALL THE COPYRIGHT OWNER OR CONTRIBUTORS BE LIABLE FOR ANY DIRECT, INDIRECT, INCIDENTAL, SPECIAL, EXEMPLARY, OR CONSEQUENTIAL DAMAGES (INCLUDING, BUT NOT LIMITED TO, PROCUREMENT OF SUBSTITUTE GOODS OR SERVICES; LOSS OF USE, DATA, OR PROFITS; OR BUSINESS INTERRUPTION) HOWEVER CAUSED AND ON ANY THEORY OF LIABILITY, WHETHER IN CONTRACT, STRICT LIABILITY, OR TORT (INCLUDING NEGLIGENCE OR OTHERWISE) ARISING IN ANY WAY OUT OF THE USE OF THIS SOFTWARE, EVEN IF ADVISED OF THE POSSIBILITY OF SUCH DAMAGE.



**zlib**

<http://www.zlib.net/>

zlib.h – interface of the ‘zlib’ general purpose compression library version 1.2.3, July 18th, 2005

Copyright (C) 1995-2004 Jean-loup Gailly and Mark Adler

This software is provided ‘as-is’, without any express or implied warranty. In no event will the authors be held liable for any damages arising from the use of this software.

Permission is granted to anyone to use this software for any purpose, including commercial applications, and to alter it and redistribute it freely, subject to the following restrictions:

1. The origin of this software must not be misrepresented; you must not claim that you wrote the original software. If you use this software in a product, an acknowledgment in the product documentation would be appreciated but is not required.
2. Altered source versions must be plainly marked as such, and must not be misrepresented as being the original software.
3. This notice may not be removed or altered from any source distribution.

Jean-loup Gailly jloup@gzip.org, Mark Adler madler@alumni.caltech.edu

**cURL**

<http://curl.haxx.se>

COPYRIGHT AND PERMISSION NOTICE

Copyright (c) 1996 - 2011, Daniel Stenberg, <daniel@haxx.se>.

All rights reserved.

Permission to use, copy, modify, and distribute this software for any purpose with or without fee is hereby granted, provided that the above copyright notice and this permission notice appear in all copies.

THE SOFTWARE IS PROVIDED “AS IS”, WITHOUT WARRANTY OF ANY KIND, EXPRESS OR IMPLIED, INCLUDING BUT NOT LIMITED TO THE WARRANTIES OF MERCHANTABILITY, FITNESS FOR A PARTICULAR PURPOSE AND NONINFRINGEMENT OF THIRD PARTY RIGHTS. IN NO EVENT SHALL THE AUTHORS OR COPYRIGHT HOLDERS BE LIABLE FOR ANY CLAIM, DAMAGES OR OTHER LIABILITY, WHETHER IN AN ACTION OF CONTRACT, TORT OR OTHERWISE, ARISING FROM, OUT OF OR IN CONNECTION WITH THE SOFTWARE OR THE USE OR OTHER DEALINGS IN THE SOFTWARE.

Except as contained in this notice, the name of a copyright holder shall not be used in advertising or otherwise to promote the sale, use or other dealings in this Software without prior written authorization of the copyright holder.

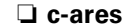
**c-ares**

<http://c-ares.haxx.se>

Copyright 1998 by the Massachusetts Institute of Technology.

Permission to use, copy, modify, and distribute this software and its documentation for any purpose and without fee is hereby granted, provided that the above copyright notice appear in all copies and that both that copyright notice and this permission notice appear in supporting documentation, and that the name of M.I.T. not be used in advertising or publicity pertaining to distribution of the software without specific, written prior permission. M.I.T. makes no representations about the suitability of this software for any purpose. It is provided “as is” without express or implied warranty.



■ License Information for the Software Used in the Unit

About GPL (GNU-General Public License), LGPL (GNU Lesser General Public License) License

This product uses GPL/LGPL software and software made by other companies.

After you purchase this product, you may procure, modify or distribute the source code of the GPL/LGPL software that is used in the product.

Marantz provides the source code based on the GPL and LGPL licenses at the actual cost upon your request to our customer service center. However, note that we make no guarantees concerning the source code. Please also understand that we do not offer support for the contents of the source code.



■ Dimensions

Unit : in. (mm)

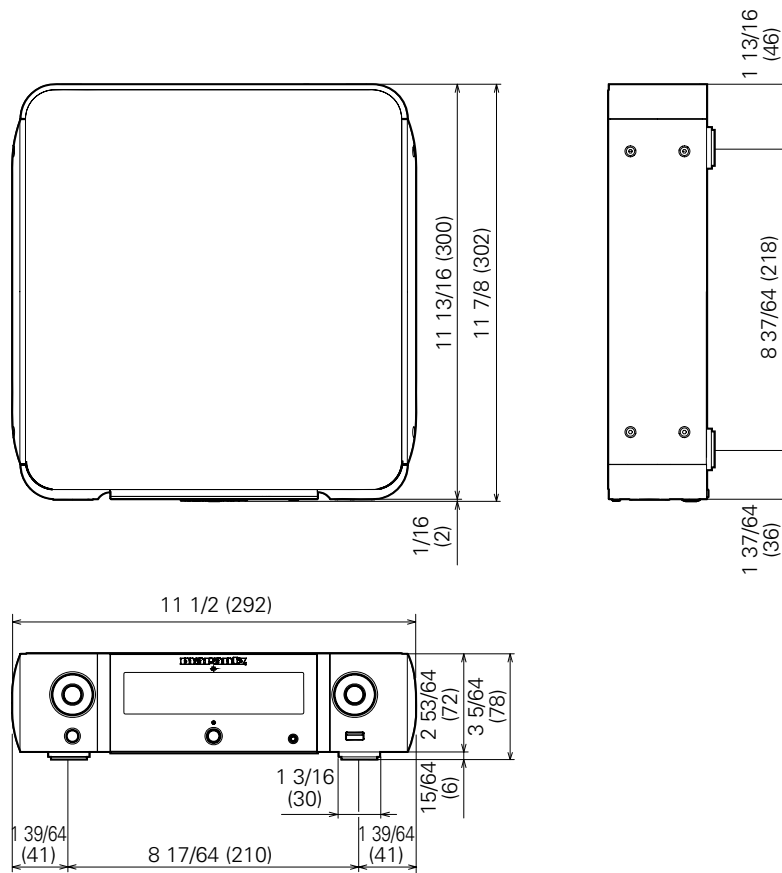

■ Weight : 5 lbs 15 oz (2.7 kg)



www.marantz.com

You can find your nearest authorized distributor or dealer on our website.

marantz[®] is a registered trademark.