



**marantz®**

AV Pre Tuner  
**AV7005**

User Guide



## SAFETY PRECAUTIONS



**CAUTION**  
**RISK OF ELECTRIC SHOCK**  
**DO NOT OPEN**



**CAUTION:**  
**TO REDUCE THE RISK OF ELECTRIC SHOCK, DO NOT REMOVE COVER (OR BACK). NO USER-SERVICEABLE PARTS INSIDE. REFER SERVICING TO QUALIFIED SERVICE PERSONNEL.**

The lightning flash with arrowhead symbol, within an equilateral triangle, is intended to alert the user to the presence of uninsulated "dangerous voltage" within the product's enclosure that may be of sufficient magnitude to constitute a risk of electric shock to persons.

The exclamation point within an equilateral triangle is intended to alert the user to the presence of important operating and maintenance (servicing) instructions in the literature accompanying the appliance.

**WARNING:**  
**TO REDUCE THE RISK OF FIRE OR ELECTRIC SHOCK, DO NOT EXPOSE THIS APPLIANCE TO RAIN OR MOISTURE.**

## IMPORTANT SAFETY INSTRUCTIONS

1. Read these instructions.
2. Keep these instructions.
3. Heed all warnings.
4. Follow all instructions.
5. Do not use this apparatus near water.
6. Clean only with dry cloth.
7. Do not block any ventilation openings. Install in accordance with the manufacturer's instructions.
8. Do not install near any heat sources such as radiators, heat registers, stoves, or other apparatus (including amplifiers) that produce heat.
9. Do not defeat the safety purpose of the polarized or grounding-type plug. A polarized plug has two blades with one wider than the other. A grounding type plug has two blades and a third grounding prong. The wide blade or the third prong are provided for your safety. If the provided plug does not fit into your outlet, consult an electrician for replacement of the obsolete outlet.
10. Protect the power cord from being walked on or pinched particularly at plugs, convenience receptacles, and the point where they exit from the apparatus.
11. Only use attachments/accessories specified by the manufacturer.
12. Use only with the cart, stand, tripod, bracket, or table specified by the manufacturer, or sold with the apparatus. When a cart is used, use caution when moving the cart/apparatus combination to avoid injury from tip-over.
13. Unplug this apparatus during lightning storms or when unused for long periods of time.
14. Refer all servicing to qualified service personnel. Servicing is required when the apparatus has been damaged in any way, such as power-supply cord or plug is damaged, liquid has been spilled or objects have fallen into the apparatus, the apparatus has been exposed to rain or moisture, does not operate normally, or has been dropped.
15. Batteries shall not be exposed to excessive heat such as sunshine, fire or the like.



### CAUTION:

To completely disconnect this product from the mains, disconnect the plug from the wall socket outlet.

The mains plug is used to completely interrupt the power supply to the unit and must be within easy access by the user.

### PRECAUTION:

Pour déconnecter complètement ce produit du courant secteur, débranchez la prise de la prise murale.

La prise secteur est utilisée pour couper complètement l'alimentation de l'appareil et l'utilisateur doit pouvoir y accéder facilement.

### PRECAUCIÓN:

Para desconectar completamente este producto de la alimentación eléctrica, desconecte el enchufe del enchufe de la pared.

El enchufe de la alimentación eléctrica se utiliza para interrumpir por completo el suministro de alimentación eléctrica a la unidad y debe de encontrarse en un lugar al que el usuario tenga fácil acceso.

## FCC INFORMATION (For US customers)

### 1. COMPLIANCE INFORMATION

Product Name: AV Pre Tuner

Model Number: AV7005

This product complies with Part 15 of the FCC Rules. Operation is subject to the following two conditions: (1) this product may not cause harmful interference, and (2) this product must accept any interference received, including interference that may cause undesired operation.

Marantz America, Inc.

(a D & M Holdings Company)

100 Corporate Drive,

Mahwah, NJ, 07430, U.S.A.

Tel. (630) 741-0300

### 2. IMPORTANT NOTICE: DO NOT MODIFY THIS PRODUCT

This product, when installed as indicated in the instructions contained in this manual, meets FCC requirements. Modification not expressly approved by Marantz may void your authority, granted by the FCC, to use the product.

### 3. IMPORTANT

When connecting this product to network hub or router, use only shielded STP or ScTP LAN cables which is available at retailer.

Follow all installation instructions. Failure to follow instructions could void your authority, granted by the FCC, to use the product.

### 4. NOTE

This product has been tested and found to comply with the limits for a Class B digital device, pursuant to Part 15 of the FCC Rules. These limits are designed to provide reasonable protection against harmful interference in a residential installation.

This product generates, uses and can radiate radio frequency energy and, if not installed and used in accordance with the instructions, may cause harmful interference to radio communications. However, there is no guarantee that interference will not occur in a particular installation. If this product does cause harmful interference to radio or television reception, which can be determined by turning the product OFF and ON, the user is encouraged to try to correct the interference by one or more of the following measures:

- Reorient or relocate the receiving antenna.
- Increase the separation between the equipment and receiver.
- Connect the product into an outlet on a circuit different from that to which the receiver is connected.
- Consult the local retailer authorized to distribute this type of product or an experienced radio/TV technician for help.

### For Canadian customers:

This Class B digital apparatus complies with Canadian ICES-003.

Cet appareil numérique de la classe B est conforme à la norme NMB-003 du Canada.

## □ NOTES ON USE / OBSERVATIONS RELATIVES A L'UTILISATION / NOTAS SOBRE EL USO

WARNINGS	AVERTISSEMENTS	ADVERTENCIAS
<ul style="list-style-type: none"> <li>• Avoid high temperatures. Allow for sufficient heat dispersion when installed in a rack.</li> <li>• Handle the power cord carefully. Hold the plug when unplugging the cord.</li> <li>• Keep the unit free from moisture, water, and dust.</li> <li>• Unplug the power cord when not using the unit for long periods of time.</li> <li>• Do not obstruct the ventilation holes.</li> <li>• Do not let foreign objects into the unit.</li> <li>• Do not let insecticides, benzene, and thinner come in contact with the unit.</li> <li>• Never disassemble or modify the unit in any way.</li> <li>• Ventilation should not be impeded by covering the ventilation openings with items, such as newspapers, tablecloths or curtains.</li> <li>• Naked flame sources such as lighted candles should not be placed on the unit.</li> <li>• Observe and follow local regulations regarding battery disposal.</li> <li>• Do not expose the unit to dripping or splashing fluids.</li> <li>• Do not place objects filled with liquids, such as vases, on the unit.</li> <li>• Do not handle the mains cord with wet hands.</li> <li>• When the switch is in the OFF position, the equipment is not completely switched off from MAINS.</li> <li>• The equipment shall be installed near the power supply so that the power supply is easily accessible.</li> </ul>	<ul style="list-style-type: none"> <li>• Eviter des températures élevées. Tenir compte d'une dispersion de chaleur suffisante lors de l'installation sur une étagère.</li> <li>• Manipuler le cordon d'alimentation avec précaution. Tenir la prise lors du débranchement du cordon.</li> <li>• Protéger l'appareil contre l'humidité, l'eau et la poussière.</li> <li>• Débrancher le cordon d'alimentation lorsque l'appareil n'est pas utilisé pendant de longues périodes.</li> <li>• Ne pas obstruer les trous d'aération.</li> <li>• Ne pas laisser des objets étrangers dans l'appareil.</li> <li>• Ne pas mettre en contact des insecticides, du benzène et un diluant avec l'appareil.</li> <li>• Ne jamais démonter ou modifier l'appareil d'une manière ou d'une autre.</li> <li>• Ne pas recouvrir les orifices de ventilation avec des objets tels que des journaux, nappes ou rideaux. Cela entraverait la ventilation.</li> <li>• Ne jamais placer de flamme nue sur l'appareil, notamment des bougies allumées.</li> <li>• Veillez à respecter les lois en vigueur lorsque vous jetez les piles usagées.</li> <li>• L'appareil ne doit pas être exposé à l'eau ou à l'humidité.</li> <li>• Ne pas poser d'objet contenant du liquide, par exemple un vase, sur l'appareil.</li> <li>• Ne pas manipuler le cordon d'alimentation avec les mains mouillées.</li> <li>• Lorsque l'interrupteur est sur la position OFF, l'appareil n'est pas complètement déconnecté du SECTEUR (MAINS).</li> <li>• L'appareil sera installé près de la source d'alimentation, de sorte que cette dernière soit facilement accessible.</li> </ul>	<ul style="list-style-type: none"> <li>• Evite altas temperaturas. Permite la suficiente dispersión del calor cuando está instalado en la consola.</li> <li>• Maneje el cordón de energía con cuidado. Sostenga el enchufe cuando desconecte el cordón de energía.</li> <li>• Mantenga el equipo libre de humedad, agua y polvo.</li> <li>• Desconecte el cordón de energía cuando no utilice el equipo por mucho tiempo.</li> <li>• No obstruya los orificios de ventilación.</li> <li>• No deje objetos extraños dentro del equipo.</li> <li>• No permita el contacto de insecticidas, gasolina y diluyentes con el equipo.</li> <li>• Nunca desarme o modifique el equipo de ninguna manera.</li> <li>• La ventilación no debe quedar obstruida por haberse cubierto las aperturas con objetos como periódicos, manteles o cortinas.</li> <li>• No deberán colocarse sobre el aparato fuentes inflamables sin protección, como velas encendidas.</li> <li>• A la hora de deshacerse de las pilas, respete la normativa para el cuidado del medio ambiente.</li> <li>• No exponer el aparato al goteo o salpicaduras cuando se utilice.</li> <li>• No colocar sobre el aparato objetos llenos de líquido, como jarros.</li> <li>• No maneje el cable de alimentación con las manos mojadas.</li> <li>• Cuando el interruptor está en la posición OFF, el equipo no está completamente desconectado de la alimentación MAINS.</li> <li>• El equipo se instalará cerca de la fuente de alimentación de manera que resulte fácil acceder a ella.</li> </ul>

## □ CAUTIONS ON INSTALLATION PRÉCAUTIONS D'INSTALLATION EMPLAZAMIENTO DE LA INSTALACIÓN

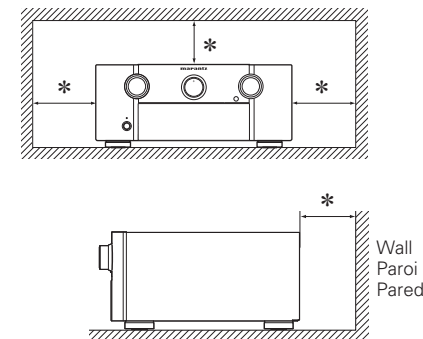

**\* For proper heat dispersal, do not install this unit in a confined space, such as a bookcase or similar enclosure.**

- More than 0.3 m (12 in.) is recommended.
- Do not place any other equipment on this unit.

**\* Pour permettre la dissipation de chaleur requise, n'installez pas cette unité dans un espace confiné tel qu'une bibliothèque ou un endroit similaire.**

- Une distance de plus de 0,3 m (12 po) est recommandée.
- Ne placez aucun matériel sur cet appareil.

**\* Para la dispersión del calor adecuadamente, no instale este equipo en un lugar confinado tal como una librería o unidad similar.**

- Se recomienda dejar más de 0,3 m (12 pulg.) alrededor.
- No coloque ningún otro equipo sobre la unidad.



# Getting started

Thank you for purchasing this Marantz product. To ensure proper operation, please read this user guide carefully before using the product. After reading them, be sure to keep them for future reference.

## Contents

<b>Getting started</b> .....	1
Accessories .....	2
About this manual .....	2
Features .....	2
Cautions on handling .....	3
<b>Simple version (Simple setup guide)</b> .....	
4	
<b>Basic version</b> .....	
13	
<b>Connections</b> .....	14
Important information .....	14
Connecting an HDMI-compatible device .....	15
Connecting a TV .....	17
Connecting a Blu-ray Disc player .....	17
Connecting a DVD player .....	18
Connecting a set-top box (Satellite tuner/cable TV) .....	18
Connecting a video cassette recorder .....	19
Connecting a digital camcorder .....	19
Connecting an iPod or USB memory device to the USB port .....	20
Connecting a CD player .....	20
Connecting a CD recorder .....	21
Connecting a record player .....	21
Connecting an antenna .....	22
Connecting a wireless receiver (RX101) .....	23
Connect a device that has a multichannel output terminal .....	23
Connecting to a home network (LAN) .....	24
<b>Playback (Basic operation)</b> .....	25
Important information .....	25
Playing a Blu-ray Disc player/DVD player .....	26
Playing a CD player .....	26
Playing an iPod® .....	27
Playing a USB memory device .....	28
Tuning in radio stations .....	30
Playing a network audio .....	34
<b>Selecting a listening mode (Surround mode)</b> .....	44
Multi-channel playback .....	44
Stereo playback .....	46
Direct playback .....	46
Dolby Virtual Speaker/Dolby Headphone playback .....	46

<b>Advanced version</b> .....	47
<b>Speaker installation/connection (Advanced connection)</b> .....	48
Install .....	48
Connect .....	49
Set up speakers .....	52
<b>Connections (Advanced connection)</b> .....	53
REMOTE CONTROL jacks .....	53
RS-232C connector .....	54
DC OUT (TRIGGER OUT) jacks .....	54
<b>Playback (Advanced operation)</b> .....	55
Convenient functions .....	55
<b>Playback in ZONE2/ZONE3 (Separate room)</b> .....	61
Audio output .....	61
Video output .....	62
Playback .....	62
<b>How to make detailed settings</b> .....	63
Menu map .....	63
Examples of menu and front display .....	64
Inputting characters .....	65
Input Setup .....	66
Audio/Video Adjust .....	72
Manual Setup .....	77
Information .....	88
<b>Other settings</b> .....	89
Remote control settings .....	89
Switches light illumination on/off .....	89
<b>Operating the connected devices by remote control unit</b> .....	90
Operating AV equipment .....	90
Registering preset codes .....	91
Operating components .....	92
Operating learn function .....	93
Operating macro function .....	95
Setting the back light .....	96

<b>Information</b> .....	97
<b>Part names and functions</b> .....	98
Front panel .....	98
Display .....	99
Rear panel .....	100
Remote control unit .....	101
<b>Other information</b> .....	103
Trademark information .....	103
Surround .....	104
Relationship between video signals and monitor output .....	108
Explanation of terms .....	109
<b>Troubleshooting</b> .....	112
Resetting the microprocessor .....	115
<b>Specifications</b> .....	116

<b>List of preset codes</b> .....	End of this manual
-----------------------------------	--------------------

## Accessories

Check that the following parts are supplied with the product.

① User guide .....	1
② Warranty card (for USA) .....	1
③ Warranty card (for CANADA) .....	1
④ Power cord .....	1
⑤ Remote control unit (RC011SR) .....	1
⑥ R03/AAA batteries .....	2
⑦ Setup microphone (ACM1H) .....	1
⑧ AM loop antenna (for HD Radio broadcasts) .....	1
⑨ FM indoor antenna (for HD Radio broadcasts) .....	1

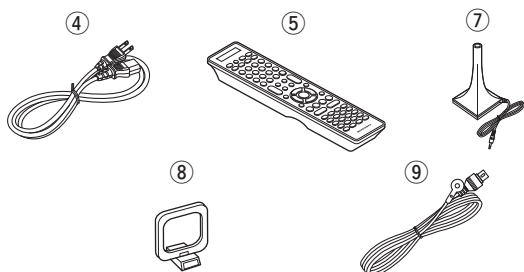

## About this manual

### ❑ Operation buttons

The operations described in this guide are based mainly on remote control operation.

### ❑ Symbols



This symbol indicates a reference page on which related information is described.



This symbol indicates a supplementary information and tips for operations.

### NOTE

This symbol indicates a supplementary information and tips for operations.

### ❑ Illustrations

Note that the illustrations in these instructions are for explanation purposes and may differ from the actual unit.

## Features

### Current feedback amplifier

This unit uses a high-speed current feedback amplifier circuit for its preamplifier so that signals from a Blu-ray Disc player and other equipment that support high-definition audio formats can be amplified with high fidelity. The high-speed current feedback amplifier also reproduces a natural sound space.

### Supports HDMI 1.4a with 3D, ARC, Deep Color, x.v.Color, Auto Lipsync and HDMI control function

This unit can output 3D video signals input from a Blu-ray Disc player to a TV that supports a 3D system. This unit also supports the ARC (Audio Return Channel) function, which reproduces TV sound with this unit via an HDMI cable used for connecting the unit and a TV\*1.

\* 1 The TV should support the ARC function.

### Internet radio, music and photo streaming via network\*2

This unit can playback audio files and still images such as photographs that are stored on your computer via a network. You can also listen to internet radio and a whole host of other online music\*3 that uses network technology.

\* 2 An internet connection is required.

\* 3 You may be required to sign a service agreement with the companies that provide particular services.

### 6-HDMI inputs and 2-outputs

The unit is equipped with 6 HDMI input connectors for connecting devices with HDMI connectors, such as a Blu-ray Disc player, game machine, HD video camera, etc. One of the 6 input connectors of this unit is provided on the front panel so that you can easily connect and display images and videos recorded in a digital still camera or digital video camera.

### High definition audio support

The unit is equipped with a decoder which supports high-quality digital audio format for Blu-ray Disc players such as Dolby TrueHD, DTS-HD Master Audio, etc.

### Audyssey DSX™

This unit is equipped with Audyssey DSX decoder. By connecting front height speakers to the power amp and using Audyssey DSX playback, you can experience a more power playback expression in the height audio range. By connecting front wide speakers, you can experience a more powerful playback expression in the wide audio range.

### Easy to use, Graphical User Interface

This unit is equipped with an easy to see "Graphical User Interface" that uses menu displays and levels. The use of level displays increases operability of the unit.

### All sources are up-scaled to 1080p

The unit is provided with an HDMI video up-scaling function that converts an analog video signal input to the unit to a 1080p (HD resolution) signal and supplies it to a TV via the HDMI connector. This enables the unit and a TV connected with a single HDMI cable and any video source to be reproduced precisely with HD level of quality.

### Direct play for iPod® and iPhone® via USB

Music data from an iPod can be played back if you connect the USB cable supplied with the iPod via the USB port of this unit, and also an iPod can be controlled with the remote control unit for this unit.

### M-XPort (Marantz-eXtension Port)

This unit is equipped with the M-XPort, a Marantz original innovation that provides outstanding expandability. You can connect the Wireless Receiver RX101 (sold separately) to this port.

### UNBALANCED PRE OUT terminal for front height channel

This unit is equipped with a dedicated UNBALANCED PRE OUT terminal on the rear panel. You can enjoy 7.1-channel playback using the front height channel and 7.1-channel playback using the surround back channel, without having to reconnect the speakers.

## Features

**Remote Power Control**

This unit is equipped with a remote power control function. When a Marantz Power Amplifier MM8003 or MM7055 or MM7025 is connected to this unit, this unit's power can be switched ON/OFF together with the MM8003 or MM7055 or MM7025 power supply. Connection to the MM8003 or MM7055 or MM7025 is a ground floating connection that prevents negative influences on sound quality as far as possible.

**Other features**

- Dolby Virtual Speaker (🔗 page 46)
- Dolby Headphone (🔗 page 46)
- DTS Neural Surround (🔗 page 45)

**Cautions on handling****• Before turning the power switch on**

Check once again that all connections are correct and that there are no problems with the connection cables.

- Power is supplied to some of the circuitry even when the unit is set to the standby mode. When going on vacation or leaving home for long periods of time, be sure to unplug the power cord from the power outlet.

**• About condensation**

If there is a major difference in temperature between the inside of the unit and the surroundings, condensation (dew) may form on the operating parts inside the unit, causing the unit not to operate properly.

If this happens, let the unit sit for an hour or two with the power turned off and wait until there is little difference in temperature before using the unit.

**• Cautions on using mobile phones**

Using a mobile phone near this unit may result in noise. If that occurs, move the mobile phone away from this unit when it is in use.

**• Moving the unit**

Turn off the power and unplug the power cord from the power outlet. Next, disconnect the connection cables to other system units before moving the unit.

**• About Care**

- Wipe the cabinet and control panel clean with a soft cloth.
- Follow the instructions when using a chemical cleaner.
- Benzene, paint thinner or other organic solvents as well as insecticide may cause material changes and discoloration if brought into contact with the unit, and should therefore not be used.

# Simple version (Simple setup guide)

Here, we explain the entire setup procedure, from unboxing the unit to using it in a home theater.

The "Simple version" section provides the speaker installation, connection, and setup methods for the 7.1-channel system with surround back speakers. For the installing, connecting, and setup methods of speakers other than the 7.1-channel system (with surround back speakers), see page 48.

- ❑ Before connecting the unit, turn off the power to all devices.
- ❑ For operation of the connected devices, refer to the user manuals for each device.

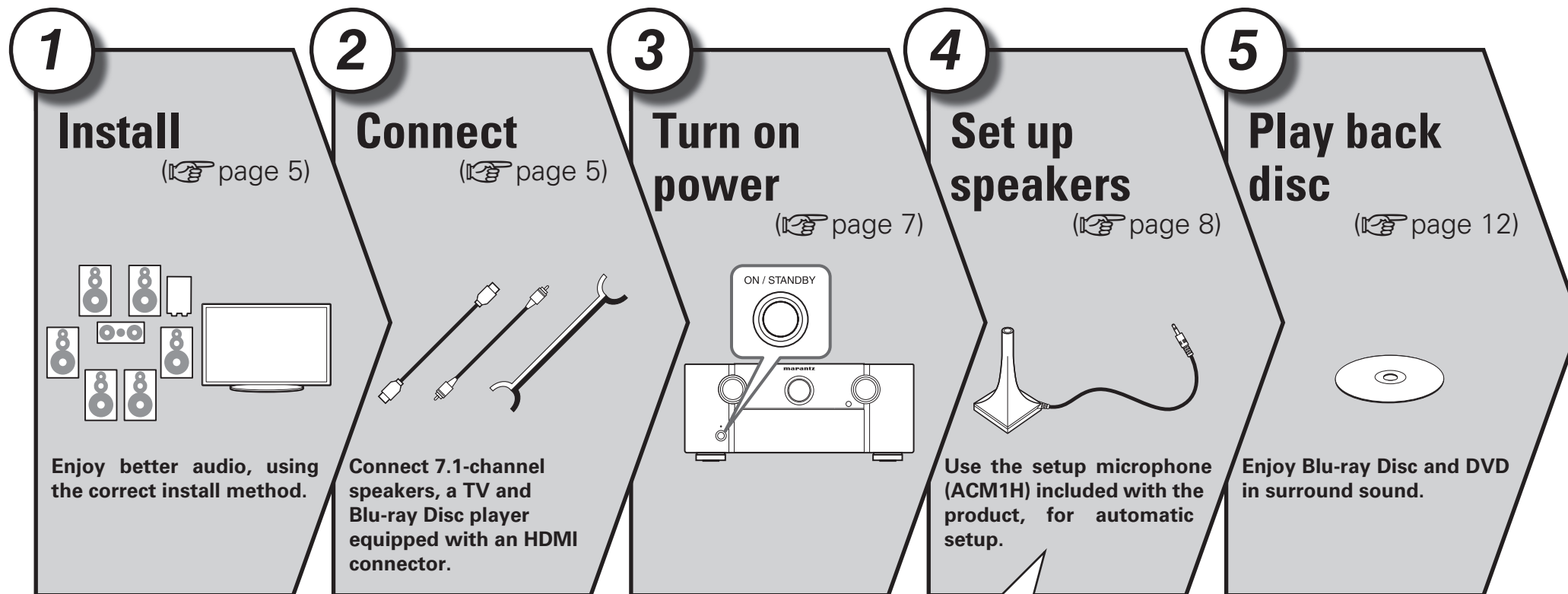

## Set up speakers (Audyssey® Auto Setup)

STEP 1  
Preparation

STEP 2  
Speaker  
Detection

STEP 3  
Measurement

STEP 4  
Calculation

STEP 5  
Check

STEP 6  
Store

Finish

# 1 Install



This unit can perform 2.0/2.1 to 7.1-channel surround playback. This page provides the speaker installation procedure for the 7.1-channel playback using surround back speakers as an example.

The default setting is 7.1-channel. You can also perform 5.1-channel playback. To perform 5.1-channel playback, connect 5.1-channel speakers only. Use Audyssey Auto Setup function of this unit to automatically detect the number of connected speakers and perform optimal settings for the speakers to be used.

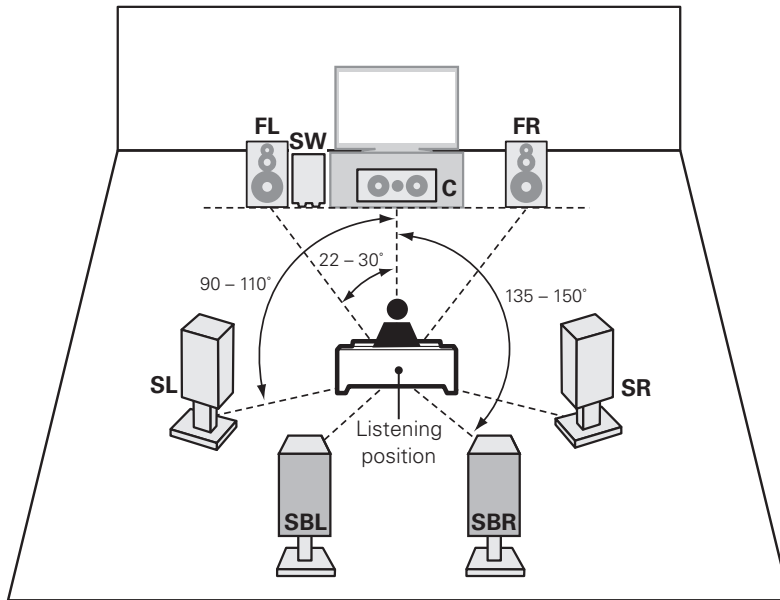

**FL** Front speaker (L)  
**FR** Front speaker (R)  
**C** Center speaker  
**SW** Subwoofer  
**SL** Surround speaker (L)  
**SR** Surround speaker (R)  
**SBL** Surround back speaker (L)  
**SBR** Surround back speaker (R)

- Install the surround speakers in a position 2 to 3 ft (60 to 90 cm) higher than ear level.

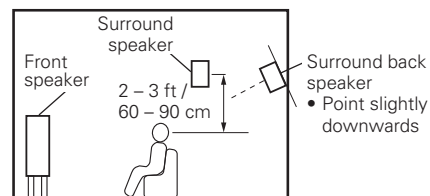

[Viewed from the side]

# 2 Connect



## Power amp

- Connect a power amp (sold separately) to the PRE OUT terminal of this unit.
- This unit has an UNBALANCED PRE OUT terminal and BALANCED PRE OUT terminal. Connect to the correct terminal for your power amp.
- Connect the speakers to the power amp.
- For details on speaker connections, see the User Guide for the power amp.

The "Simple version" section provides the speaker installation, connection, and setup methods for the 7.1-channel system with surround back speakers. For the installing, connecting, and setup methods of speakers other than the 7.1-channel system (with surround back speakers), see page 48.

Connect

Example of connections to Marantz MM7055 and MM7025 power amp

Connecting the unbalanced PRE OUT terminal

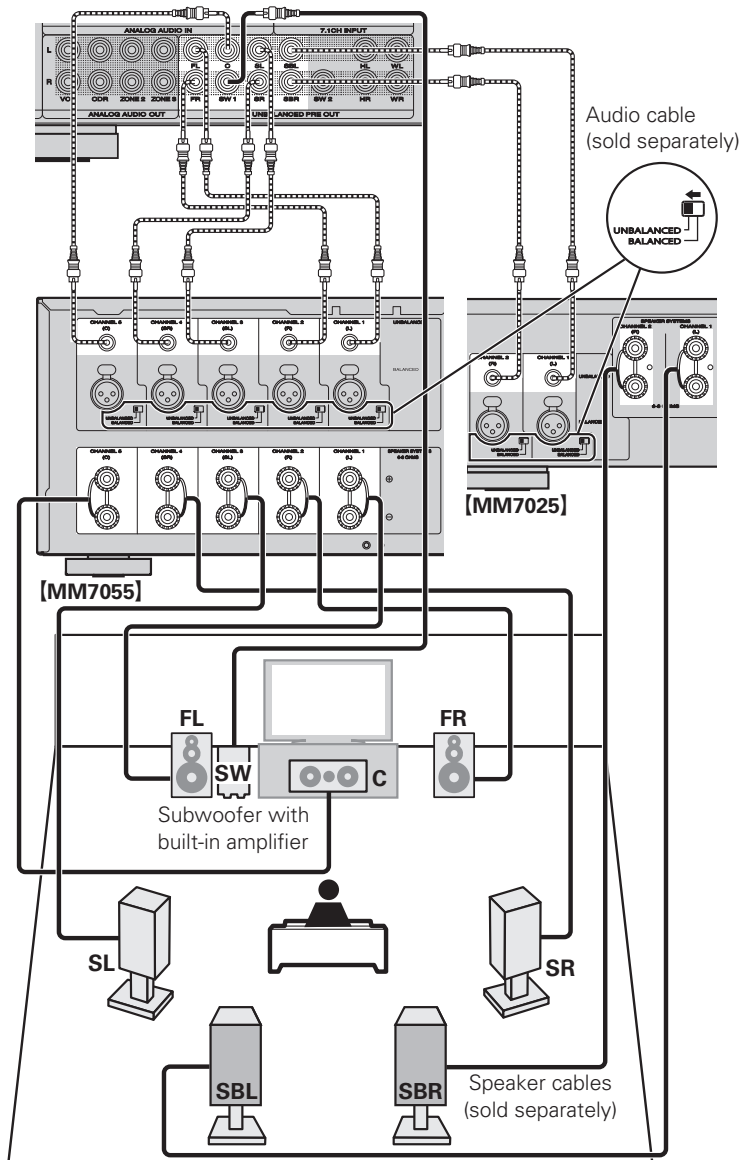

Connecting the balanced PRE OUT terminal

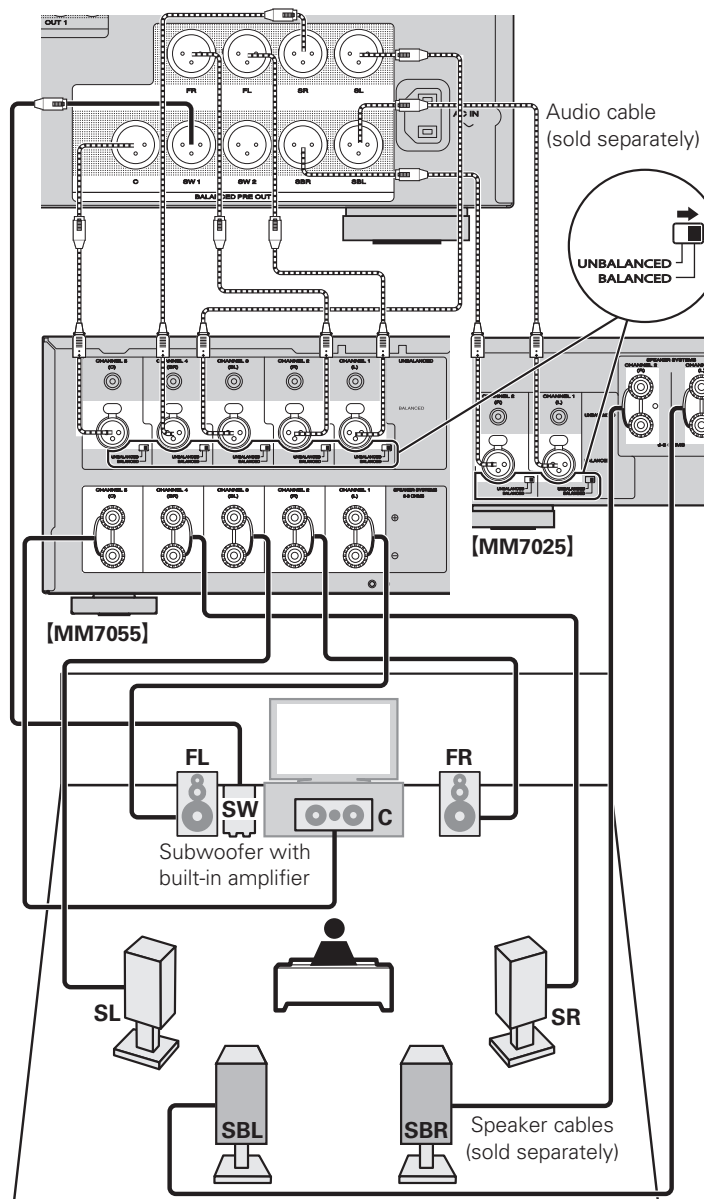

[AV7005 XLR connector PIN arrangement]



- ① GND (Ground)
- ② HOT (Hot)
- ③ COLD (Cold)

The PIN arrangement in this device uses the European method. In the USA method, ② is COLD, and ③ is HOT.

When connecting a device that utilizes the USA type of PIN arrangement, replace the ② and ③ plugs on one side of the balanced cable.

NOTE

Do not short the HOT and GND or COLD and GND for use.

The "Simple version" section provides the speaker installation, connection, and setup methods for the 7.1-channel system with surround back speakers. For the installing, connecting, and setup methods of speakers other than the 7.1-channel system (with surround back speakers), see page 48.

**Blu-ray Disc player and TV**

Use only an HDMI (High Definition Multimedia Interface) cable that bears the HDMI logo (a genuine HDMI product). Using a cable without the HDMI logo (a non-genuine HDMI product) may result in abnormal playback.

When outputting Deep Color or 1080p, etc., we recommend you use a “High Speed HDMI cable” or a “High Speed HDMI cable with Ethernet” for enhanced high-quality playback.

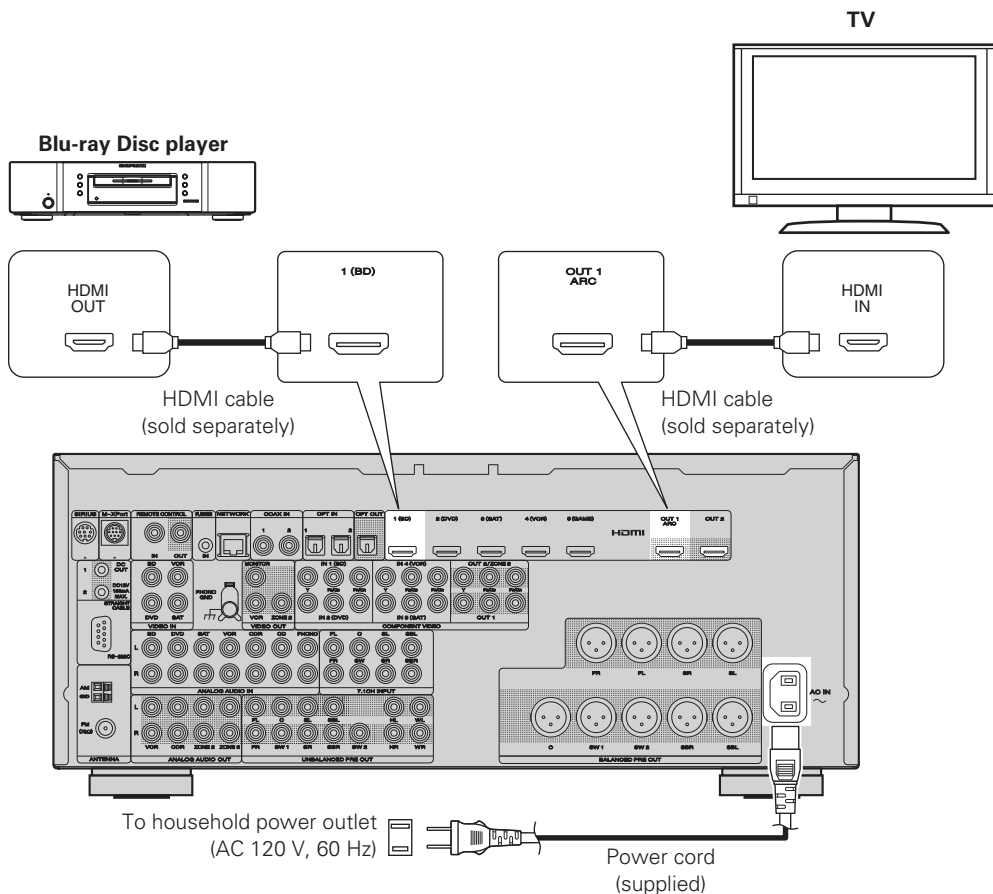

**NOTE**

- Do not plug in the power cord until all connections have been completed.
- Do not bundle power cords together with connection cables. Doing so can result in humming or noise.

**3 Turn on power**



**1 Turn on the TV and subwoofer power.**

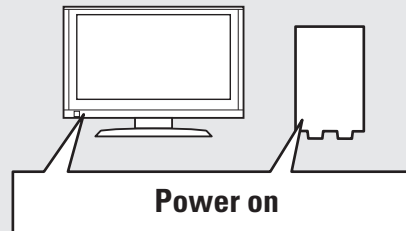

**2 Change the TV input to the input of this unit.**

**3 Press ON to turn on power to the unit.**  
The power indicator switches off, and power is supplied to the unit.

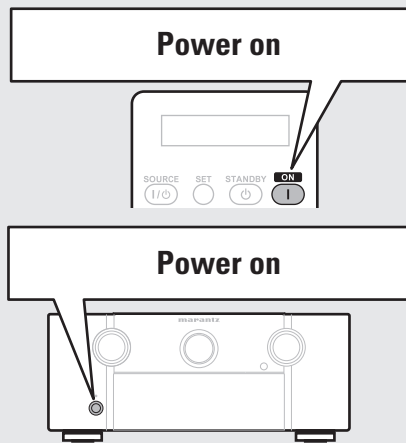

**4 Turn on the power amp power.**

**NOTE**

Before you use the remote control unit for the first time, be sure to insert the batteries (see page 102 “Inserting the batteries”).



# 4 Set up speakers (Audyssey® Auto Setup)



The acoustic characteristics of the connected speakers and listening room are measured and the optimum settings are made automatically. This is called “Audyssey Auto Setup”. To perform measurement, place the setup microphone in multiple locations all around the listening area. For best results, we recommend you measure in six or more positions, as shown in the illustration (up to eight positions).

- When performing Audyssey Auto Setup, MultEQ® XT/Dynamic EQ®/Dynamic Volume® functions become active (☞ page 74, 75).
- To set up the speakers manually, use “Speaker Setup” (☞ page 78) on the menu.

## NOTE

- Make the room as quiet as possible. Background noise can disrupt the room measurements. Close windows, silence cell phones, televisions, radios, air conditioners, fluorescent lights, home appliances, light dimmers, or other devices as measurements may be affected by these sounds.
- Cell phones should be placed away from all audio electronics during the measurement process as Radio Frequency Interference (RFI) may cause measurement disruptions (even if the cell phone is not in use).
- Do not unplug the setup microphone from the main unit until Audyssey Auto Setup is completed.
- Do not stand between the speakers and setup microphone or allow obstacles in the path while the measurements are being made. This will cause inaccurate readings.
- Loud test sounds may be played during Audyssey Auto setup. This is part of normal operation. If there is background noise in room, these test signals will increase in volume.
- Operating **VOLUME +, -** during the measurements will cancel the measurements.
- Measurement cannot be performed when headphones are connected.



## About setup microphone placement

- Measurements are performed by placing the setup microphone successively at multiple positions throughout the entire listening area, as shown in [Example ①]. For best results, we recommend you measure in six or more positions, as shown in the illustration (up to eight positions).
- Even if the listening environment is small as shown in [Example ②], measuring at multiple points throughout the listening environment results in more effective correction.

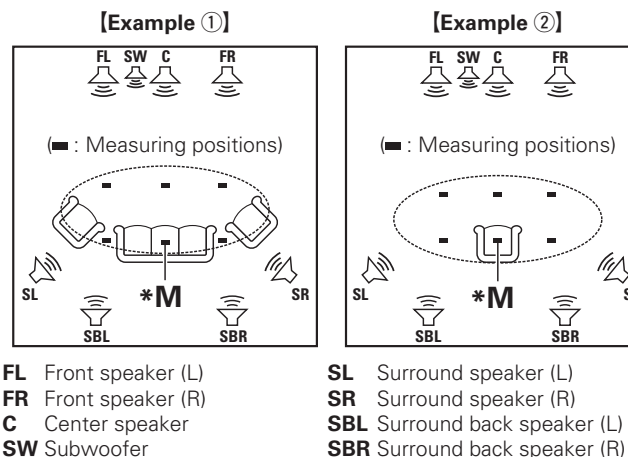

## About the main listening position (\*M)

The main listening position is the position where listeners would normally sit or where one would normally sit alone within the listening environment. Before starting Audyssey Auto Setup, place the setup microphone in the main listening position. Audyssey MultEQ® XT uses the measurements from this position to calculate speaker distance, level, polarity, and the optimum crossover value for the subwoofer.

## 1

### Prepare the setup microphone

**Mount the setup microphone on a tripod or stand and place it in the main listening position.**

When placing the setup microphone, adjust the height of the sound receptor to the level of the listener's ear.

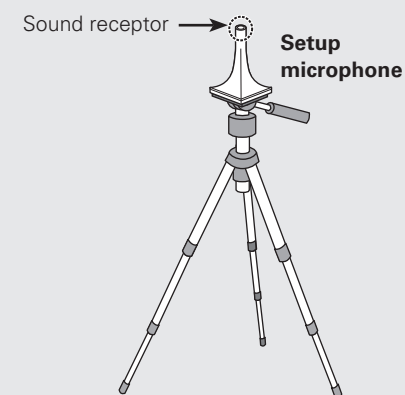

## NOTE

- Do not hold the setup microphone in your hand during measurements.
- Avoid placing the setup microphone close to a seat back or wall as sound reflections may give inaccurate results.



## 2 Set up the subwoofer

If using a subwoofer capable of the following adjustments, set up the subwoofer as shown below.

### ❑ When using a subwoofer with a direct mode

Set the direct mode to "On" and disable the volume adjustment and crossover frequency setting.

### ❑ When using a subwoofer without a direct mode

Make the following settings:

- **Volume** : "12 o'clock position"
- **Crossover frequency** : "Maximum/Highest Frequency"
- **Low pass filter** : "Off"
- **Standby mode** : "Off"

### NOTE

When you use two subwoofers, please adjust the subwoofer volume controls individually so that each subwoofer level is as close as possible to 75 dB using the test tone (page 79) before Audyssey Auto Setup.

## 3 Set up the remote control unit

❑ **Set up the operation mode**  
Press **AMP** to set the remote control unit to amplifier operation mode.



Press AMP

## STEP 1 Preparation

### 4 Connect the setup microphone to the SETUP MIC jack of this unit.

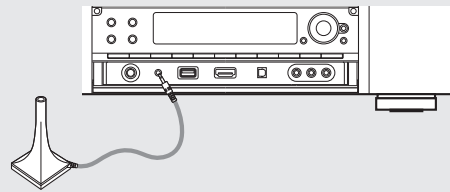

When the setup microphone is connected, the following screen is displayed.

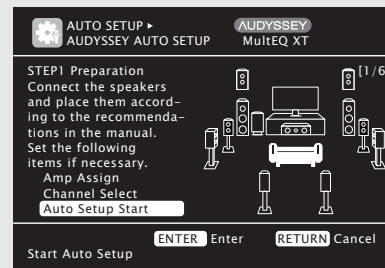

This screen provides the method for setting up 7.1-channel playback using surround back speakers. For the method of setting up speakers other than the 7.1-channel system, select "Amp Assign" and perform step 3 and 4 of "Set up "Amp Assign"" (page 52).

If unused channels are set with "Channel Select", measuring time can be shortened. For setting, perform steps 5 to 9 of "Set up "Channel Select"" (page 52).

### 5 Use $\Delta$ / $\nabla$ to select "Auto Setup Start" and then press ENTER.

## STEP 2 Speaker Detection

- In STEP 2, you will perform measurements at the main listening position.
- This step automatically checks the speaker configuration and speaker size, and calculates the channel level, distance, and crossover frequency. It also corrects distortion in the listening area.

### 6 Select "Measure" and then press ENTER.

When measuring begins, a test tone is output from each speaker.

- Measurement requires several minutes.

### 7 The detected speakers are displayed.

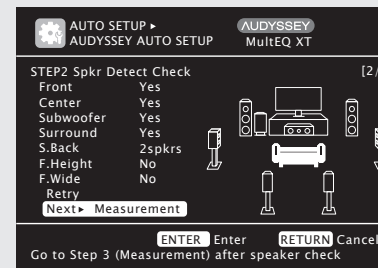

### NOTE

If a connected speaker is not displayed, the speaker may not be connected correctly. Check the speaker connection.

### 8 Use $\Delta$ / $\nabla$ to select "Next" and then press ENTER.

### NOTE

If "Caution" is displayed:

Go to "Error messages" (page 11), check any related items, and perform the necessary procedures.

If the problem is resolved, return and restart "Audyssey Auto Setup".

### When performing Audyssey Auto Setup over again

Press  $\Delta$ / $\nabla$  to select "Retry", and then press ENTER.

### When measuring has stopped

Press RETURN, to the "Cancel Auto Setup?" prompt is displayed.

Press  $\triangleleft$  to select "Yes", then press ENTER.

### Setting up the speakers again

Repeat the operation from step 4 of

**STEP1 Preparation**.

Remote control operation buttons



Move the cursor (Up/Down/Left/Right)



Confirm the setting

RETURN



Return to previous menu

## Set up speakers (Audyssey® Auto Setup)

### STEP 3 Measurement

- In STEP 3, you will perform measurements at multiple positions (two to eight positions) other than the main listening position.
- You can achieve a more effective correction of distortion within the listening area by performing measurements at multiple positions.

#### 9 Move the setup microphone to position 2, use $\Delta$ / $\nabla$ to select “Measure”, and then press ENTER.

The measurement of the second position starts. Measurements can be made in up to eight positions.

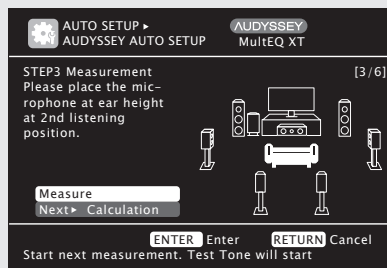

If you want to omit measurements from the next position onward, select “Next  $\blacktriangleright$  Calculation”.  
(Go to **STEP4 Calculation**)

#### 10 Repeat step 9, measuring positions 3 to 8.

When measurement of position 8 is completed, a “Measurements finished.” message is displayed.

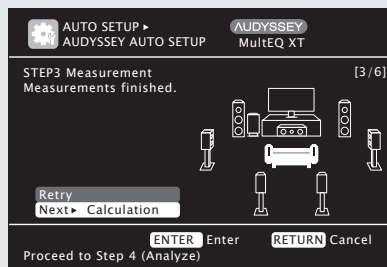

### STEP 4 Calculation

#### 11 On the **STEP3** screen, use $\Delta$ / $\nabla$ to select “Next $\blacktriangleright$ Calculation”, and then press ENTER.

Measuring results are analyzed, and the frequency response of each speaker in the listening room is determined.

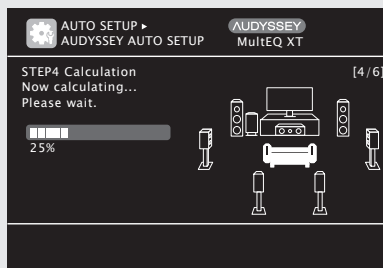

- Analysis takes several minutes to complete. The time required for this analysis depends on the number of speakers connected. The more connected speakers there are, the longer it takes to perform analysis.

### STEP 5 Check

#### 12 Use $\Delta$ / $\nabla$ to select the item you want to check, and then press ENTER.

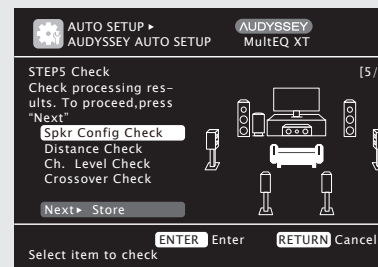

- Subwoofers may measure a greater reported distance than the actual distance due to added electrical delay common in subwoofers.
- If you want to check another item, press **RETURN**.

#### 13 Use $\Delta$ / $\nabla$ to select “Next $\blacktriangleright$ Store” and then press ENTER.

#### NOTE

- If the result differs from the actual connection status, or if “Caution!” is displayed, see “Error messages” (page 11). Then carry out Audyssey Auto Setup again.
- If the result still differs from the actual connection status after remeasurement or the error message still appears, it is possible that the speakers are not connected properly. Turn this unit off, check the speaker connections and repeat the measurement process from the beginning.
- If you change speaker positions or orientation, perform Audyssey Auto Setup again to find the optimal equalizer settings.

### STEP 6 Store

#### 14 Select “Store” and then press ENTER. Save the measurement results.

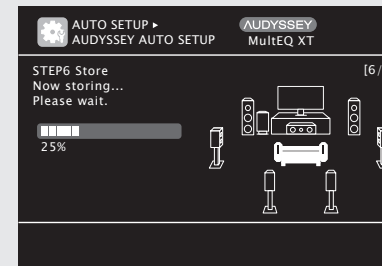
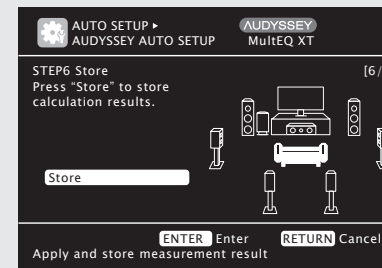

- Saving the results requires about 10 seconds.
- If the measuring results are not to be saved, press **RETURN**. A message “Cancel Auto Setup?” will be displayed. Press  $\triangleleft$  then select “Yes”. All the measured Audyssey Auto Setup data will be erased.

#### NOTE

During saving of measurement results, be sure not to turn off the power.



Set up speakers (Audyssey® Auto Setup)

Finish

**15** Unplug the setup microphone from the unit's SETUP MIC jack.

**16** Set Dynamic Volume®.

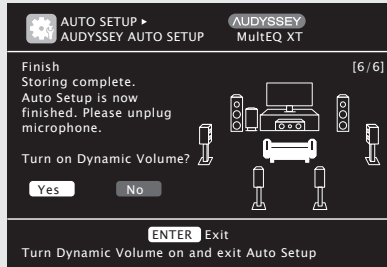

• For details of Dynamic Volume settings, see page 75.

- When turning Dynamic Volume on**  
Use ◀ to select "Yes", and then press **ENTER**.
  - The unit automatically enters "Heavy" mode.
- When turning Dynamic Volume off**  
Use ▶ to select "No", and then press **ENTER**.

**NOTE**

After performing Audyssey Auto Setup, do not change the speaker connections or subwoofer volume. In event of a change, perform Audyssey Auto Setup again.

# Error messages

An error message is displayed if Audyssey® Auto Setup could not be completed due to speaker placement, the measurement environment, etc. If this happens, check the relevant items, be sure to take the necessary measures, then perform Audyssey Auto Setup over again.

**NOTE**

Be sure to turn off the power before checking speaker connections.

Examples	Error details	Measures
<p>The screenshot shows a 'Caution!' message: 'No microphone or Speaker'. It includes a 'Retry' button and a 'RETURN Cancel' button at the bottom.</p>	<ul style="list-style-type: none"> <li>• The connected setup microphone is broken, or a device other than the supplied setup microphone is connected.</li> <li>• Not all speakers could be detected.</li> <li>• The front L speaker was not properly detected.</li> </ul>	<ul style="list-style-type: none"> <li>• Connect the included setup microphone to the SETUP MIC jack of this unit.</li> <li>• Check the speaker connections.</li> </ul>
<p>The screenshot shows a 'Caution!' message: 'Ambient noise is too high or Level is too low'. It includes a 'Retry' button and a 'RETURN Cancel' button at the bottom.</p>	<ul style="list-style-type: none"> <li>• There is too much noise in the room for accurate measurements to be made.</li> <li>• Speaker or subwoofer sound is too low for accurate measurements to be made.</li> </ul>	<ul style="list-style-type: none"> <li>• Either turn off any device generating noise or move it away.</li> <li>• Perform again when the surroundings are quieter.</li> <li>• Check the speaker installation and the direction in which the speakers are facing.</li> <li>• Adjust the subwoofer's volume.</li> </ul>
<p>The screenshot shows a 'Caution!' message: 'Front R None'. It includes a 'Retry' button and a 'RETURN Cancel' button at the bottom.</p>	<ul style="list-style-type: none"> <li>• The displayed speaker could not be detected.</li> </ul>	<ul style="list-style-type: none"> <li>• Check the connections of the displayed speaker.</li> </ul>
<p>The screenshot shows a 'Caution!' message: 'Front L Phase'. It includes 'Retry' and 'Skip' buttons, and a 'RETURN Cancel' button at the bottom.</p>	<ul style="list-style-type: none"> <li>• The displayed is connected with the polarities reversed.</li> </ul>	<ul style="list-style-type: none"> <li>• Check the polarities of the displayed speaker.</li> <li>• For some speakers, this error message may be displayed even if the speaker is properly connected. If you are sure the connection is correct, press <b>Δ</b> <b>▽</b> to select "Skip", then press <b>ENTER</b>.</li> </ul>

# Parameter Check

This function enables you to check the measurement results and equalizer characteristics after Audyssey Auto Setup.

**1** Use  $\Delta$ / $\nabla$  to select “Parameter Check” and then press **ENTER** or  $\triangleright$ .

**2** Use  $\Delta$ / $\nabla$  to select the item you want to check, then press **ENTER** or  $\triangleright$ .

Measurement results for each speaker are displayed.

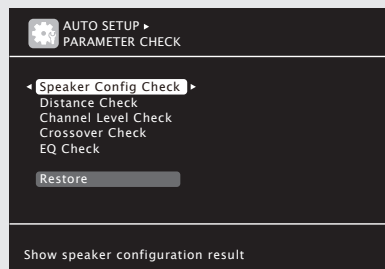

**Speaker Config. Check** Check the speaker configuration.

**Distance Check** Check the distance.

**Channel Level Check** Check the channel level.

**Crossover Check** Check the crossover frequency.

**EQ Check** Check the equalizer.

- If “EQ Check” is selected in step 2, press  $\Delta$ / $\nabla$  to select equalizing curve (“Audyssey” or “Audyssey Flat”) to be checked. Use  $\triangleleft$ / $\triangleright$  to switch the display between the different speakers.

**3** Press **RETURN**.  
The confirmation screen reappears. Repeat steps 2.

## Retrieving Audyssey Auto Setup settings

If you set “Restore” to “Yes”, you can return to Audyssey Auto Setup measurement result (value calculated at the start by MultEQ® XT) even when you have changed each setting manually.

# 5 Play back disc



**1** Press **BD** two times in a row to switch an input source for a player used for playback.

**2** Play the component connected to this unit.

Make the necessary settings on the player (language setting, subtitles setting, etc.) beforehand.

**3** Adjust the sound volume.

**VOLUME +** ..... Volume up

**VOLUME -** ..... Volume down

**MUTE** ..... Muting



**4** Set the listening mode.

Set the listening mode according to the playback contents (cinema, music, etc.) or according to your liking (refer page 44 “Selecting a listening mode (Surround mode)”).

## When power is switched to standby

Press **STANDBY**.

**[Power indicator status in standby mode]**

- Normal standby : Red
- When “HDMI Control” is set to “ON” : Orange
- When “Network Standby” is set to “ON” : Orange

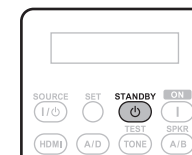

You can also switch the power to standby by pressing **ON/STANDBY** on the main unit.

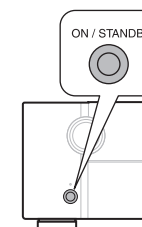



## NOTE

During power standby, a minimal amount of power is consumed. To totally cut off the power, remove the power cord from the power outlet.



























## Basic version

Here, we explain the connections and basic operation methods for this unit.

- **Connections**  page 14
- **Playback (Basic operation)**  page 25
- **Selecting a listening mode (Surround mode)**  page 44

Refer to the pages indicated below for information on connecting and playing back the various media and external devices.

Audio and Video	Connection	Playback
TV	 page 16, 17	-
Blu-ray Disc player	 page 16, 17	 page 26
DVD player	 page 16, 18	 page 26
Video cassette recorder	 page 16, 19	-
Set-top box (Satellite tuner or cable TV)	 page 16, 18	-
Game console	 page 16	-
Digital camcorder	 page 19	-
Audio	Connection	Playback
iPod®	 page 20	 page 27
USB memory device	 page 20	 page 28
CD player	 page 20	 page 26
CD recorder	 page 21	-
Record player	 page 21	-
SIRIUS satellite radio	 page 22	 page 30
HD Radio receiver	 page 22	 page 32
Wireless receiver (RX101)	 page 23	-
Network	Connection	Playback
Network	 page 24	 page 34

For speaker connections, see page 5.

# Connections

## Important information

- Make connections as follows before using this unit. Select an appropriate connection type according to the components to be connected.
- You may need to make some settings on this unit depending on the connection method. Refer to each description for more information.
- Select the cables (sold separately) according to the components being connected.

### NOTE

- Do not plug in the power cord until all connections have been completed.
- When making connections, also refer to the operating instructions of the other components being connected.
- Be sure to connect the left and right channels properly (left with left, right with right).
- Do not bundle power cords together with connection cables. Doing so can result in noise.

## Converting input video signals for output (Video conversion function)

This unit is equipped with three types of video input connectors (HDMI, Component video and video) and three types of video output connectors (HDMI, Component video and video).

Use the connectors corresponding to the components to be connected.

This function automatically converts various formats of video signals input to this unit into the formats used to output the video signals from this unit to a monitor.

### [Flow of video signals for MAIN ZONE]

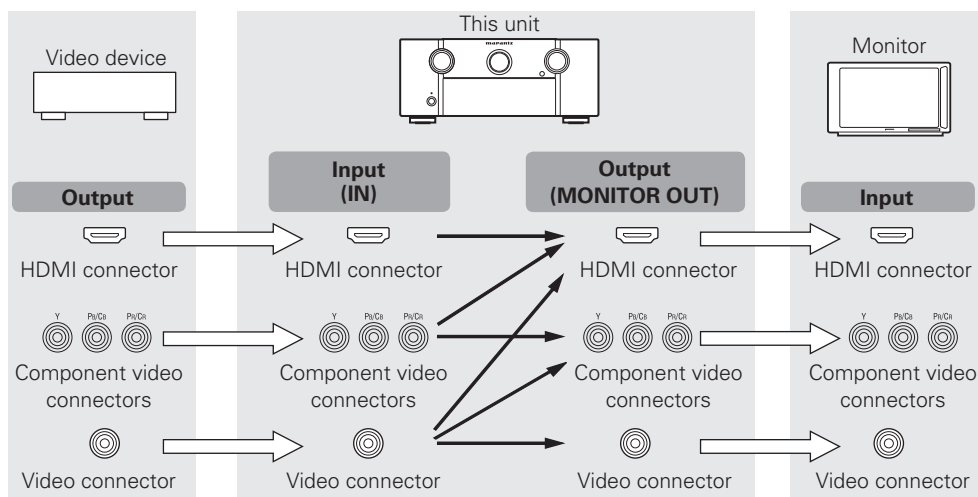

### [Flow of video signals for ZONE2]

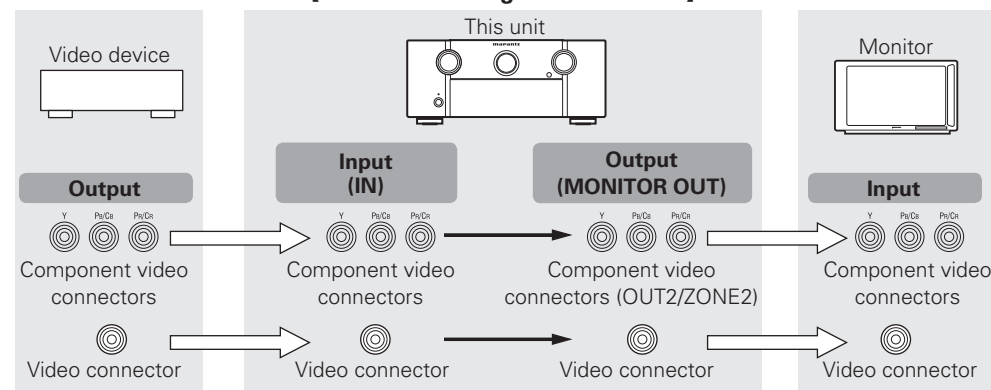

### in Set as Necessary

- Set when not using the video conversion function.
- **"Video Convert"** (☞ page 70)
- Set when changing the resolution of the video signal.
- **"Resolution"** (☞ page 70)



- The video conversion function supports the NTSC, PAL, SECAM, NTSC 4.43, PAL-N, PAL-M and PAL-60 formats.
- The resolution of the video signal input to this unit's HDMI connector is the one set at "Resolution" (☞ page 70). (1080p HDMI signals and 1080p component signals are output at 1080p, regardless of the setting.)
- Resolutions of HDMI-compatible TVs can be checked at "HDMI Monitor 1 Information" or "HDMI Monitor 2 Information" (☞ page 88).

### NOTE

- HDMI signals cannot be converted into analog signals.
- When a non-standard video signal from a game machine or some other source is input, the video conversion function might not operate.
- Component video input signals cannot be converted into Video format.
- A menu is output via the HDMI connector or component video connector.
- When using component output terminal 2 for ZONE2 video signal output, set "Input Setup" – "Input Assign" – "Component" (☞ page 69) in the menu to "ZONE2".

## Important information

## Examples of screen display

- Menu screen

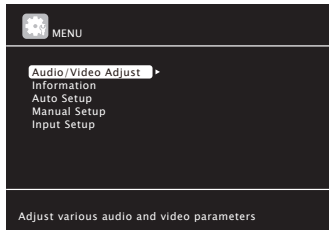

- Status display screen  
When the input source is switched



- When the volume is adjusted

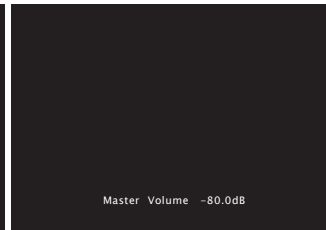

Status display: The operating status appears briefly on the screen when the input source is switched or the volume is changed.

## NOTE

- If you operate the menu while playing back 3D video content, the playback video is replaced by the menu screen. The playback video is not displayed behind the menu screen.
- This unit does not show the status display while playing back 3D video content.

## Connecting an HDMI-compatible device

You can connect up to six HDMI-compatible devices to the unit.

## HDMI function

This unit supports the following HDMI functions:

- 3D
- Deep Color (🔧 page 109)
- Auto Lip Sync (🔧 page 80, 109)
- x.v.Color, sYCC601 color, Adobe RGB color, Adobe YCC601 color (🔧 page 109, 111)
- High definition digital audio format
- ARC (Audio Return Channel)
- Content Type
- CEC (HDMI control)

## Copyright protection system

In order to play back digital video and audio such as BD-Video or DVD-Video via HDMI connection, both this unit and TV or the player need to support the copyright protection system known as HDCP (High-bandwidth Digital Content Protection System). HDCP is copyright protection technology comprised of data encryption and authentication of the connected AV device. This unit supports HDCP.

- If a device that does not support HDCP is connected, video and audio are not output correctly. Read the user guide of your television or player for more information.

## About HDMI cables

- When a device supporting Deep Color signal transfer is connected, use a cable compatible “High Speed HDMI cable” or “High Speed HDMI cable with Ethernet”.
- When the ARC function is used, connect a device with a “Standard HDMI cable with Ethernet” or “High Speed HDMI cable with Ethernet” for HDMI 1.4a.

## HDMI control function (🔧 page 55)

This function allows you to operate external devices from this unit and operate this unit from external devices.

## NOTE

- The HDMI control function may not work depending on the device it is connected to and its settings.
- You cannot operate a TV or Blu-ray Disc player/DVD player that is not compatible with the HDMI control function.

## About 3D function

This unit supports input and output of 3D (3 dimensional) video signals of the HDMI 1.4a standards. For playing the 3D video content, a player, and a TV that support the 3D function of the HDMI 1.4a standards are required in addition to this unit.

## NOTE

- If you operate the menu while playing back 3D video content, the playback video is replaced by the menu screen. The playback video is not displayed behind the menu screen.
- This unit does not show the status display while playing back 3D video content.

## About ARC (Audio Return Channel) function

The Audio Return Channel in HDMI 1.4a enables a TV, via a single HDMI cable, to send audio data “upstream” to this unit.

## NOTE

- To enable the ARC function, set “HDMI Control” to “ON” (🔧 page 80).
- ARC function is only supported for the HDMI OUT 1 connector. In order to use the ARC function, connect the television to the HDMI OUT 1 connector.
- When connecting a TV that does not support the ARC function, a separate connection using an audio cable is required. In this case, refer to “Connecting a TV” (🔧 page 17) for the connection method.

## About Content Type

The HDMI specification version 1.4a enables simple, automated picture setting selection with no user intervention.

## NOTE

To enable the Content Type, set “Video Mode” to “Auto” (🔧 page 70).



Connecting an HDMI-compatible device

Cables used for connections

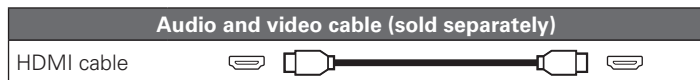

- This interface allows transfer of digital video signals and digital audio signals over a single HDMI cable.

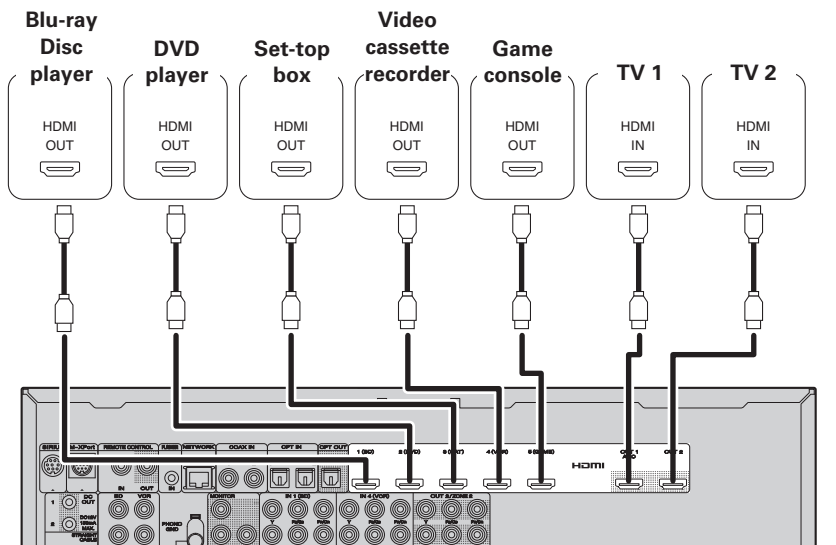

[Rear panel]

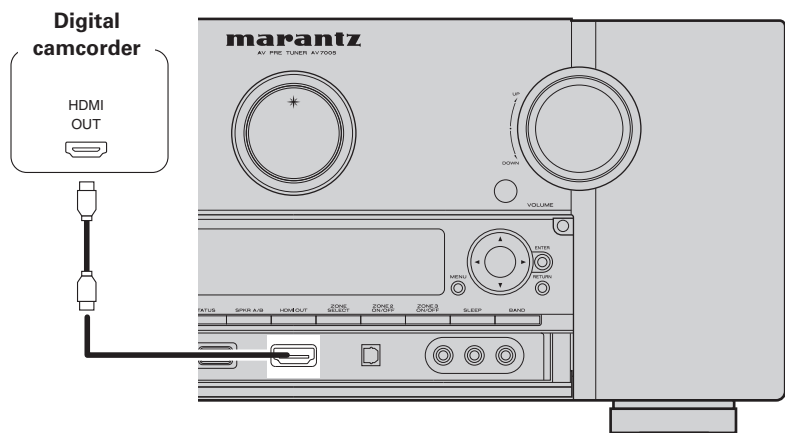

[Front panel]



- When this unit is connected to other devices with HDMI cables, connect this unit and TV also with an HDMI cable.
- When connecting a device that supports Deep Color transmission, please use a “High Speed HDMI cable” or “High Speed HDMI cable with Ethernet”.
- Video signals are not output if the input video signals do not match the monitor’s resolution. In this case, switch the Blu-ray Disc/DVD player’s resolution to a resolution with which the monitor is compatible.
- When this unit and monitor are connected with an HDMI cable, if the monitor is not compatible with HDMI audio signal playback, only the video signals are output to the monitor.

NOTE

- The HDMI signal is not simultaneously output to HDMI 1 and HDMI 2. Select the connector that you want to use in advance using “Monitor Out” (page 80) in the menu, or by pressing the **HDMI** button on the remote control unit or the **HDMI OUT** button on the main unit.
- HDMI control function is only supported for the HDMI OUT 1 connector. In order to use the HDMI control function, connect the television to the HDMI OUT 1 connector.
- The audio signal from the HDMI output connector (sampling frequency, number of channels, etc.) may be limited by the HDMI audio specifications of the connected device regarding permissible inputs.
- The front panel HDMI input connector is displayed as “HDMI6” in the “Input Setup” – “Input Assign” (page 68) in the menu.

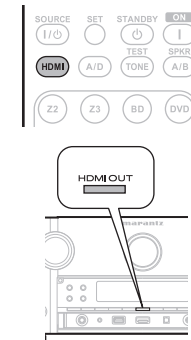

Connecting to a device equipped with a DVI-D connector

When an HDMI/DVI conversion cable (sold separately) is used, the HDMI video signals are converted to DVI signals, allowing connection to a device equipped with a DVI-D connector.

NOTE

- No sound is output when connected to a device equipped with a DVI-D connector. Make separate audio connections.
- Signals cannot be output to DVI-D devices that do not support HDCP.
- Depending on the combination of devices, the video signals may not be output.

Settings related to HDMI connections

Set as necessary. For details, see the respective reference pages.

Input Assign (page 68)

Set this to change the HDMI input connector to which the input source is assigned.

HDMI Setup (page 80)

Make settings for HDMI video/audio output.

- RGB Range
- Auto Lip Sync
- HDMI Audio Out
- Monitor Out
- HDMI Control
- Standby Source
- Power Off Control

NOTE

The audio signals output from the HDMI connectors are only the HDMI input signals.



## Connecting a TV

- Select the connector to use and connect the device.
- For video connections, see “Converting input video signals for output (Video conversion function)” (page 14).
- For instructions on HDMI connections, see “Connecting an HDMI-compatible device” (page 15).



To listen to TV audio through this device, use the optical digital connection.

### NOTE

This connection is not required when a TV compatible with the ARC function (Audio Return Channel (HDMI 1.4a standard function) is connected to this unit via an HDMI connection.

For details, see “About ARC (Audio Return Channel) function” (page 15) or refer to the instruction manual for your TV.

## Cables used for connections

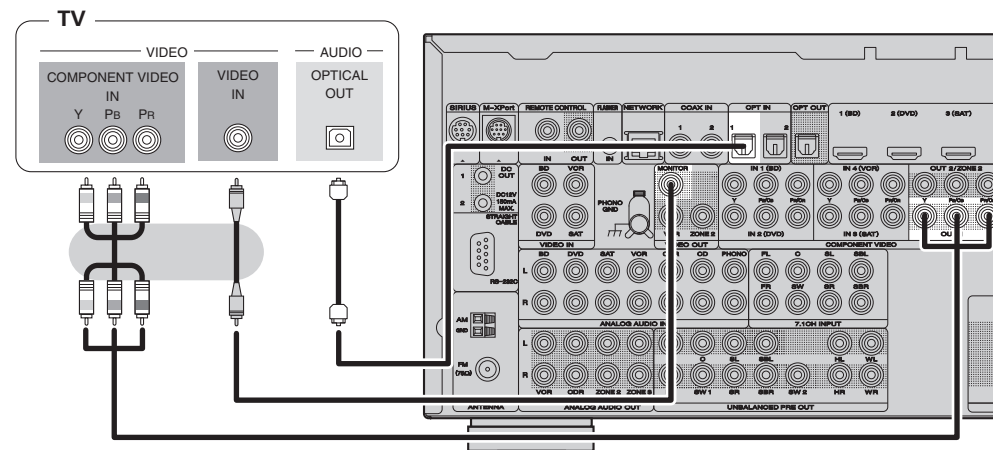
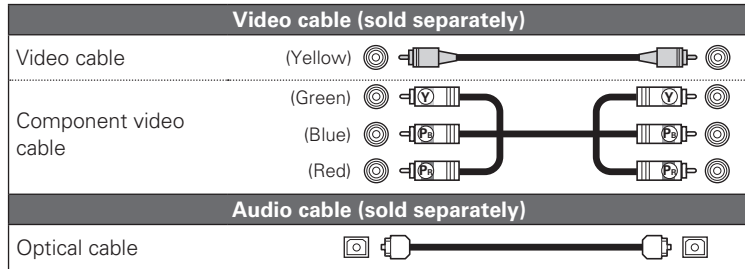

### in Set as Necessary

Set this to change the digital input connector to which the input source is assigned.  
**“Input Assign”** (page 68)

## Connecting a Blu-ray Disc player

- You can enjoy video and audio from a Blu-ray Disc.
- Select the connector to use and connect the device.
- For instructions on HDMI connections, see “Connecting an HDMI-compatible device” (page 15).

## Cables used for connections

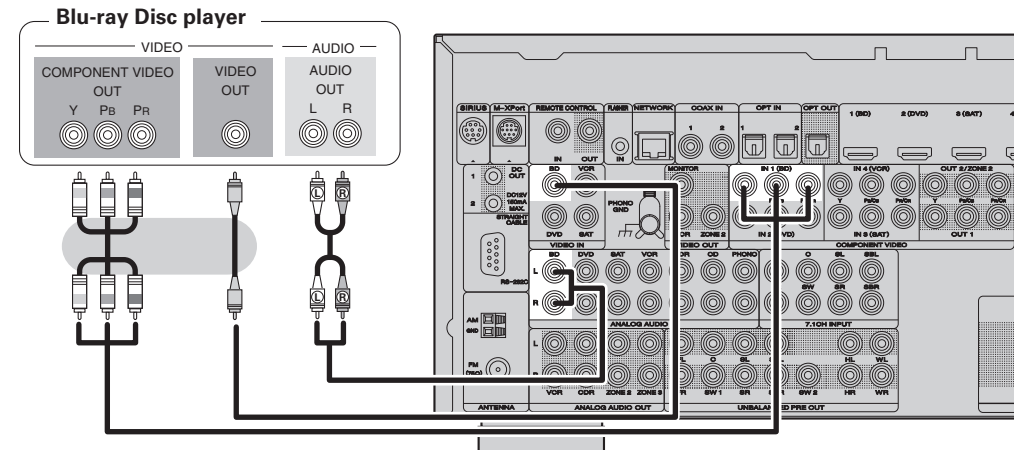
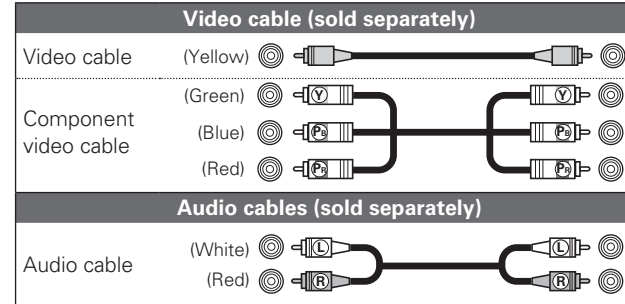

### in Set as Necessary

Set this to change the digital input connector or component video input connector to which the input source is assigned.

**“Input Assign”** (page 68)



For HD audio (Dolby TrueHD, DTS-HD, Dolby Digital Plus and DTS Express) playback, connect with HDMI (page 15 “Connecting an HDMI-compatible device”).

## Connecting a DVD player

- You can enjoy video and audio from a DVD.
- Select the connector to use and connect the device.
- For instructions on HDMI connections, see “Connecting an HDMI-compatible device” (📖 page 15).

### Cables used for connections

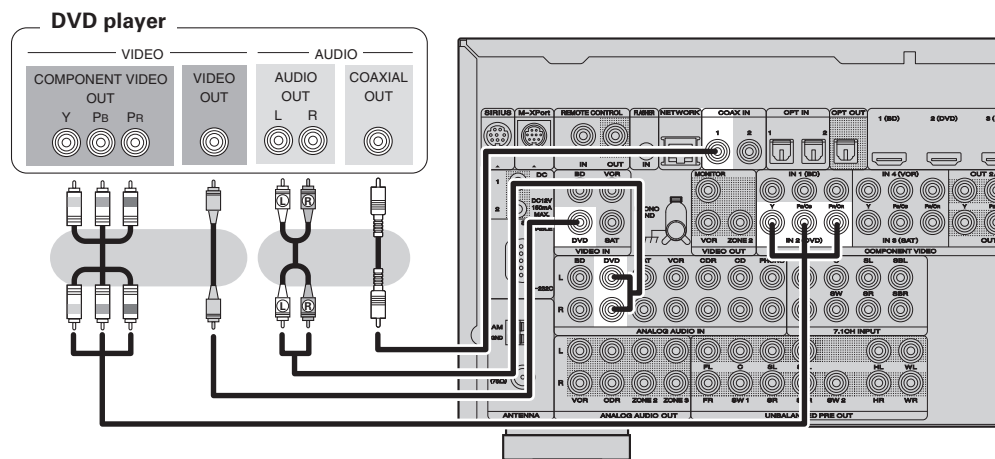
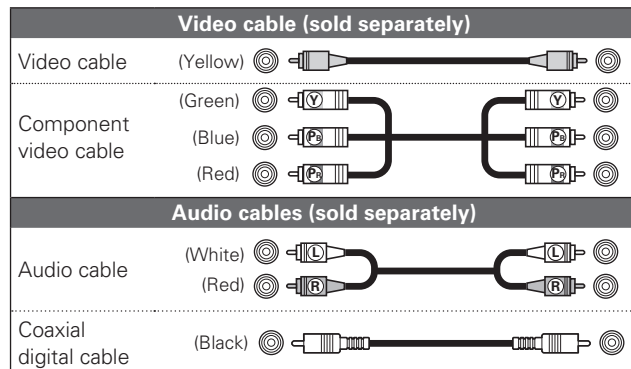

#### in Set as Necessary

Set this to change the digital input connector or component video input connector to which the input source is assigned.

“Input Assign” (📖 page 68)

## Connecting a set-top box (Satellite tuner/cable TV)

- You can watch satellite or cable TV.
- Select the connector to use and connect the device.
- For instructions on HDMI connections, see “Connecting an HDMI-compatible device” (📖 page 15).

### Cables used for connections

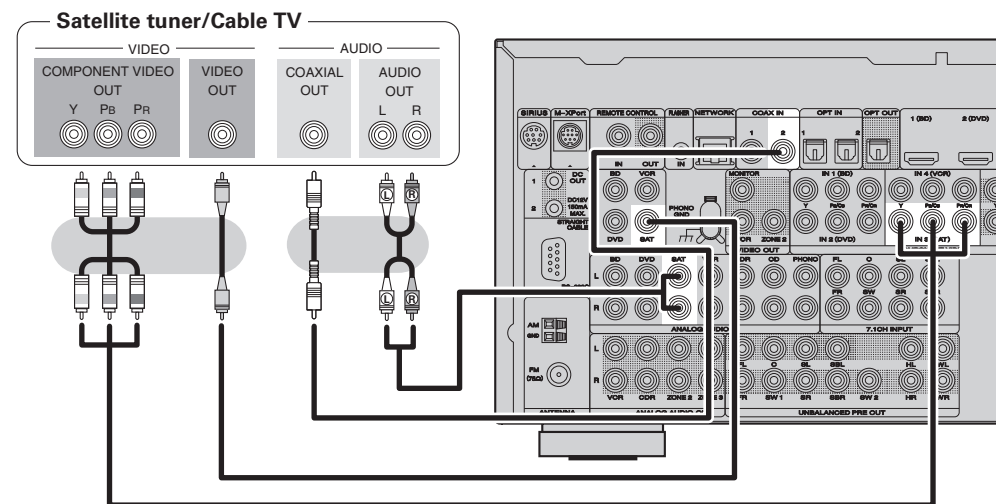
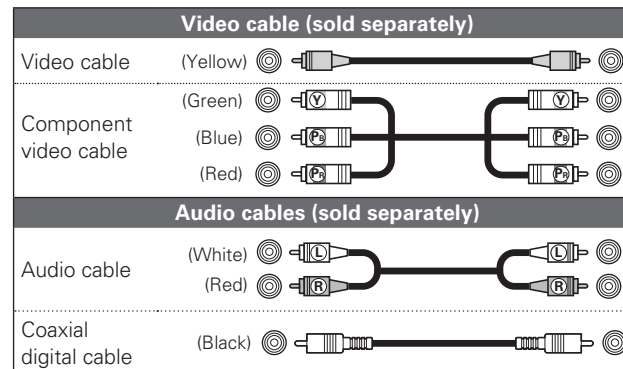

#### in Set as Necessary

Set this to change the digital input connector or component video input connector to which the input source is assigned.

“Input Assign” (📖 page 68)

## Connecting a video cassette recorder

- You can record video onto a video cassette tape.
- Select the connector to use and connect the device.
- When recording analog audio, use the analog connection.
- For instructions on HDMI connections, see “Connecting an HDMI-compatible device” (📖 page 15).

### Cables used for connections

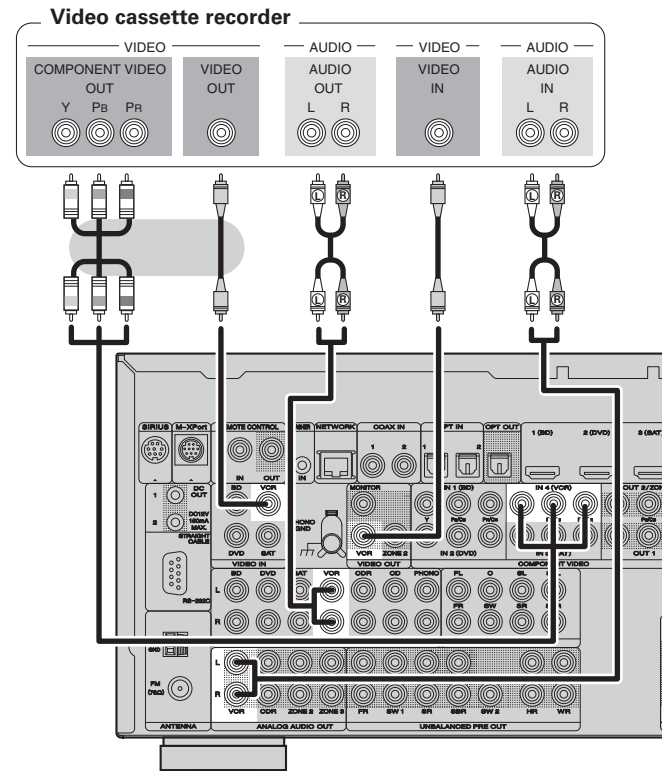
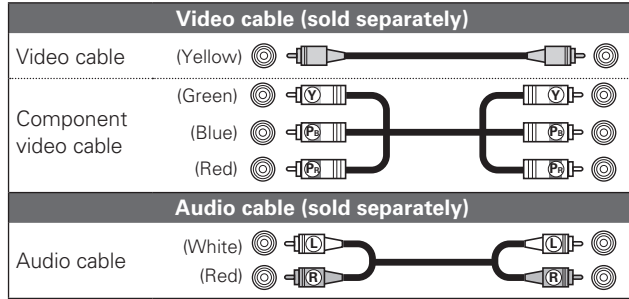

### in Set as Necessary

Set this to change the digital input connector or component video input connector to which the input source is assigned.  
**“Input Assign”** (📖 page 68)

### NOTE

To record video signals through this unit, use the same type of video cable for connection between this unit and the player as used for connection between this unit and the recorder.

## Connecting a digital camcorder

- You can enjoy video and audio from a digital camcorder.
- You can enjoy games by connecting a game machine via the AUX1 input connector. In this case, select the input source to “AUX1”.
- For instructions on HDMI connections, see “Connecting an HDMI-compatible device” (📖 page 15).

### Cables used for connections

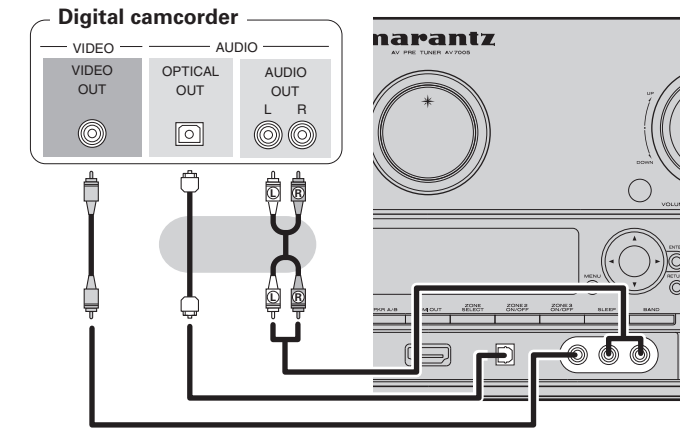
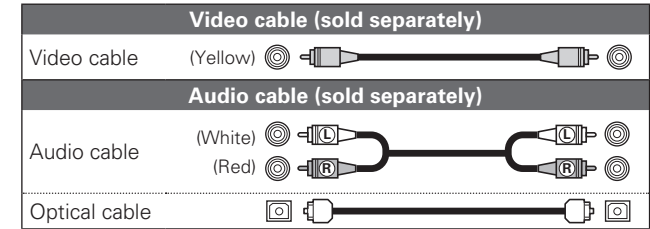

### in Set as Necessary

Set this to change the digital input connector to which the input source is assigned.  
**“Input Assign”** (📖 page 68)



The front panel OPTICAL input terminal is displayed as “OPT3” in the “Input Setup” – “Input Assign” setting (📖 page 68) in the menu.

### NOTE

When a non-standard video signal from a game machine or some other source is input, the video conversion function might not operate. In this case, use the monitor output of the same connector as the input.

## Connecting an iPod or USB memory device to the USB port

You can enjoy music stored on an iPod or USB memory device.

### Cables used for connections

To connect an iPod to this unit, use the USB cable supplied with the iPod.

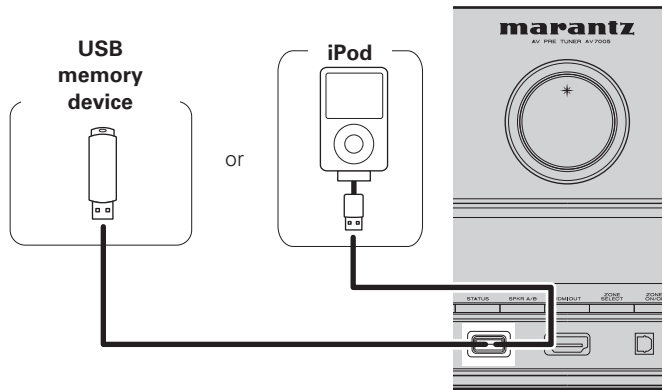

Marantz does not guarantee that all USB memory devices will operate or receive power. When using a portable USB connection type HDD of the kind to which an AC adapter can be connected to supply power, use the AC adapter.

### NOTE

- USB memory devices will not work via a USB hub.
- Do not use an extension cable when connecting a USB memory device. This may cause radio interference with other devices.

### Supported iPod models

Made for

- iPod touch (2nd generation)
- iPod touch (1st generation)
- iPod classic
- iPod with video
- iPod nano (5th generation)
- iPod nano (4th generation)
- iPod nano (3rd generation)
- iPod nano (2nd generation)
- iPod nano (1st generation)
- iPhone
- iPhone 3G
- iPhone 3GS

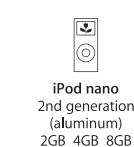
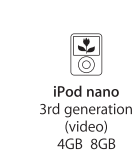

## Connecting a CD player

- You can enjoy CD sound.
- Select the connector to use and connect the device.

### Cables used for connections

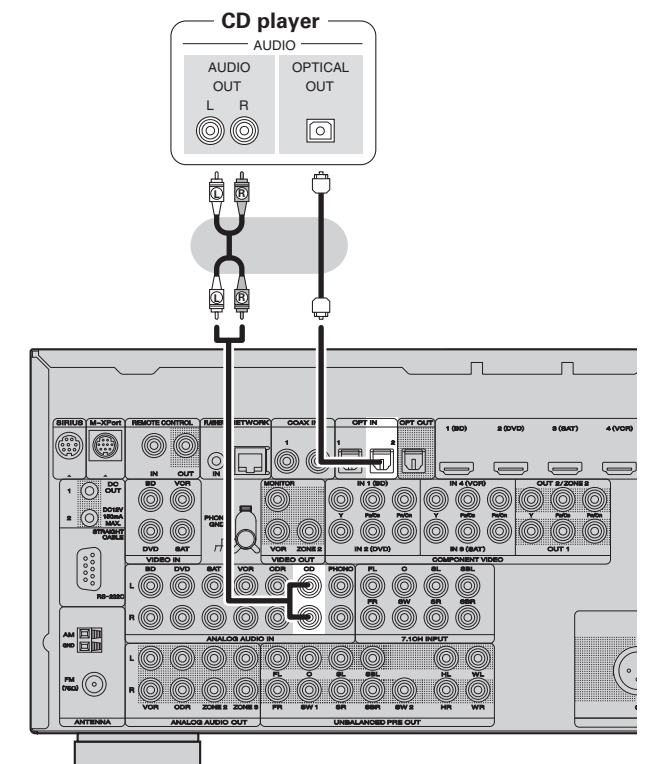
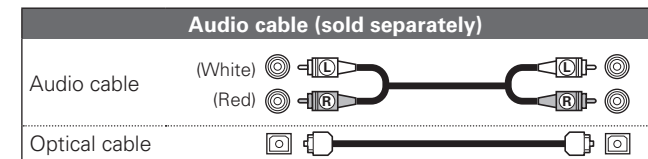

### in Set as Necessary

Set this to change the digital input connector to which the input source is assigned.  
**"Input Assign"** (🔧 page 68)

## Connecting a CD recorder

- You can record audio on a CD or cassette tape.
- Select the connector to use and connect the device.
- When recording analog audio, use the analog connection.

### Cables used for connections

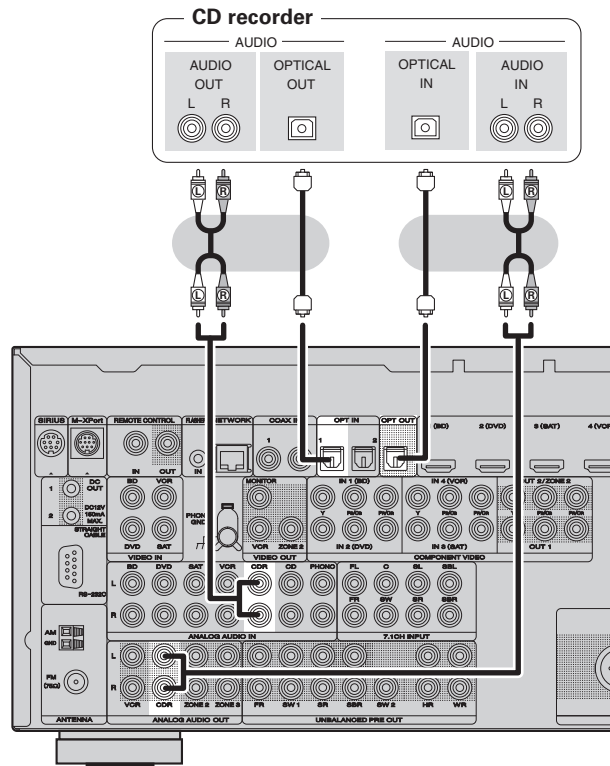
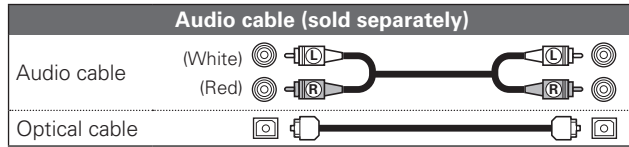

#### in Set as Necessary

Set this to change the digital input connector to which the input source is assigned.  
**"Input Assign"** (☞ page 68)



To perform digital recording using the digital connector (OPT OUT), assign either one of the digital input connectors to "CDR" by selecting "Input Setup" – "Input Assign" setting (☞ page 68).  
 The above figure shows an example of changing the assignment of OPT1 connector to "CDR".

## Connecting a record player

You can enjoy playing records.

### Cables used for connections

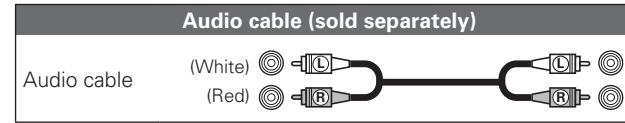

#### Turntable (MM cartridge)

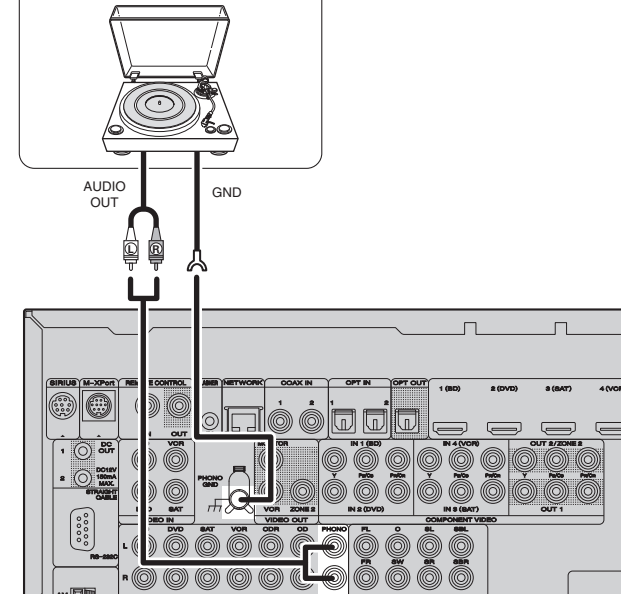

- This unit is compatible with record players with an MM cartridge. When you connect to a record player with an MC cartridge, use a commercially available MC head amp or a step-up transformer.
- When you increase the volume without connecting the record player, there may be "booming" noise from the speakers.

#### NOTE

The SIGNAL GND terminal of this unit is not a safety ground connection. Connect it to reduce noise when noise is excessive. Note that depending on the record player, connecting the ground line may have the reverse effect of increasing noise. In this case, it is not necessary to connect the ground line.



# Connecting an antenna

## Connecting a SIRIUS connector

- This unit is a SIRIUS Satellite Radio Ready® receiver. You can receive SIRIUS® Satellite Radio by connecting to the SiriusConnect Home Tuner and subscribing to the SIRIUS service.
  - Plug the SIRIUS connector on the SIRIUS service.
  - Position the Home Tuner antenna near a south-facing window to receive the best signal.
- For details, see “Listening to SIRIUS satellite radio” (page 30). When making connections, also refer to the operating instructions of the SiriusConnect Home Tuner.

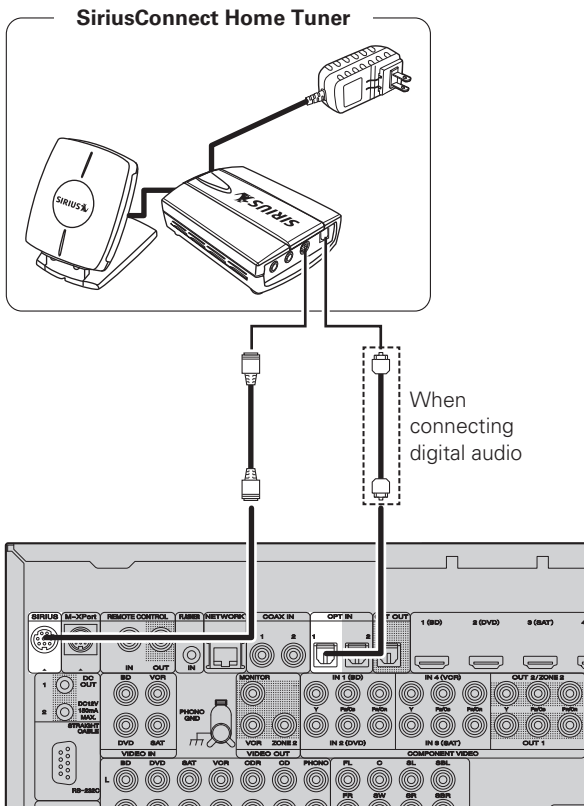

**in Set as Necessary**

When connecting digital of the SiriusConnect Home Tuner, perform the setting “Digital”. “Input Assign” (page 68)

**NOTE**

Keep the power cord unplugged until the SiriusConnect Home Tuner connection have been completed.

**Positioning the antenna**

For a consistent satellite signal, the antenna must be positioned correctly. Use the following map to determine which area you are in and position the antenna accordingly.

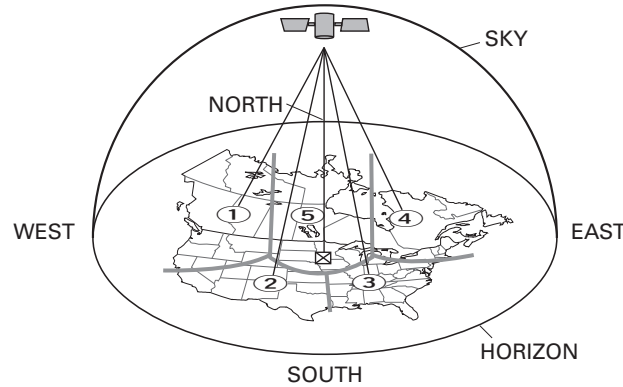

- Area 1** Point the antenna toward the sky in the **east, northeast, or southeast**, either through a window or outside.
- Area 2** Point the antenna toward the sky in the **north or northeast**, either through a window or outside.
- Area 3** Point the antenna toward the sky in the **north or northwest**, either through a window or outside.
- Area 4** Point the antenna toward the sky in the **west, northwest, or southwest**, either through a window or outside.
- Area 5** Put the antenna outside and point it **straight up**. The antenna cannot be used indoors.

## Connecting an HD Radio receiver

- By connecting a HD Radio antenna to this unit, you can receive HD Radio programs.
- HD Radio broadcasting currently is available in the United States and select other countries.

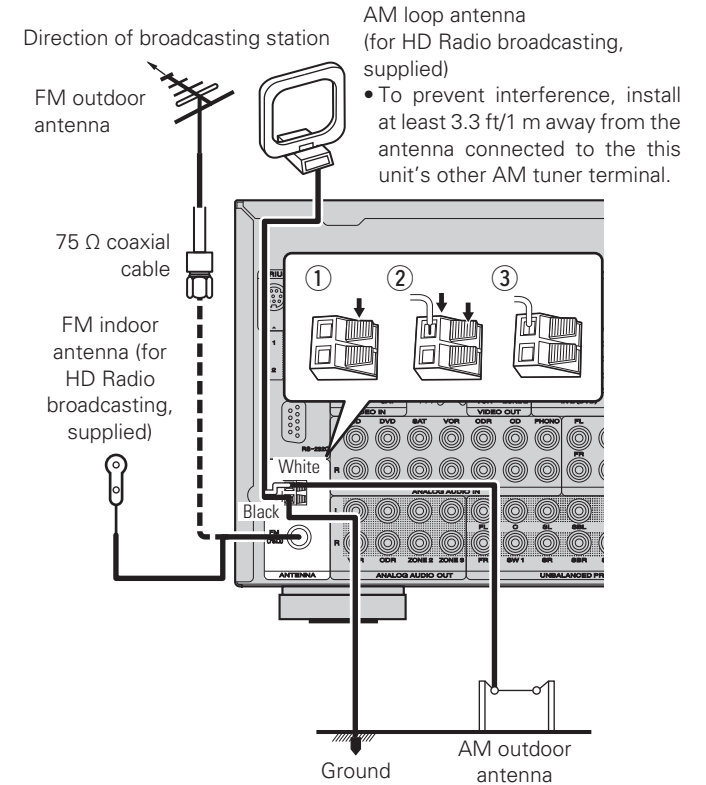

Connecting an antenna

AM loop antenna assembly

**1** Put the stand section through the bottom of the loop antenna from the rear and bend it forward.

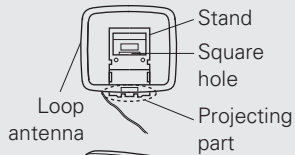

**2** Insert the projecting part into the square hole in the stand.

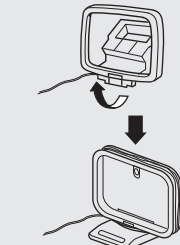

Using the AM loop antenna  
Suspending on a wall

Suspend directly on a wall without assembling.

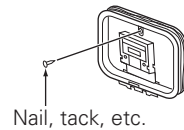

Standing alone

Use the procedure shown above to assemble.

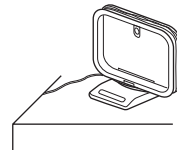

NOTE

- Do not connect two FM antennas simultaneously.
- Even if an external AM antenna is used, do not disconnect the AM loop antenna.
- Make sure the AM loop antenna lead terminals do not touch metal parts of the panel.
- If the signal has noise interference, connect the ground terminal (GND) to reduce noise.
- If you are unable to receive a good broadcast signal, we recommend installing an outdoor antenna. For details, inquire at the retail store where you purchased the unit.

Connecting a wireless receiver (RX101)

By connecting a wireless receiver RX101 (sold separately) to this unit, you can receive and playback audio signals from other devices using the Bluetooth Communication Function.

- Use a Bluetooth device that is A2DP compatible (☞ page 109 "A2DP").
- You can also use wireless receiver RX101 as an external IR receiver.
- For instructions on the wireless receiver settings, refer to the RX101's operating instructions.

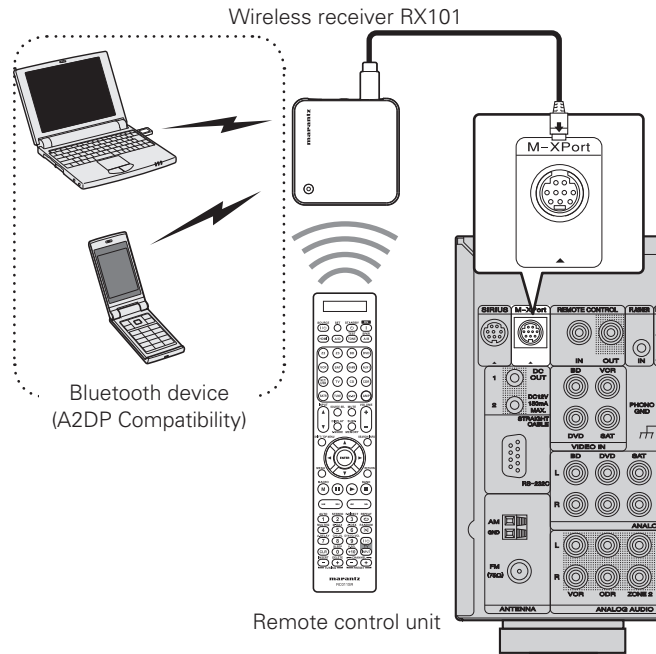

You can enjoy listening to music by connecting a wireless receiver via the M-XPort input connector. In this case, set the input source to "M-XPort".

NOTE

To use wireless receiver RX101 as external IR receiver, set the remote sensor function of this unit to "Remote Lock:ON" (☞ page 89 "Remote control settings").

Connect a device that has a multichannel output terminal

- You can connect this unit to an external device fitted with multichannel sound audio output jacks to enjoy music and video.
- The video signal can be connected in the same way as a Blu-ray Disc player / DVD player (☞ page 17 "Connecting a Blu-ray Disc player").

Cables used for connections

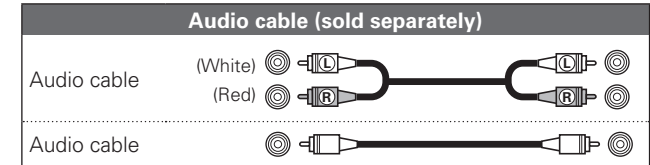

Blu-ray Disc player / DVD player / External decoder

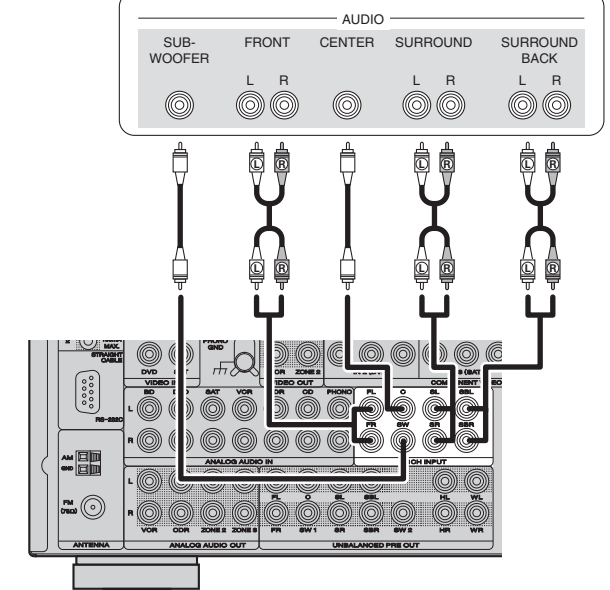

in Set as Necessary

To play analog signals input from 7.1CH INPUT terminals, set "Input Mode" (☞ page 71) to "7.1CH IN". "7.1CH IN" can also be selected with **A/D** on the remote control unit.



When a device is connected to the SBL/SBR terminal of 7.1CH INPUT terminals, set "Amp Assign" (☞ page 78) to "Normal".

## Connecting to a home network (LAN)

- This unit lets you play via your home network (LAN) music files stored on a computer and music content such as that from Internet radio.
- You can also operate this unit from a computer using the Web control function.
- You can update by downloading the latest firmware from the Marantz website.
- For more information, on the menu, select "Firmware Update" (☞ page 86).
- See "Network Setup" on the menu (☞ page 81) for more information on network setting.

### Cables used for connections

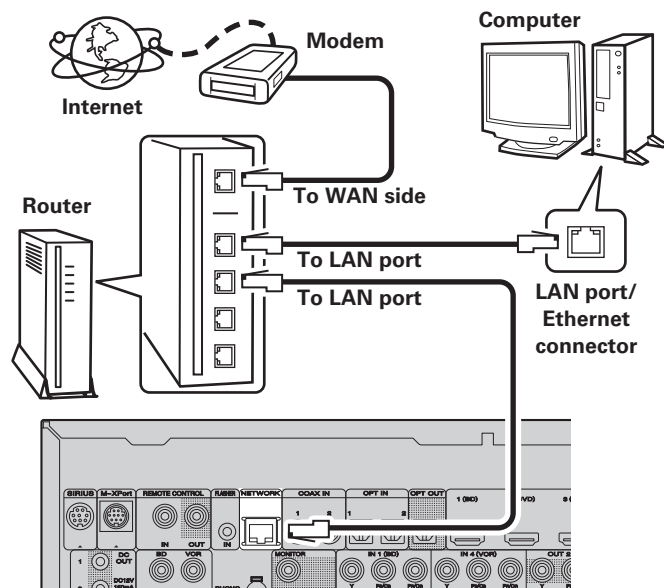
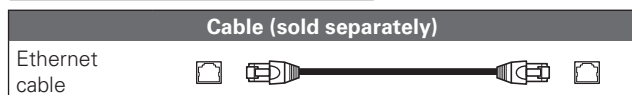

For connections to the Internet, contact an ISP (Internet Service Provider) or a computer shop.

## Required system

### ❑ Broadband internet connection

#### ❑ Modem

Device that connects to the broadband circuit and conducts communications on the Internet.

A type that is integrated with a router is also available.

#### ❑ Router

When using this unit, we recommend you use a router equipped with the following functions:

- Built-in DHCP server  
This function automatically assigns IP addresses on the LAN.
- Built-in 100BASE-TX switch

When connecting multiple devices, we recommend a switching hub with a speed of 100 Mbps or greater.

### ❑ Ethernet cable (CAT-5 or greater recommended)

- Use only shielded STP or ScTP LAN cable which is available at retailer.
- Some flat type Ethernet cables are easily affected by noise.  
We recommend using a normal type cable.



- If you have an Internet provider contract for a line on which network settings are made manually, make the settings at "Network Setup" (☞ page 81).
- With this unit, it is possible to use the DHCP and Auto IP functions to make the network settings automatically.
- When using this unit with the broadband router's DHCP function enabled, this unit automatically performs the IP address setting and other settings.  
When using this unit connected to a network with no DHCP function, make the settings for the IP address, etc., at "Network Setup" (☞ page 81).
- When setting manually, check the setting contents with the network administrator.

## NOTE

- A contract with an ISP is required to connect to the Internet.  
No additional contract is needed if you already have a broadband connection to the Internet.
- The types of routers that can be used depend on the ISP. Contact an ISP or a computer shop for details.
- Marantz assumes no responsibility whatsoever for any communication errors or troubles resulting from customer's network environment or connected devices.
- This unit is not compatible with PPPoE. A PPPoE-compatible router is required if you have a contract for a type of line set by PPPoE.
- Do not connect an NETWORK connector directly to the LAN port/Ethernet connector on your computer.



# Playback (Basic operation)

- ❑ **Selecting the input source** (☞ page 25)
- ❑ **Adjusting the master volume** (☞ page 26)
- ❑ **Turning off the sound temporarily** (☞ page 26)

- ❑ **Playing a Blu-ray Disc player/DVD player** (☞ page 26)
- ❑ **Playing a CD player** (☞ page 26)
- ❑ **Playing an iPod®** (☞ page 27)
- ❑ **Playing a USB memory device** (☞ page 28)
- ❑ **Tuning in radio stations** (☞ page 30)
- ❑ **Playing a network audio** (☞ page 34)

**Selecting a listening mode (Surround mode)**  
(☞ page 44)

**Playback (Advanced operation)** (☞ page 55)

## Important information

Before starting playback, make the connections between the different components and the settings on this unit.

### NOTE

Also refer to the operating instructions of the connected components when playing them.

## Selecting the input source

Press the input source select button (BD, DVD, VCR, SAT, GAME, AUX1, NET/USB, TV, CD, CDR, SATR, TUNE, M-XP) twice to play back that source. The desired input source can be selected directly.



You can also use the following operation to select an input source.



- Select input source "PHONO" to play back music from a record player connected to the PHONO input connector.
- Select the input source "PHONO" using one of the following methods.
  - ① "Source select" menu ("Using the "Source Select" menu" provided on the right)
  - ② **INPUT ▲▼** on the remote control unit ("Operating the remote control unit" provided on the right)
  - ③ **INPUT SELECTOR** knob on the main unit ("Operating the main unit" provided on the right)
- Select input source "SIRIUS" with **SATR** button.

### ❑ Using the "Source Select" menu

- ① Press **AMP** and the press **SOURCE SEL**.  
Display the "Source Select" menu.

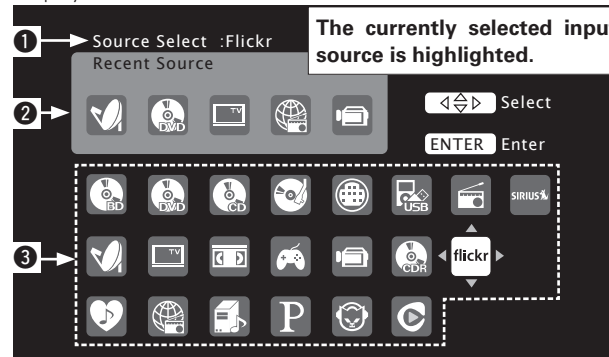

- ① **Input Source**  
The name of the highlighted input source is displayed.
- ② **Recently used sources**  
The recently used input sources (up to five) are displayed.
- ③ **Icons for the input sources in the different categories are displayed.**

- ② Use **▲▼◀▶** to select the input source, then press **ENTER**.  
The input source is set and the source selection menu is turned off.

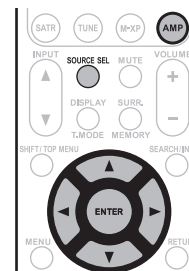

- When using with an iPod connected directly to the USB port of this unit, select "**NET/USB**" for the input source.
- Input sources that are not going to be used can be set ahead of time. Make this setting at "Source Delete" (☞ page 84).
- To turn off the source selection menu without selecting an input source, press **SOURCE SEL** again.

### ❑ Using the button on the remote control unit

Press **INPUT ▲▼**.

- When **INPUT ▲▼** is pressed, the input source is switched in the order shown below.

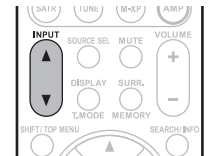

### ❑ Using the knob on the main unit

Turn **INPUT SELECTOR**.

- Turning **INPUT SELECTOR** switches the input source, as shown below.

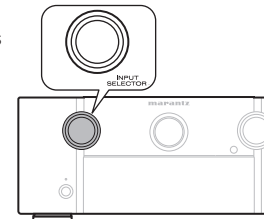

Important information

### Adjusting the master volume

Use **VOLUME** to adjust the volume.

- When the "Volume Display" setting (☞ page 84) is "Relative" [Adjustable range] **--- -80.5dB - 18.0dB**

- When the "Volume Display" setting (☞ page 84) is "Absolute" [Adjustable range] **0.0 - 99.0**

The adjustable range may vary depending on input signal and channel level settings.



You can also operate via the main unit. In this case, perform the following operations. Turn **VOLUME** to adjust the volume.

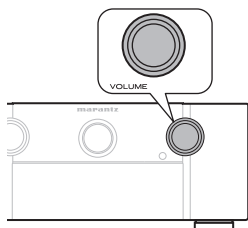

### Turning off the sound temporarily

Press **MUTE**.

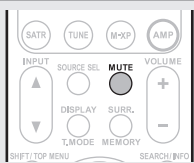

- The sound is reduced to the level set at "Mute Level" (☞ page 84).
- To cancel, press **MUTE** again. Muting can also be canceled by adjusting the master volume.

### Set the front speakers to be used

Press **SPKR A/B**.

- Each time you press **SPKR A/B**, the front speaker setting will change as follows.

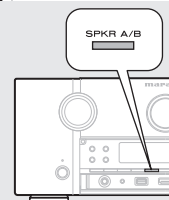
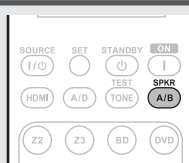
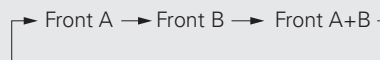

### Playing a Blu-ray Disc player/DVD player

The following describes the procedure for playing Blu-ray Disc player/DVD player.

- Prepare for playback.**
  - Turn on the power of the TV, subwoofer and player.
  - Change the TV input to the input of this unit.
  - Load the disc in the player.
- Press ON to turn on power to the unit.**
- Press BD or DVD twice to switch the input source for the player used for playback.**
- Play the component connected to this unit.** Make the necessary settings on the player (language setting, subtitles setting, etc.) beforehand.



### Playing a CD player

The following describes the procedure for playing CD player.

- Prepare for playback.**
  - Turn on the power of the subwoofer and player.
  - Load the disc in the player.
- Press ON to turn on power to the unit.**
- Press CD twice to switch the input source to the CD player.**
- Play the component connected to this unit.**

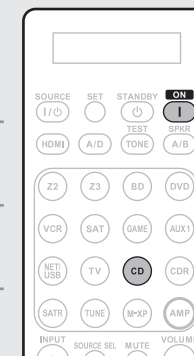

# Playing an iPod®

You can play back both video, photo and audio.

**1** Connect the iPod® to the USB port (see page 20 “Connecting an iPod or USB memory device to the USB port”).

**2** Press **ON** to turn on power to the unit.

**3** Press **NET/USB** twice to switch the input source to “NET/USB”.

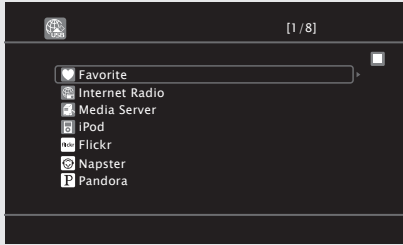

**4** Use  $\Delta$ / $\nabla$  to select “iPod”, then press **ENTER** or  $\triangleright$ .

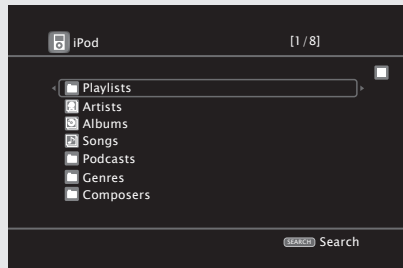

**NOTE**

If the connections screen is not displayed, the iPod may not be properly connected. Reconnect it.



**5** Press **SEARCH/INFO** and hold it down for 2 seconds or more to select the display mode.

• There are two modes for displaying the contents recorded on the iPod.

**Remote mode** Display iPod information on the TV screen.

- The unit display shows single-byte alphanumeric characters and some symbols only. “. . .” is displayed in place of incompatible characters.
- In “Remote mode”, the iPod display is as shown at right.



**Direct mode** Display iPod information on the iPod screen.

- “Direct iPod” is displayed on the display of this unit.

Display mode		Remote mode	Direct mode
Playable files	Music file	✓	✓
	Video file		*
Active buttons	Remote control unit (This unit)	✓	✓
	iPod®		✓

\* Only the sound is played.

**6** Use  $\Delta$ / $\nabla$  to select the item, then press **ENTER** or  $\triangleright$  to select the file to be played.

**7** Press **ENTER**,  $\triangleright$  or  $\blacktriangleright$ . Playback starts.



- You can specify the duration of the on-screen display to be displayed (default: 30 sec) at menu “NET/USB” (see page 85). Press  $\Delta$ / $\nabla$ / $\triangleleft$ / $\triangleright$  to return to the original screen.
- To play back compressed audio with extended bass or treble reproduction, we recommend playback in M-DAX mode (see page 76). The default setting is “OFF”.
- In Remote mode, press **STATUS** during playback to check the title name, artist name, and album name.

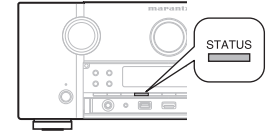

**NOTE**

- Depending on the type of iPod and the software version, some functions may not operate.
- Note that Marantz will accept no responsibility whatsoever for any problems arising with the data on an iPod when using this unit in conjunction with the iPod.

Playing an iPod®

❑ iPod operation

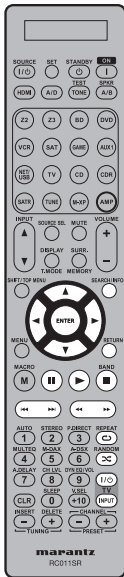

Operation buttons	Function
△ ▽ ◀ ▶	Cursor operation / Auto search (cue, △ ▽) / Manual search (Press and hold, △ ▽)
<b>ENTER</b> (Press and release)	Enter / Pause
<b>ENTER</b> (Press and hold)	Stop
<b>SEARCH</b> (Press and release)	Page search *1 / Character search *2
<b>SEARCH</b> (Press and hold)	Remote / Direct mode switching
<b>RETURN</b>	Return
◀◀ ▶▶ (Press and hold)	Manual search (fast-reverse/fast-forward)
▶	Playback / Pause
◀◀ ▶▶	Auto search (cue)
⏸	Pause
■	Stop
<b>REPEAT</b>	Repeat playback
<b>RANDOM</b>	Random playback
<b>TV POWER</b>	TV power on/standby (Default : Marantz)
<b>TV INPUT</b>	Switch TV input (Default : Marantz)

\*1 When the menu screen is displayed, press **SEARCH/INFO**, then press ◀ (previous page) or ▶ (next page).

To cancel, press △ ▽ or **SEARCH/INFO** twice.

\*2 When the menu screen is displayed, press **SEARCH/INFO** twice, then press ◀ ▶ to select the first letter you want to search mode.

- If it is not possible to search the list, "unsorted list." is displayed.

To cancel, press △ ▽ or **SEARCH/INFO**.



- Repeat playback and shuffle playback can also be set from "Input Setup" – "Playback Mode" (page 71) in the menu.
- If the list is not in alphabetical order, you may not be able to perform a character search.

## Playing a USB memory device

Playing back music or still picture (JPEG) files recorded on a USB memory device.

### Important information

#### ❑ USB memory devices

A USB memory device can be connected to the USB port of this unit to play music and still picture (JPEG) files stored on the USB memory device.

Also, files stored on an iPod can be played when the iPod is connected directly to the USB port of this unit. See "Connecting an iPod or USB memory device to the USB port" (page 20).

- Only USB memory devices conforming to mass storage class and MTP (Media Transfer Protocol) standards can be played on this unit.
- This unit is compatible with USB memory devices in "FAT16" or "FAT32" format.

#### Album art function

When an MP3 music file includes album art data, the album art can be displayed while playing the file.

#### Slide show function

Still picture (JPEG) files stored on USB memory devices can be played as slide shows.

The duration each picture is displayed can be set.



This unit plays back image (JPEG) files in the orientation in which they are stored in the folder.

#### [Compatible formats]

	USB memory devices *1
<b>WMA</b> (Windows Media Audio)	✓ *2
<b>MP3</b> (MPEG-1 Audio Layer-3)	✓
<b>WAV</b>	✓
<b>MPEG-4 AAC</b>	✓ *3
<b>FLAC</b> (Free Lossless Audio Codec)	✓
<b>JPEG</b>	✓

\*1 USB

- This unit is compatible with MP3 ID3-Tag (Ver. 2) standard.
- This unit can show the artwork that was embedded by using MP3 ID3-Tag Ver. 2.3 or 2.4.
- This unit is compatible with WMA META tags.
- WAV format Quantization bit rate: 16 bits.
- FLAC format Quantization bit rate: 16/24 bits.

\*2 Copyright-protected files can be played on certain portable players compatible with MTP.

\*3 Only files that are not protected by copyright can be played on this unit.

Content downloaded from pay sites on the Internet are copyright protected. Also, files encoded in WMA format when ripped from a CD, etc. on a computer may be copyright protected, depending on the computer's settings.

#### [Compatible formats]

	Sampling frequency	Bit rate	Extension
<b>WMA</b> (Windows Media Audio)	32/44.1/48 kHz	48 – 192 kbps	.wma
<b>MP3</b> (MPEG-1 Audio Layer-3)	32/44.1/48 kHz	32 – 320 kbps	.mp3
<b>WAV</b>	32/44.1/48 kHz	–	.wav
<b>MPEG-4 AAC</b>	32/44.1/48 kHz	16 – 320 kbps	.aac/ .m4a/ .mp4
<b>FLAC</b> (Free Lossless Audio Codec)	32/44.1/48/ 88.2/96 kHz	–	.flac

## Playing files stored on USB memory devices

**1** Connect the USB memory device to the USB port (☞ page 20 “Connecting an iPod or USB memory device to the USB port”).

**2** Press **NET/USB** twice to switch the input source to “NET/USB”.

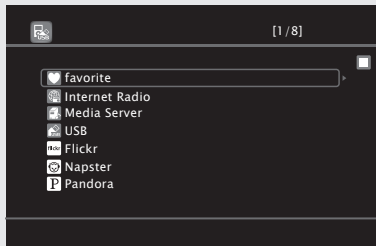

**3** Press  $\Delta \nabla$  to select “USB”, then press **ENTER** or  $\triangleright$ .

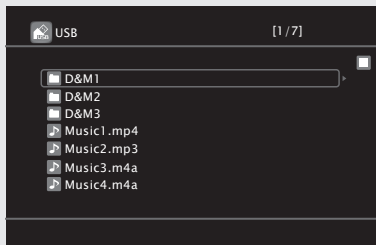

• Selecting  in the “Source Select” menu, lets you directly select “USB”.

**4** Press  $\Delta \nabla$  to select the search item or folder, then press **ENTER** or  $\triangleright$ .

**5** Press  $\Delta \nabla$  to select the file, then press **ENTER**,  $\triangleright$  or  $\blacktriangleright$ .  
Playback starts.

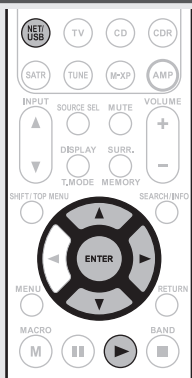

- You can specify the duration of the on-screen display to be displayed (default: 30 sec) at menu “NET/USB” (☞ page 85). Press  $\Delta \nabla \triangleleft \triangleright$  to return to the original screen.
- To play back compressed audio with extended bass or treble reproduction, we recommend playback in M-DAX mode (☞ page 76). The default setting is “OFF”.
- If the USB memory device is divided into multiple partitions, only the top partition can be selected.
- This unit is compatible with MP3 files conforming to “MPEG-1 Audio Layer-3” standards.

### NOTE

- Note that Marantz will accept no responsibility whatsoever for any problems arising with the data on a USB memory device when using this unit in conjunction with the USB memory device.
- USB memory devices will not work via a USB hub.
- Marantz does not guarantee that all USB memory devices will operate or be supplied power. When using a USB portable hard disk that can draw power from an AC adapter, we recommend using the AC adapter.
- It is not possible to connect and use a computer via the USB port of this unit using a USB cable.

## USB operation



Operation buttons	Function
<b>PRESET +, -</b>	Preset channel selection
$\Delta \nabla \triangleleft \triangleright$	Cursor operation / Auto search (cue, $\Delta \nabla$ )
<b>ENTER</b> (Press and release)	Enter / Pause
<b>ENTER</b> (Press and hold)	Stop
<b>SEARCH</b>	Page search *1 / Character search *2
<b>RETURN</b>	Return
$\blacktriangleright$	Playback / Pause
$\triangleleft \blacktriangleright \blacktriangleright \blacktriangleright$	Auto search (cue)
$\parallel$	Pause
$\blacksquare$	Stop
<b>1 - 8</b>	Preset channel selection
<b>SHIFT</b>	Preset channel block selection
<b>REPEAT</b>	Repeat playback
<b>RANDOM</b>	Random playback
<b>TV POWER</b>	TV power on/standby (Default : Marantz)
<b>TV INPUT</b>	Switch TV input (Default : Marantz)

\*1 When the menu screen is displayed, press **SEARCH/INFO**, then press  $\triangleleft$  (previous page) or  $\triangleright$  (next page).

To cancel, press  $\Delta \nabla$  or **SEARCH/INFO** twice.

\*2 When the menu screen is displayed, press **SEARCH/INFO** twice, then press  $\triangleleft \triangleright$  to select the first letter you want to search mode.

• If it is not possible to search the list, “unsorted list.” is displayed.

To cancel, press  $\Delta \nabla$  or **SEARCH/INFO**.



- Repeat playback and shuffle playback can also be set from “Input Setup” – “Playback Mode” (☞ page 71) in the menu.
- If the list is not in alphabetical order, you may not be able to perform a character search.

## Tuning in radio stations

### Important information

#### □ About SIRIUS XM radio

To listen to Satellite Radio, you'll need to connect either a SIRIUS or XM Satellite Radio tuner (sold separately) to your satellite-ready receiver. Satellite Radio is available to residents of the US (except Alaska and Hawaii) and Canada.

Satellite Radio delivers a variety of commercial-free music from categories ranging from Pop, Rock, Country, R&B, Dance, Jazz, Classical and many more plus coverage of all the top professional and college sports including play by play games from select leagues and teams. Additional programming includes expert sports talk, uncensored entertainment, comedy, family programming, local traffic and weather and news from your most trusted sources.

Whether you purchase a SIRIUS or XM tuner, you'll need to activate and subscribe to begin enjoying the service. Easy to follow installation and setup instructions are provided with the satellite tuners. Whichever service you choose, there are a variety of programming packages available, including the option of adding "The Best of SIRIUS" programming to your XM tuner or "The Best of XM" programming to your SIRIUS tuner, enabling you to enjoy the most popular programming among both services. The "Best of" packages are not available to SIRIUS or XM Canada subscribers at this time.

Family friendly packages are also available to restrict channels featuring content that may be inappropriate for children.

To subscribe to XM, U.S. customers should visit [xmradio.com](http://xmradio.com) or call 1-800-XMRADIO (1-800-967-2346); Canadian customers should visit [xmradio.ca](http://xmradio.ca) or call XM Listener Care at 1-877-GETXMSR (1-877-438-9677).

To subscribe to SIRIUS, U.S. and Canadian customers can call 1-888-539-SIRI (1-888-539-7474) or visit [sirius.com](http://sirius.com) (US) or [siriuscanada.ca](http://siriuscanada.ca) (Canada).

#### □ SIRIUS XM radio legal

SIRIUS, XM and all related marks and logos are trademarks of Sirius XM Radio Inc. and its subsidiaries. All other marks and logos are the property of their respective owners. All rights reserved. SIRIUS and XM subscriptions sold separately. Taxes and a one-time activation fee may apply. XM tuners and home docks or SIRIUS tuners (each sold separately) are required to receive the SIRIUS or XM satellite radio service. All programming and fees subject to change. It is prohibited to copy, decompile, disassemble, reverse engineer, hack, manipulate or otherwise make available any technology or software incorporated in receivers compatible with the SIRIUS or XM Satellite Radio Systems. **Service not available in Alaska and Hawaii.**

#### □ Using the HD Radio™ receiver

HD Radio stations offer higher sound quality than conventional FM/ AM broadcasts. It is also possible to receive data services and select broadcasts from among up to eight multicast programs.

HD Radio Technology provides higher quality sound than conventional broadcasts and allows reception of data services.

- FM sounds as sensational as CDs
  - AM sounds as rich as analog FM stereo
  - A variety of "data services", including text-based information, song title, artist name, album name, genre, etc. can be received.
- Furthermore, in addition to conventional broadcasts, with HD Radio broadcasting it is possible to choose from up to 8 multicast programs.

For detailed information on HD Radio Technology, please go to "[www.hdradio.com](http://www.hdradio.com)".

### Listening to SIRIUS satellite radio

**1** Press **SATR** twice to switch the input source to "SIRIUS".

**2** Use **TUNING +** or **TUNING -** to select the channel.

When the channel is tuned in, the name of the song and artist are displayed.

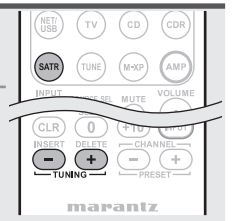

- The channel switches continuously when **TUNING +** or **TUNING -** is pressed and held.
- You can specify the duration of the on-screen display to be displayed (default: 30 sec) at menu "TUNER" (page 85). Press  $\Delta$   $\nabla$   $\triangleleft$   $\triangleright$  to return to the original screen.
- The song title, artist name, composer name, category and reception level can be checked by pressing **STATUS**.

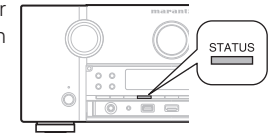



❑ **Checking the SIRIUS signal strength and radio ID**

**1** Press **STATUS** until “**SIGNAL**” appears on the display.

The display will switch as shown below, depending on the reception conditions.

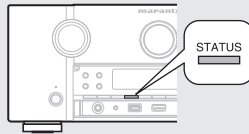

Display	Status
<b>EXCELLENT</b>	Signal strength is excellent
<b>GOOD</b>	Signal strength is good
<b>WEAK</b>	Signal strength is weak
<b>NO SIGNAL</b>	No signal

**2** Adjust the position of the antenna until “**SIGNAL: EXCELLENT**” is shown on the display.

**3** Press **STATUS** until the channel (example: “**SR001**”) is displayed.

**4** Press **TUNING +** or **TUNING –** and select channel **0 (SR000)**.

Channel No. and Sirius ID are alternately shown on the display.

SR000 SiriusID  
\*\*\*\*\* ← Sirius ID

• Write your own SIRIUS ID for storage use.

Sirius ID : \_\_\_\_\_

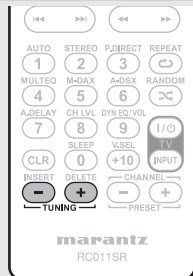

The strength of both the SIRIUS satellite and terrestrial signals can be checked “Antenna Aiming” (☞ page 68).

❑ **Presetting radio channels (Preset memory)**

Your favorite broadcast channels can be preset so that you can tune them in easily. Up to 56 channels can be preset.

**1** Tune in the broadcast channel you want to preset.

**2** Press **MEMORY**.

**3** Press **SHIFT** to select the block (A to G) in which to preset the channel (1 to 8 per block), then press **PRESET +**, **PRESET –** or **1 – 8** to select the preset number.

**4** Press **MEMORY** again to complete the setting.

• To preset other stations, repeat steps 1 to 4.



**NOTE**

Preset channels are erased by overwriting them.

❑ **Listening to preset channels**

Press **PRESET +**, **PRESET –** to select the desired preset channel, then press **ENTER**.

• Preset channels can also be selected by pressing **SHIFT/TOP MENU** (Block) and **1 – 8** (Channel).



You can also operate via the main unit. In this case, perform the following operations. Press **◀ ▶** to select the preset radio channel.

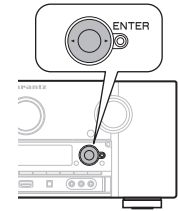

❑ **Searching categories**

**1** Press **◀ ▶**.

SR001 Hits 1  
CAT: POPS ← Channel category

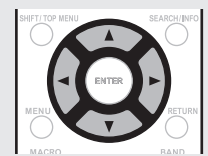

**2** Use **◀ ▶** to select the category, to use **▲ ▼** to select the desired channel.

❑ **Accessing SIRIUS satellite radio channels directly**

**1** Press **SEARCH/INFO**.

**2** Press **0 – 9** to input the channel.  
Example: Accessing channel “SR123”: Press **1**, **2** and **3**.

• If no button is pressed within several seconds, the channel automatically switches to the one whose number has been input.

**3** Press **ENTER** to set that channel.  
Reception switches to the selected channel.



- “UPDATING” is displayed while the encoding code is being updated.
- “SIRIUS UPDATING” is displayed when updating SIRIUS tuner firmware.
- Refer to “Troubleshooting” – “SIRIUS Satellite Radio” (☞ page 113) regarding other messages.

Tuning in radio stations

Parental Lock

- 1 Tune to the channel you want to lock.
- 2 Press **ENTER** for at least 3 seconds.  
"Enter Lock Code" is displayed.
- 3 Enter the 4-digit lock code using  $\Delta \nabla \triangleleft \triangleright$  or 0-9.  
When you enter the correct code, the corresponding channel is locked.
- 4 Press **ENTER**.



- Channels under Parental Lock cannot be tuned in by performing channel up/down or by category search.
- Channels stored in preset memory can be tuned in by the preset channel select operation, even if Parental Lock is applied.
- When a channel to which Parental Lock is applied is being played, Parental Lock for that channel is cancelled by performing step 2.
- See "Edit Lock Cord" (page 68) for the method of changing Parental Lock Cord.
- You can also set "Parental Lock" (page 67) from the menu.

SIRIUS operation



Operation buttons	Function
<b>PRESET +, -</b>	Preset channel selection
$\Delta \nabla \triangleleft \triangleright$	Cursor operation / Category search
<b>ENTER</b> (Press and hold)	To parental lock password check screen
<b>SEARCH</b>	Direct search
<b>RETURN</b>	Return
<b>TUNING +, -</b>	Channel selection
<b>0-9</b>	Preset channel selection (1-8) / Direct frequency tuning (0-9)
<b>SHIFT</b>	Preset channel block selection
<b>MEMORY</b>	Preset memory registration
<b>TV POWER</b>	TV power on/standby (Default : Marantz)
<b>TV INPUT</b>	Switch TV input (Default : Marantz)

Listening to HD Radio stations

- 1 Press **TUNE** twice to switch the input source to "HD Radio".
  - 2 Press **BAND** to select "FM" or "AM".
- FM** When listening to an FM broadcast.  
**AM** When listening to an AM broadcast.

- 3 Tune in the desired broadcast station.

- ① **To tune in automatically (Auto tuning)**  
Press **T.MODE** to light the "HD-AUTO" or "AUTO" indicator on the display, then use **TUNING +** or **TUNING -** to select the station you want to hear.
  - The **HD** indicator lights on the display when an HD Radio station is tuned in.
  - When "HD-AUTO" (tuning mode) is selected, only HD Radio stations are tuned in.
  - If "AUTO" (tuning mode) is selected, both HD Radio and analog stations are tuned in.
- ② **To tune in manually (Manual tuning)**  
Press **T.MODE** to turn off the display's "AUTO" indicator, then use **TUNING +** or **TUNING -** to select the station you want to hear.

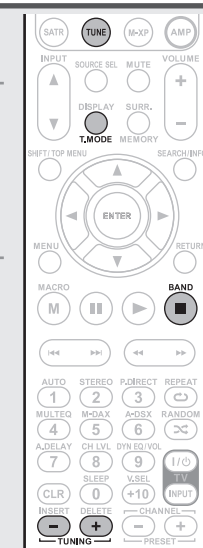

- If the desired station cannot be tuned in with auto tuning, tune it in manually.
- When tuning in stations manually, press and hold **TUNING +** or **TUNING -** to change frequencies continuously.
- You can specify the duration of the on-screen display to be displayed (default: 30 sec) at menu "TUNER" (page 85). Press  $\Delta \nabla \triangleleft \triangleright$  to return to the original screen.



### Selecting audio programs

HD Radio Technology enables stations to broadcast multiple Audio Program and data services on HD2 / HD3 / HD4 channels.

Press  $\Delta$   $\nabla$  to select the audio program.

If the station you are listening to has multiple audio programs, "HD1" is indicated on the display. If it only has one audio program, "HD" is indicated.

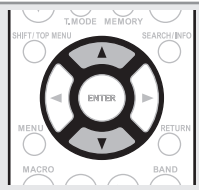

### Presetting radio stations (Manual preset)

Your favorite broadcast stations can be preset so that you can tune them in easily. Up to 56 stations can be preset.

- Stations can be preset automatically at "Auto Preset" (page 67). If "Auto Preset" is performed after performing "Manual Preset", the "Manual Preset" settings will be overwritten.

**1** Tune in the broadcast station you want to preset.

**2** Press **MEMORY**.

**3** Press **SHIFT/TOP MENU** to select the block (A to G) in which to preset the channel (1 to 8 per block), then press **PRESET +**, **PRESET -** or **1 - 8** to select the preset number.

**4** Press **MEMORY** again to complete the setting.

- To preset other stations, repeat steps 1 to 4.



### Default settings

Block (A – G) and Channel (1 – 8)	Default Settings
A1 – A8	87.5 / 87.9 / 89.1 / 93.3 / 97.9 / 98.1 / 98.9 / 100.1 MHz
B1 – B8	101.9 / 102.7 / 107.9 / 90.1 / 90.1 / 90.1 / 90.1 / 90.1 MHz
C1 – C8	530 / 600 / 930 / 1000 / 1120 / 1210 / 1400 / 1710 kHz
D1 – D8	90.1 MHz
E1 – E8	90.1 MHz
F1 – F8	90.1 MHz
G1 – G8	90.1 MHz

### Specify a name for the preset broadcast station (Preset Name) (page 68)

#### Listening to preset stations

**1** Press **SHIFT/TOP MENU** to select the memory block (A to G).

**2** Press **PRESET +**, **PRESET -** or **1 - 8** to select the desired preset channel.



You can also operate via the main unit. In this case, perform the following operations. Press  $\triangleleft$   $\triangleright$  to select the preset radio station.

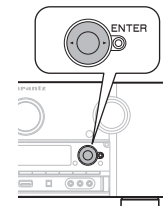

### Direct frequency tuning

You can enter the receiving frequency directly to tune in.

**1** Press **SEARCH/INFO**.

**2** Input frequencies using the **0 - 9**.

- If  $\triangleleft$  is pressed, the immediately preceding input is cancelled.

**3** When setting is completed, press **ENTER**.

The preset frequency is tuned in.



### Check the HD Radio reception information

Press **STATUS** while an HD Radio broadcast is being received.

The current reception information is shown on the display.

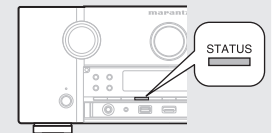

- Normal
- Frequency / Signal strength
- Station name / Program and Program type
- Title name / Artist name
- Album name / Genre name

#### NOTE

If the station signal weakens while receiving a digital broadcast (while HD and text is displayed), the mode automatically switches to the analog reception mode (the reception frequency is displayed). Because of this, the HD indicator and text may flicker if the station signal level is weak and unstable.

## Tuning in radio stations

## ❑ Tuner (HD Radio reception) operation

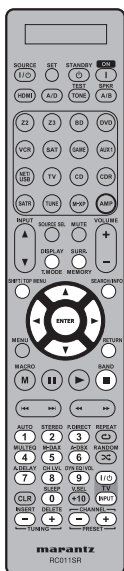

Operation buttons	Function
PRESET +, -	Preset channel selection
△ ▽ ◀ ▶	Cursor operation / Multicast switching (△ ▽)
ENTER	Enter
SEARCH	Direct frequency tuning
RETURN	Return
BAND	FM/AM switching
T.MODE	Switch search modes
TUNING +, -	Tuning (up/down)
0 - 9	Preset channel selection (1 - 8) / Direct frequency tuning (0 - 9)
SHIFT	Preset channel block selection
MEMORY	Preset memory registration
TV POWER	TV power on/standby (Default : Marantz)
TV INPUT	Switch TV input (Default : Marantz)

## Playing a network audio

Follow this procedure to play Internet radio stations or music or still picture (JPEG) files stored on a computer.

## Important information

## ❑ About the internet radio function

- Internet radio refers to radio broadcasts distributed over the Internet.  
Internet radio stations from around the world can be received.
- This unit is equipped with the following Internet radio functions:
  - Stations can be selected by genre and region.
  - Up to 56 Internet radio stations can be preset.
  - Internet radio stations in MP3 and WMA (Windows Media Audio) format can be listened to.
  - Your favorite radio stations can be registered by accessing an exclusive Marantz Internet radio URL from a Web browser on a computer.
  - The function is managed for individual users, so you must provide your MAC or e-mail address.  
Exclusive URL: <http://www.radiomarantz.com>
  - The radio station database service may be suspended without notice.
  - This unit's Internet radio station list is created using a radio station database service (vTuner). This database service provides a list edited and created for this unit.

## ❑ Media player

This function lets you play music files and playlists (m3u, wpl) stored on a computer (media server) connected to this unit via a network.

With this unit's network audio playback function, connection to the server is possible using one of the technologies below.

- Windows Media Player Network Sharing Service
- Windows Media DRM10

## Album art function

When a WMA (Windows Media Audio), MP3 or MPEG-4 AAC file includes album art data, the album art can be displayed while the music files are playing.



For music files in WMA (Windows Media Audio) format, the album art is only played when using Windows Media Player ver. 11.

## Slide show function

Still picture (JPEG) files stored in folders on a media server can be played as slide shows. The duration each picture is displayed can be set.



This unit plays back image (JPEG) files in the orientation in which they are stored in the folder.

## [Compatible formats]

	Internet radio	Media server *1
WMA (Windows Media Audio)	✓	✓
MP3 (MPEG-1 Audio Layer-3)	✓	✓
WAV		✓
MPEG-4 AAC		✓ *2
FLAC (Free Lossless Audio Codec)		✓
JPEG		✓

A server or server software compatible with distribution in the corresponding formats is required to play music files via a network.

\*1 Media server

- This unit is compatible with MP3 ID3-Tag (Ver. 2) standard.
- This unit can show the artwork that was embedded by using MP3 ID3-Tag Ver. 2.3 or 2.4.
- This unit is compatible with WMA META tags.
- WAV format Quantization bit rate: 16 bits.
- FLAC format Quantization bit rate: 16/24 bits.

\*2 Only files that are not protected by copyright can be played on this unit.

Content downloaded from pay sites on the Internet are copyright protected. Also, files encoded in WMA format when ripped from a CD, etc. on a computer may be copyright protected, depending on the computer's settings.

[Compatible formats]

	Sampling frequency	Bit rate	Extension
<b>WMA</b> (Windows Media Audio)	32/44.1/48 kHz	48 – 192 kbps	.wma
<b>MP3</b> (MPEG-1 Audio Layer-3)	32/44.1/48 kHz	32 – 320 kbps	.mp3
<b>WAV</b>	32/44.1/48 kHz	–	.wav
<b>MPEG-4 AAC</b>	32/44.1/48 kHz	16 – 320 kbps	.aac/ .m4a/ .mp4
<b>FLAC</b> (Free Lossless Audio Codec)	32/44.1/48/ 88.2/96 kHz	–	.flac

### □ About Flickr

Flickr is an online photograph sharing service that started in 2004. You can use this unit to view photographs that have been made public by Flickr users. You do not need an account to use Flickr. To view photographs that you recorded yourself, you need an account in order to upload these photographs to the Flickr server. For details, see the Flickr homepage.  
<http://www.flickr.com/>

### □ About Napster

Napster is a monthly subscription music distribution service provided by Napster LLC. This service allows users to download and play pieces of music they want to hear on this unit. Before you can use Napster, you will need to visit the Napster website on your PC to create an account and register as a member. For details, access the following site:  
[http://www.napster.com/choose/index\\_default.html](http://www.napster.com/choose/index_default.html)

### □ About Pandora

Pandora is an automated music recommendation and Internet radio service created by the Music Genome Project. When you first listen to Pandora, it is necessary to subscribe to a Pandora account at the Pandora homepage by your PC and register this machine. See the Pandora homepage for details.  
<http://www.pandora.com/marantz>

### □ About Rhapsody

Rhapsody is a paid music broadcast service of RealNetworks. When you first listen to Rhapsody, it is necessary to subscribe to a Rhapsody account at the Rhapsody homepage by your PC and register this machine. See the Rhapsody homepage for details.  
<http://www.rhapsody.com/marantz>

## Listening to internet radio

### 1 Prepare for playback.

- Check the network environment, then turn on this unit's power (page 24 "Connecting to a home network (LAN)").
- If settings are required, make the "Network Connecting" (page 81).

### 2 Press NET/USB twice to switch the input source to "NET/USB".

### 3 Press $\Delta$ / $\nabla$ to select "Internet Radio", then press ENTER or $\triangleright$ .

- Selecting  in the "Source Select" menu, lets you directly select "Internet Radio".

### 4 Press $\Delta$ / $\nabla$ to select the item you want to play, then press ENTER or $\triangleright$ .

### 5 Repeat step 4 until the station list is displayed.

The station list is displayed.

### 6 Press $\Delta$ / $\nabla$ to select the station, then press ENTER or $\triangleright$ .

Playback starts once buffering reaches "100%".

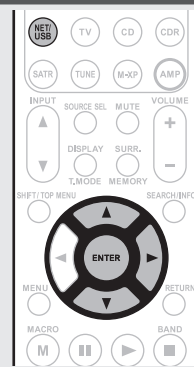

- There are many Internet radio stations on the Internet, and the quality of the programs they broadcast as well as the bit rate of the tracks varies widely. Generally, the higher the bit rate, the higher the sound quality, but depending on the communication lines and server traffic, the music or audio signals being streamed may be interrupted. Inversely, lower bit rates mean a lower sound quality but less tendency for the sound to be interrupted.
- "Server Full" or "Connection Down" is displayed if the station is busy or not broadcasting.
- On this unit, folder and file names can be displayed as titles. Any characters that cannot be displayed are replaced with "." (period).
- To play back compressed audio with extended bass or treble reproduction, we recommend playback in M-DAX mode (page 76). The default setting is "OFF".



- You can specify the duration of the on-screen display to be displayed (default: 30 sec) at menu "NET/USB" (page 85. Press  $\Delta$ / $\nabla$ / $\triangleright$  to return to the original screen.
- When **STATUS** is pressed, the display can be switched between the title name and radio station name.

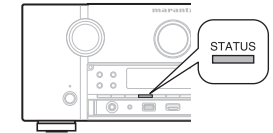

### □ Recently played internet radio stations

Recently played internet radio stations can be selected from "Recently Played".  
Up to 20 stations stored in "Recently Played".

### 1 Press $\Delta$ / $\nabla$ to select "Recently Played", then press ENTER or $\triangleright$ .

### 2 Press $\Delta$ / $\nabla$ to select the item you want to play, then press ENTER or $\triangleright$ .



### □ Searching stations by keyword (Alphabetic strings)

### 1 Press $\Delta$ / $\nabla$ to select "Search by Keyword", then press ENTER or $\triangleright$ .

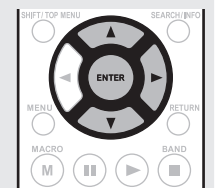
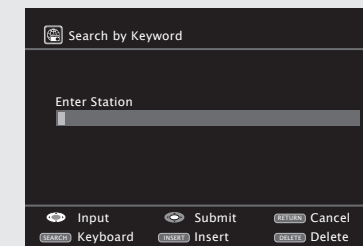

- For character input, see page 65.

### 2 Input the characters, then press ENTER.

Playing a network audio

❑ Presetting internet radio stations

Preset Internet radio stations can be selected directly.

- 1** While the Internet radio station you want to preset is playing, press **MEMORY**.
- 2** Press  $\Delta \nabla$  to select “Preset”, then press **ENTER**.
- 3** Press **SHIFT/TOP MENU**, then press **PRESET +**, **PRESET -** or **1 - 8** to select the desired preset number.
- 4** Press **MEMORY** again to complete the setting.  
The Internet radio station is now preset.



**NOTE**

If registered at a number that has already been preset, the previously registered setting is cleared.

❑ Listening to preset internet radio stations

After pressing **SHIFT/TOP MENU**, press **PRESET +**, **PRESET -** or **1 - 8** to select the registered preset number.

This unit automatically connects to the Internet and playback begins.



❑ Registering internet radio stations as your favorites

Favorites are listed at the top of the menu screen, so when a station is registered as a favorite it can be tuned in easily.

- 1** Press **MEMORY** while the Internet radio station you want to register is playing.
  - 2** Press  $\Delta \nabla$  to select “Favorites”, then press **ENTER**.
  - 3** Press  $\triangleleft$  to select “Add”.  
The Internet radio station is registered.
- If you do not want to register the station, press  $\triangleright$ .

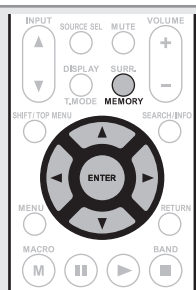

❑ Listening to internet radio stations registered in your favorites

- 1** Press **AMP** and then press **SOURCE SEL** to display the Source Select menu, then select  (page 25).
- 2** Press **NET/USB** and then press  $\Delta \nabla$  to select the Internet radio station, then press **ENTER** or  $\triangleright$ .  
This unit automatically connects to the Internet and playback begins.

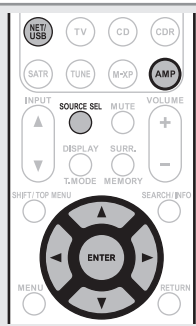

❑ Clearing internet radio stations from your favorites

- 1** Press **AMP** and then press **SOURCE SEL** to display the Source Select menu, then select  (page 25).
- 2** Press **NET/USB** and then press  $\Delta \nabla$  to select the Internet radio station you want to clear, then press **MEMORY**.

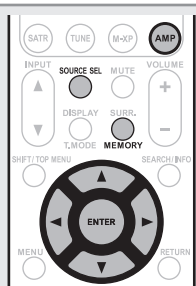

- 3** Press  $\triangleleft$  to select “Remove”.  
The selected Internet radio station is cleared.

- To cancel the operation without clearing the station, press  $\triangleright$ .

❑ Internet radio operation



Operation buttons	Function
<b>PRESET +, -</b>	Preset channel selection
$\Delta \nabla \triangleleft \triangleright$	Cursor operation
<b>ENTER</b> (Press and release)	Enter
<b>ENTER</b> (Press and hold)	Stop
<b>SEARCH</b>	Page search *1 / Character search *2
<b>RETURN</b>	Return
	Stop
<b>1 - 8</b>	Preset channel selection
<b>SHIFT</b>	Preset channel block selection
<b>MEMORY</b>	Favorites / Preset memory registration
<b>TV POWER</b>	TV power on/standby (Default : Marantz)
<b>TV INPUT</b>	Switch TV input (Default : Marantz)

\*1 When the menu screen is displayed, press **SEARCH/INFO**, then press  $\triangleleft$  (previous page) or  $\triangleright$  (next page).

To cancel, press  $\Delta \nabla$  or **SEARCH/INFO** twice.

\*2 When the menu screen is displayed, press **SEARCH/INFO** twice, then press  $\triangleleft \triangleright$  to select the first letter you want to search mode.

- If it is not possible to search the list, “unsorted list.” is displayed.

To cancel, press  $\Delta \nabla$  or **SEARCH/INFO**.

 If the list is not in alphabetical order, you may not be able to perform a character search.

## Playing files stored on a computer

Use this procedure to play music files, image files or playlists.

### 1 Prepare for playback.

- Check the network environment, then turn on this unit's power (page 24 "Connecting to a home network (LAN)").
- If settings are required, make the "Network Connecting" (page 81).
- Prepare the computer (Computer's operating instructions).

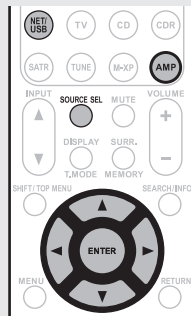

### 2 Press AMP and then press SOURCE SEL to display the Source Select menu, then select (page 25).

### 3 Press NET/USB and then use $\Delta \nabla$ to select the server including the file to be played, then press ENTER or $\triangleright$ .

### 4 Use $\Delta \nabla$ to select the search item or folder, then press ENTER or $\triangleright$ .

### 5 Repeat step 4 until the file is displayed.

### 6 Press $\Delta \nabla$ to select the file, then press ENTER or $\triangleright$ . Playback starts once buffering reaches "100%".



- Connections to the required system and specific settings must be made in order to play music files (page 24).
- Before starting, you must launch the computer's server software and set the files as server contents. For details, see the operating instructions of your server software.
- Depending on the size of the still picture (JPEG) file, some time may be required for the file to be displayed.
- The order in which the tracks/files are displayed depends on the server specifications. If the tracks/ files are not displayed in alphabetical order due to the server specifications, searching by the first letter may not work properly.
- WMA Lossless files can be played when using a server supporting transcoding, such as Windows Media Player Ver. 11.



- To play back compressed audio with extended bass or treble reproduction, we recommend playback in M-DAX mode (page 76). The default setting is "OFF".
- You can specify the duration of the on-screen display to be displayed (default: 30 sec) at menu "NET/USB" (page 85). Press  $\Delta \nabla \triangleleft \triangleright$  to return to the original screen.
- Use **STATUS** to switch between displaying the title name, artist name or album name.

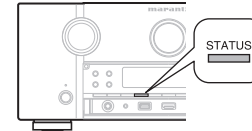

### Playing files that have been preset or registered in your favorites

Files can be preset, registered in your favorites and played using the same operations as for Internet radio stations (page 36).

#### NOTE

- Presettings are erased by overwriting them.
- When the operations described below is performed, the media server's database is updated and it may no longer be possible to play preset or favorite music files.
  - When you quit the media server and then restart it.
  - When music files are deleted or added on the media server.
- When using an ESCIENT server, place "ESCIENT" before the server name.

## Media server operation

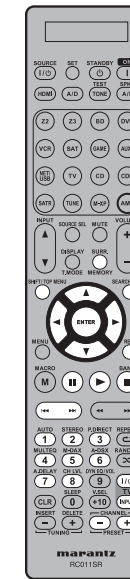

Operation buttons	Function
<b>PRESET +, -</b>	Preset channel selection
$\Delta \nabla \triangleleft \triangleright$	Cursor operation / Auto search (cue, $\Delta \nabla$ )
<b>ENTER</b> (Press and release)	Enter / Pause
<b>ENTER</b> (Press and hold)	Stop
<b>SEARCH</b>	Page search *1 / Character search *2
<b>RETURN</b>	Return
$\blacktriangleright$	Playback / Pause
$\blacktriangleleft \blacktriangleright$	Auto search (cue)
<b>II</b>	Pause
<b>■</b>	Stop
<b>1 - 8</b>	Preset channel selection
<b>SHIFT</b>	Preset channel block selection
<b>MEMORY</b>	Favorites / Preset memory registration
<b>TV POWER</b>	TV power on/standby (Default : Marantz)
<b>TV INPUT</b>	Switch TV input (Default : Marantz)

- Repeat playback** (page 71 "Repeat")
- Random playback** (page 71 "Random")

- \*1 When the menu screen is displayed, press **SEARCH/INFO**, then press  $\triangleleft$  (previous page) or  $\triangleright$  (next page). To cancel, press  $\Delta \nabla$  or **SEARCH/INFO** twice.
- \*2 When the menu screen is displayed, press **SEARCH/INFO** twice, then press  $\triangleleft \triangleright$  to select the first letter you want to search mode.
  - If it is not possible to search the list, "unsorted list." is displayed.
  - To cancel, press  $\Delta \nabla$  or **SEARCH/INFO**.



- If the list is not in alphabetical order, you may not be able to perform a character search.



Playing a network audio

### Viewing photographs on the Flickr site

You can view photographs shared by particular users, or all of the photographs shared on Flickr.

#### Viewing photographs shared by particular users

##### 1 Prepare for playback.

- Check the network environment, then turn on this unit's power (page 24 "Connecting to a home network (LAN)").
- If settings are required, make the "Network Connecting" (page 81).

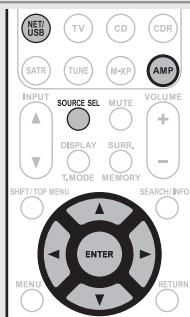

##### 2 Press AMP and then press SOURCE SEL to display the Source Select menu, then select flickr (page 25).

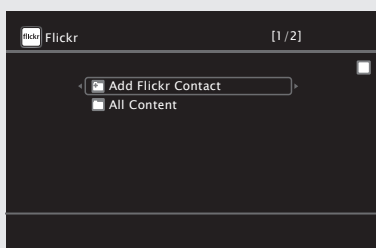

##### 3 Press NET/USB and then use $\Delta$ / $\nabla$ to select "Add Flickr Contact", then press ENTER or $\triangleright$ .

##### 4 Enter "Username".

• For character input, see page 65.

##### 5 After inputting the "Username", then press ENTER.

The "Username" entered in step 4 is displayed.

• If the Username you typed in cannot be found, "The Flickr Contact you entered could not be found" appears. Check and type in the correct Username.

##### 6 Press $\Delta$ / $\nabla$ to select the folder, and then press ENTER or $\triangleright$ .

- Favorites** Displays the favorite photographs of the specified user.
- Photostream** Displays a list of shared photographs.
- PhotoSets** Displays the folder (photograph album) list.
- Contacts** Displays a Username registered for Flickr Contact by a particular user.
- Remove this Contact** Deletes a user from Flickr Contact.

##### 7 Press $\Delta$ / $\nabla$ to select the file, and then press ENTER or $\triangleright$ .

The selected file is displayed.

#### Viewing all photographs on Flickr

##### 1 Prepare for playback.

- Check the network environment, then turn on this unit's power (page 24 "Connecting to a home network (LAN)").
- If settings are required, make the "Network Connecting" (page 81).

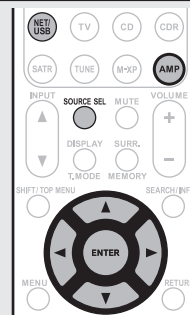

##### 2 Press AMP and then press SOURCE SEL to display the Source Select menu, then select flickr (page 25).

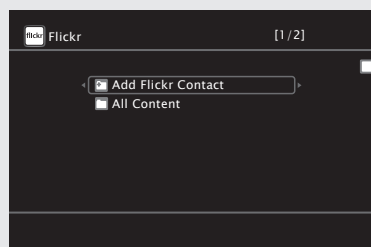

##### 3 Press NET/USB and then use $\Delta$ / $\nabla$ to select "All Content", then press ENTER or $\triangleright$ .

##### 4 Press $\Delta$ / $\nabla$ to select the folder, and then press ENTER or $\triangleright$ .

**Interestingness** Displays photographs that are popular from the number of user comments or number of times they are added as favorites.

**Recent** Displays the most recently added photographs.

**Search by text** Search for photographs by keyword.

##### 5 Press $\Delta$ / $\nabla$ to select the file, and then press ENTER or $\triangleright$ .

The selected file is displayed.

#### NOTE

Depending on the file format, some photographs cannot be viewed.

#### Flickr operation

Operation buttons	Function
PRESET +, -	Preset channel selection
$\Delta$ / $\nabla$ / $\triangleleft$ / $\triangleright$	Cursor operation / Auto search (cue, $\Delta$ / $\nabla$ )
ENTER (Press and release)	Enter
ENTER (Press and hold)	Stop
SEARCH	Page Search*
RETURN	Return
■	Stop
1 - 8	Preset channel selection
SHIFT	Preset channel block selection
TV POWER	TV power on/standby (Default : Marantz)
TV INPUT	Switch TV input (Default : Marantz)

\* When the menu screen is displayed, press **SEARCH/INFO**, then press  $\triangleleft$  (previous page) or  $\triangleright$  (next page). To cancel, press  $\Delta$ / $\nabla$  or **SEARCH/INFO**.

## Listening to Napster

### 1 Prepare for playback.

- Check the network environment, then turn on this unit's power (page 24 "Connecting to a home network (LAN)").
- If settings are required, make the "Network Connecting" (page 81).

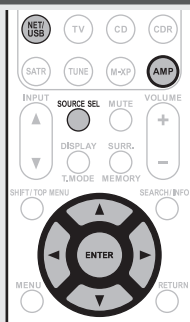

- ### 2 Press AMP and then press SOURCE SEL to display the Source Select menu, then select (page 25).

- ### 3 Press NET/USB and then use $\Delta$ $\nabla$ $\triangleright$ to input "Username" and "Password".

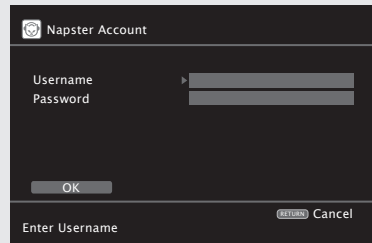

- For character input, see page 65.

- ### 4 After inputting the "Username" and "Password", select "OK", then press ENTER.

If the "Username" and "Password" match, the top menu for Napster is displayed.

#### NOTE

- The password should be no longer than 99 characters.
- Press **RETURN** to cancel the input. When "Cancel input?" is displayed, select "Yes", then press **ENTER**.

### Searching from Napster menu

- Use  $\Delta$   $\nabla$  to select search item or folder, then press **ENTER** or  $\triangleright$ .
- Repeat step 1 until the track is displayed.
- Use  $\Delta$   $\nabla$  to select the track item, then press **ENTER** or  $\triangleright$ .

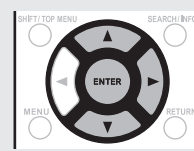

### Entering a character search for the track you want to listen to

- ### 1 Press SEARCH/INFO.

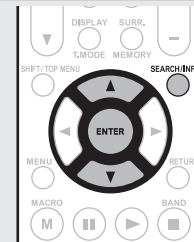
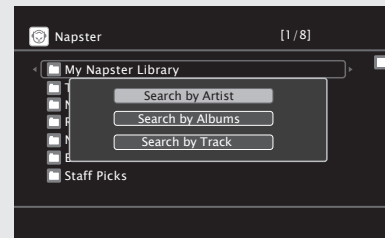

- You can search by artist name, album name or track name.

- ### 2 Use $\Delta$ $\nabla$ to select the search item, then press **ENTER**.
- The search display appears.

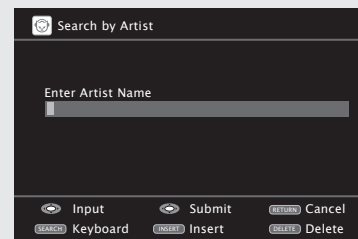

- For character input, see page 65.

- ### 3 Input the characters, then press **ENTER**.

### Registering tracks in my Napster library

- Press  $\triangleright$  while the track you wish to register is playing.
- Select "Add to my library", then press **ENTER** or  $\triangleright$ .  
The track is entered in the Library.

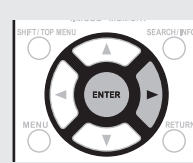

### Listening to tracks registered in my Napster library

- Use  $\Delta$   $\nabla$  to select "My Napster Library", then press **ENTER** or  $\triangleright$ .
- Use  $\Delta$   $\nabla$  to select the information or track, then press **ENTER**.

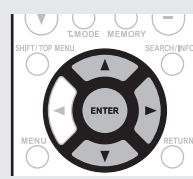

- To play back compressed audio with extended bass or treble reproduction, we recommend playback in M-DAX mode (page 76). The default setting is "OFF".
- You can specify the duration of the on-screen display to be displayed (default: 30 sec) at menu "NET/USB" (page 85). Press  $\Delta$   $\nabla$   $\triangleleft$   $\triangleright$  to return to the original screen.
- Use **STATUS** to switch between displaying the title name, artist name or album name.

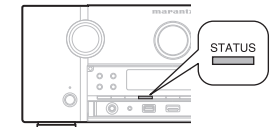



Playing a network audio

■ Napster operation

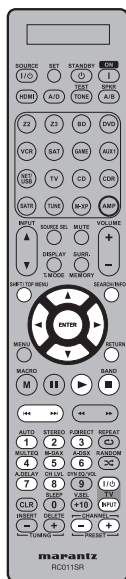

Operation buttons	Function
PRESET +, -	Preset channel selection
△▽◀▶	Cursor operation / Auto search (cue, △▽)
ENTER (Press and release)	Enter / Pause
ENTER (Press and hold)	Stop
SEARCH	Search menu / Page search *
RETURN	Return
▶	Playback / Pause
◀◀▶▶	Auto search (cue)
■	Stop
1 - 8	Preset channel selection
SHIFT	Preset channel block selection
TV POWER	TV power on/standby (Default : Marantz)
TV INPUT	Switch TV input (Default : Marantz)

- Repeat playback (☞ page 71 "Repeat")
- Random playback (☞ page 71 "Random")

\* When the menu screen is displayed, press **SEARCH/INFO** twice, then press ◀ (previous page) or ▶ (next page).  
To cancel, press △▽ or **SEARCH/INFO**.

Listening to Pandora

**1 Prepare for playback.**  
 ① Check the network environment, then turn on this unit's power (☞ page 24 "Connecting to a home network (LAN)").  
 ② If settings are required, make the "Network Connecting" (☞ page 81).

**2 Press AMP and then press SOURCE SEL to display the Source Select menu, then select P (☞ page 25). Then press NET/USB.**

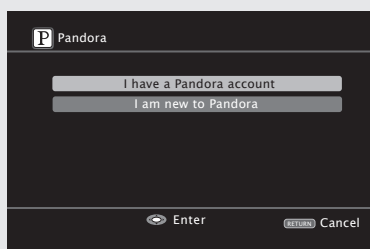

- If you do not have a Pandora account, press ▽ to select "I am new to Pandora". The URL of Pandora and activation code are displayed. Access the Pandora web page from your PC and register the displayed activation code and account information. Then press **ENTER**.

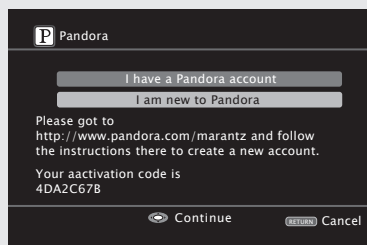

**3** If you have a Pandora account, press △▽ to select "I have a Pandora account", then press **ENTER** or ▶.

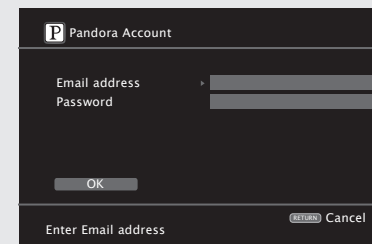

**4** Input "Email address" and "Password".

- For character input, see page 65.

**5** After inputting the "Email address" and "Password", select "OK", then press **ENTER**.  
If the "Email address" and "Password" match, the top menu for Pandora is displayed.

**NOTE**

Press **RETURN** to cancel the input. When "Cancel input?" is displayed, select "Yes", then press **ENTER**.

### ❑ Creating an original radio station

You can create up to 100 original radio stations.

**1** Use  $\Delta$   $\nabla$  to select “New Station”, then press **ENTER** or  $\triangleright$ .

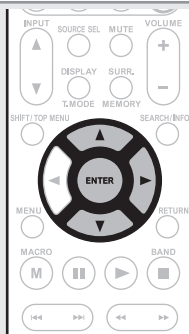
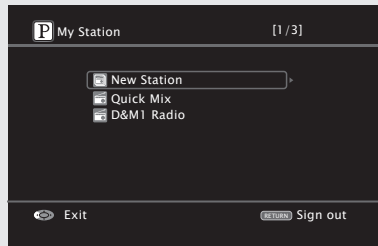

**2** Input a “Track Name” or “Artist Name”, then press **ENTER**.

• For character input, see page 65.

**3** Use  $\Delta$   $\nabla$  to select “Search by artist” or “Search by track”, then press **ENTER**.

You can search and display a list by track or artist.

**4** Press  $\Delta$   $\nabla$ , select a file (e.g. D&M2) from the list, and press **ENTER** or  $\triangleright$ .

Selected file is played back.

“Radio” is added to the end of a filename, and your original radio station is created (e.g. D&M2 Radio).



### ❑ Listening to a created radio station

#### Listening to a created radio station (e.g. D&M2 Radio)

By specifying your favorite track or artist name, music that has a similar rhythm or sound is chosen and streamed.

Press  $\Delta$   $\nabla$  and select the radio station (“D&M2 Radio”) that you want to listen to, and press **ENTER** or  $\triangleright$ .

In Pandora, you can search for the track name or artist name using “D&M2” as a keyword. When the search is complete, tracks that have a similar rhythm or sound are streamed.

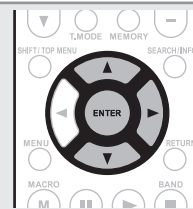
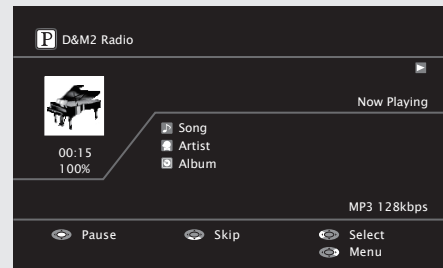

#### Listening to created radio stations at random

Use  $\Delta$   $\nabla$  to select “Quick Mix”, then press **ENTER** or  $\triangleright$ .

Created radio stations are selected at random, and tracks are streamed.

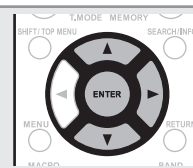

### ❑ Arranging tracks within radio stations

You can sort tracks by operating the Pandora menu screen while a track is playing.

Press  $\triangleright$  while a track is playing. The Pandora menu screen is displayed.

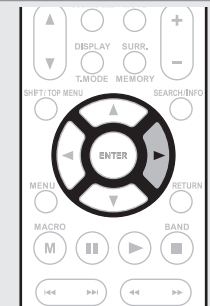
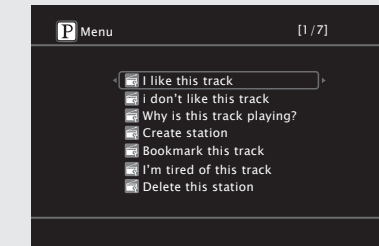

#### I like this track

- Press when you like the track that is being played.
- It will return to the Play Screen. And (Thumbs up) icon is displayed. (The icon is not displayed on the next track.)

#### I don't like this track

- Press when you don't like the track that is being played.
- It will return to the Play Screen. And (Thumbs down) icon is displayed. (The icon is not displayed on the next track.)

#### Why is this track playing?

- Displays the reason why Pandora selected this track.

#### Create station

- Creates a Station for the Track or Artist being played.

#### Bookmark this track

- Bookmarks the track currently being played.
- You can check on a computer or iPhone etc.
- For details, see the Pandora web page.

#### I'm tired of this track

- Press when you don't like the track that is being played.
- The track will not be played for 1 month.

#### Delete this station

- Press when you want to delete the station that is being played.

#### NOTE

- You can Skip up to 6 Tracks that are being played back within 1 hour.
- You can create up to 100 New Stations (radio stations).

Playing a network audio

❑ Sign out

Disassociate this unit from your Pandora account.

**1** While the Pandora top menu is displayed, press RETURN.

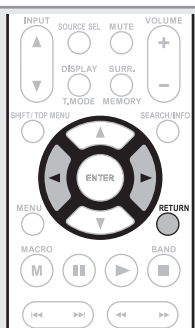
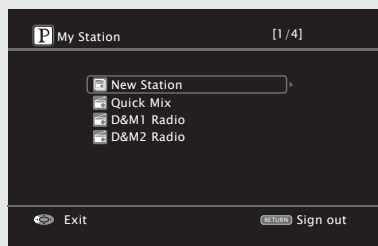

**2** When the popup menu appears, press ◀ ▶ to select “Yes”.

❑ Pandora operation

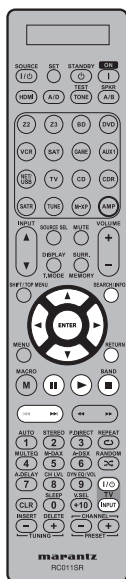

Operation buttons	Function
△▽◀▶	Cursor operation / Auto search (cue, ▽)
ENTER (Press and release)	Enter / Pause
ENTER (Press and hold)	Stop
SEARCH	Page search*
RETURN	Return
▶	Playback
▶▶I	Auto search (cue)
	Pause
■	Stop
TV POWER	TV power on/standby (Default : Marantz)
TV INPUT	Switch TV input (Default : Marantz)

\* When the menu screen is displayed, press SEARCH, then press ◀ (previous page) or ▶ (next page).  
To cancel, press △▽ or SEARCH.

Listening to Rhapsody

**1** Prepare for playback.

- ① Check the network environment, then turn on this unit's power (☞ page 24 “Connecting to a home network (LAN)”).
- ② If settings are required, make the “Network Connecting” (☞ page 81).

**2** Press AMP and then press SOURCE SEL to display the Source Select menu, then select (☞ page 25). Then press NET/USB.

**3** Use △▽ to select “Sign in to your account”, then press ENTER or ▶.

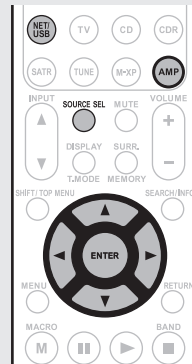
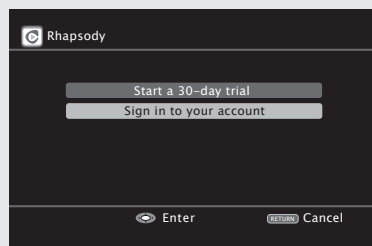

**4** Input Username and Password.

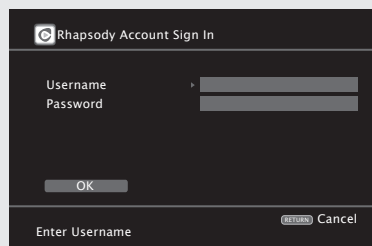

**5** After inputting the “Username” and “Password”, select “OK”, then press ENTER.  
If the “Username” and “Password” match, the top menu for Rhapsody is displayed.

**NOTE**

- The password should be no longer than 99 characters.
- Press RETURN to cancel the input. When “Cancel input?” is displayed, select “Yes”, then press ENTER.

❑ Select the search mode

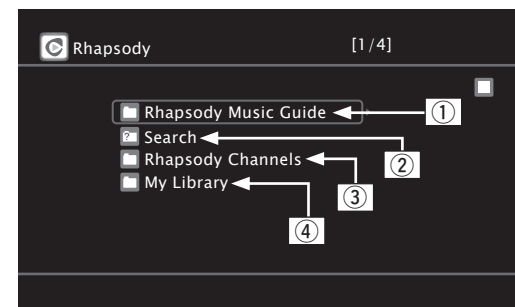

**①** Search from Rhapsody latest information

**1** Use △▽ to select “Rhapsody Music Guide”, then press ENTER or ▶.

**2** Press △▽ to select the information for track selection, then press ENTER or ▶.

- For character input, see page 65.

**3** Repeat step 2 until the track is displayed.

**4** Use △▽ to select the track, then press ENTER or ▶.

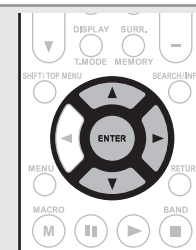

**②** Enter a character search for the track you want to listen to

**1** Use △▽ to select “Search”, then press ENTER or ▶.

**2** Use △▽ to select the search item, then press ENTER or ▶.  
The search display appears.

- You can search by artist name, album name, track name or keyword.

**3** Enter the characters, then press ENTER.

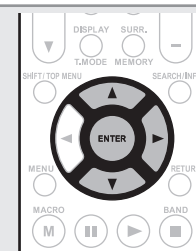

### ③ Search from the Rhapsody internet radio station

**1** Use  $\Delta \nabla$  to select “Rhapsody Channels”, then press **ENTER** or  $\triangleright$ .

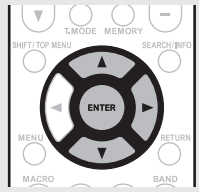

**2** Repeat step 1 until the radio station is displayed.

**3** Use  $\Delta \nabla$  to select radio station, then press **ENTER** or  $\triangleright$ .  
The search display appears.

### ④ Listening to tracks registered in my library

**1** Use  $\Delta \nabla$  to select “My Library”, then press **ENTER** or  $\triangleright$ .

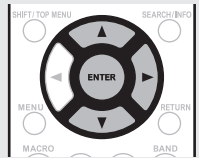

**2** Repeat step 1 until the track is displayed.

**3** Use  $\Delta \nabla$  to select the information or track, then press **ENTER** or  $\triangleright$ .  
After selecting, the information is displayed

### □ Track menu

Press  $\triangleright$  during playback to display the track menu.

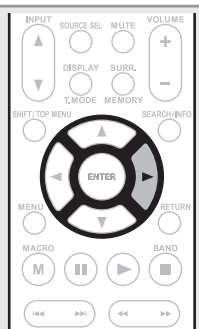
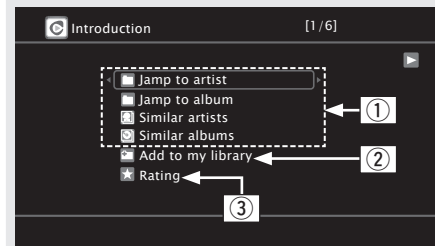

### ① Search from the similar music

Use  $\Delta \nabla$  to select the search item, then press **ENTER** or  $\triangleright$ .

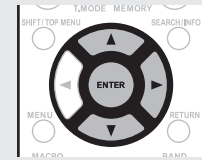

### ② Registering tracks in my library

Use  $\Delta \nabla$  to select “Add to my library”, then press **ENTER** or  $\triangleright$ .  
The track is entered in the library.

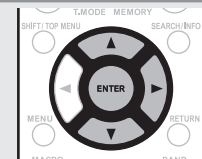

### ③ Rating function

**1** Use  $\Delta \nabla$  to select “Rating”, then press **ENTER** or  $\triangleright$ .

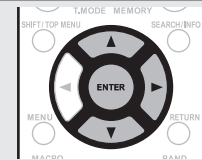

**2** Use  $\triangleleft \triangleright$  to select the rating, then press **ENTER**.



- To play back compressed audio with extended bass or treble reproduction, we recommend playback in M-DAX mode (page 76). The default setting is “OFF”.
- You can specify the duration of the on-screen display to be displayed (default: 30 sec) at menu “NET/USB” (page 85). Press  $\Delta \nabla \triangleleft \triangleright$  to return to the original screen.
- Use **STATUS** to switch between displaying the title name, artist name or album name.

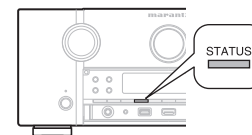

### □ Rhapsody operation



Operation buttons	Function
<b>PRESET +, -</b>	Preset channel selection
$\Delta \nabla \triangleleft \triangleright$	Cursor operation / Auto search (cue, $\Delta \nabla$ )
<b>ENTER</b> (Press and release)	Enter / Pause
<b>ENTER</b> (Press and hold)	Stop
<b>SEARCH</b>	Page search *1 / Character search *2
<b>RETURN</b>	Return
$\blacktriangleright$	Playback / Pause
$\triangleleft \blacktriangleright \blacktriangleright \blacktriangleright$	Auto search (cue)
$\parallel$	Pause
$\blacksquare$	Stop
<b>1 - 8</b>	Preset channel selection
<b>SHIFT</b>	Preset channel block selection
<b>TV POWER</b>	TV power on/standby (Default : Marantz)
<b>TV INPUT</b>	Switch TV input (Default : Marantz)

- **Repeat playback** (page 71 “Repeat”)
- **Random playback** (page 71 “Random”)

- \*1 When the menu screen is displayed, press **SEARCH**, then press  $\triangleleft$  (previous page) or  $\triangleright$  (next page).  
To cancel, press  $\Delta \nabla$  or **SEARCH** twice.
- \*2 When the menu screen is displayed, press **SEARCH** twice, then press  $\triangleleft \triangleright$  to select the first letter you want to search mode.
  - If it is not possible to search the list, “unsorted list.” is displayed.  
To cancel, press  $\Delta \nabla$  or **SEARCH**.

- If the list is not in alphabetical order, you may not be able to perform a character search.

# Selecting a listening mode (Surround mode)

This unit can play input audio signals in multi-channel surround mode or in stereo mode. Select a listening mode suitable for the playback contents (cinema, music, etc.) or according to your liking.

## Listening mode

Input audio signal	Playback	Listening mode	
2-channel Multi channel		Multi-channel playback (page 44)	For 2-channel signal input: • Surround-channel signals are created and played with surround playback. For multichannel signal input: • The surround signal recorded in source is played as surround playback. (The sound is played according to the settings of the speaker size in "Speaker Config." (page 78).) • Surround-back-channel or front-height-channel signals that are not recorded in source can be created.
2-channel Multi channel		Stereo playback (page 46)	• If multichannel signals are input, they are mixed down to 2-channel audio and are played. • Subwoofer signals are also output.
2-channel Multi channel		Direct playback (page 46)	Sound recorded in source is played as is. • Surround back signals or front height signals are not created. • In this mode, the following items cannot be adjusted. • Tone (page 73) • MultEQ® XT (page 74) • Dynamic EQ® (page 74) • Dynamic Volume® (page 75) • M-DAX (page 76)
2-channel Multi channel		Dolby Virtual Speaker/ Dolby Headphone playback (page 46)	Virtual Surround processing is performed on 2-channel or multichannel input signals that are played back.



- Some listening modes cannot be selected, depending on the audio format or number of channels of the input signal. For details, see "Types of input signals, and corresponding surround modes" (page 106).
- Adjust the sound field effect with the menu "Surround Parameter" (page 73) to enjoy your favorite sound mode.
- You can select the listening mode by pressing **SURROUND MODE** on the main unit.  
Press **SURROUND MODE** and the modes are switched as shown below.

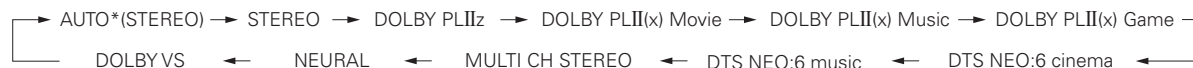
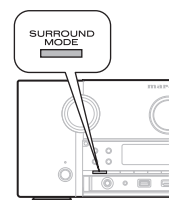

\* For "AUTO", press **AUTO** on the amplifier or remote control unit.

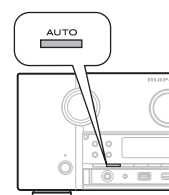

## Multi-channel playback

### Surround playback of 2-channel sources

**1** Playing the source (page 26 – 42).

**2** Press **SURR.** to select the surround decoder to play back multichannel sound.

- If **SURROUND MODE** on the main unit is pressed, the same function as with the remote control unit can be obtained.
- Each time **SURR.** is pressed, the surround mode is switched.  
Which decoder can be selected depends on the settings of "Amp Assign" (page 78) or "Speaker Config." (page 78).

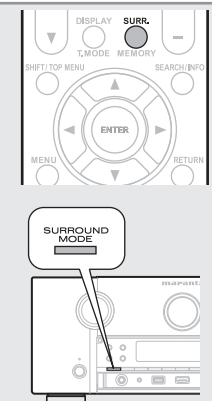

**DOLBY PLIIz** \*1 This mode is for 7.1-channel surround playback using the front height speakers.  
• "PLIIz Height" is displayed.

**DOLBY PLIIx** \*2 This mode is for 7.1-channel or 6.1-channel surround playback using the surround back speakers.  
• "PLIIx Movie", "PLIIx Music" or "PLIIx Game" is displayed.

**DOLBY PLII** This mode is for 5.1-channel surround playback. Select this mode if no front height speaker nor surround back speaker is to be used.  
• "PLII Movie", "PLII Music", "PLII Game" is displayed.

**DTS NEO:6** This mode is for 7.1-channel, 6.1-channel or 5.1-channel surround playback using the surround back speakers.  
• "DTS NEO:6 Cinema" or "DTS NEO:6 Music" is displayed.

**MULTI CH STEREO** This mode is for enjoying stereo sound from all speakers.

**NEURAL** \*3 This mode is for 7.1-channel, 6.1-channel or 5.1-channel surround playback using the surround back speakers.

- “NEURAL” is displayed.

- \*1 This can be selected when the “Amp Assign” (page 78) setting in the menu is set to “Normal” is set to “A”.
- \*2 This can be selected when “Amp Assign” is set to “Normal” or “Speaker Config.” – “S.Back” is not set to “None”.
- \*3 This mode supports analog 2-channel audio, and linear PCM 2 channel (44.1 kHz, 48 kHz) audio.

**[Views on the display]**

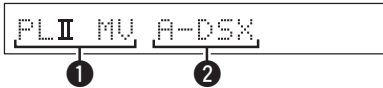

- ① Shows a decoder to be used.
- ② Shows Audyssey DSX™ processing.

**Surround playback of multi-channel sources (Dolby Digital, DTS etc.)**

**1** Playing the source (page 26 – 42).

**2** Press **SURR.** to select the surround decoder to play back multichannel sound.

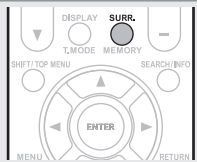

- If **SURROUND MODE** on the main unit is pressed, the same function as with the remote control unit can be obtained.

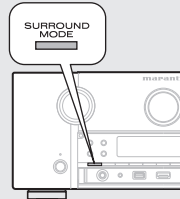

- Select the surround mode while viewing the display on the screen ( “Displaying the currently playing surround mode” at right).

- Which decoder can be selected depends on the input signal, the settings of “Amp Assign” (page 78) or “Speaker Config.” (page 78).

**Displaying the currently playing surround mode**

Input signal	Surround mode	Display
DOLBY DIGITAL (2ch)	NEURAL	NEURAL
DOLBY DIGITAL (other than 2ch) / DOLBY DIGITAL EX	DOLBY DIGITAL	DOLBY DIGITAL
	DOLBY DIGITAL EX	DOLBY DIGITAL EX
	DOLBY DIGITAL + PLIIx Movie	DOLBY D + PLIIx MV
	DOLBY DIGITAL + PLIIx Music	DOLBY D + PLIIx MS
	DOLBY DIGITAL + PLIIz	DOLBY D + PLIIz
DOLBY DIGITAL Plus	DOLBY DIGITAL Plus	DOLBY DIGITAL +
	DOLBY DIGITAL Plus + EX	DOLBY D + + EX
	DOLBY DIGITAL Plus + PLIIx Movie	DOLBY D + PLIIx MV
	DOLBY DIGITAL Plus + PLIIx Music	DOLBY D + PLIIx MS
	DOLBY DIGITAL Plus + PLIIz	DOLBY D + + PLIIz
DOLBY TrueHD	DOLBY TrueHD	DOLBY TrueHD
	DOLBY TrueHD + EX	DOLBY HD +EX
	DOLBY TrueHD + PLIIx Movie	DOLBY HD +PLIIx MV
	DOLBY TrueHD + PLIIx Music	DOLBY HD +PLIIx MS
	DOLBY TrueHD + PLIIz	DOLBY HD +PLIIz
DTS (5.1ch) / DTS-ES Discrete 6.1 / DTS-ES Matrix 6.1 / DTS 96/24	DTS SURROUND	DTS SURROUND
	DTS + PLIIx Movie	DTS + PLIIx MV
	DTS + PLIIx Music	DTS + PLIIx MS
	DTS + PLIIz HEIGHT	DTS + PLIIz
	DTS + NEO:6	DTS + NEO:6
	DTS ES MTRX6.1*1	DTS ES MTRX6.1
	DTS ES DSCRT6.1*2	DTS ES DSCRT6.1
	DTS 96/24*3	DTS 96/24
DTS-HD	DTS-HD HI RES	DTS-HD HI RES
	DTS-HD MSTR	DTS-HD MSTR
	DTS-HD + NEO:6	DTS-HD + NEO:6
	DTS-HD + PLIIx MOVIE	DTS-HD + PLIIx MV
	DTS-HD + PLIIx MUSIC	DTS-HD + PLIIx MS
	DTS-HD + PLIIz HEIGHT	DTS-HD + PLIIz
	DTS Express	DTS Express
PCM (multi ch)	MULTI CH IN	MULTI CH IN
	MULTI IN + Dolby EX	MULTI +Dolby EX
	MULTI IN + PLIIx MOVIE	MULTI IN +PLIIx MV
	MULTI IN + PLIIx MUSIC	MULTI IN +PLIIx MS
	MULTI IN + PLIIz HEIGHT	MULTI IN +PLIIz
	MULTI CH IN 7.1	MULTI CH IN 7.1
All Input signal	Dolby VIRTUAL SPEAKER	DOLBY VS
All signals indicated above	Audyssey DSX*4	Audyssey DSX

- \*1 This is displayed when the input signal is “DTS-ES Matrix 6.1”.
- \*2 This is displayed when the input signal is “DTS-ES Discrete 6.1”.
- \*3 This is displayed when the input signal is “DTS 96/24”.
- \*4 This surround mode is displayed when “Audyssey DSX” (page 75) is set to “ON-Height-” or “ON-Wide-”.

**[Views on the display]**



- ① Shows a decoder to be used.
  - A DOLBY DIGITAL Plus decoder is displayed as “DOLBY D +”.
- ② Shows a decoder that creates sound output from the surround back speakers.
  - “+ PLIIz” indicates the front height sound from front height speakers.



For an input signal that can be reproduced in each surround mode, see “Surround modes and parameters” (page 104).



## Stereo playback

This is the mode for playing in stereo. The tone can be adjusted.

- Sound is output from the front left and right speakers and subwoofer.
- If multichannel signals are input, they are mixed down to 2-channel audio and are played.

**1** Playing the source (☞ page 26 – 42).

**2** Press **STEREO**.  
Stereo playback begins.



## Direct playback

Sound recorded in source is played as is.

- Surround back signals or front height signals are not created.
- In this mode, the following items cannot be adjusted.
  - Tone (☞ page 73)
  - MultEQ® XT (☞ page 74)
  - Dynamic EQ® (☞ page 74)
  - Dynamic Volume® (☞ page 75)
  - M-DAX (☞ page 76)

**1** Playing the source (☞ page 26 – 42).

**2** Press **P.DIRECT** to select the direct mode.

- If **PURE DIRECT** on the main unit is pressed, the same function as with the remote control unit can be obtained.

- Each time **P.DIRECT** is pressed, the direct mode is switched.

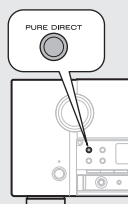

**Source Direct** This mode plays back tracks at high sound quality without passing through the sound quality adjustment circuits.

**Pure Direct** \* This mode plays back tracks at the closest to the original sound quality.

**Auto** This mode detects the type of input digital signal, and automatically selects the corresponding mode for playback.

- \* The following circuits that affect sound quality are set to off.
- Main unit's display circuit (The display is turned off.)
  - Analog video input/output circuit



- To cancel, press **P.DIRECT** again.
- Video signals are only output when HDMI signals are played in the PURE DIRECT mode.

### NOTE

When in the PURE DIRECT mode, the menu screen is not displayed.

## Dolby Virtual Speaker/Dolby Headphone playback

### ☐ Dolby Virtual Speaker mode

This delivers a full surround sound experience from two stereo speakers.

- Sound is output from the front left and right speakers.
- If multichannel signals are input, they are mixed down to 2-channel audio.

**1** Playing the source (☞ page 26 – 42).

**2** Press **SURR.** to select “DOLBY VS”.

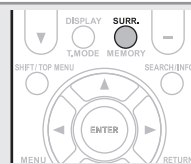

### ☐ Dolby Headphone mode

You can enjoy listening to multi-channel surround sound through headphones using this mode.

Press **SURR.** to select the Dolby Headphone mode.

- If **SURROUND MODE** on the main unit is pressed, the same function as with the remote control unit can be obtained.

- Each time **SURR.** is pressed, the Dolby Headphone mode is switched.

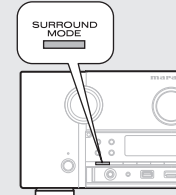
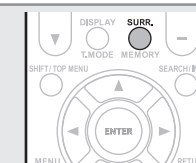

**DOLBY HEADPHONE** This is the surround mode for listening with headphones. The surround sound field is played through regular headphones.

**DOLBY HP BYPASS** The sound is played in the normal stereo mode rather than the surround mode when listening with headphones.

**DOLBY HP PLII Movie** This mode is best suited for movie sources.

**DOLBY HP PLII Music** This mode is best suited for music sources.

### NOTE





- The surround mode returns to the previous setting as soon as the plug is removed from the jack.
- You can select Dolby HP PLII Movie or Dolby HP PLII Music when a 2-channel source is played back.



## Advanced version

---

Here, we explain functions and operations that let you make better use of this unit.

- **Speaker installation/connection (Advanced connection)**  page 48
- **Playback (Advanced operation)**  page 55
- **Playback in ZONE2/ZONE3 (Separate room)**  page 61
- **How to make detailed settings**  page 63
- **Operating the connected devices by remote control unit**  page 90

# Speaker installation/connection (Advanced connection)

This section provides the installation, connection, and setup methods of speaker systems other than the 7.1-channel system (with surround back speakers).

For the speaker installation, connection, and setup methods of the 7.1-channel system with surround back speakers, see "Simple version (Simple setup guide)" (page 4).

Use Audyssey® Auto Setup function of this unit to automatically detect the number of connected speakers and perform optimal settings for the speakers to be used.

## Procedure for speaker settings

Install

Connect (page 49)

Set up speakers (page 52)

## Install

This unit is compatible with Audyssey DSX™ (page 109) and Dolby Pro Logic IIz (page 110), which offers an even wider and deeper surround sensation. When using Audyssey DSX, install front wide speakers or front height speakers. When using Dolby Pro Logic IIz, install front height speakers.



Install the surround back speakers in a position 2 to 3 ft (60 to 90 cm) higher than ear level.

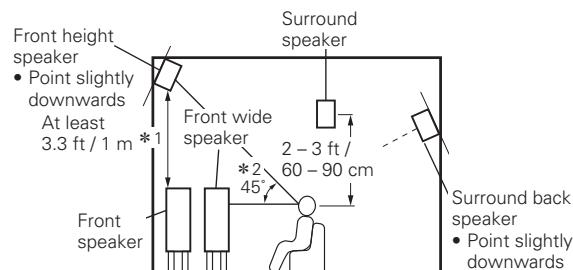

[Viewed from the side]

- \*1 Recommended for Dolby Pro Logic IIz
- \*2 Recommended for Audyssey DSX

### NOTE

Sound is not output simultaneously from the surround back speakers, front height speakers, and front wide speakers. You can switch between speakers by changing the settings in surround mode or Audyssey DSX.

## When 7.1ch (Surround back / Front height / Front wide speaker) installed

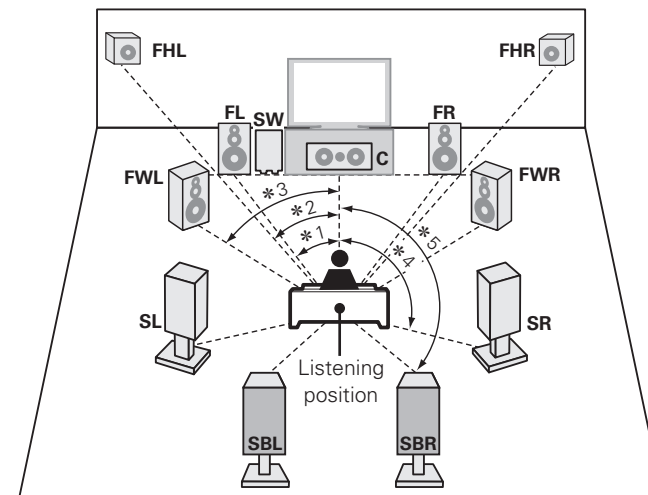

- \*1 22° - 30°
- \*2 22° - 45°
- \*3 55° - 60°
- \*4 90° - 110°
- \*5 135° - 150°

## When 6.1ch (Surround back speaker) installed

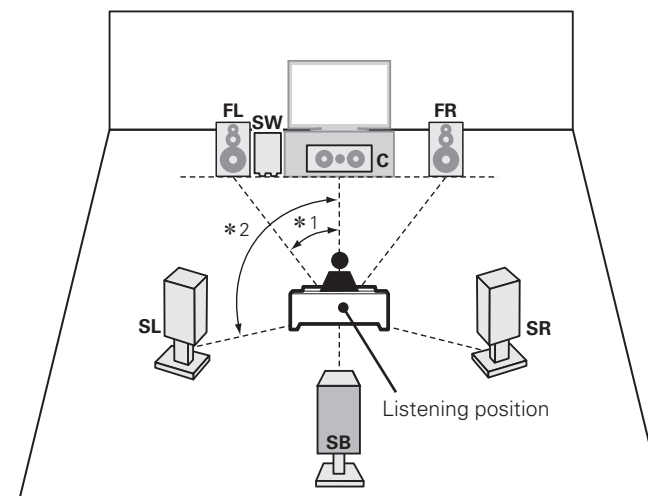

- \*1 22° - 30°
- \*2 90° - 110°

**When 5.1ch installed**

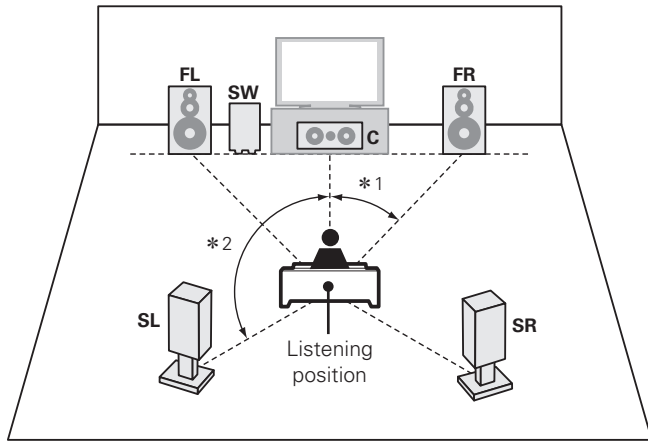

\* 1 22° - 30° \* 2 120°

**When Front A/B speakers installed**

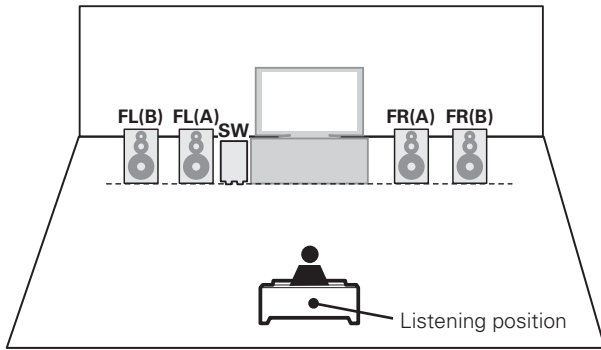

- |                                 |                                      |
|---------------------------------|--------------------------------------|
| <b>FL</b> Front speaker (L)     | <b>SBL</b> Surround back speaker (L) |
| <b>FR</b> Front speaker (R)     | <b>SBR</b> Surround back speaker (R) |
| <b>C</b> Center speaker         | <b>FHL</b> Front height speaker (L)  |
| <b>SW</b> Subwoofer             | <b>FHR</b> Front height speaker (R)  |
| <b>SL</b> Surround speaker (L)  | <b>FWL</b> Front wide speaker (L)    |
| <b>SR</b> Surround speaker (R)  | <b>FWR</b> Front wide speaker (R)    |
| <b>SB</b> Surround back speaker |                                      |

**Connect**

- For the method of connecting the 7.1-channel system with surround back speakers, see page 5.
- For the method of connecting the TV, see page 7.

**Example of connections to Marantz MM7055 and MM7025 power amp**

**7.1-channel (Surround back / Front height / Front wide speaker) connection**

For 7.1-channel (Surround back / Front height / Front wide speaker) playback, set "Set up "Amp Assign"" (page 52) to "Normal".

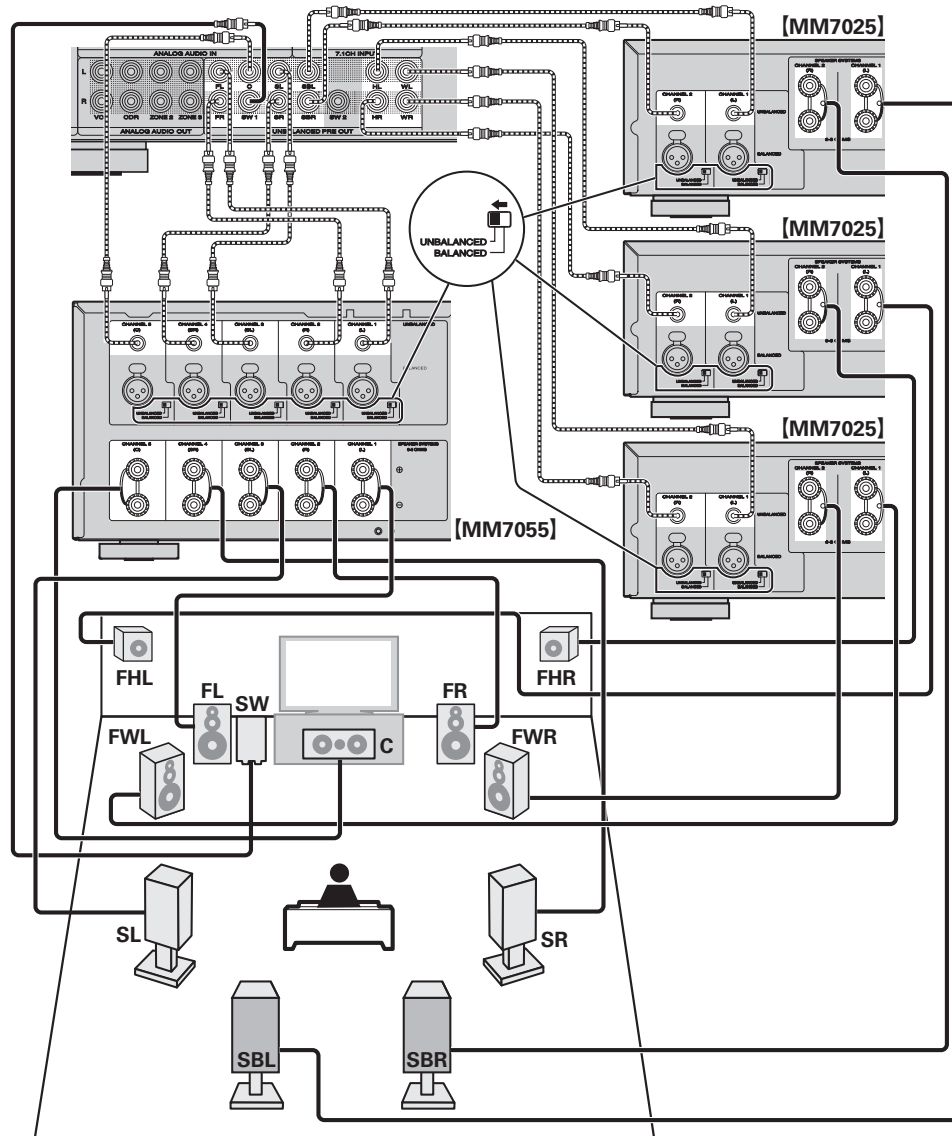

For speaker impedance and speaker cable connections, see power amp user guide.

Connect

**6.1-channel (Surround back speaker) connection**

If you are using just one surround back speaker, connect it to the UNBALANCED or BALANCED PRE OUT SBL terminals on the power amp.

For speaker settings in this case, see "When 6.1ch (Surround back speaker) installed" (page 48).

For 6.1-channel (Surround back speaker) playback, set "Set up "Amp Assign"" (page 52) to "Normal".

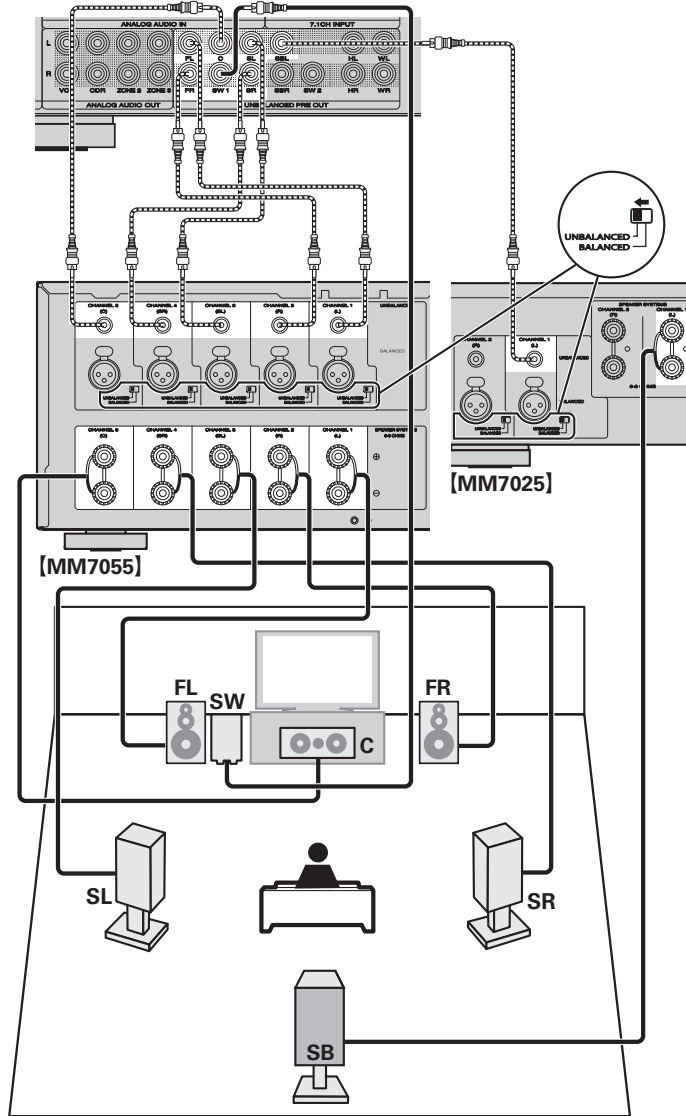

**5.1-channel connection**

For 5.1-channel playback, set "Set up "Amp Assign"" (page 52) to "Normal".

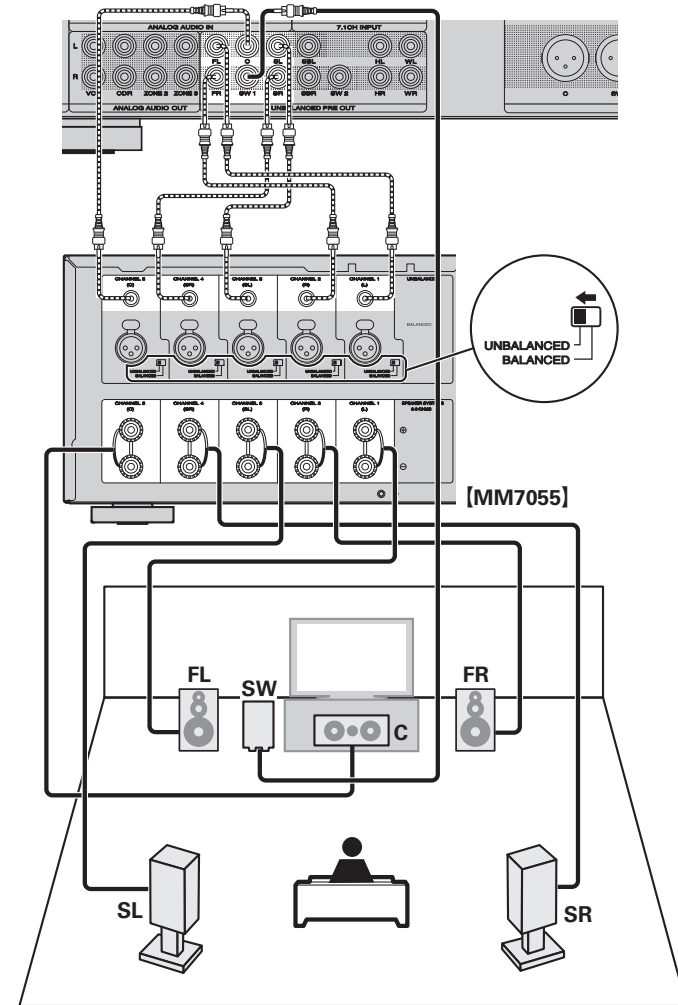

### Front A/B connection

A second set of front speakers can be connected to the UNBALANCED PRE OUT HL/HR terminals on the power amp. In this case, perform the settings using the **SPKR A/B** button on the remote control or main unit (see page 26 "Set the front speakers to be used").

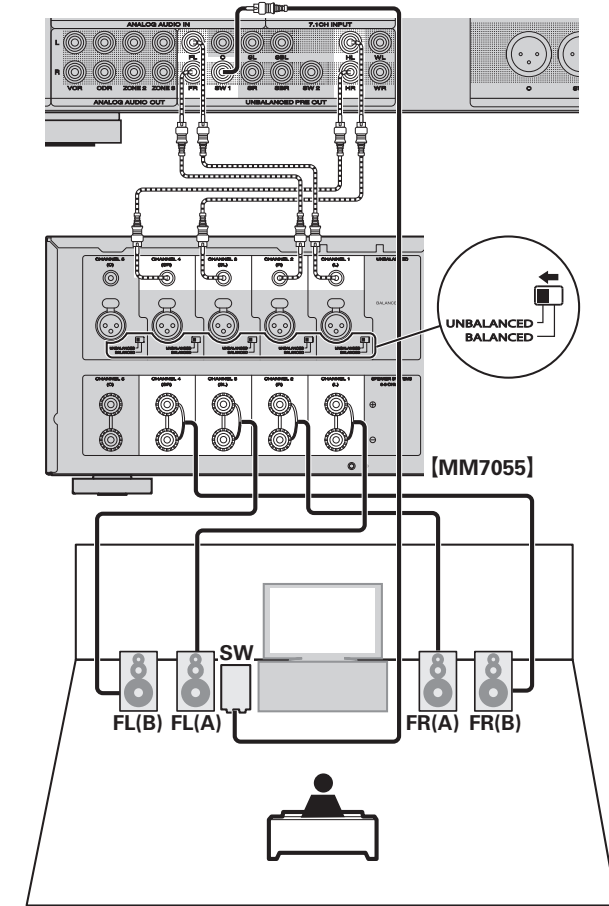

For surround playback of a multichannel source, if you connect the center speaker, surround speakers, surround back speakers (or front wide speakers) and subwoofers, 7.1-channel playback is available. Front speakers can be used separately, depending on the speaker's specifications or playback source such as front speakers (A) for multichannel playback and front speakers (B) for 2-channel playback.

### 2.1-channel connection

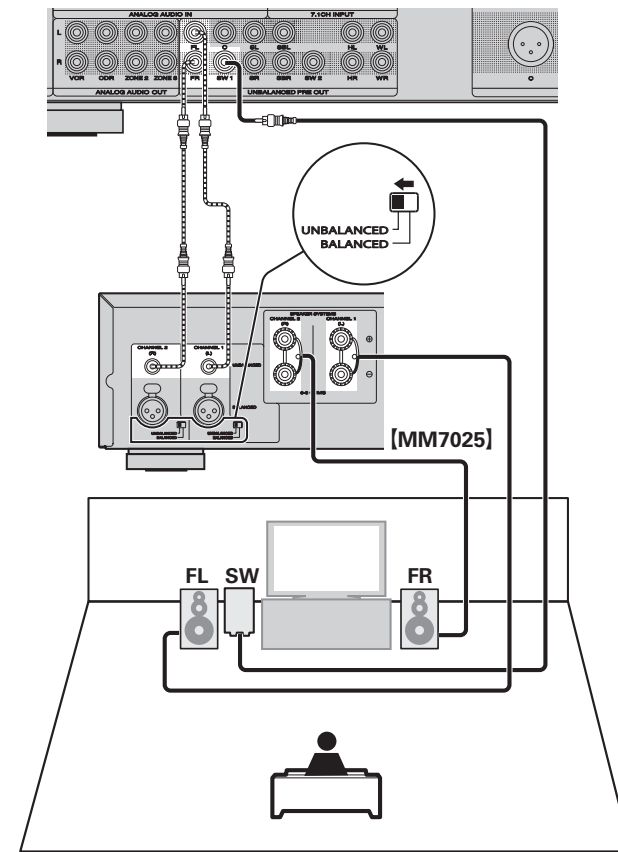

#### For connecting four subwoofers

Four subwoofers can be connected to this unit. The same signal is output from each subwoofer terminal.

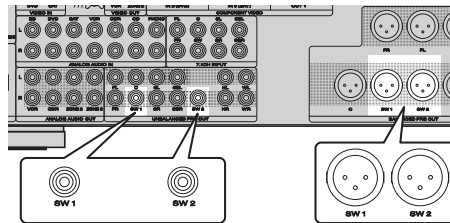

### Bi-Amp connection

A bi-amp connection is to connect separate amplifiers to the tweeter terminals and woofer terminals of speakers compatible with the bi-amp function. This prevents the back electromotive force (returned force without output) of the woofer sent to the tweeter, which affects the sound quality of the tweeter, and you can enjoy playback with higher-quality sound. In this case, set "Set up "Amp Assign"" (see page 52) to "SPKR-C".

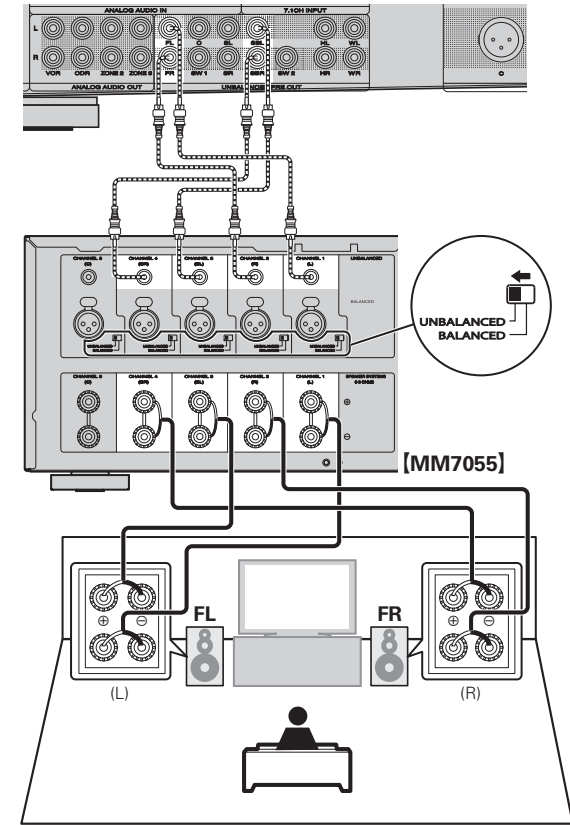

When a Bi-Amp connection is used, the same signal is output from the UNBALANCED and BALANCED PRE OUT FL/FR and SBL/SBR terminals. For surround playback of a multichannel source, if you connect the center speaker, surround speakers and subwoofers, 5.1-channel playback is available.

#### NOTE

- Use speakers compatible with bi-amp connections.
- When making bi-amp connections, be sure to remove the short-circuiting plate or wire between the speaker's woofer and tweeter terminals.

# Set up speakers

This section provides the setup methods of speaker systems other than the 7.1-channel system (with surround back speakers).

For the setup methods of the 7.1-channel system with surround back speakers, see "Simple version", "Set up speakers (Audyssey® Auto Setup)" (page 8) of "Simple version".

First install and connect the speakers to this unit.

Before Auto Setup measurement, the settings shown below can be made.

- Changing the amplifier assignment (Amp Assign)

The signal output from the UNBALANCED and BALANCED PRE OUT SBL/SBR terminals of this unit can be switched to match your speaker environment. (page 52 "Set up "Amp Assign"").

- Setting the channels to be used (Channel Select)

If channels that are not to be used are set in advance, measurement for the set channels is skipped, and measuring time can be reduced (page 52 "Set up "Channel Select"").

## Audio output from each PRE OUT terminal

	PRE OUT Channel						
UNBALANCED PRE OUT terminal	FL/FR	C	SW1/SW2	SL/SR	SBL/SBR	HL/HR	WL/WR
BALANCED PRE OUT terminal	FL/FR	C	SW1/SW2	SL/SR	SBL/SBR	---	---
Audio Output	Front A	Center	Subwoofer 1 / Subwoofer 2	Surround	Surround Back*	Front Height / Front B	Front Wide

\*The output audio differs depending on the "Amp Assign" settings.

## 1 Set up the remote control unit

- Set up the operation mode  
Press AMP to set the remote control unit to amplifier operation mode.

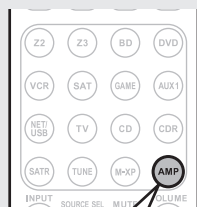

Press AMP

## 2 Connect the setup microphone.

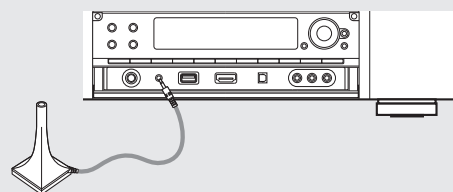

When the setup microphone is connected, the following screen is displayed.

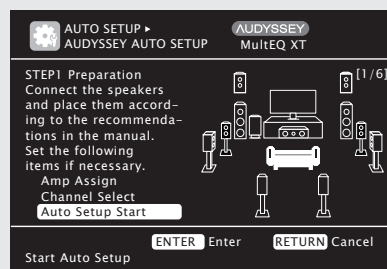

around items indicate the settings.

## 3 Set up "Amp Assign"

Use  $\Delta$ / $\nabla$  to select "Amp Assign", and then press ENTER.

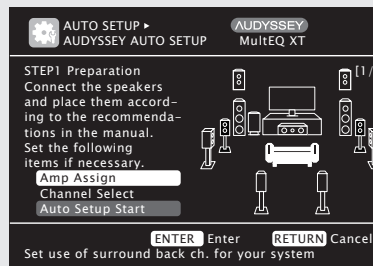

## 4 Use $\triangleleft$ / $\triangleright$ to select the configuration of the connected speakers, and then press RETURN.

- Normal** Set when using surround back, front height or front wide speakers. In this case, go to step 5.
- ZONE2** Set for connecting the speakers for ZONE2.
- ZONE3** Set for connecting the speakers for ZONE3.
- SPKR-C** Set for connecting the tweeter of the front speaker to the UNBALANCED and BALANCED PRE OUT SBL/SBR terminals of the power amp, and the woofer of the front speaker to the FL/FR terminals.

## 5 Set up "Channel Select"

Use  $\Delta$ / $\nabla$  to select "Channel Select", and then press ENTER.

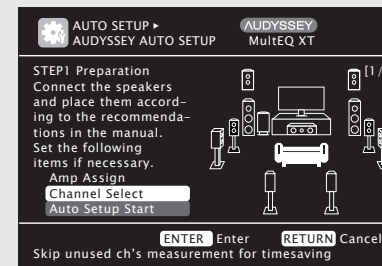

## 6 Use $\Delta$ / $\nabla$ to select a channel.

- Subwoofer** Select for no subwoofers to be used. In this case, go to step 7.
- Surround Back** Select for no surround back speakers to be used. In this case, go to step 8.
  - "Surround Back" can be set when "Amp Assign" is set to "Normal".
- Front Height** Select for no front height speakers to be used. In this case, go to step 9.
  - "Front Height" can be set when "Amp Assign" is set to "Normal".
- Front Wide** Select for no front wide speakers to be used. In this case, go to step 9.
  - "Front Wide" can be set when "Amp Assign" is set to "Normal".

## 7 [When "Subwoofer" is selected in step 6]

Use  $\triangleleft$ / $\triangleright$  to select the item.

- Measure** Set for measuring a subwoofer.
- Skip** Set for no measuring of a subwoofer.



Set up speakers

**8** [When "Surround Back" is selected in step 6]

Use ◀ ▶ to select the item.

**Measure (2spkr)** Set for measuring two surround back speakers.

**Measure (1spkr)** Set for measuring a surround back speaker.

**Skip** Set for no measuring of a surround back speaker.

**9** [When "Front Height" or "Front Wide" is selected in step 6]

Use ◀ ▶ to select the item.

**Measure** Set to measure the front height speakers or front wide speakers.

**Skip** Set when you do not want to measure the front height speakers or front wide speakers.

**10** Press RETURN.

Proceed to page 9 **STEP1 Preparation** step 5.

**NOTE**

After performing Audyssey® Auto Setup, do not change the speaker connections or subwoofer volume. In event of a change, perform Audyssey Auto Setup again.

# Connections (Advanced connection)

## REMOTE CONTROL jacks

When you use this unit connected to Marantz audio components, it sends operation signals to operate each component.

**Connection**

Use the remote connection cable (supplied with a Marantz audio component you want to connect) to connect the REMOTE CONTROL OUT terminal of this unit to the REMOTE CONTROL IN terminal of the component to be connected.

**Setting**

Set the remote control switch located on the rear panel of the connected audio component to "EXTERNAL" or "EXT." to use this feature.

- This setting will disable remote sensor reception of the connected audio component.
- To operate the connected audio component, point the remote control at the remote sensor of this unit.

Wireless receiver RX101 (page 23)

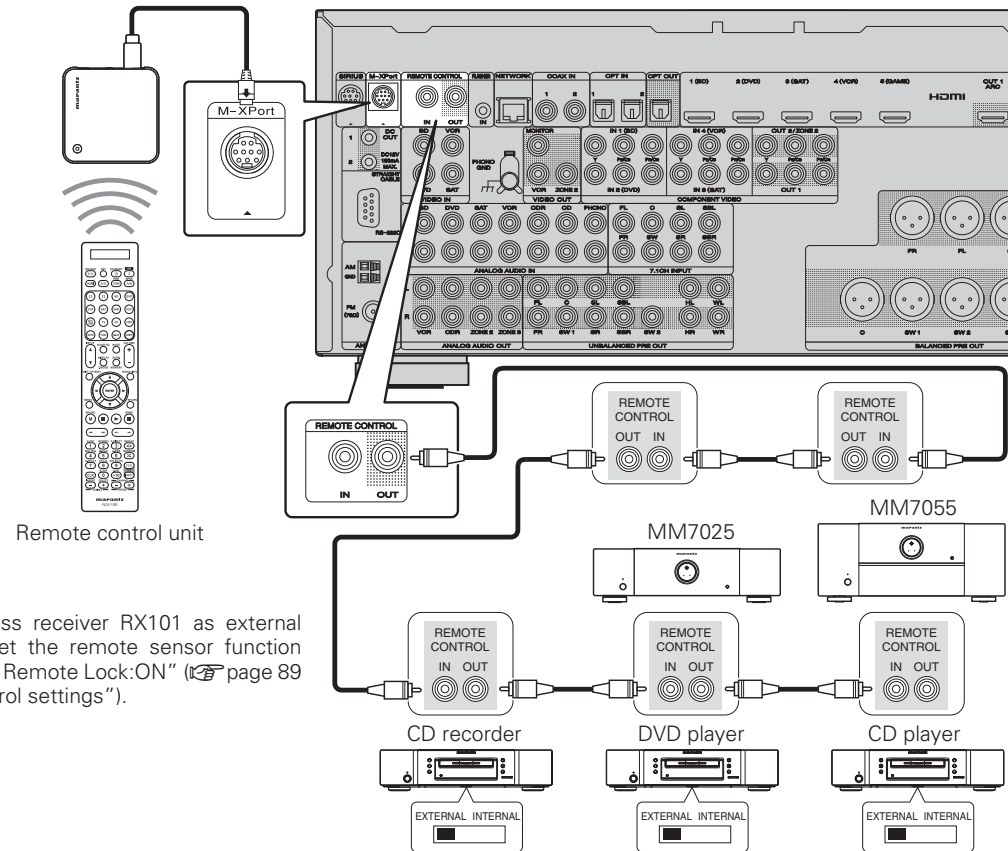

**NOTE**

To use wireless receiver RX101 as external IR receiver, set the remote sensor function of this unit to "Remote Lock:ON" (page 89 "Remote control settings").

Remote control operation buttons



Move the cursor (Up/Down/Left/Right)



Confirm the setting



Return to previous menu



## RS-232C connector

When you connect an external control device, you can control this unit with the external control device.

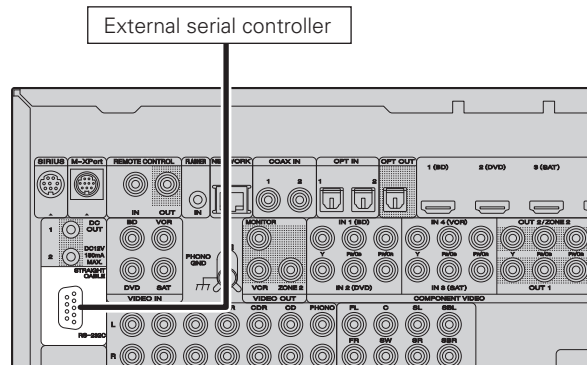

Perform the operation below beforehand.

- ① Turn on the power of this unit.
- ② Turn off the power of this unit from the external controller.
- ③ Check that the unit is in the standby mode.

## DC OUT (TRIGGER OUT) jacks

When a device with DC IN jack is connected, the connected device's power on/standby can be controlled through linked operation to this unit.

The DC OUT jack outputs a maximum 12 V/150 mA electrical signal.

12 V/150 mA trigger-compatible device

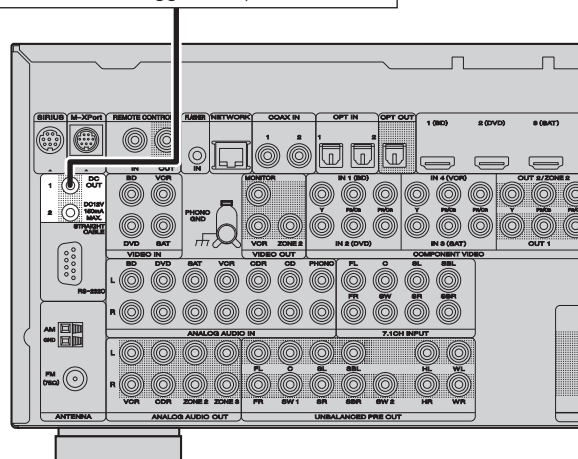

### in Set as Necessary

Set to change the conditions for linked operation via the DC OUT 1 or 2 jack.

**"Trigger Out 1"** or **"Trigger Out 2"** (page 85)

### NOTE

If the permissible trigger input level for the connected device is larger than 12V/150 mA, or has shorted, the DC OUT jack cannot be used. In this case, turn off the power to the unit, and disconnect it.

# Playback (Advanced operation)

## Playback (Basic operation) (👉 page 25)

## Selecting a listening mode (Surround mode) (👉 page 44)

- HDMI control function** (👉 page 55)
- Sleep timer function** (👉 page 56)
- Adjusting the volume of the speakers** (👉 page 56)
- Operating a wireless LAN-compatible mobile terminal to play music and still pictures** (👉 page 57)
- Web control function** (👉 page 58)
- Panel lock function** (👉 page 60)
- Various memory functions** (👉 page 60)

## Convenient functions

### HDMI control function

When you make an HDMI connection with a TV or player compatible with this unit and HDMI control functions, you can perform the following operations by setting the HDMI control function of each device.

- This unit power off can be linked to the TV power off step.**
- You can switch audio output devices with a TV operation.**  
When you set "Output audio from amp" in the TV audio output setup operation, you can switch the amp power on.
- You can adjust this unit volume in the TV volume adjustment operation.**
- You can switch this unit input sources through linkage to TV input switching.**
- When playing the player, this unit input source switches to the source for that player.**

#### NOTE

- The HDMI control function only supports the HDMI OUT 1 connector. To use the HDMI control function, connect the television to the HDMI OUT 1 connector.
- **When "HDMI Control" is set to "ON", it consumes more standby power.**
- The HDMI control function controls operations of a TV that is compatible with the HDMI control function. Make sure that the TV and HDMI are connected when you perform HDMI control.
- Some functions may not operate depending on the connected TV or player. Check the user guide of each device for details beforehand.
- When "Power Off Control" on the menu is set to "OFF" (👉 page 81), this unit is not set to standby even if the connected device is in the standby mode.
- When connection changes are implemented, such as adding connections to HDMI devices, linked operations may be initialized. In this case, you will need to reconfigure the settings.
- When "HDMI Control" is set to "ON", it is not possible to assign an HDMI connector to "TV" at "Input Assign" (👉 page 69).

### 1 Set the HDMI output connector corresponding with the HDMI control function.

Set "HDMI Control" (👉 page 80) to "ON".

### 2 Turn the power on for all the equipment connected by HDMI cable.

### 3 Set the HDMI control function for all equipment connected by HDMI cable.

- Please consult the operating instructions for the connected equipment to check the settings.
- Carry out steps 2 and 3 should any of the equipment be unplugged.

### 4 Switch the television input to the HDMI input connected to this unit.

### 5 Switch this unit input to the HDMI input source and check if the picture from the player is ok.

### 6 When you turn the TV's power to standby, check that the power of this unit also goes to standby.



If the HDMI control function does not operate properly, check the following points.

- Is the TV or player compatible with the HDMI control function?
- Is "HDMI Control" (👉 page 80) set to "ON"?
- Is "Power Off Control" (👉 page 81) set to "All" or "Video"?
- Are the HDMI control function settings of all equipment correct?
- Is the television connected to the HDMI OUT 1 connector?

#### NOTE

Should any of the operations below be performed, the interlocking function may be reset, in which case, repeat steps 2 and 3.

- "Input Assign" – "HDMI" (👉 page 69) setting has changed.
- "Monitor Out" (👉 page 80) setting is changed.
- There is a change to the connection between the equipment and the HDMI, or an increase in equipment.

## Convenient functions

## Sleep timer function

The power automatically goes into standby once the set time has elapsed.

This is convenient for playing sources while going to sleep.

**1** Press **AMP** to set the remote control unit to amplifier operation mode.

**2** Press **SLEEP** and display the time you want to set.

The **SLEEP** indicator on the display lights.

- If **SLLEP** on the main unit is pressed, the same function as with the remote control unit can be obtained.

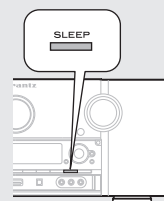

- The time switches as shown below each time **SLEEP** is pressed.

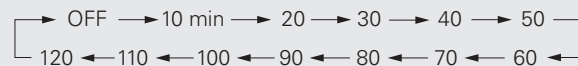

## To cancel the sleep timer

Press **SLEEP** to set "OFF".

The **SLEEP** indicator on the display turns off.



- The sleep timer setting is canceled if this unit's power is set to standby or turned off.
- When power to the main zone is turned off with the sleep timer, power in ZONE2 and ZONE3 are also turned off.

## Adjusting the volume of the speakers

You can adjust the channel level either according to the playback sources or to suit your taste, as described below.

## Adjusting the volume of the different speakers

**1** Press **AMP** to set the remote control unit to amplifier operation mode.

**2** Press **CH LVL**.

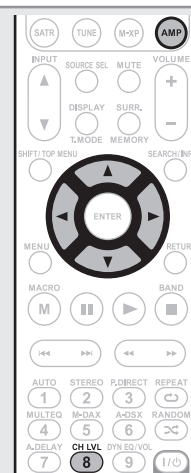
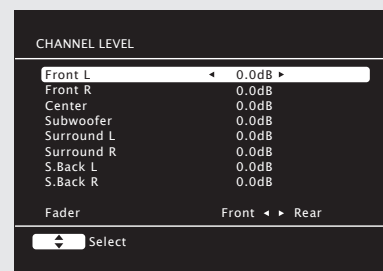

**3** Use  $\Delta$ / $\nabla$  to select the speaker.

The speaker that can be set switches each time one of the buttons is pressed.

**4** Use  $\triangleleft$ / $\triangleright$  to adjust the volume.

- In the case of a subwoofer, pressing  $\triangleleft$  when it is at "-12 dB" will change the setting to "OFF".



- When a headphone jack is inserted, the headphone channel level can be adjusted.
- When the input mode setting is "7.1CH IN", you can adjust the channel level while the 7.1CH INPUT connector is being used. In that case, "7.1CH IN Level" appears at the top of the screen.

## Adjusting the volume of groups of speakers (Fader function)

This function lets you adjust (fade) the sound all at once from the front (front speaker / front height speaker / front wide speaker / center speaker) or rear (surround speaker / surround back speaker).

**1** Press **AMP** to set the remote control unit to amplifier operation mode.

**2** Press **CH LVL**.

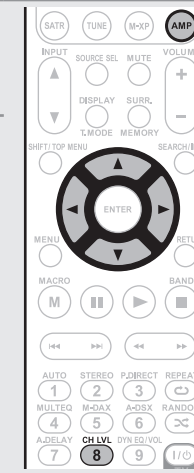
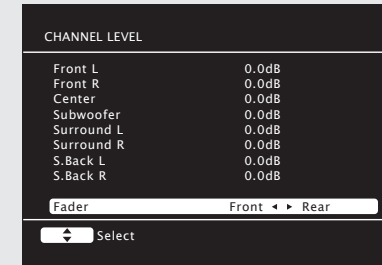

**3** Press  $\nabla$  to select "Fader", then select the item to be adjusting using  $\triangleleft$ / $\triangleright$ .

**4** Use  $\triangleleft$ / $\triangleright$  to adjust the volume of the speakers. ( $\triangleleft$ : front,  $\triangleright$ : rear)



- The fader function does not affect the subwoofer.
- The fader can be adjusted until the volume of the speaker is adjusted to the lowest value of -12 dB.

## Operating a wireless LAN-compatible mobile terminal to play music and still pictures

- Perform this procedure using a wireless LAN-compatible mobile terminal conforming to the DLNA (Digital Living Network Alliance) standard.
- This function allows you to play content located on a computer (media server) or mobile terminal device connected on a network by operating a mobile terminal device on the same network.
- There are two types of operations on the mobile terminal device.

### □ Playing content on a computer (Media server)

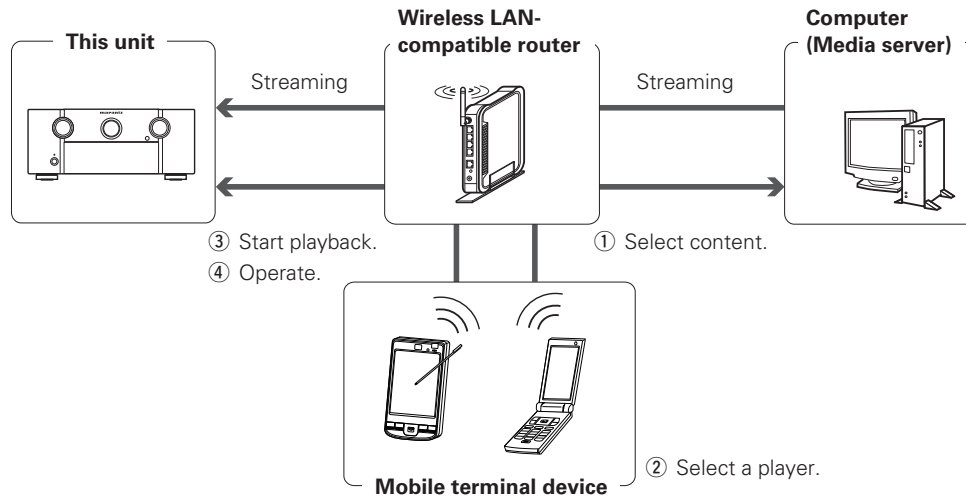

**1 From the mobile terminal device, browse the media server on the same network and choose the content you want to play.**

**2 From the mobile terminal device, select this unit from among the products on the network.**

Playback of the content selected in step 1 begins.

- When selecting this unit from the mobile terminal device, the name of this unit is displayed at "Friendly Name" (☞ page 82 "Friendly Name Edit").
- The following operations are possible from the mobile terminal device:
  - File operations (play, stop, pause, track search)
  - Volume adjustment

### □ Playing contents on a mobile terminal device

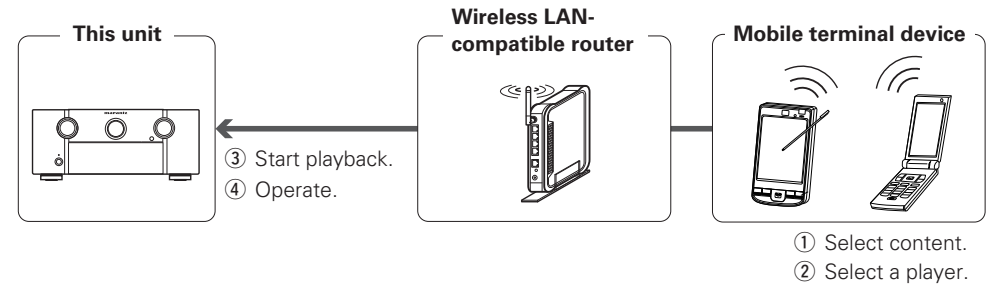

**1 Select the content you want to play from among the mobile terminal devices.**

**2 From the mobile terminal device, select this unit from among the products on the network.**

Playback of the content selected in step 1 begins.

- When selecting this unit from the mobile terminal device, the name of this unit is displayed at "Friendly Name" (☞ page 82 "Friendly Name Edit").
- The following operations are possible from the mobile terminal device:
  - File operations (play, stop, pause, track search)
  - Volume adjustment



-  is displayed on the menu screen while the mobile terminal device is being operated.

- For the various settings and operating procedures, see the operating instructions of the mobile terminal devices being used.
- When selecting this unit from the mobile terminal device, the name of this unit is displayed at "Friendly Name". "Friendly Name" can be edited at "Friendly Name Edit" (☞ page 82) as desired so that it is easily distinguishable from other devices.
- When playback is started from the mobile terminal device, this unit's input source automatically switches to "NET/USB". Also, when the "Network Standby" setting (☞ page 82) is set to "ON", the power automatically turns on.

**NOTE**

When operations related to browsing or playback (play, stop, pause, track search) are performed on this unit while operating the mobile terminal device, the connection to the network is disconnected.

## Convenient functions

## Web control function

You can operate this unit using a browser.

**1** Switch the “Network Standby” setting to “ON”.  
(☞ page 82).

**2** Check the IP address of this unit with “Network Information” (☞ page 83).

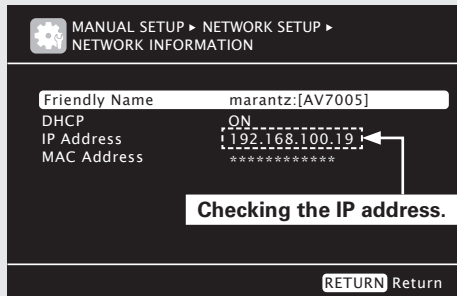

**3** Enter the IP address of this unit in browser’s address box.

For example, if the IP address of this unit is “192.168.100.19”, enter “http://192.168.100.19”.

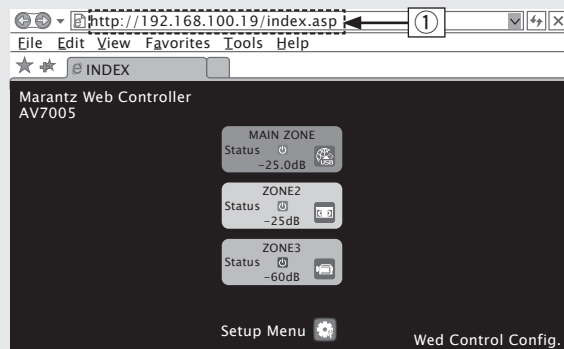

① Entering the IP address.

**4** When the top menu is displayed, click on the menu item you want to operate.

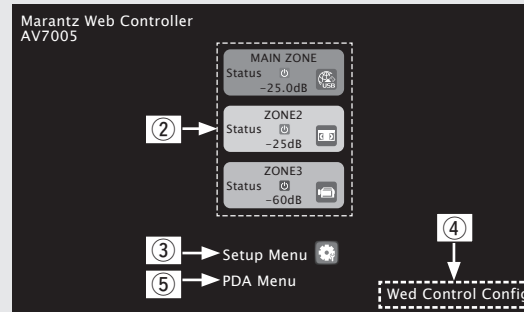

- ② Click when you operate each zone. (☞ [Example 1])
- ③ Click when you operate the setup menu. (☞ [Example 2])
- ④ Click to change the Web control screen setting.  
(☞ [Example 3])
- ⑤ Click when you operate a small screen such as a PDA screen,  
etc. (☞ [Example 4])

**5** Operate.

[Example 1] Main zone control screen

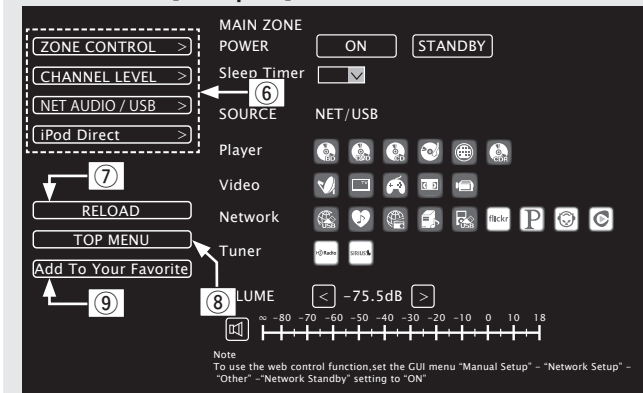

- ⑥ Click to perform individual operations.  
Changes to individual operation screens. (☞ [Example 5])
- ⑦ Click when you update to the latest information.  
Normally, there is a change to the latest information each time you operate. When operating from the main unit, click this or else the screen will not be updated.
- ⑧ Click to return to the top menu.  
Displayed when setting “Top Menu Link Setup” to “ON” in [Example 3]
- ⑨ Click to add a setting to “Favorites” in your browser.  
We recommend registering the setting screens for the different zones in the browser’s favorites so as not to accidentally perform menu operations for zones you do not intend to operate.

**[Example 2]** Setup menu screen

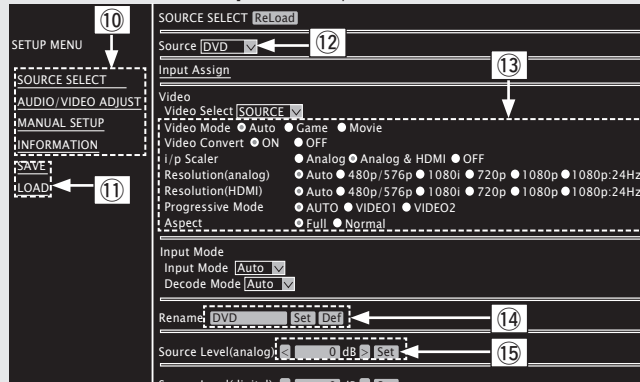

- 10 Click the menu item from which you want to make settings.  
The display on the right becomes the individual setting screens.
- 11 Click "SAVE" when you want to save settings, and click "LOAD" when you want to call settings.
- 12 Click "v" and select from the displayed items.
- 13 Click an item to make a setting.
- 14 After entering characters, click "Set" to set, or click "Def" to return to default setting.
- 15 Enter figures or click "<" or ">" to make the setting, and then click "Set".

**[Example 3]** Web configuration screen

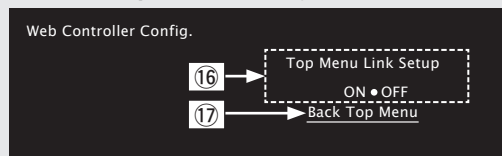

- 16 Click "ON" when performing Top Menu Link Setup.  
When set up, return to the top menu from each operation screen.  
(Default setting : "OFF")
- 17 Click this item to return to the top menu.

**[Example 4]** PDA menu screen

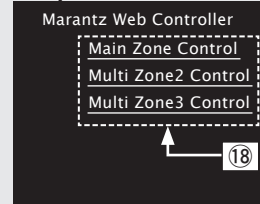

- 18 Select this item to operate each zone.

**NOTE**

You cannot change setup menu operations and zone name on the PDA menu screen.

**[Example 5]** Net Audio operating screen

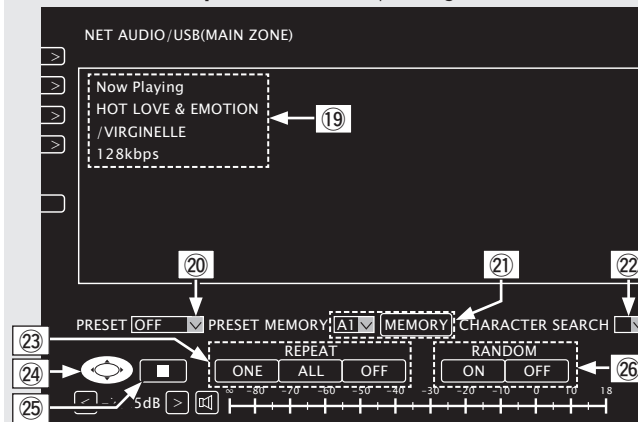

- 19 Click the menu items from which you want to play.
- 20 Click "v" to select the preset channel you want to play.
- 21 When registering presets, click "v" to select the channel you want to register, and then click "MEMORY".
- 22 When searching using an acronym, click "v" and select from the displayed characters.
- 23 Click this item to play back repeatedly.
- 24 Click this item when selecting menu items.
- 25 Click to stop playback.
- 26 Click this item to play back randomly.

**[Example 6]** Dedicated iPod Touch screen

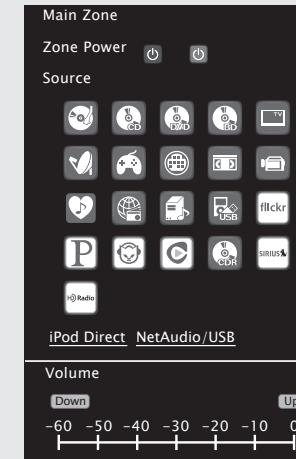

- When accessed from the iPod Touch browser, an optimized operation screen is displayed.



## Convenient functions

## Panel lock function

To prevent accidental operation of this unit, you can disable operation of the buttons on the front panel.

## ❑ Disabling all key button operations

ON/STANDBY

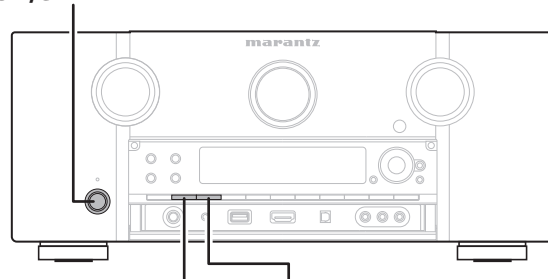

AUTO DISPLAY

Press **ON/STANDBY** while you press and hold **AUTO** and **DISPLAY** with the unit in standby mode.

"Panel Lock:ON" appears on the display and all button operations except **ON/STANDBY** are disabled.

## ❑ Disabling all button operations except VOLUME

ON/STANDBY

VOLUME

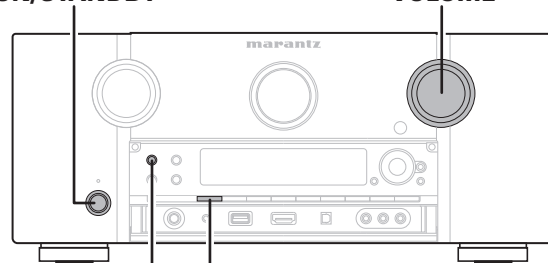

PURE DIRECT DISPLAY

Press **ON/STANDBY** while you press and hold **PURE DIRECT** and **DISPLAY** with the unit in standby mode.

"Panel Lock:ON" appears on the display and all button operations except **ON/STANDBY** and **VOLUME** are disabled.

## ❑ Canceling the Panel lock function

ON/STANDBY

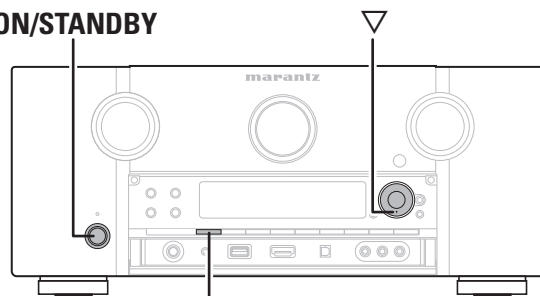

DISPLAY

Press **ON/STANDBY** while you press and hold **▽** and **DISPLAY** with the unit in standby mode.

The Panel lock function is canceled.



Even when the Panel lock function is set, you can operate the unit using the remote control unit.

## Various memory functions

## ❑ Personal memory plus function

This function sets the settings (input mode, surround mode, HDMI output mode, MultEQ® XT, Dynamic EQ®, Dynamic Volume®, audio delay etc.) last selected for the individual input sources.



The surround parameters, tone settings and the volumes of the different speakers are stored for the individual surround modes.

## ❑ Last function memory

This function stores the settings which were made before going into the standby mode.

When the power is turned back on, the settings are restored.

# Playback in ZONE2/ZONE3 (Separate room)

- You can operate this unit so as to enjoy audio in a room (ZONE2, ZONE3) other than the MAIN ZONE (room where the unit is located).
- You can simultaneously play back the same source in both the MAIN ZONE, ZONE2 and ZONE3. You can also play back separate sources in the MAIN ZONE, ZONE2 and ZONE3.

## Audio output

There are two methods to do this, as described below. Choose one of the methods.

- ① Zone playback by audio output (UNBALANCED and BALANCED)
- ② Zone playback by audio output (PRE OUT)  
Use an external amplifier.

### ① Zone playback by audio output (UNBALANCED and BALANCED)

Using the amplifier assign function, zone 2 and zone 3 auto signals are output from this unit's UNBALANCED and BALANCED PRE OUT SBL/SBR terminals.

#### ❑ Connecting and setting the speakers (Example of connections to Marantz MM7025 power amp)

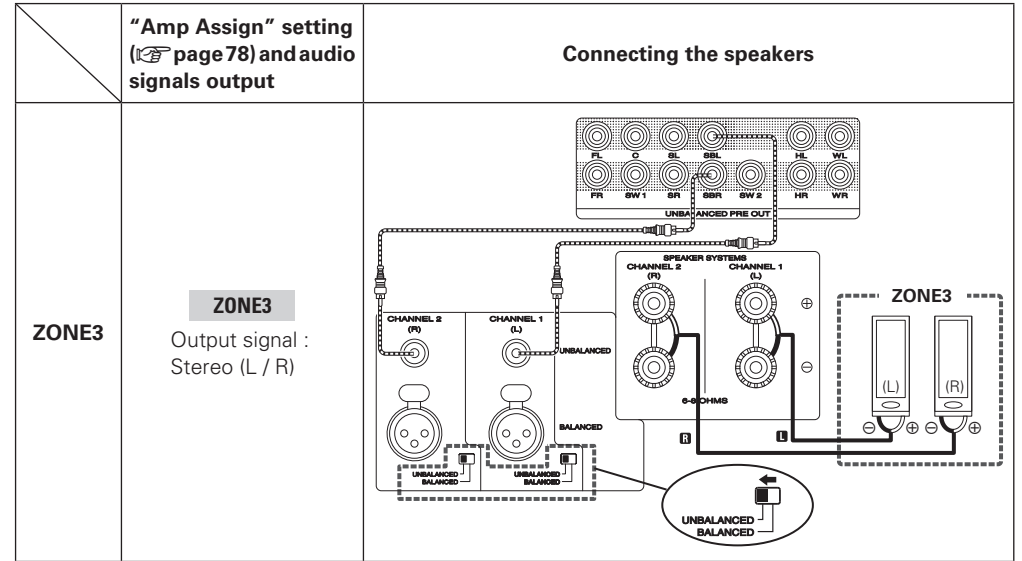
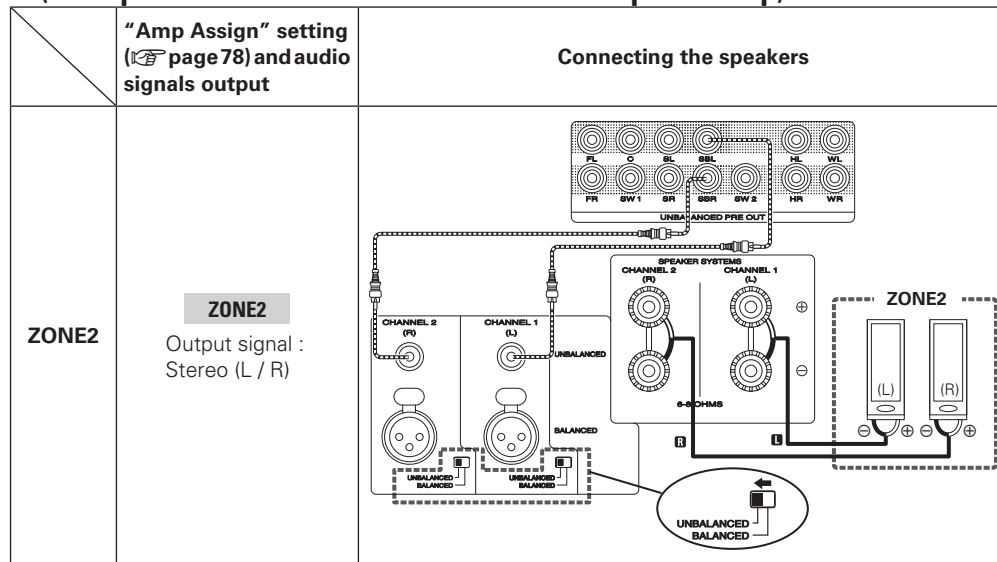

### ② Zone playback by audio output (PRE OUT)

#### ❑ Audio connections (ZONE2, ZONE3)

The audio signals of this unit's ZONE2 and ZONE3 audio output terminals are output to the ZONE2 and ZONE3 amplifiers and played on these amplifiers.

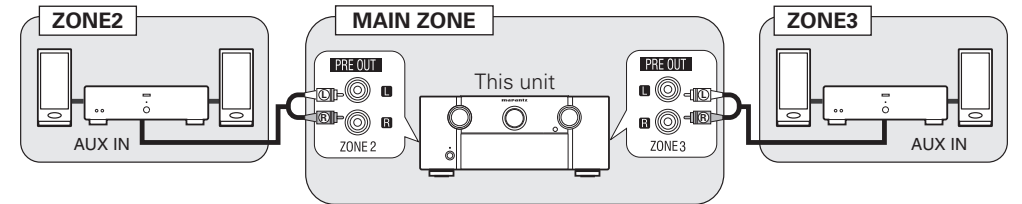

We recommend using high quality pin-plug cables for audio connections in order to prevent noise.

#### NOTE

- When the input source to which the digital input connectors (OPTICAL/COAXIAL) are assigned is selected in ZONE2 or ZONE3, playback is only possible if the digital signal being input is in PCM (2-channel) format.
- It is not possible to play the digital audio signals input from the HDMI terminals in ZONE2 and ZONE3. Use analog connections for ZONE2 or ZONE3 playback.
- When certain digital signals are being input, noise may be output from the ZONE2 and ZONE3 audio output connectors.
- The menu screen is not output.

## Video output

### Video Connection

The video signals of this unit's ZONE2 video output terminal are played by the ZONE2 TV.

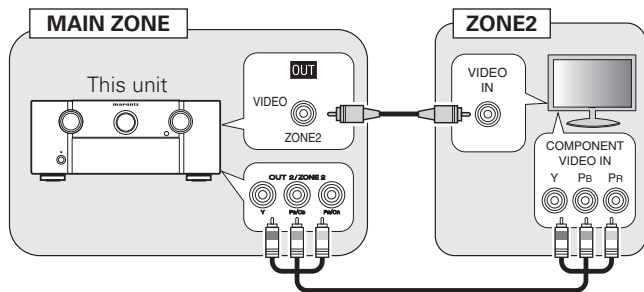

#### NOTE

- It is not possible to output video signals input to the HDMI terminals to ZONE2.
- When using component output terminal 2 for ZONE2 video signal output, set "Manual Setup" – "Option Setup" – "Component2 Output" (page 85) in the menu to "ZONE2".
- The menu screen is not output.

## Playback

### 1 Press Z2 or Z3 to switch the remote control operating mode.

The remote control unit switches to the operating mode for ZONE2 or ZONE3.

### 2 Press ON to turn on the ZONE2 or ZONE3 power.

The Z2 or Z3 indicator on the display lights.

- When **STANDBY** is pressed, ZONE2 or ZONE3 turns off.
- Power in ZONE2 or ZONE3 can be turned on or off by pressing **SOURCE ON/OFF**.
- Power in ZONE2 or ZONE3 can be turned on or off by pressing **ZONE2 ON/OFF** or **ZONE3 ON/OFF** on the main unit.

### 3 Press INPUT ▲▼.

The audio signal of the selected source is output to ZONE2 or ZONE3.

- Turn **INPUT SELECTOR** after pressing **ZONE SELECT** on the main unit to select an input source.

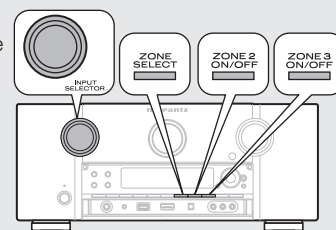

When power for both MAIN ZONE and ZONE2 is set to ON, power of the MAIN ZONE only can be turned off. Select "AMP" in step 1 then press **STANDBY**.



### Adjusting the volume

Use **VOLUME** to adjust the volume.

**[Adjustable range]** --- -80dB --40dB -18dB

(When the "Volume Display" (page 84) setting is "Relative")

**[Adjustable range]** 0 - 41 - 99

(When the "Volume Display" (page 84) setting is "Absolute")

- At time of purchase, "Volume Limit" (page 83) is set to "-10dB (71)".



Turn **VOLUME** after pressing **ZONE SELECT** on the main unit to adjust the sound volume.

### Turning off the sound temporarily

Press **MUTE**.

The sound is reduced to the level set at "Mute Level" (page 84) in the menu.

- To cancel, either adjust the volume or press **MUTE** again.
- The setting is canceled when the zone's power is turned off.



You can adjust the tone and volume for ZONE2 and ZONE3 in "Zone Setup" (page 83) in the menu.

# How to make detailed settings

## Menu map

For menu operation, connect a TV to this unit and display the menu on the TV screen. For menu operations, see the following page.

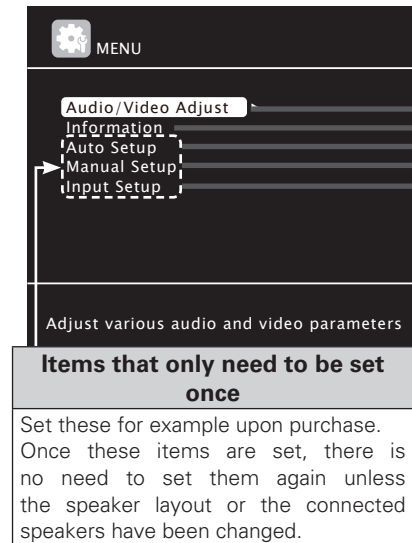

Setting items	Detailed items	Description	Page
<b>1. Audio/Video Adjust</b> AUDIO/VIDEO ADJUST Audio Adjust Picture Adjust	<b>Audio Adjust</b>	Adjusts various audio parameters.	73
	<b>Picture Adjust</b>	Adjusts the picture quality.	77
<b>2. Information</b> INFORMATION Status Audio Input Signal HDMI Information Preset Channel	<b>Status</b>	Shows information about current settings.	88
	<b>Audio Input Signal</b>	Shows information about audio input signals.	88
	<b>HDMI Information</b>	Displays the HDMI input/output signals and HDMI monitor information.	88
	<b>Preset Channel</b>	Shows information about tuner or network preset channels.	88
<b>3. Auto Setup</b> AUTO SETUP Audyssey Auto Setup Parameter Check	<b>Audyssey Auto Setup</b>	Makes the optimum settings for the speakers being used automatically.	8
	<b>Parameter Check</b>	Checks Audyssey® Auto Setup measurement results. This item is only displayed after Audyssey Auto Setup procedure has been performed.	12
<b>4. Manual Setup</b> MANUAL SETUP Speaker Setup HDMI Setup Audio Setup Network Setup Zone Setup Option Setup	<b>Speaker Setup</b>	Sets the speaker size and distance, the channel level, etc.	78
	<b>HDMI Setup</b>	Makes settings for HDMI video/audio output.	80
	<b>Audio Setup</b>	Makes settings for audio playback.	81
	<b>Network Setup</b>	Makes network settings.	81
	<b>Zone Setup</b>	Makes settings for audio playback in a multi-zone (ZONE2/ZONE3) system.	83
<b>5. Input Setup</b> (Example: "HD Radio") INPUT SETUP Auto Preset Preset Skip Preset Name Video Rename Source Level	<b>Option Setup</b>	Makes various other settings.	84
	<b>Auto Preset</b>	Uses the auto preset function to program radio stations.	67
	<b>Preset Skip</b>	Sets the preset memories that you do not want to display when tuning.	67
	<b>Parental Lock</b>	Sets the Parental Lock.	67
	<b>Antenna Aiming</b>	Adjusts the SIRIUS reception sensitivity.	68
	<b>Preset Name</b>	Assigns name to a preset memory.	68
	<b>Input Assign</b>	Changes input connector assignment.	68
	<b>Video</b>	Makes the video settings.	69
	<b>Input Mode</b>	Sets the audio input mode and decode mode.	71
	<b>Rename</b>	Changes the display name for this source.	71
<b>Source Level</b>	Adjusts the playback level of the audio input.	71	
<b>Playback Mode</b>	Makes settings for iPod, USB memory device or network source playback.	71	
<b>Still Picture</b>	Makes settings for still picture playback.	72	

Displayed items of the "Input Setup" menu differs, depending on the selected input source.

# Examples of menu and front display

Below we describe typical examples of displays on the TV screen and on the set's display window.

	Menu display	Front display	Description
<b>Top menu display</b>			<ol style="list-style-type: none"> <li>The menu items are displayed here.</li> <li>The selected line is displayed here. The currently selected item is displayed on the display. Use <math>\Delta \nabla</math> to move to the item you want to set.</li> </ol>
<b>Display when changing settings</b>			<ol style="list-style-type: none"> <li>Use <math>\Delta \nabla \triangleleft \triangleright</math> to move to the item you want to set.</li> <li>Press <b>ENTER</b> to set to the mode in which the setting can be made.</li> <li>"<math>\triangleleft</math>" and "<math>\triangleright</math>" is displayed at the sides of item whose setting can be changed. Use <math>\triangleleft \triangleright</math> to change to the desired setting.</li> </ol>
<b>Display when inputting characters</b>			<ol style="list-style-type: none"> <li>When <math>\triangleleft \triangleright</math> is pressed, the cursor moves to the left or right.</li> <li>When <math>\Delta \nabla</math> is pressed at the position where you want to input the character, the character is input.</li> </ol> <p> For inputting characters on a keyboard screen or with the number buttons on the remote control unit, see page 65.</p>
<b>Display when resetting</b>			<ol style="list-style-type: none"> <li>Press <math>\nabla</math> to select "Default", then press <b>ENTER</b> to set.</li> <li>Press <math>\triangleleft</math> to select "Yes", then press <b>ENTER</b>.</li> </ol>

# Inputting characters

You can change the names as desired using the "Preset Name" (page 68), "Rename" (page 71), "RhapsodyAccount" (page 83), "Napster Account" (page 83), "Zone Rename" (page 85) and character input for the network functions.

For inputting characters, there are three methods, as shown below.

## Method for inputting characters

Method	Operations
Using the cursor buttons (Normal screen)	<ul style="list-style-type: none"> <li>Operating with the remote control unit or the main unit.</li> <li>Use <math>\Delta</math> <math>\nabla</math> <math>\triangleleft</math> <math>\triangleright</math> and <b>ENTER</b> to input characters.</li> </ul>
Using the keyboard screen	<ul style="list-style-type: none"> <li>Operating with the remote control unit.</li> <li>Select a character on the TV screen to input characters.</li> </ul>

## Normal screen

### Display of a normal input screen

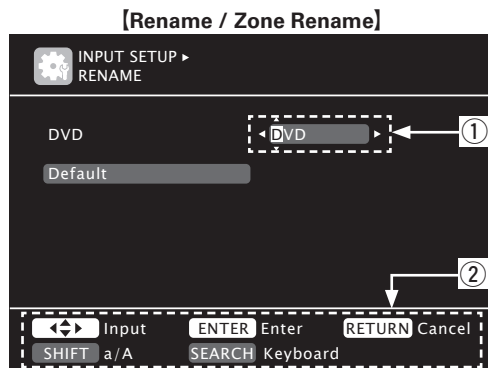

### [Account input / Search by text / Proxy Name / Friendly Name Edit]

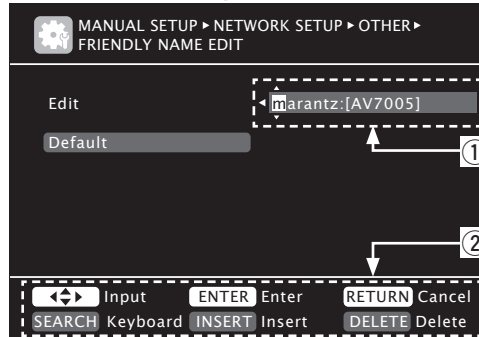

- ① Character input section
- ② Guide for operation buttons

### Using the cursor buttons

- 1 Display the screen for inputting characters (page 63 "Menu map").
- 2 Use  $\triangleleft$   $\triangleright$  to set the cursor to the character you want to change.
- 3 Use  $\Delta$   $\nabla$  to change the character, then press **ENTER**.
  - The types of characters that can be input are as shown below.

**[Upper case characters]**  
 ABCDEFGHIJKLMNOPQRSTUVWXYZ  
**[Lower case characters]**  
 abcdefghijklmnopqrstuvwxyz  
**[Symbols]** ! " # \$ % & ' ( ) \* + , - . / : ; < = > ? @ [ \ ] ^ \_ ` { | } ~  
**[Numbers]** 0 1 2 3 4 5 6 7 8 9 (Space)

  - The input character type can be switched by pressing **SHIFT/TOP MENU** while the display name is being changed.
- 4 Repeat steps 2 and 3 to change the name then press **ENTER** to register it.

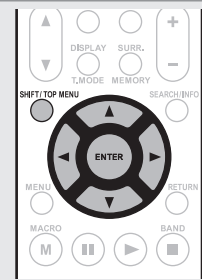

## Keyboard screen

### Display of a keyboard input screen

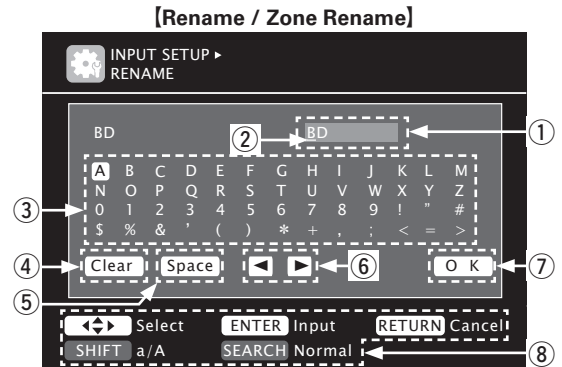

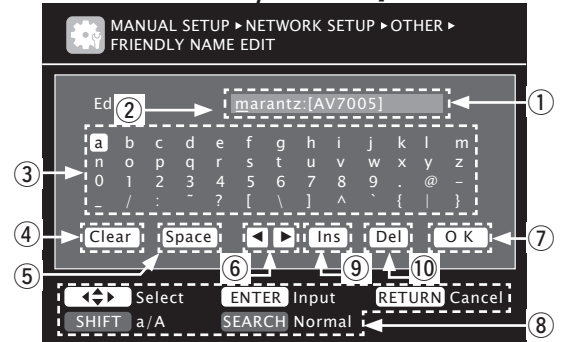

### [Account input / Search by text / Proxy Name / Friendly Name Edit]



- ① Character input section
- ② Cursor
- ③ Keyboard section
- ④ Clear key
- ⑤ Space key
- ⑥ Cursor keys
- ⑦ OK key
- ⑧ Guide for operation buttons
- ⑨ Insert key
- ⑩ Delete key



## Inputting characters

- 1** Display the screen for inputting characters (☞ page 63 “Menu map”).
- 2** Press **SEARCH/INFO** while a normal screen is displayed.  
A keyboard screen is displayed.
- 3** Select a character to be changed.
  - ① Press  $\Delta \nabla \triangleleft \triangleright$  to select  or .
  - ② Press **ENTER** to place the cursor at the character to be changed.  
Each time **ENTER** is pressed, the cursor moves by one character.
- 4** Select a character to be input with  $\Delta \nabla \triangleleft \triangleright$  then press **ENTER**.
  - The types of characters that can be input are as shown below.

**[Upper case characters/Numbers/Symbols]**  
 ABCDEFGHIJKLMNOPQRSTUVWXYZ  
 0123456789  
 ! " # \$ % & ' ( ) \* + , ; < = >

**[Lower case characters/Numbers/Symbols]**  
 abcdefghijklmnopqrstuvwxyz  
 0123456789  
 . @ \_ - / : ; ~ ? [ \ ] ^ ` { | }

  - The input character type can be switched by pressing **SHIFT/TOP MENU** while the display name is being changed.
- 5** Repeat steps 3 and 4 to change the name.
- 6** Use  $\Delta \nabla \triangleleft \triangleright$  to select , then press **ENTER**.

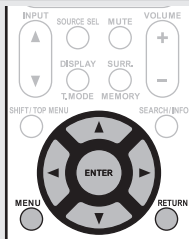

## Input Setup

Perform settings related to input source playback.

- You do not have to change the settings to use the unit. Make settings when needed.

## Menu operation

- 1** Press **AMP** to set the remote control unit to amplifier operation mode.
- 2** Press **MENU**.  
The menu is displayed on the TV screen.
- 3** Use  $\Delta \nabla$  to select the menu to be set or operated.
- 4** Press **ENTER** or  $\triangleright$  to enter the setting.
  - To return to the previous item, press **RETURN**.
  - Exiting the Menu, press **MENU** while the menu is displayed.  
The menu display disappears.

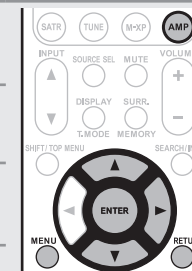

## Important information

 About the display of input sources

In this section, the configurable input sources for each item are shown as follows.



## NOTE

Input sources that have been set to “Delete” at “Source Delete” (☞ page 84) cannot be selected.



## Items that can be set with the Input Setup procedure

<p><b>Auto Preset</b> (page 67)</p>	<p><b>Preset Skip</b> (page 67)</p>	<p><b>Parental Lock</b> (page 67)</p>
<p><b>Antenna Aiming</b> (page 68)</p>	<p><b>Preset Name</b> (page 68)</p>	<p><b>Input Assign</b> (page 68)</p>
<p><b>Video</b> (page 69)</p>	<p><b>Input Mode</b> (page 71)</p>	<p><b>Rename</b> (page 71)</p>
<p><b>Source Level</b> (page 71)</p>	<p><b>Playback Mode</b> (page 71)</p>	<p><b>Still Picture</b> (page 72)</p>

## Auto Preset

Use the auto preset function to program radio stations.

Setting items	Setting details
<p><b>Start</b></p> <p>Start the auto preset process.</p> <p><b>HD Radio</b></p>	<p>If an FM station cannot be preset automatically, select the desired station by tuning it in manually, then preset it manually.</p>

## Preset Skip

Set preset channel to be skipped when selecting.

Setting items	Setting details
<p><b>A - G</b></p> <p>Set the preset channels you do not want to display. You can set by preset memory block (A to G) or by preset channel (1 to 8).</p> <p><b>SIRIUS</b> <b>HD Radio</b></p>	<p><b>1 - 8</b> : Set by individual preset channels in the currently selected preset memory block.</p> <ul style="list-style-type: none"> <li><b>ON</b> : Display the selected preset channel.</li> <li><b>Skip</b> : Do not display the selected preset channel.</li> </ul> <p>If you set "Block Presets" to "Skip", you can skip the preset memory blocks (A to G).</p>

## Parental Lock

For any channel, set the radio reception limits.

Setting items	Setting details
<p><b>Lock Setting</b></p> <p>Set the channel radio reception limits.</p> <p><b>SIRIUS</b></p>	<p>1. Press <math>\Delta \nabla</math> to select "Lock Setting", and then press <math>\triangleright</math> or <b>ENTER</b>.</p> <p>2. Pressing <math>\Delta \nabla \triangleleft \triangleright</math>, input the password (4 digits number) and press <b>ENTER</b>.</p> <p>3. Select channel by pressing <math>\Delta \nabla</math>, and set the lock by pressing <math>\triangleleft \triangleright</math>.</p> <p><b>Unlock</b> : Do not lock selected channel(s).</p> <p><b>Lock</b> : Lock selected channel(s). When a Parental Locked channel is tuned, "Enter Lock Code" is displayed, then input the password.</p> <ul style="list-style-type: none"> <li>The default password is "0000".</li> <li>If the password is wrong, "Lock Code is incorrect" is displayed. Input the correct password.</li> <li>While listening to the channel being played, you can also set parental lock (page 32).</li> </ul>















### Input Setup

Setting items	Setting details
<b>Edit Lock Code</b> Change the password. <b>SIRIUS</b>	<ol style="list-style-type: none"> <li>Press <math>\Delta \nabla</math> to select "Edit Lock Code", and then press <math>\triangleright</math> or <b>ENTER</b>.</li> <li>Input current lock code (4 digits) using <math>\Delta \nabla \triangleleft \triangleright</math>, and press <b>ENTER</b>.</li> <li>Input new lock code (4 digits) using <math>\Delta \nabla \triangleleft \triangleright</math>, and press <b>ENTER</b>.</li> <li>Input new lock code (4 digits) again using <math>\Delta \nabla \triangleleft \triangleright</math>, and press <b>ENTER</b>.</li> <li>Press <math>\Delta \nabla</math> to select "Execute", and then press <b>ENTER</b>.                      If the correct password is input, "Completed" is displayed, and the new password is modified.</li> </ol> <p> If the old password is incorrectly input, "Current Lock Code is incorrect" is displayed, and proceed again from step 1.</p> <p>If the password input is 3 digits or less, "Enter 4 digits number" is displayed, and input again with a 4 digit password.</p> <p>If the new password is not correctly input, "New Lock Codes do not Match" is displayed and the password does not change.</p>

### Antenna Aiming

Install the antenna with radio reception sensitivity set to maximum.

Setting items	Setting details											
<b>Satellite</b> Indicate satellite signal strength. <b>SIRIUS</b>	<table border="1"> <thead> <tr> <th>Display</th> <th>Condition</th> </tr> </thead> <tbody> <tr> <td></td> <td>Signal strength is excellent</td> </tr> <tr> <td></td> <td>Signal strength is good</td> </tr> <tr> <td></td> <td>Signal strength is weak</td> </tr> <tr> <td></td> <td>No signal</td> </tr> </tbody> </table>	Display	Condition		Signal strength is excellent		Signal strength is good		Signal strength is weak		No signal	
Display	Condition											
	Signal strength is excellent											
	Signal strength is good											
	Signal strength is weak											
	No signal											
<b>Terrestrial</b> Indicate terrestrial signal strength. <b>SIRIUS</b>												

### Preset Name

Assign name to a preset memory.

Setting items	Setting details
<b>A1 - G8</b> Select the preset channel. <b>HD Radio</b>	<ul style="list-style-type: none"> <li>Up to eight characters can be input.</li> <li>For character input, see page 65.</li> </ul>
<b>Default</b> The changed preset name is returned to the default setting.	<p><b>Yes</b> : Reset to the defaults.</p> <p><b>No</b> : Do not reset to the defaults.</p>

### Input Assign

#### Examples of input assign menu screen displays

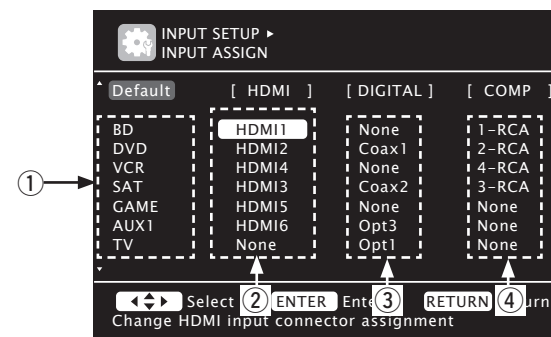

- ① Input Source
- ② HDMI input
- ③ Digital audio input
- ④ Component video input

#### Input assignments menu operations

- Use  $\Delta \nabla \triangleleft \triangleright$  to move the highlight to the item you want to set.
- Press **ENTER**, then use  $\triangleleft \triangleright$  to select the input connector to be assigned.
- Press **ENTER** to register the setting.

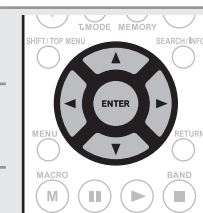

#### NOTE

If all "HDMI", "Digital" and "Component" assignment of the Game source are set to "None", Game source cannot be selected with the input source selection.

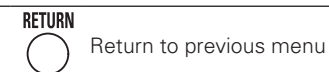
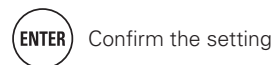

Setting items	Setting details																								
<b>HDMI</b> Set this to change the HDMI input connectors assigned to the input sources. <div style="display: flex; flex-wrap: wrap; gap: 5px;"> <div style="border: 1px solid black; padding: 2px;">BD</div> <div style="border: 1px solid black; padding: 2px;">DVD</div> <div style="border: 1px solid black; padding: 2px;">VCR</div> <div style="border: 1px solid black; padding: 2px;">SAT</div> <div style="border: 1px solid black; padding: 2px;">GAME</div> <div style="border: 1px solid black; padding: 2px;">AUX1</div> <div style="border: 1px solid black; padding: 2px;">TV</div> </div>	<b>HDMI 1 / HDMI 2 / HDMI 3 / HDMI 4 / HDMI 5 / HDMI 6</b> <b>None</b> : Do not assign an HDMI input connector to the selected input source. <ul style="list-style-type: none"> <li>At time of purchase, the settings of the different input sources are as shown below.</li> </ul> <table border="1" style="width: 100%; text-align: center;"> <tr> <td>Input source</td> <td>BD</td> <td>DVD</td> <td>VCR</td> <td>SAT</td> <td>GAME</td> <td>AUX1</td> <td>TV</td> </tr> <tr> <td>Default setting</td> <td>HDMI 1</td> <td>HDMI 2</td> <td>HDMI 4</td> <td>HDMI 3</td> <td>HDMI 5</td> <td>HDMI 6</td> <td>None</td> </tr> </table> <p> An input source to which an HDMI input connector cannot be assigned is displayed as "----".</p> <ul style="list-style-type: none"> <li>To play the video signal assigned at "HDMI" combined with the audio signal assigned at "Input Assign" - "Digital", select "Digital" at "Input Mode" (page 71).</li> <li>The audio signals input from the analog and digital connectors are not output to the monitor.</li> <li>When "HDMI Control" (page 80) is set to "ON", HDMI input connector cannot be assigned to "TV".</li> </ul>	Input source	BD	DVD	VCR	SAT	GAME	AUX1	TV	Default setting	HDMI 1	HDMI 2	HDMI 4	HDMI 3	HDMI 5	HDMI 6	None								
Input source	BD	DVD	VCR	SAT	GAME	AUX1	TV																		
Default setting	HDMI 1	HDMI 2	HDMI 4	HDMI 3	HDMI 5	HDMI 6	None																		
<b>Digital</b> Set this to change the digital input connectors assigned to the input sources. <div style="display: flex; flex-wrap: wrap; gap: 5px;"> <div style="border: 1px solid black; padding: 2px;">BD</div> <div style="border: 1px solid black; padding: 2px;">DVD</div> <div style="border: 1px solid black; padding: 2px;">VCR</div> <div style="border: 1px solid black; padding: 2px;">SAT</div> <div style="border: 1px solid black; padding: 2px;">GAME</div> <div style="border: 1px solid black; padding: 2px;">AUX1</div> <div style="border: 1px solid black; padding: 2px;">TV</div> <div style="border: 1px solid black; padding: 2px;">CD</div> <div style="border: 1px solid black; padding: 2px;">CDR</div> <div style="border: 1px solid black; padding: 2px;">SIRIUS</div> </div>	<b>Coax1 - 2 (COAXIAL) / Opt1 - 3 (OPTICAL)</b> <b>None</b> : Do not assign a digital input connector to the selected input source. <ul style="list-style-type: none"> <li>At time of purchase, the settings of the different input sources are as shown below.</li> </ul> <table border="1" style="width: 100%; text-align: center;"> <tr> <td>Input source</td> <td>BD</td> <td>DVD</td> <td>VCR</td> <td>SAT</td> <td>GAME</td> <td>AUX1</td> </tr> <tr> <td>Default setting</td> <td>None</td> <td>Coax 1</td> <td>None</td> <td>Coax 2</td> <td>None</td> <td>Opt 3</td> </tr> </table> <table border="1" style="width: 100%; text-align: center;"> <tr> <td>Input source</td> <td>TV</td> <td>CD</td> <td>CDR</td> <td>SIRIUS</td> </tr> <tr> <td>Default setting</td> <td>Opt 1</td> <td>Opt 2</td> <td>None</td> <td>None</td> </tr> </table>	Input source	BD	DVD	VCR	SAT	GAME	AUX1	Default setting	None	Coax 1	None	Coax 2	None	Opt 3	Input source	TV	CD	CDR	SIRIUS	Default setting	Opt 1	Opt 2	None	None
Input source	BD	DVD	VCR	SAT	GAME	AUX1																			
Default setting	None	Coax 1	None	Coax 2	None	Opt 3																			
Input source	TV	CD	CDR	SIRIUS																					
Default setting	Opt 1	Opt 2	None	None																					

Setting items	Setting details																
<b>Component</b> Set this to change the component video input connectors assigned to the input sources. <div style="display: flex; flex-wrap: wrap; gap: 5px;"> <div style="border: 1px solid black; padding: 2px;">BD</div> <div style="border: 1px solid black; padding: 2px;">DVD</div> <div style="border: 1px solid black; padding: 2px;">VCR</div> <div style="border: 1px solid black; padding: 2px;">SAT</div> <div style="border: 1px solid black; padding: 2px;">GAME</div> <div style="border: 1px solid black; padding: 2px;">AUX1</div> <div style="border: 1px solid black; padding: 2px;">TV</div> </div>	<b>1-RCA / 2-RCA / 3-RCA / 4-RCA</b> (Component video) <b>None</b> : Do not assign a component video input connector to the selected input source. <ul style="list-style-type: none"> <li>At time of purchase, the settings of the different input sources are as shown below.</li> </ul> <table border="1" style="width: 100%; text-align: center;"> <tr> <td>Input source</td> <td>BD</td> <td>DVD</td> <td>VCR</td> <td>SAT</td> <td>GAME</td> <td>AUX1</td> <td>TV</td> </tr> <tr> <td>Default setting</td> <td>1-RCA</td> <td>2-RCA</td> <td>4-RCA</td> <td>3-RCA</td> <td>None</td> <td>None</td> <td>None</td> </tr> </table> <p> An input source to which a component video input connector cannot be assigned is displayed as "----".</p>	Input source	BD	DVD	VCR	SAT	GAME	AUX1	TV	Default setting	1-RCA	2-RCA	4-RCA	3-RCA	None	None	None
Input source	BD	DVD	VCR	SAT	GAME	AUX1	TV										
Default setting	1-RCA	2-RCA	4-RCA	3-RCA	None	None	None										
<b>Default</b> The "Input Assign" settings are returned to the default settings.	<b>Yes</b> : Reset to the defaults. <b>No</b> : Do not reset to the defaults. <p> If you select "Default" and press <b>ENTER</b>, the message "Default Setting?" is displayed. Select "Yes" or "No", and then press <b>ENTER</b>.</p>																

## Video



**Default settings are underlined.**



Set the source video.  
 \* "GAME" or "TV" can be set when "HDMI" (page 69) or "Component" (page 69) has been assigned.

Setting items	Setting details
<b>Video Select</b> Video of another input source is played back combined with the playing audio.	<b>Source</b> : Play the picture and sound of the input source. <b>BD / DVD / VCR / SAT / GAME / AUX1 / TV</b> : Select video input source to view. This can be set for individual input sources. <p> "GAME" and "TV" can be selected only when a component video is assigned as an input source.</p> <p><b>NOTE</b></p> <ul style="list-style-type: none"> <li>It is not possible to select HDMI input signals.</li> <li>Input sources for which "Delete" is selected at "Source Delete" (page 84) cannot be selected.</li> <li>This can also be set by pressing <b>V.SEL</b> on the remote control unit.</li> </ul>



Input Setup

Setting items	Setting details												
<p><b>Video Mode</b> Make settings for video processing.</p> <table border="1"> <tr> <td>BD</td> <td>DVD</td> <td>VCR</td> </tr> <tr> <td>SAT</td> <td>GAME *</td> <td></td> </tr> <tr> <td>AUX1</td> <td>TV *</td> <td></td> </tr> </table>	BD	DVD	VCR	SAT	GAME *		AUX1	TV *		<p><b>Auto</b> : Process video automatically based on the HDMI content information. <b>Movie</b> : Process video normally. <b>Game</b> : Always process video appropriate for game content.</p> <p></p> <ul style="list-style-type: none"> <li>• If "Video Mode" is set to "Auto", the mode is switched according to the input contents.</li> <li>• If a source is played in both MAIN ZONE (audio and video) and ZONE2 (audio only) modes in the same room, audio in MAIN ZONE and ZONE2 modes may sound out of synchronization, but this is not malfunction. In this case, setting to "Game" mode may improve audio synchronization.</li> </ul>			
BD	DVD	VCR											
SAT	GAME *												
AUX1	TV *												
<p><b>Video Convert</b> The input video signal is converted automatically in conjunction with the connected TV (page 14 "Converting input video signals for output (Video conversion function)").</p> <table border="1"> <tr> <td>BD</td> <td>DVD</td> <td>VCR</td> </tr> <tr> <td>SAT</td> <td>GAME *</td> <td></td> </tr> <tr> <td>AUX1</td> <td>TV *</td> <td></td> </tr> </table>	BD	DVD	VCR	SAT	GAME *		AUX1	TV *		<p><b>ON</b> : The input video signal is converted. <b>OFF</b> : The input video signal is not converted.</p> <p></p> <ul style="list-style-type: none"> <li>• When a non-standard video signal from a game machine or some other source is input, the video conversion function might not operate. In this case set "Video Convert" to "OFF".</li> <li>• When "Video Convert" is set to "OFF", the video conversion function does not work. In this case, connect this unit and TV with the same type of cable.</li> </ul>			
BD	DVD	VCR											
SAT	GAME *												
AUX1	TV *												
<p><b>i/p Scaler</b> Convert the input source's resolution to the resolution set at "Resolution".</p> <table border="1"> <tr> <td>BD</td> <td>DVD</td> <td>VCR</td> </tr> <tr> <td>SAT</td> <td>GAME *</td> <td></td> </tr> <tr> <td>AUX1</td> <td>NET/USB</td> <td></td> </tr> <tr> <td>TV *</td> <td></td> <td></td> </tr> </table>	BD	DVD	VCR	SAT	GAME *		AUX1	NET/USB		TV *			<p><b>Analog</b> : Use i/p scaler function for analog video signal. <b>Analog &amp; HDMI</b> : Use i/p scaler function for analog and HDMI video signal. <b>HDMI</b> : Use i/p scaler function for HDMI video signal. <b>OFF</b> : Do not use i/p scaler function.</p> <p></p> <ul style="list-style-type: none"> <li>• "Analog &amp; HDMI" and "HDMI" can be set for input sources for which an HDMI input connector is assigned.</li> <li>• Which items can be set depend on the input source assigned to each input connector.</li> <li>• This function is not effective when the input signal is x.v.Color, 3D, sYCC 601 color, Adobe RGB color, Adobe YCC 601 color or computer resolution.</li> </ul>
BD	DVD	VCR											
SAT	GAME *												
AUX1	NET/USB												
TV *													

Setting items	Setting details												
<p><b>Resolution</b> Set the output resolution. Resolution (Analog) : Analog Video Resolution (HDMI) : HDMI</p> <table border="1"> <tr> <td>BD</td> <td>DVD</td> <td>VCR</td> </tr> <tr> <td>SAT</td> <td>GAME *</td> <td></td> </tr> <tr> <td>AUX1</td> <td>NET/USB</td> <td></td> </tr> <tr> <td>TV *</td> <td></td> <td></td> </tr> </table>	BD	DVD	VCR	SAT	GAME *		AUX1	NET/USB		TV *			<p><b>Auto</b> : The number of pixels the TV connected to the HDMI output connector supports is detected automatically and the appropriate output resolution is set. <b>480p / 576p / 1080i / 720p / 1080p / 1080p:24Hz</b> : Set the output resolution.</p> <p></p> <ul style="list-style-type: none"> <li>• This item can be set when "i/p Scaler" is set to anything other than "OFF".</li> <li>• When "i/p Scaler" is set to "Analog &amp; HDMI", the resolution of both the analog video input signal and HDMI input signal can be set.</li> <li>• To watch 1080p/24Hz pictures, use a TV that supports 1080p/24Hz video signals.</li> <li>• When set to "1080p/24Hz", you can enjoy film-like pictures for film sources (in 24 Hz). For video sources and mixed sources, we recommend setting the resolution to "1080p".</li> <li>• It is not possible to convert a 50 Hz signal into 1080p/24Hz. It is output at a resolution of 1080p/50Hz.</li> </ul>
BD	DVD	VCR											
SAT	GAME *												
AUX1	NET/USB												
TV *													
<p><b>Progressive Mode</b> Set an appropriate progressive conversion mode for the source video signal.</p> <table border="1"> <tr> <td>BD</td> <td>DVD</td> <td>VCR</td> </tr> <tr> <td>SAT</td> <td>GAME *</td> <td></td> </tr> <tr> <td>AUX1</td> <td>TV *</td> <td></td> </tr> </table>	BD	DVD	VCR	SAT	GAME *		AUX1	TV *		<p><b>Auto</b> : The video signal is automatically detected and the appropriate mode is set. <b>Video1</b> : Select mode suitable for video playback <b>Video2</b> : Select mode suitable for video and 30-frame film material playback.</p> <p></p> <p>This item can be set when "i/p Scaler" is set to anything other than "OFF".</p>			
BD	DVD	VCR											
SAT	GAME *												
AUX1	TV *												
<p><b>Aspect</b> Set the aspect ratio for the video signals output to the HDMI.</p> <table border="1"> <tr> <td>BD</td> <td>DVD</td> <td>VCR</td> </tr> <tr> <td>SAT</td> <td>GAME *</td> <td></td> </tr> <tr> <td>AUX1</td> <td>NET/USB</td> <td></td> </tr> <tr> <td>TV *</td> <td></td> <td></td> </tr> </table>	BD	DVD	VCR	SAT	GAME *		AUX1	NET/USB		TV *			<p><b>Full</b> : Output at 16:9 aspect ratio. <b>Normal</b> : Output at 4:3 aspect ratio.</p> <p></p> <p>"Aspect" can be set when "i/p Scaler" is set to anything other than "OFF".</p>
BD	DVD	VCR											
SAT	GAME *												
AUX1	NET/USB												
TV *													



\* "GAME" or "TV" can be set when "HDMI" (page 69) or "Component" (page 69) has been assigned.



# Input Mode

Default settings are underlined.

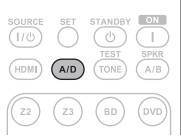
The input modes available for selection may vary depending on the input source.

Setting items	Setting details
<b>Input Mode</b> Set the audio input modes for the different input sources.	<p><b>Auto</b> : Automatically detect input signal and perform playback.  <b>HDMI</b> : Play only signals from HDMI input.  <b>Digital</b> : Play only signals from digital input.  <b>Analog</b> : Play only signals from analog input.  <b>7.1CH IN</b> : Only signals input from the 7.1CH INPUT terminal will be played back.</p>  <ul style="list-style-type: none"> <li>This can also be set by pressing <b>A/D</b> on the remote control unit.</li> <li>Each time <b>A/D</b> is pressed, the setting is changed as shown below.</li> </ul>  <p>Auto → HDMI → Digital → Analog</p> <p>7.1CH IN ←</p> <ul style="list-style-type: none"> <li>"HDMI" can be set for input sources for which "HDMI" is assigned at "Input Assign" (page 69).</li> <li>"Digital" can be set for input sources for which "Digital" is assigned at "Input Assign" (page 69).</li> <li>If the input source is set to "TV" or "Game", it cannot be set to "Analog".</li> <li>When digital signals are properly input, the <b>DIG.</b> indicator lights on the display. If the <b>DIG.</b> indicator does not light, check the digital input connector assignment and the connections.</li> <li>The surround mode cannot be set if the input mode is set to "7.1CH IN".</li> <li>If "HDMI Control" is set to "ON" and a TV compatible with the ARC is connected via the HDMI OUT connectors, the input mode whose input source is "TV" is fixed to ARC.</li> </ul>
<b>Decode Mode</b> Set the decode mode for input source.	<p><b>Auto</b> : Detect type of digital input signal and decode and play automatically.  <b>PCM</b> : Decode and play only PCM input signals.  <b>DTS</b> : Decode and play only DTS input signals.</p>  <ul style="list-style-type: none"> <li>This item can be set for input sources for which "HDMI" or "Digital" is assigned at "Input Assign" (page 68).</li> <li>Normally set this mode to "Auto". Set "PCM" and "DTS" when inputting the corresponding input signal.</li> </ul>

BD	DVD	VCR
SAT	GAME	AUX1
TV	CD	CDR

# Rename

Change the display name of the selected input source.

Setting items	Setting details
<b>Rename</b> Change the display name of the selected input source.	<ul style="list-style-type: none"> <li>Up to eight characters can be input.</li> <li>For character input, see page 65.</li> </ul>
<b>Default</b> The input source name is returned to the default setting.	<p><b>Yes</b> : Reset to the defaults.  <b>No</b> : Do not reset to the defaults.</p>

# Source Level

Default settings are underlined.

- This function corrects the playback level of the selected input source's audio input.
- Make this setting if there are differences in the input volume levels between the different sources.

Setting details
<p><b>-12dB - +12dB (0dB)</b></p>  The analog input level and digital input level can be adjusted independently for input sources for which "HDMI" or "Digital" is assigned at "Input Assign" (page 68).

# Playback Mode

Make settings for repeat playback mode or random playback mode.

Setting items	Setting details
<b>Repeat</b> Make settings for repeat mode.	<p><b>All</b> : All files are played repeatedly.  <b>One</b> : A file being played is played repeatedly.  <b>OFF</b> : Repeat playback mode is canceled.</p>
<b>Random</b> Make random mode settings.	<p><b>ON</b> : Enable random playback.  <b>OFF</b> : Disable random playback.</p>



## Input Setup

## Still Picture

Default settings are underlined&gt;.

Make settings for playing back still picture images.

Setting items	Setting details
<b>Slide Show</b> Make slide show settings.	<b>ON</b> : Display still picture images in a slide show. <b>OFF</b> : Display only the selected still picture image.
<b>NET/USB</b>	
<b>Interval</b> Set the playback time per image.	<u>5sec</u> – 60sec
<b>NET/USB</b>	

## Audio/Video Adjust

The sound being played in the surround mode can be adjusted to your liking. The items (parameters) that can be adjusted depend on the signal being input and the currently set surround mode. For details on the adjustable parameters, see "Surround modes and parameters" (page 104).

## Menu operation

**1** Press **AMP** to set the remote control unit to amplifier operation mode.

**2** Press **MENU**.  
The menu is displayed on the TV screen.

**3** Use  $\Delta$   $\nabla$  to select the menu to be set or operated.

**4** Press **ENTER** or  $\triangleright$  to enter the setting.

- To return to the previous item, press **RETURN**.
- Exiting the Menu, press **MENU** while the menu is displayed. The menu display disappears.

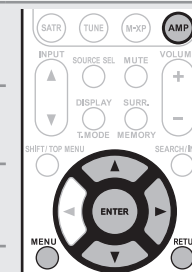

## Items that can be set with the Audio/Video Adjust procedure

- Audio Adjust** (page 73)
- Surround Parameter (page 73)
  - Tone (page 73)
  - Audyssey Settings (page 74)
  - A-DSX Soundstage (page 75)
  - Manual EQ (page 76)
  - M-DAX (page 76)
  - Audio Delay (page 76)

**Picture Adjust** (page 77)



## Audio Adjust

### Surround Parameter

Default settings are underlined.



Adjust surround sound parameters. It may not be possible to set this item depending on the input signal.

Setting items	Setting details
<b>HT-EQ</b> Soften the treble range of movie soundtracks for better understanding.	<b>ON</b> : "HT-EQ" is used. <b>OFF</b> : "HT-EQ" is not used.
<b>DRC</b> Compress dynamic range (difference between loud and soft sounds).	<b>Auto</b> : Automatic dynamic range compression on/off control according to source. This can be set in the Dolby TrueHD mode. <b>Low / Mid / High</b> : These set the compression level. <b>OFF</b> : Dynamic range compression always off.
<b>D.Comp</b> Compress dynamic range (difference between loud and soft sounds).	<b>Low / Mid / High</b> : These set the compression level. <b>OFF</b> : Turn dynamic range compression off.
<b>LFE</b> Adjust the low-frequency effects level (LFE).	<b>-10dB - 0dB</b>  For proper playback of the different sources, we recommend setting to the values below. • Dolby Digital sources : "0dB" • DTS movie sources : "0dB" • DTS music sources : "-10dB"
<b>C.Image</b> Assign center channel signal to front left and right channels for wider sound.	<b>0.0 - 1.0 (0.3)</b>
<b>Panorama</b> Assign front L/R signal also to surround channels for wider sound.	<b>ON</b> : Set. <b>OFF</b> : Do not set.
<b>Dimension</b> Shift sound image center to front or rear to adjust playback balance.	<b>0 - 6 (3)</b>
<b>C.Width</b> Assign center channel signal to front left and right channels for wider sound.	<b>0 - 7 (3)</b>

Setting items	Setting details
<b>Height Gain</b> Control the front height channel volume.	<b>Low</b> : Reduce the front height channel volume. <b>Mid</b> : Front height channel sound is output with standard sound volume. <b>High</b> : Increase the front height channel volume. <b>NOTE</b> "Height Gain" is displayed for the following settings. • When "Amp Assign" (page 78) is set to "Normal". • When the "Speaker Config." - "F.Height" setting (page 78) is set other than to "None". • When surround mode is "PLIIz" or the PLIIz decoder is used.
<b>Default</b> The "Surround Parameter" settings are returned to the default settings.	<b>Yes</b> : Reset to the defaults. <b>No</b> : Do not reset to the defaults.

### Tone

Adjust the tonal quality of the sound.

Setting items	Setting details
<b>Tone Control</b> Set the tone control function to ON and OFF.	<b>ON</b> : Allow tone adjustment (bass, treble). <b>OFF</b> : Playback without tone adjustment.  "Tone Control" can be set when "Dynamic EQ" (page 74) is set to "OFF". <b>NOTE</b> • "Tone Control" settings are not reflected to ZONE2 and ZONE3. • The tone cannot be adjusted in the direct mode.
<b>Bass</b> Adjust low frequency range (bass).	<b>-6dB - +6dB</b>  "Bass" can be set when "Tone Control" is set to "ON".
<b>Treble</b> Adjust high frequency range (treble).	<b>-6dB - +6dB</b>  "Treble" can be set when "Tone Control" is set to "ON".



Audio/Video Adjust



**Audyssey Settings**

Default settings are underlined.



Set MultEQ® XT, Dynamic EQ® and Dynamic Volume®. These can be selected after Audyssey® Auto Setup has been performed. For additional information on Audyssey technology, please see page 109.

**NOTE**



If you have not performed Auto Setup, or if you change the speaker settings after performing Auto Setup, you may not be able to select Dynamic EQ/Dynamic Volume, and "Run Audyssey" may be displayed. In this case, either perform Audyssey Auto Setup over again or perform "Restore" (page 12) to return to the settings after Audyssey Auto Setup was run.

Setting items	Setting details
<p><b>MultEQ XT</b> Select one equalizer from three modes. MultEQ XT corrects both time and frequency response problems in the listening area based on Audyssey Auto Setup calibration. We recommend "Audyssey". MultEQ XT is the prerequisite function for Dynamic EQ and Dynamic Volume.</p>	<p><b>Audyssey</b> : Optimize the frequency response of all speakers.  <b>Audyssey Byp.L/R</b> : Optimize frequency response of speakers except front L and R speakers.  <b>Audyssey Flat</b> : Optimize frequency response of all speakers to flat response.  <b>Manual</b> : Apply frequency response set with "Manual EQ" (page 76).  <b>OFF</b> : Turn "MultEQ XT" equalizer off.</p> <p>• "Audyssey", "Audyssey Byp. L/R" and "Audyssey Flat" can be selected after Audyssey Auto Setup has been performed. "Audyssey" is automatically selected after performing Audyssey Auto Setup. When "Audyssey", "Audyssey Byp. L/R" or "Audyssey Flat" is selected,  illuminates.</p> <p>• After running Audyssey Auto Setup, if the Speaker Configuration, Distance, Channel Level, and Crossover Frequency have changed without increasing the number of speakers measured, only  illuminates.</p> <p>• Pressing <b>MULTEQ</b> makes this setting.</p> <p><b>NOTE</b></p> <p>• "MultEQ XT" and "Manual" cannot be selected when "EQ Customize" is set to "Not Used" (page 81).          • When using headphones, "MultEQ XT" is automatically set to "OFF".</p>

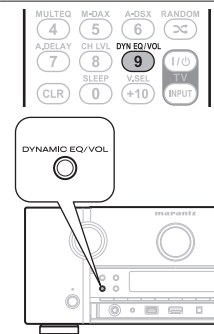

Setting items	Setting details
<p><b>Dynamic EQ®</b> Solve the problem of deteriorating sound quality as volume is decreased by taking into account human perception and room acoustics. Works with MultEQ XT.</p>	<p><b>ON</b> : Use Dynamic EQ.  <b>OFF</b> : Do not use Dynamic EQ.</p> <p>  is displayed when set to "ON".</p> <p>• Buttons on the remote control unit or main unit can be used for operations. Press <b>DYN EQ/VOL</b>.</p> <p>Each time <b>DYN EQ/VOL</b> is pressed, the setting is changed as shown below.</p> <div style="text-align: center;"> <pre>             graph TD             A[Dynamic EQ : ON Dynamic Volume : Heavy] --&gt; B[Dynamic EQ : ON Dynamic Volume : Medium]             B --&gt; C[Dynamic EQ : ON Dynamic Volume : Light]             C --&gt; D[Dynamic EQ : OFF Dynamic Volume : Light]             D --&gt; E[Dynamic EQ : OFF Dynamic Volume : Off]             E --&gt; F[Dynamic EQ : ON Dynamic Volume : Off]             F --&gt; G[Dynamic EQ : ON Dynamic Volume : Heavy]             G --&gt; A             </pre> </div>
<p><b>Reference Level Offset</b> Audyssey Dynamic EQ is referenced to the standard film mix level. It makes adjustments to maintain the reference response and surround envelopment when the volume is turned down from 0 dB. However, film reference level is not always used in music or other non-film content. Dynamic EQ Reference Level Offset provides three offsets from the film level reference (5 dB, 10 dB, and 15 dB) that can be selected when the mix level of the content is not within the standard.</p>	<p><b>0dB</b> (Film Ref) : This is the default setting and should be used when listening to movies.  <b>5dB</b> : Select this setting for content that has a very wide dynamic range, such as classical music.  <b>10dB</b> : Select this setting for jazz or other music that has a wider dynamic range. This setting should also be selected for TV content as that is usually mixed at 10 dB below film reference.  <b>15dB</b> : Select this setting for pop/rock music or other program material that is mixed at very high listening levels and has a compressed dynamic range.</p> <p> Setting is enabled when "Dynamic EQ" is "ON" (page 74).</p>

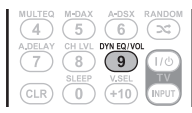

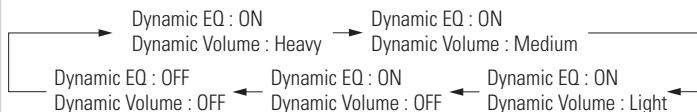

Setting items	Setting details
<p><b>Dynamic Volume®</b> Solve the problem of large variations in volume level between TV, movies and other content (between quiet passages and loud passages, etc.) by automatically adjusting to the user's preferred volume setting.</p>	<p><b>Heavy</b> : Most adjustment to softest and loudest sounds.  <b>Medium</b> : Medium adjustment to loudest and softest sound.  <b>Light</b> : Least adjustment to loudest and softest sounds.  <b>OFF</b> : Do not use "Dynamic Volume".</p>  <ul style="list-style-type: none"> <li>•  <b>AUDYSSEY MULTEQ XT DYN VOL</b> is displayed when set to "ON".</li> <li>• If "Dynamic Volume" is set to "Yes" in Auto Setup (page 11), the setting is automatically changed to "Heavy".</li> <li>• Buttons on the remote control unit or main unit can be used for operations. Press <b>DYN EQ/VOL</b>.</li> </ul> <p>Each time <b>DYN EQ/VOL</b> is pressed, the setting is changed as shown below.</p> 

**A-DSX Soundstage**

Default settings are underlined.

Adjust Audyssey DSX™ setting and sound stage parameters.

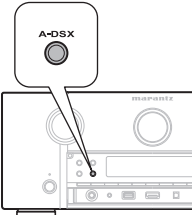
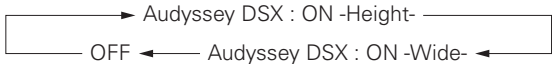
Setting items	Setting details
<p><b>Audyssey DSX</b> Provides more immersive surround sound by adding the new channels.</p>	<p><b>ON-Height-</b> : Turn on A-DSX processing for height expansion.  <b>ON-Wide-</b> : Turn on A-DSX processing for wide expansion.  <b>OFF</b> : Do not set Audyssey DSX.</p>  <ul style="list-style-type: none"> <li>• This can also be set by pressing <b>A-DSX</b>.</li> <li>• The  indicator illuminates on the display.</li> </ul>  

Setting items	Setting details
<p><b>Stage Width</b> Adjust sound stage width when using front wide speakers.</p>	<p><b>-10 - +10 (0)</b></p>
<p><b>Stage Height</b> Adjust sound stage height when using front height speakers.</p>	<p><b>-10 - +10 (0)</b></p> <ul style="list-style-type: none"> <li>• "Audyssey DSX" can be set when you are using front height speakers or front wide speakers.</li> <li>• "Audyssey DSX" is only valid when using a center speaker.</li> <li>• "Audyssey DSX" is only enabled when the listening mode is set other than STEREO, PLIIz Height, MULTI CH STEREO, NEURAL, DOLBY VS, DIRECT, PURE DIRECT.</li> <li>• "A-DSX Soundstage" cannot be configured if the HD Audio source being played includes Front height and Front wide channels. In this case, the respective channels are played back using the input signals.</li> </ul> <p><b>About Audyssey Dynamic Surround Expansion (A-DSX)</b>                      Audyssey DSX is a scalable surround expansion system that adds new channels to improve the surround impression. Based on research in human hearing Audyssey DSX adds a pair of Wide channels in the front because that information is critical in the rendering of a realistic soundstage.                      Audyssey DSX then adds a pair of Height channels above the main front channels to reproduce the next most important acoustical and perceptual cues related to soundstage depth. In addition to creating these new channels, Audyssey DSX applies Surround Envelopment Processing to enhance the blend between the front and side/back surround channels. The result is a much more seamless and enveloping home theater experience.</p>

Audio/Video Adjust

**Manual EQ**

Default settings are underlined.

Use the graphic equalizer to adjust the tone of each speaker.  
 "Manual EQ" can be set when "MultEQ XT" setting (page 74) is "Manual"

Setting items	Setting details
<b>Adjust CH</b> Correct the tone of each speaker.	① Select the speaker tone adjustment method. <b>All</b> : Adjust the tone of all speakers together. <b>L/R</b> : Adjust the tone of left and right speakers together. <b>Each</b> : Adjust the tone of each speaker. ② Select the speaker. ③ Select the adjustment frequency band. <b>63Hz / 125Hz / 250Hz / 500Hz / 1kHz / 2kHz / 4kHz / 8kHz / 16kHz</b> • Select the speakers you want to adjust when "L/R" or "Each" is selected. ④ Adjust the level. <b>-20.0dB - +6.0dB (0.0dB)</b>
<b>Base Curve Copy</b> Copy "Audyssey Flat" curve from MultEQ <sup>®</sup> XT.	<b>Yes</b> : Copy. <b>No</b> : Do not copy. • "Base Curve Copy" is displayed after Audyssey <sup>®</sup> Auto Setup has been performed.
<b>Default</b> The "Manual EQ" settings are returned to the default settings.	<b>Yes</b> : Reset to the defaults. <b>No</b> : Do not reset to the defaults.

**M-DAX**

Default settings are underlined.

Compressed audio formats such as MP3, WMA (Windows Media Audio) and MPEG-4 AAC reduce the amount of data by eliminating signal components that are hard for the human ear to hear. The M-DAX function generates the signals eliminated upon compression, restoring the sound to conditions near those of the original sound before compression. It also corrects the sense of volume of the bass to obtain richer sound with compressed audio signals.

**Setting details**

- OFF** : Do not use M-DAX.
- LOW** : Optimized mode for compressed sources with normal highs.
- MID** : Apply suitable bass and treble boost for all compressed sources.
- HIGH** : Optimized mode for compressed sources with very weak highs.

- This item can be set with analog signals or when a PCM signal (fs = 44.1/48 kHz) is input.
- This cannot be set when the surround mode is set to "DIRECT" or "PURE DIRECT".
- This item default setting is "OFF".
- If a setting other than "OFF" is selected, the M-DAX indicator lights.
- Pressing **M-DAX** on the remote control unit or the main unit makes this setting.

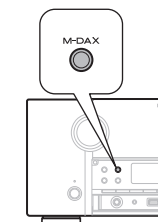

**Audio Delay**

Default settings are underlined.

While viewing video, manually adjust the time to delay audio output.

**Setting details**

**0ms - 200ms**

- This item can be set within the range of 0 to 100 ms when "Auto Lip Sync" is set to "ON" and when a TV compatible with Auto Lip Sync is connected.
- Store "Audio Delay" for each input source.
- Audio Delay for game mode can be set when "Video Mode" (page 70) is set to "Auto" or "Game".
- This can also be set by pressing **A.DELAY** on the remote control unit.



# Picture Adjust

Default settings are underlined.

- This item can be set when the input source is **BD** **DVD** **VCR** **SAT** **GAME** **AUX1** **NET/USB** **TV**.
- With input sources other than the ones above, this item can be set when "Video Select" is selected. In this case, the original input source settings are called out.
- Can be set when the "Video Convert" setting (page 70) is "ON".
- "GAME" or "TV" can be set when "HDMI" (page 69) or "Component" (page 69) has been assigned.

Setting items	Setting details
<b>Contrast</b> Adjust picture contrast.	-6 - <u>+6 (0)</u>
<b>Brightness</b> Adjust picture brightness.	<u>0</u> - +12
<b>Chroma Level</b> Adjust picture chroma level (saturation).	-6 - <u>+6 (0)</u>
<b>Hue</b> Adjust color hue.	-6 - <u>+6 (0)</u>
<b>DNR</b> Reduce overall picture noise.	<u>OFF</u> / Low / Mid / High
<b>Enhancer</b> Emphasize picture contours.	<u>0</u> - +12



- "DNR" and "Enhancer" are each effective with HDMI output.
- The value set at "Picture Adjust" is stored in the memory individually for each input source.

# Manual Setup

Set when changing Audyssey® Auto Setup settings, or when changing the audio, video, display or other settings.

- If you change the speaker settings after performing Audyssey Auto Setup, it will not be possible to set MultEQ® XT, Dynamic EQ® and Dynamic Volume® (page 74, 75).
- Can be used without changing the settings. Please set if necessary.

## Menu operation

- 1 Press **AMP** to set the remote control unit to amplifier operation mode.
- 2 Press **MENU**.  
The menu is displayed on the TV screen.
- 3 Press **Δ**/**∇** to select the menu to be set or operated.
- 4 Press **ENTER** or **▷** to enter the setting.

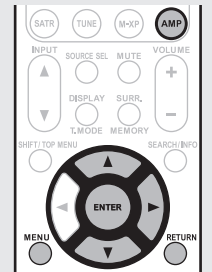

- To return to the previous item, press **RETURN**.
- Exiting the Menu, press **MENU** while the menu is displayed. The menu display disappears.

## Items that can be set with the Manual Setup procedure

<p><b>Speaker Setup</b> (page 78)</p> <p>MANUAL SETUP ▶ SPEAKER SETUP</p> <p>◀ Amp Assign ▶ Speaker Config. Bass Setting Distance Channel Level Crossover Frequency</p> <p>Assign surround back AMP for other use</p>	<p><b>HDMI Setup</b> (page 80)</p> <p>MANUAL SETUP ▶ HDMI SETUP</p> <p>RGB Range Normal Auto Lip Sync ON HDMI Audio Out AMP Monitor Out Monitor 1 HDMI Control ON Standby Source Last Power Off Control All</p> <p>RETURN Return Use video range from 16 (black) to 235 (white)</p>	<p><b>Audio Setup</b> (page 81)</p> <p>MANUAL SETUP ▶ AUDIO SETUP</p> <p>◀ 7.1ch IN SW Level ▶ EQ Customize</p> <p>Set subwoofer playback level in 7.1ch IN mode</p>
<p><b>Network Setup</b> (page 81)</p> <p>MANUAL SETUP ▶ NETWORK SETUP</p> <p>◀ Network Connecting ▶ Other Rhapsody Account Napster Account Network Information</p> <p>Make settings for wired LAN</p>	<p><b>Zone Setup</b> (page 83)</p> <p>MANUAL SETUP ▶ ZONE SETUP</p> <p>◀ ZONE2 Setup ▶ ZONE3 Setup</p> <p>Make settings for audio playback in a ZONE2</p>	<p><b>Option Setup</b> (page 84)</p> <p>MANUAL SETUP ▶ OPTION SETUP</p> <p>◀ Volume Control ▶ Source Delete GUI Component 2 Output Zone Rename Trigger Out Display Setup Lock</p> <p>Make settings for volume control</p>

Remote control operation buttons



Move the cursor (Up/Down/Left/Right)



ENTER Confirm the setting



RETURN Return to previous menu



# Speaker Setup

Default settings are underlined.

- Perform when setting the speakers manually or when changing settings made in Audyssey Auto Setup.
- If you change the speaker settings after performing Audyssey Auto Setup, it will not be possible to select MultEQ XT, Dynamic EQ and Dynamic Volume (page 74, 75).
  - Manual Setup can be used without changing the settings. Please set if necessary.

## Audio output from each PRE OUT terminal

	PRE OUT Channel						
UNBALANCED PRE OUT terminal	FL/FR	C	SW1/SW2	SL/SR	SBL/SBR	HL/HR	WL/WR
BALANCED PRE OUT terminal	FL/FR	C	SW1/SW2	SL/SR	SBL/SBR	—	—
Audio Output	Front A	Center	Subwoofer 1 / Subwoofer 2	Surround	Surround Back*	Front Height / Front B	Front Wide

\*The output audio differs depending on the "Amp Assign" settings.

Setting items	Setting details
<b>Amp Assign</b> Set the speakers connected to the UNBALANCED and BALANCED PRE OUT SBL/SBR terminals of the power amp.	<b>Normal</b> : Set when using surround back, front height or front wide speakers. <b>ZONE2</b> : Set for connecting the speakers for ZONE2. <b>ZONE3</b> : Set for connecting the speakers for ZONE3. <b>SPKR-C</b> : Set for connecting the tweeter of the front speaker to the UNBALANCED and BALANCED PRE OUT SBL/SBR terminals of the power amp, and the woofer of the front speaker to the FL/FR terminals.
<b>Speaker Config.</b> Select speaker configuration and size (bass reproduction capability).	<b>Front</b> : Set the front speaker size. <ul style="list-style-type: none"> <li>• <b>Large</b> : Use a large speaker that can adequately play back low frequencies.</li> <li>• <b>Small</b> : Use a small speaker that has inadequate playback capacity for low frequencies.</li> </ul>
<b>NOTE</b> Do not use the outward shape of the speaker to determine selection of a "Large" or "Small" speaker. Instead, use the frequencies set in "Crossover Frequency" (page 80) as the standard for determining bass reproduction capability.	<ul style="list-style-type: none"> <li>• When "Subwoofer" is set to "No", "Front" is automatically set to "Large".</li> <li>• When "Front" is set to "Small", "Center", "Surround", "S.Back", "F.Height" and "F.Wide" can not be set to "Large".</li> </ul>
	<b>Center</b> : Set the presence and size of the center speaker. <ul style="list-style-type: none"> <li>• <b>Large</b> : Use a large speaker that can adequately play back low frequencies.</li> <li>• <b>Small</b> : Use a small speaker that has inadequate playback capacity for low frequencies.</li> <li>• <b>None</b> : Select when a center speaker is not connected.</li> </ul>
	<ul style="list-style-type: none"> <li>• "Large" is not displayed when "Front" is set to "Small".</li> </ul>
	<b>Subwoofer</b> : Set the presence of a subwoofer. <ul style="list-style-type: none"> <li>• <b>Yes</b> : Use a subwoofer.</li> <li>• <b>No</b> : Select when a subwoofer is not connected.</li> </ul>
	<ul style="list-style-type: none"> <li>• When "Front" is set to "Small", "Subwoofer" is automatically set to "Yes".</li> </ul>

Setting items	Setting details
<b>Speaker Config.</b> (Continued)	<b>Surround</b> : Set the presence and size of the surround speakers. <ul style="list-style-type: none"> <li>• <b>Large</b> : Use a large speaker that can adequately play back low frequencies.</li> <li>• <b>Small</b> : Use a small speaker that has inadequate playback capacity for low frequencies.</li> <li>• <b>None</b> : Select when the surround speakers are not connected.</li> </ul>
	<ul style="list-style-type: none"> <li>• When "Surround" is set to "Large", "S.Back", "F.Height" and "F.Wide" can be set to "Large".</li> <li>• When "Surround" is set to "None", "S.Back", "F.Height" and "F.Wide" can automatically set to "None".</li> </ul>
	<b>S.Back</b> : Set the presence, size and number of surround back speakers. <ul style="list-style-type: none"> <li>• <b>Large</b> : Use a large speaker that can adequately play back low frequencies.</li> <li>• <b>Small</b> : Use a small speaker that has inadequate playback capacity for low frequencies.</li> <li>• <b>None</b> : Select when the surround back speakers are not connected.</li> </ul>
	<ul style="list-style-type: none"> <li>• <b>2spkrs</b> : Use two surround back speakers.</li> <li>• <b>1spkr</b> : Use only one surround back speaker. When you select this setting, connect the surround back speaker to the left (L) channel.</li> </ul>
	<ul style="list-style-type: none"> <li>• Even when the "S.Back" setting is other than "None", sound may not be emitted from the surround back speaker, depending on the playback source.</li> </ul>
	<b>NOTE</b> When "Amp Assign" setting (page 78) is other than "Normal", you cannot make the "S.Back" setting.
	<b>F.Height</b> : Set the presence and size of the front height speakers. <ul style="list-style-type: none"> <li>• <b>Large</b> : Use a large speaker that can adequately play back low frequencies.</li> <li>• <b>Small</b> : Use a small speaker that has inadequate playback capacity for low frequencies.</li> <li>• <b>None</b> : Select when the front height speakers are not connected.</li> </ul>
	<b>NOTE</b> When "Amp Assign" setting (page 78) is other than "Normal", you cannot make the "F.Height" setting.





Setting items	Setting details
<b>Speaker Config.</b> (Continued)	<p><b>F.Wide</b> : Set the presence and size of the front wide speakers.</p> <ul style="list-style-type: none"> <li>• <b>Large</b> : Use a large speaker that can adequately play back low frequencies.</li> <li>• <b>Small</b> : Use a small speaker that has inadequate playback capacity for low frequencies.</li> <li>• <b>None</b> : Select when the front wide speakers are not connected.</li> </ul> <p><b>NOTE</b></p> <p>When "Amp Assign" setting (🔧 page 78) is other than "Normal", you cannot make the "F.Wide" setting.</p>
<b>Bass Setting</b> Set subwoofer and LFE signal range playback.	<p><b>Subwoofer Mode</b> : Select low range signals to be reproduced by subwoofer.</p> <ul style="list-style-type: none"> <li>• <b>LFE</b> : The low range signal of the channel set to "Small" speaker size is added to the LFE signal output from the subwoofer.</li> <li>• <b>LFE+Main</b> : The low range signal of all channels is added to the LFE signal output from the subwoofer.</li> </ul> <p>🔧</p> <ul style="list-style-type: none"> <li>• "Subwoofer Mode" can be set when "Speaker Config." – "Subwoofer" (🔧 page 78) is set to "Yes".</li> <li>• Play music or a movie source and select the mode offering the strongest bass.</li> <li>• Select "LFE+Main" if you want the bass signals to always be produced from the subwoofer.</li> </ul> <p><b>NOTE</b></p> <p>If "Front" and "Center" for "Speaker Config." are set to "Large", and "Subwoofer Mode" is set to "LFE", no sound may be output from the subwoofers, depending on the input signal or selected surround mode.</p> <p><b>LPF for LFE</b> : Set LFE signal playback range.</p> <p>• <b>80Hz / 90Hz / 100Hz / 110Hz / 120Hz / 150Hz / 200Hz / 250Hz</b></p>
<b>Distance</b> Set distance from listening position to speakers. Measure beforehand the distance from the listening position to each speaker.	<p><b>Unit</b> : Set the unit of distance.</p> <ul style="list-style-type: none"> <li>• <b>Feet / Meters</b></li> </ul> <p><b>Step</b> : Set the minimum variable width of the distance.</p> <ul style="list-style-type: none"> <li>• <b>1ft / 0.1ft</b></li> <li>• <b>0.1m / 0.01m</b></li> </ul> <p><b>Front L / Front R / Center / Subwoofer / Surround L / Surround R / S.Back L* / S.Back R* / F.Height L / F.Height R / F.Wide L / F.Wide R</b>                      : Select the speaker.</p> <p>* When the "Speaker Config." – "S.Back" setting (🔧 page 78) is set to "1spkr", "S.Back" is displayed.</p> <ul style="list-style-type: none"> <li>• <b>0.0ft – 60.0ft / 0.00m – 18.00m</b> : Set the distance.</li> </ul>

Setting items	Setting details
<b>Distance</b> (Continued)	<p>🔧</p> <ul style="list-style-type: none"> <li>• The speakers that can be selected differ depending on the "Amp Assign" (🔧 page 78) and "Speaker Config." (🔧 page 78) settings.</li> <li>• Default settings :                      Front L / Front R / Center / Subwoofer / F.Height L / F.Height R / F.Wide L / F.Wide R : 12.0 ft (3.6 m)                      Surround L / Surround R / S.Back L / S.Back R : 10.0 ft (3.0 m)</li> <li>• Set the difference in the distance between the speakers to less than 20 ft (6.0 m).</li> </ul> <p><b>NOTE</b></p> <p>Speakers set to "None" in "Speaker Config." (🔧 page 78) are not displayed.</p> <p><b>Default</b> : The "Distance" settings are returned to the default settings.</p> <ul style="list-style-type: none"> <li>• <b>Yes</b> : Reset to the defaults.</li> <li>• <b>No</b> : Do not reset to the defaults.</li> </ul> <p>🔧 When you select "Default" and press <b>ENTER</b>, the "Default Setting?" prompt is displayed. Select either "Yes" or "No", and press <b>ENTER</b>.</p>
<b>Channel Level</b> Set the volume of the test tone to be the same when it is output from each speaker.	<p><b>Test Tone Start</b> : Output test tone.</p> <ul style="list-style-type: none"> <li>• <b>Front L / F.Height L / Center / F.Height R / Front R / F.Wide R / Surround R / S.Back R* / S.Back L* / Surround L / F.Wide L / Subwoofer</b> : Select the speaker.</li> <li>* When the "Speaker Config." – "S.Back" setting (🔧 page 78) is set to "1spkr", "S.Back" is displayed.</li> <li>• <b>-12.0dB – +12.0dB (0.0dB)</b> : Adjust the volume.</li> </ul> <p>🔧</p> <ul style="list-style-type: none"> <li>• When ◀ is pressed while the subwoofer volume is set to "-12 dB", the "Subwoofer" setting switches to "OFF".</li> <li>• When "Channel Level" is adjusted, the adjusted values are set for all the surround modes. To adjust the channel level separately for the different surround modes, use the operation see page 56.</li> <li>• When you press <b>TEST TONE</b> on the remote control unit, you can enter this setting item immediately.</li> </ul> <p><b>NOTE</b></p> <ul style="list-style-type: none"> <li>• Speakers set to "None" in the "Speaker Config." (🔧 page 78) settings are not displayed.</li> <li>• When a headphones jack is inserted in the PHONES jack of this unit, the "Channel Level" is not displayed.</li> </ul> <p><b>Default</b> : The "Channel Level" settings are returned to the default settings.</p> <ul style="list-style-type: none"> <li>• <b>Yes</b> : Reset to the defaults.</li> <li>• <b>No</b> : Do not reset to the defaults.</li> </ul> <p>🔧 When you select "Default" and press <b>ENTER</b>, the "Default Setting?" prompt is displayed. Select either "Yes" or "No", and press <b>ENTER</b>.</p>











## Manual Setup

Setting items	Setting details
<b>Crossover Frequency</b> Set the maximum frequency of the bass signal output from each channel to the subwoofer. Set the Crossover Frequency to suit the bass reproduction capability of the speaker being used.	<p><b>Crossover</b> : Set the crossover frequency.</p> <ul style="list-style-type: none"> <li>• <b>40Hz / 60Hz / <u>80Hz</u> / 90Hz / 100Hz / 110Hz / 120Hz / 150Hz / 200Hz / 250Hz</b></li> </ul> <p><b>Advanced</b> : Specify crossover frequency for each speaker.</p> <ul style="list-style-type: none"> <li>• <b>Front / Center / Surround / S.Back / F.Height / F.Wide</b> : Select the speaker.</li> <li>• <b>40Hz / 60Hz / <u>80Hz</u> / 90Hz / 100Hz / 110Hz / 120Hz / 150Hz / 200Hz / 250Hz</b> : Set the crossover frequency.</li> </ul> <p> "Crossover Frequency" can be set when the "Bass Setting" – "Subwoofer Mode" ( page 79) setting is "LFE+Main", or when you have a speaker that is set to "Small".</p> <ul style="list-style-type: none"> <li>• Always set the crossover frequency to "80Hz". When using small speakers, however, we recommend setting the crossover frequency to a higher frequency.</li> <li>• For speakers set to "Small", sound below the crossover frequency is cut from the sound output. The cut bass sound is output from the subwoofer or front speakers.</li> <li>• The speakers that can be set when "Advanced" is selected differ depending on to the "Subwoofer Mode" setting ( page 79).             <ul style="list-style-type: none"> <li>• When "LFE" is selected, speakers set to "Small" at "Speaker Config." can be set. If the speakers are set to "Large", "Full Band" is displayed and the setting cannot be made.</li> <li>• If set to "LFE+Main", this setting can be made regardless of the speaker size.</li> </ul> </li> </ul>

## HDMI Setup

Default settings are underlined.

Make settings for HDMI video/audio output.

Setting items	Setting details
<b>RGB Range</b> Set the video range of RGB output from the HDMI connector.	<p><b>Normal</b> : Output with RGB video range (16 (black) to 235 (white)).</p> <p><b>Enhanced</b> : Output with RGB video range (0 (black) to 255 (white)).</p> <p> This setting is active when using a TV equipped with a DVI terminal.</p>
<b>Auto Lip Sync</b> Make automatic compensation for timing shift in audio and video output.	<p><b>ON</b> : Compensated.</p> <p><b>OFF</b> : Not compensated.</p>
<b>HDMI Audio Out</b> Select HDMI audio output device.	<p><b>AMP</b> : Play back through speakers connected to this unit.</p> <p><b>TV</b> : Play back through TV connected to this unit.</p> <p> When the HDMI control function is activated, priority is given to the TV audio setting ( page 55 "HDMI control function").</p>
<b>Monitor Out</b> Make settings for HDMI monitor output.	<p><b>Monitor 1</b> : A TV connected to the HDMI OUT 1 terminal is always used.</p> <p><b>Monitor 2</b> : A TV connected to the HDMI OUT 2 terminal is always used.</p> <p> With "Resolution" ( page 70) not set to "Auto", check whether the TV you are using is compatible with the resolution under "HDMI Information" – "HDMI Monitor 1 Information" and "HDMI Monitor 2 Information" ( page 88).</p>
<b>HDMI Control</b> You can link operations with devices connected to HDMI and compatible with HDMI Control.	<p><b>ON</b> : Use HDMI control function.</p> <p><b>OFF</b> : Do not use HDMI control function.</p> <p> When a device that is not compatible with the HDMI control function is connected, set "HDMI Control" to "OFF".</p> <ul style="list-style-type: none"> <li>• Please consult the operating instructions for each connected component to check the settings.</li> <li>• Refer to "HDMI control function" ( page 55) for more information about the HDMI control function.</li> </ul>

## NOTE

- **When "HDMI Control" is set to "ON", it consumes more standby power.** If you are not using this unit for an extended period, it is recommended that you unplug the power cord from the power outlet.
- "HDMI Control" does not work when the power to the equipment is off. Either turn power on or set to standby.
- The HDMI control function controls operations of a TV that is compatible with the HDMI control function. Make sure that the TV and HDMI are connected when you perform HDMI control.
- If the "HDMI Control" settings have been changed, always reset the power to connected devices after the change.



Setting items	Setting details
<b>Standby Source</b> Sets the HDMI input source to put into standby when the power is on.	<b>Last</b> : This item is set at the last-used input source. <b>HDMI1 / HDMI2 / HDMI3 / HDMI4 / HDMI5 / HDMI6</b> : Put the respective input source into standby. "Standby Source" can be set when "HDMI Control" is set to "ON".
<b>Power Off Control</b> Links the power standby of this unit to external equipment.	<b>All</b> : If power to a connected TV is turned off independently of the input source, power to this unit is automatically set to standby. <b>Video</b> : If power to a connected TV is turned off when the input source is BD / DVD / VCR / SAT / GAME / AUX1 / TV, power to this unit is automatically set to standby. <b>OFF</b> : This unit does not link with power to a TV. "Power Off Control" can be set when "HDMI Control" is set to "ON".

## Audio Setup

Default settings are underlined.

Make settings for audio playback.

Setting items	Setting details
<b>7.1ch IN SW Level</b> Setup playback method for analog signals inputted from 7.1CH INPUT connectors.	<b>Subwoofer Level</b> : Set playback level of subwoofer signal input from the 7.1CH INPUT connector. <ul style="list-style-type: none"> <li>• <b>+10dB</b> : This is the recommended level.</li> <li>• <b>+15dB / +5dB / 0dB</b> : Select the level according to the player being used.</li> </ul>
<b>EQ Customize</b> Set so that unused equalizer settings are not displayed when <b>MULTEQ</b> is pressed.	<b>Audyssey Byp. L/R</b> : Set when not using "Audyssey Byp. L/R" equalizer. <ul style="list-style-type: none"> <li>• <b>Used</b> : Use.</li> <li>• <b>Not Used</b> : Do not use.</li> </ul> Set so that "Audyssey Byp. L/R" settings can be made when Audyssey® Auto Setup is performed.
	<b>Audyssey Flat</b> : Set when not using "Audyssey Flat" equalizer. <ul style="list-style-type: none"> <li>• <b>Used</b> : Use.</li> <li>• <b>Not Used</b> : Do not use.</li> </ul> Set so that "Audyssey Flat" settings can be made when Audyssey Auto Setup is performed.
	<b>Manual</b> : Set when not using the "Manual" equalizer. <ul style="list-style-type: none"> <li>• <b>Used</b> : Use.</li> <li>• <b>Not Used</b> : Do not use.</li> </ul>

## Network Setup

Default settings are underlined>.

Make network settings.



Setting items	Setting details
<b>Network Connecting</b> Make settings for wired LAN.	<ol style="list-style-type: none"> <li>1. Connect the LAN cable (☞ page 24 "Connecting to a home network (LAN)").</li> <li>2. Turn on this unit (☞ page 7 "Turn on power").                      This unit performs automatic network setup due to the DHCP function. When connecting to a network that has no DHCP function, perform the setting in step 3.</li> <li>3. Set the IP address at the "Network Connecting".</li> </ol>



- 1 On the menu, select "Network Connecting" – "Detail" and press **ENTER**.
- 2 Use **<** **>** to set "DHCP" to "OFF", then press **∇**.  
 The DHCP function is disabled.
- 3 Use **△** **▽** to input the address and press **ENTER**.
  - **IP Address** : Set the IP address within the ranges shown below.  
 The Network Audio function cannot be used if other IP addresses are set.  
 CLASS A: 10.0.0.0 – 10.255.255.255  
 CLASS B: 172.16.0.0 – 172.31.255.255  
 CLASS C: 192.168.0.0 – 192.168.255.255
  - **Subnet Mask** : When connecting an xDSL modem or terminal adapter directly to this unit, input the subnet mask indicated in the documentation supplied by your provider. Normally input 255.255.255.0.
  - **Default Gateway** : When connected to a gateway (router), input its IP address.
  - **Primary DNS, Secondary DNS** : If there is only one DNS address indicated in the documentation supplied by your provider, input it at "Primary DNS". If there are two or more DNS addresses, input the first one at "Secondary DNS".



Manual Setup

Setting items	Setting details
<b>Network Connecting</b> (Continued)	<p>④ Use <math>\nabla</math> to select "Exit" and press <b>ENTER</b>.                      Setup is complete.</p> <ul style="list-style-type: none"> <li>When connecting to the network via a Proxy server, select "Proxy" and press <b>ENTER</b> (☞ page 82 "Proxy settings").</li> </ul> <p></p> <ul style="list-style-type: none"> <li>If you are using a broadband router (DHCP function), there is no need to make the settings at "IP Address" and "Proxy", since the DHCP function is set to "ON" in this unit's default settings.</li> <li>If this unit is being used connected to a network without the DHCP function, the network settings must be made. In this case, some knowledge of networks is required. For details, consult a network administrator.</li> <li>If you cannot connect to the Internet, recheck the connections and settings (☞ page 24).</li> <li>If you do not understand about Internet connection, contact your ISP (Internet Service Provider) or the store from which you purchased your computer.</li> <li>When you want to cancel the setting during IP address input, press <b>RETURN</b>.</li> </ul> <p><b>Proxy settings</b> : Make this setting when connecting to the Internet via a proxy server.</p> <div style="display: flex; justify-content: space-around;"> <div style="border: 1px solid black; padding: 5px; width: 45%;"> <p>MANUAL SETUP ▶ NETWORK SETUP ▶ NETWORK CONNECTING</p> <p>DHCP ON IP Address 192.168.100.19</p> <p>Exit</p> <p>Detail ← ①</p> <p>ENTER Enter RETURN Return Set IP address and proxy manually</p> </div> <div style="border: 1px solid black; padding: 5px; width: 45%;"> <p>MANUAL SETUP ▶ NETWORK SETUP ▶ NETWORK CONNECTING</p> <p>DHCP ON IP Address [192.168.100.019] Subnet Mask [255.255.255.000] Default gateway [000.000.000.000] Primary DNS [000.000.000.000] Secondary DNS [000.000.000.000]</p> <p>Proxy ← ②</p> <p>Exit</p> <p>ENTER Enter RETURN Return Set if using proxy server</p> </div> </div> <div style="border: 1px solid black; padding: 5px; width: 45%; margin: 10px auto;"> <p>MANUAL SETUP ▶ NETWORK SETUP ▶ NETWORK CONNECTING</p> <p>Proxy ON</p> <p>Proxy Address ④ → Address [000.000.000.000] ← ⑤</p> <p>Port ⑥ → [00000] ← ⑤</p> <p>Exit ← ⑦</p> <p>RETURN Return Proxy server is used</p> </div> <p>① On the menu, select "Network Connecting" – "Detail" and press <b>ENTER</b>.</p> <p>② Use <math>\Delta\nabla</math> to set "Proxy" and press <b>ENTER</b>.</p> <p>③ Use <math>\triangleleft\triangleright</math> to set "Proxy" to "ON" and press <math>\nabla</math>.                      The proxy server is enabled.</p>





Setting items	Setting details
<b>Network Connecting</b> (Continued)	<p>④ Use <math>\triangleleft\triangleright</math> to select the proxy server input method, and then press <math>\nabla</math>.  <b>Address</b> : Select when inputting by address.  <b>Name</b> : Select when inputting by domain name.</p> <p>⑤ Use <math>\Delta\nabla\triangleleft\triangleright</math> to input the proxy server address or domain name and press <b>ENTER</b>.                      When "Address" is selected in step ④ : Input the address                      When "Name" is selected in step ④ : Input the domain name</p> <ul style="list-style-type: none"> <li>For character input, see page 65.</li> </ul> <p>⑥ Use <math>\Delta\nabla\triangleleft\triangleright</math> to input the proxy server port number and press <b>ENTER</b>.</p> <p>⑦ Use <math>\nabla</math> to select "Exit" and press <b>ENTER</b>.                      Setup is complete.</p>
<b>Other</b> Network function on/off setting during standby, and PC language setting.	<p><b>Network Standby</b> : Set the network function on/off during standby.</p> <ul style="list-style-type: none"> <li><b>ON</b> : Network is on during standby. Main unit operable with a network compatible controller.</li> <li><b>OFF</b> : Suspend network function during standby.</li> </ul> <p> Set to "ON" when using the web control function.</p> <p><b>PC Language</b> : Select computer environment language.</p> <p>• <b>ara / chi (simpl) / chi (trad) / cze / dan / dut / eng / fin / fre / ger / gre / heb / hun / ita / jpn / kor / nor / pol / por / por(BR) / rus / spa / swe / tur</b></p> <p><b>Friendly Name Edit</b> : The Friendly Name is the name of this unit displayed on the network. Up to 63 characters can be input. The default Friendly Name on first use is "marantz:[AV7005]".</p> <ul style="list-style-type: none"> <li>For character input, see page 65.</li> </ul> <p><b>Default</b> : Restores Friendly Name, which you had changed, to the default setting.</p> <ul style="list-style-type: none"> <li><b>Yes</b> : Reset to the defaults.</li> <li><b>No</b> : Do not reset to the defaults.</li> </ul> <p> When you select "Default" and press <b>ENTER</b>, the "Default Setting?" prompt is displayed. Select either "Yes" or "No", and press <b>ENTER</b>.</p>

Setting items	Setting details
<b>Other</b> (Continued)	<p><b>Update Notification</b> : Displays a notification message on this unit's menu screen when the latest firmware is released with "Firmware Update". The notification message is displayed for about 20 seconds when the power is turned on. Connect to broadband Internet (☞ page 24) when using this function.</p> <ul style="list-style-type: none"> <li>• <b>ON</b> : Display update message.</li> <li>• <b>OFF</b> : Do not display update message.</li> </ul> <p></p> <ul style="list-style-type: none"> <li>• When you press <b>ENTER</b> during display of the notification message, the "Check for Update" screen is displayed. (Refer to page 86 for more information on "Firmware Update")</li> <li>• Press <b>RETURN</b> to erase the notification message.</li> </ul> <p><b>Upgrade Notification</b> : Display a notification message on this unit's menu screen when downloadable firmware is released with "Add New Feature". The notification message is displayed for about 20 seconds when the power is turned on. Connect to broadband Internet (☞ page 24) when using this function.</p> <ul style="list-style-type: none"> <li>• <b>ON</b> : Display upgrade message.</li> <li>• <b>OFF</b> : Do not display upgrade message.</li> </ul> <p></p> <ul style="list-style-type: none"> <li>• When you press <b>ENTER</b> during display of the notification message, the "Add New Feature" screen is displayed. (Refer to page 86 for more information on "Add New Feature")</li> <li>• Press <b>RETURN</b> to erase the notification message.</li> </ul>
<b>Rhapsody Account</b> Set or change Username and Password (☞ page 42 "Listening to Rhapsody").	<b>Username / Password / Account Number / Merge / Clear</b> • For character input, see page 65.
<b>Napster Account</b> Set or change Username and Password (☞ page 39 "Listening to Napster").	<b>Username / Password</b> • For character input, see page 65.
<b>Network Information</b> Display network information.	<b>Friendly Name / DHCP= ON/OFF / IP Address / MAC Address</b>

## Zone Setup

Default settings are underlined.

Set the audio to play back with multi-zone (ZONE2, ZONE3).

Setting items	Setting details
<b>Bass</b> Adjust low frequency range (bass).	<b>-10dB – +10dB (0dB)</b>
<b>Treble</b> Adjust high frequency range (treble).	<b>-10dB – +10dB (0dB)</b>
<b>HPF</b> Make settings for cutting the low range to reduce distortion in the bass.	<b>ON</b> : The low range is attenuated. <b>OFF</b> : The low range is not attenuated.
<b>Level Lch</b> Adjust the left channel output level.	<b>-12dB – +12dB (0dB)</b>  The "Level Lch" can be set when "Channel" (☞ page 83) is set to "Stereo".
<b>Level Rch</b> Adjust the right channel output level.	<b>-12dB – +12dB (0dB)</b>  The "Level Rch" can be set when "Channel" (☞ page 83) is set to "Stereo".
<b>Channel</b> Set the signal output from multi-zone.	<b>Stereo</b> : Select stereo output. <b>Mono</b> : Select mono output.
<b>Volume Level</b> Set the volume output level.	<b>Variable</b> : Volume adjustment is enabled by main unit and remote control unit. <b>-40dB (41)</b> : Fix volume at -40 dB. Set when adjusting volume by external amplifier. <b>0dB (81)</b> : Fix volume at 0 dB. Set when adjusting volume by external amplifier.  When "Amp Assign" (☞ page 78) is set to "ZONE2" or "ZONE3", the "Volume Level" setting is automatically set to "Variable".
<b>Volume Limit</b> Make a setting for maximum volume.	<b>OFF</b> : Do not set a maximum volume. <b>-20dB (61) / -10dB (71) / 0dB (81)</b>  <ul style="list-style-type: none"> <li>• This can be set when the multi-zone "Volume Level" setting (☞ page 83) is "Variable".</li> <li>• This is displayed from 0 to 99 when "Volume Display" (☞ page 84) is set to "Absolute".</li> </ul>





Manual Setup

Setting items	Setting details
<p><b>Power On Level</b> Define the volume setting that is active when the power is turned on.</p>	<p><b>Last</b> : Use the memorized setting from the last session.  <b>---</b> <b>(0)</b> : Always mute when power is turned on.  <b>-80dB - 18dB (1 - 99)</b> : The volume is adjusted to the set level.</p> <p></p> <ul style="list-style-type: none"> <li>This can be set when the multi-zone "Volume Level" setting (page 83) is "Variable".</li> <li>This is displayed from 0 to 99 when "Volume Display" (page 84) is set to "Absolute".</li> </ul>
<p><b>Mute Level</b> Set the amount of attenuation when muting is on.</p>	<p><b>Full</b> : The sound is muted entirely.  <b>-40dB</b> : The sound is attenuated by 40 dB down.  <b>-20dB</b> : The sound is attenuated by 20 dB down.</p>



Option Setup



Default settings are underlined.

Make various other settings.

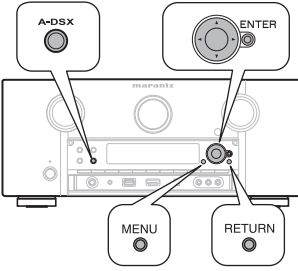
Setting items	Setting details
<p><b>Volume Control</b> Set the MAIN ZONE (room where the unit is located) volume setting.</p>	<p><b>Volume Display</b> : Set how volume is displayed.</p> <ul style="list-style-type: none"> <li><b>Relative</b> : Display -dB (Min), in the range -80.5 dB - 18 dB.</li> <li><b>Absolute</b> : Display in the range 0 (Min) - 99.</li> </ul> <p></p> <ul style="list-style-type: none"> <li>The "Volume Display" setting is applied also to the "Volume Limit" and "Power On Level" display method.</li> <li>The "Volume Display" setting applies to all zones.</li> </ul> <p><b>Volume Limit</b> : Make a setting for maximum volume.</p> <ul style="list-style-type: none"> <li><b>OFF</b> : Do not set a maximum volume.</li> <li><b>-20dB (61) / -10dB (71) / 0dB (81)</b></li> </ul> <p><b>Power On Level</b> : Define the volume setting that is active when the power is turned on.</p> <ul style="list-style-type: none"> <li><b>Last</b> : Use the memorized setting from the last session.</li> <li><b>---</b> <b>(0)</b> : Always use the muting on condition when power is turned on.</li> <li><b>-80dB - 18dB (1 - 99)</b> : The volume is adjusted to the set level.</li> </ul> <p><b>Mute Level</b> : Set the amount of attenuation when muting is on.</p> <ul style="list-style-type: none"> <li><b>Full</b> : The sound is muted entirely.</li> <li><b>-40dB</b> : The sound is attenuated by 40 dB down.</li> <li><b>-20dB</b> : The sound is attenuated by 20 dB down.</li> </ul>
<p><b>Source Delete</b> Remove from the display input sources that are not used.</p>	<p><b>BD / DVD / VCR / SAT / GAME / AUX1 / NET / USB / TV / CD / CDR / PHONO / SIRIUS / HD Radio / M-XPort</b> : Select input source that is not used.</p> <ul style="list-style-type: none"> <li><b>ON</b> : Use this source.</li> <li><b>Delete</b> : Do not use this source.</li> </ul> <p><b>NOTE</b></p> <ul style="list-style-type: none"> <li>Input sources being used in the various zones cannot be deleted.</li> <li>Input sources set to "Delete" cannot be selected using <b>SOURCE SEL</b>.</li> </ul>
<p><b>GUI</b> Make the settings related to displays on the TV screen.</p>	<p><b>Screensaver</b> : Make screensaver settings.</p> <ul style="list-style-type: none"> <li><b>ON</b> : The screensaver is activated during menu display, NET/USB, iPod, SIRIUS or HD Radio screen display if no operation is performed for an approximately 3-minute continuous period. When you press <math>\Delta \nabla \triangleleft \triangleright</math>, the screensaver is cancelled and the screen before that screen saver started is displayed.</li> <li><b>OFF</b> : Screensaver is not activated.</li> </ul>



Setting items	Setting details
<b>GUI</b> (Continued)	<p><b>Wall Paper</b> : Set wallpaper to display in the background when playback is stopped, etc.</p> <ul style="list-style-type: none"> <li>• <b>Picture</b> : Set the background to a picture (Marantz logo).</li> <li>• <b>Black</b> : Set the background to black.</li> </ul> <p><b>Format</b> : Set the video signal format to be output for the TV you are using.</p> <ul style="list-style-type: none"> <li>• <b>NTSC</b> : Select NTSC output.</li> <li>• <b>PAL</b> : Select PAL output.</li> </ul> <p> "Format" can also be set by the following procedure. However, the menu screen is not displayed.</p> <ol style="list-style-type: none"> <li>1. Press and hold the main unit's <b>A-DSX</b> and <b>RETURN</b> for at least 3 seconds. "Video Format" appears on the display.</li> <li>2. Press ◀▶ and set the video signal format.</li> <li>3. Press the main unit's <b>ENTER</b>, <b>MENU</b> or <b>RETURN</b> to complete the setting.</li> </ol>  <p><b>NOTE</b></p> <p>When a format other than the video format of the connected TV is set, the picture will not be displayed properly.</p> <p><b>Text</b> : Display the details of operation when switching surround mode, input mode, etc.</p> <ul style="list-style-type: none"> <li>• <b>ON</b> : Turn display on.</li> <li>• <b>OFF</b> : Turn display off.</li> </ul> <p><b>Master Volume</b> : Display the master volume during adjustment.</p> <ul style="list-style-type: none"> <li>• <b>Bottom</b> : Display at the bottom.</li> <li>• <b>Top</b> : Display at the top.</li> <li>• <b>OFF</b> : Turn display off.</li> </ul> <p> When the master volume display is hard to see when superimposed on movie subtitles, set to "Top".</p> <p><b>NET/USB</b> : Set the NET/USB screen display time when the input source is "NET/USB".</p> <ul style="list-style-type: none"> <li>• <b>Always</b> : Show display continuously.</li> <li>• <b>30sec</b> : Show display for 30 seconds after operation.</li> <li>• <b>10sec</b> : Show display for 10 seconds after operation.</li> <li>• <b>OFF</b> : Turn display off.</li> </ul>

Setting items	Setting details
<b>GUI</b> (Continued)	<p><b>TUNER</b> : Set the tuner screen display time when the input source is "SIRIUS" or "HD Radio".</p> <ul style="list-style-type: none"> <li>• <b>Always</b> : Show display continuously.</li> <li>• <b>30sec</b> : Show display for 30 seconds after operation.</li> <li>• <b>10sec</b> : Show display for 10 seconds after operation.</li> <li>• <b>OFF</b> : Turn display off.</li> </ul> <p><b>iPod</b> : Set the iPod screen display time when the input source is "NET/USB".</p> <ul style="list-style-type: none"> <li>• <b>Always</b> : Show display continuously.</li> <li>• <b>30sec</b> : Show display for 30 seconds after operation.</li> <li>• <b>10sec</b> : Show display for 10 seconds after operation.</li> <li>• <b>OFF</b> : Turn display off.</li> </ul>
<b>Component 2 Output</b> Set whether to use the component 2 output terminal as MAIN ZONE or ZONE2.	<p><b>MAIN ZONE</b> : Use the component 2 output terminal as a monitor output for MAIN ZONE.</p> <p><b>ZONE2</b> : Use the component 2 output terminal as a monitor output for ZONE2.</p>
<b>Zone Rename</b> Change the display title of each zone to one you prefer.	<ul style="list-style-type: none"> <li>• Up to 10 characters can be input.</li> <li>• For character input, see page 65.</li> </ul>
<b>Trigger Out</b> Select the condition for activating Trigger Out 1/2 for the input source, surround mode, etc. See "DC OUT (TRIGGER OUT) jacks" (🔧 page 54) for more information on trigger out.	<p><b>Trigger Out 1 / Trigger Out 2</b></p> <p><input type="checkbox"/> <b>When setting for zone (MAIN ZONE / ZONE2 / ZONE3)</b> Trigger out is activated through linkage to the power of the zone set to "ON".</p> <p><input type="checkbox"/> <b>When setting for input source</b> Activate trigger out when the input source set to "ON" is selected.</p> <p> Active for the zone set to "ON" with "When Setting for Zone".</p> <p><input type="checkbox"/> <b>When setting for HDMI monitor</b> Activate trigger out when the HDMI monitor set to "ON" is selected.</p> <p> Active when the "MAIN ZONE" set to "ON" with "When Setting for Zone" is selected, and when the input source set to "ON" with "When Setting for Input Source" is selected.</p> <ul style="list-style-type: none"> <li>• <b>ON</b> : Activate trigger on this mode.</li> <li>• <b>---</b> : Do not activate trigger on this mode.</li> </ul> <p><b>Default</b> : The "Trigger Out" settings are returned to the default settings.</p> <ul style="list-style-type: none"> <li>• <b>Yes</b> : Reset to the defaults.</li> <li>• <b>No</b> : Do not reset to the defaults.</li> </ul>

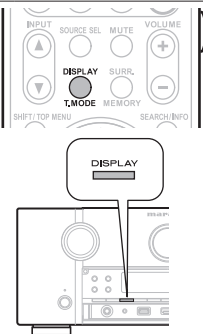

Manual Setup

Setting items	Setting details
<p><b>Display</b> Set the display on/off setting.</p>	<p><b>ON</b> : Display is always on.  <b>Display Auto OFF</b> : Display is off except when showing the status display.  <b>Display OFF</b> : Display is always off.</p> <p> This can also be set by pressing <b>DISPLAY</b>. Each time <b>DISPLAY</b> is pressed, the setting is changed as shown below.</p> <p> </p> 
<p><b>Setup Lock</b> Protect settings from inadvertent change.</p>	<p><b>ON</b> : Turn protection on.  <b>OFF</b> : Turn protection off.</p> <p> When canceling the setting, set "Setup Lock" to "OFF".</p> <p><b>NOTE</b></p> <p>When "Setup Lock" is set to "ON", the settings listed below can no longer be changed. Also, "SETUP LOCKED!" is displayed if you attempt to operate related settings.</p> <ul style="list-style-type: none"> <li>· Menu operations</li> <li>· M-DAX</li> <li>· Dynamic Volume®</li> <li>· Channel Level</li> <li>· MultEQ® XT</li> <li>· Dynamic EQ®</li> </ul>
<p><b>Maintenance Mode</b> Use when receiving maintenance from a Marantz service engineer or custom installer.</p>	<p><b>NOTE</b></p> <p>Only use this function if so instructed by a Marantz serviceperson or installer.</p>

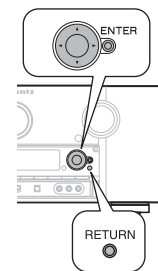
Setting items	Setting details												
<p><b>Firmware Update</b> Update the firmware of this unit.</p>	<p><b>Check for Update</b> : Check for firmware updates. You can also check approximately how long it will take to complete an update.  <b>Start</b> : Execute the update process.</p> <p>When updating starts, the power indicator becomes red and the menu screen is shut down. The amount of update time which has elapsed is displayed.</p> <p>When updating is complete, the power indicator becomes green and normal status is resumed.</p> <ul style="list-style-type: none"> <li>• If updating fails, the set automatically retries, but if updating is still not possible, one of the messages shown below is displayed. If the display reads as shown below, check the settings and network environment, then update again.</li> </ul> <table border="1" data-bbox="1444 502 2128 662"> <thead> <tr> <th>Display</th> <th>Description</th> </tr> </thead> <tbody> <tr> <td><b>Updating fail</b></td> <td>Updating failed.</td> </tr> <tr> <td><b>Login failed</b></td> <td>Failure to log into server.</td> </tr> <tr> <td><b>Server is busy</b></td> <td>Server is busy. Wait a while then try again.</td> </tr> <tr> <td><b>Connection fail</b></td> <td>Failure in connecting to server.</td> </tr> <tr> <td><b>Download fail</b></td> <td>Downloading of the firmware has failed.</td> </tr> </tbody> </table>	Display	Description	<b>Updating fail</b>	Updating failed.	<b>Login failed</b>	Failure to log into server.	<b>Server is busy</b>	Server is busy. Wait a while then try again.	<b>Connection fail</b>	Failure in connecting to server.	<b>Download fail</b>	Downloading of the firmware has failed.
Display	Description												
<b>Updating fail</b>	Updating failed.												
<b>Login failed</b>	Failure to log into server.												
<b>Server is busy</b>	Server is busy. Wait a while then try again.												
<b>Connection fail</b>	Failure in connecting to server.												
<b>Download fail</b>	Downloading of the firmware has failed.												
<p><b>Add New Feature</b> Display new features that can be downloaded to this unit and perform an update.</p>	<p><b>Upgrade</b> : Execute the upgrade process.</p> <p>When updating starts, the power indicator becomes red and the menu screen is shut down. The amount of update time which has elapsed is displayed.</p> <p>When upgrading is complete, the power indicator becomes green and normal status is resumed.</p> <ul style="list-style-type: none"> <li>• If the upgrade is not successful, an error message identical to those in "Firmware Update" will appear on the display. Check the settings and network environment, then update again.</li> </ul> <p><b>Upgrade Status</b> : Display a list of the additional functions provided by the upgrade.</p> <p> See the Marantz website for details about updates.</p> <p>When the procedure is complete, "Registered" is displayed in this menu and updates can be carried out. If the procedure has not been carried out, "Not Registered" is displayed.</p> <p>The ID number shown on this screen is needed when carrying out the procedure. The ID number can also be displayed by pressing and holding  and <b>RETURN</b> for at least 3 seconds.</p> 												



## Manual Setup

## Notes concerning use of "Firmware Update" and "Add New Feature"

- In order to use these functions, you must have the correct system requirements and settings for a broadband Internet connection (☞ page 24).
- Do not turn off the power until updating or upgrading is completed.
- Even with a broadband connection to the Internet, approximately 1 hour is required for the updating/upgrading procedure to be completed.
- Once updating/upgrade starts, normal operations on this unit cannot be performed until updating/upgrading is completed.
- Furthermore, updating/upgrading the firmware may reset the backup data for the parameters, etc. set for this unit.
- The following backup data may be erased after an update or upgrade.
  - Internet radio preset channel
  - Internet radio Recently Played data
  - Username registered for Flickr Contact
  - Data in Internet radio, media server and USB memory device
- If the update or upgrade fails, press and hold the **ON/STANDBY** on the main unit for more than 5 seconds, or remove and re-insert the power cord. "Update retry" appears on the display and update restarts from the point at which update failed. If the error continues despite this, check the network environment.

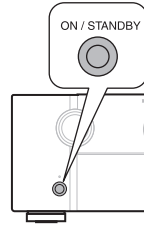

- Information regarding the "Firmware Update" function and "Add New Feature" will be announced on the Marantz web site each time related plans are defined.
- When usable new firmware is released with "Firmware Update" or "Add New Feature", a notification message is displayed on the menu screen. When you do not want to be notified, set "Update Notification" (☞ page 83) and "Upgrade Notification" (☞ page 83) to "OFF".

## Remote control operation buttons



Move the cursor  
(Up/Down/Left/Right)



Confirm the setting

RETURN



Return to previous menu

# Information

Show information about this unit settings, input signals, etc.

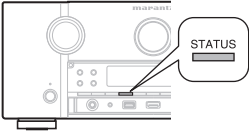
Items	Setting details
<b>Status</b> Show information about current settings.	<input type="checkbox"/> <b>MAIN ZONE</b> This item shows information about settings for MAIN ZONE. The information displayed differs according to the input source. <b>Select Source / Name / Surround Mode / Input Mode / Decode Mode / HDMI / Digital / Component / Video Select / Video Mode / Content Type / Video Convert / i/p Scaler / Resolution / Progressive Mode / Aspect</b> etc.
	<input type="checkbox"/> <b>ZONE2</b> This item shows information about settings for ZONE2. <b>Power / Select Source / Volume Level</b>
	<input type="checkbox"/> <b>ZONE3</b> This item shows information about settings for ZONE3. <b>Power / Select Source / Volume Level</b>
<b>Audio Input Signal</b> Show information about audio input signals.	<p><b>Surround Mode</b> : The currently set surround mode.  <b>Signal</b> : The input signal type.  <b>fs</b> : The input signal's sampling frequency.  <b>Format</b> : The number of channels in the input signal (front, surround, LFE).  <b>Offset</b> : The dialogue normalization correction value.  <b>Flag</b> : This is displayed when inputting signals including a surround back channel. "MATRIX" is displayed with Dolby Digital EX and DTS-ES Matrix signals, "DISCRETE" with DTS-ES Discrete signals.</p> <div style="border: 1px solid black; padding: 5px;"> <p style="text-align: center;"><b>Dialogue normalization function</b></p> <p>This function is automatically activated when playing Dolby Digital sources. It automatically corrects the standard signal level for individual program sources. The correction value can be checked using the <b>STATUS</b>.</p> <div style="display: flex; align-items: center;"> <div style="border: 1px solid black; padding: 5px; margin-right: 10px;">                     Dial.Norm                      Offset - 4dB                 </div>  </div> <p>The figure is the corrected value. This cannot be changed.</p> </div>

Items	Setting details
<b>HDMI Information</b> Show information about HDMI input/output signals and monitor.	<b>HDMI Signal Information</b> • <b>Resolution / Color Space / Pixel Depth</b> <b>HDMI Monitor 1 Information / HDMI Monitor 2 Information</b> • <b>Interface / Supported resol.</b>  "HDMI Monitor 1 Information" or "HDMI Monitor 2 Information" displays information on the HDMI monitor currently being used.
<b>Preset Channel</b> Show information about preset channels.	<b>A / B / C / D / E / F / G</b> <b>A1 - A8 / B1 - B8 / C1 - C8 / D1 - D8 / E1 - E8 / F1 - F8 / G1 - G8</b>
<div style="border: 1px solid black; padding: 2px; display: inline-block; margin-right: 5px;">NET/USB</div> <div style="border: 1px solid black; padding: 2px; display: inline-block; margin-right: 5px;">SIRIUS</div> <div style="border: 1px solid black; padding: 2px; display: inline-block;">HD Radio</div>	



## Other settings

### Remote control settings

- When you connect a remote control receiver unit (purchased separately) to the REMOTE CONTROL IN terminal of this unit, use the following procedure to disable the remote sensor function of this unit.
- The remote sensor function of remote control signals is enabled by default.

**ON/STANDBY**

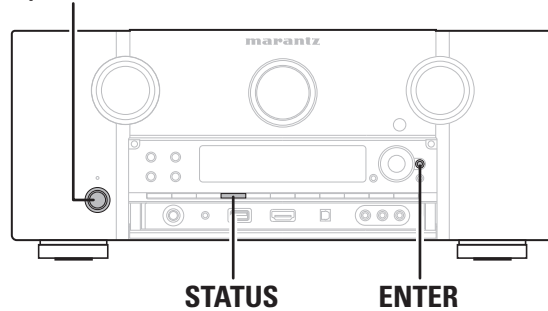

#### ❑ Disabling the sensor function of the remote control unit

**When the main unit is in standby mode, press ON/STANDBY while holding down STATUS and ENTER on the main unit.**

"Remote Lock:ON" is shown on the display, and the infrared light receiving function is disabled.

#### ❑ Enabling the remote sensor function

**When the main unit is in standby mode, press ON/STANDBY while holding down STATUS and ENTER on the main unit.**

The infrared light receiving function on the main unit is enabled.

#### NOTE

If a remote control receiver unit (purchased separately) is not connected, do not perform this setting. If you do, you will not be able to operate this unit using the remote control unit.

### Switches light illumination on/off

You can switch the lighting around the main display on or off.

- The factory setting is "ON".

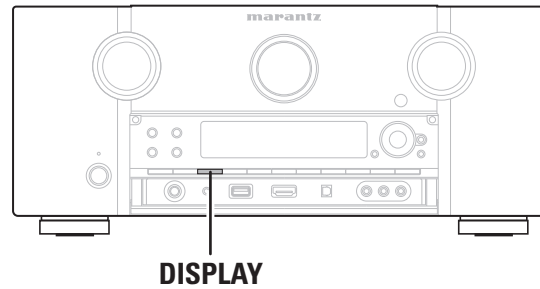

**Press and hold DISPLAY on the main unit for 3 seconds.**

- Carry out the same procedure if you want to change the settings again.



# Operating the connected devices by remote control unit

Registering the supplied preset codes in the remote control unit enables you to operate devices made by other manufacturers.

## Operating AV equipment

### 1 Press the input source select button (☞ page 25).

The remote control operating mode switches as shown in the table below, and the mode name is shown in the remote control display.

#### NOTE

Press the input source select buttons once to switch the operation mode of the remote control unit supplied with this unit. Press the input source select buttons twice consecutively to switch the operation mode of the remote control unit and input source of this unit.



Input source select buttons	Input source of this unit	Devices controllable with the remote control unit (Operation mode)
BD *	BD	Device registered on the <b>BD</b> button
DVD *	DVD	Device registered on the <b>DVD</b> button
VCR	VCR	Device registered on the <b>VCR</b> button
SAT *	SAT	Device registered on the <b>SAT</b> button
GAME	GAME	Device registered on the <b>GAME</b> button
AUX1	AUX1	Device registered on the <b>AUX1</b> button
NET/USB	NET/USB	<ul style="list-style-type: none"> <li>• Network function</li> <li>• iPod or USB memory device connected to the USB port</li> </ul>
TV *	TV	Device registered on the <b>TV</b> button
CD *	CD	Device registered on the <b>CD</b> button
CDR	CDR	Device registered on the <b>CDR</b> button
SATR	SIRIUS	SIRIUS Satellite Radio
TUNE	HD Radio	HD Radio receiver
M-XP	M-XPport	Device registered on the <b>M-XP</b> button

\* If a preset code is registered for this button, the remote control unit of this unit can control another devices.

#### NOTE

If the mode of the remote control unit is set to other than amp-operation mode, press **AMP** to switch the remote control unit to the amp-operation mode to perform the following operations:

- For menu operation by pressing **MENU**
- For setting the channel level of the unit by pressing **CH LVL**
- For performing direct playback
- For switching Audyssey DSX™, MultEQ XT®, Dynamic EQ® and Dynamic Volume® settings.
- For using the Video Select function.
- For using the sleep timer function.
- For displaying the Source Select screen.
- For switching the M-DAX function.
- For directly selecting "AUTO" and "STEREO" of the listening modes.

### 2 Operate this unit or the device whose input source is switched.

- For details, refer to the operating instructions for each device. For operations of iPod and HD Radio receiver, see the following pages.
  - iPod (☞ page 28)
  - HD Radio receiver (☞ page 34)

## Registering preset codes

When preset codes are registered in the included remote control unit, it can then be used to operate any devices you have, such as DVD players or TVs made by different manufacturers.

### NOTE

- No preset codes other than **BD**, **DVD**, **TV**, **SAT** and **CD** can be registered.
- In the factory settings, remote control codes for all Marantz products are registered.

### Buttons used for operating the devices

- SOURCE ON/OFF**  
For switching power of each device on or off.
- △▽◁▷, ENTER**  
For menu operation of each device.
- MENU, SETUP, TOP MENU**  
For displaying the menu of each device.
- ▶, ■, II, ◀▶, ▶▶, I◀◀, ◀◀I**
- Number button (**0–9, +10**)
- PRESET +, PRESET –**
- TV POWER, TV INPUT**  
For operating a TV.  
This button is enabled in any mode.

For details on operation with the remote control unit, see pages 28 – 43, 92.

## Registering preset codes

The following two methods can be used for registering the reset code.

- Entering a 4-digit code
- Scanning the code table

### 1 Entering a 4-digit code

See the preset code list table for the code to be input.

- Press and hold down the input source select buttons for the appliance to control, and press SET until indicator blinks twice.**  
The back light flashes.

- Press the 4-digit code for the appliance using the numeric buttons (code table at the end of this book).**
  - The 4-digit code is shown in the remote control display.
  - When the settings are complete, "OK" is shown in the remote control display.

- If "NG" is displayed in the remote control display, repeat steps 1 and 2, and enter the same code again.

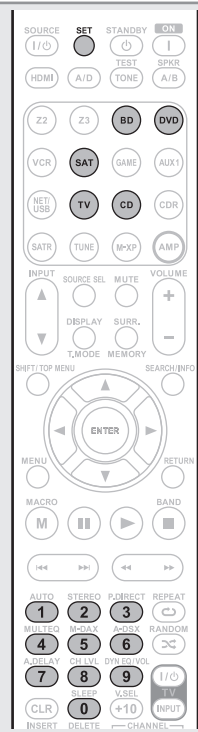

### 2 Scanning the code table

- Switch the power on of the device for which you want to set the preset code.**

- Press and hold down the input source select buttons for the appliance to control, and press SET until indicator blinks twice.**  
The back light flashes.

- Aim the remote control at the appliance and slowly alternate between pressing INPUT ▲ and SOURCE ON/OFF for the appliance.**  
The preset code is shown in the remote control display.

- Stop when the appliance turns off.**

- Press ENTER once to lock in the code.**

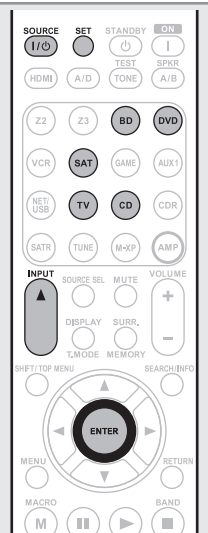

## Check the registered preset code

- Press and hold down the input source select buttons for appliance to control, and press SET until indicator blinks twice and back light flashes.**  
The back light flashes.

- Press SEARCH/INFO.**  
The display flashes twice, after which the set code is shown for 3 seconds in the remote control display.



Registering preset codes

Default settings for preset codes

The devices shown below are registered for each input source button as default. Settings can be changed according to the devices to be used.

**1** Press and hold down the input source select buttons for appliance to control and press **SET** until indicator blinks twice.

The back light flashes.

**2** Enter the appropriate preset code (4 digits) from the table below. The display flashes twice.

Input source select buttons	Category	Preset code
BD	Blu-ray Disc player	5000
DVD	DVD player	2000
TV	Television	1000
SAT	Satellite set top box	4000
CD	CD player	3000

**NOTE**

After this procedure, the selected source reset to its initial code.

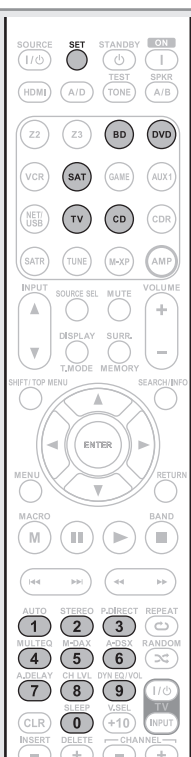

Operating components

The supplied remote control unit can control a component other than this unit.

**1** Switch the input source (page 25).

**2** Operate the component.

- For details, refer to the component's operating instructions.



Blu-ray Disc player / HD-DVD player / DVD player / DVD recorder operation

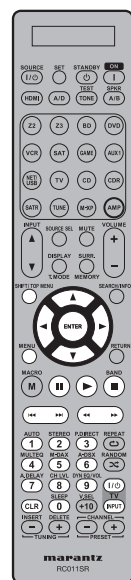

Operation buttons	Function
SOURCE ON/OFF	Power on/standby
MENU	(Popup) Menu
TOP MENU	Top menu
△▽◀▶	Cursor operation
ENTER	Enter
◀◀▶▶	Manual search (fast-reverse/fast-forward)
▶	Playback
◀◀▶▶I	Auto search (cue)
II	Pause
■	Stop
0-9	Select title, chapter or channel selection
CLR	Clear the inputting
TV POWER	TV power on/standby (Default : Marantz)
TV INPUT	Switch TV input (Default : Marantz)

CD player / CD recorder operation



Operation buttons	Function
SOURCE ON/OFF	Power on/off
◀◀▶▶	Manual search (fast-reverse/fast-forward)
▶	Playback
◀◀▶▶I	Auto search (cue)
II	Pause
■	Stop
CLR	Clear the inputting
TV POWER	TV power on/standby (Default : Marantz)
TV INPUT	Switch TV input (Default : Marantz)

TV operation



Operation buttons	Function
SOURCE ON/OFF	TV power on/standby (Default : Marantz)
CHANNEL +, -	Switch channels (up/down)
CLR	Clear the inputting
TV POWER	TV power on/standby (Default : Marantz)
TV INPUT	Switch TV input (Default : Marantz)

Operating components

■ Set top box for satellite (SAT) operation

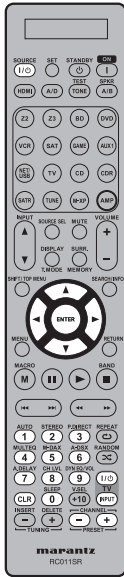

Operation buttons	Function
<b>SOURCE ON/OFF</b>	Power on/standby
<b>CHANNEL +, -</b>	Switch channels (up/down)
△▽◀▶	Cursor operation
<b>ENTER</b>	Enter
<b>0 - 9</b>	Channel selection
<b>CLR</b>	Clear the inputting
<b>TV POWER</b>	TV power on/standby (Default : Marantz)
<b>TV INPUT</b>	Switch TV input (Default : Marantz)

## Operating learn function

- If the AV device is not a Marantz device, or if the device does not operate even when the preset code is registered, use the learning function. Remote codes for different devices can be remembered for use by the Marantz remote control included with this device.
- This remote control unit is capable of learning around 160 codes.

### Remembering remote control codes from other devices

**1** Place the Marantz remote control and remote control from the other device approximately 5 cm apart, with the remote control signal transmission sections facing each other.

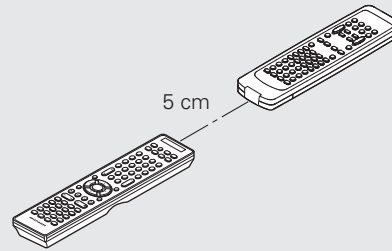

**2** Press and hold down **SET** and **SOURCE SEL** until the **LEARN** indicator blinks.

**3** Press input source select buttons to select the input source.

The input source is shown in the remote control display.

**4** Select the button to be learned. LEARN indicator lights up.



**5** Press and hold the button that you want to register on the other remote control until “OK” is displayed on the Marantz remote control display.

- If “NG” is shown on the remote control display, perform step 5 again. If “NG” is shown again on the remote control display, the remote control may not be able to learn the code correctly. In this case, use the specialized remote control for the device.
- If the remote control memory becomes full, “FULL” is shown on the remote control display. If you want to learn the code, you should erase other learned button.

**6** Repeat steps 4 and 5 to learn other buttons for the same input source.

**7** Repeat steps 3 to 6 to learn other input sources.

**8** When programming of the remote control unit is completed, press **SET**.

The LEARN display disappears, and the remote control unit exits learn mode.

**NOTE**

- The learning function is unavailable for all **SOURCE ON/OFF**, **MACRO** and **HDMI** in any mode.
- The learning function is unavailable for all buttons in TUNER mode, AMP mode, NET/USB mode and M-XP mode.
- The learning procedure does not operate correctly if the batteries have become worn.
- If no buttons are pressed for approximately 1 minutes while in the LEARN mode, the remote control unit automatically exits from the LEARN mode.

## Operating learn function

## Delete saved remote control codes

Codes can be erased in three ways: by buttons, sources, and by all memory contents.

## Delete remote control codes for each button

**1** Press and hold down **SET** and **SOURCE SEL** until the **LEARN** indicator blinks.

**2** Press input source select buttons to select the input source you want to delete.

The input source is shown in the remote control display.

**3** Press and hold down **HDMI** and press the learned button to be erased twice.

"ERASE" is shown in the remote control display, and the mode returns to learning mode.

- To return the normal mode, press **SET**.

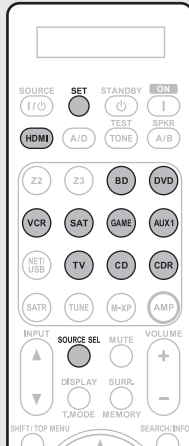

## Delete remote control codes for all input sources

**1** Press and hold down **SET** and **SOURCE SEL** until the **LEARN** indicator blinks.

**2** Press and hold down **HDMI** and press **ON** and **STANDBY**. **LEARN** indicator lights.

**3** Press **ENTER** to continue erasing. "ERASE" is shown in the remote control display, and the mode returns to learning mode.

- To cancel the erasing operation, do not press **ENTER** and simply press any other button.
- To return the normal mode, press **SET**.



## NOTE

Erasing codes will return to the factory preset code, or there will leave empty if the button has no factory preset code.

## Delete remote control codes for each input source

**1** Press and hold down **SET** and **SOURCE SEL** until the **LEARN** indicator blinks.

**2** Press and hold down **HDMI** and press the learned input source select buttons to be erased twice.

"ERASE" is shown in the remote control display.

**3** Press **ENTER** to continue erasing. The **LEARN** indicator blinks twice and the mode returns to LEARN mode.

- To cancel the erasing operation, do not press **ENTER**, and simply press any other button.
- To return the normal mode, press **SET**.



## Operating macro function

- When the macro function is used, operations that usually require a complicated series of multiple button operations can be performed easily just by pressing the **MACRO** button.
- This device can remember up to 6 macro functions.
- Each macro can record a maximum of 10 steps.

**[Example]** To playback a DVD

- ① Turn this unit's power on
- ② Switch this unit's input source to DVD
- ③ Turn the TV's power on
- ④ DVD Playback

## Recording macro operations

**[Example]** Recording DVD playback operations to the number "1" button

- 1 Press and hold SET and MACRO together until "MACRO" flashes in the LEARN indicator, MACRO indicator and remote control display.**



- 2 Press the macro operation number ("1") that you want to record to.**  
"M1-01" is shown in the remote control display.

- If the number that you want to record to has already been recorded to, the recorded number flashes in the display.

- 3 Press the input source switch button ("DVD") of the operation that you want to record along with the command button ("▶").**  
The macro operation step number is shown in the remote control display.

- To record the amp input source, press **AMP** first, followed by the input source switching button.

- 4 When the macro operation recording is complete, press and hold ENTER until the LEARN indicator and MACRO indicator switch off.**

### NOTE

The **RETURN**,  $\Delta \nabla \triangleleft \triangleright$ , **ENTER**, **VOLUME +, -** and **CLR** buttons cannot be recorded as macro operations.

## Checking recorded macro operations

**[Example]** Checking the recorded macro operations to button "1"

- 1 Press and hold MACRO and MENU together until "MACRO" flashes in the LEARN indicator, MACRO indicator and remote control display.**

- 2 Press the number button ("1") that you want to check.**

The LEARN indicator, MACRO indicator and "M1-01" flashes in the remote control display.

- 3 Press the VOLUME +, -.**
  - The LEARN indicator switches off, and "M1-01" is shown in the remote control display.
  - The recorded macro operation is performed.

- 4 Repeat step 3 until the final number of the macro operation is displayed.**

- The display returns to that of step 1.
- When the macro operation number is displayed, the corresponding macro operation is performed.

- 5 When the macro operation check is complete, press and hold ENTER until the MACRO indicator switches off.**

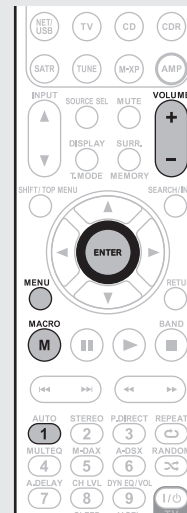

## Editing recorded macro operations

**[Example]** Changing macro operation "1" recorded on number button "▶" to "■", and changing the number button to "2"

- 1 Press and hold MACRO and MENU together until "MACRO" flashes in the LEARN indicator, MACRO indicator and remote control display.**

- 2 Press the number button ("1") that you want to change.**  
The LEARN indicator, MACRO indicator and "M1-01" flashes in the remote control display.

- 3 Press  $\Delta \nabla$  to select the macro operation button ("2") to edit.**  
After the macro operation button is displayed, the recorded operation is performed.

- When the macro operation is updated as a recorded step, press the input source switching button, and then press the new step button ("2").
- To insert a new macro operation between recorded steps, after performing step 3, press **MEMORY** and then press the new step button ("2").  
When a new step is introduced, if the total number of steps is already 10, the 10th step is deleted after the new step is introduced.
- To delete recorded macro operations, after step 3, call the step number that you want to delete, and press **CLR**.
- To return to step 1, press **ENTER**.

- 4 When the macro operation edit is complete, press and hold ENTER until the MACRO indicator switches off.**





## Operating macro function

## Using macro operations

[Example] Using the recorded macro operations to button "1"

**1 Press the MACRO.**  
"MACRO" is shown in the MACRO indicator and remote control display.

**2 Press the number button ("1") that you want to use.**

Macro operations recorded to number button "1" are performed one at a time.

- The step number shown in the remote control display disappears after the step is performed.
- When all macro operations are completed, the remote control returns to the amp operation mode.



## Deleting recorded macro operations

[Example] Deleting the macro operations recorded to button "2"

**1 Press and hold MACRO and MENU together until "MACRO" flashes in the LEARN indicator, MACRO indicator and remote control display.**

**2 Press and hold CLR and the number ("2") that you want to delete for approximately 3 seconds.**

"M2-CL" flashes in the remote control display.

**3 Press the ENTER.**  
The recorded macro operation is deleted, and the remote control returns to step 1.

- To cancel the macro delete operation, press a different button without pressing ENTER.

**4 When the macro operation delete is complete, press and hold ENTER until the MACRO indicator switches off.**



## Adjusting the interval time of macro operations transmitting

The macro operation transmission interval can be adjusted.

- The factory setting is "1 second".

**1 Press and hold MACRO and SOURCE SEL until "SETUP" is shown in the remote control display.**

"SETUP" is shown for 3 seconds in the remote control display, after which "MCR05z" is displayed.

- \* The current transmission interval is shown.

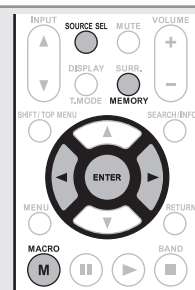

**2 Press < > to change to the desired transmission interval.**

- The interval time can be changed from 0.5 to 5 seconds by 0.5 seconds step.

**3 When the adjustment is complete, press and hold ENTER until the MACRO indicator switches off.**

## Setting the back light

Press the Light button on the side of the remote control, and the buttons on the remote control light for 2 seconds. If the Light button is pressed while the buttons are lit, the buttons remain lit for another 2 seconds.

- Backlight is set on in the factory settings.

## Disabling the backlight

Press and hold both SET and STANDBY until indicator flashes twice.

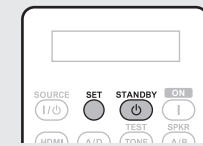

## Turning the backlight on



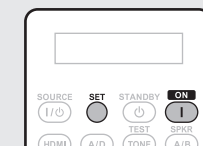

Press and hold both SET and ON until indicator flashes twice.



## Information

---

Here, we list various information related to this unit.  
Please refer to this information as needed.

- Part names and functions  page 98
- Other information  page 103
- Troubleshooting  page 112
- Specifications  page 116
- Index  page 117

# Part names and functions

## Front panel

For buttons not explained here, see the page indicated in parentheses ( ).

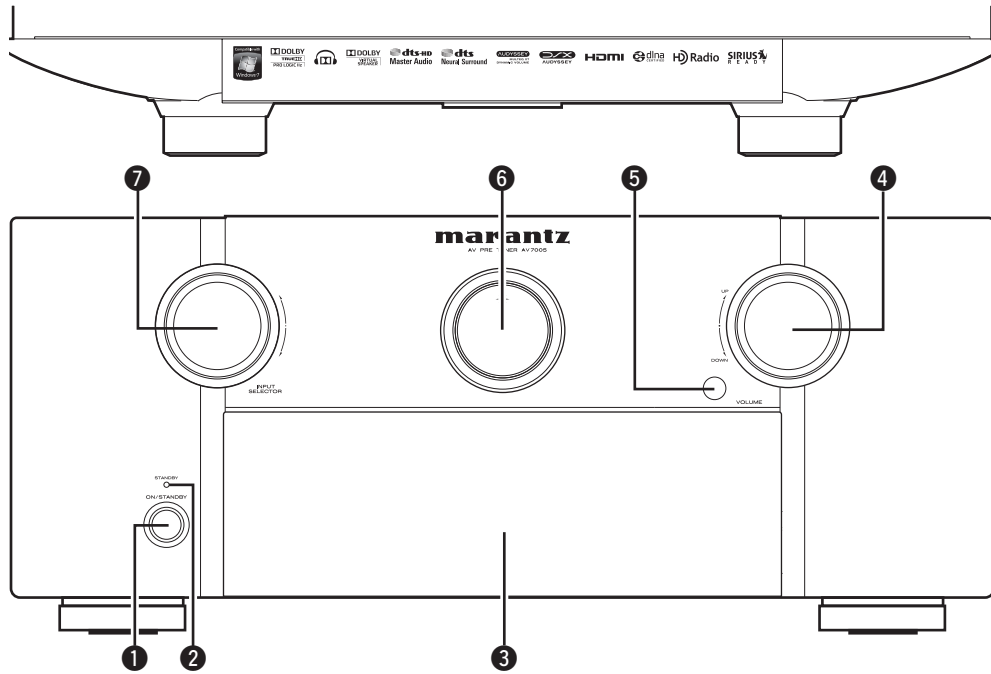

- 1 Power operation button (ON/STANDBY)** ..... (7, 12)  
Turns power to this unit on and off (standby).
- 2 Power indicator** ..... (12)
- 3 Door**
- 4 VOLUME control knob** ..... (26)
- 5 Remote control sensor** ..... (102)
- 6 Main display** ..... (99)
- 7 INPUT SELECTOR knob** ..... (25)

When you are using buttons and/or terminals behind the door, press the bottom of the door to open it. When not using buttons and/or terminals behind the door, close it. Be careful not to catch your fingers when closing the door.

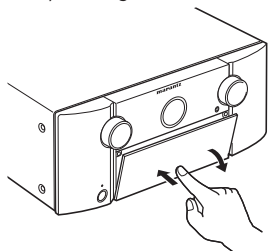

## [With the door open]

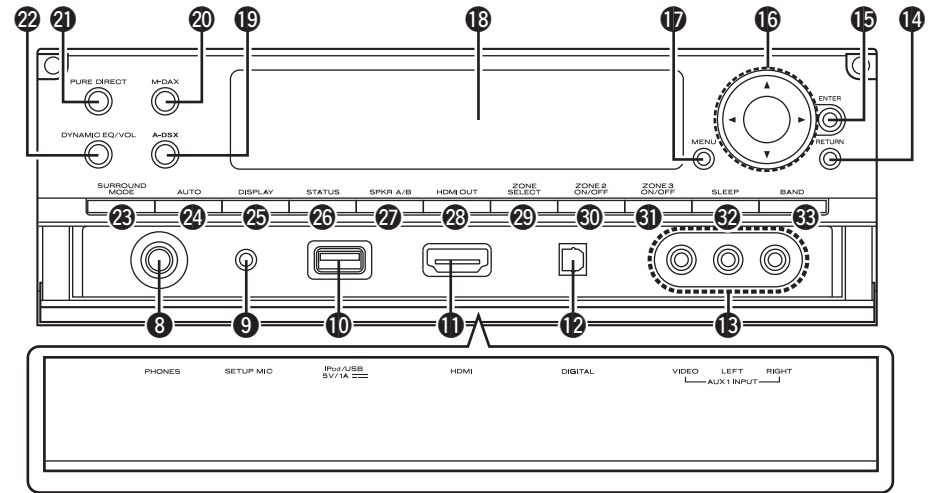

- 8 Headphones jack**  
When the headphones are plugged into this jack, audio will no longer be output from the connected speakers or from the PRE OUT connectors.
- 9 SETUP MIC jack** ..... (9, 52)
- 10 iPod/USB port** ..... (20)
- 11 HDMI connector** ..... (16)
- 12 DIGITAL connector** ..... (19)
- 13 AUX1 INPUT connectors** ..... (19)
- 14 RETURN button** ..... (64 – 66)
- 15 ENTER button** ..... (64 – 66)
- 16 Cursor buttons (Δ ▽ ◀ ▶)** ..... (64 – 66)
- 17 MENU button** ..... (66)
- 18 Sub display** ..... (99)
- 19 Audyssey DSX™ button (A-DSX)** ..... (75)
- 20 M-DAX button / indicator** ..... (76)
- 21 PURE DIRECT button / indicator** ..... (46)
- 22 Dynamic EQ®/Dynamic Volume® button (DYNAMIC EQ/VOL)** ..... (74)
- 23 SURROUND MODE button** ..... (44)
- 24 AUTO button** ..... (44, 60, 115)
- 25 DISPLAY button** ..... (60, 86)
- 26 STATUS button** ..... (88)
- 27 Speaker A/B switching button (SPKR A/B)** ..... (26)
- 28 HDMI OUT button** ..... (16)
- 29 ZONE SELECT button** ..... (62)
- 30 ZONE2 ON/OFF button** ..... (62)
- 31 ZONE3 ON/OFF button** ..... (62)
- 32 SLEEP button** ..... (56)
- 33 BAND button** ..... (32)

### NOTE

To prevent hearing loss, do not raise the volume level excessively when using headphones.

# Display

## Main Display

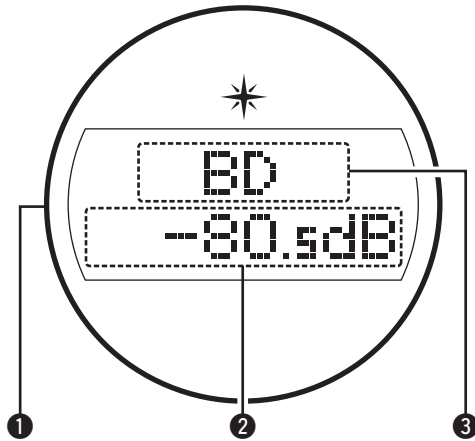

### 1 Light illumination

When the power to this device is switched on, the surrounding area is lit blue. The settings can be changed so the light does not switch on (☞ page 89 “Switches light illumination on/off”).

### 2 Master volume indicator

### 3 Input source indicator

The currently selected input source name is displayed. If the input source name has been changed using “Input Setup” – “Rename” (☞ page 71) in the menu, the input source name after the change is displayed.

## Sub Display

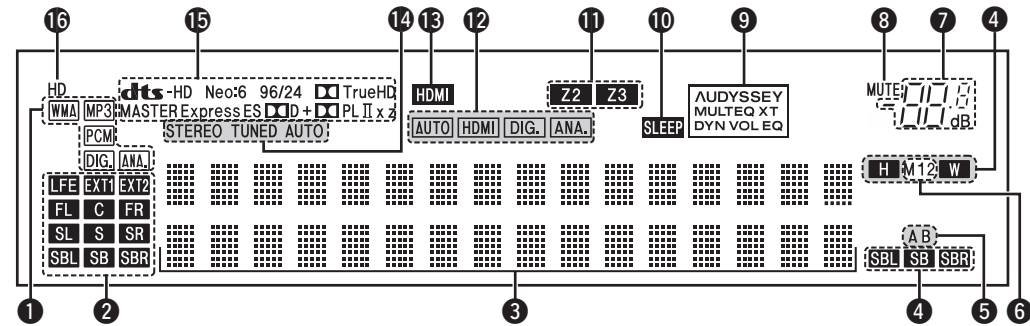

### 1 Input signal indicators

### 2 Input signal channel indicators

These light when digital signals are input. When playing HD Audio sources, the **EXT1** indicator lights when a signal from an extension channel (a channel other than the front, center, surround, surround back or LFE channel) is input. If there are two or more extension channels, the **EXT1** and **EXT2** indicators light.

### 3 Information display

The input source name, surround mode, setting values and other information are displayed here.

### 4 Surround back/front height/front wide channel indicators

When audio is output from the surround back channels, the “SB”, “SBL” or “SBR” indicator lights. When audio is output from the front height channels, the “H” indicator lights. When audio is output from the front wide channels, the “W” indicator lights.

### 5 Front speaker indicator

This lights according to the setting of the front A and B speakers.

### 6 Monitor output indicator

These light according to the HDMI monitor output setting.

### 7 Master volume indicator

### 8 MUTE indicator

This lights when the mute mode is select (☞ page 26).

### 9 AUDYSSEY indicators

Lighting is as follows, depending on the setting of “Dynamic EQ<sup>®</sup>” (☞ page 74) and “Dynamic Volume<sup>®</sup>” (☞ page 75).

AUDYSSEY MULTEQ XT DYN VOL	When “Dynamic EQ” and “Dynamic Volume” are “ON”.
AUDYSSEY MULTEQ XT DYN EQ	When “Dynamic EQ” is “ON” and “Dynamic Volume” is “OFF”.
AUDYSSEY MULTEQ XT	When “Dynamic EQ” and “Dynamic Volume” are “OFF”.

### 10 Sleep timer indicator

This lights when the sleep mode is selected (☞ page 56).

### 11 Multi-zone indicators

This lights up when ZONE2, ZONE3 (separate room) power is turned on (☞ page 62).

### 12 Input mode indicators

Set the audio input modes for the different input sources (☞ page 71).

### 13 HDMI indicator

This lights when playing using HDMI connections.

### 14 Tuner reception mode indicators

These light according to the reception conditions when the input source is set to “HD Radio”.

**STEREO** : In the FM mode, this light when receiving stereo broadcasts.

**TUNED** : Lights when the broadcast is properly tuned in.

**AUTO** : This light when in the auto tuning mode.

### 15 Decoder indicators

These light when the respective decoders are operating.

### 16 HD indicator

This light during HD Radio reception.

# Rear panel

See the page indicated in parentheses ( ).

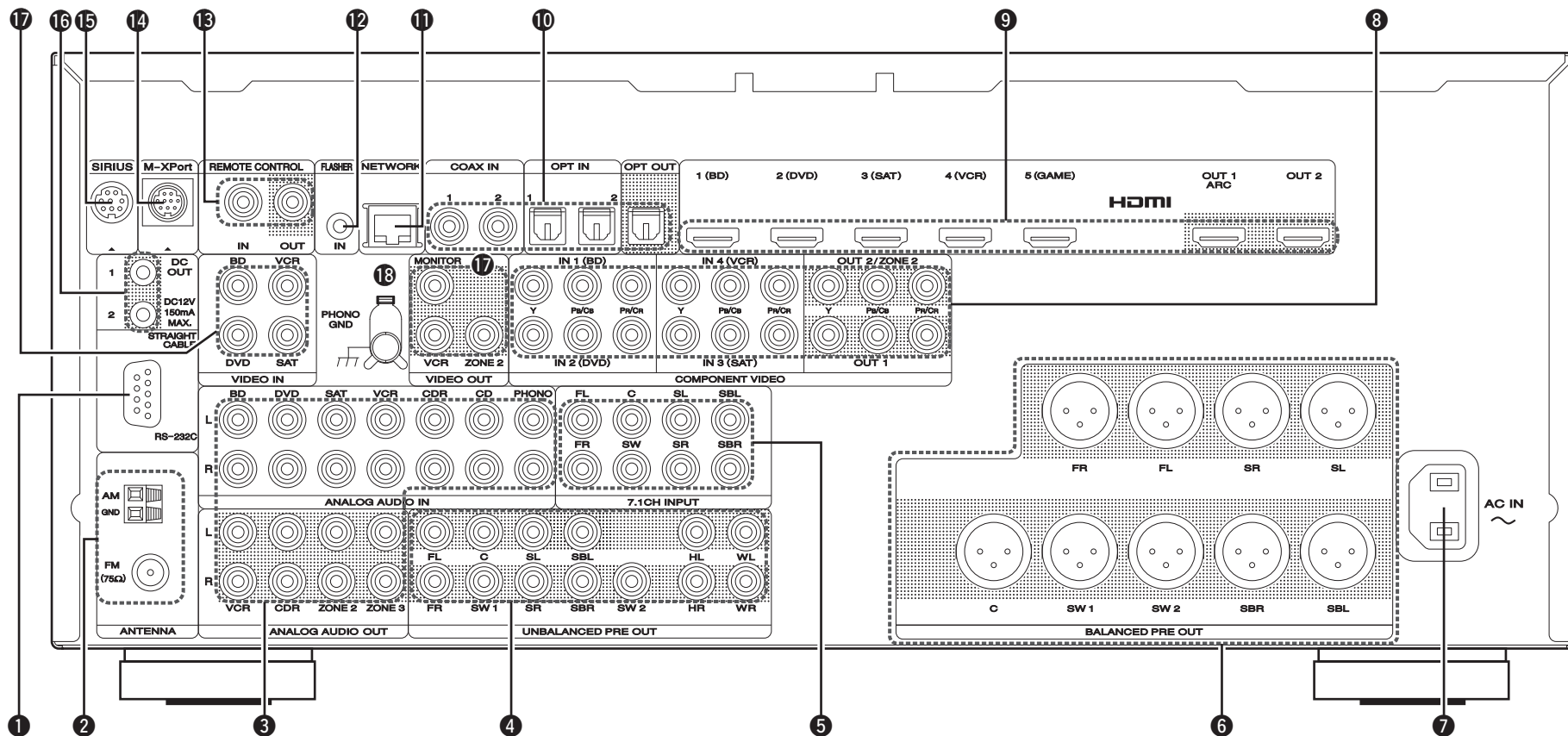

- ① RS-232C connector ..... (54)
- ② HD Radio antenna terminals ..... (22)
- ③ Analog audio connectors ..... (17 – 21, 23)
- ④ UNBALANCED PRE OUT terminals ..... (6)
- ⑤ 7.1CH INPUT connectors ..... (23)
- ⑥ BALANCED PRE OUT terminals ..... (6)
- ⑦ AC inlet (AC IN) ..... (7)
- ⑧ COMPONENT VIDEO connectors ..... (17 – 19)
- ⑨ HDMI connectors ..... (16)
- ⑩ Digital audio connectors ..... (17 – 21)
- ⑪ NETWORK connector ..... (24)
- ⑫ FLASHER IN jack  
Used when using a control BOX or other such control devices to control this unit.
- ⑬ REMOTE CONTROL jacks ..... (53)
- ⑭ M-XPort jack ..... (23)
- ⑮ SIRIUS connector ..... (22)
- ⑯ DC OUT jacks ..... (54)
- ⑰ VIDEO connectors ..... (17 – 19)
- ⑱ SIGNAL GND terminal ..... (21)

**NOTE**

Do not touch the inner pins of the connectors on the rear panel. Electrostatic discharge may cause permanent damage to the unit.

# Remote control unit

For buttons not explained here, see the page indicated in parentheses ( ).

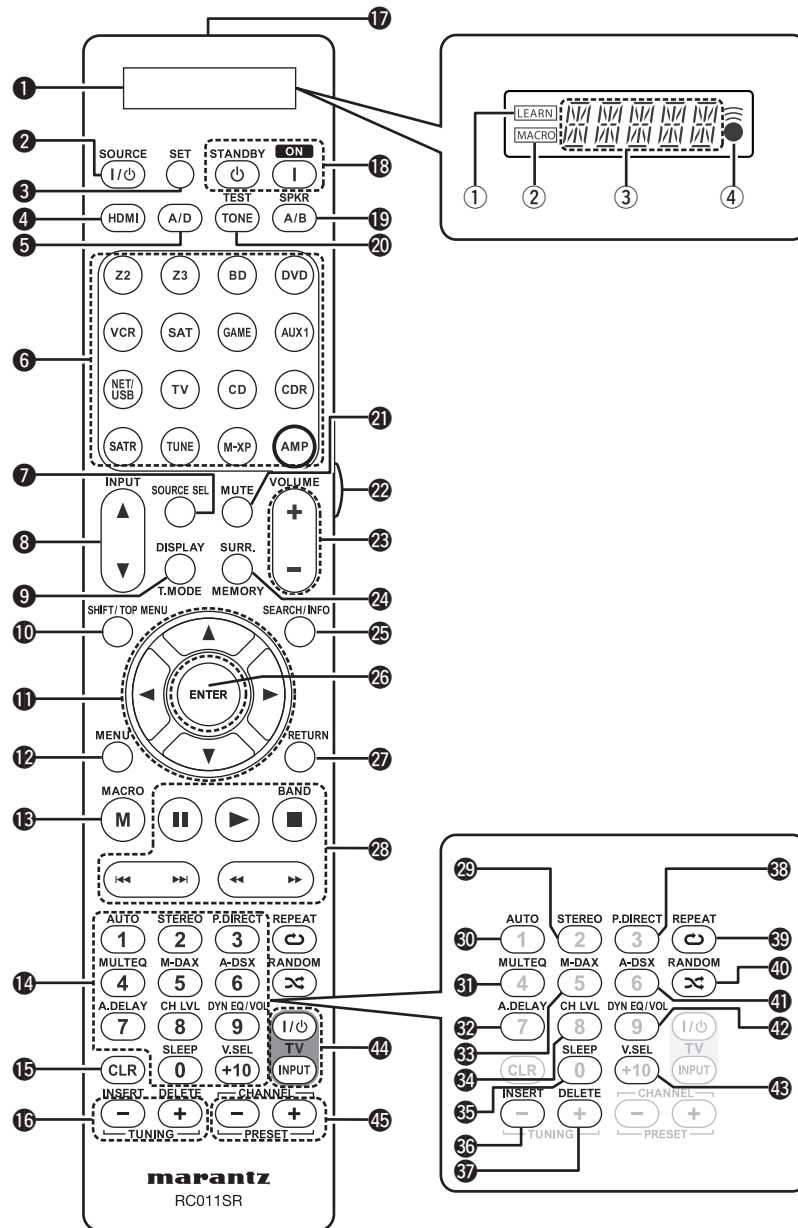

- 1 Display**
  - ① LEARN indicator ..... (93)
  - ② MACRO indicator ..... (95)
  - ③ Information display
  - ④ indicator ..... (91)
- 2 SOURCE power button** ..... (62, 92, 93)
- 3 SET button** ..... (91, 93, 95)
- 4 HDMI button** ..... (16, 94)
- 5 Input mode button (A/D)** ..... (71)
- 6 Input source select buttons** ..... (25)
- 7 Source select button (SOURCE SEL)** ..... (25)
- 8 INPUT buttons (▲, ▼)** ..... (25, 62, 91)
- 9 DISPLAY/**
  - Tuner mode (T.MODE) button ..... (32, 86)
- 10 SHIFT/TOP MENU button** ..... (33, 36, 65)
- 11 Cursor buttons (▲▼◀▶)** ..... (64 – 66)
- 12 MENU button** ..... (66)
- 13 MACRO button** ..... (95)
- 14 Number buttons** ..... (33, 36, 91, 95)
- 15 Clear button (CLR)** ..... (96)
- 16 TUNING buttons (+, -)** ..... (32)
- 17 Remote control signal transmitter**
- 18 Power buttons (ON, STANDBY)** ..... (7, 12)
- 19 Speaker A/B button (SPKR A/B)** ..... (26)
- 20 TEST TONE button** ..... (79)
- 21 Muting button (MUTE)** ..... (26)
- 22 Light button** ..... (96)
- 23 Master volume control buttons (VOLUME +, -)** ..... (26)
- 24 Surround mode (SURR.) / MEMORY button** ..... (33, 36, 44)
- 25 SEARCH/**
  - Information (INFO) button ..... (27, 31, 33, 66)
- 26 ENTER button** ..... (64 – 66)
- 27 RETURN button** ..... (64 – 66)
- 28 System buttons**
  - ..... (28, 29, 36 – 38, 40, 42, 43, 92)
  - Pause button (⏸)
  - Play button (▶)
  - Stop button (■)
  - Skip buttons (⏮, ⏭)
  - Search buttons (◀, ▶)
- FM/AM band switching button (BAND)** ..... (34)
- 29 STEREO button** ..... (46)
- 30 AUTO buttons** ..... (44, 60, 115)
- 31 MULTEQ® button** ..... (74)
- 32 Audio delay button (A.DELAY)** ..... (76)
- 33 M-DAX button** ..... (76)
- 34 Channel level button (CH LVL)** ..... (56)
- 35 SLEEP button** ..... (56)
- 36 INSERT button** ..... (65)
- 37 DELETE button** ..... (65)
- 38 Pure direct button (P.DIRECT)** ..... (46)
- 39 REPEAT button** ..... (28, 29)
- 40 RANDOM button** ..... (28, 29)
- 41 Audyssey DSX button (A-DSX)** ..... (75)
- 42 Dynamic EQ®/Dynamic Volume® button (DYN EQ/VOL)** ..... (74, 75)
- 43 Video select button (V.SEL)** ..... (69)
- 44 TV operation buttons (TV POWER / INPUT)** ..... (92, 93)
- 45 CHANNEL/ PRESET buttons (+, -)** ..... (33, 36, 92, 93)



## Remote control unit

## Inserting the batteries

① Remove the rear lid in the direction of the arrow and remove it.

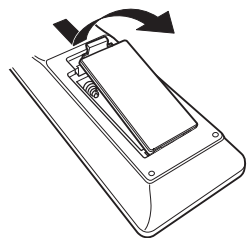

② Load the two batteries properly as indicated by the marks in the battery compartment.

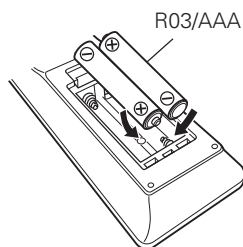

③ Put the rear cover back on.

## NOTE

- Insert the specified batteries in the remote control unit.
- Replace the batteries with new ones if the set does not operate even when the remote control unit is operated close to the unit. (The supplied batteries are only for verifying operation.)
- When inserting the batteries, be sure to do so in the proper direction, following the ⊕ and ⊖ marks in the battery compartment.
- To prevent damage or leakage of battery fluid:
  - Do not use a new battery together with an old one.
  - Do not use two different types of batteries.
  - Do not attempt to charge dry batteries.
  - Do not short-circuit, disassemble, heat or dispose of batteries in flames.
  - Do not keep the battery in a place exposed to direct sunlight or in places with extremely high temperatures, such as near a heater.
- If the battery fluid should leak, carefully wipe the fluid off the inside of the battery compartment and insert new batteries.
- Remove the batteries from the remote control unit if it will not be in use for long periods.
- Used batteries should be disposed of in accordance with the local regulations regarding battery disposal.

## Operating range of the remote control unit

Point the remote control unit at the remote sensor when operating it.

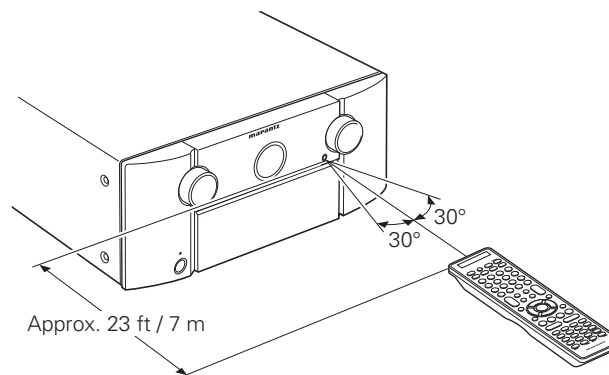

## NOTE

The set may function improperly or the remote control unit may not operate if the remote control sensor is exposed to direct sunlight, strong artificial light from an inverter type fluorescent lamp or infrared light.





# Other information



- ❑ **Trademark information** (👉 page 103)
- ❑ **Surround** (👉 page 104)
- ❑ **Relationship between video signals and monitor output** (👉 page 108)
- ❑ **Explanation of terms** (👉 page 109)

## Trademark information

This product uses the following technologies:

	<p>Manufactured under license from Audyssey Laboratories™. U.S. and foreign patents pending. Audyssey MultEQ® XT is a registered trademark of Audyssey Laboratories. Audyssey Dynamic EQ® is a registered trademark of Audyssey Laboratories. Audyssey Dynamic Volume® is a registered trademark of Audyssey Laboratories. Audyssey Dynamic Surround Expansion™ is a trademark of Audyssey Laboratories.</p>
	<p>DLNA®, the DLNA Logo and DLNA CERTIFIED® are trademarks, service marks, or certification marks of the Digital Living Network Alliance. Device Class: DMP (Digital Media Player) DLNA Certified® Product Function: FINDS, PLAYS Content Type: audio, images, videos (Check supported media formats.) DLNA consumer website: <a href="http://www.dlna.org">www.dlna.org</a> Some content may not be compatible with other DLNA Certified® products (example: optional media formats)</p>

	<p>Manufactured under license from Dolby Laboratories. “Dolby”, “Pro Logic” and the double-D symbol are trademarks of Dolby Laboratories.</p>
	<p>Manufactured under license under U.S. Patent #'s: 5,451,942; 5,956,674; 5,974,380; 5,978,762; 6,226,616; 6,487,535; 7,212,872; 7,333,929; 7,392,195; 7,272,567 &amp; other U.S. and worldwide patents issued &amp; pending. DTS and the Symbol are registered trademarks, &amp; DTS-HD, DTS-HD Master Audio, and the DTS logos are trademarks of DTS, Inc. Product includes software. © DTS, Inc. All Rights Reserved.</p>
	<p>Manufactured under license from DTS Licensing Limited. DTS and the Symbol are registered trademarks, &amp; DTS Neural Surround and the DTS logos are trademark of DTS, Inc. Product includes software. © DTS, Inc. All Rights Reserved.</p>
	<p>HDMI, the HDMI Logo and High-Definition Multimedia Interface are trademarks or registered trademarks of HDMI Licensing LLC in the United States and other countries.</p>
	<p>HD Radio™ Technology Manufactured Under License From iBiquity Digital Corp. U.S. and Foreign Patents. HD Radio™ and the HD Radio logo are proprietary trademarks of iBiquity Digital Corp.</p>

	<p>“Made for iPod” and “Made for iPhone” mean that an electronic accessory has been designed to connect specifically to iPod, or iPhone, respectively, and has been certified by the developer to meet Apple performance standards. Apple is not responsible for the operation of this device or its compliance with safety and regulatory standards. iPhone, iPod, iPod classic, iPod nano, iPod shuffle, and iPod touch are trademarks of Apple Inc., registered in the U.S. and other countries.</p> <ul style="list-style-type: none"> <li>• Individual users are permitted to use iPhone, iPod, iPod classic, iPod nano, iPod shuffle, and iPod touch for private copy and playback of non-copyrighted contents and contents whose copy and playback is permitted by law. Copyright infringement is prohibited by law.</li> </ul>
	<p>SIRIUS, XM and all related marks and logos are trademarks of Sirius XM Radio Inc. and its subsidiaries. All rights reserved. Service not available in Alaska and Hawaii.</p>
<p>This item incorporates copy protection technology that is protected by U.S. patents and other intellectual property rights of Rovi Corporation. Reverse engineering and disassembly are prohibited</p>	

# Surround

This unit is equipped with a digital signal processing circuit that lets you play program sources in the surround mode to achieve the same sense of presence as in a movie theater.

## Surround modes and parameters

This table shows the speakers that can be used in each surround mode and the surround parameters adjustable in each surround mode.

### Symbols in the table

- This indicates the audio output channels or surround parameters that can be set.
- ⊙ This indicates the audio output channels. The output channels depend on the settings of "Speaker Config." (page 78).

Surround mode (page 44)	Channel output							Surround Parameter (page 73)			
	Front L/R	Center	Surround L/R	Surround back L/R	Front height L/R	Front wide L/R	Subwoofer	HT-EQ *5 (page 73)	DRC *6 (page 73)	D. Comp *7 (page 73)	LFE *8 (page 73)
PURE DIRECT (2channel)	○						⊙*4		○	○	
PURE DIRECT (Multi-channel)	○	⊙	⊙	⊙*1	⊙*1	⊙*1	○		○	○	○
DIRECT (2channel)	○						⊙*4		○	○	
DIRECT (Multi-channel)	○	⊙	⊙	⊙*1	⊙*1	⊙*1	○		○	○	○
STEREO	○						○	○	○	○	○
MULTI CH IN	○	⊙	⊙	⊙			○	○	○	○	○
DOLBY PRO LOGIC IIz	○	⊙	⊙		⊙		○	○	○	○	
DOLBY PRO LOGIC IIx	○	⊙	⊙	⊙			○	○	○	○	
DOLBY PRO LOGIC II	○	⊙	⊙				○	○	○	○	
DOLBY PRO LOGIC II A-DSX	○	⊙	⊙		⊙*2	⊙*3	○	○	○	○	
DTS NEO:6	○	⊙	⊙	⊙			○	○	○	○	
DTS NEO:6 A-DSX	○	⊙	⊙		⊙*2	⊙*3	○	○	○	○	
Audyssey DSX	○	⊙	⊙		⊙*2	⊙*3	○	○	○		○
DOLBY DIGITAL	○	⊙	⊙	⊙	⊙		○	○		○	○
DOLBY DIGITAL Plus	○	⊙	⊙	⊙	⊙		○	○		○	○
DOLBY TrueHD	○	⊙	⊙	⊙	⊙		○	○	○		○
DTS SURROUND	○	⊙	⊙	⊙	⊙		○	○		○	○
DTS 96/24	○	⊙	⊙	⊙	⊙		○	○		○	○
DTS-HD	○	⊙	⊙	⊙	⊙		○	○		○	○
DTS Express	○	⊙	⊙	⊙	⊙		○	○		○	○
MULTI CH STEREO	○	⊙	⊙	⊙			○	○		○	○
NEURAL	○	⊙	⊙	⊙			○	○			
DOLBY VIRTUAL SPEAKER	○						○	○			
DOLBY HEADPHONE	○										

- \*1 A signal for each channel contained in an input signal is output as audio.
- \*2 If "Audyssey DSX" (page 75) is set to "ON-Height-", sound is output from the front height speakers.
- \*3 If "Audyssey DSX" (page 75) is set to "ON-Wide-", sound is output from the front wide speakers.
- \*4 Only when "Subwoofer Mode" is set to "LFE+Main" (page 79), sound is output from the subwoofer.
- \*5 For HD Audio whose sampling frequency of an input signal is more than 96 kHz, this sound parameter cannot be set.
- \*6 This item can be selected when a Dolby TrueHD signal is played.
- \*7 This item can be selected when a Dolby Digital or DTS signal is played.
- \*8 This item can be selected when a Dolby Digital or DTS signal or DVD-Audio is played.

Surround mode (page 44)	Surround Parameter (page 73)				Tone *9 (page 73)	Audyssey Settings *10 (page 74)			Audyssey DSX™ Soundstage *10 (page 75)	M-DAX *13 (page 76)	
	Height Gain (page 73)	PRO LOGIC II/IIx Music mode only				NEO:6 Music mode only	MultEQ® XT (page 74)	Dynamic EQ® *11 (page 74)			Dynamic Volume® *12 (page 75)
		Panorama (page 73)	Dimension (page 73)	C.Width (page 73)		C.Image (page 73)					
PURE DIRECT (2 channel)											
PURE DIRECT (Multi-channel)											
DIRECT (2 channel)											
DIRECT (Multi-channel)											
STEREO					○	○	○	○		○	
MULTI CH IN					○	○	○	○	○		
DOLBY PRO LOGIC IIz	○				○	○	○	○		○	
DOLBY PRO LOGIC IIx		○	○	○	○	○	○	○	○	○	
DOLBY PRO LOGIC II		○	○	○	○	○	○	○	○	○	
DOLBY PRO LOGIC II A-DSX		○	○	○	○	○	○	○	○	○	
DTS NEO:6					○	○	○	○	○	○	
DTS NEO:6 A-DSX					○	○	○	○	○	○	
Audyssey DSX					○	○	○	○	○		
DOLBY DIGITAL					○	○	○	○	○		
DOLBY DIGITAL Plus					○	○	○	○	○		
DOLBY TrueHD					○	○	○	○	○		
DTS SURROUND					○	○	○	○	○		
DTS 96/24					○	○	○	○	○		
DTS-HD					○	○	○	○	○		
DTS Express					○	○	○	○	○		
MULTI CH STEREO					○	○	○	○		○	
NEURAL					○	○	○	○		○	
DOLBY VIRTUAL SPEAKER					○	○	○	○		○	
DOLBY HEADPHONE					○	○	○	○		○	

- \*9 This item cannot be set when "Dynamic EQ" (page 74) is set to "ON".
- \*10 For HD Audio whose sampling frequency of an input signal is more than 96 kHz, this sound parameter cannot be set.
- \*11 This item cannot be set when "MultEQ XT" (page 74) is set to "OFF" or "Manual".
- \*12 This item cannot be set when "Dynamic EQ" (page 74) is set to "OFF".
- \*13 This item can be set when the input signal is analog, PCM 48 kHz or 44.1 kHz.

Simple version

Basic version

Advanced version

Information

Surround

Types of input signals, and corresponding surround modes

This table shows the input signal that can be played in each surround mode. Check the audio signal of the input source then select the surround mode.

Symbols in the table

○ This indicates the selectable surround mode.

Surround mode (page 44)	NOTE	Input signal types and formats																
		ANALOG	PCM		DTS-HD		DTS					DOLBY		DOLBY DIGITAL				
			LINEAR PCM (multi ch)	LINEAR PCM (2ch)	DTS-HD Master Audio	DTS-HD High Resolution Audio	DTS EXPRESS	DTS ES DSCRT (With Flag)	DTS ES MTRX (With Flag)	DTS (5.1ch)	DTS 96/24	DOLBY TrueHD	DOLBY DIGITAL Plus	DOLBY DIGITAL EX (With Flag)	DOLBY DIGITAL EX (With no Flag)	DOLBY DIGITAL (5.1/5/4ch)	DOLBY DIGITAL (4/3ch)	DOLBY DIGITAL (2ch)
<b>DTS SURROUND</b>																		
DTS-HD MSTR	* 5				○													
DTS-HD HI RES	* 5					○												
DTS ES DSCRT6.1	* 1 * 3									○								
DTS ES MTRX6.1	* 1 * 3										○							
DTS SURROUND	* 5										○							
DTS 96/24	* 5																○	
DTS (-HD) + PLIIx MOVIE	* 2 * 3				○	○	○	○	○	○	○	○						
DTS (-HD) + PLIIx MUSIC	* 1 * 3				○	○	○	○	○	○	○	○						
DTS (-HD) + PLIIz	* 4				○	○	○	○	○	○	○	○						
DTS EXPRESS	* 5																	
DTS (-HD) + NEO:6	* 1 * 3				○	○	○				○	○						
DTS NEO:6 CINEMA	* 5	○		○													○	
DTS NEO:6 MUSIC	* 5	○		○													○	
DTS NEO:6 CINEMA A-DSX		○		○													○	
DTS NEO:6 MUSIC A-DSX		○		○													○	
Audyssey DSX					○	○	○	○	○	○	○							
<b>DOLBY SURROUND</b>																		
DOLBY TrueHD	* 5												○					
DOLBY DIGITAL+	* 5													○				
DOLBY DIGITAL EX	* 1 * 3														○	○	○	
DOLBY (D+) (HD) +EX	* 1 * 3													○	○	○	○	
DOLBY DIGITAL	* 5														○	○	○	
DOLBY (D) (D+) (HD) +PLIIx MOVIE	* 2 * 3													○	○	○	○	
DOLBY (D) (D+) (HD) +PLIIx MUSIC	* 1 * 3													○	○	○	○	
DOLBY (D) (D+) (HD) +PLIIz	* 4													○	○	○	○	
DOLBY PRO LOGIC IIx MOVIE	* 1 * 3	○		○													○	
DOLBY PRO LOGIC IIx MUSIC	* 1 * 3	○		○													○	
DOLBY PRO LOGIC IIx GAME	* 1 * 3	○		○													○	
DOLBY PRO LOGIC IIz	* 4	○		○													○	
DOLBY PRO LOGIC II MOVIE	* 5	○		○													○	
DOLBY PRO LOGIC II MUSIC	* 5	○		○													○	
DOLBY PRO LOGIC II GAME	* 5	○		○													○	

- \* 1 If "Speaker Config." - "S.Back" (page 78) is set to "None", this surround mode cannot be selected.
- \* 2 If "Speaker Config." - "S.Back" (page 78) is set to "1spkr" or "None", this surround mode cannot be selected.
- \* 3 This surround mode can be selected when "Amp Assign" (page 78) is set to "Normal".
- \* 4 If "Speaker Config." - "F.Height" (page 78) is set to "None", this surround mode cannot be selected.
- \* 5 The same was when "Audyssey DSX™" (page 75) setting is set to "ON".

Surround mode (🔗 page 44)	NOTE	Input signal types and formats																
		ANALOG	PCM		DTS-HD		DTS					DOLBY		DOLBY DIGITAL				
			LINEAR PCM (multi ch)	LINEAR PCM (2ch)	DTS-HD Master Audio	DTS-HD High Resolution Audio	DTS EXPRESS	DTS ES DSCRT (With Flag)	DTS ES MTRX (With Flag)	DTS (5.1ch)	DTS 96/24	DOLBY TrueHD	DOLBY DIGITAL Plus	DOLBY DIGITAL EX (With Flag)	DOLBY DIGITAL EX (With no Flag)	DOLBY DIGITAL (5.1/5/4ch)	DOLBY DIGITAL (4/3ch)	DOLBY DIGITAL (2ch)
<b>DOLBY SURROUND</b>																		
DOLBY PRO LOGIC II MOVIE A-DSX		○	○														○	
DOLBY PRO LOGIC II MUSIC A-DSX		○	○														○	
DOLBY PRO LOGIC II GAME A-DSX		○	○														○	
Audyssey DSX												○	○	○	○	○	○	
DOLBY VIRTUAL SPEAKER		○	○	○	○	○	○	○	○	○	○	○	○	○	○	○	○	
DOLBY HEADPHONE		○	○	○	○	○	○	○	○	○	○	○	○	○	○	○	○	
<b>MULTI CH IN</b>																		
MULTI CH IN	* 5		○															
MULTI CH IN + PLIIx MOVIE	* 2 * 3		○															
MULTI CH IN + PLIIx MUSIC	* 1 * 3		○															
MULTI CH IN + PLIIz	* 4		○															
MULTI CH IN + Dolby EX	* 3		○															
MULTI CH IN 7.1	* 3		○ (7.1)															
Audyssey DSX			○															
<b>DIRECT</b>																		
DIRECT		○	○	○	○	○	○	○	○	○	○	○	○	○	○	○	○	○
<b>PURE DIRECT</b>																		
PURE DIRECT		○	○	○	○	○	○	○	○	○	○	○	○	○	○	○	○	○
<b>MULTI CH STEREO</b>																		
MULTI CH STEREO		○	○	○				○	○	○	○			○	○	○	○	
<b>STEREO</b>																		
STEREO		○	○	○	○	○	○	○	○	○	○	○	○	○	○	○	○	○
<b>NEURAL</b>																		
NEURAL		○	○														○	
<b>AUTO</b>																		
AUTO		○	○	○	○	○	○	○	○	○	○	○	○	○	○	○	○	○

- \* 1 If "Speaker Config." - "S.Back" (🔗 page 78) is set to "None", this surround mode cannot be selected.
- \* 2 If "Speaker Config." - "S.Back" (🔗 page 78) is set to "1spkr" or "None", this surround mode cannot be selected.
- \* 3 This surround mode can be selected when "Amp Assign" (🔗 page 78) is set to "Normal".
- \* 4 If "Speaker Config." - "F.Height" (🔗 page 78) is set to "None", this surround mode cannot be selected.
- \* 5 The same was when "Audyssey DSX™" (🔗 page 75) setting is set to "ON".

Simple version

Basic version

Advanced version

Information



# Relationship between video signals and monitor output

	Video Convert	MAIN ZONE MONITOR OUT												
		Input Signals			Output Signals			Menu displayed						
		HDMI	COMPONENT	VIDEO	HDMI	COMPONENT	VIDEO	HDMI	COMPONENT	VIDEO				
1	ON	×	×	×	Wall paper	×	×	Only the menu is displayed	× *2	×				
2	OFF	×	×	×	×	×	×	×	× *2	×				
3	ON	×	×	○	VIDEO	VIDEO	VIDEO	○ (VIDEO)	× (VIDEO) *3	× (VIDEO)				
4	ON	×	○ (1080p)	×	COMPONENT	COMPONENT	×	○ (COMPONENT)	× (COMPONENT) *2	×				
5	ON	×	○ (1080i ~ 480p)	×			×							
6	ON	×	○ (480i/576i)	×			×							
7	ON	×	○ (1080p)	○			VIDEO				-	○ (VIDEO)	× (COMPONENT) *3	×
8	ON *1	×	○ (1080p)	○										
9	ON	×	○ (1080i ~ 480p)	○										
10	ON	×	○ (480i/576i)	○										
11	ON	○	×	×	HDMI	×	×	○ (HDMI)	× *2	×				
12	ON	○	×	○		×	VIDEO				×	×		
13	ON	○	○	×		COMPONENT	×				×	× (COMPONENT) *2	×	
14	ON	○	○	○			VIDEO				×			×
15	OFF	×	×	○	×	×	VIDEO	Only the menu is displayed	× *2	× (VIDEO)				
16	OFF	×	○	×	×	COMPONENT	×				×			
17	OFF	×	○	○	×		VIDEO				×	×		
18	OFF	○	×	×	HDMI	×	×				× *2	×		
19	OFF	○	×	○		×	VIDEO						×	×
20	OFF	○	○	×		COMPONENT	×						×	× (COMPONENT) *2
21	OFF	○	○	○			VIDEO	×	×					

○ Video signal input present

× No video signal input

\*1 When no HDMI monitor is connected or the HDMI monitor's power is not on

× No video signal output

○ ( ) Superimposed on the picture indicated in ( ).

× ( ) Only the picture in ( ) is output.

× Neither the picture nor the menu is output.

\*2 Only the menu is displayed when no HDMI monitor is connected or the HDMI monitor's power is not on.

\*3 If an HDMI monitor is not connected or power of an HDMI monitor is not turned on, the menu is superimposed on a video image in parenthesis.

	ZONE2 MONITOR OUT			
	Input Signals		Output Signals	
	COMPONENT	VIDEO	COMPONENT	VIDEO
1	×	×	×	×
2	×	○	×	○
3	○	×	○	×
4	○	○	○	○



- The main zone video conversion function is compatible with the following formats: NTSC, PAL, SECAM, NTSC4.43, PAL-N, PAL-M and PAL-60.
- When SECAM signals of video input are up-converted, the signals are output in PAL format from the S-Video and Video connectors.
- The menu display cannot be superimposed when x.v.Color signals and computer's resolution (e.g. VGA) are input.

### NOTE

- If you operate the menu while playing back 3D video content, the playback video is replaced by the menu screen. The playback video is not displayed behind the menu screen.
- This unit does not show the status display while playing back 3D video content.

## Explanation of terms

### A

#### A2DP

A2DP is one profile of Bluetooth defined for in-car devices or AV devices that use wireless communication instead of a cable.

#### Adobe RGB color, Adobe YCC601 color

Like x.v.Color, each of these color spaces defines a palette of available colors that is larger than the traditional RGB color model.

#### Audyssey Dynamic Surround Expansion™ (A-DSX)

Realistic reproduction of sound relies on the ability of audio systems to match human hearing performance. Three key requirements are: (1) frequency response, (2) dynamic range, and (3) accurate spatial reproduction. The requirements for frequency response have already been surpassed with sampling rates that exceed human hearing. The dynamic range limits of human perception have also been met with current digital audio systems operating capable of signal to noise ratios that approach 120 dB. Accurate spatial sound rendering, however, has not yet reached the limits of perception as human perception relies on the combination of sounds arriving from many more directions than what 5.1-channel surround sound systems provide. Audyssey DSX technology was developed to overcome the spatial sound rendering limitations faced by 5.1-channel surround sound formats.

The ITU 5.1-channel channel standard recommends three front loudspeakers and two rear loudspeakers. The Left (L) and Right (R) front loudspeakers should be placed at  $\pm 30^\circ$  relative to the central listening position. The Center (C) loudspeaker should be at  $0^\circ$  and the surround loudspeakers (SL, SR) should be placed between  $100^\circ$  and  $120^\circ$ . All loudspeakers must be equidistant from the center listening position or compensated with time delay if that is not possible. A separate low-frequency effects (LFE) channel is used to reproduce additional bass content from the subwoofer.

There are certain things that 5.1-channel surround sound systems do well compared to 2-channel stereo. For example, it is possible to move sounds across the front seamlessly. It is also possible to create ambience behind the listener. But 5.1 channel surround systems do not provide enough channels from which to render the required reflected

sound components for a seamless and enveloping soundstage. Unfortunately, the additional two back surround channels in 7.1-channel systems are not in the right place to provide a significant perceptual improvement.

Adding more channels to a surround system is not for special effects. Accurate spatial sound reproduction requires rendering of directional sound cues and non-directional ambient cues. Reflections arriving after the direct sound play a critical role in the perception of soundstage width and depth. To have the most impact, additional surround channels should be used to control the direction, time of arrival, and frequency response of the reflected sound to render an expanded soundstage that reproduces sound with better localization and envelopment than what 5.1-channel systems provide.

Research in the perception of auditory source width has shown that there are strong preferences in the direction of reflected sound and the perception of soundstage width and spaciousness. The single most important direction of side-wall reflections is  $\pm 60^\circ$ . DSX provides a pair of Wide channels (LW and RW) at  $\pm 60^\circ$  with appropriate frequency response and perceptual processing to match the requirements of human hearing. In fact, the Wide channels are much more critical in the presentation of a realistic soundstage than then Back Surround channels found in traditional 7.1-channel systems. A more enveloping 7.1-channel system is one in which Wide speakers are used instead of Back Surround speakers. Adding surround channels behind the listener has a very small impact compared to the increase in envelopment and soundstage width that the front wide channels will provide.

After side reflections, the next most important acoustical and perceptual cues come from reflections above the front stage. DSX provides a pair of Height channels (LH and RH) at a  $\pm 45^\circ$  azimuth angle and elevated to a  $45^\circ$  angle in the median plane.

In addition to creating new Wide and Height channels, DSX also provides Surround Processing to enhance the envelopment of the Surround and Back Surround channels (if present). DSX Surround Processing processes the standard surround signals in the time and frequency domains to improve the perceived sense of envelopment and blending with the other speakers in the surround system.

Audyssey Dynamic Surround Expansion is a scalable system that can adapt to the practical needs of the user. The first level of surround stage enhancement comes from adding the Wide channels. The second level comes from adding the Height channels. If it is practical to have both Wides and Heights then the surround performance will be further enhanced. DSX automatically reconfigures its processing to optimize surround rendering over any number of available speakers beyond that of 5.1-channel.

#### Audyssey Dynamic EQ®

Audyssey Dynamic EQ solves the problem of deteriorating sound quality as volume is decreased by taking into account human perception and room acoustics. Audyssey Dynamic EQ works in tandem with Audyssey MultEQ XT to provide well-balanced sound for every listener at any volume level.

#### Audyssey Dynamic Volume®

Audyssey Dynamic Volume solves the problem of large variations in volume level between television programs, commercials, and between the soft and loud passages of movies. Audyssey Dynamic EQ is integrated into Dynamic Volume so that as the playback volume is adjusted automatically, the perceived bass response, tonal balance, surround impression, and dialog clarity remain the same.

#### Audyssey MultEQ® XT

Audyssey MultEQ XT is a room equalization solution that calibrates any audio system so that it can achieve optimum performance for every listener in a large listening area. Based on several room measurements, MultEQ XT calculates an equalization solution that corrects for both time and frequency response problems in the listening area and also performs a fully automated surround system setup.

#### Auto Lip Sync

If you connect this unit to a TV that supports the Auto Lip Sync function, it can automatically correct delay between the audio and video.

### B

#### Bluetooth

Bluetooth is a short-distance wireless communication technology used for connecting handheld devices several meters apart. This enables notebook computers, PDAs, mobile phones, etc. to connect without a cable for transmitting audio and data.

### D

#### Deep Color

This technology allows expression of more number of colors than the conventional 8 bits and can reproduce colors close to natural ones without color streak.

#### DLNA

DLNA and DLNA CERTIFIED are trademarks and/or service marks of Digital Living Network Alliance. Some contents may not be compatible with other DLNA CERTIFIED™ products.

#### Dolby Digital

Dolby Digital is a multi-channel digital signal format developed by Dolby Laboratories.

A total of 5.1 channels are played: 3 front channels ("FL", "FR" and "C"), 2 surround channels ("SL" and "SR") and the "LFE" channel for low frequencies.

Because of this, there is no crosstalk between channels and a realistic sound field with a "three-dimensional" feeling (sense of distance, movement and positioning) is achieved.

A realistic, powerful sense of presence is achieved when playing movie sources in AV rooms as well.

#### Dolby Digital EX

Dolby Digital EX is a 6.1-channel surround format proposed by Dolby Laboratories that allows users to enjoy in their homes the "DOLBY DIGITAL SURROUND EX" audio format jointly developed by Dolby Laboratories and Lucas Films.

The 6.1 channels of sound, including surround back channels, provide improved sound positioning and expression of space.

#### Dolby Digital Plus

Dolby Digital Plus is an improved Dolby Digital signal format that is compatible with up to 7.1 channels of discrete digital sound and also improves sound quality thanks to extra data bit rate performance. It is upwardly compatible with conventional Dolby Digital, so it offers greater flexibility in response to the source signal and the conditions of the playback equipment.

## Explanation of terms

**Dolby Headphone**

The Dolby Headphone technology provides a surround sound listening experience over headphones.

When listening to multichannel content such as DVD movies over headphones, the listening experience is fundamentally different than listening to speakers. Since the headphone speaker drivers are covering the pinna of the ear, the listening experience differs greatly from traditional speaker playback. Dolby utilizes patented headphone perspective curves to solve this problem and provides a non-fatiguing, immersive, home theater listening experience. Dolby Headphone also delivers exceptional 3D audio from stereo material.

**Dolby TrueHD**

Dolby TrueHD is a high definition audio technology developed by Dolby Laboratories, using lossless coding technology to faithfully reproduce the sound of the studio master.

This format provides the facility to support up to 8 audio channels with a sampling frequency of 96kHz/24bit resolution and up to 6 audio channels with a sampling frequency of 192kHz/24bit resolution. Dolby TrueHD is adopted for applications that put very high importance on sound quality.

**Dolby Pro Logic II**

Dolby Pro Logic II is a matrix decoding technology developed by Dolby Laboratories.

Regular music such as that on CDs is encoded into 5 channels to achieve an excellent surround effect. The surround channel signals are converted into stereo and full band signals (with a frequency response of 20 Hz to 20 kHz or greater) to create a "three-dimensional" sound image offering a rich sense of presence for all stereo sources.

**Dolby Pro Logic IIx**

Dolby Pro Logic IIx is a further improved version of the Dolby Pro Logic II matrix decoding technology. Audio signals recorded in 2 channels are decoded to achieve a natural sound with up to 7.1 channels. There are three modes: "Music" suited for playing music, "Movie" suited for playing movies, and "Game" which is optimized for playing games.

**Dolby Pro Logic IIz**

Dolby Pro Logic IIz introduces a new dimension to Home Entertainment through the addition of a pair of front height channels. Compatible with stereo, 5.1-channel and 7.1-channel content, Dolby Pro Logic IIz provides enhanced spaciousness, depth and dimension to movies, concert video and video game playback while maintaining the full integrity of the source mix.

Dolby Pro Logic IIz identifies and decodes spatial cues that occur naturally in all content, directing this information to the front height channels, complementing the performance of left and right surround sound speakers. Content that is encoded with Dolby Pro Logic IIz height channel information can be even more revealing, with perceptually discrete height channel information bringing an exciting new dimension to home entertainment.

Dolby Pro Logic IIz, with front height channels is also an ideal alternative for households that cannot support the placement of back surround speakers of a typical 7.1-channel system but may have bookshelf space available to support the addition of height speakers.

**Dolby Virtual Speaker**

Dolby Virtual Speaker is a technology certified by Dolby Laboratories that creates a virtualized surround sound experience from two speakers using a multichannel Dolby Digital source.

Additionally, Dolby Virtual Speaker can simulate the surround sound effect produced by Dolby Pro Logic or Dolby Pro Logic II.

Dolby Virtual Speaker retains all the original Multichannel audio information and provides the listener with the sensation of being surrounded by additional speakers.

**Downmix**

This function converts the number of channels of surround audio to less number of channels and plays back.

**DTS**

This is an abbreviation of Digital Theater System, which is a digital audio system developed by DTS. When playing back audio by connecting this system with a device such as DTS amplifier, accurate sound field position and realistic sound effect as if you are in a movie theater can be obtained.

**DTS 96/24**

DTS 96/24 is a digital audio format enabling high sound quality playback in 5.1 channels with a sampling frequency of 96 kHz and 24 bit quantization on DVD-Video.

**DTS Digital Surround**

DTS Digital Surround is the standard digital surround format of DTS, Inc., compatible with a sampling frequency of 44.1 or 48 kHz and up to 5.1 channels of digital discrete surround sound.

**DTS-ES™ Discrete 6.1**

DTS-ES™ Discrete 6.1 is a 6.1-channel discrete digital audio format adding a surround back (SB) channel to the DTS digital surround sound.

Decoding of conventional 5.1-channel audio signals is also possible according to the decoder.

**DTS-ES™ Matrix 6.1**

DTS-ES™ Matrix 6.1 is a 6.1-channel discrete digital audio format inserting a surround back (SB) channel to the DTS digital surround sound through matrix encoding. Decoding of conventional 5.1-channel audio signals is also possible according to the decoder.

**DTS Express**

DTS Express is an audio format supporting low bit rates (max. 5.1 channels, 24 to 256 kbps).

**DTS-HD**

This audio technology provides higher sound quality and enhanced functionality than the conventional DTS and is adopted as an optional audio for Blu-ray Disc. This technology supports multi-channel, high data transfer speed, high sampling frequency, and lossless audio playback. Maximum 7.1-channels are supported in Blu-ray Disc.

**DTS-HD High Resolution Audio**

DTS-HD High Resolution Audio is an improved version of the conventional DTS, DTS-ES and DTS 96/24 signals formats, compatible with sampling frequencies of 96 or 48 kHz and up to 7.1 channels of discrete digital sound. High data bit rate performance provides high quality sound. This format is fully compatible with conventional products, including conventional DTS digital surround 5.1-channel data.

**DTS-HD Master Audio**

DTS-HD Master Audio is a lossless audio format created by Digital Theater System (DTS). This format provides the facility to support up to 8 audio channels with a sampling frequency of 96kHz/24bit resolution and up to 6 audio channels with a sampling frequency of 192kHz/24bit resolution. It is fully compatible with conventional products, including conventional DTS digital surround 5.1-channel data.

**DTS Neural Surround**

DTS Neural Surround has been chosen as the surround sound format for XM Satellite Radio's "XM HD Surround", TV sports broadcasting, 7.1 games, Music Direct Internet streaming as well as leading FM and HD Radio stations. It delivers the rich envelopment and discrete image detail of surround sound by unmasking the audio details, typically lost by other playback modes. Audiences will experience the deep ambience and subtle details of movies, music and games.

**DTS NEO:6™ Surround**

DTS NEO:6™ is a matrix decoding technology for achieving 6.1-channel surround playback with 2-channel sources. It includes "DTS NEO:6 Cinema" suited for playing movies and "DTS NEO:6 Music" suited for playing music.

**Dynamic range**

The difference between the maximum undistorted sound level and the minimum discernible level above the noise emitted by the device.

**F****FLAC (Free Lossless Audio Codec)**

FLAC (Free Lossless Audio Codec) is a codec for audio data compression.

**H****HDCP**

When transmitting digital signals between devices, this copyright protection technology encrypts the signals to prevent content from being copied without authorization.

**HDMI**

This is an abbreviation of High-Definition Multimedia Interface, which is an AV digital interface that can be connected to a TV or amplifier. Video signal and audio signal can be connected using 1 cable.

## L

**LFE**

This is an abbreviation of Low Frequency Effect, which is an output channel that emphasizes low frequency effect sound. Surround audio is intensified by outputting 20 Hz to 120 Hz deep bass.

## M

**MAIN ZONE**

The room where this unit is placed is called the MAIN ZONE .

**MP3 (MPEG Audio Layer-3)**

This is an internationally standardized audio data compression scheme, using the "MPEG-1" video compression standard. It compresses the data volume to about one eleventh its original size while maintaining sound quality equivalent to a music CD.

**MPEG (Moving Picture Experts Group), MPEG-2, MPEG-4**

These are the names for digital compression format standards used for the encoding of video and audio. Video standards include "MPEG-1 Video", "MPEG-2 Video", "MPEG-4 Visual", "MPEG-4 AVC". Audio standards include "MPEG-1 Audio", "MPEG-2 Audio", "MPEG-4 AAC".

## P

**Pairing**

Pairing is an operation required for settings to connect two Bluetooth devices. Pairing enables Bluetooth devices to access each other.

**Progressive (sequential scanning)**

This is a scanning system of video signal that displays 1 frame of video as one image. Compared to the interlace system, this system provides images with less flickering and bleeding.

**Protection Circuit**

This is a function to prevent damage to components within the power supply when an abnormality such as an overload, excess voltage occurs or temperature for any reason.

In this unit, the power indicator blinks and the unit enters standby mode when an abnormality occurs.

## S

**Sampling frequency**

Sampling involves taking a reading of a sound wave (analog signal) at regular intervals and expressing the height of the wave at each reading in digitized format (producing a digital signal).

The number of readings taken in one second is called the "sampling frequency". The larger the value, the closer the reproduced sound is to the original.

**Speaker impedance**

This is an AC resistance value, indicated in  $\Omega$  (ohms). Greater power can be obtained with this value smaller.

**sYCC601 color**

Like x.v.Color, each of these color spaces defines a palette of available colors that is larger than the traditional RGB color model.

## V

**vTuner**

This is a free online content server for Internet radio. Note that usage fees are included in upgrade costs.

For inquiries about this service, visit the vTuner site below.

vTuner website: <http://www.radiomarantz.com>

This product is protected by certain intellectual property rights of Nothing Else Matters Software and BridgeCo. Use or distribution of such technology outside of this product is prohibited without a license from Nothing Else Matters Software and BridgeCo or an authorized subsidiary.

## W

**WAV (Wave)**

WAV is a standard audio format of Windows. The file size tends to increase, but sound near the original sound can be maintained.

**Windows Media DRM**

This is a copyright protection technology developed by Microsoft.

Content providers are using the digital rights management technology for Windows Media contained in this device (WM-DRM) to protect the integrity of their content (Secure Content) so that their intellectual property, including copyright, in such content is not misappropriated. This device uses WM-DRM software to play Secure Content (WM-DRM Software). If the security of the WM-DRM Software in this device has been compromised, owners of Secure Content (Secure Content Owners) may request that Microsoft revoke the WM-DRM Software's right to acquire new licenses to copy, display and/or play Secure Content. Revocation does not alter the WM-DRM Software's ability to play unprotected content. A list of revoked WM-DRM Software is sent to your device whenever you download a license for Secure Content from the Internet or from a PC. Microsoft may, in conjunction with such license, also download revocation list onto your device on behalf of Secure Content Owners.

**Windows Media Player Ver.11**

This is a media player distributed free of charge by Microsoft Corporation.

It can be used to play playlists created with Windows Media Player Ver. 11 as well as files in such formats as WMA, DRM WMA, MP3 and WAV.

**WMA (Windows Media Audio)**

This is audio compression technology developed by Microsoft Corporation.

WMA data can be encoded using Windows Media® Player Ver.7, 7.1, Windows Media® Player for Windows® XP and Windows Media® Player 9 Series.

To encode WMA files, only use applications authorized by Microsoft Corporation. If you use an unauthorized application, the file may not work properly.

## X

**x.v.Color**

This function lets HDTVs display colors more accurately. It enables display with natural, vivid colors. "x.v.Color" is a Sony registered trademark.

## Z

**ZONE2**

This unit can operate in a room other than the room where this unit is placed (MAIN ZONE) (ZONE2 playback). The room for ZONE2 playback is called ZONE2.

**ZONE3**

This unit can operate in a room other than the room where this unit is placed (MAIN ZONE) (ZONE3 playback). The room for ZONE3 playback is called ZONE3.

# Troubleshooting

If a problem should arise, first check the following:

1. Are the connections correct?

2. Is the set being operated as described in the user guide?

3. Are the other components operating properly?

If this unit does not operate properly, check the items listed in the table below. Should the problem persist, there may be a malfunction.

In this case, disconnect the power immediately and contact your store of purchase.

## [General]

Symptom	Cause/Solution	Page
Power does not turn on.	<ul style="list-style-type: none"> <li>Check whether the power plug is correctly inserted into the power outlet.</li> </ul>	7
Display is off.	<ul style="list-style-type: none"> <li>Set "Display" on the menu to something other than "OFF".</li> </ul>	86
Set does not operate properly.	<ul style="list-style-type: none"> <li>Reset the microprocessor.</li> </ul>	115

## [Video]

Symptom	Cause/Solution	Page
No picture appears.	<ul style="list-style-type: none"> <li>Check the TV connection.</li> <li>Set the TV input correctly.</li> </ul>	7 7

## [Audio]

Symptom	Cause/Solution	Page
Audio is not output.	<ul style="list-style-type: none"> <li>Check the connections for all devices.</li> <li>Check the speaker connections.</li> <li>Check whether the audio device power is turned on.</li> <li>Adjust the master volume.</li> <li>Cancel the mute mode.</li> <li>Select a suitable input source.</li> <li>Select a suitable input mode.</li> <li>Disconnect the headphones. No sound is output from the speakers or the PRE OUT connectors when headphones are connected.</li> </ul>	7, 16 – 24 6, 49 – 51 – 26, 62 26, 62 25, 62 71 98
No sound is produced from surround speaker.	<ul style="list-style-type: none"> <li>Check if the surround speakers are connected to the SURROUND terminals.</li> </ul>	–
No sound is produced from surround back speaker.	<ul style="list-style-type: none"> <li>Set "Amp Assign" on the menu to "Normal".</li> <li>Set "Speaker Config." – "S.Back" on the menu to something other than "None".</li> <li>Set the surround mode to something other than "STEREO".</li> </ul>	78 78 44
No sound is produced from front height speaker.	<ul style="list-style-type: none"> <li>Set "Amp Assign" on the menu to "Normal".</li> <li>Set "Speaker Config." – "F.Height" on the menu to something other than "None".</li> </ul>	78 78
No sound is produced from front wide speaker.	<ul style="list-style-type: none"> <li>Set "Amp Assign" on the menu to "Normal".</li> <li>Set "Speaker Config." – "F.Wide" on the menu to something other than "None".</li> </ul>	78 79
No sound is produced from subwoofer.	<ul style="list-style-type: none"> <li>Check the subwoofer connections.</li> <li>Turn on the subwoofer's power.</li> <li>Set "Speaker Config." – "Subwoofer" on the menu to "Yes".</li> <li>If "Front" and "Center" for "Speaker Config." are set to "Large", and "Subwoofer Mode" is set to "LFE", no sound may be output from the subwoofers, depending on the input signal or selected surround mode.</li> </ul>	6, 49 – 51 7 78 78, 79
DTS sound is not output.	<ul style="list-style-type: none"> <li>Set "Decode Mode" on the menu to "Auto" or "DTS".</li> </ul>	71
Dolby TrueHD, DTS-HD, Dolby Digital Plus audio is not output.	<ul style="list-style-type: none"> <li>Make HDMI connections.</li> </ul>	16



**[HDMI]**

Symptom	Cause/Solution	Page
No audio is output with HDMI connection.	• Check the connection of the HDMI connectors.	16
	• When outputting HDMI audio from the speakers, set "HDMI Audio Out" on the menu to "AMP".	80
	• When outputting HDMI audio from a TV, set "HDMI Audio Out" on the menu to "TV".	80
No video is output with HDMI connection.	• Check the connection of the HDMI connectors.	16
	• Set the input source to match the connected HDMI connector.	16, 25
	• Check whether the TV is compatible with copyright protection (HDCP). If connected to a device not compatible with HDCP, video will not be output correctly.	15
When the following operations are performed on devices compatible with HDMI control, the same operations occur on this unit. • Power ON/OFF • Switching audio output devices • Adjust volume • Switch input source	• Set "HDMI Control" on the menu to "OFF". To operate power only for each device, set "Power Off Control" to "OFF".	55, 81

**[SIRIUS Satellite Radio]**

Symptom	Cause/Solution	Page
"CHECK SIRIUS TUNER" is displayed.	• The SiriusConnect Home Tuner unit is not connected. Check that the connections are correct.	22
"ANTENNA ERROR" is displayed.	• The antenna is not connected. Check that the connections are correct.	22
"NO SIGNAL" is displayed.	• The antenna is not connected. Check that the connections are correct.	-
"INVALID CHANNEL" is displayed.	• Channel is not present. Select another channel.	-
"ACQUIRING SIGNAL" is displayed.	• The signal cannot be received. Reposition your SiriusConnect Home Tuner and Home Dock antenna.	-
	• Displays while SiriusConnect Home Tuner is connected. Reposition your SiriusConnect Home Tuner and Home Dock antenna.	-
"Call SIRIUS" * is displayed.	• Channels are not subscribed to. If you subscribe to the channel, you can receive the channel.	-
"SUBSCRIPTION UPDATED" is displayed.	• While updating contract information.	-
"Enter Lock Code [ ]" is displayed.	• Selected channels are locked. Please insert pass word (4 digits) into "[ ]"	-

\* After scroll displays "Call 888-539-...." twice, displays "Call SIRIUS".

**[HD Radio receiver]**

Symptom	Cause/Solution	Page
Reception fails, or there is a lot of noise or distortion.	• Change the antenna orientation or position.	22
	• Separate the AM loop antenna from the unit.	22
	• Use an FM outdoor antenna.	22
	• Separate the antenna from other connection cables.	22

**[M-XPort]**

Symptom	Cause/Solution	Page
Audio is not output when a wireless receiver (RX101 is connected).	• Check that the Bluetooth device and Wireless receiver (RX101) are correctly paired.	-

**[Internet radio / Media server / iPod / USB memory device / Flickr / Napster / Pandora / Rhapsody]**

Symptom	Cause/Solution	Page
When a USB memory device is connected, "USB" is not displayed on the menu.	• The set cannot recognize a USB memory device. Check the connection.	20
	• A USB memory device not conforming to mass storage class or MTP standards is connected. Connect a USB memory device conforming to mass storage class or MTP standards.	-
	• A USB memory device that the set cannot recognize is connected. This is not a malfunction. Marantz does not guarantee that all USB memory devices will operate or receive power.	-
	• USB memory device is connected via USB hub. Connect the USB memory device directly to the USB port.	-
Files on a USB memory device cannot be played.	• USB memory device is in format other than FAT16 or FAT32. Set the format to FAT16 or FAT32. For details, refer to the USB memory device's operating instructions.	-
	• USB memory device is divided into multiple partitions. When divided into multiple partitions, only files stored in the top partition can be played.	-
	• Files are stored in a non-compatible format. Record the files in a compatible format.	28
	• You are attempting to play a file that is copyright protected. Files that are copyright protected cannot be played on this set.	28
The file names are not displayed properly ("...", etc.).	• Characters that cannot be displayed are used. This is not a malfunction. On this set, characters that cannot be displayed are replaced with a ".".	-
Internet radio cannot be played.	• Ethernet cable is not properly connected or network is disconnected. Check the connection status.	24
	• Program is being broadcast in non-compatible format. Only Internet radio programs in MP3 and WMA can be played on this set.	34
	• The computer's or router's firewall is activated. Check the computer's or router's firewall settings.	-
	• Radio station is not currently broadcasting. Choose a radio station that is currently broadcasting.	35
	• IP address is wrong. Check the set's IP address.	83



Symptom	Cause/Solution	Page
Files stored on a computer cannot be played.	• Files are stored in a non-compatible format. Record in a compatible format.	34
	• You are attempting to play a file that is copyright protected. Files that are copyright protected cannot be played on this set.	34
	• Set and computer are connected by USB cable. The set's USB port cannot be used for connection to a computer.	–
Server is not found, or it is not possible to connect to the server.	• The computer's or router's firewall is activated. Check the computer's or router's firewall settings.	–
	• Computer's power is not turned on. Turn on the power.	–
	• Server is not running. Launch the server.	–
	• Set's IP address is wrong. Check the set's IP address.	83
iPod cannot be played.	• Connecting to the media server may take a few minutes the first time you attempt to make a connection.	–
	• Some iPods do not support being used connected directly to the USB port.	20
When an iPod is connected, "No Connection" is displayed.	• "No Connection" may display if you connect an iPod that has only a small amount of charge remaining in its battery to this unit. Should this occur, charge the iPod before connecting it to this unit.	–
Cannot connect to preset or favorite radio stations.	• Radio station is not currently broadcasting. Wait a while before trying again.	–
	• Radio station is not currently in service. It is not possible to connect to radio stations that are no longer in service.	–
For some radio stations, "Server Full" or "Connection Down" is displayed and station cannot be connected to.	• Station is congested or not currently broadcasting. Wait a while before trying again.	–
Sound is broken during playback.	• Network's signal transfer speed is slow or communications lines or radio station is congested. This is not a malfunction. When playing broadcast data with a high bit rate, the sound may be broken, depending on the communications conditions.	–
Sound quality is poor or played sound is noisy.	• File being played has a low bit rate. This is not a malfunction.	–
Cannot login to Rhapsody. ("Incorrect Username or Password" is displayed.)	• Login information is incorrect. Check if the Username for Rhapsody has been properly entered. Re-enter the Password. (Password is not displayed.) <a href="http://www.rhapsody.com/marantz">www.rhapsody.com/marantz</a>	83
Cannot compile Playlist.	• This unit does not respond to playlist compilation. When the playlist is compiled in PC Application, it is registered to "My Library". In this way, the playlist can be played in this unit	–

Symptom	Cause/Solution	Page
Cannot delete Rhapsody Channel registered in "My Channels"	• Cannot be done with this unit. Delete from PC Application.	–
Cannot delete Tracks, Playlists, Channels registered in "My Library"	• Cannot be done with this unit. Delete from PC Application.	–
Cannot login to Napster. ("Incorrect Username or Password" is displayed.)	• Login information is incorrect. Check if the Username for Napster has been properly entered. Re-enter the Password. (Password is not displayed.) <a href="http://www.napster.com/choose/index_default.html">http://www.napster.com/choose/index_default.html</a>	83
Cannot login to Pandora. ("Email address" or "Password" is displayed.)	• Login information is incorrect. Check if the "Email address" for Pandora has been properly entered. Re-enter the "Password". (Password is not displayed.) <a href="http://www.pandora.com/marantz">http://www.pandora.com/marantz</a>	40

**[Remote Control Unit]**

Symptom	Cause/Solution	Page
The set cannot be operated with the remote control unit.	• Batteries are worn out. Replace with new batteries.	102
	• Operate the remote control unit within a distance of about 7 m from this unit and at an angle of within 30°.	102
	• Remove any obstacle between this unit and the remote control unit.	102
	• Insert the batteries in the proper direction, checking the ⊕ and ⊖ marks.	102
	• The set's remote control sensor is exposed to strong light (direct sunlight, inverter type fluorescent bulb light, etc.). Move the set to a place in which the remote control sensor will not be exposed to strong light.	102

## Resetting the microprocessor

Perform this procedure if the display is abnormal or if operations cannot be performed.

When the microprocessor is reset, all the settings are reset to their default values.

Various setting details can be saved and reset on this device. If setting details are saved before returning to the default values, after returning to the default settings, setting details can be returned to the same values as before returning to the defaults.

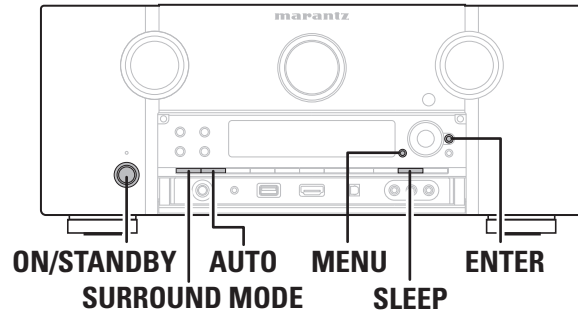

**1** When the power is ON, press and hold **SLEEP** and **ENTER** for more than 3 seconds.  
After "MEMORY SAVING" is shown on the display, "COMPLETE" is shown to inform you that the settings have been saved.

**2** Turn off the power using **ON/STANDBY**.

**3** Press **ON/STANDBY** while simultaneously pressing **SURROUND MODE** and **AUTO**.

**4** Once the display starts flashing at intervals of about 1 second, release the two buttons.

**5** Press and hold **SLEEP** and **MENU** for more than 3 seconds.  
After "MEMORY LOAD" is shown on the display, "COMPLETE" is shown to inform you that the settings have returned to those saved in step 1.



- To return all of the settings to the default values, perform steps 2 to 4 without performing step 1.
- If in step 3 the display does not flash at intervals of about 1 second, start over from step 1.

# Specifications

## □ Audio section

### • Analog

<b>Input sensitivity/Input impedance:</b>	200 mV/47 k $\Omega$
<b>Frequency response:</b>	10 Hz – 100 kHz — +1, –3 dB (DIRECT mode)
<b>S/N:</b>	105 dB (IHF-A weighted, DIRECT mode)
<b>Distortion:</b>	0.005 % (20 Hz ~ 20 kHz) (DIRECT mode)
<b>Rated output:</b>	Unbalanced pre-output: 1.2 V Balanced pre-output: 2.4 V

### • Digital

<b>D/A output:</b>	Rated output — 2 V (at 0 dB playback) Total harmonic distortion — 0.008 % (1 kHz, at 0 dB) S/N ratio — 102 dB Dynamic range — 100 dB Format — Digital audio interface
<b>Digital input:</b>	Format — Digital audio interface

### • Phono equalizer (PHONO input – REC OUT)

<b>Input sensitivity:</b>	2.5 mV
<b>RIAA deviation:</b>	$\pm 1$ dB (20 Hz to 20 kHz)
<b>S/N:</b>	74 dB (A weighting, with 5 mV input)
<b>Rated output:</b>	150 mV
<b>Distortion factor:</b>	0.03 % (1 kHz, 3 V)

## □ Video section

### • Standard video connectors

<b>Input/output level and impedance:</b>	1 V <sub>p-p</sub> , 75 $\Omega$
<b>Frequency response:</b>	5 Hz – 10 MHz — +1, –3 dB

### • Color component video connector

<b>Input/output level and impedance:</b>	Y (brightness) signal — 1 V <sub>p-p</sub> , 75 $\Omega$ P <sub>B</sub> / C <sub>B</sub> signal — 0.7 V <sub>p-p</sub> , 75 $\Omega$ P <sub>R</sub> / C <sub>R</sub> signal — 0.7 V <sub>p-p</sub> , 75 $\Omega$
<b>Frequency response:</b>	5 Hz – 60 MHz — +0, –3 dB (when "Video Convert" set to "OFF")

## □ Tuner section

	[FM]	[AM]
	(Note: $\mu$ V at 75 $\Omega$ , 0 dBf = $1 \times 10^{-15}$ W)	
<b>Receiving Range:</b>	87.5 MHz – 107.9 MHz	530 kHz – 1710 kHz
<b>Usable Sensitivity:</b>	1.5 $\mu$ V (14.8 dBf)	18 $\mu$ V
<b>S/N (IHF-A):</b>	MONO 78 dB STEREO 68 dB HD 85 dB	85 dB
<b>Total harmonic Distortion (at 1 kHz):</b>	MONO 0.1 % STEREO 0.2 % HD 0.02 %	0.02 %

## □ General

<b>Power supply:</b>	AC 120 V, 60 Hz
<b>Power consumption:</b>	60 W 0.2 W (Standby) 4.0 W (CEC standby)
<b>Maximum external dimensions:</b>	440 (W) x 187 (H) x 395 (D) mm
<b>Weight:</b>	10.1 kg

## □ Remote control unit (RC011SR)

<b>Batteries:</b>	R03/AAA Type (two batteries)
-------------------	------------------------------

For purposes of improvement, specifications and design are subject to change without notice.

## Index

 Numerics

2.1-channel	51
3D	15
5.1-channel	49, 50
6.1-channel	48, 50
7.1-channel	5, 48, 49

 A

A2DP	23, 109
Accessories	2
Add New Feature	86
Adjust CH	76
Adjusting the master volume	26
Adobe RGB color / Adobe YCC601 color	109
A-DSX Soundstage	75
AM loop antenna	22
Amp Assign	78
Antenna Aiming	68
ARC	15
Aspect	70
Audio Adjust	73
Audio cable	6, 17, 18, 19, 20, 21, 23
Audio Delay	76
Audio Setup	81
Audio/Video Adjust	72
Audyssey Auto Setup	8, 52
Audyssey DSX	75
Audyssey Dynamic EQ	74, 109
Audyssey Dynamic Surround Expansion™ (A-DSX)	109
Audyssey Dynamic Volume	75, 109
Audyssey MultEQ XT	74, 99, 109
Audyssey Settings	74
Auto Lip Sync	80, 109
Auto Preset	67
Auto Setup	8, 52

 B

Base Curve Copy	76
Bass	73, 83
Bass Setting	79
Bi-amp	51
Bluetooth	23, 109
Brightness	77

 C

Cable	
Audio cable	6, 17, 18, 19, 20, 21, 23
Coaxial digital cable	18

Component video cable	17, 18, 19
Ethernet cable	24
HDMI cable	7, 16
Optical cable	17, 19, 20, 21
Speaker cable	6
Video cable	17, 18, 19
Channel	83
Channel Level	56, 79
Characters	65
Chroma Level	77
C.Image	73
Coaxial digital cable	18
Component 2 Output	85
Component video cable	17, 18, 19
Condensation	3
Connection	
7.1CH INPUT terminal	23
Antenna	22
Blu-ray Disc player	7, 16, 17
Cable TV	18
CD player	20
CD recorder	21
DC OUT (TRIGGER OUT) jacks	54
Digital camcorder	16, 19
DVD player	16, 18
Game console	16
HDMI	15
HD Radio receiver	22
Home network (LAN)	24
iPod (USB)	20
Power cord	7
Record player	21
Remote control jacks	53
RS-232C connector	54
Satellite tuner	18
Set-top box	16, 18
SIRIUS	22
Speaker	5, 49
TV	7, 16, 17
USB memory device	20
Video cassette recorder	16, 19
Wireless receiver (RX101)	23
Contrast	77
Crossover Frequency	80
C.Width	73

 D

D.Comp	73
Decode Mode	71
Deep Color	15, 109
Dimension	73
Direct mode	27

Display	86, 99
Distance	79
DLNA	109
DNR	77
Dolby	
Dolby Digital	45, 109
Dolby Digital EX	45, 109
Dolby Digital Plus	45, 109
Dolby Headphone	46, 110
Dolby Pro Logic II	110
Dolby Pro Logic IIx	110
Dolby Pro Logic IIz	48, 110
Dolby TrueHD	45, 110
Dolby Virtual Speaker	46, 110
Downmix	110
DRC	73
DTS	45, 110
DTS 96/24	45, 110
DTS-ES Discrete 6.1	45, 110
DTS-ES Matrix 6.1	45, 110
DTS-HD	45, 110
DTS-HD High Resolution Audio	110
DTS-HD Master Audio	110
DTS Digital Surround	110
DTS Express	110
DTS NEO:6™ Surround	44, 110
DTS Neural Surround	45, 110
Dynamic EQ	74
Dynamic range	110
Dynamic Volume	75

 E

Enhancer	77
EQ Customize	81
Error messages (Auto Setup)	11
Ethernet cable	24

 F

Fader function	56
F.Height	78
Firmware Update	86
FLAC	110
Flickr	35, 38
FM indoor antenna	52
Front A/B (connection)	49, 51
Front height speaker	48, 49
Front Panel	98
Front wide speaker	48, 49
F.Wide	79

 G

GUI	84
-----	----

 H

HDCP	15, 110
HDMI	15, 110
HDMI 1.4a	15
HDMI Audio Out	80
HDMI cable	7, 16
HDMI Control	55, 80
HDMI Setup	80
HD Radio reception	22, 32
Headphones	98
Height Gain	73
HPF	83
HT-EQ	73
Hue	77

 I

Information	88
Audio Input Signal	88
HDMI Information	88
Preset Channel	88
Status	88
Input Assign	68
Input Mode	71
Input Setup	66
Input signal	45, 106
Inputting characters	65
Interval	72
i/p Scaler	70

 L

Learn function	93
Level Lch	83
Level Rch	83
LFE	73, 111
Listening mode	44
Listening position	8

 M

Macro function	95
Maintenance Mode	86
MAIN ZONE	111
Manual EQ	76
Manual Setup	77
Master volume display	85
M-DAX	76
Menu map	63
Monitor Out	80
MP3	111
MPEG	111
MPEG-4 AAC	111
MultEQ XT	74

Mute Level ..... 84  
M-XPort ..... 23

**N**

Napster ..... 35, 39  
Network Setup ..... 81  
  Napster Account ..... 83  
  Network Connecting ..... 81  
  Network Information ..... 83  
  Other ..... 82  
  Rhapsody Account ..... 83

**O**

Optical cable ..... 17, 19, 20, 21  
Option Setup ..... 84  
  Add New Feature ..... 86  
  Component 2 Output ..... 85  
  Display ..... 86  
  Firmware Update ..... 86  
  GUI ..... 84  
  Maintenance Mode ..... 86  
  Setup Lock ..... 86  
  Source Delete ..... 84  
  Trigger Out ..... 85  
  Volume Control ..... 84  
  Zone Rename ..... 85

**P**

Pairing ..... 111  
Pandora ..... 35, 40  
Panel lock function ..... 60  
Panorama ..... 73  
Parameter Check ..... 12  
Parental Lock ..... 67  
Picture Adjust ..... 77  
Playback  
  Blu-ray Disc player ..... 26  
  CD player ..... 26  
  Direct ..... 46  
  DVD player ..... 26  
  Flickr ..... 38  
  HD Radio reception ..... 32  
  Internet radio ..... 35  
  iPod(USB) ..... 27  
  Media server ..... 37  
  MP3 ..... 28, 34  
  MPEG-4 AAC ..... 34  
  Multi-channel ..... 44  
  Napster ..... 39  
  Network audio ..... 34  
  Pandora ..... 40  
  Pure direct ..... 46

Rhapsody ..... 42  
SIRIUS ..... 30  
Stereo ..... 46  
USB memory device ..... 28  
  WMA ..... 28, 34  
  ZONE2 ..... 62  
  ZONE3 ..... 62  
Playback Mode ..... 71  
Power Off Control ..... 81  
Power On Level ..... 84  
Preset codes ..... 91  
Preset Name ..... 68  
Preset Skip ..... 67  
Presetting radio stations ..... 33  
Progressive ..... 111  
Progressive Mode ..... 70  
Protection circuit ..... 111

**R**

Random ..... 71  
Rear panel ..... 100  
Reference Level Offset ..... 74  
Remote control settings ..... 89  
Remote control unit ..... 90, 101  
  Inserting the batteries ..... 102  
  Operating AV equipment ..... 90  
  Operating components ..... 92  
  Registering Preset Codes ..... 91  
Remote mode ..... 27  
Rename ..... 71  
Repeat ..... 71  
Resetting the microprocessor ..... 115  
Resolution ..... 70  
RGB Range ..... 80  
Rhapsody ..... 35, 42

**S**

Sampling frequency ..... 111  
S.Back ..... 78  
Screensaver ..... 84  
Selecting the input source ..... 25  
Setup Lock ..... 86  
SIRIUS ..... 22, 30  
Sleep timer ..... 56  
Slide Show ..... 72  
Source Delete ..... 84  
Source Level ..... 71  
Speaker  
  Connect ..... 49  
  Install ..... 5, 48  
  Set up ..... 8, 52  
Speaker cable ..... 6

Speaker Config. .... 78  
Speaker impedance ..... 111  
Speaker Setup ..... 78  
Stage Height ..... 75  
Stage Width ..... 75  
Standby Source ..... 81  
Still Picture ..... 72  
Subwoofer setting ..... 9  
Surround back speaker ..... 5, 48, 49, 50  
Surround Mode ..... 44, 104  
Surround Parameter ..... 73  
Switching the light illumination ..... 89  
Switching the front speakers ..... 26  
sYCC601 color ..... 111

**T**

Tone ..... 73  
Tone Control ..... 73  
Trademark ..... 103  
Treble ..... 73, 83  
Trigger Out ..... 85  
Troubleshooting ..... 112  
Turning off the sound temporarily ..... 26  
Turn off power (standby) ..... 12  
Turn on power ..... 7

**V**

Video ..... 69  
Video cable ..... 17, 18, 19  
Video conversion ..... 14  
Video Convert ..... 70  
Video Mode ..... 70  
Video Select ..... 69  
Volume Control ..... 84  
Volume Level ..... 83  
Volume Limit ..... 83, 84  
vTuner ..... 111

**W**

WAV ..... 111  
Web control ..... 58  
Windows Media DRM ..... 111  
Windows Media Player Ver.11 ..... 111  
Wireless LAN-compatible mobile terminal ..... 57  
WMA ..... 111

**X**

x.v.Color ..... 15, 111

**Z**

ZONE2 ..... 61, 99, 111  
ZONE3 ..... 61, 99, 111

Zone Rename ..... 85  
Zone Setup ..... 83

### Device select : BD

#### Blu-ray Disc Player

<b>D</b>	Denon	5034, 5035, 5036
<b>H</b>	Hitachi	5031, 5032, 5033
<b>I</b>	Integra	5013
<b>J</b>	JWC	5014, 5015, 5017, 5018, 5019, 5020
<b>L</b>	LG	5010, 5011
<b>M</b>	Marantz	5000, 5026, 5027
	Mitsubishi	5024, 5025
<b>O</b>	Onkyo	5013
<b>P</b>	Panasonic	5001, 5002, 5003
	Philips	5004
	Pioneer	5005
<b>R</b>	RCA	5012
<b>S</b>	Samsung	5005
	Sharp	5028, 5029, 5030
	Sony	5007, 5008, 5009, 5016
<b>T</b>	Toshiba	5012
<b>Y</b>	Yamaha	5021, 5022, 5023

### Device select : DVD

#### DVD Player

<b>A</b>	Aiwa	2036, 2037
	Apex	2012, 2017, 2018, 2019, 2021, 2034
<b>B</b>	BOSE	2038, 2039, 2063
<b>D</b>	Denon	2047, 2048
<b>F</b>	Funai	2049
<b>G</b>	GE	2009, 2020, 2029, 2033
<b>H</b>	Harman Kardon	2061
	Hitachi	2008, 2012, 2031
<b>J</b>	JVC	2006, 2010, 2040, 2041, 2042, 2043
<b>K</b>	Kenwood	2053, 2054
	Koss	2058
<b>M</b>	Magnavox	2007, 2011, 2023, 2025
	Marantz	2025, 2065
	Marantz (Blu-ray)	2064
	Mitsubishi	2011, 0215
<b>O</b>	Onkyo	2062
	Oritron	2009, 2030
<b>P</b>	Panasonic	2003, 2015, 2016, 2055
	Philips	2007, 2011, 2058
	Pioneer	2002, 2014, 2056
	Proscan	2009, 2020, 2032

<b>R</b>	RCA	2005, 2009, 2020, 2035, 2057
<b>S</b>	Sampo	2041
	Samsung	2008, 2012, 2022, 2024, 2027
	Sanyo	2050, 2052
	Sharp	2044, 2045
	Sherwood	2051
	Sony	2001, 2013, 2059
<b>T</b>	Toshiba	2004, 2008, 2026, 2028
<b>Y</b>	Yamaha	2046, 2060
<b>Z</b>	Zenith	2010

### Device select : SAT

#### Satellite Receiver

<b>A</b>	Alphastar	4027
	Amstrad	4046, 4047, 4050
	Atsky	4048
<b>B</b>	B Sky B	4021, 4045, 4046
<b>C</b>	Chaparral	4039
<b>D</b>	DIRECTV	4001, 4016, 4044
	DISH Network	4030
	Drake	4026
<b>E</b>	Echostar	4007, 4017, 4018, 4019, 4020, 4062, 4063, 4064
	Eurosky	4047, 4056
	Express Vu	4017
<b>F</b>	Foxtel	4051
	Freesat	4056
	Fujitsu	4025
<b>G</b>	GE	4002, 4008, 4009
	General Instruments	4036, 4037
	Gradiente	4044, 4057
<b>H</b>	Hitachi	4001, 4015
	Hughes	4001, 4016
	Humax	4049, 4050, 4051, 4052, 4053
<b>J</b>	Janeil	4025
	JVC	4017
<b>M</b>	Mitsubishi	4001
<b>N</b>	Nokia	4058, 4059, 4060, 4061
<b>O</b>	Optima	4048
<b>P</b>	Panasonic	4004, 4010
	Philips	4031, 4035, 4044, 4057
	Proscan	4002, 4008, 4009, 4011
<b>R</b>	Radio Shack	4036, 4037
	RCA	4002, 4008, 4009, 4029
	Realistic	4040
	Rural Cable	4036

<b>S</b>	Samsung	4022, 4027, 4042, 4043, 4050, 4054, 4055
	Schneider	4041, 4043
	SKY	4044, 4045, 4057
	Skyplus	4048
	Skysat	4041, 4047, 4056
	Sony	4003, 4012, 4014, 4065, 4066, 4067
	Star Choice	4032
	Star Trak	4024
	STS	4038
	SuperDish	4028
<b>T</b>	Teac	4049
	Thomson	4046, 4056
	Toshiba	4001, 4034
<b>U</b>	Uniden	4005, 4006, 4013
	Universum	4056
<b>V</b>	Video Pall	4025
<b>Z</b>	Zenith	4023, 4025, 4033

### Device select : TV

#### Television

<b>A</b>	Acer	1141
	Admiral	1002, 1009, 1089
	Aiko	1059
	Aiwa	1117, 1118
	Akai	1001
	Amtron	1023
	Anam	1113
	Anam National	1023, 1069, 1092
	AOC	1003, 1024, 1049, 1127
	Audiovox	1023
<b>B</b>	Bell & Howell	1009, 1025
	Benq	1104, 1142
	Broksonic	1003, 1097, 1098, 1113
<b>C</b>	Celebrity	1001
	Citizen	1003, 1013, 1023, 1026, 1059, 1063
	ColorTyme	1003, 1043
	Contec	1113
	Contec/Cony	1023, 1045, 1047
	Craig	1020, 1022, 1023, 1113
	Crown	1023, 1067
	Curtis Mathes	1003, 1013, 1025, 1026, 1062, 1103, 1110
<b>D</b>	Daewoo	1003, 1013, 1024, 1035, 1036, 1059, 1084, 1101
	Daytron	1003, 1013, 1016
	Dimensia	1103, 1110
	Dumont	1003, 1010, 1153

<b>E</b>	Electroband	1001
	Electrohome	1001, 1003, 1069, 1133
	Emerson	1003, 1013, 1015, 1020, 1021, 1022, 1023, 1025, 1038, 1044, 1045, 1048, 1055, 1061, 1094, 1096, 1099, 1101, 1113
	Envision	1003
<b>F</b>	Fisher	1025, 1051, 1091, 1160
	Fujitsu	1038, 1124, 1125, 1155
	Funai	1023, 1038, 1113
<b>G</b>	Gateway	1150
	GE	1003, 1018, 1022, 1046, 1054, 1069, 1085, 1103, 1110, 1113, 1133, 1136, 1153
	Goldstar	1003, 1013, 1024, 1030, 1045, 1080, 1100, 1112, 1154
<b>H</b>	Hallmark	1003
	Hisense	1116
	Hitachi	1003, 1012, 1031, 1032, 1037, 1041, 1045, 1047, 1065, 1068, 1082, 1088, 1094, 1139, 1140, 1145, 1159
<b>I</b>	Inf nity	1067
<b>J</b>	Janeil	1134
	JBL	1067
	JC Penney	1003, 1013, 1018, 1019, 1024, 1026, 1046, 1047, 1054, 1063, 1083, 1085, 1100, 1103, 1110, 1112, 1133, 1154
	Jensen	1003
	JVC	1028, 1029, 1045, 1047, 1050, 1060, 1065
<b>K</b>	Kawasho	1001, 1003
	Kenwood	1003
	Kloss Novabeam	1023, 1056, 1057, 1134
	KTV	1013, 1023, 1033, 1034, 1073, 1099, 1113
<b>L</b>	LG	1024, 1030
<b>M</b>	M.Wards	1002, 1009, 1038
	Magnavox	1003, 1052, 1053, 1056, 1057, 1063, 1067, 1081, 1106
	Marantz	1003, 1031, 1067, 1122
	Mitsubishi	1003, 1024, 1051, 1115, 1122, 1133
	Motorola	1014, 1069
<b>N</b>	NEC	1003, 1012, 1024, 1043, 1069
	NET-TV	1137, 1150
<b>O</b>	Orion	1020, 1096
<b>P</b>	Panasonic	1017, 1067, 1069, 1095, 1111
	Philips	1003, 1011, 1045, 1052, 1054, 1056, 1057, 1058, 1063, 1067, 1069, 1106

	Pioneer	1003, 1018, 1037, 1070, 1071, 1094, 1145, 1147, 1149
	Plasmsync	1135
	Portland	1003, 1013, 1024, 1059
	Price Club	1026
	Prism	1018
	Proscan	1004, 1005, 1006, 1007, 1008, 1085, 1103, 1110
	Proton	1003, 1045
<b>Q</b>	Quasar	1010, 1069, 1073, 1111, 1153
<b>R</b>	Radio Shack	1003, 1013, 1015, 1023, 1024, 1025, 1045, 1100, 1103, 1110, 1113
	RCA	1003, 1004, 1005, 1006, 1007, 1008, 1014, 1024, 1049, 1069, 1075, 1079, 1085, 1087, 1088, 1093, 1094, 1101, 1103, 1110, 1113, 1153
	Realistic	1013, 1015, 1023, 1025, 1045, 1100, 1103, 1110
	Runco	1010, 1153
<b>S</b>	Sampo	1150
	Samsung	1003, 1013, 1024, 1026, 1040, 1045, 1062, 1078, 1083, 1090, 1100, 1105, 1114, 1120, 1121, 1146, 1148, 1157
	Sansui	1119
	Sanyo	1003, 1025, 1051, 1072, 1077, 1091, 1156, 1157, 1158
	Sharp	1003, 1013, 1014, 1015, 1045, 1055, 1064, 1066, 1076, 1089, 1123
	Signature	1009
	Sony	1001, 1102, 1108
	Soundesign	1003, 1023, 1038, 1063, 1113
	Starlite	1023
	Supre-Macy	1134
	Sylvania	1003, 1039, 1042, 1052, 1053, 1056, 1057, 1063, 1067, 1089, 1151
	Symphonic	1023, 1039, 1044
<b>T</b>	Tandy	1014
	Tatung	1069
	Technics	1018
	Techwood	1003, 1018
	Teknika	1003, 1009, 1013, 1023, 1024, 1026, 1038, 1045, 1047, 1059, 1063, 1111, 1113
	Telecaption	1074
	Toshiba	1003, 1019, 1025, 1026, 1042, 1074, 1098, 1107, 1111, 1135, 1136
	Totevision	1013
<b>U</b>	Universal	1046, 1054



<b>V</b>	Video Concepts	1113
	Viewsonic	1006, 1022, 1109, 1128, 1129, 1130, 1131, 1138, 1143, 1145, 1150
<b>W</b>	Wards	1003, 1009, 1015, 1024, 1038, 1044, 1046, 1052, 1054, 1056, 1057, 1067, 1086, 1103, 1110
	White Westinghouse	1001, 1101
<b>Y</b>	Yamaha	1003, 1024
<b>Z</b>	Zenith	1003, 1009, 1010, 1132, 1144, 1153

## Device select : CD

### CD Player

<b>A</b>	AIWA	3001, 3002, 3003
	AKAI	3004, 3005, 3006
	AUDIO	3007
	AUDIO LABS	3008
<b>C</b>	CALIFORNIA	3008
	CARVER	3010, 3011, 3009
	CASIO	3012, 3020
	CURTIS	3020, 3012
<b>D</b>	DENON	3013
<b>E</b>	EMERSON	3014
<b>F</b>	FISHER	3011, 3015, 3016, 3017, 3018
<b>G</b>	GE	3019
	GENEXXA	3014, 3021, 3020
<b>H</b>	HARMON	3022, 3023, 3051
	HITACHI	3020
<b>I</b>	INKEL	3024
<b>J</b>	JC PENNEY	3012, 3020, 3025
	JVC	3026, 3027
<b>K</b>	KARDON	3022, 3051, 3023
	KRELL	3010
<b>L</b>	LUXMAN	3035, 3036, 3037, 3038
	LX I	3012, 3020, 3014
<b>M</b>	MAGNAVOX	3010, 3039, 3040
	MARANTZ	3010, 3041, 3042, 3043
	MATHES	3012, 3020
	MCS	3012, 3020
	MGA	3023
	MISSION	3010
	mitsubishi	3023, 3044
<b>N</b>	NAD	3034, 3045
	NAKAMICHI	3046, 3047, 3048
	NEC MCS	3025
	NIKKO	3007, 3016
<b>O</b>	ONKYO	3049, 3050, 3051, 3052, 3055, 3102, 3103

	OPTIMUS	3011, 3014, 3020, 3028, 3053, 3054, 3056, 3057, 3058, 3059
<b>P</b>	PANASONIC	3008, 3060, 3061
	PHILIPS	3009, 3010, 3010, 3040
	PIONEER	3020, 3021, 3062, 3063, 3064
<b>Q</b>	QUASAR	3008
<b>R</b>	RCA	3011, 3014, 3065, 3066, 3067, 3068, 3069
	REALISTIC	3011, 3014, 3020, 3042, 3054, 3057
	ROTEL	3010
	RS ORIGINAL	3070
<b>S</b>	SAE	3010, 3083
	SAMSUNG	3071
	SANSUI	3014, 3068, 3072, 3073
	SANYO	3011, 3018, 3074, 3075, 3076
	SCOTT	3014
	SEARS	3012, 3014, 3020, 3028, 3042
	SHARP	3028, 3042, 3077
	SHERWOOD	3042, 3056, 3070, 3078, 3024
	SHURE	3025
	SONY	3039, 3079, 3080, 3081, 3082, 3097, 3098, 3099, 3100, 3101
	SYLVANIA	3010
	SYMPHONIC	3083
<b>T</b>	TEAC	3016, 3042, 3057, 3083, 3084, 3085, 3086
	TECHNICA	3007, 3008, 3061, 3087, 3088
	THETA DIGITAL	3040
	TOSHIBA	3045
<b>V</b>	VICTOR	3026
<b>Y</b>	YAMAHA	3007, 3089, 3090, 3091, 3092
<b>Z</b>	ZENITH	3016, 3093, 3094, 3095, 3096





**Dimensions / Dimensions / Dimensions**

Unit : mm (in)

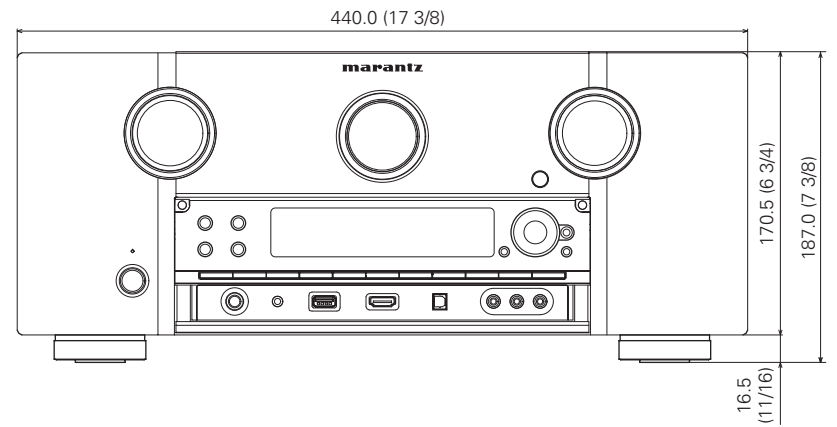
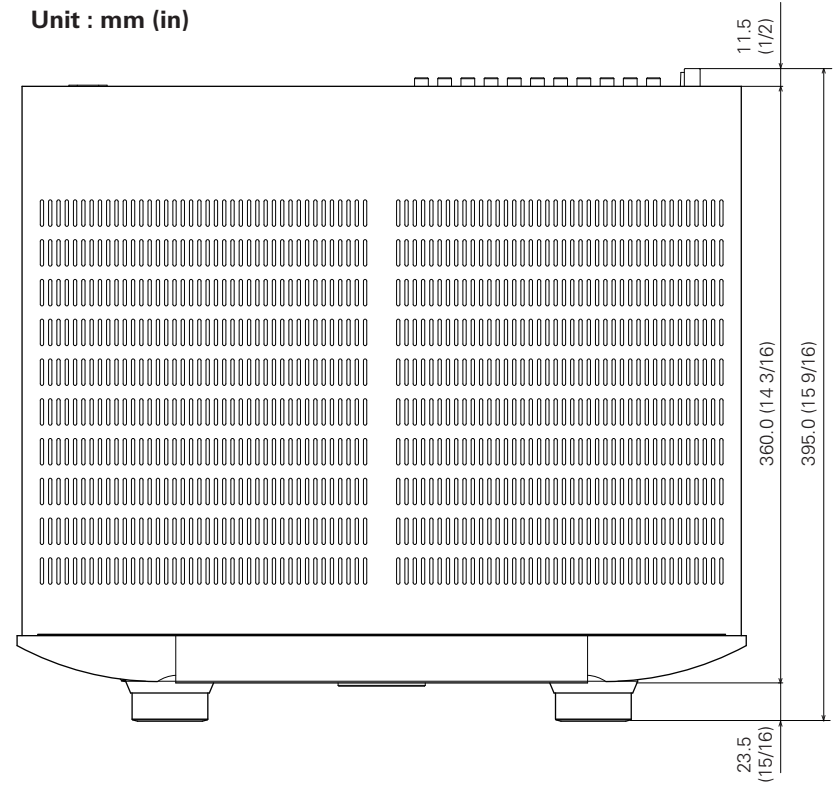

**[www.marantz.com](http://www.marantz.com)**

You can find your nearest authorized distributor or dealer on our website.

**marantz**<sup>®</sup> is a registered trademark.