

# **marantz®**

**Model SR7002/SR8002 User Guide**

---

AV Surround Receiver



**CAUTION**

**RISK OF ELECTRIC SHOCK**

**DO NOT OPEN**



**CAUTION: TO REDUCE THE RISK OF ELECTRIC SHOCK,**

**DO NOT REMOVE COVER (OR BACK)**

**NO USER-SERVICEABLE PARTS INSIDE**

**REFER SERVICING TO QUALIFIED SERVICE PERSONNEL**

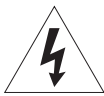

The lightning flash with arrowhead symbol within an equilateral triangle is intended to alert the user to the presence of uninsulated "dangerous voltage" within the product's enclosure that may be of sufficient magnitude to constitute a risk of electric shock to persons.



The exclamation point within an equilateral triangle is intended to alert the user to the presence of important operating and maintenance (servicing) instructions in the literature accompanying the product.

## WARNING

**TO REDUCE THE RISK OF FIRE OR ELECTRIC SHOCK,  
DO NOT EXPOSE THIS APPLIANCE TO RAIN OR MOISTURE.**

**CAUTION: TO PREVENT ELECTRIC SHOCK, MATCH WIDE BLADE OF PLUG  
TO WIDE SLOT, FULLY INSERT.**

**ATTENTION: POUR ÉVITER LES CHOCS ÉLECTRIQUES, INTRODUIRE LA  
LAME LA PLUS LARGE DE LA FICHE DANS LA BORNE CORRESPONDANTE  
DE LA PRISE ET POUSSER JUSQU'AU FOND.**

### NOTE TO CATV SYSTEM INSTALLER:

This reminder is provided to call the CATV (Cable-TV) system installer's attention to Section 820-40 of the NEC which provides guidelines for proper grounding and, in particular, specifies that the cable ground shall be connected to the grounding system of the building, as close to the point of cable entry as practical.

### NOTE:

This equipment has been tested and found to comply with the limits for a Class B digital device, pursuant to Part 15 of the FCC Rules. These limits are designed to provide reasonable protection against harmful interference in a residential installation. This equipment generates, uses and can radiate radio frequency energy and, if not installed and used in accordance with the instructions, may cause harmful interference to radio communications. However, there is no guarantee that interference will not occur in a particular installation. If this equipment does cause harmful interference to radio or television reception, which can be determined by tuning the equipment off and on, the user is encouraged to

try to correct the interference by one or more of the following measures:

- Reorient or relocate the receiving antenna.
- Increase the separation between the equipment and receiver.
- Connect the equipment into an outlet on a circuit different from that to which the receiver is connected.
- Consult the dealer or an experienced radio/TV technician for help.

### NOTE:

Changes or modifications not expressly approved by the party responsible for compliance could void the user's authority to operate the equipment.

# IMPORTANT SAFETY INSTRUCTIONS

READ BEFORE OPERATING EQUIPMENT

This product was designed and manufactured to meet strict quality and safety standards. There are, however, some installation and operation precautions which you should be particularly aware of.

1. Read Instructions – All the safety and operating instructions should be read before the product is operated.
2. Retain Instructions – The safety and operating instructions should be retained for future reference.
3. Heed Warnings – All warnings on the product and in the operating instructions should be adhered to.
4. Follow Instructions – All operating and use instructions should be followed.
5. Cleaning – Unplug this product from the wall outlet before cleaning. Do not use liquid cleaners or aerosol cleaners. Use a damp cloth for cleaning.
6. Attachments – Do not use attachments not recommended by the product manufacturer as they may cause hazards.
7. Water and Moisture – Do not use this product near water—for example, near a bath tub, wash bowl, kitchen sink, or laundry tub, in a wet basement, or near a swimming pool, and the like.
8. Accessories – Do not place this product on an unstable cart, stand, tripod, bracket, or table. The product may fall, causing serious injury to a child or adult, and serious damage to the product. Use only with a cart, stand, tripod, bracket, or table recommended by the manufacturer, or sold with the product. Any mounting of the product should follow the manufacturer's instructions, and should use a mounting accessory recommended by the manufacturer.

9. A product and cart combination should be moved with care. Quick stops, excessive force, and uneven surfaces may cause the product and cart combination to overturn.



10. Ventilation – Slots and openings in the cabinet are provided for ventilation and to ensure reliable operation of the product and to protect it from overheating, and these openings must not be blocked or covered. The openings should never be blocked by placing the product on a bed, sofa, rug, or other similar surface. This product should not be placed in a built-in installation such as a bookcase or rack unless proper ventilation is provided or the manufacturer's instructions have been adhered to.
11. Power Sources – This product should be operated only from the type of power source indicated on the marking label. If you are not sure of the type of power supply to your home, consult your product dealer or local power company. For products intended to operate from battery power, or other sources, refer to the operating instructions.
12. Grounding or Polarization – This product may be equipped with a polarized alternating current line plug (a plug having one blade wider than the other). This plug will fit into the power outlet only one way. This is a safety feature. If you are unable to insert the plug fully into the outlet, try reversing the plug. If the plug should still fail to fit, contact your electrician to replace your obsolete outlet. Do not defeat the safety purpose of the polarized plug.

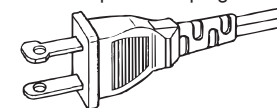

AC POLARIZED PLUG

13. Power-Cord Protection – Power-supply cords should be routed so that they are not likely to be walked on or pinched by items placed upon or against them, paying particular attention to cords at plugs, convenience receptacles, and the point where they exit from the product.
14. Protective Attachment Plug – The product is equipped with an attachment plug having overload protection. This is a safety feature. See Instruction Manual for replacement or resetting of protective device. If replacement of the plug is required, be sure the service technician has used a replacement plug specified by the manufacturer that has the same overload protection as the original plug.
15. Outdoor Antenna Grounding – If an outside antenna or cable system is connected to the product, be sure the antenna or cable system is grounded so as to provide some protection against voltage surges and built-up static charges. Article 810 of the National Electrical Code, ANSI/NFPA 70, provides information with regard to proper grounding of the mast and supporting structure, grounding of the lead-in wire to an antenna-discharge unit, size of grounding conductors, location of antennadischarge unit, connection to grounding electrodes, and requirements for the grounding electrode. See Figure 1.
16. Lightning – For added protection for this product during a lightning storm, or when it is left unattended and unused for long periods of time, unplug it from the wall outlet and disconnect the antenna or cable system. This will prevent damage to the product due to lightning and power-line surges.
17. Power Lines – An outside antenna system should not be located in the vicinity of overhead power lines or other electric light or power circuits, or where it can fall into such power lines or circuits. When installing an outside antenna system, extreme care should be taken to keep from touching such power lines or circuits as contact with them might be fatal.
18. Overloading – Do not overload wall outlets, extension cords, or integral convenience receptacles as this can result in a risk of fire or electric shock.
19. Object and Liquid Entry – Never push objects of any kind into this product through openings as they may touch dangerous voltage points or short-out parts that could result in a fire or electric shock. Never spill liquid of any kind on the product.
20. Servicing – Do not attempt to service this product yourself as opening or removing covers may expose you to dangerous voltage or other hazards. Refer all servicing to qualified service personnel.
21. Damage Requiring Service – Unplug this product from the wall outlet and refer servicing to qualified service personnel under the following conditions:
- When the power-supply cord or plug is damaged.
  - If liquid has been spilled, or objects have fallen into the product.
  - If the product has been exposed to rain or water.
  - If the product does not operate normally by following the operating instructions. Adjust only those controls that are covered by the operating instructions as an improper adjustment of other controls may result in damage and will often require extensive work by a qualified technician to restore the product to its normal operation.
  - If the product has been dropped or damaged in any way, and
  - When the product exhibits a distinct change in performance this indicates a need for service.
22. Replacement Parts – When replacement parts are required, be sure the service technician has used replacement parts specified by the manufacturer or have the same characteristics as the original part. Unauthorized substitutions may result in fire, electric shock, or other hazards.
23. Safety Check – Upon completion of any service or repairs to this product, ask the service technician to perform safety checks to determine that the product is in proper operating condition.
24. Wall or Ceiling Mounting – The product should be mounted to a wall or ceiling only as recommended by the manufacturer.
25. Heat – The product should be situated away from heat sources such as radiators, heat registers, stoves, or other products (including amplifiers) that produce heat.

**FIGURE 1**  
**EXAMPLE OF ANTENNA GROUNDING AS PER**  
**NATIONAL ELECTRICAL CODE, ANSI/NFPA 70**

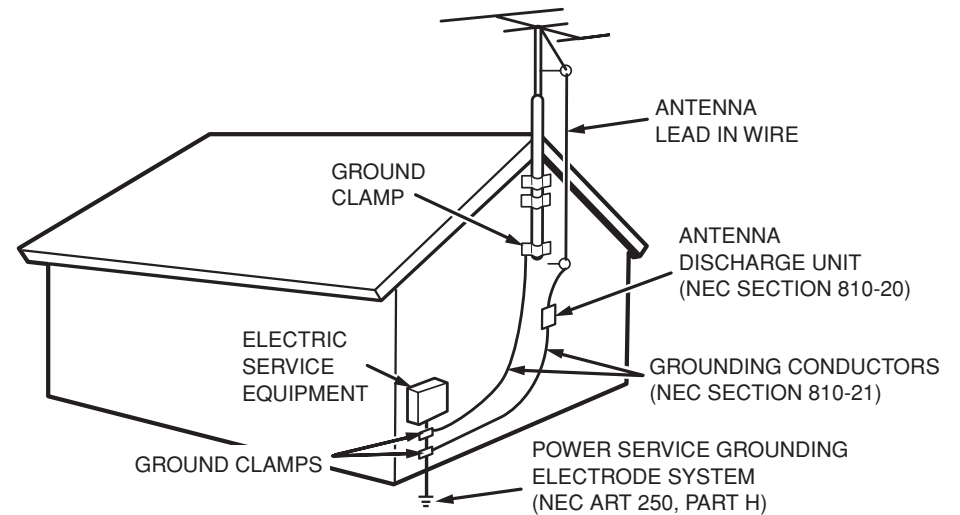

NEC - NATIONAL ELECTRICAL CODE

This Class B digital apparatus complies with Canadian ICES-003.

Cet appareil numérique de la Classe B est conforme à la norme NMB-003 du Canada.

## DECLARATION OF CONFORMITY

This device complies with Part 15 of the FCC rules. Operation is subject to the following conditions: (1) This device may not cause harmful interference, and (2) this device must accept any interference received, including interference that may cause undesired operation.

**U.S. Responsible Party: Marantz America, Inc.**  
**100 Corporate Drive,**  
**Mahwah, NJ, 07430, U.S.A.**  
**TEL: 630-741-0300**

Type of Product: AV Surround Receiver

Model: SR7002/8002

# INTRODUCTION

Thank you for purchasing the Marantz SR7002/SR8002 Surround receiver. This remarkable component has been engineered to provide you with many years of home theater enjoyment. Please take a few minutes to read this manual thoroughly before you connect and operate the SR7002/SR8002.

As there are a number of connection and configuration options, you are encouraged to discuss your own particular home theater setup with your Marantz A/V specialist dealer.

## ACCESSORIES CHECK

Before use, check the below accessories were included in the package.

### Remote Controller RC8001SR



### Remote Controller For Multiroom RC101

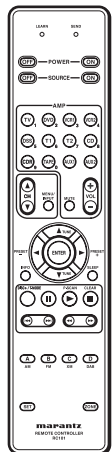

### AAA-size batteries × 5

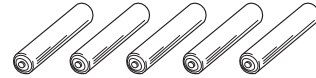

### Microphone

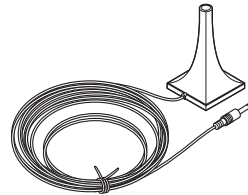

### AM Loop Antenna

### FM Antenna (For SR7002)

### FM Feeder Antenna (For SR8002)

### FM Antenna converter (Only SR8002)

### AC power cable

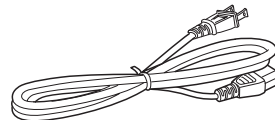

### Front AUX Jack Cover

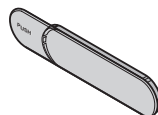

### User Guide

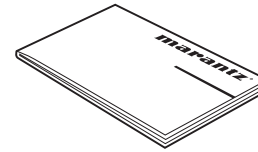

### Warranty Card

USA × 1  
Canada × 1



# TABLE OF CONTENTS

<b>INTRODUCTION .....</b>	<b>1</b>	CONNECTING THE ANTENNA TERMINALS.....	36	AUX2 INPUT.....	66
ACCESSORIES CHECK.....	1	XM RADIO OVERVIEW .....	37	VIDEO ON/OFF.....	66
<b>TABLE OF CONTENTS .....</b>	<b>2</b>	CONNECTING THE XM CONNECT-AND-PLAY		TV AUTO ON/OFF FUNCTION.....	66
<b>FEATURES.....</b>	<b>2</b>	ANTENNA.....	37	LIP.SYNC.....	66
DESCRIPTION.....	3	CONNECTING FOR THE MULTI ROOM.....	38	DUAL BACKUP MEMORY.....	66
<b>BEFORE USE.....</b>	<b>6</b>	CONNECTING OTHER EQUIPMENT.....	39	<b>BASIC OPERATION (TUNER).....</b>	<b>67</b>
OPERATION OF REMOTE CONTROLLER.....	7	<b>SETUP .....</b>	<b>40</b>	LISTENING TO THE TUNER.....	67
<b>NAMES AND FUNCTION .....</b>	<b>8</b>	ONSCREEN DISPLAY MENU SYSTEM.....	40	PRESET MEMORY .....	68
FRONT PANEL.....	8	1 INPUT SETUP .....	42	LISTENING TO THE HD RADIO STATIONS	
FL DISPLAY AND INDICATER.....	9	2 SPKR (SPEAKER) SETUP.....	45	(SR8002 ONLY).....	70
<b>REAR PANEL.....</b>	<b>10</b>	ERROR MESSAGES .....	48	RBDS OPERATION (SR8002 ONLY).....	73
<b>REMOTE CONTROL OPERATION</b>		3 SURROUND SETUP .....	51	LISTENING TO XM SATELLITE RADIO.....	74
<b>(RC8001SR).....</b>	<b>11</b>	4 VIDEO SETUP .....	53	SEARCH MODE.....	75
NAME AND FUNCTION.....	11	5 PREFERENCE .....	54	PRESET MEMORY .....	76
LCD INDICATORS (RC8001SR).....	12	6 ACOUSTIC EQ .....	56	<b>MULTI ROOM SYSTEM .....</b>	<b>78</b>
SETTING THE TIME .....	13	<b>BASIC OPERATION (PLAY BACK) ..</b>	<b>58</b>	MULTI ROOM PLAYBACK USING THE MULTI ROOM	
GENERAL INFORMATION OF RC8001SR TO THE UNIT ..	13	SELECTING AN INPUT SOURCE.....	58	OUT TERMINALS.....	78
CONTROLLING MARANTZ COMPONENTS .....	14	SELECTING THE SURROUND MODE.....	58	MULTI ROOM PLAYBACK USING THE MULTI SPEAKER	
BASIC OPERATION.....	17	DIALOGUE NORMALIZATION MESSAGE.....	58	TERMINALS .....	78
PROGRAMMING MACROS .....	20	NIGHT MODE.....	58	OPERATION OF THE MULTI ROOM OUTPUTS WITH	
CLONE MODE.....	22	ADJUSTING THE MAIN VOLUME .....	58	THE REMOTE CONTROL FROM MULTI A.....	79
SETUP.....	23	ADJUSTING THE TONE (BASS & TREBLE) CONTROL.....	59	<b>TROUBLESHOOTING .....</b>	<b>80</b>
<b>RENOTE CONTROL OPERATION (RC101)..</b>	<b>24</b>	TEMPORARILY TURNING OFF THE SOUND .....	59	HDMI.....	81
NAME AND FUNCTION.....	24	USING THE SLEEP TIMER.....	59	XM SATELLITE RADIO.....	81
GENERAL INFORMATION OF RC101 TO THE UNIT.....	25	M-DAX (MARANTZ DYNAMIC AUDIO EXPANDER).....	59	<b>TECHNICAL SPECIFICATIONS.....</b>	<b>82</b>
CONTROLLING MARANTZ COMPONENTS .....	25	VIDEO CONVERT .....	59		
BASIC OPERATION.....	28	I/P CONVERT .....	60		
OTHER OPERATIONS .....	30	<b>SURROUND MODE .....</b>	<b>60</b>		
<b>CONNECTIONS .....</b>	<b>31</b>	<b>OTHER FUNCTION.....</b>	<b>64</b>		
SPEAKER PLACEMENT .....	31	DISPLAY MODE.....	64		
CONNECTING SPEAKERS.....	31	RECORDING AN ANALOG SOURCE.....	64		
CONNECTING AUDIO COMPONENTS.....	32	SELECTING ANALOG AUDIO INPUT OR DIGITAL AUDIO			
CONNECTING VIDEO COMPONENTS.....	33	INPUT .....	64		
CONNECTING HDMI COMPONENTS.....	34	LISTENING THROUGH HEADPHONES .....	64		
ADVANCED CONNECTING .....	35	DOLBY HEADPHONE MODE .....	65		
CONNECTING THE REMOTE CONTROL JACKS.....	35	ATTENUATION TO ANALOG INPUT SIGNAL .....	65		
		SPEAKER A/B.....	65		
		7.1 CH INPUT.....	65		

# FEATURES

This unit incorporates the latest generation of digital surround sound decoding technology such as Dolby Digital EX, Dolby Digital, DTS ES (Discrete 6.1 and Matrix 6.1), DTS Neo:6 (Cinema, Music), Dolby Pro-Logic II (Movie, Music and Game), Dolby Pro-Logic IIx (Movie, Music and Game), Circle Surround II (Cinema, Music and Mono).

Additionally, the unit is compatible with Dolby TrueHD and DTS-HD (as used for Blu-ray and HD DVD discs) as well as Dolby Digital Plus, an expanded and improved version of Dolby Digital positioned as the next-generation delivery format. These audio formats can be sent with video signals via an HDMI cable to HDMI 1.3a-compatible equipment.

In addition, Marantz has focused on the future. By utilizing pre-out jacks, 7.1 direct inputs and a RS-232C communication port, the unit is tomorrow's technology, today!

## • THX Select 2 certified

7ch amplifiers have enough power for even the most difficult conditions found in large rooms.

Enormous power reserves endow the system with substantial dynamic ability at high sound levels.

110 watts (SR7002) / 125 watts (SR8002) to each of the 7 main channels the power amp section features an advanced, premium high-storage power supply capacitors, and fully discrete output stages housed in cast aluminum heat sinks .

This unit incorporates the most advanced Digital Signal Processing circuitry, along with a 192 kHz/24 bit D/A converter in each of the 7 channels. Independent power supply circuits are incorporated for the FL display, audio and video sections for maximum separation, clarity and dynamic range. Together with hand-selected customized components, all elements work in harmony to recreate the emotion, exactly as the artist had intended.

This unit is designed and engineered with extensive feedback from custom installation experts, dealers and consumers. It features multi-room/multisource, assignable DC trigger, a RS-232C communication port, Flasher input, heavy duty speaker binding posts and an extensive array of both analog and digital inputs / outputs. With 6 assignable digital inputs (7 total), 4 component inputs, Super Audio CD Multi Channel (7.1 channel) direct inputs, video convert system and a speaker-B and OSD output versatility is taken to a stunning new level. Furthermore, the unit can output the OSD information through the Y/C (S-video) and composite video outputs.

An easy-to-use programmable, learning remote controller allows full access to all of the operating functions and can be used for system operation as well.

The new generation of Marantz Receivers is stylish and completely symmetrical. On the front panel of the unit, buttons are kept to a minimum. Source selectors and volume controls are intuitively placed. This unit is here to perform in your unrivaled home entertainment setup.

**• HDMI**

HDMI (High-Definition Multimedia Interface) is an enhancement to the DVI (Digital Visual Interface) standard. It adds capabilities for digitally transmitting audio signals in addition to video signals. Where multiple cables were previously needed for audio/video, HDMI enables audio/video connection via a single cable.

The HDMI input jacks of this unit support HDMI Ver. 1.3a. and the HDMI output jacks of this transmitter support HDMI Ver. 1.3a.

**Copyright Protection**

This unit supports HDCP (High-bandwidth Digital Content Protection). HDCP is copyright protection technology that consists of data encoding and other device authentication. Its purpose is to protect digital video content. Both this unit and the connected component (such as a video player or monitor) must support HDCP. Before connecting a component to this unit, refer to its instruction manual.

- xvYCC
- Deep Color 36bit
- THX / THX Surround EX
- Dolby True HD, Dolby Digital Plus dts HD
- Dolby Digital EX, Dolby Digital, DTS ES (Discrete 6.1, Matrix 6.1, Neo:6)
- Dolby Headphone
- Dolby Pro Logic II (Movie, Music, Game)
- Dolby Pro Logic IX (Movie, Music, Game)
- Circle Surround II (Cinema, Music, Mono)
- HDCD
  
- Bi-amp drive
- Source/Pure Direct mode
- 9 bands x 7 ch GEQ
- DSD to PCM converter
  
- Audyssey Mult EQ
- XM Satellite Radio Ready
- XM® HD Surround Powered by Neural Audio
- HD Radio (SR8002 Only)
- Improved Station Name Input Method, 60 Presets

- Auto Adjust Function for Speaker Distance Settings (Delay Time)
- M-DAX (Marantz Dynamic Audio eXpander)
- Assignable DC Trigger Output
- Assignable Video Input
- Auto Lipsync (Audio Delay)
  
- 7 × 110 Watts (8 Ohms), Discrete Amplifiers (SR8002: 7 × 125 Watts)
- High Power Current Feedback Circuitry
- Massive Energy Power Supply, Huge EI Transformer, Large ELCO's. (SR7002 only)
- Troidal Core Transformer (SR8002 only)
- Function Rename
- 192 kHz/24 bit DAC for all 8 Channels
- 32 bit Digital Surround Processing Chipsets
- Large Heavy Duty Speaker Terminals for all Channels
- Auto Input Signal Detection
- Front Optical AUX Input (Digital Camera, Portable DVD)
- Multi Room B output (SR8002 only)
  
- Video Off Mode
- Set Up Menu via all Video Output (Composite, S-Video, Component video and HDMI)
- Video convert system  
HDMI ← Component Video ↔ S-Video ↔ Composit Video
- Two component monitor outputs
- Video I/P Converter
- Selectable Multi Room Component Video output (SR8002 only)
  
- RS-232C Terminal for Future Upgrade or System Control
- Emitter Output (SR8002 only)
- Programmable, learning remote controller
- Flasher Input
- IR Receiver Input (SR8002 only)

**DESCRIPTION**



**THX**  
SELECT 2  
SURROUND EX

RECOMMENDED USE

Medium-sized Home Theater or Living Room

THX CERTIFICATION FEATURES

**THX Cinema, Music, Games modes using:**

- Re-Equalization
- Timbre Matching
- Adaptive Decorrelation
- ASA Technology

**Boundary Gain Compensation**

ADDITIONAL THX TECHNOLOGIES

**Neural-THX Surround**

THX PERFORMANCE

Capable of THX Reference Level at approx.  
9 feet (3 meters) viewing/listening distance

Visit [www.thx.com](http://www.thx.com) for further technical details.

THX® is an exclusive set of standards and technologies established by the world-renowned film production company, Lucasfilm Ltd. THX resulted from George Lucas' desire to reproduce the movie soundtrack as faithfully as possible both in the movie theater and in the home theater.

THX engineers developed patented technologies to accurately translate the sound from a movie theater environment into the home, correcting the tonal and spatial errors that occur.

When the THX mode of the unit is on, three distinct THX technologies are automatically added:

Re-Equalization-restores the correct tonal balance for watching a movie in a home environment.

These sounds are otherwise mixed to be brighter for a large movie theater. Re-EQ compensates for this and prevents the soundtracks from being overly bright and harsh when played in a home theater.

Timbre Matching-filters the information going to the surround speakers so they more closely match the tonal characteristics of the sound coming from the front speakers.

This ensures seamless panning between the front and surround speakers.

Adaptive Decorrelation-slightly changes one surround channel's time and phase relationship with respect to the other surround channel.

This expands the listening position and creates with only two surround speakers the same spacious surround experience as in a movie theater with multiple surround speakers.

The unit was required to pass a rigorous series of quality and performance tests, in addition to incorporating the technologies explained above, in order to be THX certified.

THX requirements cover every aspect of performance including pre-amplifier and power amplifier performance and operation, and hundreds of other parameters in both the digital and analog domain.

Movies which have been encoded in Dolby Digital, DTS, Dolby Pro Logic, stereo and Mono will all benefit from the THX mode when being viewed.

The THX mode should only be activated when watching movies which were originally produced for a movie theater environment.

THX need not be activated for music, movies made especially for TV, or shows such as sports programming, talk shows, etc.

This is because they were originally mixed for a small room environment.

THX and Select 2 are trademarks of THX Ltd. THX may be registered in some jurisdictions. Surround EX is a trademark of Dolby Laboratories. Used with permission.

**THX SURROUND EX**

THX Surround EX—Dolby Digital Surround EX is a joint development of Dolby Laboratories and THX Ltd.

In a movie theater, film soundtracks that have been encoded with Dolby Digital Surround EX technology are able to reproduce an extra channel which has been added during the mixing of the program. This channel, called Surround Back, places sounds behind the listener in addition to the currently available front left, front center, front right, surround right, surround left and subwoofer channels. This additional channel provides the opportunity for more detailed imaging behind the listener and brings more depth, spacious ambience and sound localization than ever before.

Movies that were created using the Dolby Digital Surround EX technology, when released into the home consumer market may exhibit wording to that effect on the packaging. A list of movies created using this technology can be found on the Dolby web site at [www.dolby.com](http://www.dolby.com). A list of available DVD software titles encoded with this technology can be found at [www.thx.com](http://www.thx.com).

Only receiver and controller products bearing the THX Surround EX logo, when in the THX Surround EX mode, faithfully reproduce this new technology in the home. This product may also engage the THX Surround EX mode during the playback of 5.1 channel material that is not Dolby Digital Surround EX encoded. In such case, the information delivered to the Surround Back channel will be program dependent and may or may not be very pleasing depending on the particular soundtrack and the tastes of the individual listener.

“SURROUND EX™” is a trademark of Dolby Laboratories. Used under authorization.

### THX Select2

Before any home theater component can be THX Select2 certified, it must pass a rigorous series of quality and performance tests. Only then can a product feature the THX Select2 logo, which is your guarantee that the Home Theater products you purchase will give you superb performance for many years to come. THX Select2 requirements define hundreds of parameters, including power amplifier performance, and pre-amplifier performance and operation for both digital and analog domains. THX Select2 receivers also feature proprietary THX technologies (e.g., THX Mode) which accurately translate movie soundtracks for home theater playback.



Neural Surround™, THX® Technologies has been chosen as the official surround sound broadcast format for XM Satellite Radio's "XM HD Surround" and other leading FM/HD radio stations in the USA and worldwide. Neural Surround, THX Technologies delivers the rich envelopment and discrete image detail of surround sound in a format 100% compatible with stereo.

Neural Surround, THX Technologies draws the brain's attention to sonic details in musical instruments, vocals and ambience that are typically masked by other playback systems. This allows the listener to fully experience the richness and subtleties in recorded performance as never before for both surround encoded material and regular stereo material such as CDs or digital media players. Neural Surround, THX Technologies is enabling the second surround sound revolution, bringing surround directly to your ears!

This product is manufactured under license from Neural Audio Corporation and THX Ltd. Marantz hereby grants the user a non-exclusive, non-transferable, limited right of use to this product under USA and foreign patent, patent pending and other technology or trademarks owned by Neural Audio Corporation and THX Ltd. "Neural Surround", "Neural Audio", "Neural" and "NRL" are trademarks and logos owned by Neural Audio Corporation, THX is a trademark of THX Ltd., which may be registered in some jurisdictions. All rights reserved.



Manufactured under license under U.S. Patent #'s: 5,451,942; 5,956,674; 5,974,380; 5,978,762; 6,226,616; 6,487,535; 7,003,467 & other U.S. and worldwide patents issued & pending. DTS, DTS Digital Surround, ES, and Neo:6 are registered trademarks and the DTS logos, Symbol and DTS 96/24 are trademarks of DTS, Inc. © 1996-2007 DTS, Inc. All Rights Reserved.

### • dts Digital Surround

DTS was introduced in 1994 to provide 5.1 channels of discrete digital audio into home theater systems. DTS brings you premium quality discrete multichannel digital sound to both movies and music.

DTS is a multichannel sound system designed to create full range digital sound reproduction.

The no compromise DTS digital process sets the standard of quality for cinema sound by delivering an exact copy of the studio master recordings to neighborhood and home theaters.

Now, every moviegoer can hear the sound exactly as the moviemaker intended.

DTS can be enjoyed in the home for either movies or music on of DVD's, LD's, and CD's.

### • dts Neo:6®

The advantages of discrete multichannel systems over matrix are well known.

But even in homes equipped for discrete multichannel, there remains a need for high-quality matrix decoding. This is because of the large library of matrix surround motion pictures available on disc and on VHS tape; and analog television broadcasts.

The typical matrix decoder of today derives a center channel and a mono surround channel from two-channel matrix stereo material. It is better than a simple matrix in that it includes steering logic to improve separation, but because of its mono, band-limited surround it can be disappointing to users accustomed to discrete multichannel.

Neo:6 offers several important improvements as follows,

- Neo:6 provides up to six full-band channels of matrix decoding from stereo matrix material. Users with 6.1 and 5.1 systems will derive six and five separate channels, respectively, corresponding to the standard home-theater speaker layouts.
- Neo:6 technology allows various sound elements within a channel or channels to be steered separately, and in a way which follows naturally from the original presentation.
- Neo:6 offers a music mode to expand stereo nonmatrix recordings into the five- or six-channel layout, in a way which does not diminish the subtlety and integrity of the original stereo recording.

### • dts Digital Surround ES®

DTS-ES Extended Surround is a new multichannel digital signal format developed by Digital Theater Systems Inc. While offering high compatibility with the conventional DTS Digital Surround format, DTS-ES Extended Surround greatly improves the 360-degree surround impression and space expression thanks to further expanded surround signals. This format has been used professionally in movie theaters since 1999.

In addition to the 5.1 surround channels (FL, FR, C, SL, SR and LFE), DTS-ES Extended Surround also offers the SB (Surround Back) channel for surround playback with a total of 6.1 channels. DTS-ES Extended Surround includes two signal formats with different surround signal recording methods, as DTS-ES Discrete 6.1 and DTS-ES Matrix 6.1.

### • dts Digital Surround 96/24

The stereo CD is a 16-bit medium with sampling at 44.1 kHz. Professional audio has been 20- or 24-bit for some time, and there is increasing interest in higher sampling rates both for recording and for delivery into the home. Greater bit depths provide extended dynamic range. Higher sampling rates allow wider frequency response and the use of anti-alias and reconstruction filters with more favorable aural characteristics.

DTS 96/24 allows for 5.1 channel sound tracks to be encoded at a rate of 96kHz/24bits on DVD-Video titles.

When DVD-video appeared, it became possible to deliver 24-bit, 96 kHz audio into the home, but only in two channels, and with serious limitations on picture. This capability has had little use.

DVD-audio allows 96/24 in six channels, but a new player is needed, and only analog outputs are provided, necessitating the use of the D/A converters and analog electronics provided in the player.

DTS 96/24 offers the following:

1. Sound quality transparent to the original 96/24 master.
2. Full backward compatibility with all existing decoders. (Existing decoders will output a 48 kHz signal)
3. No new player required: DTS 96/24 can be carried on DVD-video, or in the video zone of DVD-audio, accessible to all DVD players.
4. 96/24 5.1-channel sound with full-quality full-motion video, for music programs and motion picture soundtracks on DVD-video.



DTS-HD Master Audio is capable of delivering audio that is a bit-for-bit identical to the studio master. DTS-HD Master Audio delivers audio at super high variable bit rates -24.5 mega-bits per second (Mbps) on Blu-ray discs and 18.0 Mbps on HD-DVD - that are significantly higher than standard DVDs. This bit stream is so "fast" and the transfer rate is so "high" that it can deliver the Holy Grail of audio: 7.1 audio channels at 96k sampling frequency/24 bit depths that are identical to the original. With DTS-HD Master Audio, you will be able to experience movies and music, exactly as the artist intended: clear, pure, and uncompromised.

Manufactured under license under U.S. Patent #'s: 5,451,942; 5,956,674; 5,974,380; 5,978,762; 6,226,616; 6,487,535 & other U.S. and worldwide patents issued & pending. DTS is a registered trademark & the DTS logos and Symbol are trademarks of DTS, Inc. © 1996-2007 DTS, Inc. All Rights Reserved.



DTS-HD High Resolution Audio can deliver up to 7.1 channels of sound that is virtually indistinguishable from the original. DTS-HD High Resolution Audio delivers audio at high constant bit rates superior to standard DVDs---6.0 Mbps on Blu-ray discs and 3.0 Mbps on HD-DVD to produce outstanding sound quality. It is capable of delivering up to 7.1 channels at 96k sampling frequency/24 bit depth resolution. It allows content creators to deliver rich, high definition audio on movies where disc space may not allow for DTS-HD Master Audio.



Manufactured under license under U.S. Patent #'s: 5,451,942; 5,956,674; 5,974,380; 5,978,762; 6,226,616; 6,487,535 & other U.S. and worldwide patents issued & pending. DTS is a registered trademark and the DTS logos, Symbol, DTS-HD, DTS-HD High Resolution Audio and DTS-HD High Res Audio are trademarks of DTS, Inc. © 1996-2007 DTS, Inc. All Rights Reserved.



Dolby Digital identifies the use of Dolby Digital audio coding for such consumer formats as DVD and DTV. As with film sound, Dolby Digital can provide up to five full-range channels for left, center, and right screen channels, independent left and right surround channels, and a sixth (".1") channel for low-frequency effects.

Dolby Surround Pro Logic II is an improved matrix decoding technology that provides better spatiality and directionality on Dolby Surround program material; provides a convincing three-dimensional soundfield on conventional stereo music recordings; and is ideally suited to bring the surround experience to automotive sound. While conventional surround programming is fully compatible with Dolby Surround Pro Logic II decoders, soundtracks will be able to be encoded specifically to take full advantage of Pro Logic II playback, including separate left and right surround channels. (Such material is also compatible with conventional Pro Logic decoders.)

Dolby Digital EX creates six full-bandwidth output channels from 5.1-channel sources. This is done using a matrix decoder that derives three surround channels from the two in the original recording. For best results, Dolby Digital EX should be used with movies soundtracks recorded with Dolby Digital Surround EX.

**About Dolby Pro Logic IIx**

Dolby Pro Logic IIx technology delivers a natural and immersing 7.1-channel listening experience to the home theater environment. A product of Dolby's expertise in surround sound and matrix decoding technologies, Dolby Pro Logic IIx is a complete surround sound solution that maximizes the entertainment experience from stereo as well as 5.1-channel encoded sources.

Dolby Pro Logic IIx is fully compatible with Dolby Surround Pro Logic technology and can optimally decode the thousands of commercially available Dolby Surround encoded video cassettes and television programs with enhanced depth and spatiality. It can also process any high-quality stereo or Advanced Resolution 5.1-channel music content into a seamless 6.1- or 7.1-channel listening experience.



The Dolby Headphone technology provides a surround sound listening experience over headphones. When listening to multichannel content such as DVD movies over headphones, the listening experience is fundamentally different than listening to speakers. Since the headphone speaker drivers are covering the pinna of the ear, the listening experience differs greatly from traditional speaker playback. Dolby utilizes patented headphone perspective curves to solve this problem and provides a non-fatiguing, immersive, home theater listening experience. Dolby Headphone also delivers exceptional 3D audio from stereo material.



Dolby Virtual Speaker is a technology certified by Dolby Laboratories that creates a virtualized surround sound experience from two speakers using a multichannel Dolby Digital source. Additionally, Dolby Virtual Speaker can simulate the surround sound effect produced by Dolby Pro Logic or Dolby Surround Pro Logic II.

Dolby Virtual Speaker retains all the original Multichannel audio information and provides the listener with the sensation of being surrounded by additional speakers.

Manufactured under license from Dolby Laboratories. "Dolby", "Pro Logic", "Surround EX", and the double-D symbol are trademarks of Dolby Laboratories.



Dolby® TrueHD is Dolby's next-generation lossless technology developed for high-definition disc-based media. Dolby TrueHD delivers tantalizing sound that is bit-for-bit identical to the studio master, unlocking the true high-definition entertainment experience on next-generation discs. When coupled with high-definition video, Dolby TrueHD offers an unprecedented home theater experience that lets you enjoy sound as stunning as the high-definition picture.

Manufactured under license from Dolby Laboratories. "Dolby", "Pro Logic", "Surround EX", and the double-D symbol are trademarks of Dolby Laboratories.



Dolby Digital Plus is a highly sophisticated and versatile audio codec based on Dolby Digital and designed specifically to adapt to the changing demands of future audio, video delivery, and audio storage systems while simultaneously retaining backwards compatibility with the existing Dolby Digital 5.1-channel home theater systems in use today.

Manufactured under license from Dolby Laboratories. "Dolby", "Pro Logic", "Surround EX", and the double-D symbol are trademarks of Dolby Laboratories.



Circle Surround II (CS-II) is a powerful and versatile multichannel technology. CS-II is designed to enable up to 6.1 multichannel surround sound playback from mono, stereo, CS encoded sources and other matrix encoded sources. In all cases the decoder extends it into 6 channels of surround audio and a LFE/subwoofer signal. The CS-II decoder creates a listening environment that places the listener "inside" music performances and dramatically improves both hi-fi audio conventional surround-encoded video material. CS-II provides composite stereo rear channels to greatly improve separation and image positioning— adding a heightened sense of realism to both audio and A/V productions.

CS-II is packed with other useful feature like dialog clarity (SRS Dialog) for movies and cinema-like bass enrichment (TruBass). CS-II can enable the dialog to become clearer and more discernable in movies and it enables the bass frequencies contained in the original programming to more closely achieve low frequencies—overcoming the low frequency limitations of the speakers by full octave.

Circle Surround II, Dialog Clarity, TruBass, SRS and  symbol are trademarks of SRS Labs, Inc. Circle Surround II, Dialog Clarity and TruBass technology are incorporated under license from SRS Labs, Inc.



HDCD® (High Definition Compatible Digital ®) is a patented process for delivering on Compact Disc the full richness and details of the original microphone feed. HDCD encoded CDs sound better because they are encoded with 20-bits of real musical information as compared to 16-bits for all other CDs. HDCD overcomes the limitation of the 16-bit CD format by using a sophisticated system to encode the additional four bits onto the CD while remaining completely compatible with the CD format.

When listening to HDCD recordings, you hear more dynamic range, a focused 3-D sound stage, and extremely natural vocal and musical timbre. With HDCD, you get the body, depth and emotion of the original performance not a flat, digital imitation. HDCD system manufactured under license from Microsoft. This product is covered by one or more of the following: In the United States 5,479,168 5,638,074 5,640,161 5,808,574 5,838,274 5,854,600 5,864,311 5,872,531 and in Australia 669,114 with other patents pending.



HDMI, the  and High-Definition Multimedia Interface are trademarks or registered trademarks of HDMI Licensing LLC.

## HD Radio®

HD Radio™ technology is a new technology that enables AM and FM radio stations to broadcast programs digitally. Digital broadcasting provides listeners with radically improved audio quality and reception as well as new data services. Furthermore, supplemental program services allow listeners to select from up to 8 HD Radio programs multicast on a single FM HD Radio channel. For more information on HD Radio™ technology, visit "www.ibiquity.com".

HD Radio™ Technology Manufactured Under License From iBiquity Digital Corp. U.S. and Foreign Patents. HD Radio™ and the HD Radio logo are proprietary trademarks of iBiquity Digital Corp.

### XM Satellite Radio Ready



### READY

The XM name and related logos are registered trademarks of XM Satellite Radio Inc.

XM HD Surround uses Neural Surround™ technology to achieve optimal surround sound from XM radio.



There are several factors that can degrade the sound from even the best loudspeakers in a listening room. One of the most important is the interaction of sound from the loudspeakers with large surfaces such as walls, the floor, and the ceiling in the room. Even with careful loudspeaker placement and acoustical treatments, there are significant problems that are caused by room acoustics. These include reflections from nearby surfaces and standing waves that are created between large parallel surfaces in the room. In a home theater the situation is further complicated because there are several listening locations. The effects of room acoustics on the sound arriving at each person's ears are very different and the result is a listening experience that is degraded in a different way for every person in the room. It is not uncommon to have variations in two adjacent seats that are as large as 10 dB, particularly in the frequency range below 250 Hz.

The solution to this problem is to apply room correction after precisely measuring how each loudspeaker interacts with the room. Because the room causes variations in the frequency response of the loudspeakers that are so large from seat to seat, it is important to measure each loudspeaker at several locations in the listening room. This should be done even if there is only one listener. Measurement at a single location is not representative of the acoustical problems in the room and will in most cases, degrade overall performance. Audyssey MultEQ is the only technology that can achieve room correction for multiple listeners in a large listening area. It does so by combining the data collected at several points in the room from each loudspeaker and then applying correction that minimizes the acoustical effects of the room and is matched to the frequency resolution of human perception (known as psychoacoustics). Furthermore, MultEQ correction is applied both in frequency and time domains and so there are no artifacts (such as smearing of sound or modal ringing) that are sometimes associated with traditional methods of room equalization.

In addition to correcting frequency response problems over a wide listening area, Audyssey MultEQ provides a completely automated sound system set-up process. It identifies how many loudspeakers are connected to the amplifiers and whether they are full-range, satellites, or subwoofers. If there is a least one subwoofer connected, Audyssey MultEQ determines the optimum crossover frequency between each satellite and the subwoofer(s). It automatically checks the polarity of each loudspeaker and alerts the user if there are any that may be wired out-of-phase relative to the others. It measures the distance to each loudspeaker from the main listening position and adjusts the delays so that sound from each loudspeaker arrives at the same time. Finally, Audyssey MultEQ determines the playback level of each loudspeaker and adjusts the volume trims so that all levels are equal.



MultEQ and the Audyssey MultEQ logo are trademarks of Audyssey Laboratories, Inc. All rights reserved.

## BEFORE USE

This section must be read before any connection is made to the mains supply.

### EQUIPMENT MAINS WORKING SETTING

Your Marantz product has been prepared to comply with the household power and safety requirements that exist in your area. SR7002/SR8002 can be powered by 120V AC only.

### COPYRIGHT

Recording and playback of any material may require consent. For further information refer to the following:

- Copyright Act 1956
- Dramatic and Musical Performers Act 1958
- Performers Protection Acts 1963 and 1972
- Any subsequent statutory enactments and orders

### DO NOT LOCATE IN THE FOLLOWING PLACES

To ensure long-lasting use, do not locate the unit where:

- Exposed to direct sunlight.
- Near to sources of heat such as heaters.
- Highly humid or poorly ventilated.
- Dusty.
- Subjected to mechanical vibrations.
- On wobbly, inclined or otherwise unstable surfaces
- Radiated heat is blocked such as in cramped audio racks.

To ensure proper heat radiation, ensure the below clearance from walls and other equipment.

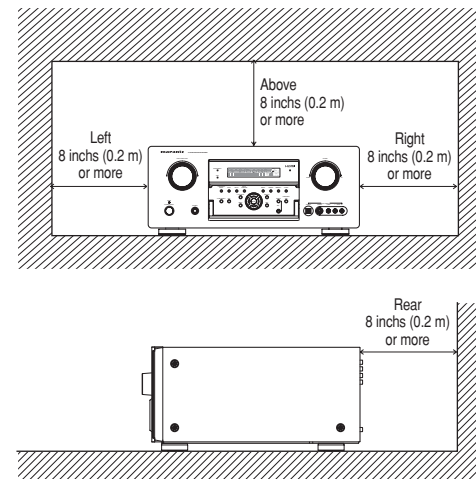

### KEEP OBJECTS OFF

Keep objects off the unit. Blocking the vent can result in accident and damage.

### DO NOT TOUCH HOT SPOTS DURING AND IMMEDIATELY AFTER USE

During and immediately after use, the unit is hot in areas other than the controls and rear panel connection jacks. Do not touch hot spots and especially the top panel. Contact with hot areas can cause burns.

#### Opening and closing the front panel door

When you want to use the controls behind the front panel door, open the door by gently pressing on the lower part of the panel. Keep the door closed when not using these controls.

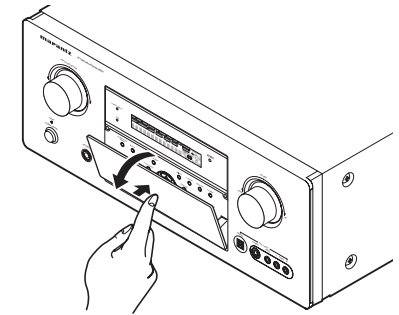

#### Caution:

- Be careful not to pinch your fingers between the door and the panel.

**OPERATION OF REMOTE CONTROLLER**

**REMOTE CONTROL**

Operate the remote controller within a distance of approx. 5m from the infrared receptor window on the front of the unit.

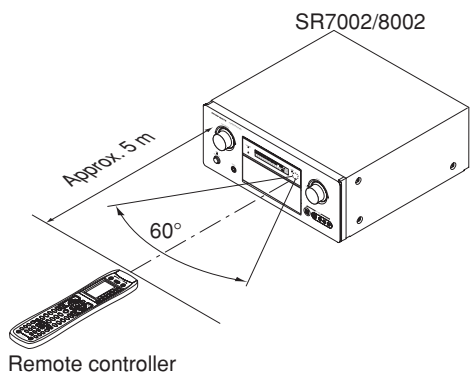

**Caution:**

- Do not allow direct sunlight, an inverter fluorescent light or other strong source of light to shine onto the player's infrared receptor window. Otherwise, the operation of the remote controller may be disabled.
- Bear in mind that operating the remote controller may cause other devices operated by infrared rays to be operated by mistake.
- The remote controller cannot be operated if the space between the controller and the player's infrared receptor window is obstructed.
- Do not place any objects on top of the remote controller. Doing so may cause one or more buttons to be held down which will cause the batteries to run down.

**LOADING BATTERIES**

Before using the remote controller for the first time, load the batteries in the remote controller. The batteries provided are used to verify the operations of the remote controller only.

**<RC8001SR>**

1. Remove the back cover.

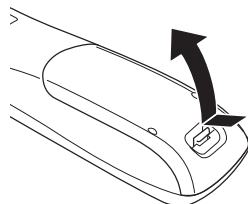

2. Insert the new batteries (AAA type) with correct ⊕ and ⊖ polarity.

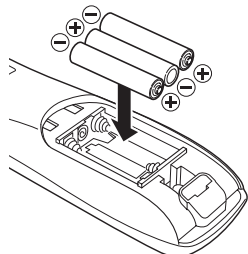

3. Close the battery cover until it clicks shut.

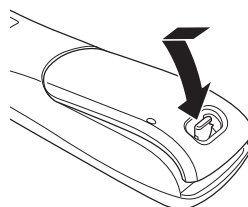

**<RC101>**

1. Remove the battery cover.

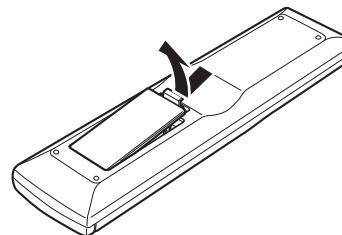

2. Insert the new batteries (AAA type) with correct ⊕ and ⊖ polarity.

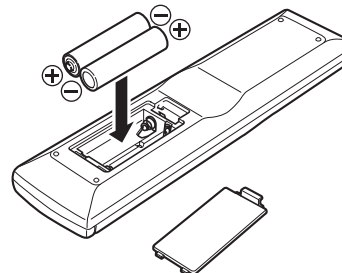

3. Close the battery cover until it clicks shut.

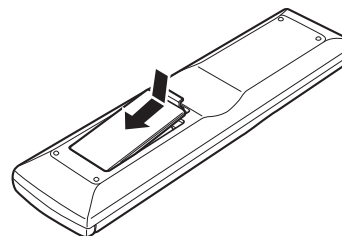

**CAUTIONS ON BATTERIES**

- Use "AAA" type batteries in this remote controller.
- We recommend that you use alkali batteries.
- The life of the batteries used with the remote controller is about 4 months with normal use.
- If the remote controller does not operate from close to the unit, replace the batteries with new ones, even if less than a year has passed.
- The included battery is only for verifying operation. Replace it with a new battery as soon as possible.
- When inserting the batteries, be careful to do so in the proper direction, following the + and - marks in the remote controller's battery compartment.
- To prevent damage or battery fluid leakage:
  - Do not use a new battery with an old one.
  - Do not use two different types of batteries.
  - Do not short-circuit, disassemble, heat or dispose of batteries in flames.
- Remove the batteries when not planning to use the remote controller for a long period of time.
- If the batteries should leak, carefully wipe off the fluid from the inside of the battery compartment, then insert new batteries.
- When disposing of used batteries, please comply with governmental regulations or environmental public instruction's rules that apply in your country or area.

**BATTERY REPLACEMENT INTERVAL (RC8001SR)**

When the batteries wear out, a battery mark is displayed on the LCD. Although the remote control can still be used when the battery mark is displayed, the batteries should be replaced as soon as possible. The LCD eventually starts to flash when buttons are pressed, the remote control will be unable to transmit signals or learn codes.

- This remote control uses non-volatile memory so that the learned codes and macro programs are retained even if the batteries are removed.
- Reset the clock after replacing the batteries.



# NAMES AND FUNCTION

## FRONT PANEL

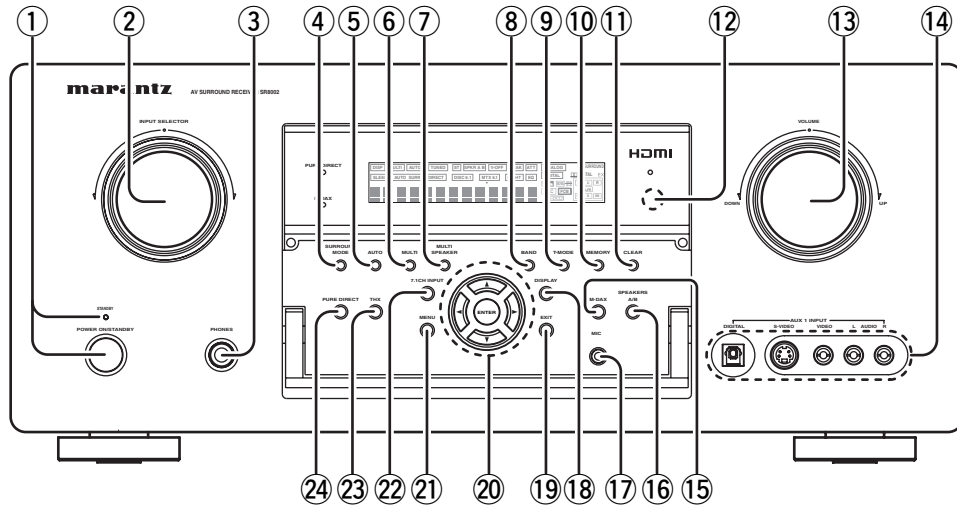

### ① POWER switch and STANDBY indicator

When this switch is pressed once, the unit turns ON and the display illuminates. When pressed again, the unit turns OFF and the STANDBY indicator will be illuminated.

### ② INPUT SELECTOR knob (AUDIO/VIDEO)

This knob is used to select the input sources. (See page 58)

### ③ HEADPHONE jack for stereo headphones

This jack may be used to listen to the unit's output through a pair of headphones. Be certain that the headphones have a standard 1/4" stereo phono plug.

### ④ SURROUND MODE button

Press this button to select the surround mode.

### ⑤ AUTO (Auto surround) button

Press this button to select the AUTO mode from the surround modes. When this mode is selected, the unit determines the surround mode corresponding to a digital input signal automatically.

### ⑥ MULTI (Multi Room) button

Press this button to activate the Multiroom system. "MULTI" indicator will be illuminated in the display. (See page 78)

### ⑦ MULTI SPEAKER button

Press this button to activate the Multiroom Speaker system. "MULTI" indicator will be illuminated in the display. (See page 78)

### ⑧ BAND button

Press this button to switch between FM, AM and XM (XM Ready) in the TUNER mode.

### ⑨ T-MODE button

Press this button to select the auto stereo mode or mono mode when the FM band is selected. The "AUTO" indicator lights in the auto stereo mode. (See page 68)

### ⑩ MEMORY button

Press this button to enter the tuner preset memory numbers or station names. (See page 68)

### ⑪ CLEAR button

Press this button to cancel the station-memory setting mode or preset scan tuning. (See page 69)

### ⑫ INFRARED receiving sensor window

This window receives infrared signals for the remote controller.

### ⑬ VOLUME control knob

This knob is used to adjust the overall sound level. Turning the control clockwise increases the sound level.

### ⑭ AUX1 INPUT jacks

These auxiliary video/audio input jacks accept the connections of a camcorder, portable DVD, game etc. When not using these jacks, protect with the included jack covers.

#### How to Attach the Front AUX Jack Cover

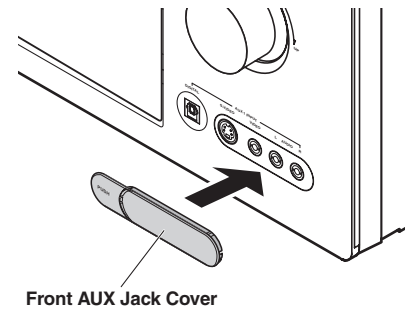

### ⑮ M-DAX button

Press this button to select M-DAX processing for input source. (See page 59)

### ⑯ SPEAKER A/B button

Press this button to select speaker systems A and/or B.

### ⑰ MIC jack

Automatically measure speaker characteristics using the included microphone. (See page 46)

### ⑱ DISPLAY button

Press this button to change the FL display mode.

### ⑲ EXIT button

Press this button to exit from the SETUP MAIN MENU.

### ⑳ Cursor (▲, ▼, ◀, ▶) / ENTER button

Press these buttons to operate the SETUP MAIN MENU and TUNER function.

### ㉑ MENU button

Press this button to enter the SETUP MAIN MENU.

### ㉒ 7.1CH INPUT button

Press this button to select the output of an external multichannel player.

### ㉓ THX button

Press this button to select THX processing for input source.

### ㉔ PURE DIRECT button and indicator

When this button is pressed once, "SOURCE DIRECT" appears on the FL display. If pressed again, "PURE DIRECT" appears. After 2 seconds, the FL display indication goes out.

In the source/pure direct mode, the tone control circuitry and bass management are bypassed.

#### Notes:

- The surround mode is automatically switched to AUTO when the pure direct function is turned on.
- Additionally, speaker configurations are fixed automatically as follows.  
Front SPKR = LARGE  
Center SPKR = LARGE  
Surround SPKR = LARGE  
Surround Back SPKR = LARGE  
Sub woofer = YES

## FL DISPLAY AND INDICATOR

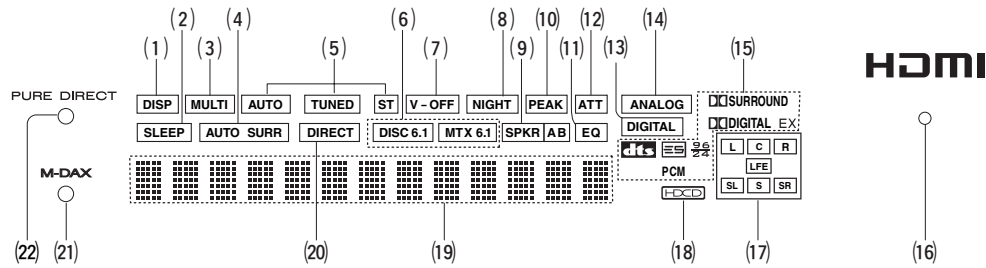

HDMI

### (1) DISP (Display Off) indicator

This indicator is illuminated when this unit is in the display off mode.

### (2) SLEEP timer indicator

This indicator is illuminated when the sleep timer function in the main-room is in use.

### (3) Multi-room system indicator

This indicator is illuminated when the multi-room system is active.

### (4) AUTO SURR (Auto Surround mode) indicator

This indicator is illuminated to show that the AUTO SURROUND mode is in use.

### (5) TUNER's indicators

**AUTO** : This indicator illuminates when the tuner's Auto mode is in use.

**TUNED** : This indicator illuminates when the tuner receives a sufficiently strong radio signal.

**ST(Stereo)** : This indicator illuminates when an FM station is being tuned into stereo condition.

### (6) DTS-ES mode indicators (DISC6.1, MTX6.1)

These indicators will illuminate to show the DTS-ES decoding mode (Discrete 6.1 or Matrix 6.1).

### (7) V (video)-OFF mode indicator

This indicator is illuminated when the Video-OFF function is active.

### (8) NIGHT mode indicator

This indicator is illuminated when this unit is in the Night mode, which reduces the dynamic range of digital program material at low volume levels.

### (9) SPKR (speaker) AB indicator

This indicator is illuminated when the speaker system is active.

### (10) PEAK indicator

This indicator is a monitor for an analog audio input signal. If the selected analog audio input signal is greater than the capable level of internal processing, this will illuminate. If this happens, you should press the **ATT** button. (See page 11)

### (11) EQ indicator

This indicator is illuminated when the EQ MODE is selected to "AUDDYSSEY", "FRONT" or "FLAT".

### (12) ATT (Attenuation) indicator

This indicator is illuminated when the attenuation function is active.

### (13) DIGITAL Input Indicator

This indicator is illuminated when a digital input has been selected.

### (14) ANALOG input indicator

This indicator is illuminated when an analog input source has been selected.

### (15) SIGNAL FORMAT indicators

**DIGITAL**

This indicator is illuminated when a Dolby Digital signal is input.

**EX**

This indicator is illuminated when a Dolby Digital EX signal is input.

**dts**

This indicator is illuminated when a DTS signal is input.

**ES**

This indicator is illuminated when a DTS ES signal is input.

### 96/24

This indicator is illuminated when a DTS 96/24 signal is input.

**PCM**

This indicator is illuminated when the input signal is PCM (pulse code modulation).

**SURROUND**

This indicator is illuminated when a Dolby Surround signal is input.

### (16) HDMI indicator

This indicator is illuminated when the HDMI device is connected to the unit.

### (17) ENCODED CHANNEL STATUS indicators

These indicators display the channels that are encoded with a digital input signal.

If the digital input signal is Dolby Digital 5.1ch or DTS 5.1ch, "L", "C", "R", "SL", "SR" and "LFE" will be illuminated.

If the digital input signal is 2 channel PCM-audio, "L" and "R" will be illuminated.

If the digital input signal is 7.1channel PCM-Audio, "L", "C", "R", "SL", "S", "SR" and "LFE" will be illuminated.

If the digital input signal is Dolby Digital 5.1ch signal with Surround EX flag or DTS-ES, "L", "C", "R", "SL", "S", "SR" and "LFE" will be illuminated.

**Note:**

When this unit is decoding a Dolby True HD signal, the status of the input signal is displayed, depending on the number of speaker channels being used.

The "S" indicator is not illuminated when a 7.1-channel signal is input to a 5.1-channel speaker system with L, C, R, SL, SR, and SW.

### (18) HDCD indicator

This indicator is illuminated when the HDCD signal is decoded from digital input signal.

### (19) Main Information Display

This display shows messages relating to the status, input source, surround mode, tuner, volume level or other aspects of unit's operation.

### (20) SOURCE DIRECT indicator

This indicator is illuminated when this unit is in the SOURCE DIRECT mode.

### (21) M-DAX indicator

This indicator illuminates when this unit is in the M-DAX mode.

### (22) PURE DIRECT indicator

This indicator is illuminated when this unit is in the PURE DIRECT mode.

## REAR PANEL

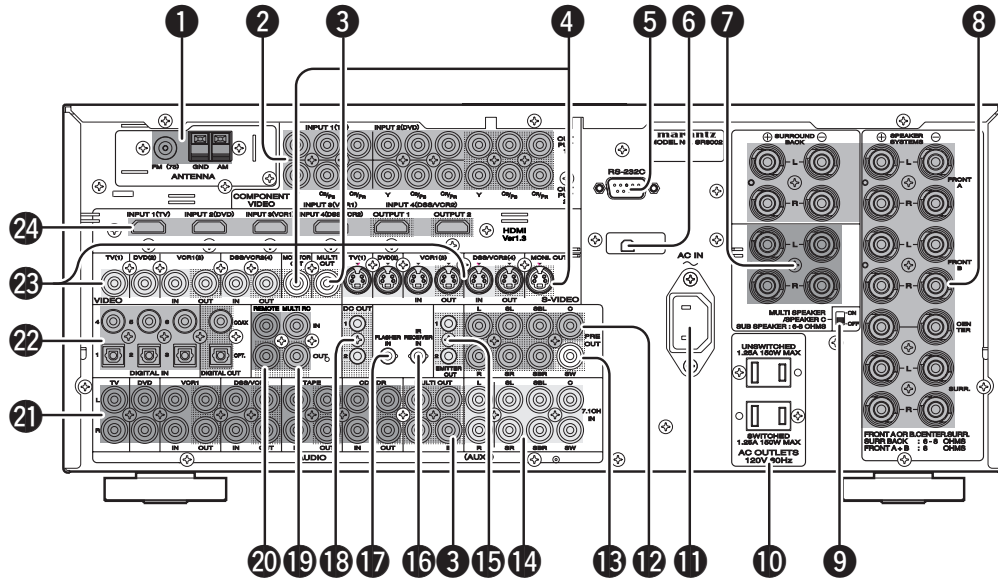
**1 FM antenna terminal (75 ohms)**

Connect an external FM antenna with a coaxial cable, or a cable network FM source.

**AM antenna and ground terminals**

Connect the supplied AM loop antenna. Use the terminals marked "AM" and "GND". The supplied AM loop antenna will provide good AM reception in most areas. Position the loop antenna until you hear the best reception.

**Note:**

- The SR8002 can receive HD Radio broadcasts. (See p.70)

**2 COMPONENT VIDEO INPUT/ OUTPUT**

If your DVD player or other device has component video connectors, be sure to connect them to these component video connectors on the unit. This unit has 4 component video input connectors to obtain the color information (Y, C<sub>B</sub>, C<sub>R</sub>) directly from the recorded DVD signal or other video component and two component video outputs connector to output it directly into the matrix decoder of the display device. By sending the pure DVD component video signal directly, the DVD signal forgoes the extra processing that normally would degrade the image. The result is vastly increased image quality, with incredibly life like colors and crisp detail.

**3 Multiroom Outputs (Audio output A/B, Video)**

These are the audio and video output jacks for the Multi zone (Multi room).

Connect these jacks to optional audio power amplifiers or video display devices to listen and view the source selected by the multiroom system in a remote room.

**Note:**

- The SR7002 does not use Multiroom audio output B.

**4 MONITOR OUT**

These are monitor outputs and each one includes both composite video and S-video configurations. When connecting two video monitors or televisions, be aware that the OSD interface can be used with both MONITOR OUT connections.

**5 RS-232C**

The RS-232C port is to be used in conjunction with an external controller to control the operation of the unit by using an external device.

The RS-232C port may also be used in the future to update the operating software of the unit so that it will be able to support new digital audio formats and the like as they are introduced.

**6 XM terminal**

See page 37 for connecting information.

**7 Sub Speaker outputs terminals (MULTI SPEAKER / SPEAKER C)**

Two terminals are provided for the front left, and right speakers for multi room.

The terminals can be used to connect a third set of speakers by setting the SPEAKER C selector switch to ON. For connection and use, see page 38.

**8 Speaker outputs terminals**

Nine terminals are provided for the front (A) left, front (A) right, front (B) left, front (B) right, front center, surround left, surround right, surround back left and surround back right speakers.

**9 SPEAKER C switch**

Set to ON to connect a bi-amp to this receiver or set to OFF for normal speaker connection (surround back and multiroom speakers). (See page 38)

**10 AC OUTLETS**

Connect the AC power cables of components such as a DVD and CD player to these outlets. SWITCHED and UNSWITCHED outlets are provided.

The one marked SWITCHED provides power only when the unit is turned on and is useful for components which you use every time you play your system.

The one marked UNSWITCHED is always live as long as the unit is plugged into a live outlet.

A component connected here may be left on permanently, or may be switched off with via its own power switch.

**Caution:**

- In order to avoid potential turn-off thumps, anything plugged into these outlets should be powered up before the unit is turned on.
- The capacity of this AC outlet is 150W. Do not connect devices that consume electricity more than the capacity of these AC outlets. If the total power consumption of the connected devices exceeds the capacity, the protection circuit shuts down the power supply.

**11 AC INLET**

Plug the supplied power cord into this AC INLET and then into the power outlet on the wall.

This unit can be powered by 120V AC only.

**12 Preamp Outputs (L, R, SL, SR, SBL, SBR, C)**

Jacks for L (front left), R (front right), C (Center), SL (surround left), SR (surround right), SBL (surround back left) and SBR (surround back right).

Use these jacks for connection to external power amplifiers.

**13 Subwoofer Output**

Connect this jack to the line level input of a powered subwoofer. If an external subwoofer amplifier is used, connect this jack to the subwoofer amplifier input.

If you are using two subwoofers, either powered or with a 2 channel subwoofer amplifier, connect a "Y" connector to the subwoofer output jack and run one cable from it to each subwoofer amplifier.

**14 7.1 CHANNEL or AUX2 INPUT**

By connecting a DVD Audio player, Super Audio CD multichannel player, or other components that has a multichannel port, you can playback the audio with 5.1 channel or 7.1 channel outputs.

**15 EMITTER OUT (SR8002 only)**

The signals input to the IR RECEIVER IN terminals are output to this terminal. External devices can be controlled by connecting them to this terminal.

**16 IR RECEIVER IN (SR8002 only)**

Connect to an external IR receiver.

**17 FLASHER IN (Flasher input terminal)**

These terminals are to control the unit from each zone. Connect the control signal from a Keypad, etc.

**18 DC TRIGGER output terminal**

Connect a device that needs to be triggered by DC under certain conditions (screen, power strip, etc...)

Use the system OSD setup menu to determine the conditions by which these jack will be active.

**Note:**

- This output voltage is for (status) control only, It is not sufficient for drive capability.

**19 MULTI ROOM REMOTE IN/OUT terminals**

IN: Connect to a multi-room remote control device, available from your Marantz dealer.

OUT: Connect to the Marantz component equipped with remote control (RC-5) terminals in Multi zone (Multi room).

**20 REMOTE CONT. IN/OUT terminals**  
Connect to a Marantz component equipped with remote control (RC-5) terminals.

**21 AUDIO IN/OUT (TV, DVD, VCR1, DSS/VCR2, TAPE, CD/CDR)**

These are the analog audio inputs and outputs. There are 6 audio inputs and 4 audio outputs. The audio jacks are nominally labeled for cassette tape decks, compact disc players, DVD players and etc.... The audio inputs and outputs require RCA-type connectors.

**22 DIGITAL INPUT (Dig.1 - 6) / OUTPUT (coaxial, optical)**

These are the digital audio inputs and outputs. There are 3 digital inputs with coaxial jacks, 3 with optical jacks.

The inputs accept digital audio signals from a compact disc, LD, DVD, or other digital source component.

For digital output, there is 1 coaxial output and 1 optical output.

The digital outputs can be connected to MD recorders, CD recorders, DAT decks, or other similar components.

**23 VIDEO IN/OUT (TV, DVD, VCR1, DSS/VCR2)**

These are the video inputs and outputs. There are 4 video inputs and 2 video outputs and each one includes both composite video and S-video configurations. Connect VCRs, DVD players, and other video components to the video inputs.

The 2 video output channels can be used to be connected to video tape recorders for making recordings.

**24 HDMI INPUT / OUTPUT**

This unit has 4 HDMI inputs and 2 HDMI output. The input function can be selected from the OSD menu system. (See page 43)

# REMOTE CONTROL OPERATION (RC8001SR)

## NAME AND FUNCTION

The provided remote controller is a universal remote controller. The **POWER** button, numeric buttons and control buttons are used in common across different input source components. The input source controlled with the remote controller changes when one of the input selector buttons is pressed.

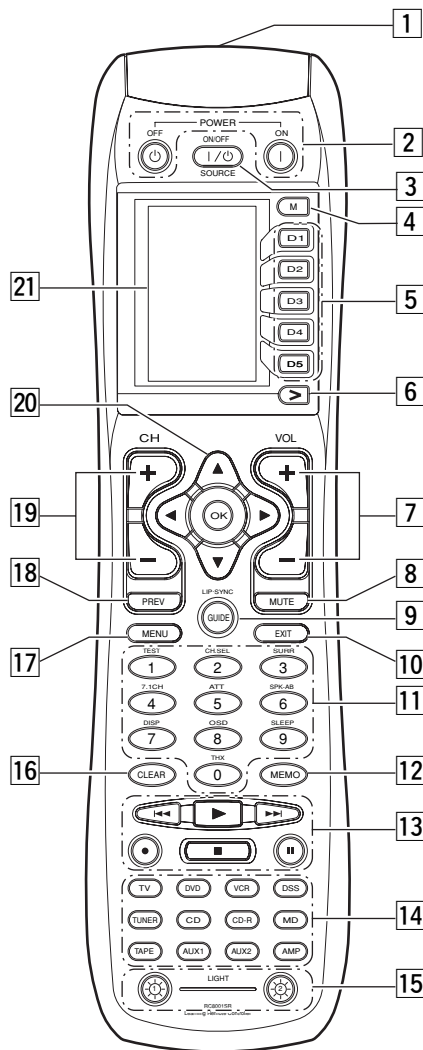

**1 Infrared Transmitter and Learning Sensor**

This transmitter emits infrared light. Press the buttons while pointing the transmitter towards the infrared receiver window of the unit or other AV equipment. Be sure to also point towards other remote controls when using the learning function.

**2 POWER ON and OFF buttons**

*(When AMP mode is selected)*

These buttons are used to turn the unit on or off.

**3 SOURCE ON/OFF button**

This button is used to turn a specific source (such as a DVD player) on or off independently from the rest of the system.

**4 M (Mode) button**

This button is used to program Macros. Pressing this button switches between Normal mode and Macro mode.

The > button is used to move to the next page. Up to 20 programs (4 pages) can be made. Holding down the **M** button for three seconds or more switches to the Setup mode, where the Setup menu is shown on the LCD. The Setup menu has four pages, and the > button is used to move to the next page. Pressing the > button from page 4 returns you to page 1.

**5 D1 to D5 (Direct) buttons**

Five types of direct operations can be performed for each of the 12 source buttons such as the DVD, television, amplifier, and other AV equipment. The pages can be switched, so 4 pages x 5 types = 20 operations can be performed for a single source. The text display can also be changed.

**6 > (Page) button**

This button is used to switch pages for the Direct button. The current page is shown on the LCD.

**7 VOL (Volume) button**

This button is used to adjust the volume for the amplifier and television.

**Note:**

- Set the AMP mode to use this button with the unit.

**8 MUTE button**

This button is used to mute the audio for the amplifier and television.

**Note:**

- Set the AMP mode to use this button with the unit.

**9 GUIDE button**

This button is used to display the menus for the DVD player, DSS (satellite broadcasting tuner), or other AV equipment.

*(when AMP mode is selected)*

This button is used to select the LIP.SYNC mode.

**10 EXIT button**

*(when AMP mode is selected)*

This button is used to cancel settings in the setup menu.

**11 Numeric buttons**

These buttons are used to switch between 0 to 9 of the source components. If the source is set to the amplifier, these buttons are used to perform operations.

*(when AMP mode is selected)*

**(1) TEST button**

This button is used to enter the test tone menu.

**(2) CH SEL. (channel select) button**

This button is used to call up SETUP MAIN MENU and adjust speaker levels or 7.1 ch input level.

**(3) SURR (surround) button**

This button is used to select the surround mode.

**(4) 7.1CH button**

This button is used to select the output of an external multi channel decoder.

**(5) ATT button**

When the input signal is too high and the voice distorts even by throttling the unit VOLUME control, turn on this function. "ATT" is indicated when this function is activated.

The input level is reduced. Attenuator is invalid for use with the output signal of "REC OUT".

**Note:**

- This function is unavailable during the digital input is selected.

**(6) SPK-AB button**

Speaker mode is switched in the following sequence.

A → B → A+B → off



**(7) DISP. button**

Selects the display mode for the front display of the unit.

**(8) OSD button**

When this button is pressed, the current setting are displayed on the TV monitor.

**(9) SLEEP (sleep timer) button**

This button is used for setting the sleep timer. Each time this button is pressed, the sleep timer is increased by 10 minutes, in a range of 10–120 minutes.

**(0) THX button**

Use this button to select the THX mode.

**12 MEMO button**

This button is used to store settings to memory or program a source.

**13 CONTROL button**

These buttons are used when operating the PLAY, STOP, PAUSE, and other commands of a source.

**Note:**

- This button is unavailable for the unit.

**14 SOURCE button**

These buttons are used to switch the source of your A/V Receiver / amplifier. Each time a source button is pressed, the remote controller changes to the source which was pressed.

This remote controller can control 12 types of equipment. To change the A/V Receiver / amplifier source, press this button twice within two seconds. The signal is sent when it is pressed the second time.

**Note:**

- Select the AMP as the source to use this remote controller with the unit.
- The MD button does not work with the unit.

**15 LIGHT 1 and 2 buttons**

Pressing these buttons will light up the LCD and its buttons. This lighting time can be set. If the lighting time is set to 0 seconds, the backlight turns on only while this button is pressed. The operations for LIGHT 1 and 2 are identical.

**16 CLEAR button**

This button is used to erase the memory or program of a source.

**17 MENU button**

*(when AMP mode is selected)*

This button is used to call up the SETUP MAIN MENU of the unit.

**18 PREV (Previous) button**

This button is used to return to the previous channel on the television or other device.

**Note:**

- This button is unavailable for the unit.

**19 CH (Channel) button**

This is used to change channels.

**20 CURSOR buttons**

These buttons are used when controlling the cursor of the unit, DVD, or other AV equipment.

**21 LCD**

Information about the sources and modes are shown on the LCD.

**LCD INDICATORS (RC8001SR)**

Information about currently selected source and direct code names are displayed on the LCD.

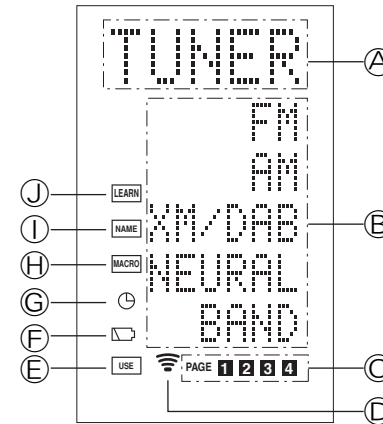
**A Source Name indicator**

This displays the name of the selected source, such as DVD, television, or other AV equipment (up to five characters).

**B Direct Button Name indicator**

This displays up to 20 types of button names for each source. (up to six characters)

**C Page indicator**

This displays the current page position.

**D Transmission indicator**

This indicator is displayed when the remote controller is sending a signal.

**E USE indicator**

This indicator is displayed under normal operation.

**F Battery Level indicator**

This indicator is displayed when the battery level is low.

**G TIMER indicator**

This indicator is displayed when the macro timer is set.

**H MACRO indicator**

This indicator is displayed when the remote controller is in macro programming mode.

**I NAME indicator**

This indicator is displayed when the remote controller is in renaming mode.

**J LEARN indicator**

This indicator is displayed when the remote controller is in learning mode.

**SETTING THE TIME**

Example: Setting to 6:20PM (18:20)

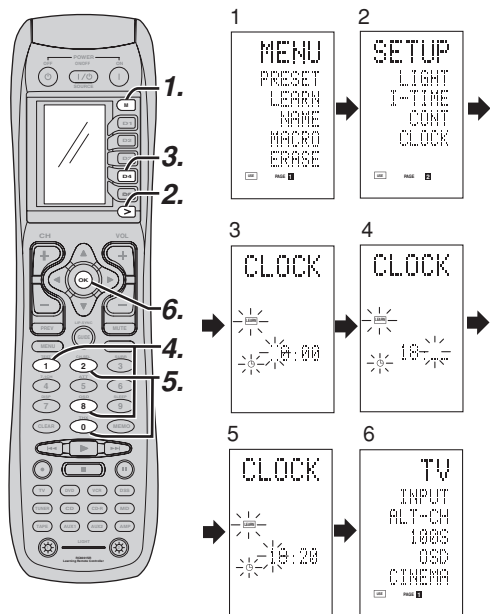

When you bought this remote controller and insert the batteries to the remote controller at first, the steps 1 to 3 are skipped. Starts from step 4 to set the time.

1. Hold down the **M** button for three seconds or more.  
The menu is displayed.
2. Press the **>** button once.  
This displays second page (SETUP).
3. Press the **D4 (CLOCK)** direct button.  
The ":" indicator blinks and the clock indicator displays "0:00".
4. Press the **1** and **8** numeric button to set the hour indicator.  
The hour indicator displays "18".  
The minute indicator blinks "\_".
5. Press the **2** and **0** numeric button to set the minute indicator.  
The minute indicator displays "20".  
The hour indicator blinks.
6. Press the **OK** cursor button to start the clock.  
The clock starts from 0 second at the time that was set and return to normal (USE) mode.

Whenever the batteries are replaced, the clock shows 00:00. Please reset the clock. (The time setting is not backed up.)

**CHECKING THE TIME**

To check the time, hold down the **>** button for three seconds or more. The current time is displayed for five seconds.

**Note:**

- Although the remote controller uses a quartz clock, the time may become out of sync over the course of operation. Be sure to correct the clock from time to time.

**GENERAL INFORMATION OF RC8001SR TO THE UNIT**

To control the unit by your RC8001SR, you have to select the device AMP or TUNER by pressing the function selector button. Please refer below for the details in AMP and TUNER mode.

**AMP MODE**

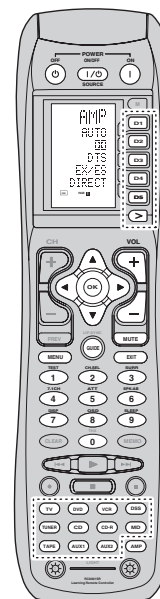

SOURCE ON/OFF	Turns the SR7002/SR8002 on and off
POWER ON	Turns the SR7002/SR8002 on
POWER OFF	Turns the SR7002/SR8002 off
D1 - D5 / >(Page)	(Refer to page vi)
VOL +/-	Adjust the over all sound level
MUTE	Decreases the sound temporarily
Cursor	Move the cursor for setting in SETUP MENU mode
OK	Enter the SETUP MENU Confirms the setting in SETUP MENU mode
MENU	Enter the SETUP MENU
EXIT	Exits from SETUP MENU
TEST (1)	Enter the test tone menu
CH.SEL (2)	Call up SETUP MENU and adjusts speaker levels or 7.1ch input setup
SURR (3)	Selects the surround mode
7.1CH (4)	Selects the 7.1CH IN
ATT (5)	Reduces the input level
SPK-AB (6)	Selects the speaker system
DISP (7)	Changes the front display mode
OSD (8)	Displays the current setting on the monitor
SLEEP (9)	Sets the sleep timer function
THX (0)	Selects the THX mode
Function selector	Selects a particular source component
GUIDE / LIP.SYNC	Selects the LIP.SYNC mode

**TUNER MODE**

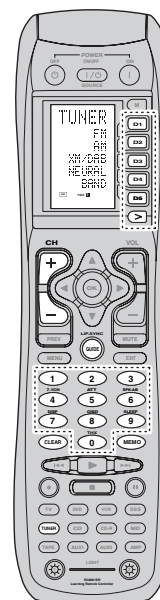

D1 - D5 / >(Page)	(Refer to page vi)
CH +/-	Selects a preset station up and down
GUIDE	Selects the "Frequency direct input"
0-9	Input the numeric
MEMO	Enter the tuner preset memory numbers
CLEAR	Clears the inputting
TUNER	Selects a frequency band



CONTROLLING MARANTZ COMPONENTS

1. Press the desired function button.
  - The selected function name and USE are displayed in the LCD.
2. Press the desired operation buttons to play the selected component.
  - For details, refer to the component's user guide.
  - It may not be possible to operate some models.

CONTROLLING A MARANTZ DVD PLAYER (DVD MODE)

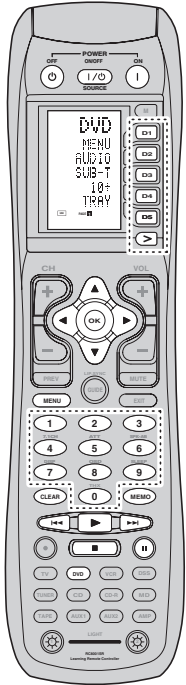

SOURCE ON/OFF	Turns the DVD player on and off
POWER ON	Turns the DVD player on
POWER OFF	Turns the DVD player off
D1 - D5 / >(Page)	(Refer to page vi)
Cursor/OK	Move the cursor, enters the setting
MENU	Calls up the menu of DVD disc
0-9	Input the numeric
MEMO	Call up the programming menu
CLEAR	Clears the inputting
▶	Play
⏮ / ⏭	Skip forward or previous chapter/ track
■	Stop
⏸	Pause

CONTROLLING A MARANTZ CD PLAYER (CD MODE)

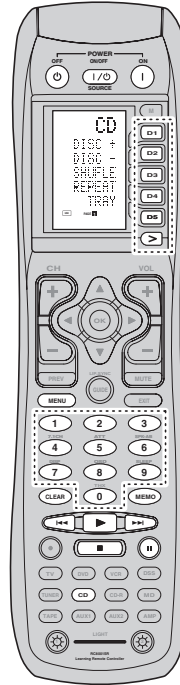

SOURCE ON/OFF	Turns the CD player on and off
POWER ON	Turns the CD player on
POWER OFF	Turns the CD player off
D1 - D5 / >(Page)	(Refer to page vi)
MENU	Switches the display information
0-9	Input the numeric
MEMO	Programs
CLEAR	Clears the inputting
▶	Play
⏮ / ⏭	Skip forward or previous track
■	Stop
⏸	Pause

**CONTROLLING A MARANTZ VCR (VCR MODE)**

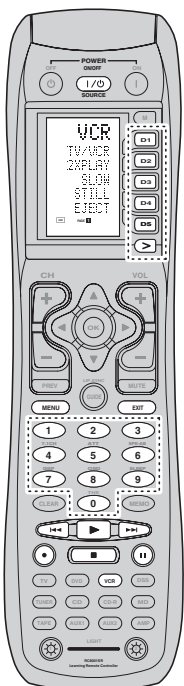

SOURCE ON/OFF	Turns the VCR on and off
D1 - D5 / >(Page)	(Refer to page vi)
MENU	Call up the menu
EXIT	Exits the programming menu
0-9	Input the numeric
▶	Play
⏮ / ⏭	Skip forward or previous track
■	Stop
⏸	Pause
●	Record

**CONTROLLING A MARANTZ CD RECORDER (CDR MODE)**

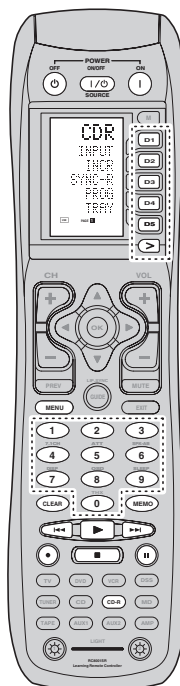

SOURCE ON/OFF	Turns the CD recorder on and off
POWER ON	Turns the CD recorder on
POWER OFF	Turns the CD recorder off
D1 - D5 / >(Page)	(Refer to page vi)
MENU	Switches the display information
0-9	Input the numeric
MEMO	Programs
CLEAR	Clears the inputting
▶	Play
⏮ / ⏭	Skip forward or previous track
■	Stop
⏸	Pause
●	Record

**CONTROLLING A MARANTZ MD DECK (MD MODE)**

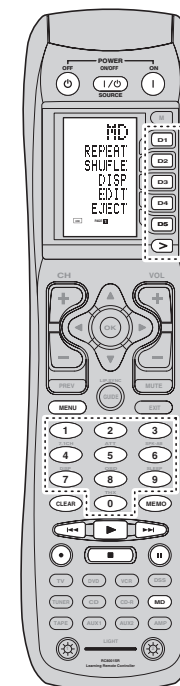

SOURCE ON/OFF	Turns the MD deck on and off
POWER ON	Turns the MD deck on
POWER OFF	Turns the MD deck off
D1 - D5 / >(Page)	(Refer to page vi)
MENU	Switches the display information
0-9	Input the numeric
MEMO	Programs
CLEAR	Clears the inputting
▶	Play
⏮ / ⏭	Skip forward or previous track
■	Stop
⏸	Pause
●	Record

**CONTROLLING A MARANTZ TAPE DECK (TAPE MODE)**

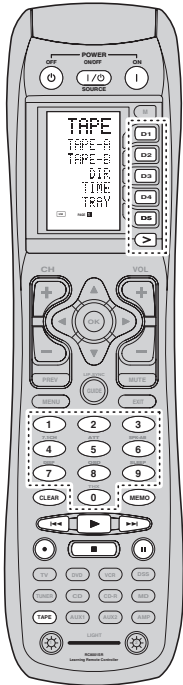

SOURCE ON/OFF	Turns the TAPE deck on and off
POWER ON	Turns the TAPE deck on
POWER OFF	Turns the TAPE deck off
D1 - D5 / >(Page)	(Refer to page vi)
0-9	Input the numeric
MEMO	Programs
CLEAR	Clears the inputting
▶	Play
◀◀ / ▶▶	Skip forward or previous track
■	Stop
	Pause
●	Record

**CONTROLLING A MARANTZ UNIVERSAL DOCK (AUX1 MODE)**

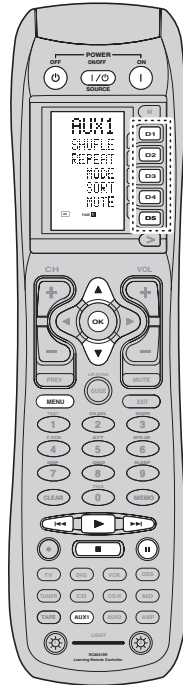

SOURCE ON/OFF	Turns the UNIVERSAL DOCK (Dock connector) ON and OFF
POWER ON	Turns the UNIVERSAL DOCK (Dock connector) ON
POWER OFF	Turns the UNIVERSAL DOCK (Dock connector) OFF
D1 - D5 / >(Page)	(Refer to page vi)
MENU	Call up the menu
Cursor Up	Select contents Up
Cursor Down	Select contents Down
OK	Enter the setting
▶	Play / Pause
◀◀ / ▶▶	Next track / previous track
■	Stop
	Pause

## BASIC OPERATION

### USE MODE

#### (Normal operation status)

This remote controller is preset with a total of 12 types of remote codes, including Marantz TV (television), DVD, VCR (VCR deck), DSS (satellite broadcasting tuner), TUNER, CD/CD-R, MD, TAPE (tape deck), AUX1, AUX2, and AMP (amplifier). Learning is not necessary for Marantz products. You can use these products without setting any codes.

1. Press the **SOURCE** button.  
For this example, press DVD.  
DVD is shown on the LCD, and the remote controller is set for DVD.  
Pressing the **SOURCE** button once changes the remote control to the settings for the source that was pressed.  
To change the amplifier or other source, press the **SOURCE** button twice (double-click). The code is sent, and then the amplifier source changes to DVD.
2. Press the buttons to operate the DVD.  
The  indicator is shown on the LCD while the remote control codes are being transmitted. It is not displayed when buttons without stored code are pressed.
3. The direct buttons can be used to perform up to 20 operations for each of the 12 sources, including DVD, TV, AMP, and other AV equipment.  
The buttons consist of the D1 to D5 buttons, and the equipment is operated by pressing the buttons corresponding to the indicators on the LCD.  
Four pages are available, and press the > button to select a page. The current page position is displayed on the LCD.

### PRESET MODE

#### (When operating non-Marantz AV equipment products)

This remote controller is preset with remote control codes from AV equipment by other manufacturers. The preset codes are TV, VCR, LD, CABLE, DSS, DVD, TAPE, TUNER, CD/CD-R, MD and AMP. Settings can be made in one of two ways.  
When the preset codes are set, the following codes are contained in the **SOURCE** button of the remote controller.

See the attached manufacturer number list for the preset manufacturers, devices, preset numbers, and other settings.

Remote control source name	Corresponding preset code	Device name
TV	TV	Television
DVD	DVD	DVD player
VCR	VCR	Video deck
DSS	SATELLITE	Satellite broadcasting tuner equipment
TUNER	RECEIVER/TUNER	AM FM TUNER
CD	CD/CD-R PLAYER	CD player
CD-R	CD/CD-R PLAYER	CD recorder
MD	CD/CD-R PLAYER	MD deck
TAPE	TAPE	Cassette deck
AUX1	CABLE	Cable television
AUX2	LASER DISC	Laser disc player
AMP	AMPLIFIER	Amplifier or receiver
	RECEIVER/TUNER	

- When using Marantz products, TV and DVD can be set to TV1 (TV/VDP: Projector) and TV2 (PDP: Plasma display), and DVD1 (first DVD player) and DVD2 (second DVD player), respectively, to match the customer's operating environment. These settings are made in PRESET mode.

In the factory default state, the remote controller is set to TV1 and DVD1. To make the presets, enter the numbers below while referring to the section "Entering and Setting the Manufacturer Number Directly".

TV1: 0001, TV2: 0002  
DVD1: 0001, DVD2: 0002

#### Entering and Setting the Manufacturer Number Directly

Refer to the manufacturer number list.  
This example shows how to set a SAMSUNG DVD player.

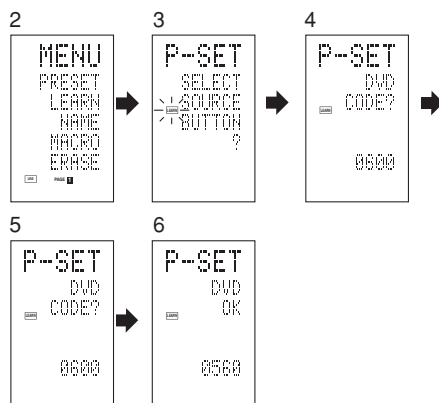

1. View the supplied manufacturer number list, and find the number of the manufacturer for the device that you are using.
2. Hold down the **M** button for three seconds or more.  
The menu is displayed.
3. Press the **D1** (PRESET) direct button.  
The Preset setting (P-SET) is displayed.
4. Press the **DVD** source button.
5. Press the numeric buttons to enter the four-digit manufacturer number.  
Example: To enter "0600" from the manufacturer number list.  
To correct the entered number, use the ◀ or ▶ cursor button to enter the correct number.
  - If no button is pressed for over one minute during the setting process, any settings that were made are cancelled.
6. Press the **OK** cursor button.
7. Confirm the OK is displayed and then the display returns to the Preset Setting (P-SET).  
When the manufacturer number is entered correctly, OK is displayed momentarily on the screen.
  - If you enter a number not in the manufacturer number list, WRONG CODE is displayed, and then you return to the preset setting again
8. To set the manufacturer number for another source device, repeat the procedure in steps 4 to 6.
9. After the settings are completed, press the **M** button.
10. Press the buttons on the remote controller to check that the DVD can be operated correctly.

#### Setting Equipment Not Appearing in Manufacturer Number List

Use the sequence function to set equipment not appearing in the manufacturer number list. You may still be unable to set some equipment even when using the sequence function. In this case, the remote controller can be programmed with codes individually. In the sequence function, the power ON/OFF codes are transmitted by pressing the remote controller buttons in order.

If the power for the equipment is left on, hold down the button until the equipment is turned off, and then release. This completes the setting.

This example shows how to set a DVD player.

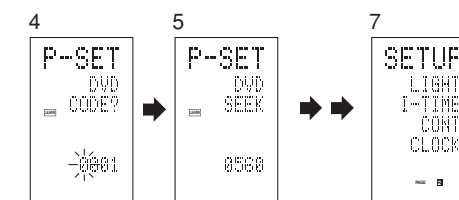

1. Turn on the power of the DVD player.
2. Hold down the **M** button for three seconds or more.  
The menu is displayed.
3. Press the **D1** (PRESET) direct button.  
The Preset setting (P-SET) is displayed.
4. Press the **DVD** source button.
5. Hold down the **CH+** or **CH-** button for one second or more.
6. Press the **CH+** button repeatedly in the interval for one second.  
The signal is transmitted, and the display cycles through the code number.  
Press the **CH-** button to go back to a number screen.
7. Release the button once the DVD player turns off.
8. Press the **OK** cursor button.
9. Confirm the OK is displayed and then the display returns to the Preset Setting (P-SET).
10. To set the manufacturer number for another source device, repeat the procedure in steps 4 to 8.
11. After the settings are completed, press the **M** button.
12. Press the buttons on the remote controller to check that the DVD can be operated correctly.

Check the following points if the equipment which was set does not operate properly.

- If there is more than one number in the manufacturer number list, try setting a different number.
- There may be some buttons which cannot be used. Program the codes to the required buttons.

**LEARN MODE****Programming the ► (PLAY) and Other Control Buttons and Numeric Buttons**

This remote controller is capable of learning and storing codes used by other remote controllers that you already own.

For codes which are not learned, the remote controller will transmit either the Marantz preset codes from the initial settings, or remote codes from another manufacturer's AV equipment which is set by the customer.

The receiver sensor for the remote control signals is located at the top of the remote controller.

This example shows how to learn the codes from the remote control of a DVD player.

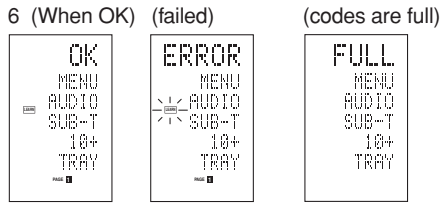
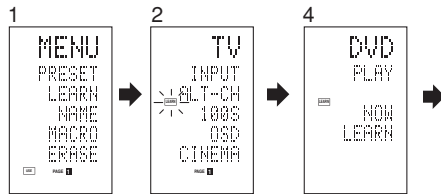

1. Hold down the **M** button for three seconds or more. The menu is displayed.
2. Press the **D2** (LEARN) direct button. The LEARN setting (LEARN) is displayed. The **LEARN** indicator then blinks.
3. Press the **DVD** source button.
4. Press the ► (PLAY) button. The **LEARN** indicator blinks, and then displays to indicate that learning is ready.
5. Place the receiver sensor of the remote control (top) so that it is facing the transmitter of the DVD remote control (top) at a distance of about 5 cm (2 inches).

6. Press and hold down the ► (PLAY) button of the transmitting DVD remote control, and check that OK is displayed on the LCD. The remote controller has finished learning when OK is displayed on the LCD.

If ERROR is displayed on the LCD, some error has prevented the command from being learned. If this happens, repeat the procedure for steps 4 and 5.

In some rare cases, ERROR may be displayed repeatedly during the learning operation. In this case, the transmitting remote control may have special signal codes. These codes cannot be learned by this remote controller.

7. Follow the same procedure to make the remote control learn the other buttons.
8. Repeat the procedure in steps 3 to 6 to have the remote control learn the signal codes from a TV, CD player, or other AV equipment.
  - When no buttons are pressed for approximately one minute during the learning operation, the remote controller automatically returns to USE mode.
  - When programming the source buttons, switch to the source in step 3, and then press the source button again.

9. When you have finished programming the codes for each button, press the **M** button. The **USE** indicator is displayed on the LCD, and the newly stored codes can be used.

- If FULL is displayed on the LCD, the memory cannot hold any more learned codes in LEARN mode.

If FULL is displayed no matter how many times you try the learning operation, the remote controller cannot accept any more new codes until some of the previously learned codes are deleted from the memory. Delete some of the learned buttons from the sources.

The **M** button and > button cannot be taught. Only each one code can be learned for the **LIGHT** buttons 1 and 2, regardless of the source.

**Programming the Direct Buttons and Rewriting Names**

This example shows how to program codes from other manufacturer products to the DVD MENU button (D1) and change the display to OSD.

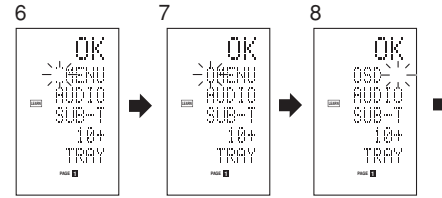

1. Hold down the **M** button for three seconds or more. The menu is displayed.
2. Press the **D2** (LEARN) direct button. The LEARN setting (LEARN) indicator is displayed. The **LEARN** indicator then blinks.
3. Press the **DVD** source button. The first page of the direct button screen is displayed. There are four available pages. Pressing the > buttons cycles through the pages in this order 1 → 2 → 3 → 4 → 1.
4. Press the **D1** (MENU) direct button. The **LEARN** indicator blinks, and then displays to indicate that learning is ready.
5. Place the receiver sensor of the remote control (top) so that it is facing the transmitter of the DVD remote control (top) at a distance of about 5 cm (2 inches).
6. Press and hold down the **OSD** button of the transmitting DVD remote control, and check that OK is displayed on the LCD. The remote controller has finished learning when OK is displayed on the LCD. If ERROR is displayed on the LCD, some error has prevented the command from being learned. If this happens, repeat the procedure for steps 4 and 5.
  - After learning is completed, the remote controller automatically switches to name rewriting mode. The left end “:” indicator on the MENU blinks to indicate that the blinking part can be rewritten.
  - If no names will be rewritten, press the **OK** cursor button. The display returns to learning standby mode by pressing the **OK** cursor button.

7. To change the name, press the numeric buttons to enter the text.

- Use the cursor buttons ◀ ▶ to move to the sections to be rewritten on the LCD.
- To change MENU to OSD, press the 5 numeric button.

Each time the button is pressed, the display cycles through M → N → O → 5 → M.

8. After rewriting of the text is completed, press the **OK** cursor button. To delete text that is already entered, press the **O** button to insert a space.
  - In this example, MENU is changed to “OSD (space) (space)” in this step, and then OSD is displayed in the right side by pressing the **OK** button.

For details, refer to the section “Rewriting Names”.

9. In the same way, use the > button to select the page, and then press the direct button to program the codes.

10. After programming the codes for each of the buttons, press the **M** button. The **USE** indicator displays on the LCD, and the newly stored codes can be transmitted.

**REWRITING NAMES**

This remote controller allows the rewriting of names for the sources and direct buttons. This operation is performed for each individual source.

This example shows how to change the source name from DVD to AVD and AUDIO to SOUND.

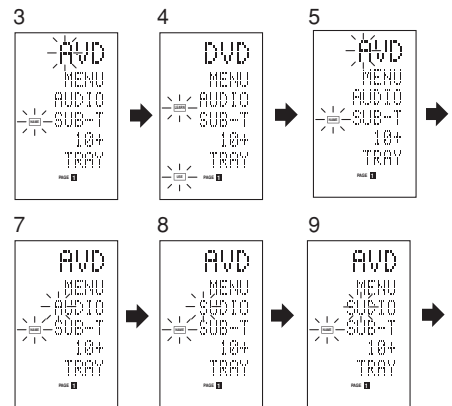

1. Hold down the **M** button for three seconds or more. The menu is displayed.
2. Press the **D3** (NAME) direct button.

3. Press the **DVD** source button .  
The **[NAME]** indicator blinks.  
The ":" blinks to indicate that the letter can be changed.
4. Press the **DVD** cursor button twice.  
The D in DVD blinks to indicate that the letter can be changed.
5. Press the **1** numeric button to select **A**.  
Each time the numeric buttons are pressed, the button cycles through the alphanumeric characters shown below.  
1: A → B → C → 1 → A  
2: D → E → F → 2 → D  
3: G → H → I → 3 → G  
4: J → K → L → 4 → J  
5: M → N → O → 5 → M  
6: P → Q → R → 6 → P  
7: S → T → U → 7 → S  
8: V → W → X → 8 → V  
9: Y → Z → / → 9 → Y  
0: SPACE (:) → + → - → , → ' → < → > → ? → 0 → SPACE (:)
  6. Press the **◀** or **▶** cursor button .  
The letter is changed to "A".
    - The **▲** and **▼** cursor buttons can be used to move the blinking indicator of the section to be rewritten.
  7. Press the **▲** or **▼** cursor buttons to select **AUDIO** on the direct button indicator. The A flashes to indicate that the name can be changed.
  8. Press the **7** numeric button to select **S**.  
Each time the button is pressed, the button cycles through S → T → U → 7 → S.
  9. Press the **▶** cursor button to move the flashing section.
  10. Press the **5** numeric button to select **0**.
  11. Follow the same procedure to enter U, N, and D.
  12. When finished entering the text, press the **OK** cursor button .
  13. Press the **M** button .  
The **[USE]** indicator displays on the LCD, and the newly stored codes can be used.  
The input is overwritten, and so the currently displayed text is erased.  
Up to six characters can be entered for the direct button indicator.

### ERASING PROGRAMMED CODES (RETURNING TO INITIAL SETTINGS)

Codes can be erased in five ways: by buttons, direct buttons, direct button pages, sources, and by all memory contents.

#### Erasing Buttons and Erasing Direct Buttons

This example shows how to erase the code learned from the **PLAY** button of the DVD player and the **AUTO** code of the AMP direct button.

##### Erasing buttons

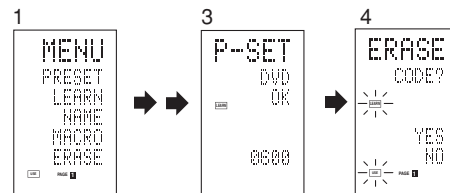

1. Hold down the **M** button for three seconds or more.  
The menu is displayed.
  2. Press the **D5 (ERASE)** direct button .
  3. Press the **DVD** source button .  
The **[USE]** and **[LEARN]** indicators blink.
  4. Press the button **▶** (PLAY) that you want to erase while holding down the **CLEAR** button .  
A message is displayed on the LCD.
  5. Press the **D4 (YES)** direct button to erase.  
The code programmed to the **▶** (PLAY) button is erased.  
When the code is cleared, the code for this button resets to the factory default code or becomes blank.
    - To cancel the erasing operation, press the **D5 (NO)** button to return to the previous display.
- To erase codes programmed for the **CLEAR** button, simply press the **CLEAR** button twice.
- To erase codes programmed for the **SOURCE** button, simply press the **SOURCE** button twice.

##### Erasing direct buttons

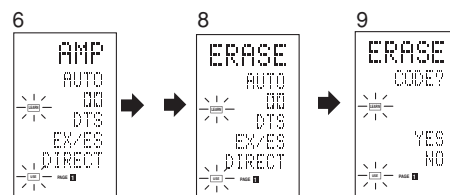

6. Press the **AMP** source button .
7. Press the **>** button to display the first page for AMP.
8. Press the **D1 (AUTO)** direct button to be erased while holding down the **CLEAR** button .
9. Press the **D4 (YES)** direct button to erase.  
The code programmed to the **AUTO** button is erased.  
When the code is cleared, the code for this button resets to the factory default code or becomes blank.  
The rewritten name returns to the original name.
  - To cancel the erasing operation, press the **D5 (NO)** button to return to the previous screen.
10. When the erasing operation is finished, press the **M** button .  
The **[USE]** indicator displays to indicate that the remote controller can now be operated.

#### Erasing Direct Button Pages

This example shows how to erase the entire direct button second page learned from the DVD player.

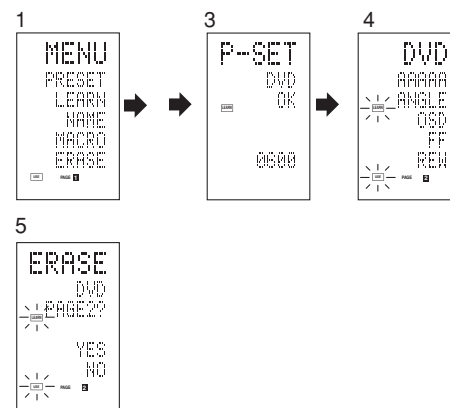

1. Hold down the **M** button for three seconds or more.  
The menu is displayed.
2. Press the **D5 (ERASE)** direct button .
3. Press the **DVD** source button .  
The **[USE]** and **[LEARN]** indicators blink.
4. Press the **>** button to display the second page.
5. Press the **>** button while holding down the **CLEAR** button .

6. Press the **D4 (YES)** direct button to erase.  
All codes and names programmed to page 2 are erased. When the codes are cleared, the codes for this button reset to the factory default code or become blank. Any rewritten names return to the original name.
  - To cancel the erasing operation, press the **D5 (NO)** button to return to the previous screen.
7. When the erasing operation is finished, press the **M** button .  
The **[USE]** indicator lights up to indicate that the remote controller can now be operated.

#### Erasing Sources

This procedure clears all codes and names programmed to the DVD, TV, or other sources. All codes and names in the four direct button pages are also erased.

This example shows how to erase the names and codes learned from the DVD player.

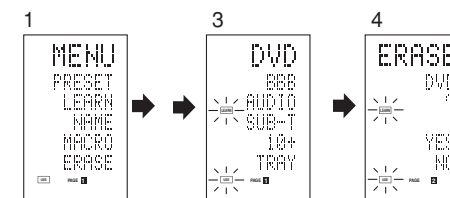

1. Hold down the **M** button for three seconds or more.  
The menu is displayed.
2. Press the **D5 (ERASE)** direct button .
3. Press the **DVD** source button .  
The **[USE]** and **[LEARN]** indicators blink.
4. Press the **DVD** source button while holding down the **CLEAR** button .
5. Press the **D4 (YES)** direct button to erase.  
All codes and names programmed to the DVD source are erased. When the codes are cleared, the codes for this button reset to the factory default code or become blank. Any rewritten names return to the original name.
  - To cancel the erasing operation, press the **D5 (NO)** button to return to the previous display.
6. When the erasing operation is finished, press the **M** button .  
The **[USE]** indicator displays to indicate that the remote controller can now be operated.



## Erasing All

This procedure clears (resets) all programmed codes and names. Once all the data is cleared, the memory is returned to the factory default status. The programmed macros are also erased.

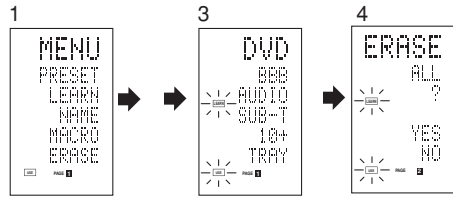

1. Hold down the **M** button for three seconds or more. The menu is displayed.
2. Press the **D5** (ERASE) direct button. The **USE** and **LEARN** indicators blink.
3. Press the **CLEAR** button while holding down the **POWER ON** and **OFF** buttons at the same time.
4. Press the **D4** (YES) direct button to erase. All programmed codes and names are erased and reset to the factory default settings.
  - To cancel the erasing operation, press the **D5** (NO) button to return to the previous screen.
  - To erase all operation takes a few seconds after the **D4** (YES) button is pressed.

## PROGRAMMING MACROS

This remote controller can program a series of button operations in sequence.

Macros are a function that makes it possible to use a single button operation to perform a complex series of button operations any number of times. A single button can be programmed to perform up to 20 steps in sequence. A total of 20 buttons can be programmed with macros.

- For example, the following sequence of operations can be programmed to a macro.
 

Switch amplifier to DVD source → Set amplifier mode to AUTO → Play DVD player → Switch TV to video input

The factory default for the transmission interval (time) between macro operations is one second, but these signal transmission intervals can be set between approximately 0.5 seconds and 5 seconds in the Setup mode. Each transmission interval can be adjusted independently when programming or revising a macro.

### Note:

- If the signal transmission interval (interval time) is changed using the Setup mode (described later), this transmission interval is applied to all macro programs. To change individual signal transmission intervals, use the procedures in this section for programming macros and revising macros.
- No signals are transmitted while programming a macro.
- The **M** button, **>** button, cursor buttons, **MEMO** button, **CLEAR** button, and **VOL** buttons cannot be programmed.
- If no button is pressed for approximately one minute during programming, the remote controller returns to the state before macro mode. In this case, the macro program is not stored.
- When executing macro mode, performing the source switching operation two or more times only changes the remote control mode and does not transmit any signals. (Switching of the source selector of the amplifier is valid only once.)

## PROGRAMMING MACROS

This example shows how to program a macro to the **M-01** button.

(The screens shown in the example are the default factory states. If the names of direct buttons were rewritten, these modified names would be displayed.)

Switch amplifier to DVD source → Play DVD player → Set the interval to 2 seconds until the next signal is sent → Switch TV to video input → Set the amplifier mode to AUTO

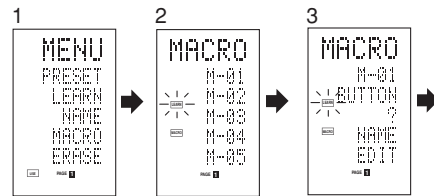

1. Hold down the **M** button for three seconds or more. The menu is displayed.
2. Press the **D4** (MACRO) direct button. The macro menu is displayed. The **MACRO** indicator displays and **LEARN** blinks.
3. Press the **D1** (M-01) direct button. The menu has four pages, and so use the **>** button to select the page when programming other buttons.

4. Press the buttons in the sequence that you want the operations performed. The actual program starts here. Each time a button is pressed, the name of the button is displayed on the LCD.

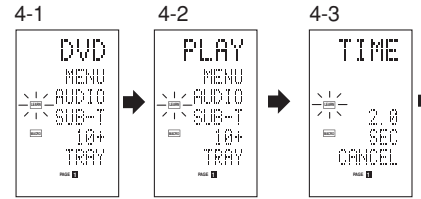

- 4.1. Press the **DVD** source button.
- 4.2. Press the **▶** (PLAY) button.
- 4.3. Press the **▲** or **▼** cursor buttons. The interval time is displayed on the LCD.
- 4.4. Press the **▲** or **▼** cursor buttons and set to 2.0 (seconds).
  - Use the **▲** cursor button to increase the time and the **▼** button to decrease the time. The interval time can be set from 0.5 seconds to 5 seconds.
  - To stop the time adjustment, press the **D5** (CANCEL) direct button.
- 4.5. Press the **OK** cursor button.
- 4.6. Press the **TV** source button.
- 4.7. Press the **>** button to display the first page.
- 4.8. Press the **D1** (INPUT) direct button.
- 4.9. Press the **AMP** source button.
- 4.10. Press the **>** button to display the first page.
- 4.11. Press the **D1** (AUTO) direct button.
- 4.12. Press the **OK** cursor button. The LCD displays END to indicate that programming is completed.
5. To program another macro, repeat the procedure in steps 3 to 4-12.
6. To exit macro programming, press the **M** button.

The **USE** indicator displays to indicate that the remote controller can now be operated. When the macro are programmed 20 operations or more, the display returns macro menu. Edit the macro so that it has 20 operations or less.

## EXECUTING MACRO PROGRAMS

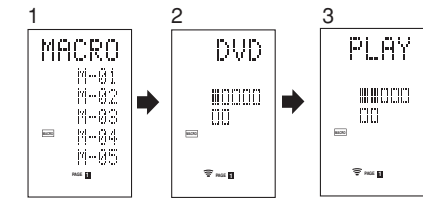

1. Press the **M** button shortly. The macro menu is displayed.
2. Press the **D1** (M-01) direct button.
3. Check that the operations of the program are executed step by step. The name of the operation button is displayed on the LCD.
  - The programmed section is indicated by . The bar indicator moves to indicate the progress of the program.
 

Select DVD source → PLAY transmit → Interval time: 2 seconds → Select TV → TV INPUT transmit → Select AMP → AUTO transmit → End
  - To cancel transmission of the program while it is in progress, press any button.

## CHANGING NAMES OF MACRO PROGRAMS

Under the factory default settings, the names of the macro programs are set from M-01 to M-20, but you can change them to any desired name. The text can have up to six characters, and it is entered using the numeric buttons. This example shows how to change the M-01 name to MOVIE.

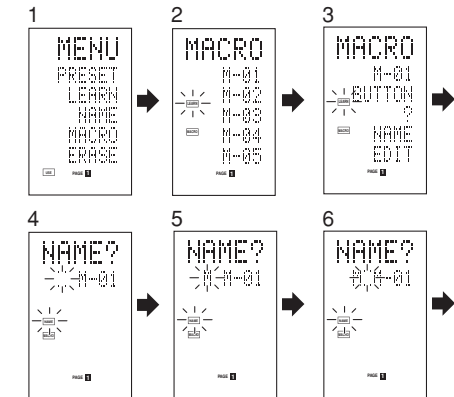

1. Hold down the **M** button for three seconds or more. The menu is displayed.

2. Press the **D4** (MACRO) direct button. The macro menu is displayed. The **MACRO** indicator displays and **LEARN** blinks.
3. Press the **D1** (M-01) direct button. The NAME is displayed.
4. Press the **D3** (NAME) direct button. The "..." blinks to indicate that rewriting is possible.
5. Press the **5** numeric button to select M.
6. Press the **▶** cursor button to next. The "..." blinks to indicate that rewriting is possible.
7. Press the **5** numeric button to select O.
8. Repeat steps 6 and 7, and then enter V, I, E and "... (space)".
  - To make changes in the text while entering it, use the **◀** or **▶** cursor buttons to move to the blinking section.
9. After making the changes, press the **OK** cursor button.
  - To change the names of other macro programs, repeat the procedure in steps 3 to 9.
10. To exit, press the **M** button.

### ERASING STEPS OF MACRO PROGRAMS

This example shows how to delete the TV and INPUT steps from the following macro programmed to M-01.

The program is changed from DVD → PLAY → TIME → TV → INPUT → AMP → AUTO to DVD → PLAY → TIME → AMP → AUTO.

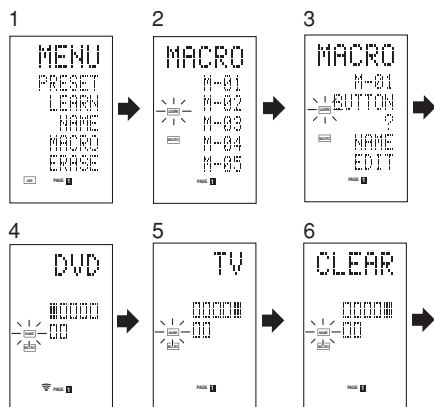

1. Hold down the **M** button for three seconds or more. The menu is displayed.

2. Press the **D4** (MACRO) direct button. The macro menu is displayed. The **MACRO** indicator displays and **LEARN** blinks.
3. Press the **D1** (M-01) direct button.
4. Press the **D5** (EDIT) direct button. The LCD displays DVD, and the step position is indicated by **■**. The programmed section is indicated by **▲**.
5. Press the **▶** cursor button to display TV.
6. Press the **CLEAR** button. The LCD displays CLEAR, and TV and INPUT are deleted.
  - When deleting steps from a macro program, the operations performed for a source after switching to the source are also deleted. If the **CLEAR** button is pressed at the INPUT position, only the INPUT step is deleted. The **□** indicator for the step is also changed.
    - To check the modified steps, press the **◀** or **▶** cursor button.
7. To exit, press the **M** button. When finished, to change another macro program, press the **OK** cursor button to return to the menu, and then repeat the procedure for steps 3 to 6.

### OVERWRITING STEPS IN MACRO PROGRAMS

This example shows how to change the macro programmed to M-01 from DVD → PLAY → AMP → AUTO to DVD → PLAY → TV → INPUT.

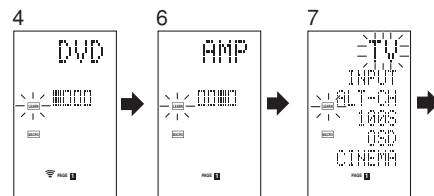

1. Hold down the **M** button for three seconds or more. The menu is displayed.
2. Press the **D4** (MACRO) direct button. The macro menu is displayed. The **MACRO** indicator displays and **LEARN** blinks.
3. Press the **D1** (M-01) direct button.
4. Press the **D5** (EDIT) direct button. The LCD displays DVD, and the step position is indicated by **■**. The programmed section is indicated by **□**.
5. Press the **▶** cursor button so that AMP is displayed.

6. Press the **TV** source button. TV blinks for 0.5 seconds.
7. Press the **D1** (INPUT) direct button. INPUT blinks for 0.5 seconds. TV and INPUT are overwritten.
  - To check the modified steps, press the **◀** or **▶** cursor button.
8. To exit, press the **M** button. When finished, to change another macro program, press the **OK** cursor button to return to the menu, and then repeat the procedure for steps 3 to 8.

### INSERTING STEPS IN MACRO PROGRAMS

This example shows how to change the macro programmed to M-01 from DVD → PLAY → AMP → AUTO to DVD → PLAY → TV → INPUT → AMP → AUTO.

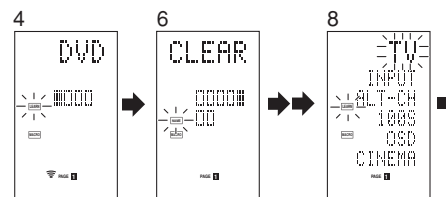

1. Hold down the **M** button for three seconds or more. The menu is displayed.
2. Press the **D4** (MACRO) direct button. The macro menu is displayed. The **MACRO** indicator displays and **LEARN** blinks.
3. Press the **D1** (M-01) direct button.
4. Press the **D5** (EDIT) direct button. The LCD displays DVD, and the step position is indicated by **■**. The programmed section is indicated by **□**.
5. Press the **▶** cursor button so that AMP is displayed.
6. Press the **MEMO** button.
7. Press the **TV** source button. TV blinks for 0.5 seconds.
8. Press the **D1** (INPUT) direct button. INPUT blinks for 0.5 seconds. TV and INPUT are inserted.
9. Press the **OK** cursor button.
  - To check the modified steps, press the **◀** or **▶** cursor button.
10. To exit, press the **M** button. When finished, to change another macro program, press the **OK** cursor button to return to the menu, and then repeat the procedure for steps 3 to 9.

### CLEARING MACRO PROGRAMS

When clearing macros, the macros programmed to the button are erased. Modified macro names are also returned to the factory default settings. This example shows how to clear a macro with the name MOVIE programmed to M-02.

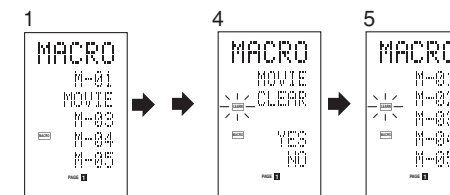

1. Press the **M** button for three seconds or more. The macro menu is displayed.
2. Press the **D4** (MACRO) direct button. The macro menu is displayed.
3. Press the **D2** (MOVIE) direct button while holding down the **CLEAR** button.
4. Press the **D4** (YES) direct button to clear the macro. To cancel the clearing operation, press the **NO** (D5 button).
5. To exit, press the **M** button. When finished, to change another macro program, press the **OK** cursor button to return to the menu, and then repeat the procedure for steps 2 to 4.

## SETTING THE MACRO TIMER

Setting the macro timer enables the macro program to automatically turn the power for a device on or off or perform other operations.

In the settings, you can select to execute the macro timer everyday or only once.

Be sure to set the clock to the correct time before using the timer. The macro timer can only be set for one program a day.

This example shows how to use the timer only once at 20:35 to execute a macro programmed to M-01.

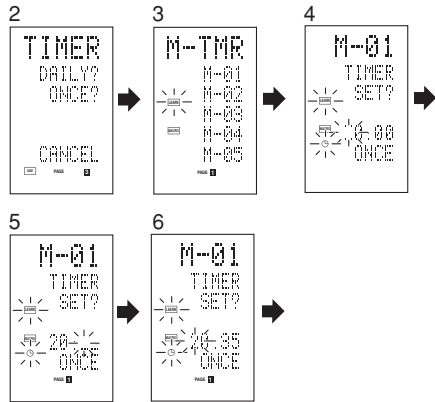

1. Hold down the **M** button for three seconds or more.  
The menu is displayed.
2. Press the **>** button to display the third page TIMER menu.
3. Press the **D2** (ONCE?) direct button.  
The M-TMR menu is displayed on the LCD.
  - To cancel timer operation, press CANCEL.
4. Press the **D1** (M-01) direct button.  
The time which is set previously is displayed.
5. Press the **2** and **0** numeric button to set the hour indicator to 20.
6. Press the **3** and **5** numeric button to set the minute indicator to 35.
7. Press the **OK** cursor button.  
This finalizes the time.
8. To exit, press the **M** button.  
To cancel the macro timer, return to the TIMER menu and press the **D5** (CANCEL) and then press **D1** (M-01).

## EXECUTING THE MACRO TIMER

The macro program starts when the time that was set is reached. The TIMER  $\odot$  indicator lights up whenever the macro timer is activated.

### Note:

- To execute the macro timer, place the remote controller facing the infrared sensor of the device to be operated. If the remote controller is not in a suitable position, it may not operate the device properly.

## CLONE MODE

### CREATING COPIES USING CLONE MODE

All of the codes programmed to the RC8001SR remote controller can be copied to another RC8001SR using a few simple operations.

- The remote controller can copy the entire contents or the contents for specific source buttons.
- When copying the entire contents, all programmed codes, modified names, programmed macros, and signal transmission intervals are copied.

When copying the contents for source buttons, the programmed codes and modified names are copied.

### Note:

- The clone function can only be used for copying when using the same model (RC8001SR) for both the transmitting and receiving remote controller.

## COPYING ENTIRE CONTENTS

### <Transmitting remote controller>

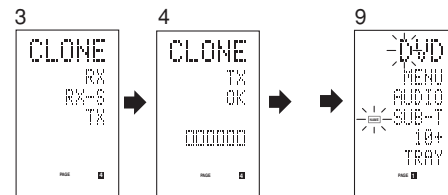

### <Receiving remote controller>

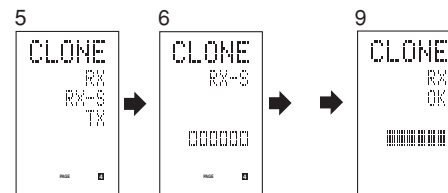

1. Place the receiver sensor of the receiving remote control (top) so that it is facing the transmitter of the transmitting remote control (top) at a distance of about 5 cm (2 inches).
2. Hold down the **M** button of the transmitting remote controller for three seconds or more.  
The menu is displayed.
3. Press the **>** button to display the fourth page CLONE menu.
4. Press the **D3** (TX) direct button.  
The transmitting side is now ready.
5. Hold down the **M** button of the receiving remote controller for three seconds or more.  
The menu is displayed.
6. Press the **>** button to display the fourth page CLONE menu.
7. Press the **D1** (RX) direct button.  
The receiving side is now ready.
8. Press the **OK** cursor button on the receiving remote controller.
9. Press the **OK** cursor button on the transmitting remote controller.  
When copying is started, the bar indicators on both LCDs start to move from the left to the right.
  - When the copying operation is completed, TX OK is displayed on the LCD of the transmitting remote controller, and RX OK is displayed on the LCD of the receiving remote controller.
  - Do not touch either of the remote controllers during the copying operation. Doing so could cause copying to fail.
  - If the copying fails in the middle of the copying process, RX ERROR is displayed on the receiving remote controller. Check and perform steps 1 to 7 again.
  - Copying takes about three minutes to complete when the transmitting remote controller has been programmed to 100% capacity.
10. Once copying is completed, press the **M** button on both remote controllers.

## COPYING BY SOURCE

The 12 sources can be copied on a source by source basis. You can select from up to 12 source types.

### <Receiving remote controller>

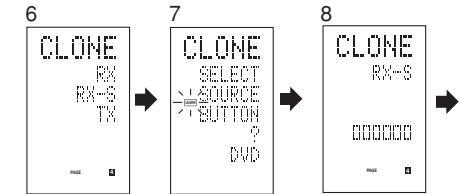

1. Place the receiver sensor of the receiving remote control (top) so that it is facing the transmitter of the transmitting remote control (top) at a distance of about 5 cm (2 inches).
2. Hold down the **M** button of the transmitting remote controller for three seconds or more.  
The menu is displayed.
3. Press the **>** button to display the fourth page CLONE menu.
4. Press the **D3** (TX) direct button.  
The transmitting side is now ready.
5. Hold down the **M** button of the receiving remote controller for three seconds or more.  
The menu is displayed.
6. Press the **>** button to display the fourth page CLONE menu.
7. Press the **D2** (RX-S) direct button.
8. Press the source button to be copied.  
The receiving side is now ready.  
The name of the source which was pressed is displayed on the LCD.
  - Each time the source button is pressed, the name is displayed on the LCD.
9. Press the **OK** cursor button on the receiving remote controller.
10. Press the **OK** cursor button on the transmitting remote controller.  
When copying is started, the bar indicators on both LCDs start to move from the left to the right.
  - When the copying operation is completed, TX OK is displayed on the LCD of the transmitting remote controller, and RX OK is displayed on the LCD of the receiving remote controller.
  - Do not touch either of the remote controllers during the copying operation. Doing so could cause copying to fail.
  - If the copying fails in the middle of the copying process, ERROR is displayed on the remote controller.  
Check and perform steps 1 to 7 again.

- Once copying is completed, press the **M** button on both remote controllers.

**SETUP**

**SETTING THE LIGHTING TIME**

- The LCD lights up when the **LIGHT** buttons are pressed. The LCD remains lit while the pressed button is held down, and it goes off when the button is released.
- The LCD continues to light up if another button is pressed while it is lit or if pressed within two seconds after the light goes off.
- The lighting time can be set in one-second units from 0 to 60 seconds.

The **LIGHT** buttons have light-absorbing properties that enable them to store light. If the buttons are no longer illuminated in a dimly lit environment, bring the buttons near a fluorescent lamp or other light source for a sufficient amount of time. This should illuminate the buttons again.

- The **LIGHT** buttons consist of a **LIGHT1** and **LIGHT2** button, and they both perform the same operation.

The factory default lighting time is set to 15 seconds.

This example shows how to set the lighting time to 20 seconds.

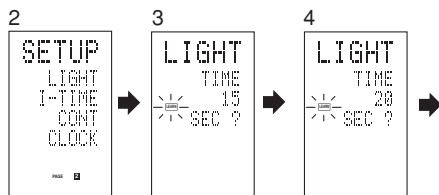

- Hold down the **M** button for three seconds or more. The menu is displayed.
- Press the **>** button to display the second page SETUP menu.
- Press the **D1** (**LIGHT**) direct button. The **LIGHT** is displayed on the LCD
- Press the **▲** or **▼** cursor button to set the lighting time.
- Press the **OK** cursor button to enter the lighting time.
- Once the setting is finished, press the **M** button.

**SETTING THE MACRO INTERVAL TIME**

When a macro program is executed, control signals are transmitted in sequence. This transmission interval (interval time) can be set in 0.5-second units from 0.5 to 5 seconds.

If the interval time is set in this Setup mode, the interval times for all programmed macros are changed. If necessary, use **EDIT** (see page 60) in the macro program to change the individual transmission times.

The factory default setting for the transmission interval is 1 second.

This example shows how to set the interval time to 5 seconds.

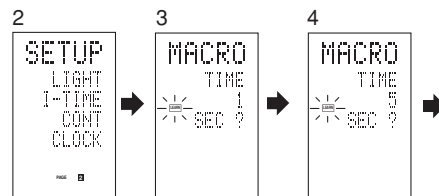

- Hold down the **M** button for three seconds or more. The menu is displayed.
- Press the **>** button to display the second page SETUP menu.
- Press the **D2** (**I-TIME**) direct button.
- Press the **▲** or **▼** cursor button to set the interval time. Holding down the cursor button fast-forwards the time indicator.
- Press the **OK** cursor button to enter the interval time.
- Once the setting is finished, press the **M** button.

**ADJUSTING THE DISPLAY CONTRAST**

The contrast of the LCD can be adjusted. Adjust for maximum visibility according to your viewing environment.

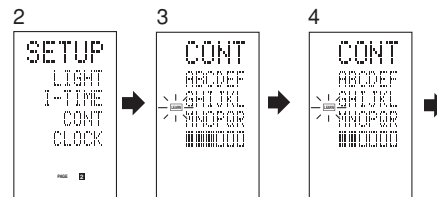

- Hold down the **M** button for three seconds or more. The menu is displayed.
- Press the **>** button to display the second page SETUP menu.
- Press the **D3** (**CONT**) direct button.
- Press the **▲** or **▼** cursor button and set the display contrast for maximum visibility. The adjustment has 10 levels. The factory default setting for the contrast is the fifth level.
- Press the **OK** cursor button to enter the display contrast.
- Once the setting is finished, press the **M** button.



# REMOTE CONTROL OPERATION (RC101)

## NAME AND FUNCTION

The included remote controller can be used in multi-room systems. Using this remote controller, you can operate the unit through infrared receivers or the infrared receptor of Marantz products in multiple rooms. The **SOURCE ON/OFF** button and control buttons are used in common across different input source components.

The input source controlled with the remote controller changes when one of the input selector buttons is pressed.

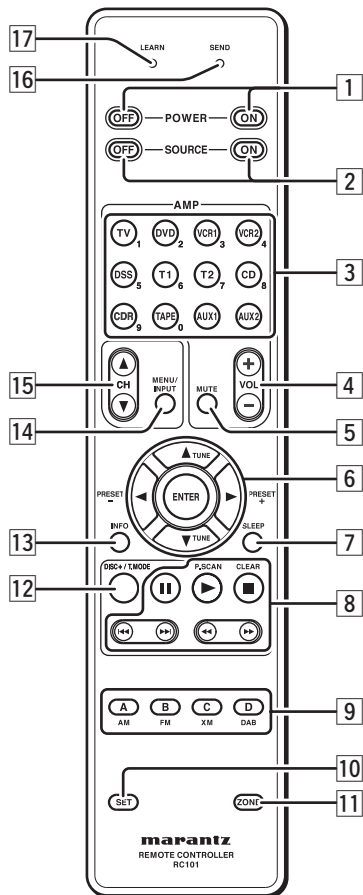

### 1 POWER ON and OFF buttons

*(When Zone (MULTI ROOM) A/B mode is selected)*

These buttons are used to turn on or off, for the multi room control or multi speaker control of the unit.

*(When Zone D (MAIN ROOM) mode is selected)*

These buttons are used to turn on or off, for the unit in main room.

### 2 SOURCE ON and OFF buttons

These buttons are used to turn on or off a specific source (such as a DVD player) independently from the rest of the system.

### 3 AMP - SOURCE /Numeric buttons

#### SOURCE buttons

These buttons are used to switch the source of the unit. Each time a source button is pressed, the remote control changes to the source which was pressed.

This remote controller can control 12 types of equipment. To change the unit source, press this button twice within two seconds. The signal is sent when it is pressed the second time.

#### Note:

The T2 button is not used for this unit.

*(When Zone (MULTI ROOM) A/B mode is selected)*

These buttons are used to select the source for the multi room/multi speaker control of the unit.

*(When Zone D (MAIN ROOM) mode is selected)*

These buttons are used to select the source for the unit in main room.

#### Numeric buttons

Use these buttons only for preset setting.

### 4 AMP - VOL +/- buttons

*(When Zone (MULTI ROOM) A/B mode is selected)*

These buttons are used to adjust the volume for the multi room control or multi speaker.

*(When Zone D (MAIN ROOM) mode is selected)*

These buttons are used to adjust the volume for the unit in main room.

### 5 AMP - MUTE button

*(When Zone (MULTI ROOM) A/B mode is selected)*

This button is used to mute the audio for the multi room control or multi speaker control of the unit.

*(When Zone D (MAIN ROOM) mode is selected)*

These buttons are used to mute the audio for the unit in main room.

### 6 ▲, ▼, ◀, ▶ (CURSOR) / ENTER buttons

These buttons are used when operating cursor of a source.

*(When Tuner mode (T1) is selected)*

#### PRESET +/- PRESET - buttons

Used to select a preset station up and down.

#### TUNE ▲ /TUNE ▼ buttons

Used to tune a frequency station up and down.

### 7 SLEEP button

*(When Zone (MULTI ROOM) A/B mode is selected)*

This button is used for setting the sleep timer of multi room control mode.

*(When Zone D (MAIN ROOM) mode is selected)*

This button is used for setting the sleep timer of the unit receiver in main room.

### 8 CONTROL buttons

These buttons are used when operating PLAY, STOP, PAUSE and other commands of a source.

*(When TUNER mode (T1) is selected)*

#### P.SCAN button

Used to start preset scan.

#### CLEAR button

Used to stop preset scan.

### 9 A/B/C/D buttons

*(When TUNER mode (T1) is selected)*

Used to select the band of tuner (AM/FM/XM/DAB).

*(When the other source is selected)*

Reserve key for the learning commands.

### 10 SET button

This button is used to enter learn mode, preset mode and clone mode.

### 11 ZONE (MULTI ROOM) button

This button is used to set the zone area.

- Zone A: MULTI ROOM A
- Zone B: MULTI ROOM B  
(The SR7002 does not use this zone.)
- Zone C: The unit does not use this zone.
- Zone D: MAIN ROOM

### 12 DISC+/T.MODE

*(When TUNER mode (T1) is selected)*

Used to select auto stereo mode or mono mode when the FM band is selected.

The "AUTO" indicator lights in the auto stereo mode.

*(When CD/DVD/CDR mode is selected)*

Used to change the disc for the CD/DVD/CDR changer.

### 13 INFO button

*(When Zone (MULTI ROOM) A mode is selected)*

When this button is pressed, the current setting for selected multi room control of the unit is displayed on the TV monitor.

*(When Zone D (MAIN ROOM) mode is selected)*

When this button is pressed, the current setting for the unit are displayed on the TV monitor.

### 14 MENU/INPUT button

*(When DVD mode is selected)*

Used to menu command.

*(When TV mode is selected)*

Used to select the TV video input.

### 15 CH ▲/▼ buttons

These buttons are used to change channels in TV mode and DSS mode.

### 16 SEND indicator

Indicates when the remote controller is transmitting a signal.

### 17 LEARN indicator

Indicates when the remote controller is in the LEARN mode.

**GENERAL INFORMATION OF RC101 TO THE UNIT**

The included remote controller can be used in multi-room systems. Using this remote controller, you can operate the unit through infrared receivers or the infrared receptor of Marantz products in multiple rooms.

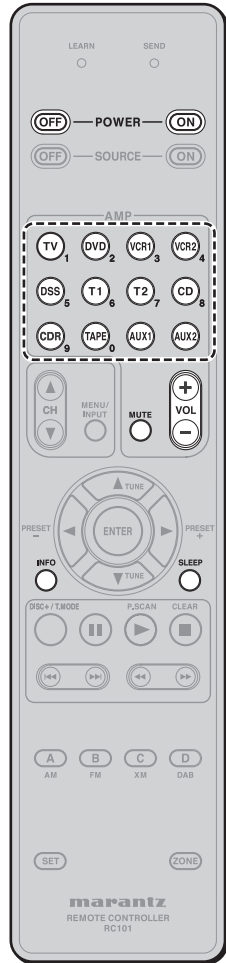

- Zone A: Multi room A control**
- Zone B: Multi room B control**  
(The SR7002 does not use this zone)
- Zone C: The unit does not use this zone.**

POWER ON/OFF	Turns on or off for each multi zone of the unit.
SOURCE	Selects a particular source component for each multi zone.
VOL +/-	Adjusts the over all sound level for each multi zone.
MUTE	Decreases the sound temporarily.
SLEEP	Sets the sleep timer function.
INFO	Turns on or off the "On Screen Display" for the multi zone.

**Zone D: Main room control**

POWER ON/OFF	Turns on or off for main room of the unit.
SOURCE	Selects a particular source component for main zone.
VOL +/-	Adjusts the over all sound level for Main room.
MUTE	Decreases the sound temporarily.
SLEEP	Sets the sleep timer function.
INFO	Turns on or off the "On Screen Display" for the main room.

**CONTROLLING MARANTZ COMPONENTS**

1. Press the desired **SOURCE** button.
2. Press the desired operation buttons to play the selected component.
  - For details, refer to the component's user guide.
  - It may not be possible to operate some models.

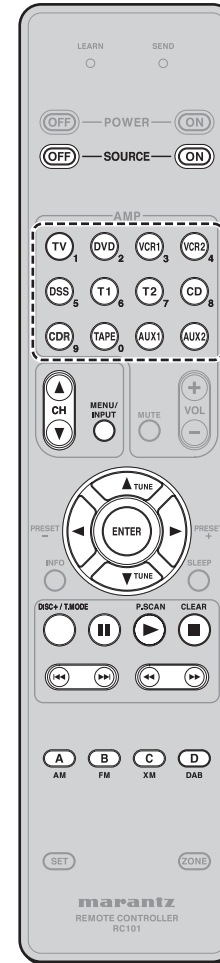

**CONTROLLING A MARANTZ TV (TV)**

SOURCE ON/OFF	Turns the TV on and off
MENU/INPUT	Select the TV video input
CH▲/▼	Selects TV channel up or down
ENTER	Moves the cursor for setting in TV menu
▲(CURSOR)	
▼(CURSOR)	
▶(CURSOR)	
◀(CURSOR)	
▶	-
■	-
	-
▶▶	-
◀◀	-
▶▶	-
◀◀	-
DISC+/T.MODE	-
A	Reserve for learning
B	Reserve for learning
C	Reserve for learning
D	Reserve for learning



**CONTROLLING A MARANTZ DVD PLAYER (DVD)**

- (\*) RC101 dose not have the PRESET code library for this key.

SOURCE ON/OFF	Turns the DVD Player on and off
MENU/INPUT	Select the DVD menu
CH▲/▼	–
ENTER	Moves the cursor for setting in DVD menu
▲(CURSOR)	
▼(CURSOR)	
▶(CURSOR)	
◀(CURSOR)	
▶	Play
■	Stop
	Pause
▶▶	Skips to forward chapter/track
◀◀	Skips to previous chapter/track
▶▶	Searchs forward
◀◀	Searchs backward
DISC+/T.MODE	DVD changer next disc (*)
A	Reserve for learnig
B	Reserve for learnig
C	Reserve for learnig
D	Reserve for learnig

**CONTROLLING A MARANTZ VCR DECK (VCR1/ VCR2)**

- RC101 dose not have the PRESET code library for this device.

SOURCE ON/OFF	Turns the VCR deck on and off
MENU/INPUT	–
CH▲/▼	–
ENTER	Moves the cursor for setting in VCR menu
▲(CURSOR)	
▼(CURSOR)	
▶(CURSOR)	
◀(CURSOR)	
▶	Play
■	Stop
	Pause
▶▶	Skips to forward track
◀◀	Skips to previous track
▶▶	Searchs forward
◀◀	Searchs backward
DISC+/T.MODE	–
A	Reserve for learnig
B	Reserve for learnig
C	Reserve for learnig
D	Reserve for learnig

**CONTROLLING A MARANTZ SATELLITE BROADCASTING TUNER (DSS)**

- (\*) RC101 dose not have the PRESET code library for this key.

SOURCE ON/OFF	Turns the satellite broadcasting tuner on and off
MENU/INPUT	Select the satellite tuner menu
CH▲/▼	Selects satellite tuner channel up or down
ENTER	Moves the cursor for setting in SATELLITE Broadcasting TUNER menu
▲(CURSOR)	
▼(CURSOR)	
▶(CURSOR)	
◀(CURSOR)	
▶	Play (*)
■	Stop (*)
	PAUSE (*)
▶▶	–
◀◀	–
▶▶	Searchs forward (*)
◀◀	Searchs backward (*)
DISC+/T.MODE	–
A	Reserve for learnig
B	Reserve for learnig
C	Reserve for learnig
D	Reserve for learnig

**CONTROLLING A MARANTZ TUNER (T1)**

- RC101 dose not have the PRESET code library for this device.

SOURCE ON/OFF	Turns the Tuner on and off
MENU/INPUT	–
CH▲/▼	–
ENTER	–
▲(CURSOR)	Tunes a frequency station up and down
▼(CURSOR)	Tunes a frequency station up and down
▶(CURSOR)	Selects a preset station up and down
◀(CURSOR)	Selects a preset station up and down
▶	Starts preset scan
■	Stop preset scan
	–
▶▶	–
◀◀	–
▶▶	–
◀◀	–
DISC+/T.MODE	Selects the auto stereo mode or mono mode
A	Selects AM mode
B	Selects FM mode
C	Selects XM mode
D	Selects DAB mode

**CONTROLLING A MARANTZ CD PLAYER (CD)**

- (\*) RC101 dose not have the PRESET code library for this key.

SOURCE ON/OFF	Turns the CD Player on and off
MENU/INPUT	–
CH▲/▼	–
ENTER	–
▲(CURSOR)	–
▼(CURSOR)	–
▶(CURSOR)	–
◀(CURSOR)	–
▶	Play
■	Stop
	Pause
▶▶	Skips to forward track
◀◀	Skips to previous track
▶▶	Searchs forward
◀◀	Searchs backward
DISC+/T.MODE	CD changer next disc (*)
A	Reserve for learnig
B	Reserve for learnig
C	Reserve for learnig
D	Reserve for learnig

**CONTROLLING A MARANTZ CD RECORDER (CDR)**

- RC101 dose not have the PRESET code library for this device.

SOURCE ON/OFF	Turns the CD Recorder on and off
MENU/INPUT	–
CH▲/▼	–
ENTER	–
▲(CURSOR)	–
▼(CURSOR)	–
▶(CURSOR)	–
◀(CURSOR)	–
▶	Play
■	Stop
	Pause
▶▶	Skips to forward track
◀◀	Skips to previous track
▶▶	Searchs forward
◀◀	Searchs backward
DISC+/T.MODE	CDR changer next disc
A	Reserve for learnig
B	Reserve for learnig
C	Reserve for learnig
D	Reserve for learnig

**CONTROLLONG A MARANTZ TAPE DECK (TAPE)**

- RC101 dose not have the PRESET code library for this device.

SOURCE ON/OFF	Turns the tape deck on and off
MENU/INPUT	–
CH▲/▼	–
ENTER	–
▲(CURSOR)	–
▼(CURSOR)	–
▶(CURSOR)	–
◀(CURSOR)	–
▶	Play
■	Stop
	Pause
▶▶	Skips to forward track
◀◀	Skips to previous track
▶▶	Searchs forward
◀◀	Searchs backward
DISC+/T.MODE	–
A	Reserve for learnig
B	Reserve for learnig
C	Reserve for learnig
D	Reserve for learnig

**CONTROLLING A MARANTZ UNIVERSAL DOCK (AUX1)**

- RC101 dose not have the PRESET code library for this device.

SOURCE ON/OFF	Turns the Universal Dock on and off
MENU/INPUT	Call up the menu
CH▲/▼	–
ENTER	–
▲(CURSOR)	Moves the cursor for setting in Universal dock menu
▼(CURSOR)	
▶(CURSOR)	
◀(CURSOR)	
▶	Play
■	Stop
	Pause
▶▶	Skips to forward track
◀◀	Skips to previous track
▶▶	Searchs forward
◀◀	Searchs backward
DISC+/T.MODE	Change the userinterface mode
A	Reserve for learnig
B	Reserve for learnig
C	Reserve for learnig
D	Reserve for learnig

## BASIC OPERATION

### NORMAL MODE

*(When operating Marantz AV equipment products)*

This remote controller is preset with a total of 12 types of remote codes, including Marantz TV (television), DVD, VCR (VCR deck), DSS (satellite broadcasting tuner), TUNER 1, TUNER 2, CD, CD-R, TAPE (tape deck), AUX1 and AUX2.

Learning is not necessary for Marantz products. You can use these products without setting any codes.

1. Press the **SOURCE** button.  
For this example, press DVD.  
Pressing the **SOURCE** button once changes the remote control to the settings for the source that was pressed.  
To change the amplifier on other source, press the **SOURCE** button twice (double-click). The code is sent, and then the amplifier source changes to DVD.

### SETTING THE BACK LIGHT

Each time press the buttons, illuminate button 2 seconds.

To turn off back light, press and hold down the **SET** and **◀◀** button until SEND indicator blinks twice.

To turn on it again, press and hold down the **SET** and **▶▶** button until SEND indicator blinks twice.  
Initial is back light ON.

### PRESET MODE

*(When operating non-Marantz AV equipment products)*

This remote controller is preset with remote control codes from AV equipment by other manufacturers. The preset codes are TV, DVD, CD and DSS. Settings can be made in one of two ways.

When the preset codes are set, the following codes are contained in the source button of the remote controller.

See the attached manufacturer number list for the preset manufacturers, devices, preset numbers, and other settings.

Remote control source name	Corresponding preset code	Device name
TV	TV	Television
DVD	DVD	DVD player
CD	CD	CD player
DSS	SATELLITE	Satellite broadcasting tuner equipment

### Important:

- Some codes may be not match your equipment. In this case, you can use LEARN mode to store these codes.
- The preset codes do not cover full functions. If you need extra function, use LEARN mode to store extra function.
- When the batteries are getting weak, the preset procedure is not successful.

### PROGRAMMING WITH THE 4-DIGIT CODE

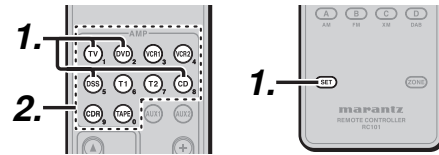

1. Press and hold down the **SOURCE** button (ex TV) for the appliance which should be controlled and press **SET** button until the SEND indicator blinks twice. Then back light flashes.
2. Press the 4-digit code by numeric keys for appliance (code table at the end of this book) When the procedure is successful, the SEND indicator will blink twice.

### Note:

If the indicator did not blink twice, then repeat steps 1 through 2 and try entering the same code again.

### SCANNING THE CODE TABLE

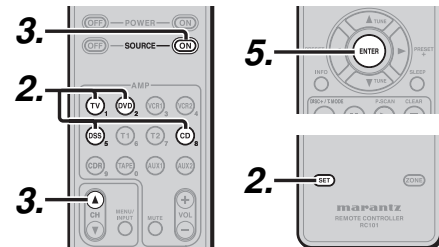

1. Switch on the appliance which should be controlled.
2. Press and hold down the **SOURCE** button for appliance which should be controlled and press **SET** button until the SEND indicator blinking twice. Then back light flashes.
3. Aim the remote controller at the appliance and alternately press the **CH+** and **SOURCE ON** buttons slowly.

4. Stop when the appliance turns off.
5. Press **ENTER** button once to lock in the code.

### CHECKING THE CODE

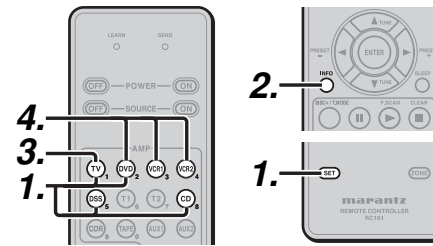

1. Press and hold down the **SOURCE** button for appliance which should be controlled and press **SET** button until the SEND indicator blinking twice then back light flashes.
2. Press the **INFO** button.  
The SEND indicator will blink twice.
3. To view the code for first digit, press 1 once.  
Count the SEND indicator blinks (e.g. 3 blinks = 3) and write down the number.

### Note:

If a code digit is "0", the SEND indicator will not blink.

4. Repeat step 3 three more times for remaining digits. Use 2 for the second digit, 3 for the third digit, and 4 for the fourth digit.

### RESETTING THE CODE

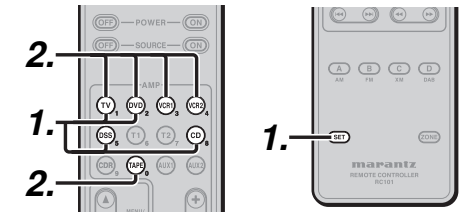

1. Press and hold down the **SOURCE** button for appliance which should be controlled and press **SET** button until the SEND indicator blinking twice. Then back light flashes.
2. Press the below codes to reset.  
TV : 1000  
DVD : 2000  
CD : 3000  
DSS : 4000  
The indicator will blink twice.

### Note:

After this procedure, the selected **SOURCE** button is set initial code.

**LEARN MODE**

This remote controller is capable of learning and storing codes used by other remote controls that you already own.

For codes which are not learned, the remote controller will transmit either the Marantz preset codes from the initial settings, or remote codes from another manufacturer's AV equipment which is set by the customer.

The receiver sensor for the remote control signals is located at the top of the remote controller.

**Notes:**

- This remote controller is capable to learn around 60 codes.
- When the batteries are getting weak, the learning procedure is not successful.

**LEARNING PROCEDURE**

1. Place the remote controller so that its infrared signal transmitter is facing the infrared signal receiver on the Marantz remote controller at a distance of about 2 inches (5 cm).

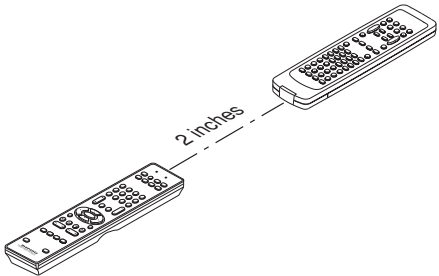

2. Press and hold down the **SET** and **MENU/INPUT** buttons until LEARN indicator blinks.

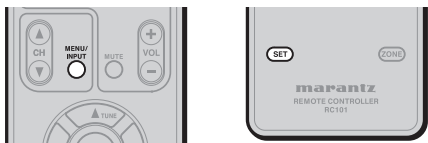

3. Select the **SOURCE** button to select the SOURCE.

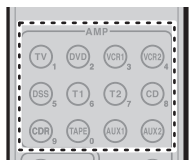

4. Select the button to be learned.
  - LEARN indicator lights up.

**When the following key learned**

• **SOURCE** buttons  
The learning function is unavailable for all SOURCE buttons in any mode.

- **POWER ON** button
- **POWER OFF** button
- **VOL +/-** button
- **MUTE** button
- **INFO** button
- **SLEEP** button

The above keys are common use in each device mode. It can be learned in TV mode.

5. Press and hold the button of the original remote controller to learn until the SEND indicator blinks twice.
  - When the SEND indicator blinks once, repeat this step.
  - When the memory of the RC101 is full, the LEARN and SEND indicators blink once. If you want to learn the code, you should erase other learned button.

6. Repeat steps 4 and 5 to learn other buttons in same SOURCE.

7. Repeat steps 3 to 6 to learn other SOURCE.

8. When you have finished programming the remote controller, press the **SET** button, then LEARN indicator stops blinking and exits from the LEARN mode.



**Notes:**

- When the SEND indicator blinks once again, the transmitting code is unavailable for RC101, or the transmitting signal is intercepted by noise.
- If no buttons are pressed for approximately 1 minutes while in the LEARN mode, the remote controller automatically exits from the LEARN mode.

**ERASING PROGRAMMED CODES (RETURNING TO INITIAL SETTINGS)**

Codes can be erased in three ways: by buttons, sources, and by all memory contents.

**Erasing the code by buttons**

1. Press and hold down the **SET** and **MENU/INPUT** buttons until LEARN indicator blinks.



2. Select the **SOURCE** button to select the button to be erased.

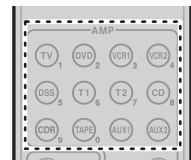

3. Press and hold down the **SLEEP** button and press the learned button twice to be erased.
  - SEND indicator blinks twice and the mode returns to LEARN mode.

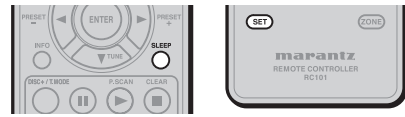

4. To return the NORMAL mode, press the **SET** button.

**Erasing the code by SOURCE**

1. Press and hold down the **SET** and **MENU/INPUT** buttons until LEARN indicator blinks.



2. Press and hold down the **SLEEP** button and press the learned **SOURCE** button twice to be erased.
  - LEARN indicator lights.

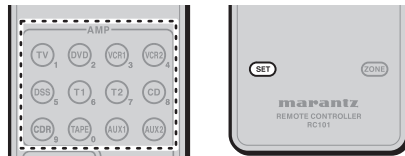

3. Press **ENTER** button to continue erasing.
  - The SEND indicator blinks twice and the mode returns to LEARN mode.
  - To cancel the erasing operation, do not press **ENTER** button and simply touch any other button.

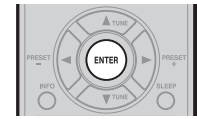

4. To return the NORMAL mode, press the **SET** button.

**Erasing the all SOURCES**

1. Press and hold down the **SET** and **MENU/INPUT** buttons until LEARN indicator blinks.



2. Press and hold down the **SLEEP** button and press **POWER ON** and **POWER OFF** button.
  - LEARN indicator lights.



3. Press **ENTER** button to continue erasing.
  - The SEND indicator blinks twice and the mode returns to LEARN mode.
  - To cancel the erasing operation, do not press **ENTER** button and simply touch any other button.



4. To return the NORMAL mode, press the **SET** button.

**Note:**

Erasing codes will return to the factory preset code, or there will leave empty if the button has no factory preset code.



**CLONE MODE**

**Creating copies using clone mode**

All of the codes programmed to the RC101 remote controller can be copied to another RC101 using a few simple operations.

- The remote controller can copy the entire contents.
- When copying the entire contents, all programmed codes are copied.

**Note:**

The clone function can only be used for copying when using the same model (RC101) for both the transmitting and receiving remote controller.

**Copying entire contents**

1. Place the receiver sensor of the receiving remote controller (top) so that it is facing the transmitter of the transmitting remote controller (top) at a distance of about 2 inches (5 cm).

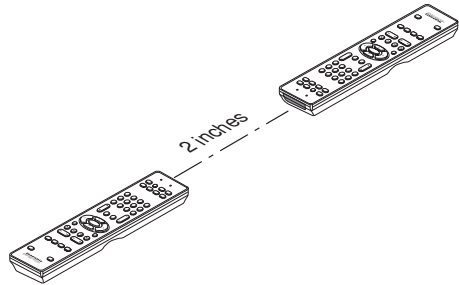

2. Press **SET** button and **PLAY** button of the transmitting remote controller until the SEND indicator blinks twice.



Then backlight flashes.  
The transmitting side is now ready.

3. Press **SET** button and **STOP** button of the receiving remote controller until the LEARN indicator blinks twice.



Then backlight flashes.  
The receiving side is now ready.

4. Press the **ENTER** cursor button on the receiving remote controller.

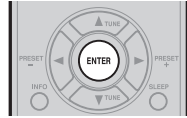

Then back lights tune off.

5. Press the **ENTER** cursor button on the transmitting remote controller.

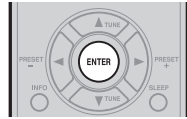

Then backlights tune off.

6. When copying is started, the SEND indicator of transmitting remote controller and the LEARN indicator of receiving remote controller start to blink.

When the copying operation is completed, the back lights of transmitting remote controller and receiving remote controller are turned on.

Do not touch either of the remote controls during the copying operation. Doing so could cause copying to fail.

If the copying fails in the middle of the copying process, back light of receiving remote are flash. Press the **SET** button to return the normal mode. Check and perform steps 1 to 5 again.

Copying takes about 30 seconds to complete when the transmitting remote controller has been programmed to 100% capacity.

7. Once copying is completed, press the **SET** button on both remote controls.



**OTHER OPERATIONS**

**CHANGE THE MULTI ROOM CONTROL COMMANDS FOR EACH ZONE**

(When operating the unit by Multi Zone connected)

- Zone A: MULTI ROOM A Control (Default)
- Zone B: MULTI ROOM B Control (The SR7002 does not use this zone.)
- Zone C: The unit does not use this zone.
- Zone D: MAIN ROOM

Change the control commands for each zone.

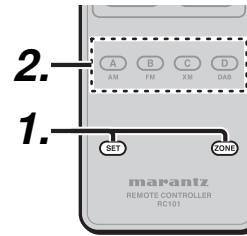

1. Press **SET** button and **ZONE** button until the SEND indicator blinks twice. Then backlight flashes.

2. Press each zone button(A/B button)  
When the procedure is successful, the SEND indicator will blink twice.

These buttons change a special code of each zone.

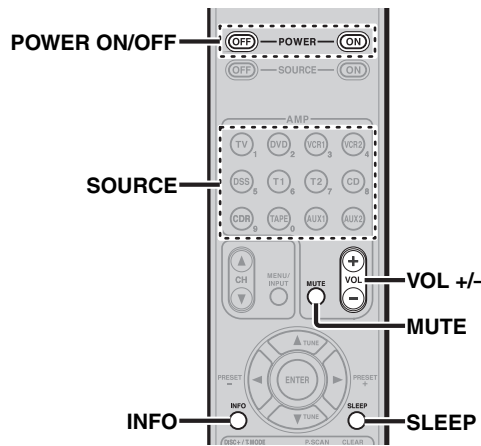

Tuner mode operation remote code (Refer to p.26)

**CHANGE THE CONTROL COMMANDS OF MULTI SPEAKER FUNCTION FROM MULTI ROOM.**

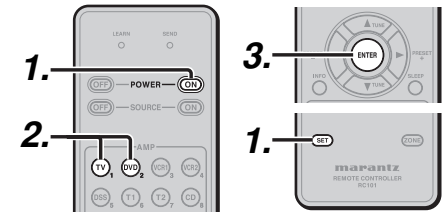

1. Press **SET** button and **POWER ON** button until the SEND indicator blinks twice. Then backlight flashes.

2. Press the 1-digit code by numeric keys.
  - Multi room mode: 1 (Default)
  - Multi speaker mode: 2

**Note**

In case of Zone D, only control for main room is possible.

3. Press **ENTER** button once to lock in the code. When the procedure is successful, the SEND indicator will blink twice.

These buttons change a special code of multi room mode or multi speaker mode.

**Note**

The control commands can be set independently in ZONE A/B.

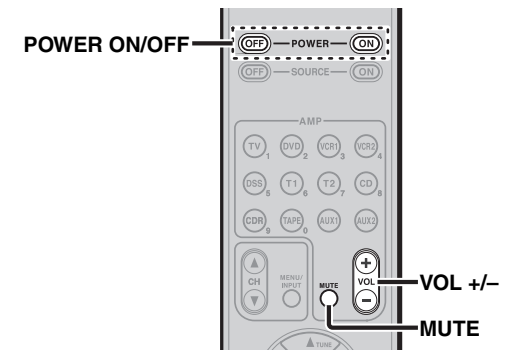

# CONNECTIONS

## SPEAKER PLACEMENT

The ideal surround speaker system for this unit is 7-speaker systems, using front left and right speakers, a center speaker, surround left and right speakers, a surround back left and right speakers, and a subwoofer.

For best results we recommend that all front speakers be of the same type, with identical or similar driver units. This will deliver smooth pans across the front sound stage as the action moves from side to side. Your center channel speaker is very important as over 80 % of the dialog from a typical motion picture emanates from the center channel.

It should possess similar sonic characteristics to the main speakers. Surround channel speakers need not be identical to the front channel speakers, but they should be of high quality.

The surround center speaker is useful for playback of Dolby Digital Surround EX or DTS-ES. One of the benefits of both Dolby Digital and DTS is that surround channels are discrete full range, while they were frequency limited in earlier "Pro Logic" type systems.

Bass effects are an important part of home theater. For optimal enjoyment a subwoofer should be used as it is optimized for low frequency reproduction. If you have full range front speakers, however, they may be used in place of a subwoofer with proper setting of the switches in the menu system.

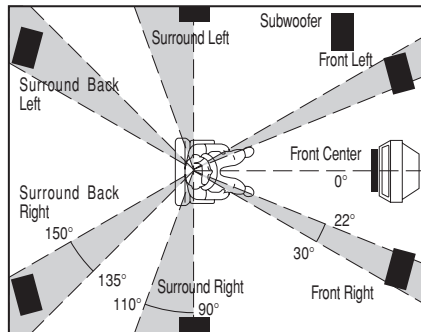

### Front left and right speakers

We recommend to set the front L and R speakers with 45-60 degrees from the listening position.

### Center speaker

Align the front line of the center speaker with the front L/R speakers. Or place the center speaker a little backward from the line.

### Surround left and right speakers

When this unit is used in surround operation, the preferred location for surround speakers is on the side walls of the room, at or slightly behind the listening position.

The center of the speaker should face into the room.

### Surround back left and right speakers

Surround back speakers are required when a full 7.1-channel system is installed.

Speakers should be placed on a rear wall, behind the listening position.

The center of the speaker should face into the room.

### Subwoofer

We recommend using a sub-woofer to have maximum bass effect. As the subwoofer only handle low frequency. You can place it anywhere in the room.

## HEIGHT OF THE SPEAKER UNITS

### Front left and right speakers, and a center speaker

Align the tweeters and mid-range drivers on the three front speakers at the same height, as best as possible.

### Surround left and right speakers, and surround back speaker

Place the surround left, right and surround back speakers higher than your ears by about 70cm-1m. Also place the speakers at the same height, as best as possible.

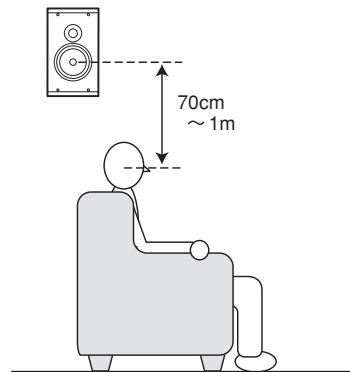

### Note:

- Use magnetically-shielded speakers for front left, right and the center speakers when the speakers are installed near the TV.

## CONNECTING SPEAKERS

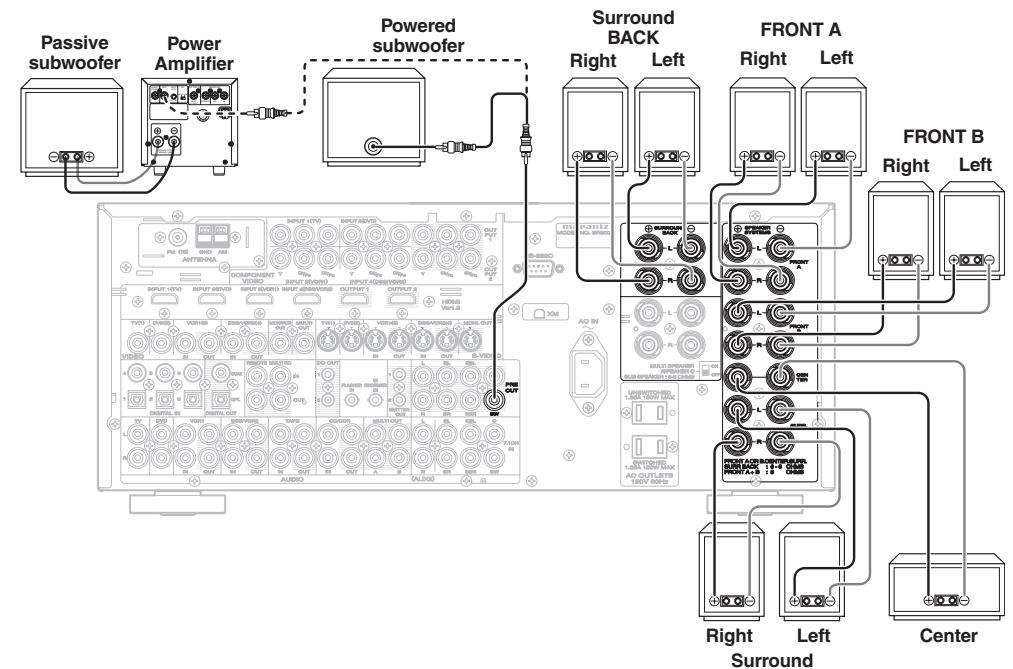

## CONNECTING SPEAKER WIRE

1. Strip away approx. 3/8 inch (10 mm) of wire insulation.
2. Twist the bared wire ends tight, to prevent short circuits.
3. Loosen the knob by turning it counterclockwise.
4. Insert the bare part of the wire into the hole in side of each terminal.
5. Tighten the knob by turning it clockwise to secure the wire.

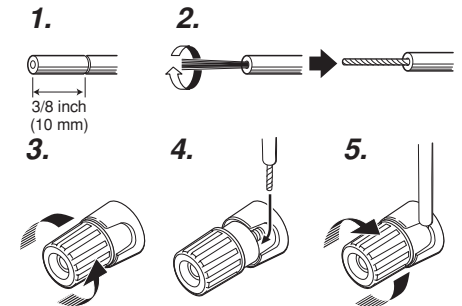

**Caution:**

- Be sure to use speakers with the specified impedance as shown on the rear panel of this unit.
- To prevent damage to circuitry, do not let the bare speaker wires touch each other and do not let them touch any metal part of this unit.

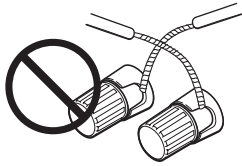

- Do not touch the speaker terminals when the power is on. It may cause you to receive an electric shocks.
- Do not connect more than one speaker cable to one speaker terminal. Doing so may damage this unit.

**Note:**

- Be sure to connect the positive and negative cables for the speaker properly. If they are miss-connected, the signal phase will be reversed and the signal quality will be corrupted.

**CONNECTING A SUBWOOFER**

Use the PRE OUT SUBWOOFER jack to connect a powered subwoofer (power amplifier built in ). If your subwoofer is a passive type (power amplifier is not built in), connect a monaural power amplifier to the PRE OUT SUBWOOFER jack and connect the subwoofer to the amplifier.

**CONNECTING AUDIO COMPONENTS**

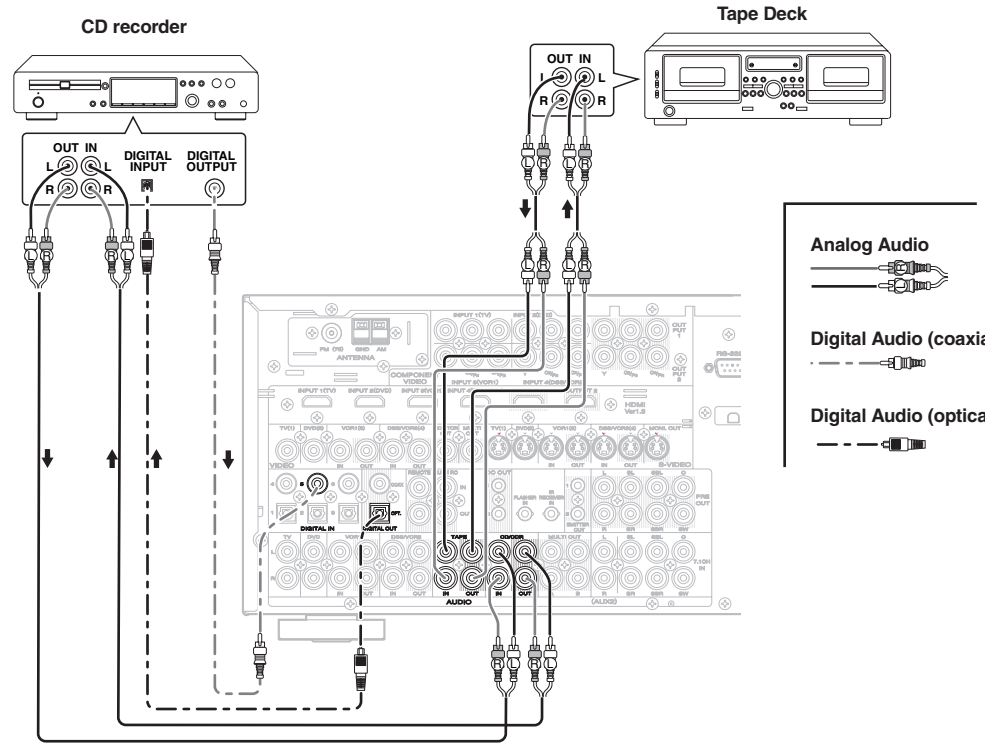

The output audio signal from the TAPE OUT jack and the CD/CD RECORDER OUT jack is the same signal which is currently selected.

**Caution:**

- Do not connect this unit and other components to mains power until all connections between components have been completed.

**Notes:**

- Insert all plugs and connectors securely. Incomplete connections may make noise.
- Be sure to connect the left and right channels properly. Red connectors are for the R (right) channel, and white connectors are for the L (left) channel.
- Be sure to connect input and output properly.
- Refer to the instructions for each component that is connected to this unit.
- Do not bind audio/video connection cables with power cords and speaker cables this will result in generating a hum or other noise.

**CONNECTING DIGITAL AUDIO COMPONENTS**

- There are 6 digital inputs, 3 coaxial jacks and 3 optical jacks, on the rear panel. You can use these jacks to input PCM, Dolby Digital and DTS bitstream signals from a CD, DVD, or other digital source components.
- There is one digital output coaxial jack and one optical output jack on the rear panel. These jacks can be connected to a CD recorder, or a MD deck inputs, respectively.
- Refer to the instructions for each component. To setup the digital audio format of DVD player, or other digital source's connected to digital input jacks.
- Use fiber optical cables (optical) for DIG-1,2,3 input jacks. Use 75 ohms coaxial cables (for digital audio or video) for DIG-4, 5, 6 input jacks.
- You can designate the input for each digital input/output jacks according to your component. See page 43.

**Notes:**

- There is no Dolby Digital RF input jack. Use an external RF demodulator Dolby Digital decoder when connecting the Dolby Digital RF output jack of the videodisc player to the digital input jack.
- The digital signal jacks on this unit conform to the EIA standard. If you use a cable that does not conform to this standard, this unit may not function properly.
- Each type of audio jack works independently. Signals input through the digital and analog jacks are output through the corresponding digital and analog jacks, respectively.

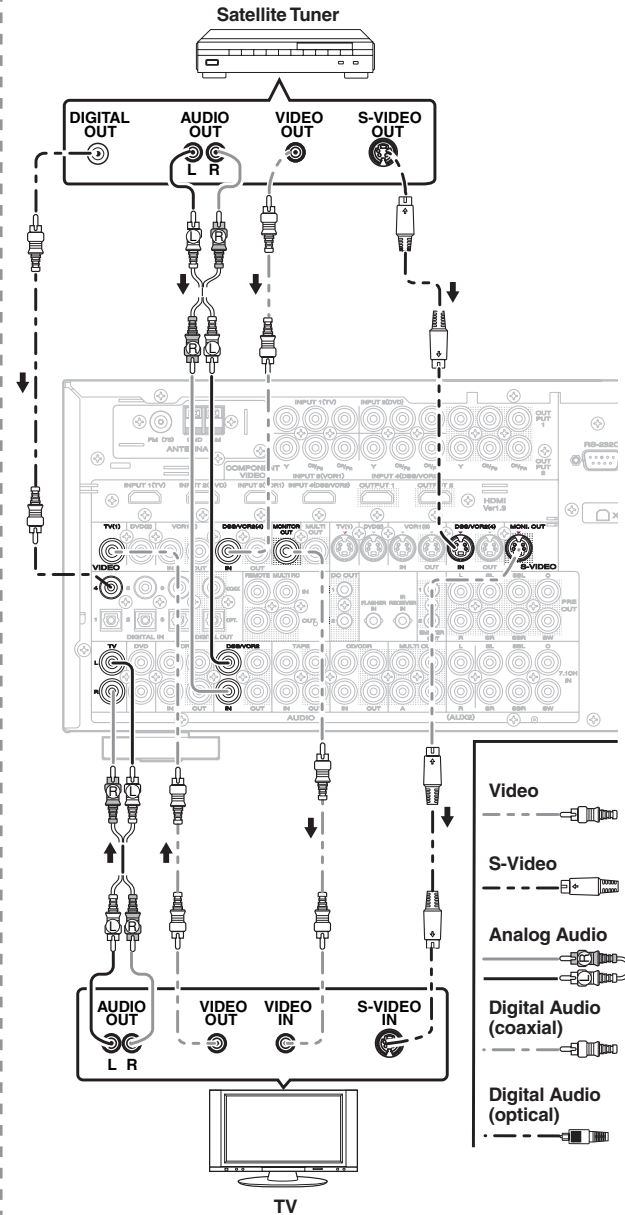
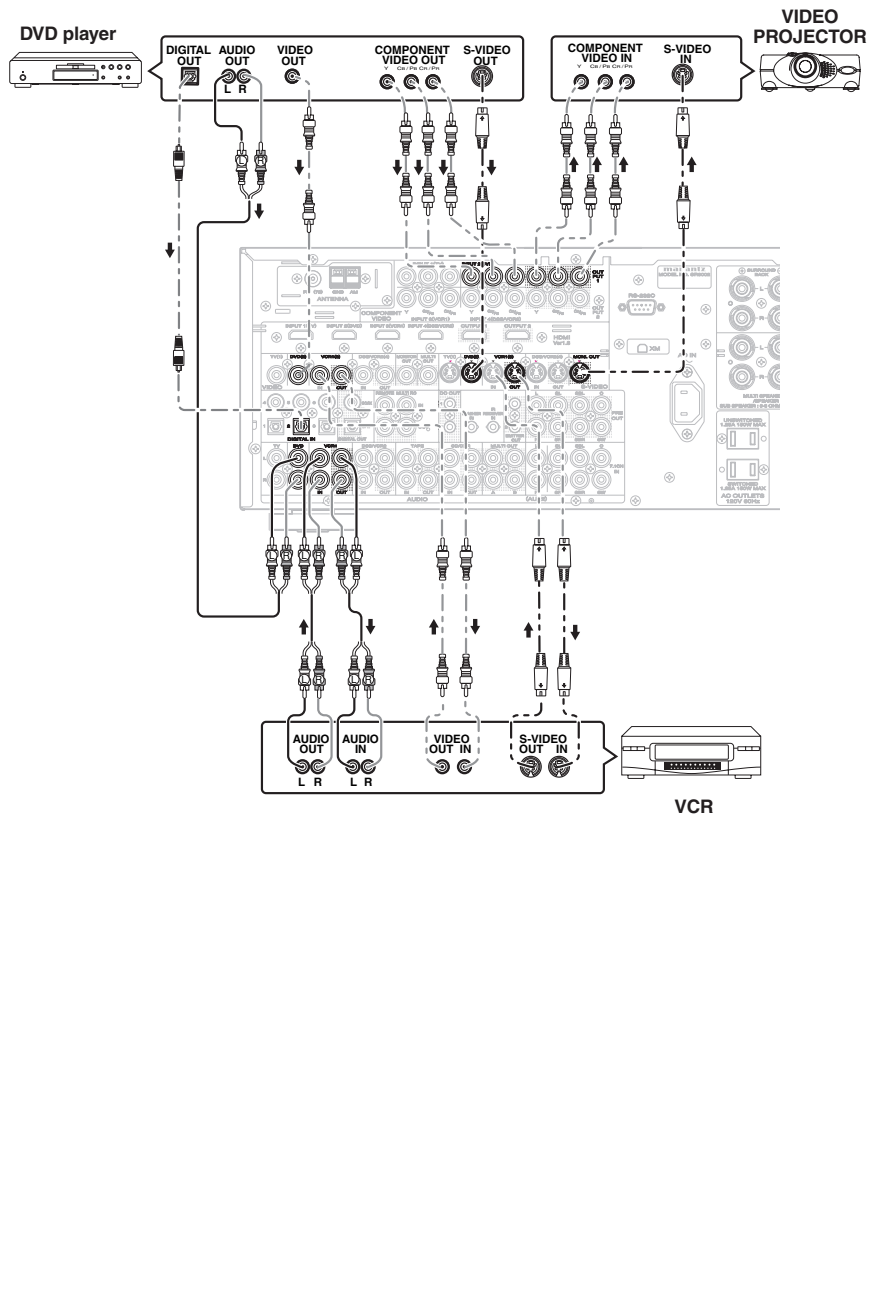

VIDEO, S-VIDEO, COMPONENT JACKS

There are 3 types of video jacks on the rear panel.

**VIDEO jack**

The video signal for the VIDEO jacks is the conventional composite video signal.

**S-VIDEO jack**

The video signal is separated into luminance (Y) and color (C) signals for the S-VIDEO jack. The S-VIDEO signals enables high-quality color reproduction. If your video component has an S-VIDEO output, we recommend to use it. Connect the S-VIDEO output jack on your video component to the S-VIDEO input jack on this unit.

**Component jack**

Make component video connections to a TV or monitor with component inputs to produce higher quality video images. Use a component video cable or 3 video cords to connect the component video out jacks on the unit to the monitor.

**Notes:**

- Be sure to connect the left and right audio channels properly. Red connectors are for the R (right) channel, and white connectors are the for L (left) channel.
- Be sure to connect the inputs and outputs of the video signals properly.
- If you connect the S-VIDEO or component signal to the S-VIDEO or component jack on this unit, it is not necessary to connect the conventional video signal to the VIDEO (composite) jack. If you use both video inputs, this unit gives priority to the S-VIDEO signal.
- Each type of video jack works independently. Signals input to the VIDEO (composite) and S-VIDEO jacks or component are output to the corresponding VIDEO (composite) and S-VIDEO or component jacks, respectively.
- This unit has the "TV-AUTO ON/OFF" function to turn the TV ON or OFF automatically, by sensing the incoming video signal from the VIDEO jacks.
- You may need to setup the digital audio output format of your DVD player, or other digital source components. Refer to the instructions of the each component connected to the digital input jacks.
- There is no Dolby Digital RF input jack. Use an external RF demodulator with a Dolby Digital decoder to connect the Dolby Digital RF output jack of the DVD player to the digital input jack on this unit.
- The COMPONENT OUTPUT 1 and 2 terminals of this unit can output the same video signal. Moreover, the OUTPUT 2 terminal of the SR8002 can output video signals for multi room playback. (See page 53)



## CONNECTING HDMI COMPONENTS

### HDMI JACK

This unit has four HDMI inputs and two HDMI output. It can send digital video and audio signals from DVDs and other sources directly to a display. It minimizes signal degradation caused by analog conversion so that high quality images can be enjoyed.

This unit is also capable of converting analog video signals (Composite Video, S-Video, Component Video) for HDMI output.

Select an input source from the OSD menu system. (See page 43, 44)

#### Notes:

- When the HDMI output is connected to a display monitor that does not support HDCP, signals are not output. To view images in HDMI, it is necessary to connect to a display that supports HDCP.
- There may be no image output if connected to a TV or display that is not compatible with the above format.
- Refer to the instruction manual of the TV or display to be connected to the unit for detailed information regarding the HDMI terminal.

\* **HDCP: High-bandwidth Digital Content Protection**

### CONNECTING HDMI COMPONENTS

An HDMI cable (sold separately) is used to connect the HDMI jack on the unit with the HDMI jack on a DVD player, TV, projector or other component. To transmit multichannel audio via HDMI, the connected player must support multichannel audio transmission through its HDMI jack.

HDMI video streaming is compatible with DVI in principle. Therefore, it is possible to connect to a TV or monitor that has a DVI terminal using an HDMI-DVI conversion cable or plug. When connecting to a DVI terminal, connect the audio signal separately.

#### Notes:

- Some HDMI components can be controlled over the HDMI cable, but this unit cannot control other components this way.
- When connected to a monitor (i.e., TV, projector, etc.) that does not support HDCP, video and audio are not output.
- DVI cables come with 24-pin and 29-pin plugs. This unit supports 24-pin DVI-D cables; 29-pin DVI cables cannot connect to it.

- Some source devices such as DVD players or set top box do not support HDMI repeater operations like those of the unit. In such case, pictures are not properly projected on monitors such as TVs and projectors.
- When multiple components are connected to this unit, turn power to unused components off to prevent interference between them.
- Disconnecting or connecting cables with the power on can damage the equipment. Turn the power off before disconnecting or connecting cables.
- Some DVD-Audio disks disable downmixing. These types of disks are not played back correctly unless the left, center, right and surround left and right speakers, and subwoofer are connected.
- If a DVD player that does not support HDMI 1.1 or later is connected to the unit, multi channel PCM playback is not possible even with DVD-Audio disks.
- If an Super Audio CD player that does not support HDMI 1.2 or later is connected to the unit, DSD playback is not possible even with Super Audio CD.

(\*DSD: Direct Stream Digital)

- The following functions are not available when the unit is connected to equipment that does not support HDMI 1.3a.
  - Deep Color
  - xvYCC
- Bitstream audio signal decoding, as for Dolby Digital Plus, Dolby TrueHD, DTS-HD, and so on

For details, refer to the user's manuals of connected equipment.

- If a DVD player or other device with DVI output is connected to the unit, a separate audio cable (optical-digital, coaxial digital or analog) is needed for the audio signals. In this case, select the connected audio input as explained in "1-1 FUNC INPUT SETUP". (See page 43)
- Multi channel PCM signals and audio signals of 64 kHz or higher that are input from the HDMI jack are not output from the DIGITAL OUT jacks.
- Depending on the quality of the cable used, the HDMI signal may be affected by noise.

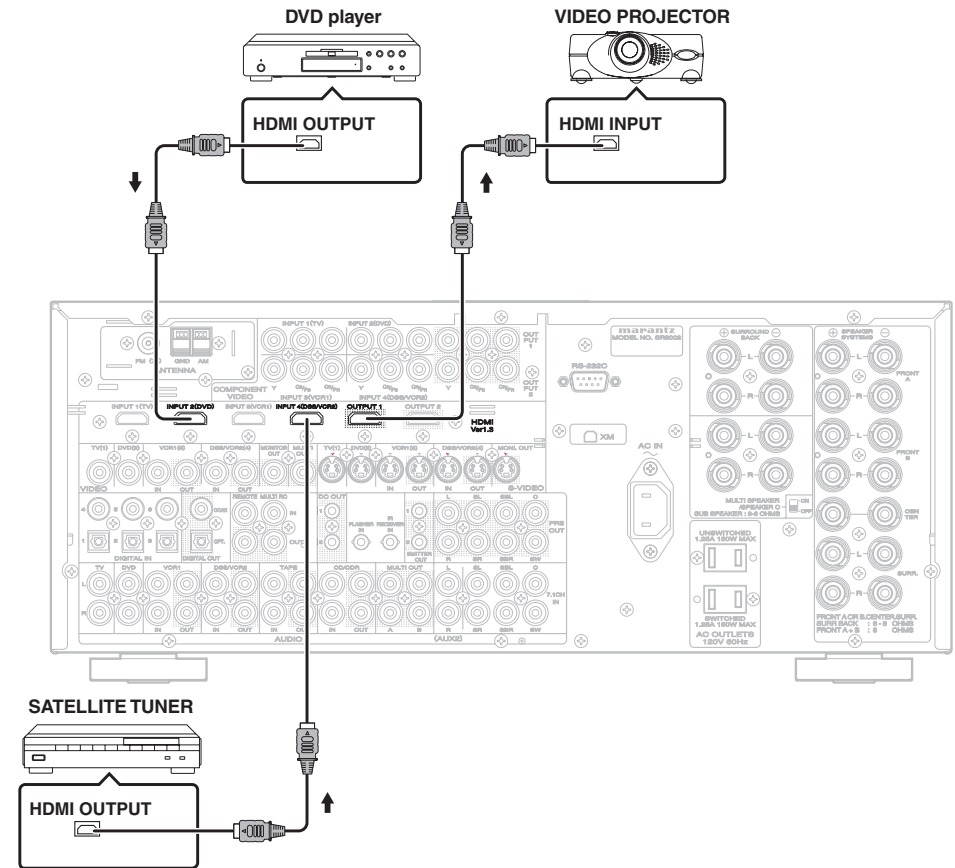

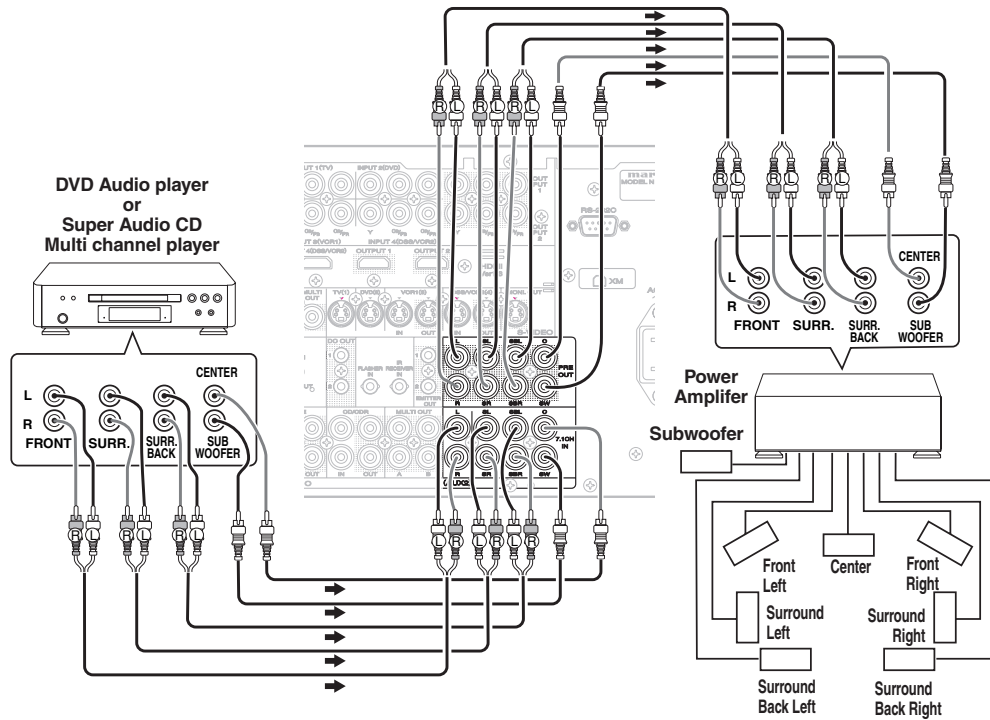

**CONNECTING MULTI CHANNEL AUDIO SOURCE**

The 7.1CH INPUT jacks are for multichannel audio source such as a Super Audio CD multichannel player, DVD audio player or external decoder. If you use these jacks, switch on the 7.1CH INPUT and set the 7.1CH INPUT level by using the SETUP MAIN MENU. See page 43.

**CONNECTING AN EXTERNAL POWER AMPLIFIER**

The PREOUT jacks are for connecting external power amplifiers. Be sure to connect each speaker to the corresponding external power amplifier.

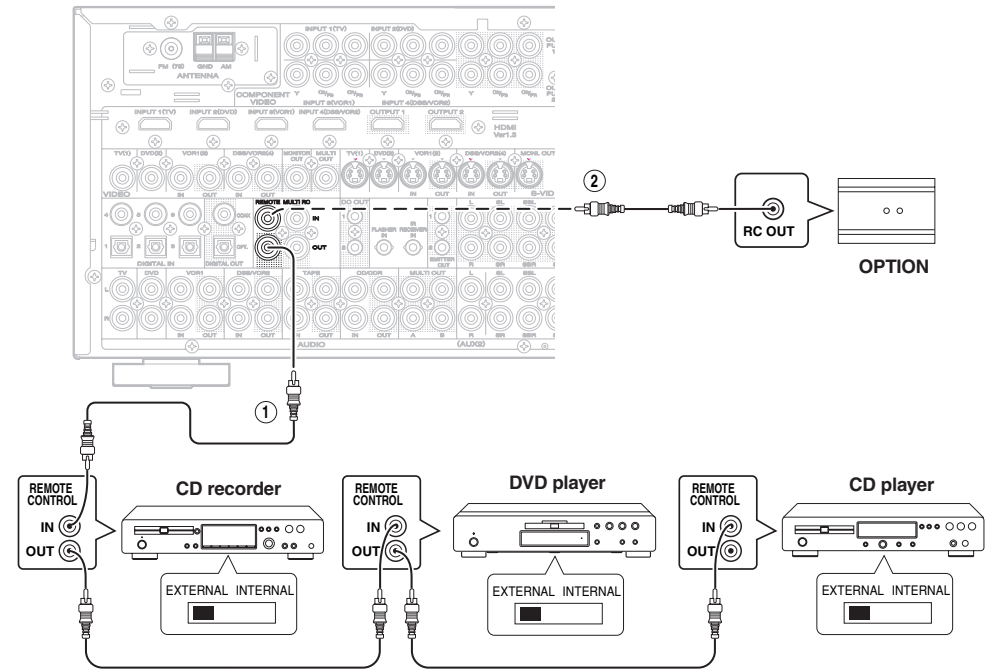

①

You can control other Marantz products through this unit with the remote controller by connecting the REMOTE CONTROL terminals on each unit. The signal transmitted from the remote controller is received by the remote sensor on this unit. Then the signal is sent to the connected device through this terminal. Therefore you need to aim the remote control only at the unit. Also, if a Marantz power amplifier (some models excluded) is connected to one of these terminals, the power amplifier's power switch is synchronized with this unit's power switch.

Set the REMOTE CONTROL SWITCH on the back of other units (not the SR7002/8002) to "EXT." (EXTERNAL) to use this feature.

②

Whenever external infrared sensors or similar devices are connected to RC-5 IN of the unit, be sure to always disable operation of the infrared sensor on the unit by using the following procedure.

1. Hold down the **MULTI** button and the **MENU** button on the front panel at the same time for five seconds.
2. The setting "IR=ENABLE" is shown on the FL DISPLAY.
3. Press the **CURSOR** buttons (◀, ▶) to change this to "IR=DISABLE".
4. Press the **ENTER** button. Once this setting is made, the infrared sensor on the unit is disabled.

**Note:**

- Be sure to set to "IR=ENABLE" when external infrared sensors or similar devices are not connected. Otherwise, the unit will be unable to receive remote control commands.
5. To restore the original setting, perform steps 1 to 4 to set to "IR=ENABLE".

**CONNECTING THE ANTENNA TERMINALS**

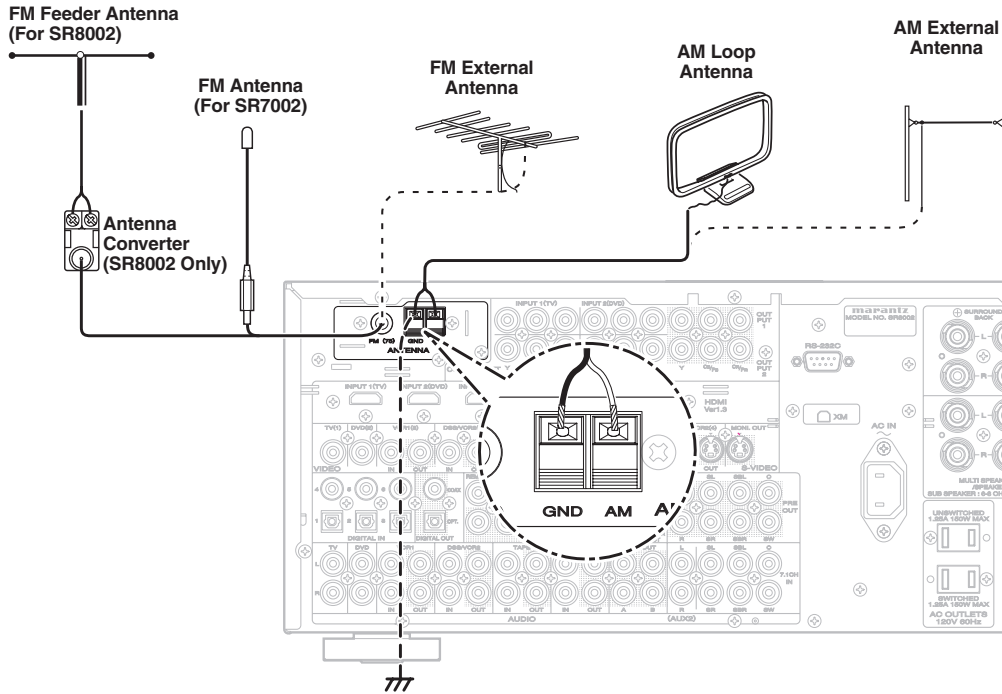

**ASSEMBLING THE AM LOOP ANTENNA**

1. Release the vinyl tie and take out the connection line.
2. Bend the base part in the reverse direction.
3. Insert the hook at the bottom of the loop part into the slot at the base part.
4. Place the antenna on stable surface.

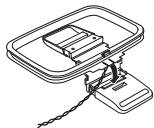
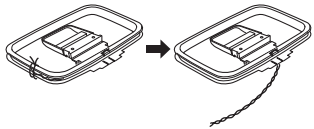

**CONNECTING THE ANTENNA WIRE TO THE ANTENNA CONVERTER**

Loosen the screws and attach the wire terminals, then tighten the screws with a screwdriver.

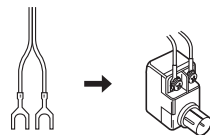

**CONNECTING THE SUPPLIED ANTENNAS**

**Connecting the supplied FM antenna**

The supplied FM antenna is for indoor use only. During use, extend the antenna and move it in various directions until the clearest signal is received. Fix it with push pins or similar implements in the position that will cause the least amount of distortion. If you experience poor reception quality, an outdoor antenna may improve the quality.

**Connecting the supplied AM loop antenna**

The supplied AM loop antenna is for indoor use only. Set it in the direction and position it to where you receive the clearest sound. Put it as far away as possible from the unit, televisions, speaker cables, and power cords. If you experience poor reception quality, an outdoor antenna may improve the quality.

1. Press and hold down the lever of the AM antenna terminal.
2. Insert the bare wire into the antenna terminal.
3. Release the lever.

**Note:**

- Connect the shielded grounding wire (black) to the AM antenna GND terminal.

**CONNECTING AN FM OUTDOOR ANTENNA**

**Notes:**

- Keep the antenna away from noise sources (neon signs, busy roads, etc.).
- Do not put the antenna close to power lines. Keep it well away from power lines, transformers, etc.
- To avoid the risk of lightning and electrical shock, grounding is necessary.

**CONNECTING AN AM OUTDOOR ANTENNA**

An outdoor antenna will be more effective if it is stretched horizontally above a window or outside.

**Notes:**

- Do not remove the AM loop antenna.
- To avoid the risk of lightning and electrical shock, grounding is necessary.

## XM RADIO OVERVIEW

This unit is the XM Ready® receiver. You can receive XM Satellite Radio® by connecting to the XM Mini-Tuner and Home Dock (sold separately) and subscribing the XM service.

### Introducing XM Satellite Radio

There's a world of audio listening pleasure beyond AM and FM. XM Satellite Radio which includes:

- Over 170 Digital Channels
- The most commercial-free music in satellite radio
- Live concerts plus exclusive original programming
- The biggest names in news, talk, and entertainment
- The most sports play-by-play
- Major league Baseball. Every team. All season long.

Questions? Visit [www.xmradio.com](http://www.xmradio.com) <<http://www.xmradio.com/>>

### How to Subscribe

Listeners can subscribe by visiting XM on the Web at [www.xmradio.com](http://www.xmradio.com) or by calling XM's Listener Care at (800) 967-2346. Customers should have their Radio ID and credit card ready. The Radio ID can be found by selecting channel 0 on the radio.

(See the "CHECKING THE XM SIGNAL STRENGTH AND RADIO ID")

### A Warning Against Reverse Engineering

It is prohibited to copy, decompile, disassemble, reverse engineer, or manipulate any technology incorporated in receivers compatible with the XM Satellite Radio system.

Furthermore, the AMBE® voice compression software included in this product is protected by intellectual property rights including patent rights, copyrights, and trade secrets of Digital Voice Systems, Inc. The user of this or any other software contained in an XM Radio is explicitly prohibited from attempting to copy, decompile, reverse engineer, or disassemble the object code, or in any other way convert the object code into human-readable form. The software is licensed solely for use within this product.

XM \$ 12.95 monthly service subscription sold separately. XM Mini-Tuner and Home Dock required to receive XM service (sold separately). Installation costs and other fees and taxes, including a one-time activation fee may apply. Subscription fee is consumer only. All fees and programming subject to change. Channels with frequent explicit language are indicated with an XL. Channle blocking is available for XM radio receivers by calling 1-800-XMRADIO. Subscriptions subject to Customer Agreement available at [xmradio.com](http://xmradio.com). XM service only available in the 48 contiguous United States. [XM Ready, XMDirect\*] are trademarks of XM Satellite Radio Inc. © 2006 XM Satellite Radio Inc. All rights reserved.

## CONNECTING THE XM CONNECT-AND-PLAY ANTENNA

- Plug the XM Mini-Tuner and Home Dock into XM terminal on the rear panel.
- Position the XM antenna near a south-facing window to receive the best signal. When making connections, also refer to the operating instructions of the XM Mini-Tuner and Home Dock.

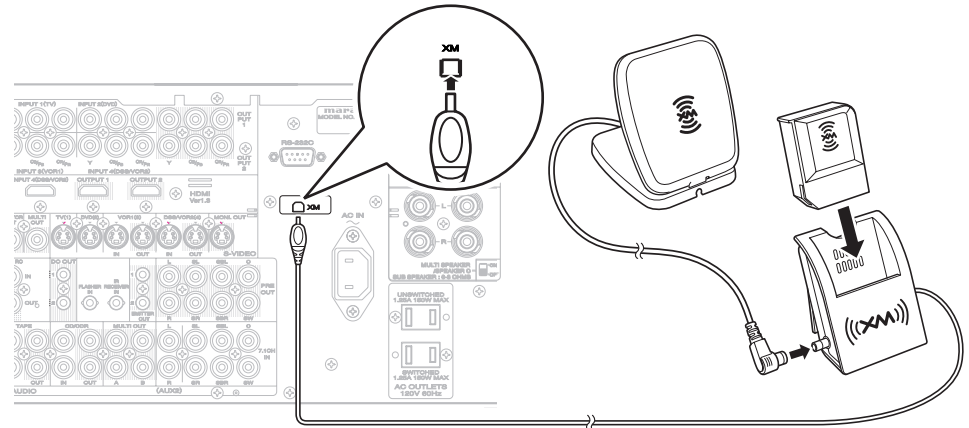

### Note

- Keep the power supply cord unplugged until the XM Mini-Tuner and Home Dock connection have been completed.



CONNECTING FOR THE MULTI ROOM

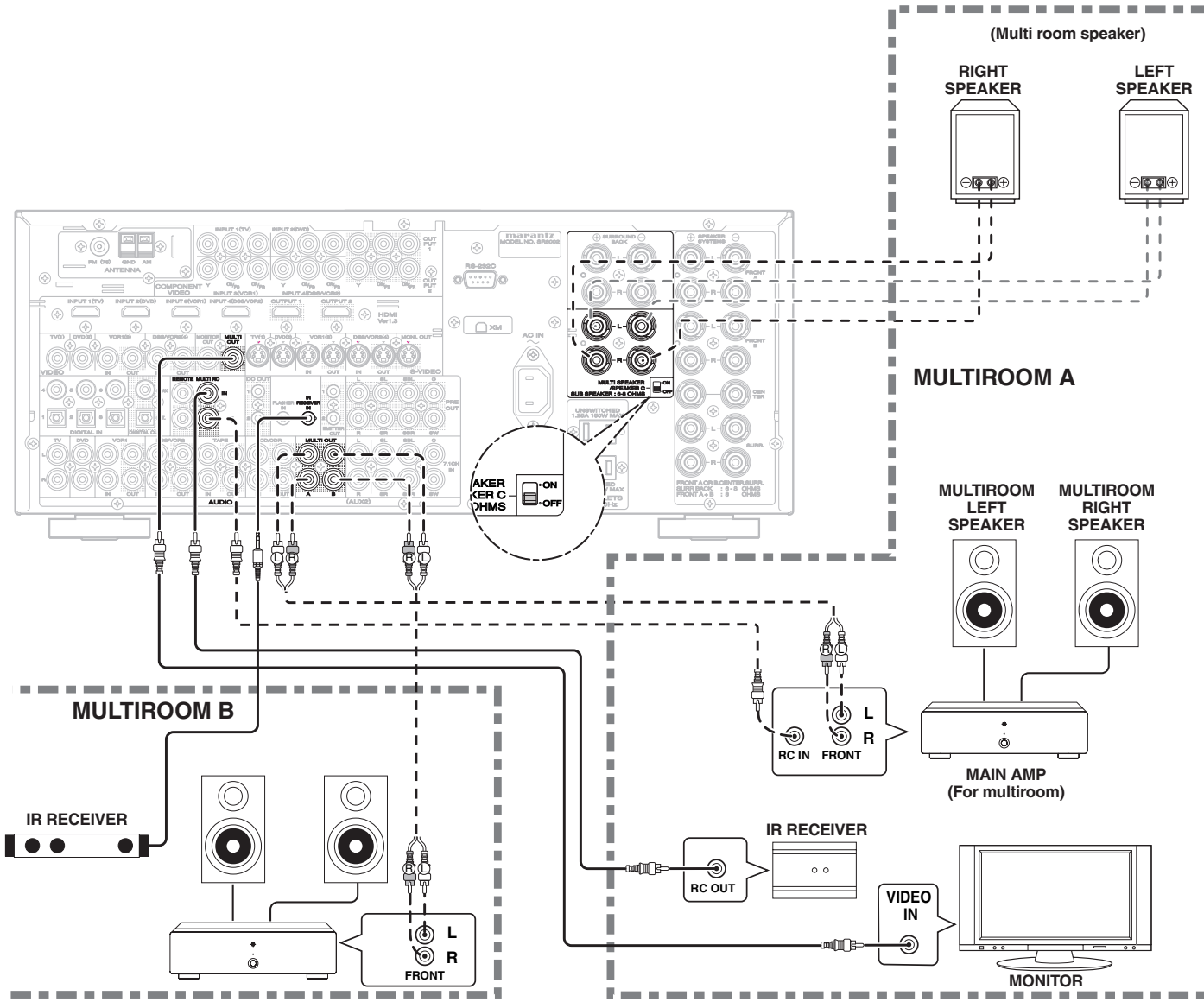

**Note:**  
The SR7002 does not use MULTIROOM B.

CONNECTING FOR SPEAKER C USE

**Bi-amp Connection**

A bi-amp connection is possible with speakers that have two sets of inputs (for treble and bass). This allows you to drive the treble and bass units with separate channel amps, which enables better sound quality. Connect the speakers as shown in the figure. Set the SPEAKER C selector switch on the rear panel to ON.

**Notes:**

- If incorrectly connected, a protective circuit in the unit will trip and set the unit to standby. (The STANDBY indicator will flash.) In such case, recheck the connections between the speakers and the unit.
- Turn power to the unit off before changing the setting of the SPEAKER C selector switch.

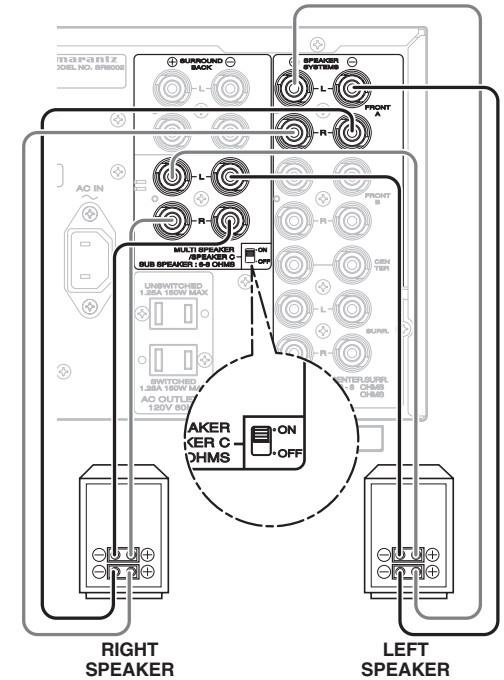

**Note:**

- You can use surround back speaker terminals as MULTI SPK. terminals or SPEAKER C terminal when you are not using surround back speakers.

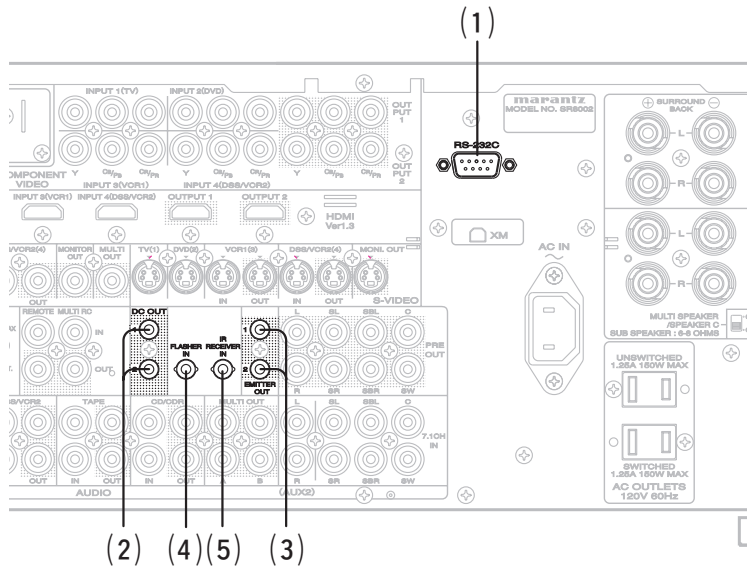

**(1) RS232C**

Connect an external control device or other device for servicing. (Use a straight cable for the connection.)

**(2) DC OUT (DC TRIGGER)**

External devices can be controlled from the unit by connecting them to the DC OUT terminal (12 V 44mA max).

**(3) EMITTER OUT (SR8002 Only)**

Outputs the remote control signal input to the IR RECEIVER IN terminals. External components can be controlled by connecting them to the EMITTER OUT terminal.

**(4) FLASHER IN**

This unit can be controlled by connecting a control box or other control device to this unit.

**(5) IR RECEIVER IN (SR8002 Only)**

This unit can be operated by remote controller without using the internal IR receiver, by connecting an external IR receiver.

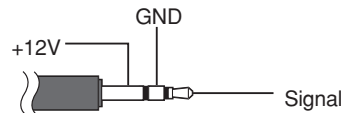

An IR receiver is connected as shown above.

**Caution:**

- Wrongly connecting an IR receiver or connecting an IR receiver of the wrong voltage can damage the unit, therefore do not do this.
- 50 mA of current are supplied to the device connected to the IR RECEIVER IN terminal.
- Connecting a device that requires more than 50 mA of current to this unit will damage this unit. Before using other devices, carefully check the specifications of those devices.

# SETUP

After all components are connected, initial setup must be performed.

## ONSCREEN DISPLAY MENU SYSTEM

This unit incorporates an onscreen menu system, which makes various operations possible by using the cursor (▲, ▼, ◀, ▶) and **OK/ENTER** buttons on the remote controller or on the front panel.

**Note:**

- To view the onscreen displays, make certain you have connected the **MONITOR OUT** jack on the rear panel to the composite, S-Video, component video or **HDMI** input of your TV or projector. (See page 33, 34)

1. Press the **AMP** button on the remote controller. (This step is not needed when operating the setup menus from the unit.)
2. Press the **MENU** button on the remote controller or press the **MENU** button on the front panel. The **"MAIN MENU"** of the OSD menu system is displayed.  
There are 6 items in the MAIN MENU.
3. Select the desired sub-menu with the ▲ or ▼ cursor buttons and press the **OK/ENTER** button. The display will change to the selected sub-menu.

**Notes:**

- If you desire to adjust any sub-menu, you need to set it to **UNLOCKED**.
- To lock sub-menus, set items 1-6 on the MAIN MENU to **"LOCKED"**.

**<LOCKING SUBMENUS>**

- (1) Move the cursor to "1. INPUT SETUP" in the MAIN MENU.
- (2) Select the "●" mark left of **"LOCKED"** with the ◀ or ▶ cursor buttons.
4. To exit from OSD menu system, press the **EXIT** button, or move the cursor to **EXIT** and press the **OK/ENTER** button.

**Note:**

- Settings are entered with the **ENTER** button on the unit or the **OK** button on the remote controller. When using the remote controller, use the **OK** button as if it were the **ENTER** button.

## RC8001SR BUTTON CONTROL

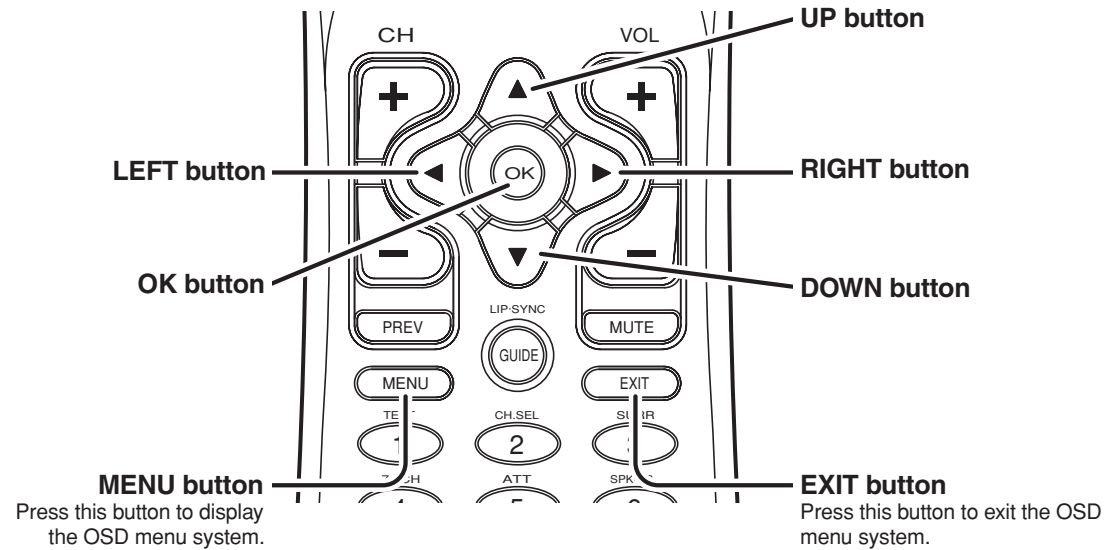

## SR7002/SR8002 FRONT BUTTON CONTROL

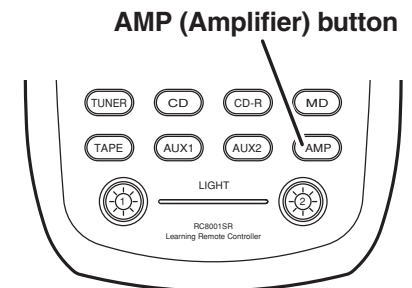
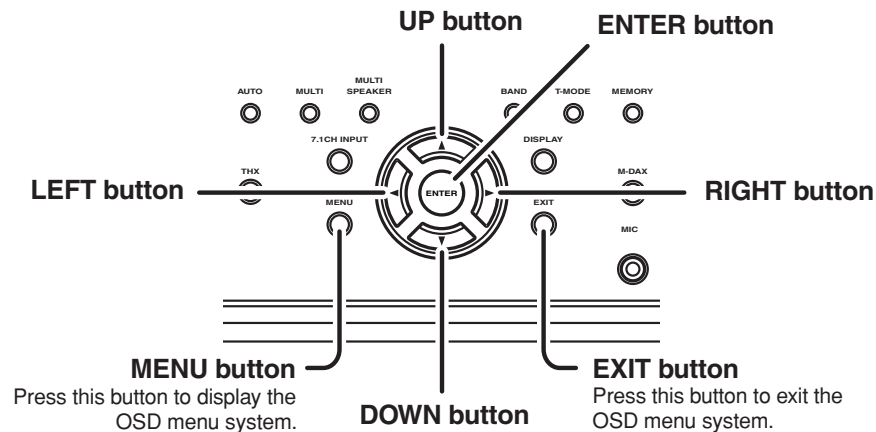

**Note:**

- After you complete this portion of the setup, move cursor to “RETURN” with the ▲, ▼, ◀ and ▶ cursor buttons and press the OK/ENTER button.

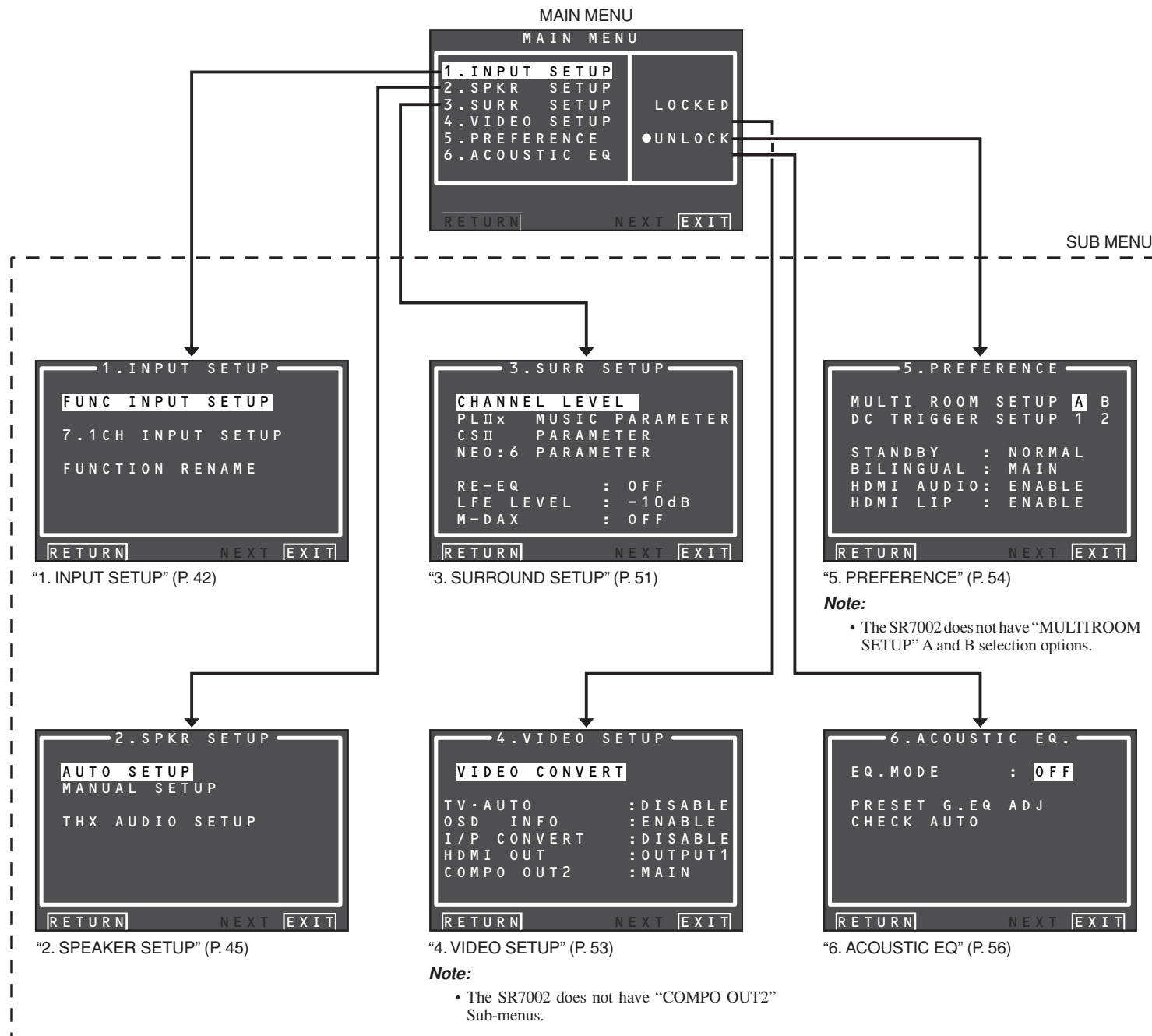

## 1 INPUT SETUP

This menu is for setting the matching the output of connected audio devices and the input jacks of this unit.

- **FUNC INPUT SETUP :**  
“1-1 FUNC INPUT SETUP” (see page 43)
- **7.1 CH INPUT SETUP :**  
“1-2 7.1 CH INPUT SETUP” (see page 43)
- **FUNC RENAME :**  
“1-3 FUNCTION RENAME” (see page 44)

1. Select “1. INPUT SETUP” from the MAIN MENU with ▲ or ▼ cursor button, and press the OK/ENTER button.

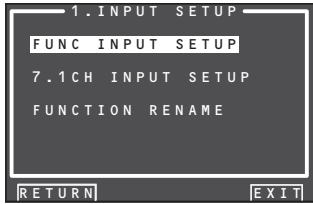

2. Select the desired sub-menu with the ▲ or ▼ cursor buttons, and press the OK/ENTER button.

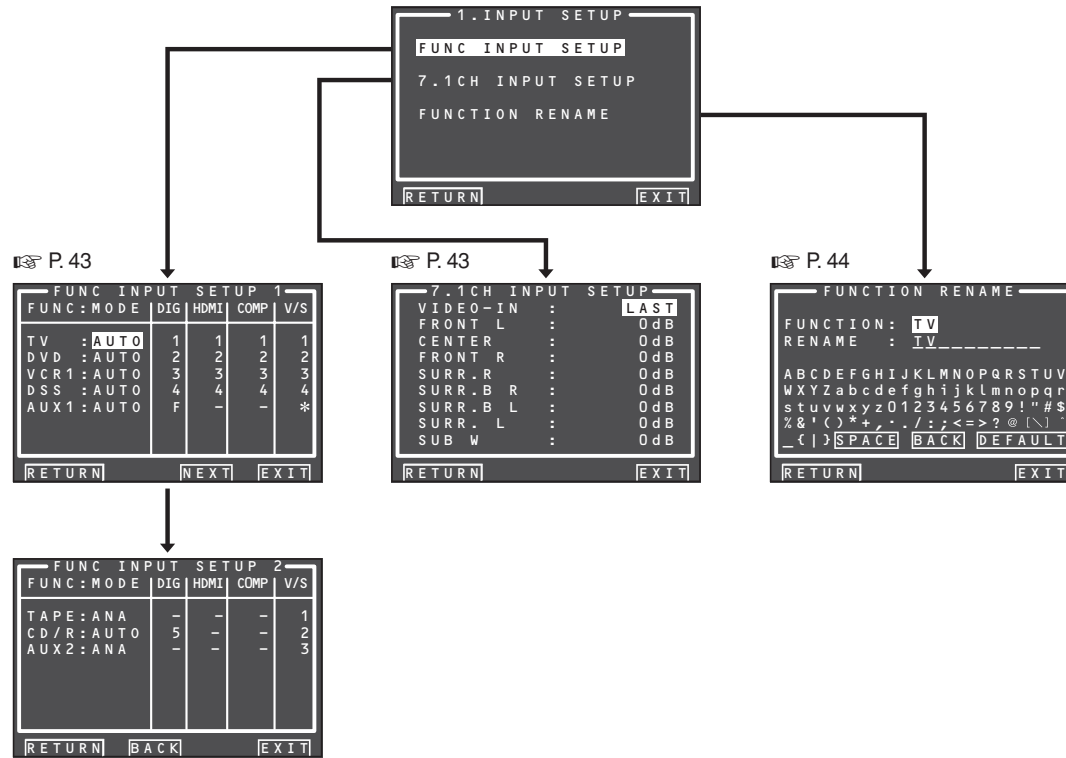



### 1-1 FUNC INPUT SETUP (ASSIGNABLE DIGITAL INPUT)

The 6 and F (Front) digital inputs can be assigned to a desired source.

HDMI and COMPONENT inputs can be assigned to the preferred source.

Use this menu to select which digital input jacks are to be assigned to which input source.

1. Select "FUNC INPUT SETUP" from the 1.INPUT SETUP menu with the ▲ or ▼ cursor buttons and press the **OK/ENTER** button.

FUNC INPUT SETUP 1				
FUNC: MODE	DIG	HDMI	COMP	V/S
TV : AUTO	1	1	1	1
DVD : AUTO	2	2	2	2
VCR1 : AUTO	3	3	3	3
DSS : AUTO	4	4	4	4
AUX1 : AUTO	F	1 & 2	1 & 2	*

[RETURN] [NEXT] [EXIT]

2. Select a setting with the ▲, ▼, ◀, and ▶ cursor buttons, and assign a mode and input jack (DIG, HDMI, COMP, V/S).

#### MODE

##### AUTO:

Select "AUTO", for automatic detection of the digital input signal condition. If there is no digital signal, but there is an analog signal present, the analog signal will be played. "AUTO" is the initial setting of all input sources.

##### HDMI:

Select "HDMI", when only a HDMI signal will be used.

##### DIG:

Select "DIG", when only a digital signal will be used.

##### ANA:

Select "ANA" for input sources for which no digital input jacks are used.

#### DIG

6 and F(Front) digital inputs can be assigned to a desired source.

Assign the number of a digital input jack to the device.

#### HDMI

Assign the number of an HDMI input jack to the device.

#### Note:

- When FUNCTION MODE is set to HDMI and HDMI AUDIO of "5. PREFERENCE" is set to THROUGH, audio is not output from the unit. (See page 54)

#### COMP

Assign the number of a component video input jack to the device.

#### V/S

Assign the number of a composite video and S-video input jack to the device.

#### Note:

- Video and S-video can use the same numbers when assigning to input functions.
- The \* mark in AUX.1 indicates that other inputs cannot be assigned.

3. Press the **OK/ENTER** button.
4. Select each mode setting and input terminal with the ◀ or ▶ cursor buttons.
5. Press the **OK/ENTER** button.
6. Repeat steps 2-5 until all items are set.
7. After you complete this portion of the setup, move the cursor to "NEXT" with the ▲, ▼, ◀, and ▶ cursor buttons and then press the **OK/ENTER** button to go to the next page.

FUNC INPUT SETUP 2				
FUNC: MODE	DIG	HDMI	COMP	V/S
TAPE : ANA	-	-	-	1
CD/R : AUTO	5	-	-	2
AUX2 : ANA	-	-	-	2

[RETURN] [BACK] [EXIT]

8. Repeat steps 2-5 until all items are set. After you complete this portion of the setup, move the cursor to "RETURN" with ▲, ▼, ◀, and ▶ cursor buttons and press the **OK/ENTER** button.

To return to the Func Input Setup 1 menu from the Func Input Setup 2 menu, move the cursor to "BACK" with the ▲, ▼, ◀, and ▶ cursor buttons and press the **OK/ENTER** button.

#### Note:

- Assignments cannot be made in sections with a \* mark.

### 1-2 7.1 CH INPUT SETUP

This menu is for adjusting the speaker levels for 7.1-channel input sources.

Here you will adjust the volume for each channel so that they are all heard by the listener at the same level.

1. Select "7.1 CH INPUT SETUP" from the 1.INPUT SETUP menu with the ▲ or ▼ cursor buttons and press the **OK/ENTER** button.

7.1 CH INPUT SETUP	
VIDEO-IN :	LAST
FRONT L :	0dB
CENTER :	0dB
FRONT R :	0dB
SURR. R :	0dB
SURR. B R :	0dB
SURR. B L :	0dB
SURR. L :	0dB
SUB W :	0dB

[RETURN] [EXIT]

2. Select "VIDEO-IN" with the ▲ or ▼ cursor buttons.
3. Using the ◀ or ▶ cursor buttons, select the video input source to be played through the MONITOR OUT jack.

The input source is switched by pressing the ◀ or ▶ cursor buttons as follows;

LAST ↔ TV ↔ DVD ↔ VCR1 ↔ DSS ↔ AUX1 ↔ V-OFF ↔ LAST ↔...

#### Notes:

- When "LAST" is selected, the source is set to the source selected before the 7.1 ch input menu was activated.
- When "V-OFF" is selected, no signal is emitted from MONITOR OUT jack.

4. Select desired channel with the ▲ or ▼ cursor buttons.
5. Using the ◀ or ▶ cursor buttons, adjust the volume level of each channel.

Move the cursor to "RETURN" with the ▲, ▼, ◀, and ▶ cursor buttons, and press the **OK/ENTER** button to go to the 1.INPUT SETUP menu.

#### Note:

- The volume level can be set between -12 dB and +12 dB in 1 dB increments on all channels except the subwoofer (SUB W), which can be set from -18dB to +12 dB in 1 dB increments.

**1-3 FUNCTION RENAME**

Input sources can be registered under any name. This menu is for renaming input source.

This menu is for renaming function name. Names can be up to 10 characters long, including spaces. (Characters are selected from those appearing on the display.) This name appears on the unit's FL display and the OSD, but it does not appear in the OSD Setup menu.

1. Select "**FUNCTION RENAME**" from the 1. INPUT SETUP menu with the ▲ or ▼ cursor buttons and press the **OK/ENTER** button.

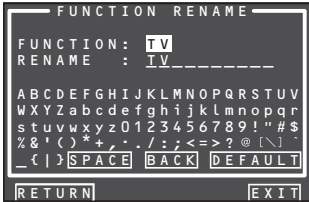

2. Select "**FUNCTION**" with the ▲ or ▼ cursor buttons.
3. Select an input source with the ◀ or ▶ cursor buttons.
4. Select "**RENAME**" with the ▲ or ▼ cursor buttons.
5. Move the cursor to the character (1st to 10th) to change with the ◀ or ▶ cursor buttons.
6. Move the cursor to the character list with the ▼ cursor button. (Move the cursor to the letter "A" to begin with.)
7. Select a character with the ▲, ▼, ◀, and ▶ cursor buttons.
8. Press the **OK/ENTER** button to enter the selected letter.

9. Repeat steps 5-8 until the new name is input.

**BACK:**

Deletes the character left of the cursor in the "**RENAME**" area one character at a time.

**DEFAULT:**

Restores the name in the "**RENAME**" area to the name in the "**FUNCTION**" area.

**SPACE:**

Inserts a space at the cursor point of the "**RENAME**" area.

**Note:**

- RENAME cannot be left blank.

Move the cursor to "**RETURN**" with the ▲, ▼, ◀, and ▶ cursor buttons and press the **OK/ENTER** button to go to the 1. INPUT SETUP menu.

## 2 SPKR (SPEAKER) SETUP

After you have installed the unit connected all the components and determined the speaker layout, it is now time to perform the settings in the Speaker Setup menu for the optimum sound acoustics for your environment and speaker layout.

Before you perform the following settings, it is important that you first determine the following characteristics:

- **AUTO SETUP:**  
 “2-1 AUTO SETUP (MultEQ Setup)”  
 (see page 46)
- **MANUAL SETUP:**  
 “2-2 MANUAL SETUP” (see page 49)
- **THX AUDIO SETUP:**  
 “2-3 THX AUDIO SETUP” (see page 50)

1. Select “2.SPKR SETUP” from the MAIN MENU with ▲ or ▼ cursor buttons and press the **OK/ENTER** button.

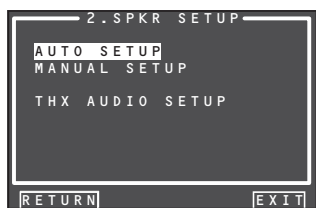

2. Select the desired menu with the ▲ or ▼ cursor buttons, and press the **OK/ENTER** button.

**Note:**

- After you complete this the portion of the setup, press the ▲, ▼, ◀, and ▶ cursor button. The cursor will move to “RETURN” and press the **OK/ENTER** button to go to the Sub-menu.

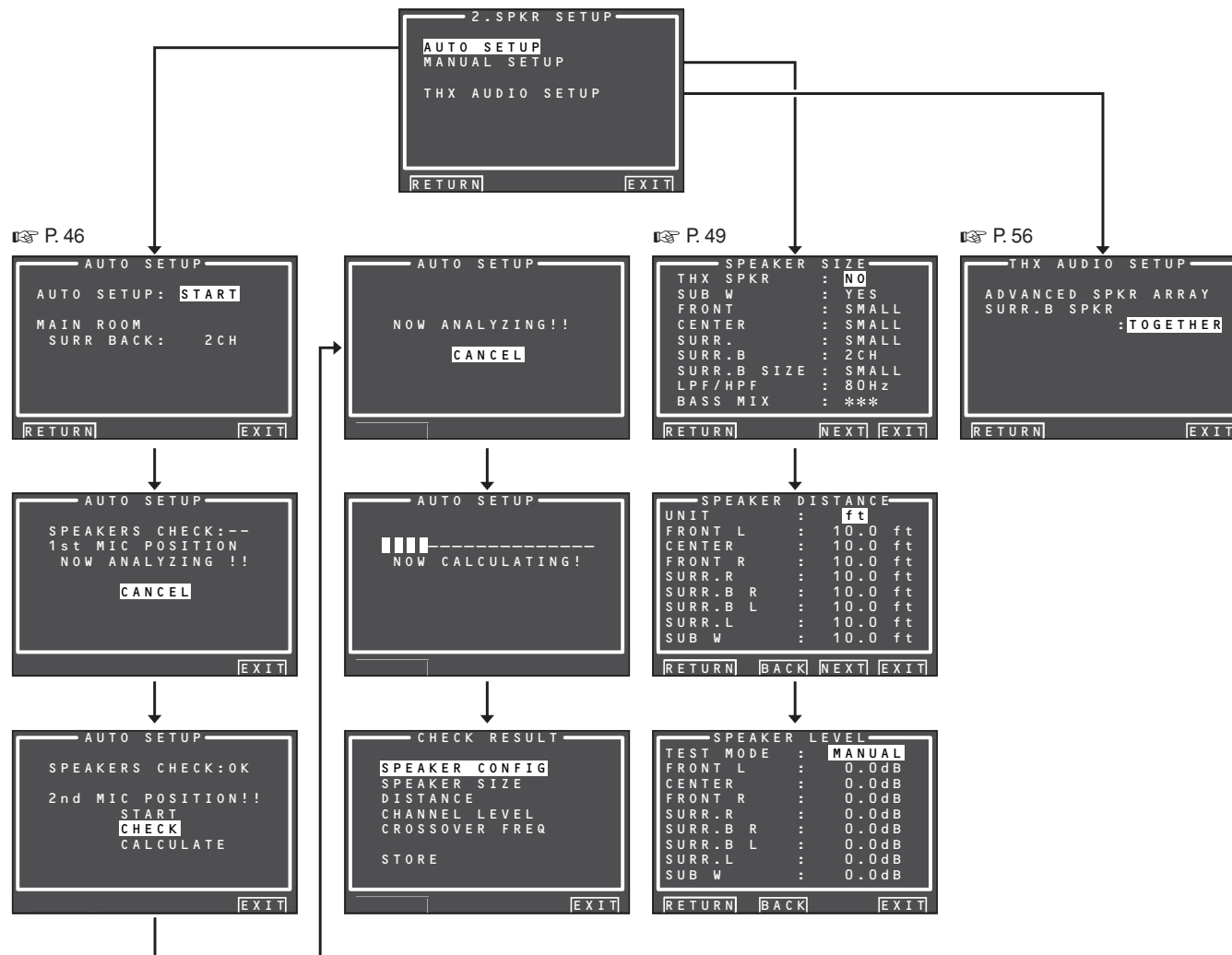

## 2-1 AUTO SETUP (MultEQ™ SETUP)

The AUTO SETUP (MultEQ™ Setup) feature of the unit measures sound characteristics of the speaker system and room where the unit is used and automatically optimizes settings.

The Audyssey MultEQ™ technology adopted by this unit provides the best listening environment for multiple listeners.

To do this, the AUTO SETUP feature measures a test tone emitted by each channel in a maximum of 6 listening positions, using the supplied microphone.

The measurement results are analyzed using an original algorithm and environmental settings are made to improve the sound characteristics of the listening area.

To set up the speaker system (i.e., adjusting speaker distance, etc.) without using the AUTO SETUP feature, see "MANUAL SETUP" on page 49 of the manual.

### HOW TO PERFORM AUTO SETUP

During measurement, the OSD menu displays the condition, therefore turn power to the monitor on.

1. Connect the supplied microphone to the MIC jack on the unit.

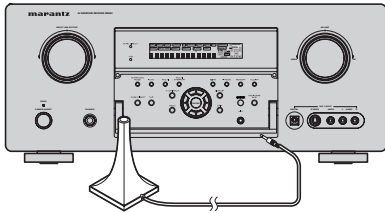

2. Set the microphone in the listening position.

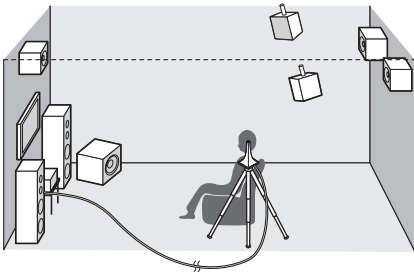

#### Notes:

- Measurement can be done in a maximum of 6 listening positions.
- For the first measurement, set the microphone in the main listening position.

- Use a stand or tripod to position the microphone at ear height in the listening position.
- Remove any obstructions between the speakers and microphone.
- To use the internal subwoofer of the amp, set the volume to the middle point and set the crossover frequency to the highest.
- During measurement, step away from the microphone and operate the unit via the remote controller from a position that is out of the path of the speaker sound.
- The test tone output from the speakers during measurement is loud. Be mindful of neighbors and watch out for small children.

3. Select "2. SPKR SETUP" from the MAIN MENU, select "AUTO SETUP" with the ▲/▼ cursor buttons, and press the **OK/ENTER** button to display the start screen.

4. Select the number of channels for the surround back speaker you are using.

For a 5.1 channel speaker system, select "NON" (Surround Back speaker off). (To use speaker C or multi speaker, select "NON". See page 38, 55.)

Select "START" with the ▲/▼ cursor buttons and press the **OK/ENTER** button to start measurement.



5. 1st Position Check

During the first position check, the following screen is displayed as the unit checks background noise in the listening room, presence of speakers, and speaker polarity and measures the acoustical characteristics in the first position where the microphone is set up.

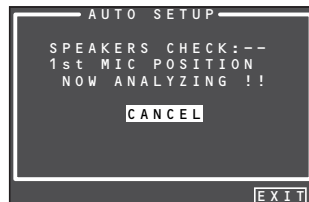

#### Note:

- The detection check measures the state of use of all speakers whether actually used or not.

For example, if the center speaker is not used, the test tone will require time to go from the L-channel to the R-channel, therefore be careful not to unplug the microphone or operate this unit during this time.

6. When the 1st Position Check ends, the following OSD appears on the display.

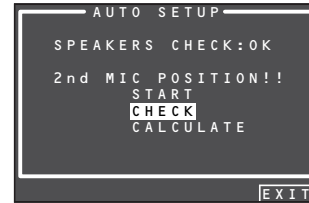

Here, to view the results of the detection check, select "CHECK" with the ▲/▼ cursor buttons and press the **OK/ENTER** button. The results will be displayed.

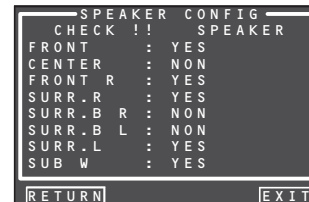

If the check results indicate an error, take suitable action with that item and remeasure. (For error messages, see "ERROR MESSAGES" on page 48.)

After confirming the check results, select "RETURN" with the ▲/▼ cursor buttons and press the **OK/ENTER** button to return to the OSD menu.

At this point, you can select "EXIT" to end Auto Setup and return to "2. SPKR SETUP".

#### Note:

- AUTO SETUP is not available in Pure Direct, Source Direct, or 7.1 Channel Input modes.

7. Move the microphone to the second listening position, select "START" with the ▲/▼ cursor buttons and press the **OK/ENTER** button to measure the second point. At this point, you can cancel second point measurement and calculate measurement results by selecting "CALCULATE" and pressing the **OK/ENTER** button.



8. Repeat steps 7 until measuring 6 points between the main listening position and surrounding positions.

When all measurements end, the following OSD appears on the display.

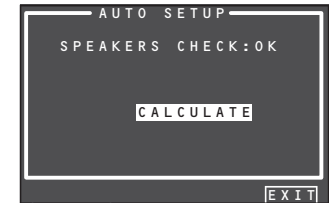

Select "CALCULATE" with the ▲/▼ cursor buttons and press the **OK/ENTER** button to calculate measurement results. During calculations, the following OSD appears on the display.

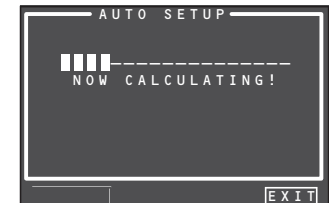

#### Note:

- Less than 6 positions can be measured, but it is recommended to measure in all 6 positions in order to obtain the best results.
- The time needed to complete calculations depends on the number of connected speakers and measured listening positions. The more speakers and listening positions, the more time is needed.

### 9. Checking Measurement Results

When calculations for the measurement results end, a screen appears for confirming the calculation results.



Select items to check with the ▲/▼ cursor buttons and press the **OK/ENTER** button to enter them.

**Note:**

To check equalizer (MultEQ) parameters, see page 57.

**[Example]** Confirmation screen for speaker detection

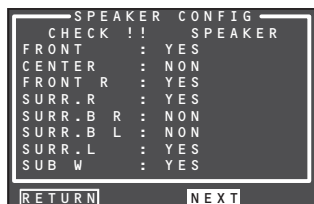

**[Example]** Confirmation screen for the distance from speakers to the listening position

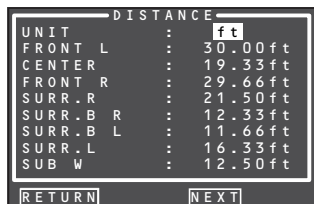

\* The units can be changed by moving the cursor to [ft] of UNIT and pressing ◀/▶ the cursor buttons. Each time a ◀/▶ cursor button is pressed, the units alternate between [ft] (feet) and [m] (meters).

**[Example]** Confirmation screen for speaker size and crossover frequency

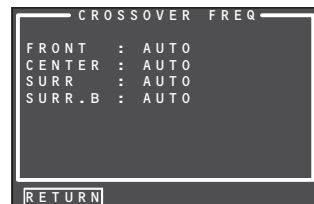
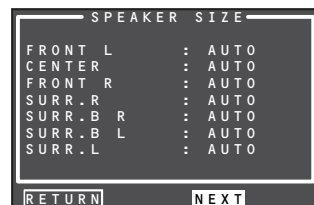

\* AUTO is displayed to indicate that the speaker size and crossover frequency results were automatically measured.

### 10. Storing Measurement Results in Memory

Once finished confirming the measurement results, select **RETURN** with the ▲/▼ cursor buttons and press the **OK/ENTER** button to display the CHECK RESULT screen.

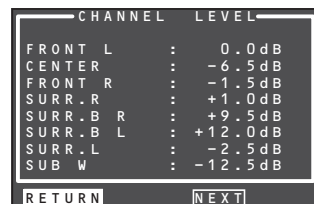

Place the cursor on **STORE** and press the **OK/ENTER** button to store all parameters including the equalizer parameters in memory. If not wanting to store the calculation results in memory, place the cursor on **EXIT** and press

the **OK/ENTER** button.

**Note:**

Pressing **EXIT** prior to pressing **STORE** erases all measurement results and calculation results, therefore operate the remote controller with care.

When storing operations end, the following OSD appears on the display.

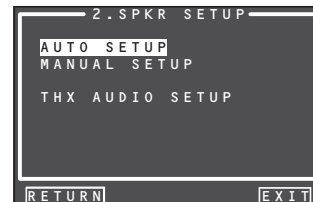

**Notes:**

- Do not turn the power to the unit off while storing parameters in memory. This may erase all data in the unit's memory and may damage the unit.
- Please set any THX Certified speakers manually to "Small" and the crossover "80 Hz" after Auto setup operation.

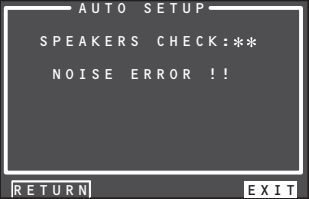
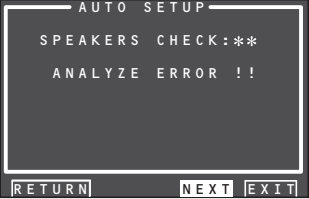
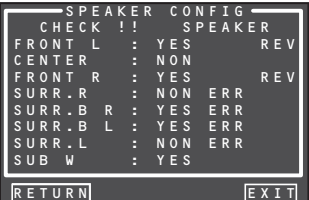

ERROR MESSAGES

Displayed Error	Cause	How to Remedy
<p>MIC SET ERROR!!</p> 	<ul style="list-style-type: none"> <li>The microphone is not properly connected.</li> </ul>	<ul style="list-style-type: none"> <li>Connect the included microphone.</li> <li>Check the microphone connection.</li> </ul>
<p>NOISE ERROR!!</p> 	<ul style="list-style-type: none"> <li>There is too much noise in the listening room to measure properly.</li> <li>Volume from the speakers is low.</li> </ul>	<ul style="list-style-type: none"> <li>During measurement, turn off devices that make noise such as air conditioners.</li> <li>Measure at a time when the surrounding area is quiet.</li> </ul>
<p>ANALYZE ERROR!!</p>  <p>* Under ANALYZE ERROR, select "NEXT" with the ▲/▼ cursor buttons and press the <b>OK/ENTER</b> button. A detail screen like the following appears on the display.</p> 	<ul style="list-style-type: none"> <li>The speakers required for suitable playback were not detected.</li> <li>Speaker polarity is connected backwards.</li> </ul> <p>In the examples at left, the following trouble is detected.</p> <ul style="list-style-type: none"> <li>The polarity of the left and right channels of the front speakers is backwards ([REV] appears on the display.)</li> <li>The surround speaker is not connected ([NON] is displayed), but the surround back speaker is connected (In this kind of situation, [ERR] is displayed for all surround and surround back speakers.)</li> </ul> <p>An error is indicated in addition to the above if the speakers are connected as follows.</p> <ul style="list-style-type: none"> <li>When using just one surround back speaker, but it is connected to the surround back R-channel (To use just one surround back speaker, connect it to the L-channel.)</li> </ul>	<ul style="list-style-type: none"> <li>Check the speaker that is indicated as having reversed polarity ([REV] can appear with some speakers even when properly connected. In such case, ignore the error indication.)</li> <li>Check speaker direction and layout</li> </ul>

## 2-2 MANUAL SETUP

1. Select "2. SPKR SETUP" from the MAIN MENU.
2. Select "MANUAL SETUP" with the ▲ or ▼ cursor buttons.
3. Press the **OK/ENTER** button to enter the selection.

### <SPEAKER SIZE>



When setting the speaker size in the SPEAKER SIZE menu, use the guidelines below.

#### LARGE:

The complete frequency range for the channel you are setting will be output from the speaker.

#### SMALL:

Frequencies of the channel you are setting that are lower than approx. 80 Hz will be output from the subwoofer.

If the SUB. W is set to "NONE" and the front speakers are set to "LARGE," then the sound will be output from both the left and right speakers.

4. Select each speaker with the ▲ or ▼ cursor buttons.
5. Set the size of each speaker with the ◀ or ▶ cursor buttons.
6. After you complete this portion of the setup, move the cursor to "NEXT" with the ▲, ▼, ◀ and ▶ cursor buttons and press the **OK/ENTER** button to go to the next page.

#### THX SPKR

If you are using a full THX speaker systems which are approved by THX Ltd:

- The front, center and surround speaker size should be "SMALL".
- The subwoofer should be "YES".
- LPF/HPF (the crossover frequency) should be "80Hz".

You need to set the number of surround back speakers and the surround back speaker size should be "SMALL".

#### SUB W

##### YES:

Select when a subwoofer is connected.

##### NO:

Select when a subwoofer is not connected.

#### FRONT

##### LARGE:

Select if the front speakers are large.

##### SMALL:

Select if the front speakers are small.

- If "NO" is selected for the subwoofer setting, then this setting is fixed at "LARGE".

#### CENTER

##### NONE:

Select if no center speaker is connected.

##### LARGE:

Select if the center speaker is large.

##### SMALL:

Select if the center speaker is small.

#### SURR.

##### NONE:

Select if no surround left and right speakers are connected.

##### LARGE:

Select if the surround left and right speakers are large.

##### SMALL:

Select if the surround left and right speakers are small.

#### SURR. B

##### NONE:

Select if no surround back left and right speakers are connected.

##### 2CH:

Select if the surround back left and right speakers are connected.

##### 1CH:

Select if one surround back speaker is connected. In this case, the audio signal is emitted from the SURR BACK LEFT output terminal.

#### Notes:

- If "NONE" is selected for the SURR. setting, then this setting is fixed to "NONE."

#### SURR. BACK SIZE

##### LARGE:

Select if the surround back speakers are large.

##### SMALL:

Select if the surround back speakers are small.

#### Note:

- If "NONE" is selected for the SURR. setting, then this setting is not available.

#### LPF/HPF

When you use a subwoofer, you can select the cutoff frequency for the small speakers used. Select one of the crossover frequency levels according to the size of the small speakers connected.

60Hz → 80Hz → 100Hz → 120Hz → 140Hz → 160Hz → 180Hz

#### Note:

- If using small front speakers, set a slightly higher frequency. If using large front speakers, set a slightly lower frequency.

#### BASS MIX

- The bass mix setting is only valid when "LARGE" is set for the front speakers and "YES" is set for the subwoofer during stereo playback.

This setting has effect only during playback of PCM or analog stereo sources.

- When "BOTH" is selected, the low frequencies will be played through the main L&R speakers and the subwoofer.

In this playback mode, the low frequency range expands more uniformly throughout the room, but depending on the size and shape of the room, interference may result in a decrease of the actual volume of the low frequency range.

- By selecting "MIX", the low frequencies will play through the main L&R only. This selection is preferred by THX.

#### Note:

- LFE signals during playback of Dolby Digital or DTS will be played through the subwoofer.

7. After you complete this portion of the setup, move the cursor to "NEXT" with the ▲, ▼, ◀ and ▶ cursor buttons and press the **OK/ENTER** button to go to the next page.

### <SPEAKER DISTANCE>

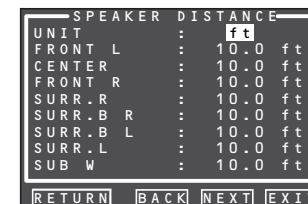

Use this menu to specify the distance of each speaker's position from the listening position. The delay time is automatically calculated according to these distances.

Begin by determining the ideal or most commonly used seating position in the room.

This is important for the timing of the acoustics to create the proper sound space that the unit and today's sound systems are able to produce.

#### Note:

- For speakers for which you have selected "NONE", the speaker configuration sub-menu will not appear here. (There are several useful books and special DVD and LD's available to guide you through proper home theater configuration. If you are unsure, have your Marantz dealer perform the installation for you. They are trained professionals familiar with even the most sophisticated custom installations. Marantz recommends the [www.cedia.org](http://www.cedia.org) website for further information.)

8. Select either **m** (meters) or **ft** (feet) for UNIT with the ◀ or ▶ cursor buttons.

9. Select each speaker with the ▲ or ▼ cursor buttons.

10. Set the distance for each speaker, press the ◀ or ▶ cursor buttons.

#### FRONT L:

Set the distance from the front left speaker to your normal listening position.

#### CENTER:

Set the distance from the center speaker to your normal listening position.

#### FRONT R:

Set the distance from the front right speaker to your normal listening position.

#### SURR. L:

Set the distance from the surround left speaker to your normal listening position.

#### SURR. R:

Set the distance from the surround right speaker to your normal listening position.

**SUB W:**

Set the distance from the subwoofer to your normal listening position.

**SURR. B L:**

Set the distance from the surround back left speaker to your normal listening position.

**SURR. B R:**

Set the distance from the surround back right speaker to your normal listening position.

**Notes:**

- Set the distance to each speaker in meters (m) or feet (ft) as follows.  
m: 0.03 - 9.15 m in 0.03 m steps  
ft: 0.1 - 30.0 ft in 0.1 ft steps  
(The values appearing on the FL display are approximate.)
- For the speakers that you have selected “NONE” the speaker size menu will not appear.
- The setting for surr.back L and surr.back R appears if it is set, two surround back speakers in the SPEAKER SIZE menu.
- The setting of SURR. BACK appears if it is set for one surround back speaker in the SPEAKER SIZE menu.

11. After you complete this portion of the setup, move the cursor to “NEXT” with the ▲, ▼, ◀ and ▶ cursor buttons and press the OK/ENTER button to go to the next page.

<SPEAKER LEVEL>

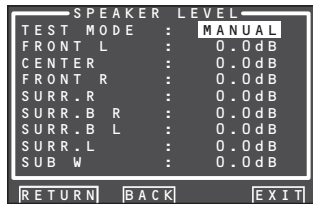

Here you can set the volume for each speaker so that they are all heard by the listener at the same level. We recommend holding a dB SPL (Sound Pressure Level) meter at the listening position, at arms length, and pointing straight up at the ceiling, adjust the level of each speaker in turn until it reads 75dB SPL when the meter is set to “C” weighting and Slow response.

**Note:**

- The speaker level settings are not available in 7.1 Channel Input mode, Pure Direct mode and Source Direct mode.

**TEST MODE:**

Select “MANUAL” or “AUTO” generation of the test tone with the ◀ or ▶ cursor buttons.

If you select “AUTO”, the test tone will be cycled through in a circular pattern beginning at **Left → Center → Right → Surround Right → Surround Back Right → Surround Back Left → Surround Left → Subwoofer → Left**, in 2 seconds increments for each channel.

Using the ◀ or ▶ cursor buttons, adjust the volume level of the noise from the speaker so that it is the same level for all the speakers.

If you select “MANUAL”, adjust the output level of each speaker as listed below.

12. Move the cursor to FRONT L by pressing the ▼ cursor button. This unit will emit a pink noise from the front left speaker.

Remember the level of this noise and then press the ▼ cursor button.

(Note that this can be adjusted to any level between -12 and +12 dB in 0.5 dB increments.)

This unit will now emit the pink noise from the center speaker.

13. Using the ◀ and ▶ cursor buttons, adjust the volume level of the noise from the center speaker so that it is the same level as the front left speaker.

14. Press the ▼ cursor button again. This unit will now emit the pink noise from the front right speaker.

15. Repeat steps 13 and 14 for the front right and other speakers until all speakers are adjusted to the same volume level.

After you complete this portion of the setup, press the OK/ENTER button to move the cursor to “RETURN”. Press the OK/ENTER button to go to “2. SPKR SETUP”.

**Notes:**

- Speakers for which you selected “NONE” in the SPEAKER SIZE menu will not appear.
- Surr. Back L and Surr. Back R appear if it is set for two surround back speakers in the SPEAKER SIZE menu.
- Surr. Back appears if it is set for one surround back speaker in the SPEAKER SIZE menu.
- To adjust the speaker levels for 7.1 channel input sources, you will need to use the 7.1 Ch Input sub menu. (See page 51)
- SUB W can be set from -18dB to +12dB.

**2-3 THX AUDIO SETUP**

You can set the advanced Speaker Array.

1. Select “2. SPEAKER SETUP” from the MAIN MENU.
2. Select “THX AUDIO SETUP” with the ▲ or ▼ cursor buttons.
3. Press the OK/ENTER button to enter the selection.



**Advanced Speaker Array (ASA)**

**SURR.B SPKR: TOGETHER, CLOSE or APART**

The best ASA effect is when the surround back speakers are together and facing forward.

If the distance between the surround back speakers is,

- Less than **12 in.** (30 cm): TOGETHER
- Greater than **12 in.** (30 cm), and less than **48 in.** (122 cm): CLOSE
- Greater than **48 in.** (122 cm): APART

**Speaker type and positioning**

This diagram shows the desired positioning for 7.1 channel speaker systems used in ASA mode. During system setup, select the distance between surround back speakers.

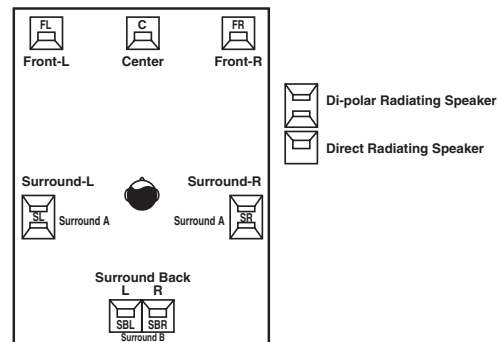

**Note:**

- If you set SURR.B = 1CH or NONE in the SPEAKER SIZE menu, Advanced Speaker Array will not be activated.

After you complete this portion of the setup, move the cursor to “RETURN” with ▲, ▼, ◀ and ▶ cursor buttons and press OK/ENTER button to go to the 2. SPKR SETUP menu.

### 3 SURROUND SETUP

This menu is for setting surround effect parameters for the various surround input signals so as to bring out the live audio effect of your speaker system.

- **CHANNEL LEVEL:**  
“3-1 CHANNEL LEVEL” (see page 51)
- **PLIIX MUSIC PARAMETER:**  
“3-2 PLIIX MUSIC PARAMETER” (see page 52)
- **CSII PARAMETER:**  
“3-3 CSII PARAMETER” (see page 52)
- **NEO:6 PARAMETER:**  
“3-4 NEO:6 PARAMETER” (see page 52)

1. Select “3. SURR SETUP” from the MAIN MENU with the ▲ or ▼ cursor buttons and press the **OK/ENTER** button.
2. Select the desired menu with the ▲ or ▼ cursor buttons and press the **OK/ENTER** button.

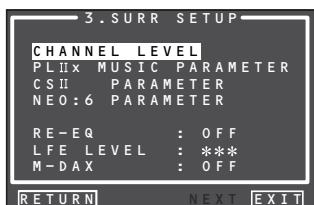

**RE-EQ:**

Turns THX Cinema Re-EQ™ on and off. Select the Cinema Re-EQ™ with the ◀ or ▶ cursor button to activate it.

**LFE LEVEL:**

Select the output level of the LFE signal included in the Dolby Digital signal or the DTS signal. Select “0dB”, “-10 dB” or “OFF” with ◀ or ▶ cursor button.

**M-DAX:**

Select the desired M-DAX mode. Select “HIGH”, “LOW” or “OFF” with the ◀ or ▶ cursor button. (See page 59)

After you complete this portion of the setup, move the cursor to “RETURN” with the ▲, ▼, ◀, ▶ cursor buttons and press the **OK/ENTER** button.

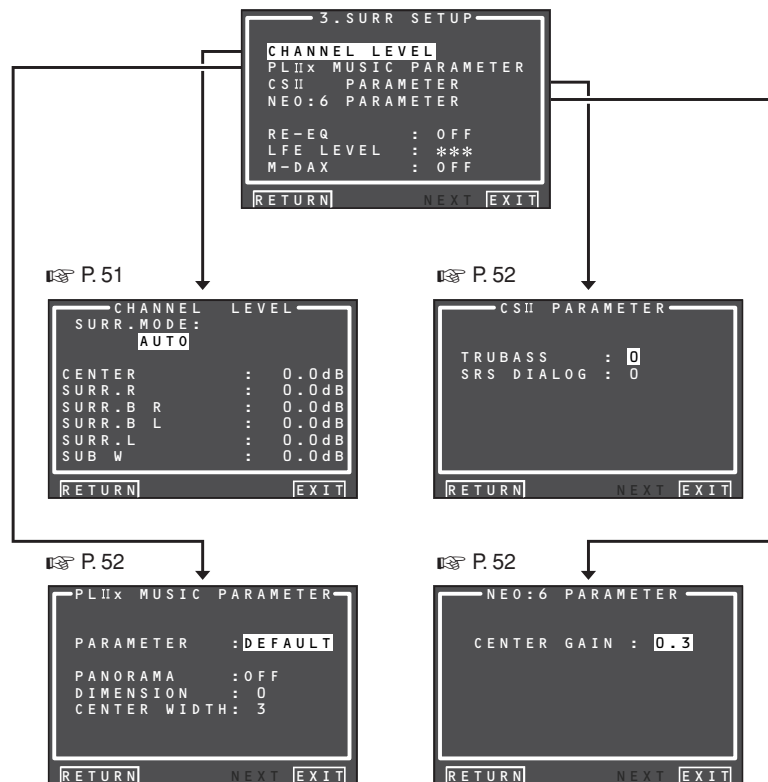

### 3-1 CHANNEL LEVEL

1. Select “3. SURR SETUP” from MAIN MENU with ▲ or ▼ cursor buttons and press the **OK/ENTER** button.
2. Select “CHANNEL LEVEL” with the ▲ or ▼ cursor buttons and press the **OK/ENTER** button.
3. Set the SURR. MODE with the ◀ or ▶ cursor buttons.

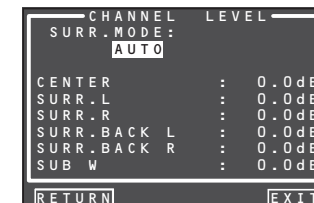

4. Select the desired menu item with the ▲ or ▼ cursor buttons, set the desired level with the ◀ or ▶ cursor buttons, and press the **OK/ENTER** button.

**SURROUND MODE:**

The surround mode can be independently set for 3 modes.

1. Multi Ch STEREO
2. CSII
3. Others

**CHANNEL LEVEL**

**CENTER LEVEL:**

Set the effect level of the center speaker between -12 and +12 level in 0.5 level interval .

- If “NONE” was selected for the center speaker setting in the SPEAKER SIZE, then this setting will not appear.

**SURR L or R LEVEL:**

Set the effect level of the Surround speaker between -12 and +12 level in 0.5 level interval .

- If “NONE” was selected for the surround speakers setting in the SPEAKER SIZE, then this setting will not appear.

**SURR. BACK L or R LEVEL:**

Set the effect level of the Surround Back speaker between -12 and +12 level in 0.5 level interval .

- If “NONE” was selected for the surround back speakers setting in the SPEAKER SIZE, then this setting will not appear.

**SUB W LEVEL:**

Set the effect level of the subwoofer speaker between **-18** and **+12** level in 0.5 level interval .

- If **"NONE"** was selected for the subwoofer speaker setting in the **SPEAKER SIZE**, then this setting will not appear.

**Note:**

- Setting to a mode other than multichannel stereo or CSII will affect the speaker level as explained in "2-2 MANUAL SETUP".

After you complete this portion of the setup, move the cursor to **"RETURN"** with the **▲**, **▼**, **◀** and **▶** cursor buttons and press the **OK/ENTER** button to go to the **3. SURR SETUP** menu.

**3-2 PLIIx (PRO LOGIC IIx) MUSIC PARAMETER**

Pro LogicIIx-Music mode creates a rich and enveloping surround ambience from stereo sources such as CDs.

In this mode, this unit includes three controls to fine-tune the sound field as follows.

1. Select **"3. SURR SETUP"** in MAIN MENU with **▲** or **▼** cursor buttons and press the **OK/ENTER** button.
2. Select **"PLIIx MUSIC PARAMETER"** with the **▲** or **▼** cursor buttons.
3. Press the **OK/ENTER** button to enter the selection.

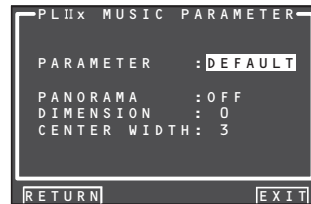
**PARAMETER:**

Select **"DEFAULT"** or **"CUSTOM"** with the **◀** or **▶** cursor buttons.

If you select **"CUSTOM"**, you can adjust three parameters as listed below.

**PANORAMA:**

Select the PANORAMA mode **"ON"** or **"OFF"** with the **◀** or **▶** cursor buttons.

Panorama wraps the sound of the front left and right speakers around you, for an exciting perspective.

**DIMENSION:**

Set the DIMENSION level between **-3** and **+3** level in 1 level intervals with the **◀** or **▶** cursor buttons.

Adjust the sound field either towards the front or towards the rear.

This can be useful to help achieve a more suitable balance from all the speakers with certain recordings.

**CENTER WIDTH:**

Set the CENTER WIDTH level between **0** and **7** in 1 level intervals with the **◀** or **▶** cursor buttons.

Center width allows you to gradually spread the center channel sound into the front left and right speakers.

At its widest setting, all the sound from the center is mixed into the left and right speakers.

This control may help achieve a more spacious sound or a better blend for the front image.

If **"NONE"** was selected for the center speaker

setting in the **SPEAKER SIZE** menu, this setting cannot be selected.

After you complete this portion of the setup, move cursor to **"RETURN"** with the **▲**, **▼**, **◀** and **▶** cursor buttons and press the **OK/ENTER** button.

**3-3 CSII PARAMETER**

1. Select **"3. SURROUND SETUP"** from MAIN MENU with the **▲** or **▼** cursor buttons and press the **OK/ENTER** button.
2. Select **"CS II PARAMETER"** with the **▲** or **▼** cursor buttons.
3. Press the **OK/ENTER** button to enter the selection.

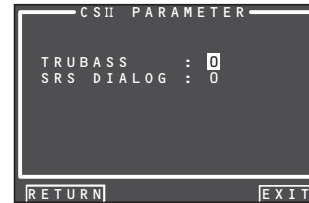
**TRUBASS:**

Set the TRUBASS level between **0** and **6** in 1- level increments with the **◀** or **▶** cursor buttons.

TRUBASS produced by the speakers are an octave below the actual physical capabilities of the speakers adding exciting, deeper bass effects.

**SRS DIALOG:**

Set the SRS DIALOG level between **0** and **6** in 1- increments with the **◀** or **▶** cursor buttons.

This can be popped out of the surround audio effects, allowing the listener to easily discern what the actors say.

If **"NONE"** was selected for the center speaker setting in the **SPEAKER SIZE** menu, this setting cannot be selected.

After you complete this portion of the setup, move cursor to **"RETURN"** with the **▲**, **▼**, **◀** and **▶** cursor buttons and press the **OK/ENTER** button.

**Note:**

- This parameter can only be set in the CSII mode.

**3-4 NEO:6 PARAMETER**

The DTS NEO:6 mode enables a maximum 6.1 channel output with just 2 channel input. (It also supports 5.1 channel input.)

This mode expands the sound image from the center channel.

1. Select **"3. SURROUND SETUP"** from MAIN MENU with the **▲** or **▼** cursor buttons and press the **OK/ENTER** button.
2. Select **"NEO:6 PARAMETER"** with the **▲** or **▼** cursor buttons.
3. Press the **OK/ENTER** button to enter the selection.

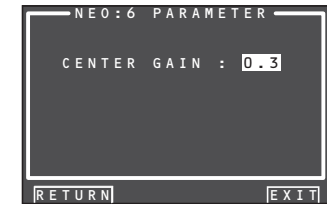

4. Set the CENTER GAIN level between 0.0 and 1.0 in 0.1 level increments with the **◀** or **▶** cursor buttons.

After you complete this portion of the setup, move cursor to **"RETURN"** with the **▲**, **▼**, **◀** and **▶** cursor buttons and press the **OK/ENTER** button.

**Notes:**

- This parameter can only be set in the NEO:6-Music mode.
- If **"NONE"** was selected for the center speaker setting in the **SPEAKER SIZE** menu, this setting is disabled.



## 4 VIDEO SETUP

Video settings are made as follows.

1. Select "4. VIDEO SETUP" from the MAIN MENU with the ▲/▼ cursor buttons and press the **OK/ENTER** button.



2. Select the desired menu with the ▲/▼ cursor buttons and press the **OK/ENTER** button.

- **VIDEO CONVERT**

"4-1 VIDEO CONVERT"

- **TV-AUTO**

Select the TV AUTO ON/OFF function to enable or disable with the ◀ or ▶ cursor buttons. (refer to page 66)

- **OSD INFO**

Select the OSD information function to "ENABLE" or "DISABLE" with the ◀ or ▶ cursor buttons. If you select "ENABLE", this unit will display the status of the feature (Volume up/down, input select, etc.) on the monitor. If you do not desire this information, select "DISABLE".

**Note:**

- OSD information is not output to Monitor Output of HDMI and Component Video. However, OSD information is output if the Video Convert function is used to output Video or S-Video video signals to Monitor Out of HDMI and Component Video.

For details, refer to "VIDEO CONVERT" on page 59.

- **IP CONVERT**

Select the IP CONVERT ON/OFF function to enable or disable with the ◀ or ▶ cursor buttons. (refer to page 59)

- **HDMI OUT**

This setting is for selecting which output terminal, HDMI 1 or HDMI 2, to output the signal to. Select the output destination with the ◀ / ▶ cursor buttons.

To use the remote controller (RC8001SR) to change the HDMI OUT setting, press the **AMP** button and then the > button until the second page is displayed. After HDMI 1 or HDMI 2 is displayed on the remote controller, press the **D3** or **D4** button to switch between them.



- **COMPONENT OUT 2**

(This feature is not available on the SR7002.)

This setting is for selecting whether to output the images for the main room or the images for the multi room system to the COMPONENT MONITOR OUT 2 terminal. Select the output destination between MAIN and MULTI with the ◀ / ▶ cursor buttons.

**Note:**

- When MULTI is selected, video signals converted from the MONITOR OUT 2 terminal are not output.

After you complete this portion of the setup, move cursor to "RETURN" with the ▲, ▼, ◀ and ▶ cursor buttons and press the **OK/ENTER** button.

## 4-1 VIDEO CONVERT

This unit is equipped to convert video signals for monitor output.

This section explains how to set up conversion for each type of video input.

1. Select "4. VIDEO SETUP" from the MAIN MENU with the ▲ / ▼ cursor buttons and press the **OK/ENTER** button.

2. Select "VIDEO CONVERT" with the ▲ / ▼ cursor buttons and press the **OK/ENTER** button.



3. Select "FUNCTION" with the ▲ / ▼ cursor buttons and set the video conversion mode with the ◀ / ▶ cursor buttons

**ANA&HDMI:**

This mode both up-converts and down-converts analog video signals (Composite Video, S-Video, Component Video). Furthermore, it up-converts from analog video signal to HDMI. (It cannot down-convert from HDMI digital video signals to analog video signals.)

**ANA ONLY:**

This mode both up-converts and down-converts analog video signals (Composite Video, S-Video, Component Video). It does not up-convert to HDMI.

**OFF:**

This mode turns off all conversion features.

**Note:**

- For details on video convert feature, see page 59.

## 5 PREFERENCE

- **MULTI ROOM SETUP :**  
"5-1 MULTI ROOM SETUP" (see page 55)
- **DC TRIGGER SETUP :**  
"5-2 DC TRIGGER SETUP" (see page 55)

1. Select "**5. PREFERENCE**" from MAIN MENU with the ▲ or ▼ cursor buttons and press the **OK/ENTER** button.

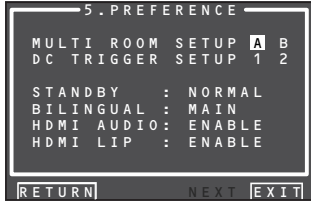

2. Select the desired menu with the ▲ or ▼ cursor buttons and press the **OK/ENTER** button.

**STAND BY:**

When this is set to "**ECONOMY**", you can reduce the power consumption when the unit is in the Standby mode. When "**ECONOMY**" is selected, "**TV AUTO**" and "**RS-232C**" are disabled when the unit is in the Standby mode.

**BILINGUAL:**

In the Bilingual mode, Dolby Digital and DTS output is set to either "**MAIN**" or "**SUB**". Select "**BILINGUAL**" with the ◀ or ▶ cursor buttons, then select **MAIN** ↔ **SUB** ↔ **MAIN+SUB** with the ◀ or ▶ cursor buttons.

**HDMI AUDIO:**

This setting determines whether to play back audio input to the HDMI jacks through the unit or output it through the unit to a TV or projector.

**ENABLE:** The audio input to the HDMI jacks can be played back by this unit. In such case, audio signals are not output to the TV or projector.

**THROUGH:** The audio input to the HDMI jacks is not output from the speaker terminals of the unit. Audio data is output directly to the TV or projector. This setting is used to listen to audio on a multi channel TV, etc.

After you complete this portion of the setup, move the cursor to "**RETURN**" with the ▲, ▼, ◀ and ▶ cursor buttons and press the **OK/ENTER** button.

**HDMI LIP (Auto Lipsync Correction):**

Video signals may take longer to process than audio signals depending on the connected video equipment.

When the unit is connected to TV or Projector supporting Auto Lipsync Correction in HDMI 1.3a, audio and video can be automatically synchronized using this function.

Use the ◀ or ▶ cursor buttons to switch between **ENABLE** and **DISABLE**.

**ENABLE:** Auto Lipsync Correction is used to synchronize audio and video.

**DISABLE:** Deactivates this function.

**Note:**

- This function is not available when the unit is connected to equipment that does not support HDMI 1.3a or Auto Lipsync Correction. For details, check the user's manual of the connected equipment.
- If this function is unavailable, you can use the regular lipsync function to synchronize audio and video. (See page 66)

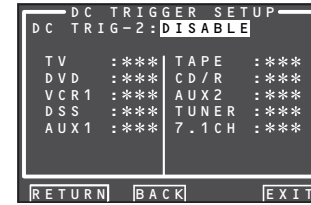
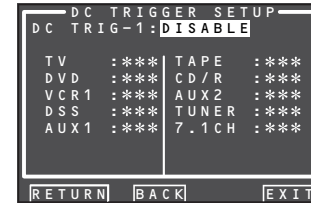
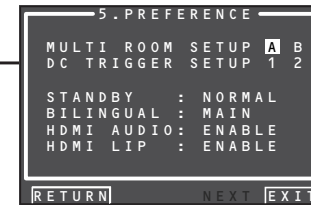

(The SR7002 is not equipped with the MULTI ROOM SETUP B feature)

## 5-1 MULTI ROOM SETUP

The SR8002 has source selectors, sleep timers and multispeaker output remote controller for the two other rooms in the multi room system. (The SR7002 has only one other room in the multi-room system.) These features can be set from this menu.

1. Select "5. PREFERENCE" from the MAIN MENU with the ▲ or ▼ cursor buttons and press the **OK/ENTER** button.
2. Select "MULTI ROOM SETUP" with the ▲ or ▼ cursor buttons and select either "Room A" or "Room B" with the ◀ or ▶ cursor buttons.
3. Press the **OK/ENTER** button to enter the setting.

The following explanation shows how to operate MULTI ROOM A of the multi-room system. The MULTI ROOM B setting does not have the VIDEO FUNCTION. (The SR7002 does not have a MULTI ROOM B setting)



4. Select the desired item with the ▲ or ▼ cursor button.

### VIDEO:

Select the video source of the multiroom output with the ◀ or ▶ cursor buttons.

### AUDIO:

Select the audio source of the multiroom output with the ◀ or ▶ cursor buttons.

### SLEEP:

The sleep mode is available when the multiroom is active, set the time with ◀ or ▶ cursor buttons. The sleep timer can be set to a maximum 90 minutes in 10 minute increments.

### MONO/ST:

This mode switches audio output to the multi room system between MONAURAL and STEREO, using the ◀ and ▶ cursor buttons.

### OSD INFO:

With this function, on-screen display information is shown on connected TVs or other devices when you switch input functions. Select "ENABLE" with the ◀ or ▶ cursor buttons to enable OSD INFO or "DISABLE" to disable it. Select "DISABLE" if this function is not needed.

### MULTI (MULTI ROOM):

Switch the multiroom output "ON" or "OFF" with the ◀ or ▶ cursor buttons.

### MSPK (MULTI SPEAKER):

Switch the speaker output "ON" or "OFF" with the ◀ or ▶ cursor buttons.

### VOL (VOLUME SETUP):

Select whether the multiroom or multi speaker output level is variable or fixed with the ◀ or ▶ cursor buttons.

### LEVEL (VOLUME LEVEL):

Adjust the multiroom output level with the ◀ or ▶ cursor buttons. The volume can be set between -90 dB and 0 dB in 1 dB increments.

### Note:

- This setting can be changed when the SURR B is set to "NONE" in the SPEAKER SIZE menu and "SPEAKER C" is in the OFF position on the rear panel. When this setting is unavailable, "\*\*\*" is displayed.
- If "VOLUME" is set to "FIXED", the multiroom output level cannot be adjusted from the A or B room.
- MSPK cannot be on for both Room A and Room B at the same time. After you complete this portion of the setup, move the cursor to "RETURN" with the ▲ or ▼ cursor buttons and press the **OK/ENTER** button.

## 5-2 DC TRIGGER SETUP

This unit has 2 DC trigger control jacks, which can be used to link with input functions for the main room or multiroom.

Each trigger can be setup separately.

1. Select "5. PREFERENCE" from MAIN MENU with the ▲ or ▼ cursor buttons and press the **OK/ENTER** button.
2. Select "DC TRIGGER SETUP 1or 2" with the ▲, ▼, ◀ and ▶ cursor buttons.
3. Press the **OK/ENTER** button to enter the selection.

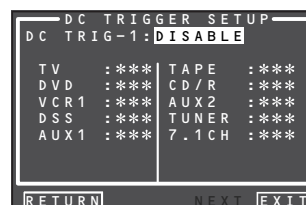

4. You can select "MAIN ROOM", "MULTI ROOM A", "MULTI ROOM B", "REMOTE" or "DISABLE" with the ◀ or ▶ cursor buttons. (The SR7002 does not have a MULTI ROOM B setting)

### Note:

- REMOTE is available for the external control. The RC8001SR cannot operate the function.

5. Select desired input source with the ▲ or ▼ cursor buttons.
6. Set to "ON" or "OFF" with the ◀ or ▶ cursor buttons.
7. After you complete this portion of the setup, move the cursor to "RETURN" with the ▲ or ▼ cursor button and press the **OK/ENTER** button.

### Note:

- When an input source that is on in the set room is selected, voltage is output to the DC TRIGGER output terminal.

## 6 ACOUSTIC EQ

This display is for setting up the equalizer and changing the Equalizer mode.

- **PRESET G. EQ ADJ :**  
"6-1 PRESET G. EQ ADJ" (see page 57)
- **CHECK AUTO 1 & 2 :**  
"6-2 CHECK AUTO" (see page 57)

### EQ MODE:

There are 4 equalizer modes to choose from: PRESET G. EQ that allows the user to manually adjust the equalizer, and AUDYSSEY, FRONT and FLAT that automatically adjust the equalizer from the measurement results of the AUTO SETUP feature (see page 46).

### AUDYSSEY:

This mode adjusts the frequency characteristics of all speakers so as to create the best listening environment for the sound characteristics of the listening room.

### FRONT:

This mode matches the characteristics of each speaker to those of the front speakers.

### FLAT:

This mode flattens the frequency characteristics of all speakers. It is suited for playback of multichannel music such as Dolby Digital and DTS.

### PRESET:

This mode adjusts the graphic equalizer that was set in PRESET G.EQ ADJ to adjust the characteristics of each speaker (see page 57).

### OFF:

The graphic equalizer is not used.

1. Select "6. ACOUSTIC EQ" from MAIN MENU with the ▲ or ▼ cursor buttons and press the OK/ENTER button.

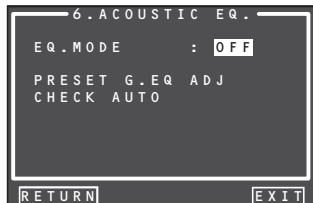

2. Select "EQ. MODE" with the ▲ or ▼ cursor buttons.

3. Select "FRONT", "FLAT", "AUDYSSEY", "PRESET" or "OFF" with the ◀ or ▶ cursor buttons.

After you complete this portion of the setup, move the cursor to "RETURN" with the ▲, ▼, ◀ and ▶ cursor buttons and press the OK/ENTER button.

To use the remote controller (RC8001SR) to change the EQ MODE, press the AMP button and then the > button until the second page is displayed. When EQ is displayed on the remote controller, press the EQ (D5) button.

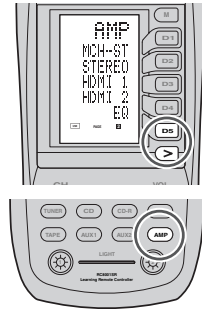

Each time this button is pressed, the EQ MODE changes as follows.

OFF → FRONT → FLAT → AUDYSSEY → PRESET

### Notes:

- "FRONT", "FLAT" and "AUDYSSEY" can be selected after executing the AUTO SETUP feature.
- If a speaker that was determined "NON" in Auto Setup is manually turned on, the "AUDYSSEY", "FRONT" and "FLAT" modes cannot be selected.
- The equalizer turns off when the Pure Direct mode, Source Direct mode, Dolby Headphone or Virtual mode is set.
- ACOUSTIC EQ MODEs are not used during playback of Dolby TrueHD, Dolby Digital Plus, or DTS-HD signals.
- Tone Control is disabled when an EQ MODE is in use.

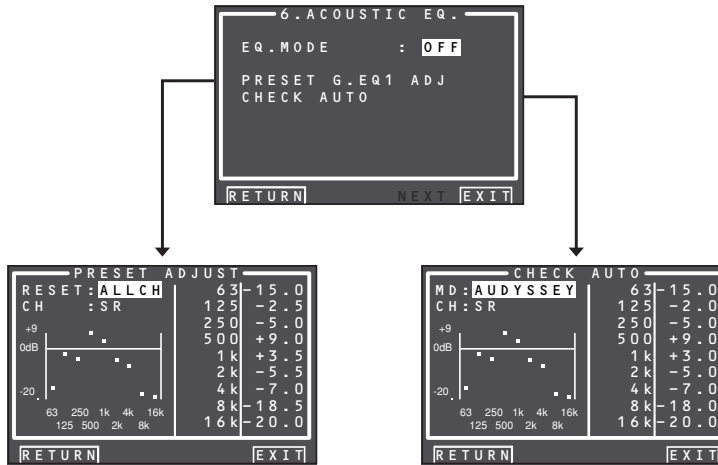

### 6-1 PRESET G. EQ ADJ

These modes allow you to set a 9-band graphic equalizer for each of the 7 channels.

1. Select “**6. ACOUSTIC EQ**” from MAIN MENU with the ▲ or ▼ cursor buttons and press the **OK/ENTER** button.
2. Select “**PRESET G. EQ ADJ**” with the ▲ or ▼ cursor buttons.
3. Press the **OK/ENTER** button to enter the selection.



#### RESET:

Using the ◀ or ▶ cursor buttons, select the channel(s) to be reset to either the currently displayed channel (“CH”) or all channels (“ALL”), and press the **OK/ENTER** button to enter the setting.

“ALL” : Resets all channels.

“CH” : Resets only the currently displayed channel.

#### CH:

Select the channel (“FL”, “C”, “FR”, “SR”, “SBR”, “SBL” or “SL”) to adjust with the ◀ or ▶ cursor buttons, and switch to the adjustment mode with the ▼ cursor button.

#### Frequency:

Select the target frequency on the graph with the ◀ or ▶ cursor buttons and press the **OK/ENTER** button to enter the selection. Adjust the level with the ▲ or ▼ cursor buttons. (Note that this can be adjusted to any level between -20 and +9 dB in 0.5 dB increments.)

Move to the next frequency with the ◀ or ▶ cursor buttons, and adjust the level.

After you complete this portion of the setup, press the **OK/ENTER** button to enter the settings. Move cursor to “**RETURN**” with the ▲, ▼, ◀ and ▶ cursor buttons and press the **OK/ENTER** button.

### 6-2 CHECK AUTO

These menus are for confirming the results of AUTO SETUP function equalizer measurement (AUDYSSEY, FRONT, FLAT).

1. Select “**6. ACOUSTIC EQ**” from MAIN MENU with the ▲ or ▼ cursor buttons and press the **OK/ENTER** button.
2. Select “**CHECK AUTO**” with the ▲ or ▼ cursor buttons.
3. Press the **OK/ENTER** button to enter the selection.

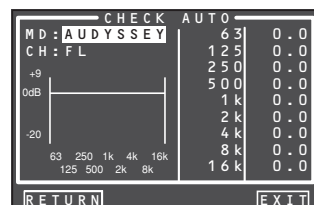

Select MD (mode) with the ▲ / ▼ cursor buttons followed by the desired equalizer (“AUDYSSEY”, “FRONT”, “FLAT”).

#### CH:

Select the channel to check with the ◀ or ▶ cursor buttons.

#### Notes:

- The frequency will not be exactly the same as in the Preset G. EQ modes.
- FL and FR are not indicated on the CHECK AUTO 2 menu.

4. Once finished checking, select “**RETURN**” with the ▲ / ▼ cursor buttons and press the **OK/ENTER** button to return to the “6. ACOUSTIC EQ” menu.



# BASIC OPERATION

## (PLAY BACK)

### SELECTING AN INPUT SOURCE

Before you can listen to any input media, you must first select the input source on the unit.

#### Example : DVD

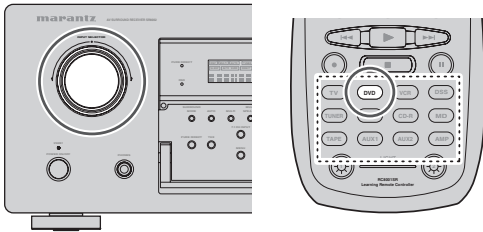

To select DVD, turn the **INPUT SELECTOR** knob on the front panel or press the **DVD** button on the remote controller two times in a row. After you have selected DVD, simply turn on the DVD player and play the DVD.

- As the input source is changed, the new input name will appear momentarily on the video display. The input name will also appear in the display, on the front-panel.
- If you use the **FUNCTION RENAME** feature (see page 44), the renamed name appears on the display.
- As the input is changed, this unit will automatically switch to the digital input, surround mode, attenuation, and night mode status which were entered during the configuration process for that source.
- When a video source is selected, the selected video signal is output from the **MONITOR OUT** terminal.

### SELECTING THE SURROUND MODE

#### Example: AUTO SURROUND

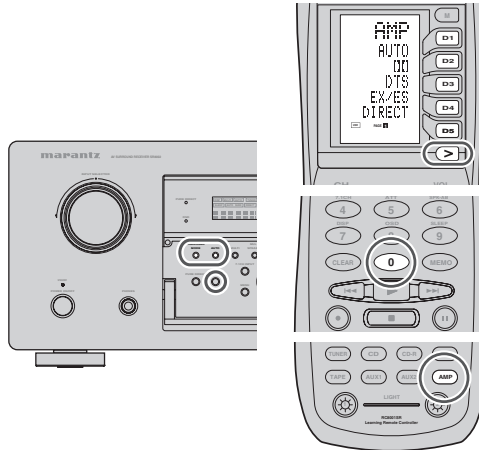

#### (Using the unit)

To select the Auto surround mode during playback, press the **AUTO** button on the front panel.

#### (Using the remote controller)

To select the Auto surround mode, press the **AMP** button and press the **>** button until **PAGE1** is displayed. Press the **AUTO (D1)** button.

- For surround modes, see "Surround Mode" on page 60.
- To add the THX mode to the Auto Surround mode, press either the **THX** button on the unit or the **THX** button on the remote controller.
- To select a specific surround mode, Press the individual surround mode button on page 1.2 on the remote controller.

### IALOGUE NORMALIZATION MESSAGE

Dialogue Normalization (Dial Norm) is a feature of Dolby Digital.

When playing back software which has been encoded in Dolby Digital, sometimes you may see a brief message on the FL display which will read "D-NORM X dB" (X being a numeric value).

Dialogue Normalization serves to let you know if the source material has been recorded at a higher or lower level than usual. For example, if you see the following message: "D-NORM + 4 dB" on the FL display, to keep the overall output level constant just turn down the volume control by 4 dB. In other words, the source material that you are listening to has been recorded 4 dB louder than usual.

If you do not see a message on the FL display, then no adjustment of the volume control is necessary.

### NIGHT MODE

Useful at night or when loud noise is undesirable, this mode compresses the dynamic range, making it easier to hear quieter audio content without increasing the overall volume.

Note that the effect of night mode is determined by the Dolby Digital content. Night mode may have no effect with content that does not support this function.

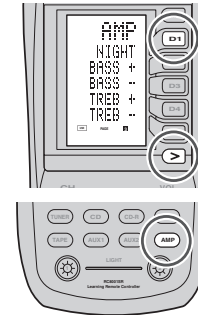

1. To select this mode, press the **AMP** button on the remote controller, and then press the **>** button until **PAGE3** is displayed.
2. Each time the **NIGHT (D1)** button is pressed, the mode changes according to the following options indicated on the front of the unit.

- **AUTO Mode**

N I G H T   A U T O

AUTO mode is available when decoding Dolby TrueHD signals.

When night mode is activated, "NIGHT" is illuminated on the front of the unit. (See page 9)

- **NIGHT Mode ON**

N I G H T   O N

Setting the Night mode to "ON" compresses the dynamic range in Dolby Digital only.

- **NIGHT Mode OFF**

N I G H T   O F F

Turn off the Night mode.

### ADJUSTING THE MAIN VOLUME

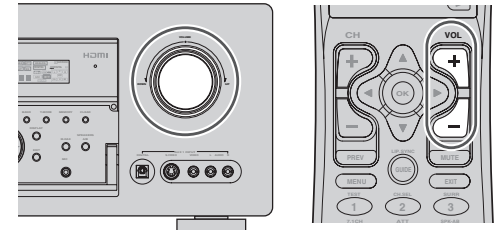

Adjust the volume to a comfortable level using the **VOLUME** control knob on the front panel or **VOLUME ▲ / ▼** buttons on the remote controller.

To increase the volume, turn the **VOLUME** knob clockwise or press **VOLUME ▲** button on the remote, to decrease the volume, turn counterclockwise or press **VOLUME ▼** button on the remote controller.

#### Notes:

- The volume can be adjusted within the range of  $-\infty$  to 18 dB, in steps of 1 dB.
- However, when the channel level is set as described on page 51, if the volume for any channel is set at +1 dB or greater, the volume cannot be adjusted up to 18 dB. (In this case the maximum volume adjustment range is "18 dB - Maximum value of channel level")

**ADJUSTING THE TONE (BASS & TREBLE) CONTROL**

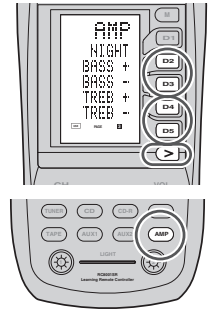

During a listening session you may wish to adjust the Bass and Treble Control to suit your listening tastes or room acoustics.

**(Using the remote controller)**  
To adjust the tone, press the **AMP** button and press the > button PAGE3 is displayed.  
To adjust the bass effect, press **BASS+ (D2)** or **BASS- (D3)**.  
To adjust the treble effect, **TREB+ (D4)** or **TREB- (D5)**.

- Notes:**
- The tone control function is unavailable for the Source Direct, Pure Direct, Headphone, Dolby Virtual Speaker, THX mode, and 176.4/192kHz PCM.
  - The tone control function is not available when ACOUSTIC EQ is being used.
  - Additionally, tone control is not available during Dolby TrueHD, Dolby Digital Plus, or DTS-HD playback.

**TEMPORARILY TURNING OFF THE SOUND**

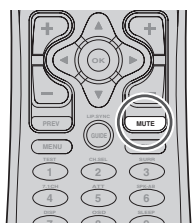

To temporarily silence all speaker outputs such as when interrupted by a phone call, press the **MUTE** button on the remote controller. This will interrupt the output to all speakers and the head-phone jack, but it will not affect any recording or dubbing that may be in progress. When the system is muted, the display will show "MUTE". Press the **MUTE** button again to return to normal operation.

**USING THE SLEEP TIMER**



To program this unit for automatic standby, press the **SLEEP** button on the remote controller. Each press of the button will increase the time before shut down in the following sequence.

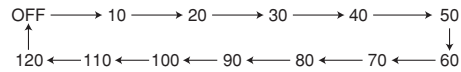

The sleep time will be shown for a few seconds in the display on the front panel, and it will count down until the time has elapsed. When the programmed sleep time has elapsed, the unit will automatically turn off. Note that the SLEEP indicator on the display will illuminate when the Sleep function is programmed. To cancel the Sleep function, press the **SLEEP** button until the display shows "SLEEP OFF" and the SLEEP indicator will disappear.

**M-DAX (Marantz Dynamic Audio eXpander)**

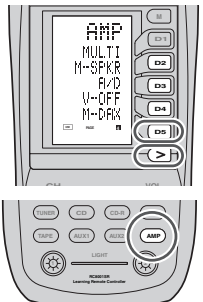

This function makes up for lost audio content in MP3 or AAC sources (from lossy compression) during playback. Choose one of the following levels for this effect as desired.  
"HIGH": Stronger effect  
"LOW": Weaker effect  
"OFF": Deactivated.

**(Using the remote controller)**  
When switching to M-DAX mode, press the AMP button and then the > button until the PAGE 4 is displayed.  
When "M-DAX" is displayed on the remote controller, press the **M-DAX (D5)** button. Each time this button is pressed, M-DAX changes as follows.

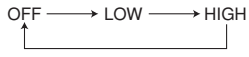

- Notes:**
- M-DAX is compatible with PCM (48 kHz or lower) and two-channel analog sources.
  - The M-DAX is not available when Dolby Virtual Speaker mode is being used.

**VIDEO CONVERT**

**ANALOG VIDEO CONVERSION**  
This unit is equipped to convert video signals for monitor output. Because of this, indifferent of the connection (VIDEO, S-VIDEO, COMPONENT VIDEO) between the playback device and this unit, listening and viewing are possible with a single higher grade cable between the MONITOR OUT terminal of the unit and the monitor.

**UP-CONVERSION FROM ANALOG VIDEO SIGNALS TO HDMI**

The up-conversion feature of this unit can output the input analog video signals (for component video signals of 480i, 480p, 1080i and 720p resolution, and S-Video and Video (composite) of 480i resolution) to the HDMI MONITOR terminal.

- Notes:**
- HDMI video input is only output to the HDMI MONITOR OUT terminal of the unit. If connecting a playback device such as a DVD player to the HDMI input jack, connect the HDMI MONITOR OUT terminal of the unit to a TV monitor.
  - This mode is unavailable for the REC out terminal.
  - This mode is unavailable for still picture, fast forward and reverse play on video component.
  - If, while attempting to use the video convert feature, the unit cannot synchronize with the display device, "NO SIGNAL" appears on the monitor or noise is generated, this feature cannot be used. All of these signs are caused by equipment incompatibility; there is nothing wrong with the unit.

If this occurs, set "VIDEO CONVERT" in the "VIDEO SETUP" menu to "DISABLE". Next, connect the video input signal to the display component via the MONITOR OUT terminal under VIDEO and the S-video input signal to the display component via the MONITOR OUT terminal under S-VIDEO.

- The video convert feature constantly monitors input video signals and determines whether to convert the input signals or not. However, some input video signals cannot be detected correctly. If this occurs, set "VIDEO CONVERT" in the "VIDEO SETUP" menu to "DISABLE".
- For optimal video performance, THX recommends setting the "VIDEO CONVERT" mode "DISABLE".

**CONNECTION EXAMPLE**

- When a monitor is connected to the HDMI MONITOR OUT terminal of the unit

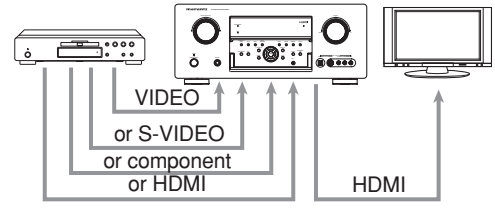

- Notes:**
- If the resolution of the component video signal input from the playback device is other than 480i, 480p, 1080i or 720p, images are not output from the HDMI MONITOR OUT terminal of the unit.
  - If the resolution of the S-Video or Video signal input from the playback device is other than 480i, images are not output from the HDMI MONITOR OUT terminal of the unit.

- When a monitor is connected to the VIDEO or S-VIDEO MONITOR OUT terminals of the unit

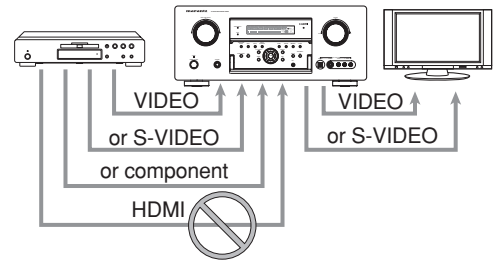

Notes:

- The HDMI video signal input from the playback device is not output from the VIDEO or S-VIDEO MONITOR OUT terminals of the unit.
- If the resolution of the component video signal input from the playback device is other than 480i, it is not output from the VIDEO or S-VIDEO MONITOR OUT terminals of the unit.

- When a monitor is connected to the COMPONENT VIDEO MONITOR OUT terminal of the unit

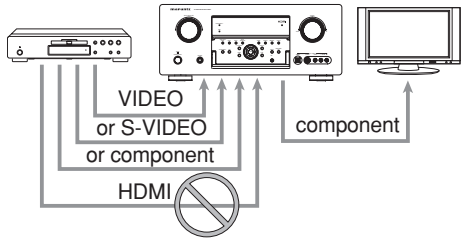

Notes:

- The HDMI video signal input from the playback device is not output from the COMPONENT VIDEO MONITOR OUT terminal of the unit.

Notes of OSD menu system:

- The setup menu can be displayed through all video out terminals (“HDMI”, “COMPONENT”, “SVIDEO” and “VIDEO”).

- OSD information is output only to the VIDEO and S-VIDEO MONITOR OUT terminals.

OSD information is also output when the video conversion feature is on and the video signal input to the VIDEO or S-VIDEO input jack of the unit is converted and output from the COMPONENT VIDEO or HDMI MONITOR OUT terminals.

I/P CONVERT

The video circuit of the unit is equipped with an I/P conversion feature.

When this feature is on, 480i analog video signals (VIDEO, S-VIDEO or COMPONENT VIDEO) input from a playback device can be converted to 480p and progressively output to the COMPONENT VIDEO or HDMI MONITOR OUT terminals of the unit.

(For setting instructions, see page 53)

SURROUND MODE

This unit is equipped with many surround modes. These are provided to reproduce a variety of surround sound effects, according to the content of the source to be played.

The available surround modes may be restricted depending on the input signal and speaker setup.

The relationship between the selected surround mode and the input signal

The surround mode is selected with the surround mode selector on the unit or the remote controller. However, the sound you hear is subject to the relationship between the selected surround mode and the input signal. That relationship is as follows:

Surround Mode	Input Signal	Decoding	Output Channel					Front information display		
			L/R	C	SL SR	SBL SBR	SubW	Signal format indicators	Channel status	
AUTO	Dolby Surr.EX	Dolby Digital EX	○	○	○	○	○	□ DIGITAL EX	L, C, R, SL, SR, S, LFE	
	Dolby D (5.1ch)	Dolby Digital 5.1	○	○	○	-	○	□ DIGITAL	L, C, R, SL, SR, LFE	
	Dolby D (2ch)	Dolby Digital 2.0	○	-	-	-	○	□ DIGITAL	L, R	
	Dolby D (2ch Surr)	Pro Logic IIx movie	○	○	○	-	○	□ DIGITAL □ SURROUND	L, R, S	
	Dolby Digital Plus (5.1ch)	Dolby Digital +	○	○	○	-	○	□ DIGITAL	L, C, R, SL, SR, LFE	
	Dolby Digital Plus (6.1ch)	Dolby Digital +	○	○	○	-	○	□ DIGITAL	L, C, R, SL, SR, S, LFE	
	Dolby Digital Plus (7.1)	Dolby Digital +	○	○	○	-	○	□ DIGITAL	L, C, R, SL, SR, S, LFE	
	Dolby TrueHD (5.1ch)	Dolby TrueHD	○	○	○	-	○	□ DIGITAL	Depend on speaker setup	
	Dolby TrueHD (6.1ch)	Dolby TrueHD	○	○	○	-	○	□ DIGITAL	Depend on speaker setup	
	Dolby TrueHD (7.1ch)	Dolby TrueHD	○	○	○	-	○	□ DIGITAL	Depend on speaker setup	
	DTS-ES	DTS-ES	○	○	○	-	○	dts, ES	L, C, R, SL, SR, S, LFE	
	DTS 96/24	DTS-96/24	○	○	○	-	○	dts 96/24	L, C, R, SL, SR, LFE	
	DTS (5.1ch)	DTS 5.1	○	○	○	-	○	dts	L, C, R, SL, SR, LFE	
	DTS-HD (5.1)	DTS-HD	○	○	○	-	○	dts	L, C, R, SL, SR, LFE	
	DTS-HD (6.1)	DTS-HD	○	○	○	-	○	dts	L, C, R, SL, SR, S, LFE	
	DTS-HD (7.1)	DTS-HD	○	○	○	-	○	dts	L, C, R, SL, SR, S, LFE	
	Multi Ch-PCM	Multi Ch-PCM	○	○	○	-	○	PCM	L, C, R, SL, SR, LFE	
	Multi Ch-PCM 96kHz	Multi Ch-PCM 96kHz	○	○	○	-	○	PCM	L, C, R, SL, SR, LFE	
	SA-CD (5.1ch)	Multi Ch-PCM	○	○	○	-	○	DSD	L, C, R, SL, SR, LFE	
	SA-CD (2ch)	PCM (Stereo)	○	-	-	-	○	DSD	L, R	
	PCM (Audio)	PCM (Stereo)	○	-	-	-	○	PCM	L, R	
	PCM 96kHz	PCM (Stereo 96kHz)	○	-	-	-	○	PCM	L, R	
	HDCCD	HDCCD	○	-	-	-	○	PCM, HDCCD	L, R	
	Analog	Stereo	○	-	-	-	○	ANALOG	-	
	7.1ch input	Multi Ch	○	○	○	○	○	ANALOG	-	
	SOURCE DIRECT PURE DIRECT	Dolby Surr.EX	Dolby Digital EX	○	○	○	-	○	□ DIGITAL EX	L, C, R, SL, SR, S, LFE
		Dolby D (5.1ch)	Dolby Digital 5.1	○	○	○	-	○	□ DIGITAL	L, C, R, SL, SR, LFE
		Dolby D (2ch)	Dolby Digital 2.0	○	-	-	-	○	□ DIGITAL	L, R
		Dolby D (2ch Surr)	Pro Logic IIx movie	○	○	○	-	○	□ DIGITAL □ SURROUND	L, R, S
		Dolby Digital Plus (5.1)	Dolby Digital +	○	○	○	-	○	□ DIGITAL	L, C, R, SL, SR, LFE
Dolby Digital Plus (6.1)		Dolby Digital +	○	○	○	-	○	□ DIGITAL	L, C, R, SL, SR, S, LFE	
Dolby Digital Plus (7.1)		Dolby Digital +	○	○	○	-	○	□ DIGITAL	L, C, R, SL, SR, S, LFE	
Dolby TrueHD (5.1)		Dolby TrueHD	○	○	○	-	○	□ DIGITAL	Depend on speaker setup	
Dolby TrueHD (6.1)		Dolby TrueHD	○	○	○	-	○	□ DIGITAL	Depend on speaker setup	
Dolby TrueHD (7.1)		Dolby TrueHD	○	○	○	-	○	□ DIGITAL	Depend on speaker setup	
DTS-ES		DTS-ES	○	○	○	-	○	dts, ES	L, C, R, SL, SR, S, LFE	
DTS 96/24		DTS-96/24	○	○	○	-	○	dts 96/24	L, C, R, SL, SR, LFE	
DTS (5.1ch)		DTS 5.1	○	○	○	-	○	dts	L, C, R, SL, SR, LFE	
DTS-HD (5.1)		DTS-HD	○	○	○	-	○	dts	L, C, R, SL, SR, LFE	
DTS-HD (6.1)		DTS-HD	○	○	○	-	○	dts	L, C, R, SL, SR, S, LFE	
DTS-HD (7.1)		DTS-HD	○	○	○	-	○	dts	L, C, R, SL, SR, S, LFE	
Multi Ch-PCM		Multi Ch-PCM	○	○	○	-	○	PCM	L, C, R, SL, SR, LFE	
Multi Ch-PCM 96kHz		Multi Ch-PCM 96kHz	○	○	○	-	○	PCM	L, C, R, SL, SR, LFE	
SA-CD (5.1ch)		SA-CD (5.1ch)	○	○	○	-	○	DSD	L, C, R, SL, SR, LFE	
SA-CD (2ch)		SA-CD (2ch)	○	-	-	-	○	DSD	L, R	
PCM (Audio)		PCM (Stereo)	○	-	-	-	○	PCM	L, R	
PCM 96kHz		PCM (Stereo 96kHz)	○	-	-	-	○	PCM	L, R	
HDCCD		HDCCD	○	-	-	-	○	PCM, HDCCD	L, R	
Analog		Stereo	○	-	-	-	○	ANALOG	-	
7.1ch input		Multi Ch	○	○	○	○	○	ANALOG	-	
EX/ES		Dolby Surr.EX	Dolby Digital EX	○	○	○	-	○	□ DIGITAL EX	L, C, R, SL, SR, S, LFE
		Dolby D (5.1ch)	Dolby Digital EX	○	○	○	-	○	□ DIGITAL	L, C, R, SL, SR, LFE
		Dolby Digital Plus (5.1)	Dolby Digital +	○	○	○	-	○	□ DIGITAL	L, C, R, SL, SR, LFE
		Dolby TrueHD (5.1)	Dolby TrueHD	○	○	○	-	○	□ DIGITAL	Depend on speaker setup
		DTS-ES	DTS-ES	○	○	○	-	○	dts, ES	L, C, R, SL, SR, S, LFE
	DTS (5.1ch)	DTS-ES	○	○	○	-	○	dts	L, C, R, SL, SR, LFE	
	Multi-PCM	Multi Ch-PCM + Dolby Digital EX	○	○	○	-	○	PCM	L, C, R, SL, SR, LFE	
SA-CD (5.1ch)	Multi Ch-PCM + Dolby Digital EX	○	○	○	-	○	DSD	L, C, R, SL, SR, LFE		

Surround Mode	Input Signal	Decoding	Output Channel					Front information display	
			L/R	C	SL SR	SBL SBR	SubW	Signal format indicators	Channel status
DOLBY (PLIIX movie) (PLIIX music) (PLIIX game)	Dolby Surr.EX	Dolby Digital EX	○	○	○	-	○	DD DIGITAL EX	L, C, R, SL, SR, S, LFE
	Dolby D (5.1ch)	Dolby Digital 5.1	○	○	○	-	○	DD DIGITAL	L, C, R, SL, SR, LFE
	Dolby D (5.1ch)	Dolby Digital 5.1 + PLIIX	○	○	○	○	○	DD DIGITAL	L, C, R, SL, SR, LFE
	Dolby D (2ch)	Pro Logic IIx	○	○	○	○	○	DD DIGITAL	L, R
	Dolby D (2ch Surr)	Pro Logic IIx	○	○	○	○	○	DD DIGITAL DD SURROUND	L, R, S
	Dolby Digital Plus (5.1)	DolbyDigital +	○	○	○	-	○	DD DIGITAL	L, C, R, SL, SR, LFE
	Dolby Digital Plus (6.1)	DolbyDigital +	○	○	○	-	○	DD DIGITAL	L, C, R, SL, SR, S, LFE
	Dolby Digital Plus (7.1)	DolbyDigital +	○	○	○	-	○	DD DIGITAL	L, C, R, SL, SR, S, LFE
	Dolby TrueHD (5.1)	DolbyTrueHD	○	○	○	-	○	DD DIGITAL	Depend on speaker setup
	Dolby TrueHD (6.1)	DolbyTrueHD	○	○	○	-	○	DD DIGITAL	Depend on speaker setup
	Dolby TrueHD (7.1)	DolbyTrueHD	○	○	○	-	○	DD DIGITAL	Depend on speaker setup
	Multi Ch-PCM	Multi Ch-PCM + PLIIX	○	○	○	○	○	PCM	L, C, R, SL, SR, LFE
	SA-CD (5.1ch)	Multi Ch-PCM + PLIIX	○	○	○	○	○	DSD	L, C, R, SL, SR, LFE
	SA-CD (2ch)	Pro Logic IIx	○	○	○	○	○	DSD	L, R
	PCM (Audio)	Pro Logic IIx	○	○	○	○	○	PCM	L, R
	HDCD	Pro Logic IIx	○	○	○	○	○	PCM, HDCD	L, R
	Analog	Pro Logic IIx	○	○	○	○	○	ANALOG	-
	DTS (Neo:6 Cinema) (Neo:6 Music)	DTS-ES	DTS 5.1	○	○	○	-	○	dtc, ES
DTS 96/24		DTS-96/24	○	○	○	-	○	dtc 96/24	L, C, R, SL, SR, LFE
DTS (5.1ch)		DTS 5.1	○	○	○	-	○	dtc	L, C, R, SL, SR, LFE
DTS-HD(5.1)		DTS-HD	○	○	○	-	○	dtc	L, C, R, SL, SR, LFE
DTS-HD(6.1)		DTS-HD	○	○	○	-	○	dtc	L, C, R, SL, SR, S, LFE
DTS-HD(7.1)		DTS-HD	○	○	○	-	○	dtc	L, C, R, SL, SR, S, LFE
Dolby D (2ch)		Neo:6	○	○	○	○	○	DD DIGITAL	L, R
Dolby D (2ch Surr)		Neo:6	○	○	○	○	○	DD DIGITAL DD SURROUND	L, R, S
SA-CD (2ch)		Neo:6	○	○	○	○	○	DSD	L, R
PCM (Audio)		Neo:6	○	○	○	○	○	PCM	L, R
HDCD		Neo:6	○	○	○	○	○	PCM, HDCD	L, R
Analog		Neo:6	○	○	○	○	○	ANALOG	-
CSII Cinema CSII Music CSII Mono	Dolby D (2ch)	CSII	○	○	○	○	○	DD DIGITAL	L, R
	Dolby D (2ch Surr)	CSII	○	○	○	○	○	DD DIGITAL DD SURROUND	L, R, S
	SA-CD (2ch)	CSII	○	○	○	○	○	DSD	L, R
	PCM (Audio)	CSII	○	○	○	○	○	PCM	L, R
	HDCD	CSII	○	○	○	○	○	PCM, HDCD	L, R
	Analog	CSII	○	○	○	○	○	ANALOG	-
STEREO	Dolby Surr.EX	Stereo	○	-	-	-	○	DD DIGITAL EX	L, C, R, SL, SR, S, LFE
	Dolby D (5.1ch)	Stereo	○	-	-	-	○	DD DIGITAL	L, C, R, SL, SR, LFE
	Dolby D (2ch)	Stereo	○	-	-	-	○	DD DIGITAL	L, R
	Dolby D (2ch Surr)	Stereo	○	-	-	-	○	DD DIGITAL DD SURROUND	L, R, S
	Dolby Digital Plus (5.1)	Stereo	○	-	-	-	○	DD DIGITAL	L, C, R, SL, SR, LFE
	Dolby Digital Plus (6.1)	Stereo	○	-	-	-	○	DD DIGITAL	L, C, R, SL, SR, S, LFE
	Dolby Digital Plus (7.1)	Stereo	○	-	-	-	○	DD DIGITAL	L, C, R, SL, SR, S, LFE
	Dolby TrueHD (5.1)	Stereo	○	-	-	-	○	DD DIGITAL	Depend on speaker setup
	Dolby TrueHD (6.1)	Stereo	○	-	-	-	○	DD DIGITAL	Depend on speaker setup
	Dolby TrueHD (7.1)	Stereo	○	-	-	-	○	DD DIGITAL	Depend on speaker setup
	DTS-ES	Stereo	○	-	-	-	○	dtc, ES	L, C, R, SL, SR, S, LFE
	DTS 96/24	Stereo	○	-	-	-	○	dtc 96/24	L, C, R, SL, SR, LFE
	DTS (5.1ch)	Stereo	○	-	-	-	○	dtc	L, C, R, SL, SR, LFE
	DTS-HD (5.1)	Stereo	○	-	-	-	○	dtc	L, C, R, SL, SR, LFE
	DTS-HD (6.1)	Stereo	○	-	-	-	○	dtc	L, C, R, SL, SR, S, LFE
	DTS-HD (7.1)	Stereo	○	-	-	-	○	dtc	L, C, R, SL, SR, S, LFE
	Multi Ch-PCM	Stereo	○	-	-	-	○	PCM	L, C, R, SL, SR, LFE
	Multi Ch-PCM 96kHz	Stereo	○	-	-	-	○	PCM	L, C, R, SL, SR, LFE
SA-CD (5.1ch)	Stereo	○	-	-	-	○	DSD	L, C, R, SL, SR, LFE	
SA-CD (2ch)	Stereo	○	-	-	-	○	DSD	L, R	
PCM (Audio)	Stereo	○	-	-	-	○	PCM	L, R	
HDCD	Stereo	○	-	-	-	○	PCM, HDCD	L, R	
Analog	Stereo	○	-	-	-	○	ANALOG	-	
Dolby Virtual Speaker	Dolby Surr.EX	Dolby Virtual Speaker	○	-	-	-	○	DD DIGITAL EX	L, C, R, SL, SR, S, LFE
	Dolby D (5.1ch)	Dolby Virtual Speaker	○	-	-	-	○	DD DIGITAL	L, C, R, SL, SR, LFE
	Dolby D (2ch)	Dolby Virtual Speaker	○	-	-	-	○	DD DIGITAL	L, R
	Dolby D (2ch Surr)	Dolby Virtual Speaker	○	-	-	-	○	DD DIGITAL DD SURROUND	L, R, S
	DTS-ES	Dolby Virtual Speaker	○	-	-	-	○	dtc, ES	L, C, R, SL, SR, S, LFE
	DTS 96/24	Dolby Virtual Speaker	○	-	-	-	○	dtc 96/24	L, C, R, SL, SR, LFE
	DTS (5.1ch)	Dolby Virtual Speaker	○	-	-	-	○	dtc	L, C, R, SL, SR, LFE
	Multi Ch-PCM	Dolby Virtual Speaker	○	-	-	-	○	PCM	L, C, R, SL, SR, LFE
	SA-CD (5.1ch)	Dolby Virtual Speaker	○	-	-	-	○	DSD	L, C, R, SL, SR, LFE
	SA-CD (2ch)	Dolby Virtual Speaker	○	-	-	-	○	DSD	L, R
	PCM (Audio)	Dolby Virtual Speaker	○	-	-	-	○	PCM	L, R
	HDCD	Dolby Virtual Speaker	○	-	-	-	○	PCM, HDCD	L, R
Analog	Dolby Virtual Speaker	○	-	-	-	○	ANALOG	-	
Multi Ch. Movie Music (O): Movie mode only.	Dolby Surr.EX	Dolby Digital EX	○	(○)	○	○	○	DD DIGITAL EX	L, C, R, SL, SR, S, LFE
	Dolby D (5.1ch)	Dolby Digital 5.1	○	(○)	○	-	○	DD DIGITAL	L, C, R, SL, SR, LFE
	Dolby D (2ch)	Multi Channel	○	(○)	○	○	○	DD DIGITAL	L, R
	Dolby D (2ch Surr)	Multi Channel	○	(○)	○	○	○	DD DIGITAL DD SURROUND	L, R, S

Surround Mode	Input Signal	Decoding	Output Channel					Front information display	
			L/R	C	SL SR	SBL SBR	SubW	Signal format indicators	Channel status
Multi Ch. Movie Music  (O): Movie mode only. Dolby H.P	DTS-ES	DTS-ES	○	(○)	○	○	○	dtc, ES	L, C, R, SL, SR, S, LFE
	DTS 96/24	DTS-96/24	○	(○)	○	-	○	dtc 96/24	L, C, R, SL, SR, LFE
	DTS (5.1ch)	DTS 5.1	○	(○)	○	-	○	dtc	L, C, R, SL, SR, LFE
	Multi Ch-PCM	Multi Ch-PCM	○	(○)	○	-	○	PCM	L, C, R, SL, SR, LFE
	Multi Ch-PCM 96kHz	Multi Ch-PCM 96kHz	○	(○)	○	-	○	PCM	L, C, R, SL, SR, LFE
	SA-CD (5.1ch)	Multi Ch-PCM	○	(○)	○	-	○	DSD	L, C, R, SL, SR, LFE
	SA-CD (2ch)	Multi Channel	○	(○)	○	○	○	DSD	L, R
	PCM (Audio)	Multi Channel	○	(○)	○	○	○	PCM	L, R
	HDCD	Multi Channel	○	(○)	○	○	○	PCM, HDCD	L, R
	Analog	Multi Channel	○	(○)	○	○	○	ANALOG	-
	Dolby Surr.EX	Dolby H.P	○	-	-	-	-	DD DIGITAL EX	L, C, R, SL, SR, S, LFE
	Dolby D (5.1ch)	Dolby H.P	○	-	-	-	-	DD DIGITAL	L, C, R, SL, SR, LFE
	Dolby D (2ch)	Dolby H.P	○	-	-	-	-	DD DIGITAL	L, R
	Dolby D (2ch Surr)	Dolby H.P	○	-	-	-	-	DD DIGITAL DD SURROUND	L, R, S
	Dolby Digital Plus (5.1)	Stereo	○	-	-	-	○	DD DIGITAL	L, C, R, SL, SR, LFE
	Dolby Digital Plus (6.1)	Stereo	○	-	-	-	○	DD DIGITAL	L, C, R, SL, SR, S, LFE
	Dolby Digital Plus (7.1)	Stereo	○	-	-	-	○	DD DIGITAL	L, C, R, SL, SR, S, LFE
	Dolby TrueHD (5.1)	Stereo	○	-	-	-	○	DD DIGITAL	Depend on speaker setup
Dolby TrueHD (6.1)	Stereo	○	-	-	-	○	DD DIGITAL	Depend on speaker setup	
Dolby TrueHD (7.1)	Stereo	○	-	-	-	○	DD DIGITAL	Depend on speaker setup	
DTS-ES	Dolby H.P	○	-	-	-	-	dtc, ES	L, C, R, SL, SR, S, LFE	
DTS 96/24	Dolby H.P	○	-	-	-	-	dtc 96/24	L, C, R, SL, SR, LFE	
DTS (5.1ch)	Dolby H.P	○	-	-	-	-	dtc	L, C, R, SL, SR, LFE	
DTS-HD (5.1)	Stereo	○	-	-	-	○	dtc	L, C, R, SL, SR, LFE	
DTS-HD (6.1)	Stereo	○	-	-	-	○	dtc	L, C, R, SL, SR, S, LFE	
DTS-HD (7.1)	Stereo	○	-	-	-	○	dtc	L, C, R, SL, SR, S, LFE	
Multi Ch-PCM	Dolby H.P	○	-	-	-	-	PCM	L, C, R, SL, SR, LFE	
SA-CD (5.1ch)	Dolby H.P	○	-	-	-	-	DSD	L, C, R, SL, SR, LFE	
SA-CD (2ch)	Dolby H.P	○	-	-	-	-	DSD	L, R	
PCM (Audio)	Dolby H.P	○	-	-	-	-	PCM	L, R	
HDCD	Dolby H.P	○	-	-	-	-	PCM, HDCD	L, R	
Analog	Dolby H.P	○	-	-	-	-	ANALOG	-	
THX (AUTO)	Dolby Surr.EX	Dolby Digital + THX Surround EX	○	○	○	○	○	DD DIGITAL EX	L, C, R, SL, SR, S, LFE
	Dolby D (5.1ch)	Dolby Digital 5.1+ THX 5.1	○	○	○	-	○	DD DIGITAL	L, C, R, SL, SR, LFE
	Dolby D (2ch)	Pro Logic IIx movie + THX	○	○	○	○	○	DD DIGITAL	L, R
	Dolby D (2ch Surr)	Pro Logic IIx movie + THX	○	○	○	○	○	DD DIGITAL DD SURROUND	L, R, S
	DTS-ES	DTS-ES + THX	○	○	○	○	○	dtc, ES	L, C, R, SL, SR, S, LFE
	DTS (5.1ch)	DTS + THX 5.1	○	○	○	-	○	dtc	L, C, R, SL, SR, LFE
	Multi Ch-PCM	Multi Ch-PCM + THX5.1	○	○	○	-	○	PCM	L, C, R, SL, SR, LFE
	SA-CD (5.1ch)	Multi Ch-PCM + THX5.1	○	○	○	-	○	DSD	L, C, R, SL, SR, LFE
	SA-CD (2ch)	Pro Logic IIx movie + THX	○	○	○	○	○	DSD	L, R
	PCM (Audio)	Pro Logic IIx movie + THX	○	○	○	○	○	PCM	L, R
	HDCD	Pro Logic IIx movie + THX	○	○	○	○	○	PCM, HDCD	L, R
	Analog	Pro Logic IIx movie + THX	○	○	○	○	○	ANALOG	-
THX Select2 (THX EX) (THX Cinema) (THX Music) (THX Games)	Dolby Surr.EX	Dolby Digital + THX Surround EX	○	○	○	○	○	DD DIGITAL EX	L, C, R, SL, SR, S, LFE
	Dolby D (5.1ch)	Dolby Digital 5.1+ THX Select2 Cinema	○	○	○	-	○	DD DIGITAL	L, C, R, SL, SR, LFE
	Dolby D (2ch)	Pro Logic IIx movie + THX	○	○	○	○	○	DD DIGITAL	L, R
	Dolby D (2ch Surr)	Pro Logic IIx movie + THX	○	○	○	○	○	DD DIGITAL DD SURROUND	L, R, S
	DTS-ES	DTS-ES + THX	○	○	○	○	○	dtc, ES	L, C, R, SL, SR, S, LFE
	DTS (5.1ch)	DTS + THX Select2 Cinema	○	○	○	○	○	dtc	L, C, R, SL, SR, LFE
	Multi Ch-PCM	Multi Ch-PCM + THX Select2 Cinema	○	○	○	○	○	PCM	L, C, R, SL, SR, LFE
	SA-CD (5.1ch)	Multi Ch-PCM + THX Select2 Cinema	○	○	○	○	○	DSD	L, C, R, SL, SR, LFE
	SA-CD (2ch)	Pro Logic IIx movie + THX	○	○	○	○	○	DSD	L, R
	PCM (Audio)	Pro Logic IIx movie + THX	○	○	○	○	○	PCM	L, R
	HDCD	Pro Logic IIx movie + THX	○	○	○	○	○	PCM, HDCD	L, R
	Analog	Pro Logic IIx movie + THX	○	○	○	○	○	ANALOG	-

Notes:

- Dolby Digital (2 channel L/R): Speakers for signal with Dolby Surround are fully equipped.
- No sound is outputs from the surround speaker, center speaker and subwoofer if the DVD disc has no surround data.
- Surround modes other than Stereo are not available during Dolby TrueHD, Dolby Digital Plus, or DTS-HD playback.

If surround modes other than Stereo are selected and Dolby TrueHD, Dolby Digital Plus, or DTS-HD content is played, the surround mode setting is disabled.

Abbreviations

- L/R : Front speakers
- C : Center speaker
- SL/SR : Surround speakers
- SBL/SBR : Surround back speakers
- SubW : Subwoofer



**AUTO**

When this mode is selected, the unit determines whether the digital input signal is Dolby Digital, Dolby Digital Surround EX, Dolby Digital Plus, Dolby TrueHD, DTS-HD, DTS, DTS-ES, DTS 96/24 or PCM audio.

Surround EX & DTS-ES will operate for multichannel sources that have a Dolby Digital Surround EX or DTS-ES auto trigger flag in the digital signal.

When a Dolby Digital or DTS signal is input, the number of channels for which the corresponding signal is encoded will be played.

Inputting a Dolby Digital two channel signal with Dolby surround status automatically subjects that signal to Pro Logic IIx movie processing before play. PCM 96 kHz source material can be played in this mode.

**Notes:**

- When you use this mode with certain DVD and CD players, performing operations such as skip or stop may momentarily interrupt the output.
- When the signal is not decoded, the mode is changed to AUTO mode automatically. See page 60 to confirm the available decoding modes.

**SOURCE DIRECT**

In the Source Direct mode, the tone control circuit Acoustic EQ. and bass management configuration are bypassed for full-range frequency response and the purist audio reproduction.

**Notes:**

- Speaker size is set to Front L/R = LARGE, Center = LARGE, Surround L/R = LARGE and Subwoofer = YES automatically. Tone controls, equalizer and additional processing are deactivated.
- When you use this mode with certain DVD and CD players, performing operations such as skip or stop may momentarily interrupt the output.
- In SOURCE DIRECT mode, ACOUSTIC EQ and M-DAX are not available.

**PURE DIRECT**

The Pure Direct mode further reduces sources of noise in addition to effect of the Source Direct mode, by blocking output from the video jacks (VIDEO, S-VIDEO, COMPONENT VIDEO and HDMI) and turning the FL display off.

**Note:**

- In PURE DIRECT mode, ACOUSTIC EQ and M-DAX are not available.

**EX/ES**

This mode provides 6.1 channel surround for Dolby Digital EX, and DTS-ES-encoded source material such as DVD.

This mode cannot be used when an analog input has been selected.

**Dolby Digital EX**

In a movie theater, film soundtracks that have been encoded with Dolby Digital Surround EX technology are able to reproduce an extra channel which has been added during the mixing of the program.

This channel, called surround back, places sounds behind the listener in addition to the currently available front left, front center, front right, surround right, surround left and subwoofer channels.

This additional channel provides the opportunity for more detailed imaging behind the listener and brings more depth, spacious ambience and sound localization than ever before.

Dolby Digital EX is not available in systems that do not have without surround back speaker(s).

**DTS-ES (Discrete 6.1, Matrix 6.1)**

DTS-ES adds the surround center channel audio to the DTS 5.1 channel format to improve the acoustic positioning, and makes acoustic image movement more natural with the 6.1 channel reproduction.

This unit incorporates a DTS-ES-decoder, which can handle DTS-ES Discrete-encoded and DTS-ES Matrix-encoded program sources from DVD, etc.

DTS-ES Discrete 6.1 features digital discrete recording of all channels, including the surround back channel(s), and higher quality audio reproduction.

DTS-ES is not available in systems that do not have surround back speakers.

**MODE****(Dolby Digital, Pro Logic IIx MOVIE, Pro Logic IIx MUSIC, Pro Logic IIx GAME)**

This mode is used with source materials encoded in Dolby Digital and Dolby Surround.

**DOLBY DIGITAL**

This mode is enabled when playing source materials encoded in Dolby Digital.

Playing multichannel-encoded 5.1 channel Dolby Digital sources provides 5 main audio channels (left, center, right, surround left and surround right) and a Low Frequency Effect channel.

Dolby Digital EX decoding is not available in this mode.

Dolby Pro Logic IIx has 5 modes:

**Pro Logic IIx MOVIE**

This mode provides 6.1 or 7.1 channel surround sound from Dolby Surround, encoded stereo movie soundtracks.

**Pro Logic IIx MUSIC**

This mode provides 6.1 or 7.1 channel surround sound from conventional stereo sources (analog or digital), such as CD, tape, FM, TV, stereo VCR, etc.

**Pro Logic IIx GAME**

This mode restores the impact low-frequency surround effects by routing them to the system's subwoofer.

**5.1ch + Pro Logic IIx Movie**

This mode provides 7.1 channel surround sound from 5.1 channel sources movie soundtracks.

**5.1ch + Pro Logic IIx Music**

This mode provides 6.1 or 7.1 channel surround sound from 5.1 channel sources music soundtracks.

**Notes:**

- Pro Logic IIx mode will decode as Pro Logic II mode when the SURR. B is set to "NONE" from SPEAKER SETUP menu. (See page 49)
- Pro Logic IIx mode is available for a 2 channel input signal which is encoded in Dolby Digital, HDCD or PCM format.

**dts**

dts, Neo:6 Cinema, Neo:6 Music

This mode is for DTS-encoded source materials such as laserdisc, CD and DVD. Neo:6 is for some 2 channel sources.

**dts**

This mode is enabled when playing source materials encoded in dts multichannel.

Playing multichannel encoded-5.1 channel dts sources provides five main audio channels (left, center, right, surround left and surround right) and a Low Frequency Effects channel.

dts-ES decoding is not available in this mode.

The DTS mode cannot be used when an analog input has been selected.

**Neo:6 Cinema, Neo:6 Music**

This mode decodes 2 channel signals into 6 channel signals using high-accuracy digital matrix technology. The DTS Neo:6 decoder has near-discrete properties in the frequency characteristics of the channels as well as in channel separation.

According to the signals to be played back, DTS Neo:6 uses either the Neo:6 Cinema mode optimized for movie playback or the Neo:6 Music mode optimized for music playback.

**Note:**

- The Neo:6 mode is available for 2 channel input signals which are encoded in Dolby Digital, HDCD or PCM format.

**CIRCLE SURROUND II (CSII-CINEMA, CSII-MUSIC, CSII-MONO)**

Circle Surround is designed to enable multichannel surround sound playback of non-encoded and multichannel encoded material.

Backward compatibility provides listeners with up to 6.1 channels of surround performance from an entire collection of music and film, including broadcast, videotape and stereo recorded music.

Depending on source material, you can select CSII-Cinema mode, CSII-Music mode or CSII-Mono mode.

**Note:**

- The CS II mode is available for 2 channel input signals which are encoded in Dolby Digital, HDCD or PCM format.



## **STEREO**

This mode bypasses all surround processing. In stereo program sources, the left and right channels play normally when PCM audio or analog stereo is input.

With Dolby Digital and DTS sources, the 5.1 channels are converted to two channel stereo. 96 kHz PCM source material can be played back in stereo mode.

## **Dolby Virtual Speaker**

Dolby Virtual Speaker technology uses proprietary technology of Dolby Laboratories to create a virtual surround sound field using only two speakers for the front channels, allowing the user to experience sound as if surround speakers were actually being used.

## **MULTI CH. (MOVIE, MUSIC)**

This mode is used to create a wider, deeper and more natural soundstage from two channel source material. This is done by feeding the left channel signal to both the left front and left surround speakers and the right channel signal to both the right front and right surround speakers. Additionally, the center channel reproduces a mix of the right and left channels.

### **Note:**

- Audio is not output from the CENTER channel when using MULTI CH. MUSIC mode.

## **THX CINEMA**

THX Cinema mode applies additional processing to Dolby Digital, DTS and Dolby Pro Logic multichannel, surround sources. The THX processing was developed by THX Ltd. to recreate the sound of top-quality theater.

Use the THX Cinema mode for all movies on disc, tape or broadcast. In this mode, the THX Surround EX mode is not available.

## **THX SURROUND EX**

In a movie theater, film soundtracks that have been encoded with Dolby Digital Surround EX technology are able to reproduce an extra channel which has been added during the mixing of the program.

This channel, called Surround Back, places sounds behind the listener in addition to the currently available front left, front center, front right, surround right, surround left and subwoofer channels.

This additional channel provides the opportunity for more detailed imaging behind the listener and brings more depth, spacious ambience and sound localization than ever before.

THX Surround EX will operate for any 5.1 channel source whenever THX is active.

THX Surround EX is not available in system without surround back speaker(s).

### **Note:**

- When playing Dolby Digital Surround EX-encoded software in 6.1 channels, it is required to select the THX Surround EX mode.

## **THX SELECT2 CINEMA**

THX SELECT2 Cinema mode plays 5.1 movies using all 7.1 speakers giving you the best possible movie watching experience. In this mode, ASA processing blends the surround L/R speakers and surround back speakers, providing the optimal mix of ambient and directional surround sound.

This mode permits the playback of a non Surround EX/ES-encoded 5.1 movie over a 7.1 system.

DTS-ES (Matrix and 6.1 Discrete) and Dolby Digital Surround EX-encoded soundtracks will be automatically detected, if the appropriate flag has been encoded.

Some Dolby Digital Surround EX soundtracks are missing the digital flag that allows automatic switching.

If you know that the movie that you are watching is encoded in Surround EX, you can manually select the THX Surround EX playback mode, otherwise the THX SELECT2 Cinema mode will apply ASA processing to provide optimum replay.

## **THX MUSIC**

For the replay of multichannel music, the THX Music mode should be selected. In this mode, THX ASA processing is applied to the surround channels of all 5.1-encoded music sources, such as DTS and Dolby Digital, to provide a wide, stable, rear soundstage.

This mode is to be used with multichannel music sources such as DTS 5.1 music and Dolby Digital 5.1 music.

### **Notes:**

- These modes are only available when you have setup SPEAKER SIZE menu system (i.e. 2 surround back speakers).
- These modes are only available when the input signal has surround left and surround right contents.

## **THX GAMES**

For the replay of stereo and multichannel game audio the THX Games mode should be selected. In this mode, THX ASA processing is applied to the surround channels of all 5.1 and 2.0-encoded game sources such as analog, PCM, DTS and Dolby Digital. This accurately places all game audio surround information, providing a full 360-degree playback environment. THX Games mode is unique as it gives you a smooth transition of audio in all points of the surround field.

## **Neural Surround**

Neural Surround™ represents the latest advancement in surround technology developed for music.

Neural Surround™ employs psychoacoustic frequency domain processing which allows delivery of a more detailed sound stage with superior channel separation and localization of audio elements. System playback is scalable from 5.1 to 7.1 multichannel surround playback.

This is the optimum mode for playing sources recorded in XM HD Surround. (See page 77)

## **CAUTION**

### **Note for DTS**

- To connected DVD player, laserdisc player or CD player needs to support DTS digital output. You may not be able to play some DTS source signals from certain CD players and LD players even if you connect the player to the unit digitally. This is because the digital signal has been processed (such as the output level, sampling frequency or frequency response), and the unit cannot recognize the signal as DTS data.
- Depending on the player used, DTS play may produce a short noise. This is not a malfunction.
- While signals from a DTS laserdisc or CD are playing in another surround mode, you cannot switch to digital input or from digital input to analog input from the INPUT SETUP in the MAIN MENU or by pressing the **A/D** button.
- You can not listen to DTS-encoded software in a multiroom.
- The outputs for VCR 1 OUT, DSS/VCR 2 OUT, TAPE OUT and CD-R OUT output analog audio signals only. Do not record from CDs or LDs that support DTS using these outputs. If you do, the DTS-encoded signal will be recorded as noise.

### **Note or Dolby Digital Surround EX**

- When playing Dolby Digital Surround EX-encoded software in 6.1 channels, it is required to set the EX/ES mode.
- Note that some Dolby Digital Surround EX-encoded software does not contain the identification signal. In this case, set the EX/ES mode manually.

### **Note for 96 kHz/192 kHz PCM audio**

- The AUTO, Pure Direct, and Stereo modes can be used when playing PCM signals with a sampling frequency of 96/192 kHz (such as from DVD-Video/Audio discs).
- Certain DVD player models inhibit digital output. For details, refer to the player's operation manual.
- Some DVD discs feature copy protection. When using such disc, 96 kHz PCM signal are not output from the DVD player. For details, refer to the player's operation manual.

### **Note for HDCD**

- HDCD is effective only through digital input.
- You may not be able to play some HDCD source signals from certain CD players if you connect the player to the unit digitally. This is because the digital signal has been processed (such as the output level, sampling frequency or frequency response) and the unit cannot recognize the signal as HDCD data.

# OTHER FUNCTION

## DISPLAY MODE

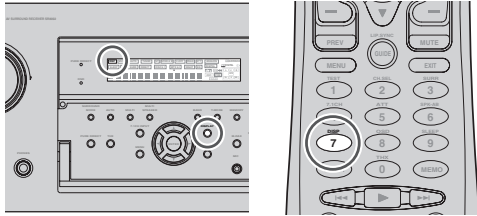

You can select the display mode for the front display of the unit.

To select this mode, press the **DISPLAY** on the remote controller or the front panel. When this button is pressed, the display mode is switched in the following sequence.  
Input Mode → Surround Mode → Auto display OFF → Display OFF → Normal Mode → Input Mode

### Normal Mode:

Displays the selected input function. If the function has been renamed using the Function Rename feature (see page 44), the renamed name appears on the display.

### Input Mode:

Displays the input mode set via the Function Input Setup feature (see page 43).

### Surround Mode:

Displays the status of the selected surround mode.

### Auto Display Off mode:

The display is off. But, if you make a change to the unit such as the input or surround mode, the display will show that change, then go back to off after about 3 seconds. When changing the volume, it is not displayed.

### Display Off mode:

The display is off completely.

### Note:

- Only the DISP indicator will be illuminated on the front display in display off condition.

## RECORDING AN ANALOG SOURCE

In normal operation, the audio or video source selected for listening through this unit is sent to the record outputs.

This means that any program you are watching or listening to may be recorded simply by placing machines connected to the outputs for **TAPE OUT**, **CD/CDR OUT**, **VCR1 OUT**, and **DSS/VCR2 OUT** in the record mode.

*To record the input source signal you are currently watching or listening to*

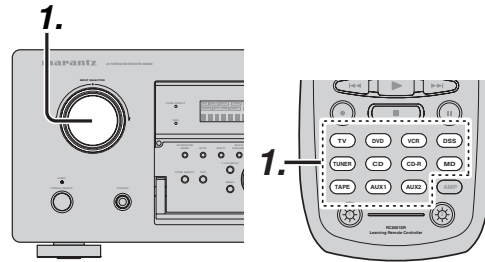

1. Select the input source to record by turning the **INPUT FUNCTION SELECTOR** knob on the front panel or simply press the input selector buttons on the remote controller.  
The input source is now selected and you may watch or listen to it as desired.
2. The currently selected input source signal is output to the **TAPE OUT**, **CD/CDR OUT**, **VCR1 OUT**, and **DSS/VCR2 OUT** outputs for recording.
3. Start recording to the recording component as desired.

## SELECTING ANALOG AUDIO INPUT OR DIGITAL AUDIO INPUT

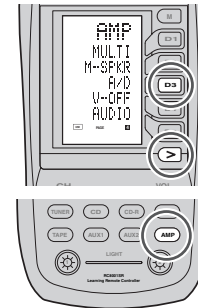

If you have already assigned the digital inputs, you can temporarily select the audio input mode for each input source as following procedures.  
Press the **AMP** button and press the > button until PAGE4 is displayed. Press the **A/D (D3)** button. When this button is pressed, the input mode is switched in the following sequence.  
Auto → HDMI → Digital → Analog → Auto

### Auto mode:

The types of signals being input to the digital and analog input jacks for the selected input source are detected automatically.  
If no digital signal is being input, the analog input jacks are selected automatically.

### HDMI mode:

HDMI mode can be selected only when an HDMI input has been assigned as an input source.  
When "HDMI AUDIO" under PREFERENCE of the SETUP MENU is set to "THROUGH", the HDMI mode cannot be selected.

### Digital mode:

The input signal is fixed to an assigned digital input terminal.

### Analog mode:

The analog input jacks are selected.

This selection is temporary and will not be stored in memory.

To store changes to the input mode, select "**1. INPUT SETUP**" from the MAIN MENU. (See page 43)

## LISTENING THROUGH HEADPHONES

This jack may be used to listen to the unit's output through a pair of headphones. Be certain that the headphones have a standard 1/4" stereo phono plug.

Note that the speakers will automatically be turned off when the headphone jack is in use.

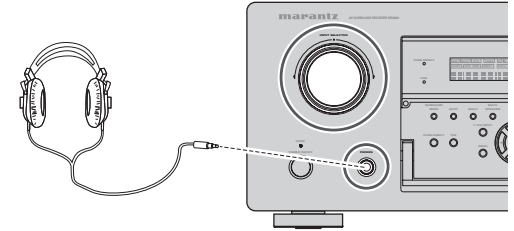

### Note:

- When using headphones, the surround mode will change to STEREO and Dolby Headphone by MENU and Cursor button.
- The surround mode returns to the previous setting as soon as the headphone plug is removed from the jack.

## DOLBY HEADPHONE MODE

This feature simulates the waveforms of the actual sounds heard from the speakers.

When headphones are used, the **MENU** button automatically switches to the Dolby headphone mode.

The OSD that appears when the **MENU** button is pressed is shown below.

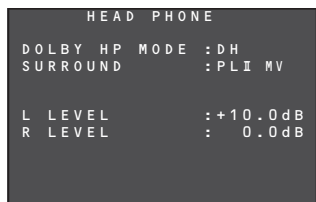

DOLBY HP (Headphone) MODE can be selected with the left and right cursor buttons.

BYPASS → DH (DOLBY Headphone) → BYPASS

**BYPASS:** Bypasses the Dolby headphone mode and delivers ordinary 2-channel stereo.

**DH:** Dolby Headphone is a signal processing system that delivers a sound similar to room speakers.

It makes it possible to experience the volume and space of a 5-channel surround system using ordinary stereo headphones.

When the PURE DIRECT mode is selected, Dolby surround processing is bypassed and "\*\*\*" is displayed as the mode indication.

The surround mode can be selected when the modes in DH is selected.

L/R LEVEL can be set in the ±12 dB range.

### Notes:

- The surround mode returns to the previous setting as soon as the plug is removed from the jack.
- In headphone mode, Tone Control and ACOUSTIC EQ are not available.

## ATTENUATION TO ANALOG INPUT SIGNAL



If the selected analog audio input signal is greater than the capable level of internal processing, the **"PEAK"** indicator will light up on the front display. If this happens, you should press the **ATT** button on the remote controller.

**"ATT"** indicator will be illuminated when this function is activated. The signal-input level is reduced by about half. Attenuation will not work with the output signal of TAPE-OUT, CD/CD-R, VCR1-OUT and DSS/VCR2-OUT.

This function is memorized for each individual input source.

## SPEAKER A/B

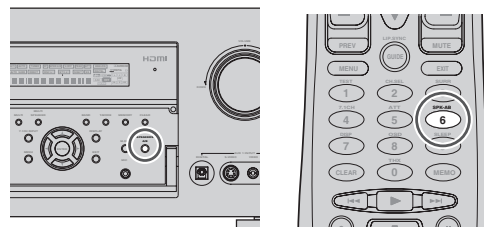

This unit has speaker system - A and speaker system- B for front L/R channels.

You can select these systems by pressing **SPEAKERS A/B** button on the front panel or **SPK-AB** on the remote controller.

## 7.1 CH INPUT

This unit is equipped for future expansion through the use of Multi channel Super Audio CD multichannel player or DVD-Audio player.

When this is selected, the input signals connected to the L (front left), R (front right), CENTER, SL (surround left), SR (surround right) and SBL (surround back left) and SBR (surround back right) channels of the 7.1 CH. In jacks are output directly to the front (left and right), center, surround (left and right) and surround back speaker systems as well as the pre-out jacks without passing through the surround circuitry.

In addition, the signal input to the SW (subwoofer) jack is output to the PRE OUT SW (subwoofer) jack. When 7.1 CH. INPUT is selected, the last video input used remains routed to the **Monitor Outputs**.

This permits simultaneous viewing with video sources

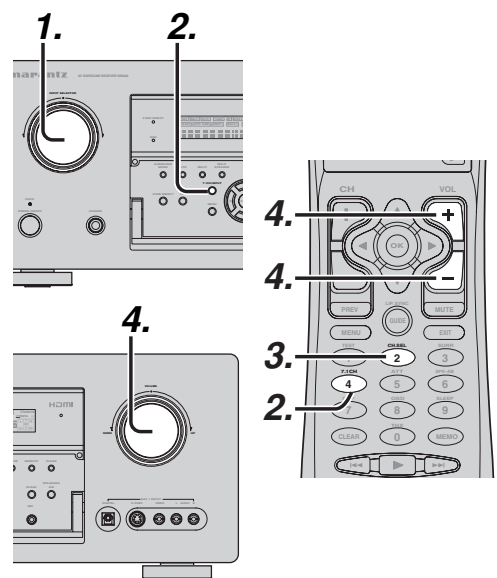

1. Select a desired Video source to decide the routed video signal to the **Monitor Outputs**.
2. Press the **7.1 CH INPUT** button on the front panel or press **7.1 CH** on the remote controller to switch the 7.1 channel input.

3. If it is necessary to adjust the output level of each channel, press the **CH.SEL** button on the remote controller.

Adjust the speaker output levels so that you can hear the same sound level from each speaker at the listening position. For the front left, front right, center, surround left, surround right and surround back speakers, the output levels can be adjusted between -12 to +12 dB.

The subwoofer can be adjusted between -18 and +12 dB.

These adjustments result will be stored to 7.1 CH. INPUT memory.

4. Adjust the main volume with the **MAIN VOLUME** knob or the **VOL** buttons on the remote controller.

To cancel the 7.1 CH. INPUT setting, press the **7.1 CH INPUT** button on the front panel or press **7.1 CH** on the remote controller.

### Notes:

- When the 7.1 CH. Input is in use, you may not select a surround mode, as the external decoder determines processing.
- In addition, there is no signal at the record outputs when the 7.1 CH. Input is in use.
- Furthermore, the following functions are not available during 7.1 CH Input use.

Test Tone, NIGHT MODE, Source Direct, Pure Direct, RE-EQ, Tone Control, Multi EQ

## AUX2 INPUT

If you don't need to connect 7.1 Ch. input terminals with multi channel decoder, L(front left) and R (front right) inputs terminals are available as AUX2 input. In this case, You can connect additional audio source to AUX2 as other audio input terminals.

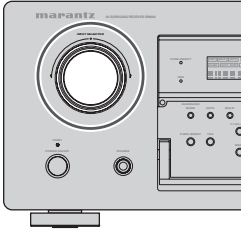

## VIDEO ON/OFF

When no video signal is connected to the unit or a DVD, etc., is connected directly to your TV, the unnecessary video circuit can be turned off by selecting the "VIDEO OFF" setting.

To select video off, press the **AMP** button and press the > button until PAGE 4 is displayed. Press the **V-OFF** button.

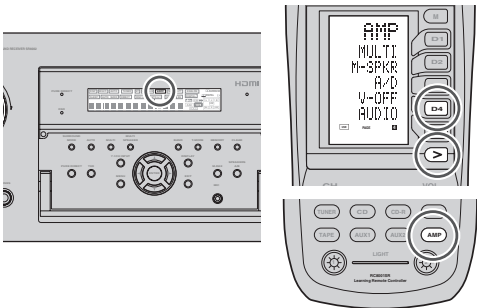

## TV AUTO ON/OFF FUNCTION

This function allows the component connected to the TV-VIDEO in jack to control the power (ON/OFF) to the unit.

## AUTO POWER ON

1. Be sure the TV auto mode is **ENABLED**. (Refer to page 53:)

2. Connect your TV TUNER (etc) to the TV-VIDEO in terminal. Be sure to connect the VIDEO input.
3. Turn OFF the power to the TV TUNER and the unit.
4. Turn ON the TV TUNER and tune in a receivable station.
5. When the station is received, this unit turns ON and TV is selected automatically.

## AUTO POWER OFF

1. In the above situation, turn the TV TUNER OFF or select a channel that does not contain any broadcast.
2. The power to the unit switches to **STANDBY** after approx. 5 minutes.

### Notes:

- **AUTO POWER OFF** is canceled if this unit is set to a source other than TV. The function reactivates when TV is selected again.
- Some TV broadcasts may cause the **TV AUTO FUNCTION** to turn ON.
- The S-Video terminal does not support "TV AUTO ON/OFF" function.

## LIP.SYNC

Depending on the image device (TV, monitor, projector, etc.) connected to the unit a time lag can occur between image signal processing and audio signal processing. Though minor, this time lag can interfere with movie and music enjoyment. The **LIP.SYNC** feature delays the audio signal with respect to the image signal output from the SR7001 to correct the time lag between the sound and image. It can be operated with the "LIP.SYNC" and ◀ and ▶ cursor buttons of the remote controller. Set the remote controller to the **AMP** mode before operating the **LIP.SYNC** feature. The initial setting is **OFF (0 ms)**. The time lag can be adjusted in 10 ms steps up to 200 ms.

Watch the picture on the image device (i.e., TV, monitor, projector, etc.) as you adjust the time lag.

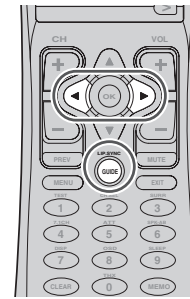

### Note:

- The **LIP.SYNSC** feature turns OFF (0 ms) in the **SOURCE/PURE DIRECT** mode. When the **SOURCE/PURE DIRECT** mode is deactivated, the set value of the **LIP.SYNSC** feature is automatically restored.
- Even if you do not correct the time lag manually this way, audio and video are automatically synchronized when the unit is connected to TV or Projectors supporting Auto Lipsync Correction in HDMI 1.3a. For instructions on Auto Lipsync Correction, see page 54.

## DUAL BACKUP MEMORY

The unit stores settings information in nonvolatile memory even when the main power supply is turned off. Using the Dual Backup Memory function, you can write settings information to another memory area to back up saved settings for recovery anytime as needed.

### BACKUP

Set up the unit in the state for which you want to store the settings. Hold the **MEMORY** and **ENTER** buttons on the front panel simultaneously for at least 3 seconds.

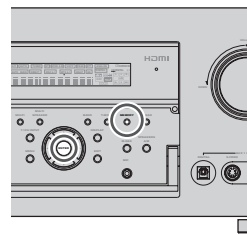

"**MEMORY SAVING**" is displayed and the unit's settings are saved. The stored settings information is retained until Dual Backup Memory is used again and the information is overwritten.

## MEMORY SAVING

### Note:

- The following settings values cannot be backed up.
  - Main Room Volume
  - Multi Room Volume
  - Multi Speaker Room Volume

## RECOVERY OF MEMORY

Recover backed up settings as follows. Hold the **MEMORY** and **MENU** buttons on the front panel simultaneously for at least 3 seconds.

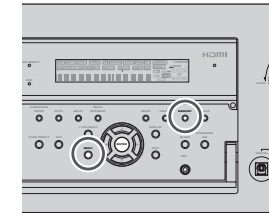

"**MEMORY LOAD**" is displayed and the unit's stored settings are reapplied.

The unit temporarily enters standby mode. If there is no backup data, "**NO BACKUP**" is displayed and no data is recovered.

## MEMORY LOAD

## NO BACKUP

### Note:

- Because the following settings values are not backed up, each Volume value is set to Minimum.
  - Main Room Volume
  - Multi Room Volume
  - Multi Speaker Volume



# BASIC OPERATION

## (TUNER)

To operate the unit from the remote controller, press the **TUNER** button on the remote controller so that the tuner mode is engaged.

### LISTENING TO THE TUNER

Frequency scan step for AM is selectable. Default setup is 10 kHz step, if your country's standard is 9 kHz step, Press **BAND** button on the front panel or **TUNER** button on the remote controller more than 5 seconds. Scan step will change.

#### Note:

- This function is not available on the SR8002.
- Preset memory for the tuner will clear by changing this setup.

### AUTO TUNING

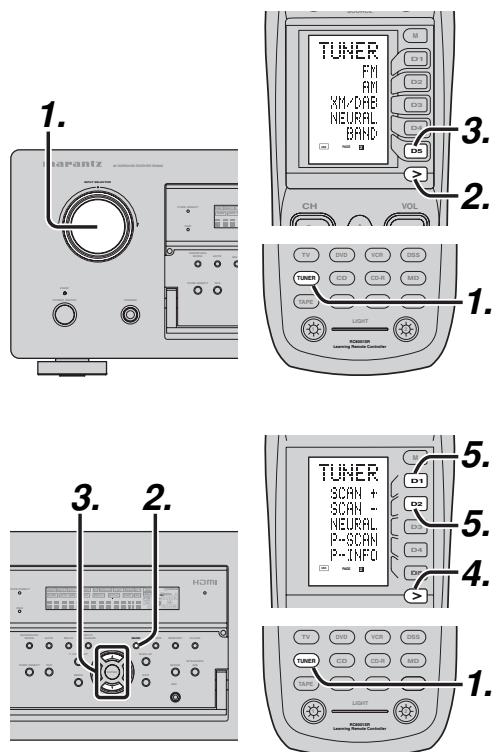

#### (Using the unit)

1. Turn the INPUT SELECTOR knob to select "TUNER".
2. Press the **BAND** button to select either FM or AM.
3. Press the **▲** or **▼** cursor buttons on the front Panel for more than 1 second to start the auto tuning function.
4. Automatic searching begins then stops when a station is tuned in.

#### (Using the remote controller)

1. To select tuner, Press the **TUNER** button twice within two second on the remote.
2. Press the **>** button until PAGE 1 is displayed.
3. Press the **BAND (D5)** button to select either FM or AM.
4. Press the **>** button until PAGE 2 is displayed.
5. Press and hold the **SCAN+ (D1)** or **SCAN- (D2)** button for 1 second or more.
6. Automatic searching begins then stops when a station is tuned in.

If tuning does not stop at the desired station, use to the "MANUAL TUNING" operation.

### MANUAL TUNING

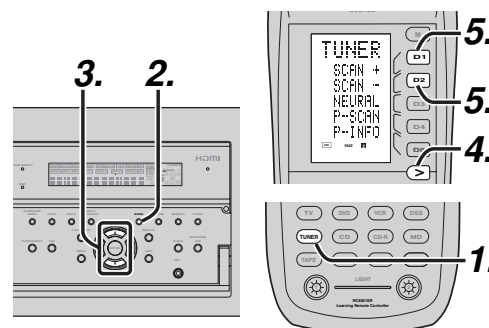
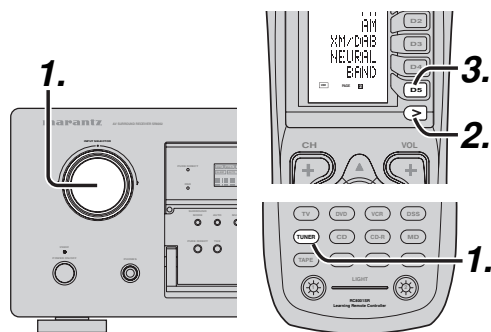

#### (Using the unit)

1. Turn the INPUT SELECTOR knob to select "TUNER".
2. Press the **BAND** button to select either FM or AM.
3. Press the **▲** or **▼** cursor buttons on the front Panel to select the desired station.

#### (Using the remote controller)

1. To select tuner, press the **TUNER** button twice within two seconds on the remote controller.
2. Press the **>** button until PAGE 1 is displayed.
3. Press the **BAND (D5)** button to select either FM or AM.
4. Press the **>** button until PAGE 2 is displayed.
5. Press the **SCAN+ (D1)** or **SCAN- (D2)** button to tune in the deseired station.

### DIRECT FREQUENCY CALL

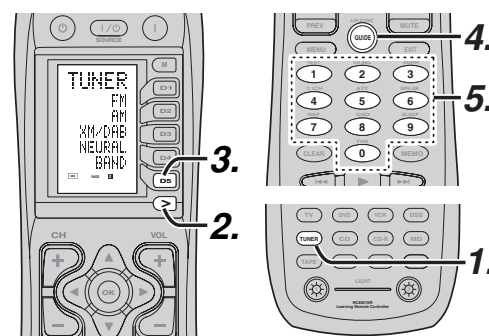

1. To select tuner, Press the **TUNER** button twice within two seconds on the remote controller.
2. Press the **>** button until PAGE 1 is displayed.
3. Press the **BAND (D5)** button to select either FM or AM.
4. Press the **GUIDE** on the remote controller, display will show "FREQ----".
5. Input your desired station's, frequency with the ten numbered keypad on the remote controller.
6. The desired station will automatically be tuned.

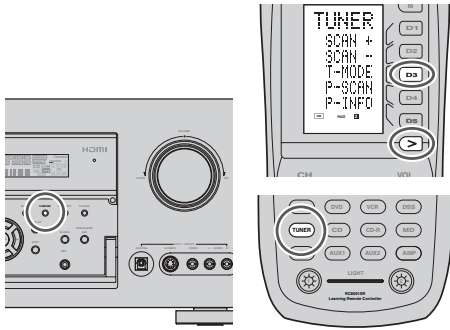

**(FM) TUNING MODE (AUTO STEREO OR MONO)**

In TUNER mode, press the **T-MODE** button on the remote controller to switch between AUTO STEREO and monaural sound.

1. Press the > button on the remote controller to display Page 2.
2. Each time the **T-MODE (D3)** button is pressed, the TUNER mode changes and the mode is displayed on the FL display.

**Analog / Digital Auto Mode (Only on the SR8002)**

**T - M O D E : D I G - A T**

For listening to HD Radio stations. See p.70 for more information on HD Radio technology.

**Note:**

- This mode is not available on the SR7002.

**Analog Auto Mode (when receiving FM broadcasts)**

**T - M O D E : A N A - A T**

AUTO STEREO mode is selected and the AUTO indicator is illuminated on the FL display.

When stereo broadcasts are received, the ST indicator is illuminated on the FL display.

**Note:**

- This mode is not available when BAND is set to AM.

**Analog Mono Mode**

**T - M O D E : M O N O**

MONO mode is selected and the AUTO indicator disappears from the FL display. Monaural broadcasts are received in TUNER mode.

**Note:**

- On the SR7002, the TUNER mode cannot be changed when BAND is set to AM.
- The SR7002 does not display the mode on the FL display when the TUNER MODE is switched.

The AUTO indicator appears on the FL display when the mode is switched to Analog Auto Mode. (See page 9)

- If the unit receives a weak signal or it is difficult to receive a stereo signal, press the **T-MODE** button on the remote controller or the unit to switch to MONO mode. This reduces the amount of noise and makes broadcasts easier to hear. The AUTO indicator on the FL display disappears.

**PRESET MEMORY**

With this unit you can preset up to 60 FM/AM stations in any order.

For each station, you can memorize the frequency and reception mode if desired.

**AUTO PRESET MEMORY**

This function automatically scans the FM and AM band and enters all stations with proper signal strength into the memory.

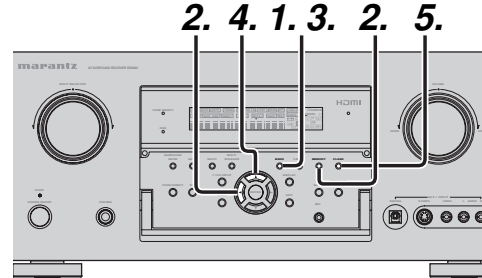

1. To select FM, press the **BAND** button on the front panel.
2. While pressing the **MEMORY** button, press the ◀ cursor button.  
“**AUTO PRESET**” will appear on the display, and scanning starts from the lowest frequency.
3. Each time the tuner finds a station, scanning will pause and the station will be played for five seconds.  
During this time, the following operations are possible.  
The band can be changed by the **BAND** button.
4. If no button is pressed during this period, the current station is memorized in location Preset 01.

If you wish to skip the current station, press the ▲ cursor button during this period, this station is skipped and auto presetting continues.

5. Operation stops automatically when all 60 preset memory positions are filled or when auto scanning attains the highest end of all bands. If you desire to stop the auto preset memory at anytime, press the **CLEAR** button.

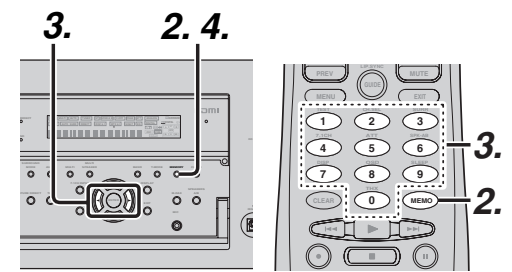
**MANUAL PRESET MEMORY**

*(Using the unit)*

1. Tune into the radio station you desire (Refer to the “**MANUAL TUNING**” or “**AUTO TUNING**” section).
2. Press the **MEMORY** button on the front panel. “- -” (preset number) starts blinking on the display.
3. Select the preset number by pressing the ◀ or ▶ cursor buttons, while this is still blinking (approx. 5 seconds)
4. Press the **MEMORY** button again to enter. The display stops blinking.  
The station is now stored in the specified preset memory location.

*(Using the remote controller)*

1. Tune into the radio station you desire (Refer to the “**MANUAL TUNING**” or “**AUTO TUNING**” section).
2. Press the **MEMO** button on the remote controller. “- -” (preset number) starts blinking on the display.
3. Enter the desired preset number by pressing the **numeric** buttons.

**Note:**

- When entering a single digit number (2 for example), either input “02” or just input “2” and wait for a few seconds.

**RECALLING A PRESET STATION**

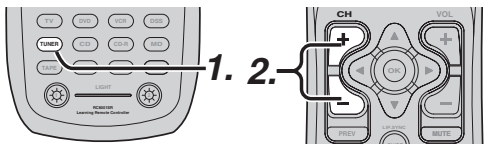

(Using the unit)

1. Select the desired preset station by pressing the ◀ or ▶ cursor buttons on the front panel.

(Using the remote controller)

1. Press the **TUNER** button twice within two seconds on the remote.
2. Press the **CH+** or **CH-** button to tune in the desired preset station.  
Or enter the preset station number with the numeric buttons.

**PRESET SCAN**

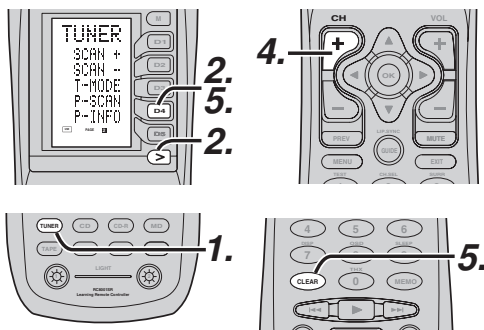

(Using the remote controller)

1. Press the **TUNER** button twice within two seconds on the remote controller.
2. Press the > button until **PAGE2** is displayed and press the **P-SCAN (D4)** on the remote.  
“**PRESET SCAN**” appears on the front display and then the preset station with the lowest preset number is recalled first.
3. Preset stations are recalled in sequence (No.1 → No.2 → etc.) for 10 seconds each.  
No stored preset number will be skipped.

4. You can fast forward the preset stations, press the **CH+** continuously.
5. When the desired preset station is received, cancel the preset scan operation by pressing the **CLEAR** button or **P-SCAN (D4)** on the remote controller.

**PRESET CHANNEL LIST DISPLAY**

A complete list of the broadcast channels stored in this unit can be displayed.

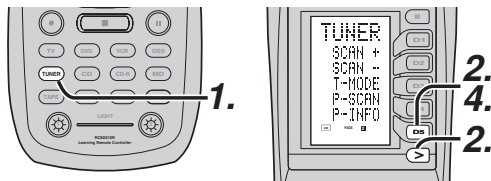

1. Press the **Tuner** button on the remote controller twice within two seconds to switch to the **TUNER** function.
2. Press > on the remote controller to display **PAGE2**, then press **P-INFO (D5)**.
3. The list of preset channels will be displayed on the screen of the TV monitor connected to this unit.

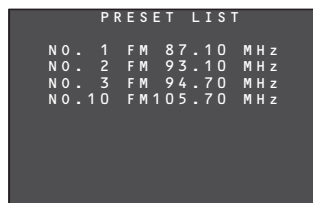

On the SR8002, multicast channels are also displayed, as shown below, when an HD Radio channel is set to the preset channels.

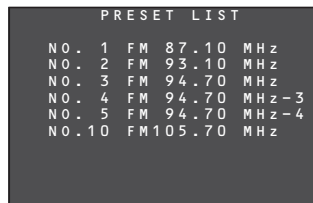

In the list of preset channels above, preset numbers 4 and 5 are the multicast channels for preset number 3.

4. Up to 10 channels can be displayed at a time. If there are more than 10 channels, press **P-INFO (D5)** on the remote controller once more to display the next page.  
The list display will disappear automatically in 5 seconds.

**CLEARING STORED PRESET STATIONS**

You can remove preset stations from the memory using the following procedure.

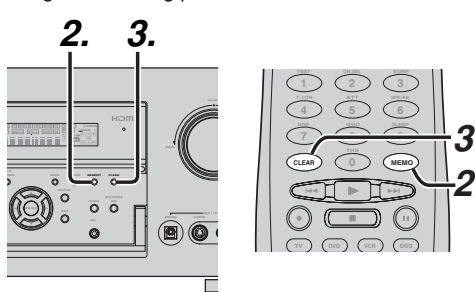

1. Recall the preset number to be cleared with the method described in “Recalling” a preset station.
2. Press the **MEMORY** button on the front panel or press the **MEMO** button on the remote.
3. The stored preset number blinks in the display for 5 seconds. While blinking, press the **CLEAR** button on the front panel or the remote controller.
4. “**xx CLEAR**” appears on the display to indicate that the specified preset number has been cleared.

**Note:**

- To clear all stored preset stations, press and hold the **CLEAR** and the **ENTER** buttons for two seconds.

**SORTING PRESET STATIONS**

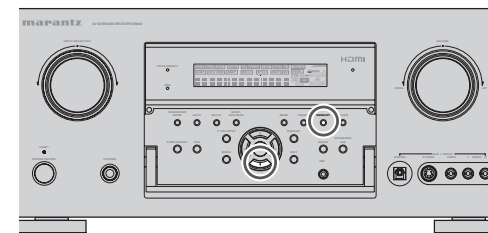

If you have stations memorized, and there is a gap in the sequential order:

i.e. the stations are stored as follows

- 1) 87.1 MHz
- 2) 93.1 MHz
- 3) 94.7 MHz
- 10) 105.9 MHz

(notice there is no stations programmed for pre sets for 4-9), you can have pre set 10 become pre set 4: To sort the numbers, press and hold the **MEMORY** and the ▼ cursor buttons.  
“**PRESET SORT**” will appear on the display and sorting will be done.

**NAME INPUT OF THE PRESET STATION.**

This function allows the name of each preset channel to be entered using alphanumeric characters. Before name inputting, you need to store preset stations with the preset memory operation.

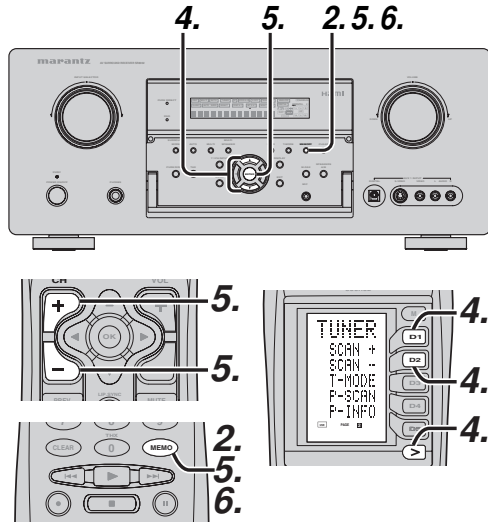

1. Recall the preset number to be inputted name with the method described in "Recalling" a preset station.
2. Press the **MEMORY** button on the front panel or press the **MEMO** button on the remote controller for more than 3 seconds.
3. The left most column of the station name indicator flashes, indicating the character entry ready status.
4. When you press the **▲** or **▼** cursor buttons on the front panel or the **SCAN+** or **SCAN-** buttons on the remote controller (page 4), alphabetic and numeric characters will be displayed in the following order:

A → B → C ... Z → 1 → 2 → 3 ..... 0 → - → +  
 → / → (Blank) → A  
 UP →  
 → DOWN

5. After selecting the first character to be entered, press the **MEMORY** or **ENTER** button, or press the **MEMO** button on the remote controller.

The entry in this column is fixed and the next column starts to flash. Fill the next column the same way.

To move back and forth between the characters, press the **◀/▶** cursor buttons or press **CH+** or **CH-** button on the remote controller.

**Note:**

- Unused columns should be filled by entering blanks.
6. To save the name, press the **MEMORY** or **ENTER** button on the front panel, or press the **MEMO** button on the remote controller for more than 2 seconds.

Instead of using the **▲** and **▼** cursor buttons or the **SCAN+** and **SCAN-** buttons of the remote controller unit to select characters, characters can be input from the numeric keys of the remote controller. See the below table for a correspondence between characters and numeric keys.

Ten keypad	Press, press again, press again, etc.
1	A → B → C → 1 → A
2	D → E → F → 2 → D
3	G → H → I → 3 → G
4	J → K → L → 4 → J
5	M → N → O → 5 → M
6	P → Q → R → 6 → P
7	S → T → U → 7 → S
8	V → W → X → 8 → V
9	Y → Z → space → 9 → Y
0	- → + → / → 0

**Note:**

On the SR8002, when the unit receives HD Radio and RBDS broadcasts, the HD Radio and RBDS text data is displayed. Therefore, the preset station names entered with this function are not displayed.

**FOR LISTENING TO HD Radio STATIONS (SR8002 ONLY)**

HD Radio technology brings digital radio to conventional analog AM and FM radio stations, with improved sound quality, better reception, and new data services.

HD Radio technology provides CD-quality sound for FM stations, and FM-quality sound for AM stations. In addition, FM HD Radio stations can transmit multiple programs on the same frequency by using multicast channels.

Text data display includes station name, song title, artist name, and so on. For more information about HD Radio technology, visit: [www.ibiquity.com](http://www.ibiquity.com)

**TUNING MODE**

HD Radio stations transmit analog and digital signals for broadcast programs. You can change the TUNING mode to the desired signal type.

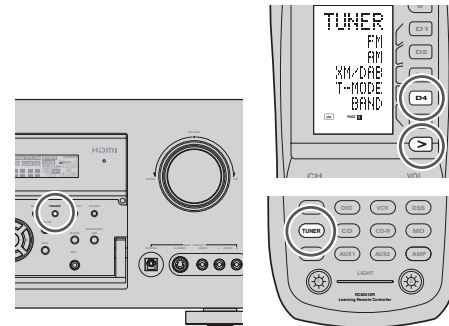

1. Press the **>** button on the remote controller to display Page 2.
2. Each time the **T-MODE (D4)** button is pressed, the TUNER mode changes and the mode is displayed on the FL display.

**Analog/Digital Auto Mode**

T - M O D E : D I G - A T

Use this mode when listening to HD Radio stations. (It is recommended that you normally use this mode.)

AUTO STEREO mode is selected and the AUTO indicator is illuminated on the FL display.

When stereo broadcasts are received, the ST indicator is illuminated on the FL display. When an HD Radio (digital) signal is received, the DIGITAL indicator is illuminated on the FL display.

**Note:**

In this mode, if the strength of the HD Radio signal is weak, the unit automatically changes to Analog mode to receive the analog signal.

**Analog Auto Mode (when receiving FM broadcasts)**

T - M O D E : A N A - A T

In this mode, the unit receives only analog signals and changes to AUTO STEREO mode. See p.68 for more information on Analog received. (Only analog broadcasts are received.)

**Notes:**

- In this mode, HD Radio signals cannot be received. (Only analog broadcasts are received.)
- This mode is not available when BAND is set to AM.

**Analog Mono Mode**

T - M O D E : M O N O

In this mode, the unit receives only analog signals and changes to Monaural mode. See p.68 for more information on Analog Mono Mode.

**Note:**

In this mode, HD Radio signals cannot be received. (Only analog broadcasts are received.)

## HD RADIO AUTO TUNING

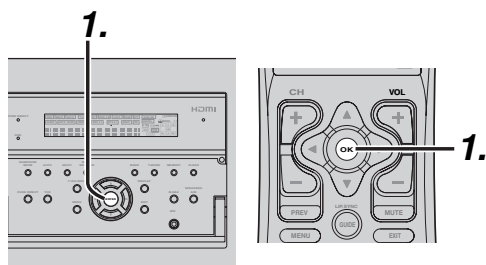

You can use TUNING mode to scan for HD Radio stations.

### (Using the SR8002)

1. Press the **ENTER** button on the front panel.
2. Automatic searching begins then stops when a station is tuned in.

### (Using the remote controller)

1. Press the **OK** button on the remote controller.
2. Automatic searching begins then stops when a station is tuned in.

### Notes:

- When TUNING mode is set to a mode other than Analog/Digital Auto mode (DIG-AT), TUNING mode automatically changes to Analog/Digital Auto mode.
- If tuning does not stop at the desired station, use manual tuning. (See p.67 for the manual tuning operation.)

## SWITCHING HD-RADIO INFORMATION IN THE FRONT PANEL FL DISPLAY

You can display HD Radio information (such as station name, artist name/song title or signal status) for the channel currently selected in the front panel FL display.

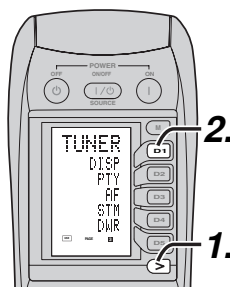

1. Press the > button until PAGE 3 is displayed.
2. Select the information with the **DISP (D1)** button.

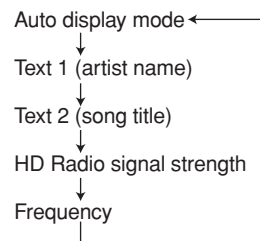

When the auto display mode is displayed:

F M W X Y Z - F M <sup>H<sub>D</sub></sup> 1

When the unit is tuned to an HD Radio station, the station name (call sign) is displayed on the FL display.

### Notes:

- The station name is displayed if the text data from the HD Radio station can be received. If the signal from the radio station is weak, text data may be displayed intermittently or not all.

If the text data cannot be received, the frequency is displayed. The station name is displayed if it has been registered with the preset station name input function.

(See p.70 for information on the PRESET STATION NAME INPUT function.)

- When the unit receives a broadcast with multicast channels, the multicast program number (<sup>H<sub>D</sub></sup> 1) is displayed to the right of the station name displayed on the FL display.

When (<sup>H<sub>D</sub></sup> 1) is displayed, you can select the multicast channel. (See p.72 for information on multicast channels.)

When the Text 1 (Artist name) is displayed:



The "TXT1" is displayed for 2 seconds, followed by the artist's name. If artist's name is more than 13 characters long, the text is scrolled.

### Notes:

- If the signal from a radio station is weak, text data may be displayed intermittently or not all.
- When the unit receives an analog broadcast not from an HD Radio station but from an RBDS station, the radio text is displayed on the FL display. (See p.73 for information on RBDS.)

When the Text 2 (Song title) is displayed:



The "TXT 2" is displayed for 2 seconds, followed by the song title. If song title is more than 13 characters long, the text is scrolled.

### Notes:

- If the signal from a radio station is weak, text data may be displayed intermittently or not all.
- When the unit receives an analog broadcast not from an HD Radio station but from an RBDS station, the program service name is displayed on the FL display. (See p.73 for information on RBDS.)

## CHECKING THE HD Radio SIGNAL STRENGTH



- The HD Radio signal strength of the FL display changes as shown below according to the receiving condition.

HD SIG: ■■■■■■  
**SIGNAL: STRONG**  
 (Signal strength is good)

HD SIG: ■■■■  
**SIGNAL: MARGINAL**  
 (Signal strength is Marginal)

HD SIG: ■■  
**SIGNAL: WEAK**  
 (Signal strength is poor)

HD SIG: ■  
**SIGNAL: NON**  
 (Loss of the signal)

This TUNER information can also be displayed on a TV-monitor connected to the SR8002.

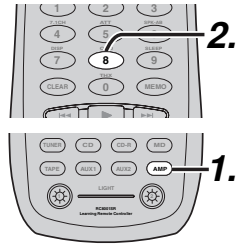

1. Press the **AMP** button on the remote controller.
2. Press the **OSD** button. The following information display will be output.

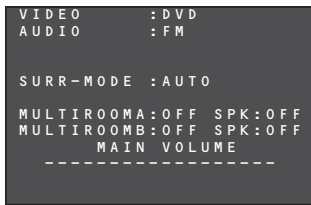

3. When this display appears, press the **OSD** button again. TUNER information like the following will appear.

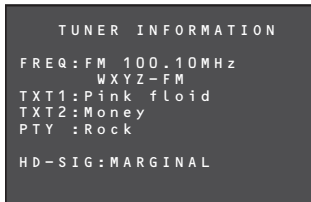

4. Press the **OSD** button again. The information display will go out.

**Note:**

- When the entire TXT1 or TXT2 character string cannot be displayed at once, the display changes to scrolling display. If text data cannot be received, “---” is displayed.

**SELECTING MULTICAST CHANNELS**

FM HD Radio stations can transmit multiple programs on the same frequency by using what are called **MULTICAST CHANNELS**.

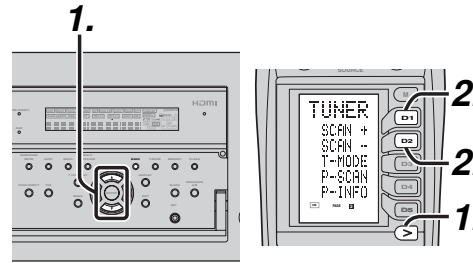

*(Using the SR8002)*

1. Press the **▲** or **▼** cursor buttons on the front panel to select the desired Multicast Channel.

*(Using the remote controller)*

1. Press the **>** button until **PAGE 2** is displayed.
2. Press the **SCAN+ (D1)** or **SCAN- (D2)** button to tune in the deseired Multicast channel.

When the unit receives multicast channels, the multicast program number (<sup>H<sub>b</sub></sup> 2) is displayed to the right of the station name displayed on the FL display.



- This function is not available for AM HD Radio stations because they cannot broadcast multicast channels.
- If the received HD Radio station have multicast channels, the unit scans for frequencies as shown below.

**Example:**

When two multicast channels are broadcast by an HD Radio station at 100.10 MHz

1. Unit receives 99.90 MHz.  
↓ (Press [SCAN +].)
2. Unit receives the main channel of the HD Radio station at 100.10 MHz.  
↓ (Press [SCAN +].)
3. Unit receives multicast channel 1 at 100.10 MHz.  
↓ (Press [SCAN +].)
4. Unit receives multicast channel 2 at 100.10 MHz.  
↓ (Press [SCAN +].)
5. Unit receives 100.30 MHz.  
(The station at 100.10 MHz does not have a third multicast channel, so the next frequency (100.30 MHz) is received.)

**Notes:**

- If digital audio data cannot be received after the station is selected, or if the station signal is weak, the unit may not be able to receive the multicast channels.
- If the station signal is weak, the digital audio of the multicast channel may cut out. In this case, “LOADING” is displayed on the FL display.
- If the digital signal of the multicast channel cannot be received, “OFF AIR” is displayed on the FL display and the main channel is selected.
- Multicast channels cannot be received on AM broadcasts.

**PTY AUTO SEARCH**

You can use the Program Type information search function for some HD Radio stations. See **PTY AUTO SEARCH** on p.73.



## RBDS OPERATION (SR8002 ONLY)

RBDS (Radio Broadcast Data System) is a description of the station's programming hidden space in the FM signal.

Your new unit is equipped with RBDS to assist in the selection of FM stations using station and network names, rather than broadcast frequencies. Additional RBDS functions include the ability to search for programme types.

### Note:

When the unit is receiving an HD Radio (digital) signal, the HD Radio text data is displayed instead of the RBDS data.

## RADIO TEXT

Some RBDS stations broadcast RADIO TEXT, which is additional information on the station and programme being broadcast.

RADIO TEXT information appears as 'running' text in the display. RADIO TEXT is transmitted character by the radio station. As a result of that it may take some time until the entire text has been completely received.

## RBDS DISPLAY

When a unit is tuned to an FM station that is transmitting RBDS data, the Front Panel Information Display will automatically show the call sign or RBDS TEXT in place of the typical display of the station's broadcast frequency.

To change the display, press the **TUNER** button and press the the > button until PAGE3 is displayed. Select the information with the **DISP (D1)** button.

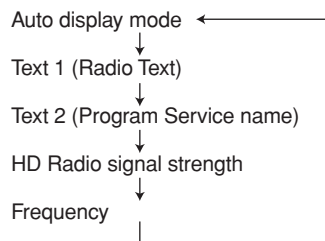

When the auto display mode is displayed:

F M W X Y Z

When the unit is tuned to an RBDS station, the station name (call sign) is displayed on the FL display.

### Notes:

When the unit receives the RBDS text data from a station, the station name is displayed. If the signal from the radio station is weak, text data may be displayed intermittently or not at all.

If the text data cannot be received, the frequency is displayed. You can use the preset station name input function to register the station name. The registered station name is then displayed.

(See p.70 for information on the PRESET STATION NAME INPUT function.)

When the Text 1 (Radio Text) is displayed:

T X T 1  
↓  
P i n k F l o i d

The "TXT1" is displayed for 2 seconds, followed by the Radio Text (RT). If RT is more than 13 characters long, the text is scrolled.

### Notes:

- If the signal from an radio station is weak, text data may be displayed intermittently or not at all.
- When the unit is tuned to an HD Radio station, the artist name is displayed on the FL display. (See p.71 for information on HD Radio technology.)

When the Text 2(Program service name) is displayed:

T X T 2  
↓  
M o n e y

The "TXT 2" is displayed for 2 seconds, followed by the Program Service (PS). If PS is more than 13 characters long, the text is scrolled.

### Notes:

- If the signal from an radio station is weak, text data may be displayed intermittently or not at all.
- When the unit is tuned to an HD Radio station, the song title is displayed on the FL display. (See p.71 for information on HD Radio technology.)

## CHECKING THE HD Radio SIGNAL STRENGTH

H D S I G :

- The signal strength is only displayed when the unit is tuned to a digital HD Radio station. "SIGNAL: NON" is displayed when receiving an analog signal.

- You can view the tuner information on a TV monitor when connected to the SR8002. (See p.33, 34 for the operation details.)

## PTY AUTO SEARCH

Your unit is equipped to automatically search for stations transmitting any of 29 different programme types. To search for a PTY, follow these procedures:

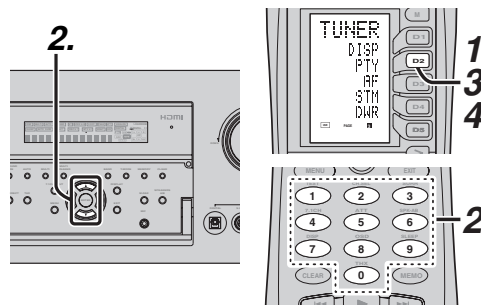

1. Press the **PTY** button in the **TUNER MODE** on the remote controller. The current station's PTY will be displayed, or the currently selected PTY group will be displayed in blinking if no station or RBDS data is present.
2. To change to a new PTY type, press the **TUNING ▲** or **▼** button on the front panel or **numeric** buttons on the remote controller until the desired PTY is shown in the display.
3. Once the desired PTY group or type has been selected, press the **PTY** button while the display blink (approx. 5 seconds). The PTY Auto search will start, and the tuner will pause at each station broadcasting RBDS PTY information corresponding to the selected choice.
4. To advance to the next RBDS station with the desired PTY, press the **PTY** button again within 5 seconds.

### Notes:

- Not all RBDS stations and HD Radio stations broadcast PTY information.
- PTY AUTO SEARCH may not function for stations with weak signals if the unit is unable to detect the information needed for the search.

NUMBER	DISPLAY	PROGRAMME TYPE
1	NEWS	News
2	INFORM	Information
3	SPORTS	Sports
4	TALK	Talk
5	ROCK	Rock
6	CLS ROCK	Classic Rock
7	ADLT HIT	Adult Hits
8	SOFT RCK	Soft Rock
9	TOP 40	Top 40
10	COUNTRY	Country
11	OLDIES	Oldies
12	SOFT	Soft
13	NOSTALGA	Nostalgia
14	JAZZ	Jazz
15	CLASSICL	Classical
16	R & B	Rhythm and Blues
17	SOFT R&B	Soft Rhythm and Blues
18	LANGUAGE	Foreign Language
19	REL MUSC	Religious Music
20	REL TALK	Religious Talk
21	PERSNLTY	Personality
22	PUBLIC	Public
23	COLLEGE	College
24	WEATHER	Weather
25	ALERT!	Emergency
26	TRAFFIC	Traffic
27	GOVERMNT	Government
28	EMERGNCY	Emergency
29	READSVCS	Radio Reading Services
30	PRIVSVCS	Private Services

**LISTENING TO XM SATELLITE RADIO**

**SELECTING AN INPUT SOURCE**

Before you can listen to XM Satellite Radio, you must first select the input source on the unit.

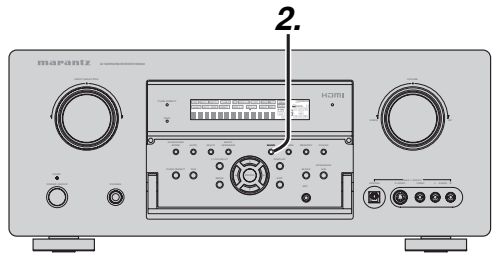
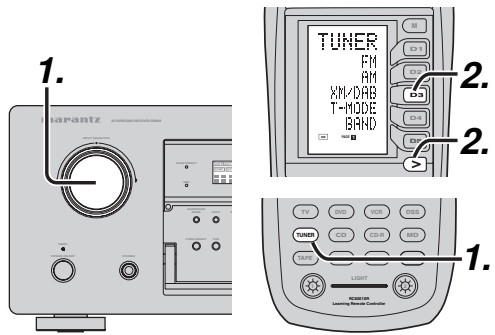

*(Using the unit)*

1. Turn the **INPUT SELECTOR** knob to select "TUNER".
2. Press the **BAND** button to select either XM or DAB.

*(Using the remote controller)*

1. To select tuner, Press the **TUNER** button twice within two seconds on the remote controller.
2. Press the **>** button until PAGE 1 is displayed. Select XM or DAB with the **D3** button.

**CHECKING THE XM SIGNAL STRENGTH AND RADIO ID**

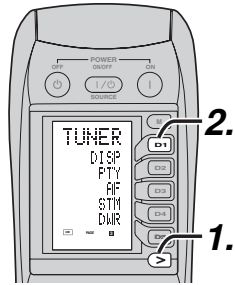

1. Press the **>** button until PAGE 3 is displayed.
2. Press the **D1 (DISP)** button four times to display the signal status on the front display of the unit.



- The display changes as shown below according to the receiving condition.

SIGNAL: ■■■■■■  
**SIGNAL: STRONG**  
 (Signal strength is good)

SIGNAL: ■■■■  
**SIGNAL: MARGINAL**  
 (Signal strength is Marginal)

SIGNAL: ■■  
**SIGNAL: WEAK**  
 (Signal strength is poor)

XM NO SIGNAL  
**SIGNAL: NON**  
 (Loss of the signal)

3. Adjust the antenna location until signal strength is good.
4. Select channel 0 (XM000) with the **▲** or **▼** cursor buttons of the unit or the **SCAN +** or **SCAN -** buttons of the remote controller.

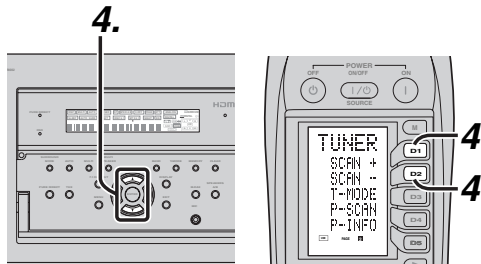

- The Radio ID is displayed.



**Note:**

- If "ANTENNA" appears in the front panel display, the XM Mini-Tuner and Home Dock may not be connected to the XM terminal on the rear panel of this unit properly.

**SWITCHING XM INFORMATION IN THE FRONT PANEL DISPLAY**

You can display XM information (such as artist name/ song title, category or signal status) for the channel currently selected in the front panel display.

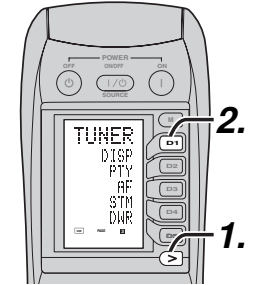

1. Press the **>** button until PAGE 3 is displayed.
2. Select the information with the **DISP (D1)** button.

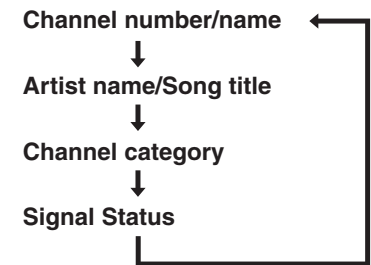

When the Channel number/name mode is displayed:

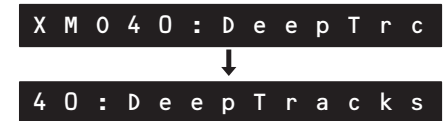

(If text is more than 13 characters long, the text is scrolled.)

When the Artist name/Song title is displayed:

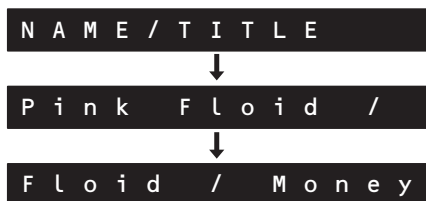

The "NAME/TITLE" is displayed for 2 seconds, followed by the artist's name and song title. (If artist's name or song title is more than 13 characters long, the text is scrolled.)

When the channel category is displayed:



**Note:**

- To change the display content from XM information to unit functions, do so from the display mode. (See "DISPLAY MODE" on page 47)

This XM information can also be displayed on a TV monitor connected to the unit.

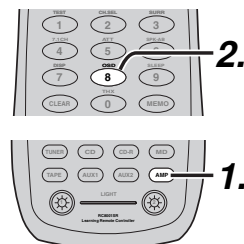

1. Press the **AMP** button on the remote controller.
2. Press the **OSD** button. The following information display will be output.

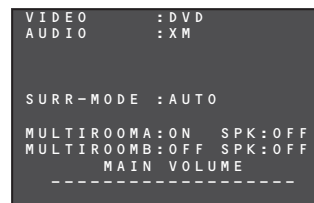

3. When this display appears, press the **OSD** button again. XM information like the following will appear.

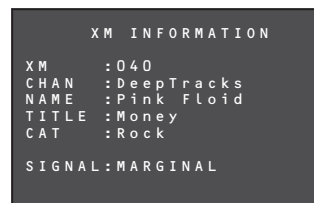

4. Press the **OSD** button again. The information display will go out.

**Note:**

- If the information contains a character that cannot be recognized by that unit, the character will be displayed with " "(space).

**SEARCH MODE**

You can search for the channel you want to listen to using one of three search modes. You can also enter the number directly to select the desired channel.

**ALL CHANNEL SEARCH MODE**

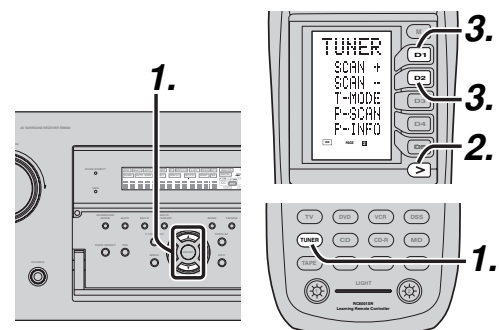

*(Using the unit)*

1. Press the **▲** or **▼** cursor button on the front panel to select the desired station.

*(Using the remote controller)*

1. Press the **TUNER** button twice within two seconds on the remote controller.
2. Press the **>** button until PAGE 4 is displayed.
3. Press and hold the **SCAN+ (D1)** or **SCAN- (D2)** button.

**PRESET SEARCH MODE**

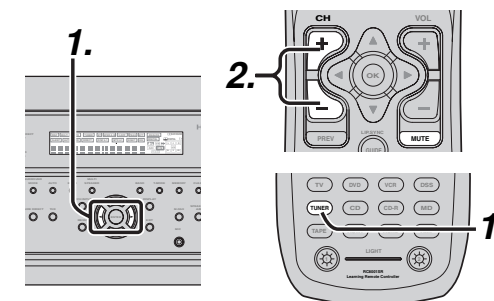

*(Using the unit)*

1. Press the **◀** or **▶** cursor button on the front panel to select the desired preset station.

*(Using the remote controller)*

1. Press the **TUNER** button twice within two seconds on the remote controller.
2. **CH+** or **CH-** button to tune in the desired preset station.  
Or enter the preset station number with the numeric buttons.

**CATEGORY SEARCH MODE**

You can select the desired channel from the category allocated to each channel. Category being aired can be only selected.

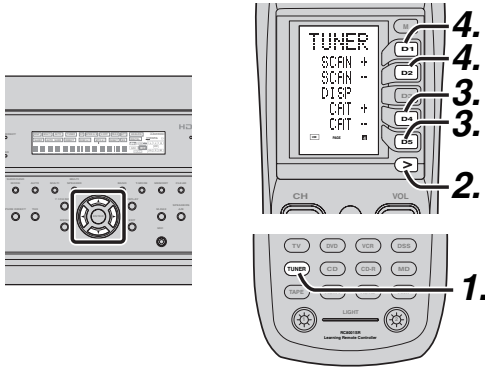

*(Using the unit)*

1. Press the **ENTER** button on the front panel.
2. Press the ◀ or ▶ button on the front panel to select the desired Category.
3. After selecting the Category, Press the ▲ or ▼ cursor button to select the desired station of the category.
4. You can return to the normal mode by press the **ENTER** button during Category Search Mode.

*(Using the remote controller)*

1. Press the **TUNER** button twice within two seconds on the remote controller.
2. Press the > button until PAGE 4 is display.
3. Press the **CAT+ (D4)** or **CAT- (D5)** button.
4. After selecting the category, Press the **SCAN+ (D1)** or **SCAN- (D2)** button to select the desired station of the category.
5. You can return to the normal mode by press the **OK** button during Category Search Mode.

**Note:**

- Category search ends automatically about 5 seconds after the last operation.

**CHANNEL DIRECT CALL**

You can select the desired channel by directly tapping the numeric keypads on the remote controller.

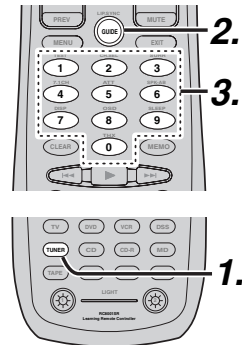

1. Press the **TUNER** button twice within two seconds on the remote controller.
2. Press the **GUIDE**.  
“XM - -” will appear on the display.
3. Input the three digit number for your desired Channel with the numeric keypad on the remote controller.
4. The desired channel will automatically be tuned.

**Note:**

- If there is no input on the keypad for 5sec., the input is cancelled to return to the original display

**Notes:**

- “LOADING” is displayed while receiving the channel or information.
- “UPDATING” is displayed while updating encryption code.
- When the selected channel is not available, “XM - -” is displayed.
- “OFF AIR” is displayed while air is suspended (e.g. midnight).

**PRESET MEMORY**

You can store the desired channel in the Preset Memory. (You can preset 60 XM Radio stations in addition to FM/AM stations.)

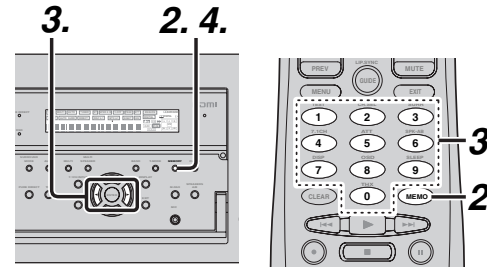

*(Using the unit)*

1. Tune into the desired channel.
2. Press the **MEMORY** button on the front panel.  
“- -” (preset number) starts blinking on the display.

- - X M 0 4 0

3. Select the preset number by pressing the ◀ or ▶ cursor buttons, While this is still blinking (approx. 5 seconds)

0 1 X M 0 4 0

4. Press the **MEMORY** button again to enter.  
The display stops blinking.  
The station is now stored in the specified preset memory location.

*(Using the remote controller)*

1. Tune into the desired channel.
2. Press the **MEMO** button on the remote controller. “- -” (preset number) starts blinking on the display.
3. Enter the desired preset number by pressing the **numeric** buttons.

**Note:**

- When entering a single digit number (2 for example), either input “02” or just input “2” and wait for a few seconds.

**CHECKING THE XM PRESET CHANNEL**

The preset channel can be checked on the on screen display.

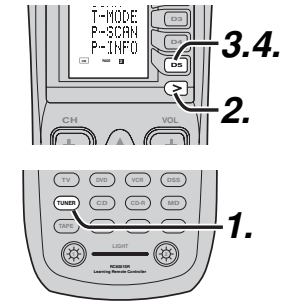

*(Using the remote controller)*

1. Press the **TUNER** button twice within two seconds on the remote controller.
2. Press the > button until PAGE 2 is display.
3. Press the **P-INFO (D5)** button. to view a list of tuner preset channel on the on screen display.
4. If there are 10 or more preset channel, Press the **P-INFO** button. again.

XM PRESET LIST			
NO.	1	XM010	XXXXXXXXXX
NO.	2	XM011	XXXXXXXXXX
NO.	3	XM015	XXXXXXXXXX
NO.	4	XM022	XXXXXXXXXX
NO.	5	XM125	XXXXXXXXXX
NO.	6	XM001	Preview
NO.	7	XM001	Preview
NO.	8	XM001	Preview
NO.	9	XM001	Preview
NO.	10	XM001	Preview

**Note:**

- The preset channel indication disappears in about 5 sec.

### PRESET SCAN

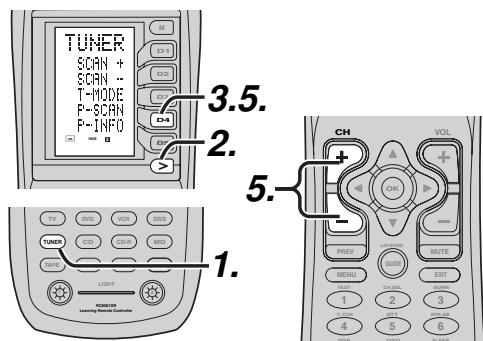

1. Press the **TUNER** button twice within two seconds on the remote controller.
2. Press the > button until PAGE 2 is displayed.
3. press the **P-SCAN (D4)** button on the remote controller. "PRESET SCAN" appears on the display and then the preset station with the lowest preset number is recalled first.
4. Preset stations are recalled in sequence (No.1 → No.2 → etc.) for about 5-10 seconds each. The time changes by the received condition. No stored preset number will be skipped.
5. Pressing the **CH+** button during prescanning speeds up scanning.

Also, pressing the **CH-** button returns to the previous preset station.

When the desired preset station is received, cancel the preset scan operation by press the **P-SCAN (D4)** button.

### CLEARING STORED PRESET STATIONS

You can remove preset stations from the memory using the following procedure.

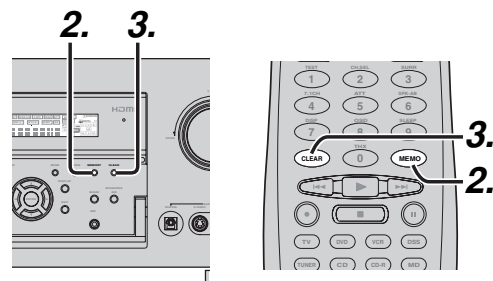

1. Recall the preset number to be cleared with the method described in "PRESET SEARCH MODE".
2. Press the **MEMORY** button on the front panel or Press the **MEMO** button on the remote controller.
3. The stored preset number blinks in the display for 5 seconds. While blinking, Press the **CLEAR** button on the front panel or the remote.
4. "xx CLEAR" appears on the display to indicate that the specified preset number has been cleared.

**Note:**

- To clear all stored preset stations, press and hold the **CLEAR** and the **ENTER** buttons for two seconds.
- There are 60 preset channels prepared at the factory default. The 60 channels are all set to "CHANNEL 001". Each channel can be stored in the preset memory. You can search for only the preset channels.

### NEURAL SURROUND MODE

When the XM Satellite Radio broadcast received supports XM HD Surround Sound, Surround playback is possible in Neural Surround mode.

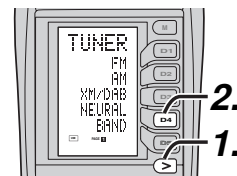

1. Press the > button until PAGE 2 is displayed.
2. Press the **NEURAL (D4)** button to tune in the Neural surround mode.

**Note:**

For information on Neural Surround, see page 63.



# MULTI ROOM SYSTEM

The Multiroom System mode allows the same source or different sources to be heard in two rooms other than where this unit is installed.

To use the multiroom system, connect the audio from the MULTI OUT A and B AUDIO output terminals to the MULTI ROOM A and B amps.

**Note:**

- The SR7002 does not have a MULTI ROOM B setting.

Connect the VIDEO output (MULTI OUT) terminal to the monitor in Room A. (MULTI VIDEO OUT terminal is linked to the source selector in Multi Room A.)

If a surround channel back speaker or speaker C (see page 38) are not used in the room where this unit is installed, the multi speaker system can be used with the amp for the surround back channel.

Also, the COMPONENT VIDEO MONITOR OUT 2 terminal can be used for the monitor output of Room A. (This feature cannot be used with the SR7002.)

This unit supports multiroom system functions such as source selectors, OSD menu systems, sleep timers and remote control.

## MULTI ROOM PLAYBACK USING THE MULTI ROOM OUT TERMINALS

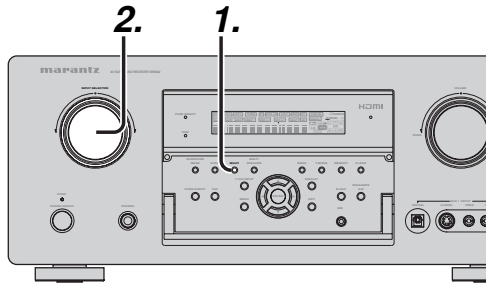

1. Pressing the **MULTI** button on the unit one time accesses the MULTI ROOM A settings. Pressing it two times accesses the MULTI ROOM B settings. Then, pressing it a third time turns the multiroom feature off. (The SR7002 does not have a MULTI ROOM B setting.)
2. When the MULTI ROOM setting mode is engaged, one of the following screens appears on the display for 10 seconds.

– SR8002 –

- \* Display when MULTI ROOM A is selected



- \* Display when MULTI ROOM B is selected



– SR7002 –



3. Select an input source with the **INPUT SELECTOR** knob.
4. Turn the **VOLUME** knob to set the volume of the room used in the multi room system as you like.

**Note:**

- The sleep timer, monaural output and other features can also be set using the MAIN MENU. (See page 55)

## MULTI ROOM PLAYBACK USING THE MULTI SPEAKER TERMINALS

This unit allows you to connect another set of speakers and place them in a different room or separated area for listening to music.

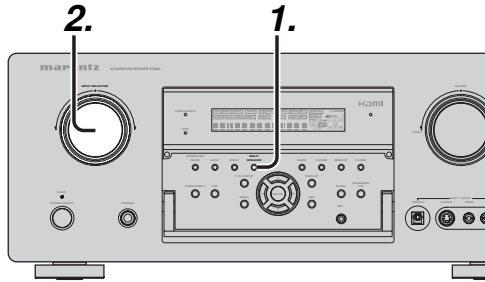

1. Pressing the **MULTI SPEAKER** button on the unit one time accesses the MULTI SPEAKER A settings. Pressing it two times accesses the MULTI SPEAKER B settings. Then, pressing it a third time turns the MULTI SPEAKER feature off. (The SR7002 does not have a MULTI SPEAKER B setting.)
2. When the MULTI SPEAKER setting mode is engaged, one of the following screens appears on the display for 10 seconds.

– SR8002 –

- \* Display when MULTI SPEAKER A is selected



- \* Display when MULTI SPEAKER B is selected



– SR7002 –



3. Select an input source with the **INPUT SELECTOR** knob.
4. Turn the **VOLUME** knob to set the volume of the room used in the multiroom system as you like.

**Note:**

- The sleep timer, monaural output and other features can also be set using the MAIN MENU. (See page 55.)

**Notes for Multi Room Speaker**

- The Multiroom Speaker mode can be set for only one of the rooms, A or B.
- The MULTIROOM SPEAKER output terminals can be used when Surround Back Speaker = "NONE" in the SPEAKER SETUP menu. (See SPEAKER SETUP, page 45)
- "The Surr. Back Speakers are in use" is displayed when the **MULTI SPEAKER** button is pressed when the Surround Back Speaker is not set to "NONE" in the SPEAKER SETUP menu. (See SPEAKER SETUP, page 45)
- The Multispeaker mode cannot be used at the same time as the speaker C. When connecting for multiroom use, set the **SPEAKER C** selector switch on the rear panel to OFF.

### OPERATION OF THE MULTI ROOM OUTPUTS WITH THE REMOTE CONTROL FROM MULTI A

Room A output can be operated from a room where the unit (SR7002 or SR8002) is not installed. This requires a separately sold IR receiver. (For connections, see page 37.)

### CHANGE THE MULTI ROOM CONTROL COMMANDS (RC101) FOR MULTIROOM A

- (When operating the unit by Multi Zone connected)
- Zone A: MULTI ROOM A Control (Default)
  - Zone B: MULTI ROOM B Control (The SR7002 does not use this zone.)

Change the control commands for each zone.

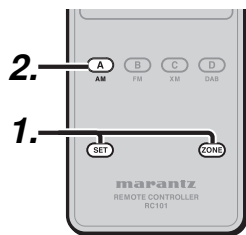

1. Press **SET** button and **ZONE** button until the SEND indicator blinks twice. Then backlight flashes.
2. Press A zone button. When the procedure is successful, the SEND indicator will blink twice.

These buttons change a special code of each zone.

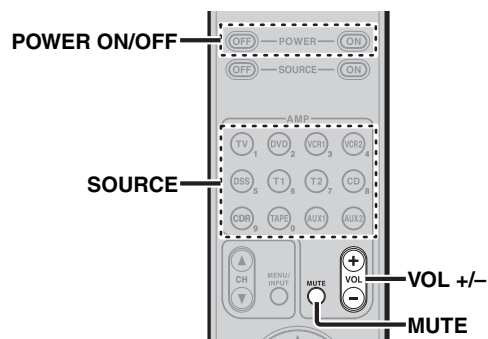

Tuner mode operation remote code (Refer to page 26)

### Notes for the Multi Room System

- If the Tuner (FM or AM) is active in the main room, you can not control any function of the tuner. In this case, You must listen to the same station as the main room.

### OSD INFORMATION FOR THE MULTIROOM A SETUP

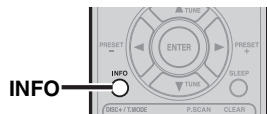

Press the INFO button to view the current setup as shown below on a TV monitor connected to MULTI VIDEO OUTPUT.

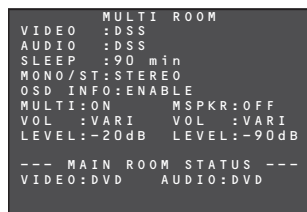

### OPERATION OF THE MULTI ROOM OUTPUTS WITH THE REMOTE CONTROL FROM MULTI B

Room B output can be operated from a room where the unit (SR7002 or SR8002) is not installed. This requires a separately sold IR receiver. (For connections, see page 37.)

### Note:

The SR7002 does not use MULTIROOM B.

### CHANGE THE MULTI ROOM CONTROL COMMANDS (RC101) FOR MULTIROOM B

Change the control commands for each zone.

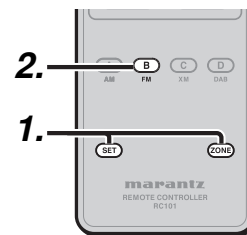

1. Press **SET** button and **ZONE** button until the SEND indicator blinks twice. Then backlight flashes.
2. Press B zone button. When the procedure is successful, the SEND indicator will blink twice.

These buttons change a special code of each zone.

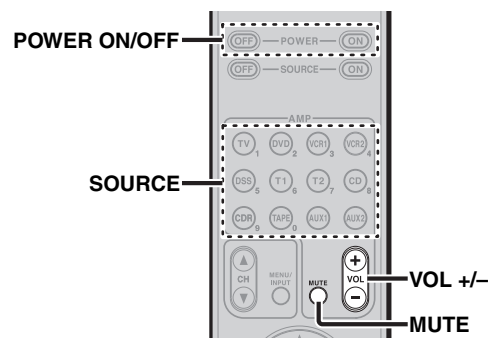

Tuner mode operation remote code (Refer to page 26)

### Notes for the Multi Room System

- If the Tuner (FM or AM) is active in the main room, you can not control any function of the tuner. In this case, You must listen to the same station as the main room.

### OPERATION OF THE MULTI SPEAKER OUTPUTS WITH THE REMOTE CONTROL

To switch to MULTI SPEAKER SYSTEM (A or B) control, perform the following operations with the RC101 set to MULTI ROOM A or MULTI ROOM B.

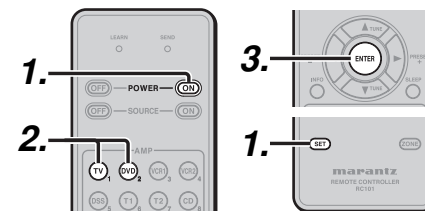

1. Press **SET** button and **POWER ON** button until the SEND indicator blinks twice. Then backlight flashes.
2. Press the **DVD** button.
3. Press **ENTER** button once to lock in the code. When the procedure is successful, the SEND indicator will blink twice.

### Note

Press the TV button at this time to return to the MULTI ROOM settings.

# TROUBLESHOOTING

In case of trouble, check the following before calling for service:

1. Are the connections made properly ?
2. Are you operating the unit properly following the user's guide ?
3. Are the power amplifiers and speaker working properly ?

If the unit does not operate properly, check items shown in the following table.  
 If your trouble cannot be recovered with the remedy actions listed in the following table, malfunction of the internal circuitry is suspected; immediately unplug the power cable and contact your dealer, nearest Marantz authorized dealer or the Marantz Service Center in your country.

SYMPTOM	CAUSE	REMEDY
This unit cannot be turned up.	The power plug is not connected.	Connect the power plug to the outlet.
No sound and picture are output even when power is on.	Mute is on.	Cancel mute using the remote controller.
	The input cable is not connected correctly.	See the connection diagram and connect the cables correctly.
	The master volume control is turned all the way down.	Adjust the master volume.
No speaker output.	The headphones are connected to the headphone jack.	Disconnect the headphones. (Speakers will not output sound when headphones are connected.)
	The function selector position is wrong.	Select correct position.
Incorrect Audio or Video for selected source.	Input cable connected incorrectly.	Connect the cable correctly by referring to the connection diagram.
Incorrect Audio from a channel.	Speaker cable connected incorrectly.	Connect the cable correctly by referring to the connection diagram.
No Audio output from the center channel speaker.	The center speaker cable connection is incomplete.	Connect the cable correctly.
	STEREO has been selected for Surround mode.	When STEREO is selected for Surround mode, no sound will be output from the center speaker. Set another Surround mode.
	Center = NONE has been selected in SETUP mode.	Make the correct setting.
No Audio output from the surround speakers.	The surround speaker cable connection is incomplete.	Connect the cable correctly.
	STEREO has been selected for Surround mode.	When STEREO has been selected for Surround mode, no sound will be output from the surround speaker. Set another Surround mode.
	Surround = NONE has been selected in SETUP mode.	Make the correct setting.
No Audio output from the surround back speakers.	The surround back speaker cable connection is incomplete.	Connect the cable correctly.
	Surround mode is not EX/ES mode.	Set surround mode EX/ES.
	Surround back = NONE has been selected in SPEAKERS SIZE SETUP	Make the correct setting.

SYMPTOM	CAUSE	REMEDY
Can not select EX/ES mode.	Surround center= NONE has been selected in SPEAKERS SIZE SETUP	Make the correct setting.
	Input signal is incompatible.	Use 5.1 channel source.
Can not select Pro Logic IIx mode.	Input signal is incompatible.	Use 2 channel Dolby Digital input signal, PCM input signal or analog input signal.
Can not select Neo:6 mode.	Input signal is incompatible.	Use 2 channel DTS input signal, PCM input signal or analog input signal.
Can not select CSII mode.	Input signal is incompatible.	Use 2 channel Dolby Digital input signal, PCM input signal or analog input signal.
No output to Subwoofer Out.	Subwoofer = NONE has been selected in SETUP mode.	Select Subwoofer = YES.
Noise is produced during DTS-encoded CD or laser disc play.	Analog has been selected for input.	Be sure to perform digital connection, select digital input, then play.
A specific channel does not produce output.	Nothing recorded on source.	Check the encoded channel on the source side.
FM or AM reception fails.	Antenna connection is incomplete.	Correctly connect the indoor FM and AM antennas to FM and AM antenna outlets.
Noise is heard during AM reception.	Reception is affected by other electrical fields.	Try changing location where the AM indoor antenna is set up.
Noise is heard during FM reception.	The radio waves from the broadcasting station are weak.	Install an FM outdoor antenna.
Cannot get programmed station when the PRESET button is pressed.	Preset data has been erased.	Disconnecting power plug for long periods of time will erase preset data. If that happens, input the preset data again.
Control with the remote controller fails.	Batteries are consumed.	Replace all the batteries with new ones.
	Remote controller's function-key setting is wrong.	Select different position from which equipment will be controlled.
	The distance between this unit and the remote commander is too far.	Move closer to this unit.
	Something is blocking the unit and the remote commander.	Remove offending object.
Auto Setup (SPEAKER SETUP) is not working.	Headphones are connected.	Disconnect the headphones.

**HDMI**

SYMPTOM	CAUSE	REMEDY
The display does not appear over an HDMI connection.	The connected monitor or projector does not support HDCP.	
	The HDMI input of on the TV is not on.	Set HDMI input so that it turns on, as explained in the TV's instruction manual.
	The HDMI output on the source component (DVD, Set Top Box, etc.) is not on.	Set HDMI output so that it turns on, as explained in the source component's instruction manual.
	The HDMI mode is not correctly set on the unit.	Set HDMI input on the FUNC INPUT SETUP menu as explained on page 43.
	The HDMI output video resolution of the source component (DVD, Set Top Box, etc.) does not match the TV specifications.	Set the resolution so that it matches, as explained in the instruction manuals of both components.
	The device is connected with a non-standard HDMI cable.	A 5 m or shorter cable is recommended to ensure stable operation and prevent image quality deterioration.
	Power to the unit is off. (When the unit is on standby, HDMI connections cannot be turned on.)	Turn on the power to the unit.
The connection between HDMI components was not authenticated.	Shut off and then turn the power back on to the unit, TV and source component.	
Time is needed for the display of an HDMI connection to appear.	The connection is being authenticated between the HDMI devices.	There is nothing wrong with the system. Some HDMI devices require time for authentication.
Audio is not played back over an HDMI connection.	The HDMI audio output of the source component (DVD, Set Top Box, etc.) is not on.	Set the HDMI audio output so that it turns on, as explained in the source component's instruction manual.
	The signal format of the source component (DVD, Set Top Box, etc.) is not supported by the unit.	Set the HDMI audio output so that it can connect to the unit, as explained in the source component's instruction manual.
	This unit is set to the HDMI audio "THROUGH" mode.	In the "THROUGH" mode, sound is not produced from the unit. Set it to "ENABLE". (see page 54)
DVD-Audio is not played back over an HDMI connection.	The DVD player does not support CPPM, therefore it cannot output HDMI audio.	<ul style="list-style-type: none"> <li>• Use a DVD-Audio player that supports CPPM.</li> <li>• Turn on PCM downsampling on the DVD player.</li> <li>• Use an analog connection.</li> </ul>

**XM SATELLITE RADIO**

If a problem should arise, first check the following.

1. Are the connections correct?
2. Have you operated the receiver according to the operating instructions?
3. Are the speakers and other components operating properly?

If this unit is not operating properly, Check the items listed in the table below. Should the problem persist, there may be a malfunction. Disconnect the power immediately and contact your store of purchase.

SYMPTOM	CAUSE	REMEDY
"ANTENNA" is displayed.	XM terminal and the XM Mini-Tuner and Home Dock is not properly connected.	Check that the connection are correct.
"NO SIGNAL" is displayed.	The signal cannot be received.	Reposition your XM Mini-Tuner and Home Dock.
Receiving only XM channels 0 and 1.	The XM Tuner is not activated.	Contact XM Radio.

**HD Radio RECEPTION**

SYMPTOM	CAUSE	REMEDY
The signal is not digital, even when receiving from an HD Radio station. (SR8002 only)	Reception is affected by other electrical fields. (AM)	Try changing location where the AM indoor antenna is set up.
	The radio waves from the broadcasting station are weak. (FM)	Install an FM outdoor antenna.
The signal sometimes switches from digital to analog or the sound cuts out when receiving from an HD Radio station. (SR8002 only)	Reception is affected by other electrical fields. (AM)	Set the TUNER MODE to Analog Auto mode or Analog Mono mode.
	The radio waves from the broadcasting station are weak. (FM)	<b>Note:</b> In this case you cannot receive a digital signal. (See page.70)

**PROTECTIVE FEATURE**

In some cases, the STANDBY indicator may blink slowly, twice per second. In this case, turn off the unit, unplug the power cord, and check the following points.

- Make sure the speaker cables are not reversed and connected to the wrong sides (+ and -) on the unit.
- Make sure the speaker cables connected to the unit are not shorted. (Check both the unit end and the speaker end.)
- Make sure the volume does not exceed the level that the unit is capable of producing.
- When using the unit in a rack or other enclosed space, heat may build up inside the unit and cause a fire. When installing the unit, be sure to leave sufficient space between the top, back and both sides of the unit and walls or other AV components to prevent the internal temperature from rising.

After checking these points, plug in the power cord and use the remote controller to turn on the unit. Turn down the volume before resuming playback. Confirm that there are no problems with the speaker connections and playback performance.

If this symptom recurs, request service at your nearest service center.

In rare instances, the unit may enter standby mode and the STANDBY indicator may blink rapidly, 8 times per second. In this case, unplug the power cord and request service at your nearest service center.

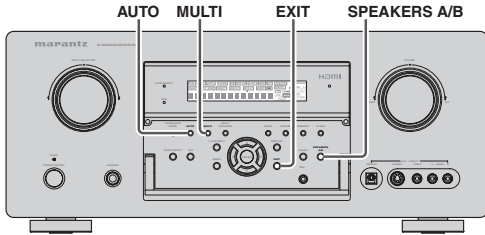

**FRONT KEY (BUTTON) LOCK OF THE UNIT**

To lock all front panel buttons (except the POWER ON/OFF button) and the INPUT SELECTER and VOLUME knobs, hold the AUTO and EXIT buttons on the front panel simultaneously for at least 3 seconds. At this time, "F-KEY LOCK!" is displayed. To unlock the controls, press the same buttons again simultaneously for at least 3 seconds. At this time, "F-KEY UNLOCK" is displayed, and the buttons are released.

**GENERAL MALFUNCTION**

If the equipment malfunctions, this may be because an electrostatic discharge or AC line interference has corrupted the information in the equipment memory circuits. Therefore:

- disconnect the plug from the AC line supply
- after waiting at least three minutes, reconnect the plug to the AC line supply
- re-attempt to operate the equipment

**Memory backup**

- In case a power outage occurs or the power cord is accidentally unplugged, this unit is equipped with a backup function to prevent memory data such as the preset memory from being erased.

**HOW TO RESET THE UNIT**

Should the operation or display seem to be abnormal, reset the unit with the following procedure. This unit is turned on, press and hold the **MULTI + SPEAKERS A/B** buttons simultaneously for 3 seconds or more. Remember that the procedure will reset the settings of the function selector, Surround mode, delay time, TUNER PRESET etc., to their initial settings.

**TECHNICAL SPECIFICATIONS**

**FM TUNER SECTION**

Frequency Range .....	87.5 – 107.9 MHz
Usable Sensitivity .....	IHF 1.8 μV/16.4 dBf
Signal to Noise Ratio .....	Mono/Stereo 75/70 dB
Distortion.....	Mono/Stereo 0.2/0.3 %
HD Radio (SR8002 only) .....	0.02 %
Stereo Separation.....	1 kHz 45 dB
HD Radio (SR8002 only).....	1 kHz 85 dB
Alternate Channel Selectivity.....	± 400 kHz 60 dB
Image Rejection.....	98.1 MHz 70 dB
Tuner Output Level .....	1 kHz, ± 75 kHz Dev 800 mV

**AM TUNER SECTION**

Frequency Range .....	530 – 1710 kHz
Signal to Noise Ratio .....	50 dB
Usable Sensitivity .....	Loop 500μV
Distortion.....	.400Hz, 30 % Mod. 0.5 %
HD Radio (SR8002 only).....	1Hz, 0.02 %
Selectivity.....	± 20 kHz 70 dB

**AUDIO SECTION**

**SR7002**

Power Output (20 Hz – 20 kHz/THD=0.08%)	
Front L&R .....	8 ohms 110 W / Ch
Center .....	8 ohms 110 W / Ch
Surround L&R .....	8 ohms 110 W / Ch
Surround Back L&R.....	8 ohms 110 W / Ch
Front L&R .....	6 ohms 140 W / Ch
Center .....	6 ohms 140 W / Ch
Surround L&R .....	6 ohms 140 W / Ch
Surround Back L&R.....	6 ohms 140 W / Ch

**SR8002**

Power Output (20 Hz – 20 kHz/THD=0.08%)	
Front L&R .....	8 ohms 125 W / Ch
Center.....	8 ohms 125 W / Ch
Surround L&R.....	8 ohms 125 W / Ch
Surround Back L&R.....	8 ohms 125 W / Ch
Front L&R .....	6 ohms 160 W / Ch
Center.....	6 ohms 160 W / Ch
Surround L&R.....	6 ohms 160 W / Ch
Surround Back L&R.....	6 ohms 160 W / Ch

Input Sensitivity/Impedance.....	168 mV/ 47 Kohms
Signal to Noise Ratio(Analog Input / Pure Direct) .....	105 dB
Frequency Response	
(Analog Input / Pure Direct)	8 Hz – 100 kHz (± 3 dB)
(Digital Input / 96 kHz PCM)	8 Hz – 45 kHz (± 3 dB)

**VIDEO**

Television Format.....	NTSC
Input Level/Impedance .....	1 Vp-p/75 ohms
Output Level/Impedance.....	1 Vp-p/75 ohms
Video Frequency Response .....	5 Hz to 8 MHz (–1 dB)
Video Frequency (Component) .....	5 Hz to 80 MHz (–1 dB)
S/N.....	60 dB

**HDMI**

Version.....	1.3a [INPUT]
.....	1.3a [OUTPUT]

**GENERAL**

Power Requirement.....	AC 120 V 60 Hz
Power Consumption .....	6.5A (SR7002)
.....	6.7A (SR8002)
Weight.....	33.1 lbs (15.0 Kg) (SR7002)
.....	33.1 lbs (15.0 Kg) (SR8002)

**DIMENSIONS**

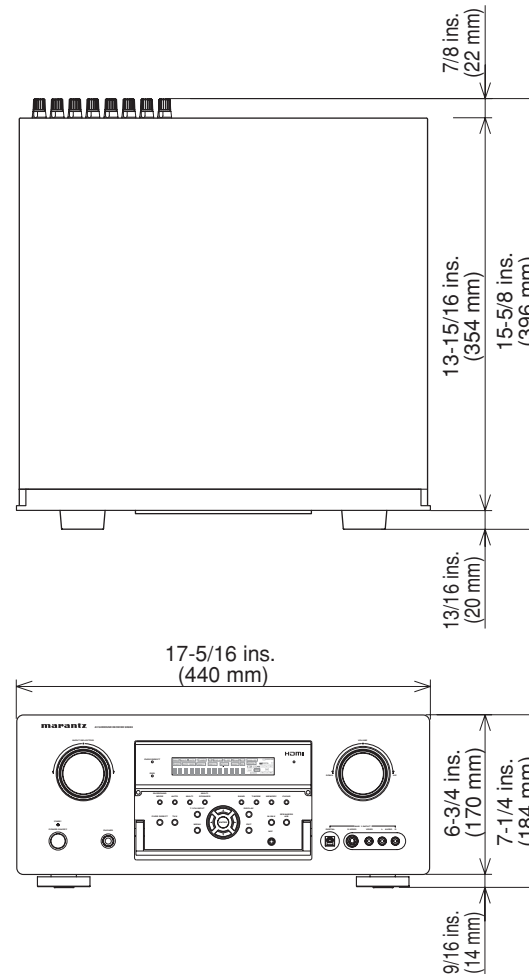

**ACCESSORIES**

Remote Control Unit RC8001SR.....	1
Remote Control Unit RC101 .....	1
Microphone .....	1
AAA-size batteries .....	5
FM Antenna (SR7002).....	1
FM Feeder Antenna (SR8002).....	1
FM Antenna Converter (SR8002) .....	1
AM Loop Antenna .....	1
Front AUX Jack Cover .....	1
AC cable .....	1

Specifications subject to change without prior notice.



# SETUP CODES (RC8001SR)

## AMPLIFIER

### Source button name : AMP

Brand name	Setup code
Amstrad	0105
Arcam	0296
Audiolab	0296
Carver	0296
GE	0105
Genexxa	0422
Grundig	0296
Harman/Kardon	0919
JVC	0358
Left Coast	0919
Linn	0296
Magnavox	0296
Marantz	0919, 0296
Micromega	0296
Myryad	0296
Optimus	0422
Panasonic	0335
Philips	0919, 0296
Pioneer	0040
Polk Audio	0919, 0296
Realistic	0422
Revox	0296
Sony	0247
Soundesign	0105
Technics	0335
Thorens	0296
Victor	0358
Wards	0105, 0040
Yamaha	0381

## RECEIVER/TUNER

### Source button name : AMP, TUNER

Brand name	Setup code
ADC	0558
Aiwa	1432, 0185, 1116, 1415, 1668
Alco	1417
Anam	1636
Apex Digital	1284
Audiolab	1216
Audiotronic	1216
Audiovox	1417
Bose	1256
Cambridge	1397
Soundworks	
Capetronic	0558
Carver	1216, 1116
Centrex	1284
Denon	1387
Ferguson	0558
Fine Arts	1216
Grundig	1216

## RECEIVER/TUNER

### Source button name : AMP, TUNER

Brand name	Setup code
Harman/Kardon	0137, 1331
Integra	0162, 1325
JBL	0137, 1333
JVC	0101, 0558, 1401, 1522
KLH	1417, 1439
Kerwood	1340, 1054
MCS	0066
Magnavox	1216, 1296, 0558, 1116
Marantz	1216, 0066, 1116, 1316
Micromega	1216
Musicmagic	1116
Myryad	1216
NAD	0347
Norcent	1416
Onkyo	0162, 0869, 1325
Optimus	1050, 0558
Panasonic	1545, 0066, 1315, 1790
Philips	1216, 1296, 1116, 1293, 1295, 1310, 1316
Pioneer	1050, 0041, 0558, 1411
Polk Audio	1316
Proscan	1281
Quasar	0066
RCA	1050, 1636, 1281, 0558, 1417
Saba	0558
Sansui	1116
Schneider	0558
Sony	1085, 0185, 1185, 1685, 1785
Stereophonics	1050
Sunfire	1340
Teac	1417
Technics	1335, 1545, 0066, 1336
Telefunken	0558
Thomson	1281
Thorens	1216
Uher	0558
Venturer	1417
Victor	0101
Wards	0185, 0041
Yamaha	0203, 1203, 1358

## CABLE

### Source button name : AUX1

Brand name	Setup code
ABC	0030, 0035
Americast	0926
Bell South	0926
Birmingham Cable	0303
Communications	
British Telecom	0030
Cable & Wireless	1095
Daeryung	0904, 1904, 0504, 0035
Director	0503
Filmnet	0470
General	0503, 0837, 0303,

## CABLE

### Source button name : AUX1

Brand name	Setup code
GoldStar	0171
Hamlin	0036, 0300
Instrument	0030
Jerrold	0503, 0837, 0303, 0030
LG	0171
MNet	0470
Memorex	0027
Motorola	0503, 0837, 0303, 1133
NTL	1095
Noos	0844
Ono	1095
PVP Stereo	0030
Visual Matrix	
Pace	0264, 1087, 1095
Panasonic	0027, 0035, 0134
Paragon	0027
Philips	0332, 0344
Pioneer	0904, 1904, 0171, 0560
Pulsar	0027
Quasar	0027
Regal	0306, 0300
Quarco	0027
Sagem	0844
Samsung	0027, 0171
Scientific Atlanta	0904, 1904, 0504, 0035
Sony	1033
Starcom	0030
Supercable	0303
TS	0030
Tele+1	0470
Telewest	1095
Torx	0030
Toshiba	0027
Trans PX	0303
United Cable	0030
Zenith	0027, 0552, 0926

## SATELLITE

### Source button name : DSS

Brand name	Setup code
@sat	1327
ABsat	0150
Alba	0482
AlphaStar	0799
Amstrad	0874
Aston	0169, 1156
Astro	0200
Atsat	1327
Avalon	0423
Blaupunkt	0200
British Sky	0874, 1202
Broadcasting	
Canal Digital	0880
Canal Satellite	0880

## SATELLITE

### Source button name : DSS

Brand name	Setup code
Canal+	0880
Chaparral	0243
Citycom	1203
Connexions	0423
Crossdigital	1136
Cyrus	0227
D-box	0750, 1154
DMT	1102
DNT	0227, 0423
Daeryung	0423
Daewoo	1323
Digenius	0326
DirecTV	0419, 0593, 0666, 1169, 0274, 0776, 1776, 0751, 0846, 1883, 1103, 1136
Dish Network System	1032, 0802
DishPro	1032, 0802
Distratel	0111
Dream Multimedia	1264
Echostar	1032, 0802, 0194, 0423, 0637, 0880, 0898, 1113
Engel	1044
Expressvu	0802
FTE	0890
Finlux	0482
Fracarro	0898
Fuba	0423
GE	0593
GOI	0802
Galaxis	0890, 1138
General Instrument	0896
Gold Box	0880
Grundig	0200, 0874
HTS	0802
Hirschmann	0200, 0423
Hitachi	0846, 0482
Hughes	1169, 0776, 1776
Network Systems	
Humax	0890, 1203
InVideo	0898
JVC	0802
Kathrein	0150, 0200, 0227, 0276, 0685, 1248
Kreiselmeier	0200
Labgear	1323
Logix	1044
Lorenzen	0326
Magnavox	0751, 0749
Manhattan	0482, 1044, 1110
Marantz	0227
MediaSat	0880
Memorex	0751
Metronic	0111
Mitsubishi	0776
Motorola	0896
Myryad	0227
Next Level	0896

**SATELLITE****Source button name : DSS**

Brand name	Setup code
Nokia	0482, 0750, 0778, 1154, 1250, 1750
OctalTV	1032
Orbitech	1127
Pace	0482, 0874, 1202, 1350
Panasonic	0274, 0728, 0874, 1347
Panda	0482
Paysat	0751
Philips	1169, 0776, 1776, 0751, 1103, 0749, 0160, 0227, 0482, 0880
Pioneer	0880
Promax	0482
Proscan	0419, 0593
RCA	0419, 0593, 0882, 0170
RFT	0227
RadioShack	0896
Radiola	0227
Radix	0423
SKY	0883, 0874, 1202
SM Electronic	1227
Sabre	0482
Sagem	0847, 1141, 1280
Samsung	1303, 1136, 1044, 1319
Sat Control	1327
Satstation	1110
Schwaiger	1138
Seemann	0423
Siemens	0200
Sony	0666, 1666, 0874
Star Choice	0896
Strong	1327
TPS	0847, 1280
Tantec	0482
TechniSat	1126, 1127
Telestar	1127
Thomson	0482, 0880, 1073, 1318
Topfield	1233
Toshiba	0776, 1776, 0817
UltimateTV	0419, 0666
Uniden	0751, 0749
Universum	0200
Ventana	0227
Wisi	0200, 0423, 0482
XSat	0150
Zehnder	1102
Zenith	0883, 1883

**TAPE DECK****Source button name : TAPE**

Brand name	Setup code
Aiwa	0056
Carver	0056
Grundig	0056
Harman/Kardon	0056
Magnavox	0056
Marantz	0056
Myryad	0056
Optimus	0054
Philips	0056
Pioneer	0054
Polk Audio	0056
RCA	0054
Revox	0056
Sansui	0056
Sony	0270
Thorens	0056
Wards	0054

**LASER DISK****Source button name : AUX2**

Brand name	Setup code
Carver	0091
Denon	0086
Marantz	0091
Mitsubishi	0086
NAD	0086
Nagsmi	0086
Optimus	0086
Philips	0091
Pioneer	0086
Salora	0091
Sony	0228
Telefunken	0086

**CD/CD-R PLAYER****Source button name : CD, CDR, MD**

Brand name	Setup code
Aiwa	0184
Arcam	0184
Audio Research	0184
AudioTon	0184
Audiolab	0184
Audiomeca	0184
Cairn	0184
California Audio Labs	0056
Carver	0184, 0206
Cyrus	0184
DKK	0027
DMX Electronics	0184
Denon	0900
Dynamic Bass	0206
Emerson	0332
Fisher	0206

**CD/CD-R PLAYER****Source button name : CD, CDR, MD**

Brand name	Setup code
Genexxa	0059, 0332
Goodmans	0332
Grundig	0184
Harman/ Kardon	0184, 0200
Hitachi	0059
JVC	0099
Kenwood	0708, 0653, 0055, 0064
Krell	0184
LXI	0332
Linn	0184
MCS	0056
Magnavox	0184, 0332
Marantz	0653, 0056, 0184
Matsui	0184
Memorex	0332
Meridian	0184
Micromega	0184
Miro	0027
Mission	0184
Myryad	0184
NAD	0027
NSM	0184
Naim	0184
Onkyo	0895
Optimus	0027, 0059, 0064, 0206, 0332
Panasonic	0056
Philips	0653, 0184
Pioneer	0059, 0332
Polk Audio	0184
Proton	0184
QED	0184
Quad	0184
Quasar	0056
RCA	0059, 0206, 0332
Realistic	0206
Revox	0184
Rotel	0184
SAE	0184
Sansui	0184, 0332
Sanyo	0206
Scott	0332
Sears	0332
Sharp	0888, 0064
Simaudio	0184
Sonic Frontiers	0184
Sony	0517, 0027
Symphonic	0332
TAG McLaren	0184
Tandy	0059
Technics	0056
Thorens	0184
Thule	0184
Universum	0184
Victor	0099
Wards	0184

**TV****Source button name : TV**

Brand name	Setup code
MARANTZ	0001
TV1 (TV, VDP)	
MARANTZ	0002
TV2 (Plasma)	
AGB	0543
AOC	0478, 0120, 0207, 0087, 0057, 0205, 0036, 0119, 0135
ASA	0131
AWA	0036
Acura	0036
Addison	0119, 0135, 0680
Admiral	0120, 0490, 0190
Advent	0788
Aiko	0119
Akai	0839, 0729, 0057, 0036, 0235, 0388, 0543
Akura	0291
Alba	0036, 0064, 0398, 0695
America Action	0207
Ampro	0778
Amstrad	0198, 0036, 0064, 0398, 0439, 0460, 0543
Anam	0277, 0207, 0036
Anam National	0277, 0677
Anitech	0036
Apex Digital	0775, 0792, 0794
Audiosonic	0064, 0136
Audiovox	0478, 0207, 0119, 0650
Bang & Olufsen	0592
Basic Line	0036
Baur	0064, 0388, 0539
Baysonic	0207
Beaumarck	0205
Beko	0397, 0513, 0741, 0742
Bell & Howell	0181
Beon	0064
Blaupunkt	0222
Blue Sky	0695, 1064
Bondstec	0274
Bradford	0207
Brandt	0136, 0362
Broksonic	0263, 0490
Bush	0036, 0064, 0398, 0401, 0695, 1064
CCE	0064
CGE	0274
CTC	0274
CXC	0207
Candle	0057
Carnivale	0057
Carver	0081, 0197
Cascade	0036
Cathay	0064
Celebrity	0027
Celera	0792
Centurion	0064
Changhong	0792
Ching Tai	0036, 0119

## TV

## Source button name : TV

Brand name	Setup code
Chun Yun	0027, 0207, 0036, 0119
Chung Hsin	0207, 0080, 0135
Cimline	0036
Cineral	0478, 0119
Citizen	0087, 0057, 0119
Clarion	0207
Clarivox	0064
Clatronic	0274, 0397
Condor	0347, 0397
Conrac	0835
Contec	0207, 0036
Craig	0207
Crosley	0081
Crown	0207, 0036, 0064, 0397, 0445
Curtis Mathes	0074, 0081, 0181, 0478, 0120, 0087, 0729, 0057, 0172, 0193, 1174, 1374
Daewoo	0181, 0478, 0207, 0057, 0205, 1688, 0036, 0064, 0119, 0135, 0197, 0401, 0650, 0661
Dansai	0064
Dayton	0036
De Graaf	0235, 0575
Decca	0064, 0543
Denon	0172
Digatron	0064
Dixi	0036, 0064
Dumont	0044
Dwin	0747, 0801
ECE	0064
Elbe	0286
Electroband	0027
Elin	0064, 0575
Elite	0347
Elta	0036
Emerson	0181, 0263, 0490, 0207, 0205, 0388, 0650
Envision	0057, 0840
Epson	0860
Erres	0064
Ether	0057, 0036
Etron	0036
Europhon	0543
Ferguson	0064, 0100, 0136, 0265, 0314, 0362, 0587
Fidelity	0388
Finlandia	0235, 0373
Finlux	0064, 0131, 0132, 0373, 0543
Firstar	0263, 0036
Firstline	0036, 0274, 0695
Fisher	0181, 0131, 0235, 0397
Flint	0482
Formenti	0064, 0347
Fortress	0120
Frontech	0190, 0274, 0291
Fujitsu	0710, 0836
Funai	0207, 0198, 0291
Futuretech	0207

## TV

## Source button name : TV

Brand name	Setup code
GE	0074, 0078, 0478, 0207, 0057, 0205, 1481, 0119, 0587, 1174, 1374
GEC	0064, 0543
Gateway	1782, 1783
Geloso	0036
Genexxa	0190
Gibraltar	0044, 0057
GoldStar	0181, 0057, 0205, 0064, 0136, 0404
Goodmans	0064, 0398, 0401, 0661
Gorenje	0397
Gradiente	0080, 0197
Graetz	0190, 0388
Granada	0064, 0235, 0366, 0543
Grandin	0637
Grundig	0064, 0222, 0514, 0583, 0614
Grunpy	0207
HCM	0036, 0439
Hallmark	0205
Hankook	0207, 0057, 0205
Hanseatic	0064, 0347, 0388, 0455, 0583
Hantarex	0543
Harman/Kardon	0081
Harvard	0207
Havermy	0120
Hello Kitty	0478
Hinari	0036, 0064
Hisawa	0482
Hitachi	0057, 0205, 1172, 0172, 1283, 0036, 0119, 0132, 0136, 0190, 0252, 0383, 0508, 0575, 0605
Hua Tun	0036
Huanayu	0401
Hypson	0064, 0291
ICE	0291, 0398
ITS	0398
ITT	0190, 0388, 0575
Imperial	0274, 0397, 0445
Indiana	0064
Infinity	0081
Ingelen	0190
Inno Hit	0543
Innova	0064
Inteq	0044
Interfunk	0064, 0190, 0274, 0388, 0539
Intervision	0064, 0291, 0404
JBL	0081
JCB	0027
JVC	0490, 0080, 0398, 0680, 0710
Jean	0183, 0078, 0263, 0036, 0119
Jensen	0788
KEC	0207
KTV	0207, 0057
Kaisui	0036
Kapsch	0190
Karcher	0637

## TV

## Source button name : TV

Brand name	Setup code
Kathrein	0583
Kendo	0064
Kenwood	0057
Kneissel	0286, 0462
Kolin	0207, 0080, 0135
Korpel	0064
Koyoda	0036
L&S Electronic	0835
LG	0087, 0057, 0205, 0064, 0135, 0741
LXI	0074, 0081, 0181, 0183, 0205
Leyco	0064, 0291
Liesenk & Tter	0064
Loewe	0539
Luxor	0383, 0388
M Electronic	0036, 0064, 0131, 0132, 0136, 0190, 0314, 0373, 0401, 0507
MGA	0177, 0057, 0205
MTC	0087, 0057, 0539
Magnadyne	0274, 0543
Magnafon	0543
Magnavox	0081, 0057, 1481, 1281
Manesth	0291, 0347
Mark	0064
Matsui	0036, 0064, 0235, 0398, 0514, 0543
Matsushita	0277, 0677
Mediator	0064
Medion	0695, 0835, 1064
Megatron	0205, 0172
Memorex	0181, 0277, 0490, 0177, 0205, 0036, 1064
Metz	0474
Micromaxx	0835
Microstar	0835
Midland	0074, 0044, 0078
Minerva	0514
Minoka	0439
Mitsubishi	0181, 0277, 0120, 0263, 0207, 0177, 1277, 0057, 0205, 0135, 0539, 0863
Mivar	0318, 0319, 0543, 0636
Motorola	0120
Multitech	0207, 0036
Myryad	0583
NAD	0183, 0205, 0388, 0893
NEC	0181, 0183, 0078, 0057, 0205, 0036, 0197, 0482, 0524, 1731
NEI	0064
NTC	0119
Neckermann	0064, 0583
Netsat	0064
Newave	0120, 0205, 0036, 0119
Nikkai	0064, 0291
Nikko	0057, 0205, 0119
Nokia	0388, 0500, 0507, 0575, 0658
Norcent	0775, 0851
Nordmende	0136, 0314, 0587
Oceanic	0190, 0388

## TV

## Source button name : TV

Brand name	Setup code
Onwa	0207, 0460
Optimus	0181, 0277, 0193, 0677
Optonica	0120
Orion	0263, 0490, 0064, 0347, 0543
Osaki	0291, 0439
Otto Versand	0064, 0347, 0539, 0583
Palladium	0397, 0445
Panama	0291
Panasonic	0081, 0277, 0078, 0064, 0190, 0677, 1437
Pathe Cinema	0265, 0347
Pausa	0036
Penney	0074, 0183, 0078, 0087, 0057, 0205, 1374
Perdio	0347
Philco	0081, 0490, 0207, 0057, 0205, 0172, 1688, 0064, 0274
Philips	0081, 0027, 0078, 0057, 0205, 1481, 0064, 0119, 0135, 0401, 0583, 0717
Phonola	0064
Pilot	0057
Pioneer	0193, 0136, 0190, 0314, 0706, 0787, 0893
Portland	0119
Prandoni-Prince	0543
Prima	0788
Prism	0078
Profex	0036, 0388
Proscan	0074
Protech	0036, 0064, 0274, 0291, 0445, 0695
Proton	0057, 0205, 0036
Pulsar	0044
Quasar	0277, 0078, 0677
Quelle	0064, 0131, 0388, 0539
R-Line	0064
RCA	0074, 0027, 0057, 0205, 1474, 1481, 0117, 0119, 0706, 1074, 1174, 1274, 1374, 1574
RFT	0455
RadioShack	0074, 0181, 0207, 0057, 0205
Radiola	0064
Radiomarelli	0543
Realistic	0181, 0207, 0057, 0205
Rediffusion	0388
Reoc	0741
Revox	0064
Rex	0190, 0286, 0291
Roadstar	0036, 0291, 0445
Runco	0044, 0057, 0524, 0630
SBR	0064
SEG	0291, 0695
SEI	0543
SKY	0064
SSS	0207
Saba	0136, 0190, 0314, 0362
Saccs	0265
Sagem	0637
Saisho	0036, 0291, 0543
Salora	0190, 0383, 0388, 0575

## TV

**Source button name : TV**

Brand name	Setup code
Sambers	0543
Sampo	0181, 0120, 0057, 0205, 0198, 0036, 0119, 0677, 1782
Samsung	0181, 0087, 0839, 0729, 0057, 0205, 0036, 0064, 0117, 0119, 0291, 0397, 0583, 0614, 0645, 0793, 0841
Sansei	0478
Sansui	0490
Sanyo	0181, 0207, 0131, 0235, 0366, 0826
Schaub Lorenz	0388
Schneider	0064, 0274, 0398, 0695
Scotch	0205
Scott	0263, 0207, 0205
Sears	0074, 0081, 0181, 0183, 0205, 0198
Seleco	0190, 0286
Semivox	0207
Semp	0183
Sharp	0120, 0057, 0677
Shen Ying	0036, 0119
Sheng Chia	0120, 0263, 0036
Siarem	0543
Siemens	0064, 0222
Sinudyne	0543
Skantic	0383
Skygiant	0207
Skyworth	0064
Solavox	0190
Sonitron	0235
Sonoko	0036, 0064
Sonolor	0190, 0235
Sontec	0064
Sony	1127, 0027, 0677, 0861, 1532, 1678
Soundesign	0207, 0205
Soundwave	0064, 0445
Sowa	0183, 0078, 0087, 0205, 0119
Squareview	0198
Standard	0036
Starlite	0207
Stern	0190, 0286
Supreme	0027
Sylvania	0081, 0057, 0198
Symphonic	0207, 0198
Synco	0027, 0478, 0120, 0087, 0205, 0119
Sysline	0064
T + A	0474
TCM	0835
TMK	0205
TNCi	0044
TVS	0490
Tacico	0205, 0036, 0119
Tai Yi	0036
Tandy	0120, 0190
Tashiko	0119, 0677
Tatung	0081, 0181, 0183, 0078, 0087, 0036, 0064, 0543

## TV

**Source button name : TV**

Brand name	Setup code
Teac	0036, 0064, 0291, 0439, 0445, 0482, 0695, 1064
Tec	0274
Technema	0347
Technics	0277, 0078, 0677
Techwood	0078
Teco	0078, 0120, 0205, 0036, 0119, 0291, 0680
Teknika	0081, 0207, 0177, 0087, 0119
Telefunken	0729, 0136, 0289, 0362, 0652
Telemeister	0347
Teletech	0036
Tensai	0347
Tera	0057
Thomson	1474, 0136, 0314, 0587, 0652
Thorn	0064, 0131, 0388, 0539
Toshiba	0181, 0183, 0087, 1283, 0535, 0645, 0677, 0859, 1383, 1683, 1731
Triumph	0543
Tuntex	0057, 0036, 0119
Uher	0347
Universum	0064, 0131, 0132, 0291, 0373, 0397, 0519
Vector Research	0057
Vestel	0064
Victor	0277, 0080, 0677, 0680
Videosat	0274
Vidikron	0081
Vidtech	0205
ViewSonic	1782
Vision	0347
Voxson	0190
Waltham	0383
Wards	0081, 0057, 0205, 0893
Watson	0064, 0347
Waycon	0183
White Westinghouse	0490, 0064, 0347, 0650
Yamaha	0057, 0796, 0860
Yapshe	0277
Yoko	0064, 0291
Zenith	0044, 0490, 0205, 0119

## VCR

**Source button name : VCR**

Brand name	Setup code
ASA	0064, 0108
Admiral	0075
Adventura	0027
Aiko	0305
Aiwa	0064, 0027, 0334, 0375, 0379
Akai	0068, 0342
Akiba	0099
Alba	0099, 0305, 0342, 0379
America Action	0305
American High	0062
Amstrad	0027

## VCR

**Source button name : VCR**

Brand name	Setup code
Anam	0064, 0267, 0305, 0253, 0507
Anam National	0253, 1589
Anitech	0099
Asha	0267
Asuka	0064
Audiovox	0064, 0305
Baird	0027, 0131, 0068
Basic Line	0099, 0305
Beaumarck	0267
Bell & Howell	0131
Blaupunkt	0253
Brandt	0347
Brandt Electronic	0068
Broksonic	0211, 0375, 1506
Bush	0099, 0305, 0379
CCE	0099, 0305
CGE	0027
Calix	0064
Canon	0062
Carver	0108
Cimline	0099
Cineral	0305
Citizen	0064, 0305, 1305
Colt	0099
Combitech	0379
Craig	0064, 0074, 0267, 0099
Crown	0099, 0305
Curtis Mathes	0087, 0062, 0068, 1062
Cybernex	0267
Cyrus	0108
Daewoo	0072, 0131, 0305, 0669, 1305
Dansai	0099
De Graaf	0069
Decca	0108, 0027
Denon	0069
Dual	0068
Dumont	0108, 0027, 0131
Dynatech	0027
ESC	0267, 0305
Elcatech	0099
Electrohome	0064
Electrophonic	0064
Emerex	0059
Emerson	0062, 0064, 0211, 0267, 0072, 0027, 0070, 0305, 1305, 1506
Ferguson	0068, 0347
Fidelity	0027
Finlandia	0108, 0131
Finlux	0108, 0027, 0069, 0131
Firstline	0064, 0072, 0070, 0099
Fisher	0074, 0131
Fuji	0062, 0060
Fujitsu	0072, 0027
Funai	0027
GE	0087, 0062, 0267, 0834, 1062, 1087

## VCR

**Source button name : VCR**

Brand name	Setup code
GEC	0108
Garrard	0027
General	0072
Go Video	0459
GoldHand	0099
GoldStar	0064, 0252, 0507, 1264
Goodmans	0064, 0027, 0099, 0305
Gradiente	0027
Graetz	0267, 0131, 0068
Granada	0108, 0131
Grandin	0064, 0027, 0099
Grundig	0108, 0099, 0253, 0374
HCM	0099
Hi-Q	0074
Hanseatic	0064
Harley Davidson	0027
Harman/Kardon	0108
Harwood	0099
Hinari	0267, 0099, 0379
Hitachi	0064, 0267, 0027, 0069, 0068
Hughes	0069
Network Systems	
Hypson	0099
ITT	0267, 0131, 0068
ITV	0064, 0305
Imperial	0027
Interfunk	0108
JVC	0072, 0094, 0068
Jensen	0068
KEC	0064, 0305
KLH	0099
Kaisui	0099
Kenwood	0094, 0068
Kodak	0062, 0064
Kolin	0070, 0068
Korpel	0099
LG	0064, 0072, 0069, 0507
LXI	0064
Lenco	0305
Leyco	0099
Lloyd's	0027
Loewe	0064, 0108, 1589
Logik	0267, 0099
Luxor	0075, 0131, 0070
M Electronic	0027
MEI	0062
MGA	0267, 0070
MGN Technology	0267
MTC	0267, 0027
Magnasonic	1305
Magnavox	0062, 0066, 0108, 0027, 1808
Magnin	0267
Manesth	0072, 0099
Marantz	0062, 0108
Marta	0064

## VCR

**Source button name : VCR**

Brand name	Setup code
Matsui	0375, 0379
Matsushita	0062
Medion	0375
Memorex	0062, 0064, 0075, 0066, 0074, 0267, 0027, 0131, 0334, 0375, 1264
Memphis	0099
Metz	0064, 0374, 1589
Minolta	0069
Mitsubishi	0108, 0094, 0070, 0068, 0834
Motorola	0062, 0075
Multitech	0027, 0099
Murphy	0027
Myryad	0108
NAD	0131
NEC	0062, 0064, 0075, 0131, 0094, 0068
National	0253
Neckermann	0108
Nesco	0099
Newave	0064
Nikko	0064
Noblex	0267
Nokia	0267, 0131, 0068
Nordmende	0068, 0347
Oceanic	0027, 0068
Okano	0342, 0375
Olympus	0062, 0253
Optimus	0064, 0075, 0131, 0459
Orion	0211, 0375, 0379, 1506
Osaki	0064, 0027, 0099
Otto Versand	0108
Palladium	0064, 0068, 0099
Panasonic	0062, 0252, 0253, 0643, 1062, 1589
Pathe Marconi	0068
Penney	0062, 0064, 0267, 0069, 1062, 1264
Pentax	0069
Perdio	0027
Philco	0062
Philips	0062, 0108, 0645, 1108, 1208
Phonola	0108
Pilot	0064
Pioneer	0108, 0069, 0094
Polk Audio	0108
Profitronic	0267
Proline	0027
Proscan	0087, 1087
Protec	0099
Pulsar	0066
Pye	0108
Quasar	0062, 1062
Quelle	0108
RCA	0087, 0062, 0267, 0069, 0834, 1062, 1087
RadioShack	0027
Radiola	0108
Radix	0064
Randex	0064

## VCR

**Source button name : VCR**

Brand name	Setup code
Realistic	0062, 0064, 0075, 0074, 0027, 0131
Reoc	0375
ReplayTV	0641, 0643
Rex	0068
Roadstar	0064, 0267, 0099, 0305
Riunco	0066
SBR	0108
SEG	0267
SEI	0108
STS	0069
Saba	0068, 0347
Salora	0070
Sampo	0064, 0075
Samsung	0267, 0072, 0459
Sanky	0075, 0066
Sansui	0027, 0094, 0068, 1506
Sanyo	0074, 0267, 0131
Saville	0379
Schaub Lorenz	0027, 0131, 0068
Schneider	0108, 0027, 0099
Scott	0211, 0072, 0070
Sears	0062, 0064, 0074, 0027, 0069, 0131, 1264
Seleco	0068
Semp	0072
Sharp	0075, 0834
Shintom	0131, 0099
Shogun	0267
Siemens	0064, 0108, 0131
Silva	0064
Singer	0072, 0099
Sinudyne	0108
Sonic Blue	0641, 0643
Sontec	0064
Sony	0062, 0059, 0060, 0027, 0663, 1259
Sunkai	0375
Sunstar	0027
Suntronic	0027
Sylvania	0062, 0108, 0027, 0070, 1808
Symphonic	0027
TMK	0267
Tandy	0027, 0131
Tashiko	0064, 0027
Diamond	0795
Digitrex	0699
Emerson	0618
Tatung	0108, 0072, 0027, 0094, 0068
Teac	0027, 0068, 0305, 0334, 0669
Technics	0062, 0253
Teco	0062, 0064, 0075, 0068
Teknika	0062, 0064, 0027
Teleavia	0068
Telefunken	0068, 0347
Tenosal	0099
Tensai	0027
Thomas	0027

## VCR

**Source button name : VCR**

Brand name	Setup code
Thomson	0087, 0094, 0068, 0347
Thorn	0131, 0068
Tivo	0645, 0663
Toshiba	0108, 0072, 0094, 0070, 0068, 0872
Totevision	0064, 0267
Uher	0267
Unitech	0267
Universum	0064, 0108, 0267, 0027
Vector	0072
Victor	0094, 0068
Video Concepts	0072
Videomagic	0064
Videosonic	0267
Villain	0027
Wards	0087, 0062, 0075, 0074, 0108, 0267, 0027, 0069, 0099
White Westinghouse	0099
XR-1000	0062, 0027, 0099
Yamaha	0068
Yamishi	0099
Yokan	0099
Yoko	0267
Zenith	0066, 0060, 0027, 1506

## DVD

**Source button name : DVD**

Brand name	Setup code
MARANTZ DVD1	0001
MARANTZ DVD2	0002
Acoustic Solutions	0757
Alba	0744
Amstrad	0740
Apex Digital	0699, 0744, 0782, 0821, 0823, 0857, 1127
Blaupunkt	0744
Blue Parade	0598
Bush	0740
Centrex	0699
Clatronic	0815
CyberHome	0741
DVD2000	0548
Daewoo	0811, 0797
Dansai	0797
Decca	0797
Denon	0517
Enterprise	0618
Fisher	0697
GE	0549, 0744
Go Video	0742
GoldStar	0768
Gradiente	0678
Greenhill	0744
Grundig	0566
Hitachi	0600, 0691
Hiteker	0699

## DVD

**Source button name : DVD**

Brand name	Setup code
JVC	0585, 0650
KLH	0744
Kenwood	0517, 0561
Koss	0678
LG	0768
Limit	0795
Magnavox	0530, 0702
Memorex	0858
MiCO	0750
Microsoft	0549
Mintek	0744
Mitsubishi	0548
Mustek	0757
Nesa	0744
Onkyo	0530
Oritron	0678
Palsonic	0699
Panasonic	0517, 0659, 1389
Philips	0530, 0566, 0673, 0881
Pioneer	0552, 0598, 0658, 0659
Polk Audio	0566
Proscan	0549
Qwestar	0678
RCA	0549, 0598, 0744
Rotel	0650
SM Electronic	0757
Samsung	0600
Sanyo	0697
Sharp	0657
Sherwood	0797
Shinsonic	0560
Slim Art	0811
Sony	0560, 0891
Sylvania	0702
Tatung	0797
Teac	0598, 0744
Technics	0517
Theta Digital	0598
Thomson	0549
Toshiba	0530
Urban Concepts	0530
XBox	0549
Yamaha	0517, 0566, 0572
Zenith	0530, 0618, 0768
Zeus	0811



# DIRECT BUTTON FUNCTIONS (RC8001SR)

## Source button name : AMP

PAGE	Command	Note
PAGE 1	1 AUTO	SELECT AUTO SURROUND
	2 	SELECT DOLBY MODE
	3 DTS	SELECT DTS MODE
	4 EX/ES	SELECT EX/ES
	5 DIRECT	SELECT PURE DIRECT
PAGE 2	1 MCH-ST	SELECT MULTI CHANNEL STEREO
	2 STEREO	SELECT STEREO MODE
	3 HDMI 1	SELECT HDMI OUTPUT 1
	4 HDMI 2	SELECT HDMI OUTPUT 2
	5 EQ	SELECT EQ MODE
PAGE 3	1 NIGHT	NIGHT MODE ON/OFF
	2 BASS +	BASS +
	3 BASS -	BASS -
	4 TREB +	TREBLE +
	5 TREB -	TREBLE -
PAGE 4	1 MULTI	MULTI ROOM ON/OFF
	2 M-SPKR	MULTI SPEAKER ON/OFF
	3 A/D	SELECT ANALOG/DIGITAL
	4 V-OFF	VIDEO OFF
	5 M-DAX	M-DAX ON/OFF

## Source button name : TUNER

PAGE	Command	Note
PAGE 1	1 FM	SELECT FM
	2 AM	SELECT AM
	3 XM/DAB	SELECT XM RADIO
	4 NEURAL	SELECT NEURAL AUDIO
	5 BAND	SELECT RADIO BAND
PAGE 2	1 SCAN +	FREQUENCY SCAN UP
	2 SCAN -	FREQUENCY SCAN DOWN
	3 T-MODE	SELECT MONO/STEREO
	4 P-SCAN	SELECT PRESET SCAN
	5 P-INFO	SHOW PRESET INFORMATION
PAGE 3 European model only	1 DISP	DISPLAY
	2 PTY	RDS PTY
	3 AF	RDS ALTERNATE FREQUENCY
	4 STM	RDS STATION MODE
	5 DWR	RDS DSR WAVE LANGUAGE
PAGE 4	1 SCAN +	FREQUENCY SCAN UP
	2 SCAN -	FREQUENCY SCAN DOWN
	3 DISP	XM/RDS DISPLAY
	4 CAT +	CATEGORY SEARCH UP
	5 CAT -	CATEGORY SEARCH DOWN

## Source button name : DVD

PAGE	Command	Note
PAGE 1	1 MENU	SELECTS MAIN MENU
	2 AUDIO	SELECT LANGUAGES
	3 SUB-T	SELECT SUB TITLE
	4 10+	DIGIT ENTRY +10
	5 TRAY	TRAY OPEN/CLOSE
PAGE 2	1 SETUP	SELECTS SETUP MENU
	2 ANGLE	SELECTS ANGLE
	3 OSD	ACTIVATES ON SCREEN DISPLAY
	4 FF	FAST FORWARD
	5 REW	REWIND
PAGE 3	1 SLOW	SLOW FORWARD
	2 L-PLAY	LAST PLAY
	3 SHUFLE	SHUFFLE PLAY
	4 REPEAT	REPEAT MODE
	5 A/B	REPEAT A TO B
PAGE 4	1 RETURN	RETURN TO MENU
	2 T/C	TITLE AND CHAPTER
	3 3-D	SURROUND ON/OFF
	4 TITLE	SELECTS TITLE MENU
	5 ZOOM	ZOOM MODE ON/OFF

## Source button name : CD

PAGE	Command	Note
PAGE 1	1 DISC +	CD CHANGER NEXT DISC
	2 DISC -	CD CHANGER PREVIOUS DISC
	3 SHUFLE	SHUFFLE PLAY
	4 REPEAT	REPEAT
	5 TRAY	TRAY OPEN/CLOSE
PAGE 2	1 TEXT	ACTIVATE TEXT FUNCTION
	2 AMS	AUTO MUSIC SCAN
	3 SCROLL	SCROLL/RECALL
	4 FF	FAST FORWARD
	5 REW	REWIND
PAGE 3	1 DISC 1	CD CHANGER DISC 1
	2 DISC 2	CD CHANGER DISC 2
	3 DISC 3	CD CHANGER DISC 3
	4 DISC 4	CD CHANGER DISC 4
	5 DISC 5	CD CHANGER DISC 5
PAGE 4	1 UNIT	SELECT UNIT No.
	2 TITL-S	SELECT TITLE SEARCH
	3 TRACK	SELECT TRACK No.
	4 CATGRY	SELECT CATEGORY
	5 P-MODE	SELECT PLAY MODE

## Source button name : VCR

PAGE	Command	Note
PAGE 1	1 TV/VCR	SELECT TV/VCR
	2 2XPLAY	TWICE NORMAL PLAYBACK SPEED
	3 SLOW	SLOW PLAYBACK SPEED
	4 STILL	STILL FRAME
	5 EJECT	EJECT
PAGE 2	1 OTR	ONE TOUCH RECORDING
	2 AUDIO	SELECT AUDIO MODE
	3 SKIP	SKIP TO NEXT PROG.MARKER
	4 FF	FAST FORWARD
	5 REW	REWIND
PAGE 3	1 VIS +	VHS INDEX SERCH NEXT
	2 VIS-	VHS INDEX SERCH PREVIOUS
	3	
	4	
	5	

## Source button name : CDR

PAGE	Command	Note
PAGE 1	1 INPUT	SELECT INPUT SOURCE
	2 INCR	INCREMENTS TRACK No.
	3 SYNC-R	ACTIVATE SYNCRO RECORDING
	4 PROG	ACTIVATE PROGRAM MODE
	5 TRAY	TRAY OPEN/CLOSE
PAGE 2	1 SCROLL	SCROLL/RECALL
	2 FINAL	FINALIZES(WRITES TOC)
	3 BLANK	RECORDS BLANK
	4 FF	FAST FORWARD
	5 REW	REWIND
PAGE 3	1 BLANK	RECORDS BLANK
	2 REPEAT	ACTIVATE REPEAT MODE
	3	
	4	
	5	

## Source button name : TAPE

PAGE	Command	Note
PAGE 1	1 TAPE-A	SELECT TAPE DECK A
	2 TAPE-B	SELECT TAPE DECK B
	3 DIR	AUTO REVERSE DIRECTION
	4 TIME	TIME DISPLAY
	5 TRAY	TRAY OPEN/CLOSE
PAGE 2	1 AMS	AUTO MUSIC SCAN
	2	
	3	
	4 FF	FAST FORWARD
	5 REW	REWIND

## Source button name : MD

PAGE	Command	Note
PAGE 1	1 REPEAT	SELECTS REPEAT MODE
	2 SHUFLE	SELECTS SHUFFLE PLAY
	3 DISP	SELECTS DISPLAY MODE
	4 EDIT	SELECTS EDIT MODE
	5 EJECT	EJECT
PAGE 2	1 SP/LP	SELECTS SP/LP MODE
	2 DELETE	SELECTS DELETE
	3 ENTER	SELECTS ENTER
	4 FF	FAST FORWARD
	5 REW	REWIND
PAGE 3	1 MARKER	SELECTS AUTO MARKER
	2 PROG	SELECTS PROGRAM MODE
	3 SYNC-R	SYNCRO REC
	4 CHAR	SELECTS CHARACTER MODE
	5	

## Source button name : AUX 2

PAGE	Command	Note
PAGE 1	1 SHUFFL	SELECT AUX1
	2 REPEAT	SELECT AUX2
	3 MODE	SELECT AUX3
	4 SORT	SELECT NET
	5 MUTE	
PAGE 2	1 INPUT+	INPUT SELECTOR FORWARD
	2 INPUT-	INPUT SELECTOR REVERSE
	3	
	4	
	5	

## Source button name : AUX 1

PAGE	Command	Note
PAGE 1	1 SHUFFL	SELECT SHUFFLE PLAY
	2 REPEAT	SELECT REPEAT PLAY
	3 MODE	CHANGE USER INTERFACE MODE
	4 SORT	SORT DATA BASE
	5 MUTE	MUTE ON/OFF (TOGGLE)
PAGE 2	1 ALBUM+	NEXT ALBUM
	2 ALBUM-	PREVIOUS ALBUM
	3 LIST+	NEXT PLAY LIST
	4 LIST-	PREVIOUS PLAY LIST
	5	
PAGE 3	1 ARTIST	SORT ORDER (ARTIST)
	2 ALBUM	SORT ORDER (ALBUM)
	3 SONG	SORT ORDER (SONG)
	4 GENRE	SORT ORDER (GENRE)
	5 P-LIST	SORT ORDER (PLAY LIST)
PAGE 4	1 1 INPUT+	INPUT SELECTOR FORWARD
	2 INPUT-	INPUT SELECTOR REVERSE
	3	
	4	
	5	

# SETUP CODES (RC101)

## TV

Acer	1141
Admiral	1002, 1009, 1089
Aiko	1059
Aiwa	1117, 1118
Akai	1001
Amtron	1023
Anam	1113
Anam National	1023, 1069, 1092
AOC	1003, 1024, 1049, 1127
Audiovox	1023
Bell & Howell	1009, 1025
Benq	1104, 1142
Broksonic	1003, 1097, 1098, 1113
Celebrity	1001
Citizen	1003, 1013, 1023 1026, 1059, 1063
Colortyme	1003, 1043
Contec	1113
Contec/Cony	1023, 1045, 1047
Craig	1020, 1022, 1023, 1113
Crown	1023, 1067
Curtis Mathes	1003, 1013, 1025 1026, 1062, 1103, 1110
Daewoo	1003, 1013, 1024, 1035 1036, 1059, 1084, 1101
Daytron	1003, 1013, 1016
Dimensia	1103, 1110
Dumont	1003, 1010, 1153
Electroband	1001
Electrohome	1001, 1003, 1069, 1133
Emerson	1003, 1013, 1015 1020, 1021, 1022, 1023 1025, 1038, 1044, 1045 1048, 1055, 1061, 1094 1096, 1099, 1101, 1113
Envision	1003
Fisher	1025, 1051, 1091, 1160
Fujitsu	1038, 1124, 1125, 1155
Funai	1023, 1038, 1113
Gateway	1150
GE	1003, 1018, 1022, 1046 1054, 1069, 1085, 1103 1110, 1113, 1133, 1136, 1153

Goldstar	1003, 1013, 1024 1030, 1045, 1080 1100, 1112, 1154
Hallmark	1003
Hisense	1116
Hitachi	1003, 1012, 1031, 1032 1037, 1041, 1045, 1047 1065, 1068, 1082, 1088 1094, 1139, 1140, 1145, 1159
Infinity	1067
Janeil	1134
JBL	1067
JC Penney	1003, 1013, 1018 1019, 1024, 1026 1046, 1047, 1054 1063, 1083, 1085 1100, 1103, 1110 1112, 1133, 1154
Jensen	1003
JVC	1028, 1029, 1045 1047, 1050, 1060, 1065
Kawasho	1001, 1003
Kenwood	1003
Kloss Novabeam	1023, 1056, 1057, 1134
KTV	1013, 1023, 1033 1034, 1073, 1099, 1113
LG	1024, 1030
M.Wards	1002, 1009, 1038
Magnavox	1003, 1052, 1053 1056, 1057, 1063 1067, 1081, 1106
Marantz	1003, 1031, 1067, 1122
Mitsubishi	1003, 1024, 1051 1115, 1122, 1133
Motorola	1014, 1069
NEC	1003, 1012, 1024, 1043, 1069
NET-TV	1137, 1150
Orion	1020, 1096
Panasonic	1017, 1067, 1069, 1095, 1111 1054, 1056, 1057, 1058 1063, 1067, 1069, 1106
Philips	1003, 1011, 1045, 1052 1054, 1056, 1057, 1058 1063, 1067, 1069, 1106
Pioneer	1003, 1018, 1037 1070, 1071, 1094 1145, 1147, 1149
Plasmsync	1135
Portland	1003, 1013, 1024, 1059
Price Club	1026
Prism	1018
Proscan	1004, 1005, 1006, 1007 1008, 1085, 1103, 1110

Proton	1003, 1045
Quasar	1010, 1069, 1073, 1111, 1153
Radio Shack	1003, 1013, 1015 1023, 1024, 1025, 1045 1100, 1103, 1110, 1113
RCA	1003, 1004, 1005 1006, 1007, 1008 1014, 1024, 1049, 1069 1075, 1079, 1085, 1087 1088, 1093, 1094, 1101 1103, 1110, 1113, 1153
Realistic	1013, 1015, 1023, 1025 1045, 1100, 1103, 1110
Runco	1010, 1153
Sampo	1150
Samsung	1003, 1013, 1024, 1026 1040, 1045, 1062, 1078 1083, 1090, 1100, 1105, 1114 1120, 1121, 1146, 1148, 1157
Sansui	1119
Sanyo	1003, 1025, 1051, 1072 1077, 1091, 1156, 1157, 1158
Sharp	1003, 1013, 1014 1015, 1045, 1055, 1064 1066, 1076, 1089, 1123
Signature	1009
Sony	1001, 1102, 1108
Soundesign	1003, 1023, 1038, 1063, 1113
Starlite	1023
Supre-Macy	1134
Sylvania	1003, 1039, 1042 1052, 1053, 1056, 1057 1063, 1067, 1089, 1151 1023, 1039, 1044
Symphonic	1023, 1039, 1044
Tandy	1014
Tatung	1069
Technics	1018
Techwood	1003, 1018
Teknika	1003, 1009, 1013, 1023 1024, 1026, 1038, 1045 1047, 1059, 1063, 1111, 1113
Telecaption	1074
Toshiba	1003, 1019, 1025 1026, 1042, 1074, 1098 1107, 1111, 1135, 1136
Totevision	1013
Universal	1046, 1054
Video Concepts	1113
Viewsonic	1006, 1022, 1109 1128, 1129, 1130, 1131 1138, 1143, 1145, 1150

Wards	1003, 1009, 1015 1024, 1038, 1044, 1046 1052, 1054, 1056, 1057 1067, 1086, 1103, 1110
White Westinghouse	1001, 1101
Yamaha	1003, 1024
Zenith	1003, 1009, 1010 1132, 1144, 1153

## CD

AIWA	3001, 3002, 3003
AKAI	3004, 3005, 3006
AUDIO	3007
AUDIO LABS	3008
CALIFORNIA	3008
CARVER	3010, 3011, 3009
CASIO	3012, 3020
CURTIS	3020, 3012
DENON	3013
EMERSON	3014
FISHER	3011, 3015, 3016, 3017, 3018
GE	3019
GENEXXA	3014, 3021, 3020
HARMON	3022, 3023, 3051
HITACHI	3020
INKEL	3024
JC PENNEY	3012, 3020, 3025
JVC	3026, 3027
KARDON	3022, 3051, 3023
KENWOOD	3028, 3029, 3030, 3031 3032, 3033
KRELL	3010
LUXMAN	3035, 3036, 3037, 3038
LX I	3012, 3020, 3014
MAGNAVOX	3010, 3039, 3040
MARANTZ	3010, 3041, 3042, 3043
MATHES	3012, 3020
MCS	3012, 3020
MGA	3023
MISSION	3010
MITSUBISHI	3023, 3044
NAD	3034, 3045
NAKAMICHI	3046, 3047, 3048
NEC MCS	3025
NIKKO	3007, 3016
ONKYO	3049, 3050, 3051, 3052 3055, 3098
OPTIMUS	3011, 3014, 3020, 3028, 3053 3054, 3056, 3057, 3058, 3059
PANASONIC	3008, 3060, 3061

PHILIPS.....	3009, 3010, 3010, 3040
PIONEER.....	3020, 3021, 3062, 3063, 3064
QUASAR.....	3008
RCA.....	3011, 3014, 3065, 3066, 3067 3068, 3069
REALISTIC.....	3011, 3014, 3020, 3042 3054, 3057
ROTEL.....	3010
RS ORIGINAL.....	3070
SAE.....	3010, 3083
SAMSUNG.....	3071
SANSUI.....	3014, 3068, 3072, 3073
SANYO.....	3011, 3018, 3074, 3075, 3076
SCOTT.....	3014
SEARS.....	3012, 3014, 3020, 3028, 3042
SHARP.....	3028, 3042, 3077
SHERWOOD.....	3042, 3056, 3070, 3078, 3024
SHURE.....	3025
SONY.....	3039, 3079, 3080, 3081, 3082, 3097
SYLVANIA.....	3010
SYMPHONIC.....	3083
TEAC.....	3016, 3042, 3057, 3083, 3084 3085, 3086
TECHNICA.....	3007, 3008, 3061, 3087, 3088
THETA DIGITAL.....	3040
TOSHIBA.....	3045
VICTOR.....	3026
YAMAHA.....	3007, 3089, 3090, 3091, 3092
ZENITH.....	3016, 3093, 3094, 3095, 3096

DVD	
Aiwa.....	2036, 2037
Apex.....	2012, 2017, 2018, 2019, 2021, 2034
BOSE.....	2038, 2039
Denon.....	2047, 2048
Funai.....	2049
GE.....	2009, 2020, 2029, 2033
Harman Kardon.....	2061
Hitachi.....	2008, 2012, 2031
JVC.....	2006, 2010, 2040 2041, 2042, 2043
Kenwood.....	2053, 2054
Koss.....	2058
Magnavox.....	2007, 2011, 2023, 2025
Marantz.....	2025
Mitsubishi.....	2011, 2015
Onkyo.....	2062
Oritron.....	2009, 2030
Panasonic.....	2003, 2015, 2016, 2055
Philips.....	2007, 2011, 2058
Pioneer.....	2002, 2014, 2056
Proscan.....	2009, 2020, 2032
RCA.....	2005, 2009, 2020, 2035, 2057
Sampo.....	2041
Samsung.....	2008, 2012, 2022, 2024, 2027
Sanyo.....	2050, 2052
Sharp.....	2044, 2045
Sherwood.....	2051
Sony.....	2001, 2013, 2059
Toshiba.....	2004, 2008, 2026, 2028
Yamaha.....	2046, 2060
Zenith.....	2010

DSS	
Alphastar.....	4027
BSB.....	4021
Chaparral.....	4039
DIRECTV.....	4001, 4016
DISH Network.....	4030
Drake.....	4026
Echostar.....	4007, 4017, 4018, 4019, 4020
Express Vu.....	4017
Fujitsu.....	4025
GE.....	4002, 4008, 4009
General Instruments.....	4036, 4037
Hitachi.....	4001, 4015
Hughes.....	4001, 4016
Janeil.....	4025
JVC.....	4017
Mitsubishi.....	4001
Panasonic.....	4004, 4010
Philips.....	4031, 4035
Proscan.....	4002, 4008, 4009, 4011
Radio Shack.....	4036, 4037
RCA.....	4002, 4008, 4009, 4029
Realistic.....	4040
Rural Cable.....	4036
Samsung.....	4022, 4027
Sony.....	4003, 4012, 4014
Star Choice.....	4032
Star Trak.....	4024
STS.....	4038
SuperDish.....	4028
Toshiba.....	4001, 4034
Uniden.....	4005, 4006, 4013
Video Pall.....	4025
Zenith.....	4025, 4033

**[www.marantz.com](http://www.marantz.com)**

You can find your nearest authorized distributor or dealer on our website.

**marantz**<sup>®</sup> is a registered trademark.

