

marantz[®]

AV Surround Receiver

NR1402

Owner's Manual

SAFETY PRECAUTIONS



CAUTION
RISK OF ELECTRIC SHOCK
DO NOT OPEN



CAUTION:
TO REDUCE THE RISK OF ELECTRIC SHOCK, DO NOT REMOVE COVER (OR BACK). NO USER-SERVICEABLE PARTS INSIDE. REFER SERVICING TO QUALIFIED SERVICE PERSONNEL.

The lightning flash with arrowhead symbol, within an equilateral triangle, is intended to alert the user to the presence of uninsulated "dangerous voltage" within the product's enclosure that may be of sufficient magnitude to constitute a risk of electric shock to persons.

The exclamation point within an equilateral triangle is intended to alert the user to the presence of important operating and maintenance (servicing) instructions in the literature accompanying the appliance.

WARNING:
TO REDUCE THE RISK OF FIRE OR ELECTRIC SHOCK, DO NOT EXPOSE THIS APPLIANCE TO RAIN OR MOISTURE.

IMPORTANT SAFETY INSTRUCTIONS

1. Read these instructions.
2. Keep these instructions.
3. Heed all warnings.
4. Follow all instructions.
5. Do not use this apparatus near water.
6. Clean only with dry cloth.
7. Do not block any ventilation openings. Install in accordance with the manufacturer's instructions.
8. Do not install near any heat sources such as radiators, heat registers, stoves, or other apparatus (including amplifiers) that produce heat.
9. Protect the power cord from being walked on or pinched particularly at plugs, convenience receptacles, and the point where they exit from the apparatus.
10. Only use attachments/accessories specified by the manufacturer.
11. Use only with the cart, stand, tripod, bracket, or table specified by the manufacturer, or sold with the apparatus. When a cart is used, use caution when moving the cart/apparatus combination to avoid injury from tip-over.
12. Unplug this apparatus during lightning storms or when unused for long periods of time.
13. Refer all servicing to qualified service personnel. Servicing is required when the apparatus has been damaged in any way, such as power-supply cord or plug is damaged, liquid has been spilled or objects have fallen into the apparatus, the apparatus has been exposed to rain or moisture, does not operate normally, or has been dropped.
14. Batteries shall not be exposed to excessive heat such as sunshine, fire or the like.

CAUTION:

To completely disconnect this product from the mains, disconnect the plug from the wall socket outlet.
The mains plug is used to completely interrupt the power supply to the unit and must be within easy access by the user.

DECLARATION OF CONFORMITY

We declare under our sole responsibility that this product, to which this declaration relates, is in conformity with the following standards: EN60065, EN55013, EN55020, EN61000-3-2 and EN61000-3-3. Following the provisions of Low Voltage Directive 2006/95/EC and EMC Directive 2004/108/EC, the EC regulation 1275/2008 and its frame work Directive 2009/125/EC for Energy-related Products (ErP).

marantz Europe
A division of D&M Europe B.V.
Beemdstraat 11, 5653 MA Eindhoven,
The Netherlands

A NOTE ABOUT RECYCLING:

This product's packaging materials are recyclable and can be reused. Please dispose of any materials in accordance with the local recycling regulations.

When discarding the unit, comply with local rules or regulations.

Batteries should never be thrown away or incinerated but disposed of in accordance with the local regulations concerning battery disposal.

This product and the supplied accessories, excluding the batteries, constitute the applicable product according to the WEEE directive.



Pb

☐ NOTES ON USE

WARNINGS

- Avoid high temperatures.
Allow for sufficient heat dispersion when installed in a rack.
- Handle the power cord carefully.
Hold the plug when unplugging the cord.
- Keep the unit free from moisture, water, and dust.
- Unplug the power cord when not using the unit for long periods of time.
- Do not obstruct the ventilation holes.
- Do not let foreign objects into the unit.
- Do not let insecticides, benzene, and thinner come in contact with the unit.
- Never disassemble or modify the unit in any way.
- Ventilation should not be impeded by covering the ventilation openings with items, such as newspapers, tablecloths or curtains.
- Naked flame sources such as lighted candles should not be placed on the unit.
- Observe and follow local regulations regarding battery disposal.
- Do not expose the unit to dripping or splashing fluids.
- Do not place objects filled with liquids, such as vases, on the unit.
- Do not handle the mains cord with wet hands.
- When the switch is in the OFF (STANDBY) position, the equipment is not completely switched off from MAINS.
- The equipment shall be installed near the power supply so that the power supply is easily accessible.

☐ CAUTIONS ON INSTALLATION

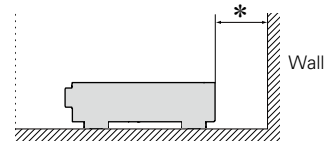
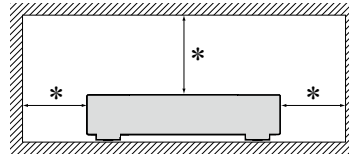

*** For proper heat dispersal, do not install this unit in a confined space, such as a bookcase or similar enclosure.**

- More than 0.3 m is recommended.
- Do not place any other equipment on this unit.

Getting started

Thank you for purchasing this marantz product. To ensure proper operation, please read this owner's manual carefully before using the product. After reading them, be sure to keep them for future reference.

Contents

Getting started	1
Accessories	1
Features	2
Cautions on handling	2

Basic version

Connections	4
Important information	4
Connecting an HDMI-compatible device	5
Connecting a TV	7
Connecting a Blu-ray Disc player/DVD player	7
Connecting a set-top box (Satellite tuner/Cable TV)	8
Connecting a portable audio player	8
Connecting a CD player	9
Connecting an antenna	9
Connecting a wireless receiver (RX101)	10
Settings	11
Set up speakers (Audyssey® Auto Setup)	11
Playback (Basic operation)	18
Important information	18
Playing a Blu-ray Disc player/DVD player	19
Playing a CD player	19
Tuning in radio stations	20
Selecting a listening mode (Surround mode)	24
Selecting a listening mode	24

Advanced version

Speaker installation/connection (Advanced)	29
Install	29
Connect	31
Set up speakers	35
Connections (Advanced connection)	37
Connecting the remote control connectors	37
Playback (Advanced operation)	38
Convenient functions	38
How to make detailed settings	43
Menu map	43
Examples of menu screen displays	44
Examples of menu and front display	45
Inputting characters	46
Audio Adjust	48
Information	53
System Setup	54
Input Setup	62
Other settings	67
Remote control settings	67
Operating the connected devices by remote control unit	68
Operating AV devices	68
Registering preset codes	69
Operating devices	71

Information

Part names and functions	74
Front panel	74
Display	75
Rear panel	76
Remote control unit	77
Other information	79
Trademark information	79
Surround	80
Relationship between video signals and monitor output	84
Explanation of terms	85
Troubleshooting	87
Resetting the microprocessor	89
Specifications	90

Accessories

Check that the following parts are supplied with the product.

① Getting Started	1
② CD-ROM (Owner's manual)	1
③ Power cord	1
④ Remote control unit (RC013SR)	1
⑤ R03/AAA batteries	2
⑥ Setup microphone (ACM1H)	1
⑦ AM loop antenna	1
⑧ FM indoor antenna	1

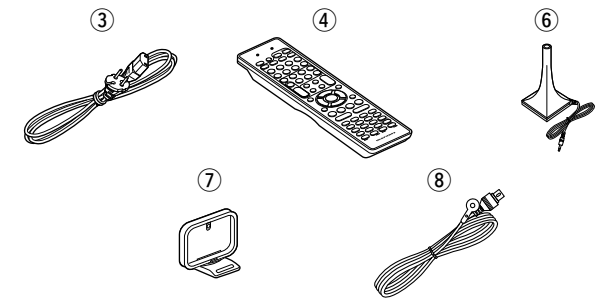

Features

Fully discrete, identical quality and power for all 5 channels (50 W x 5ch, 8 Ω)

The unit is equipped with a power amplifier that reproduces high-fidelity sound in surround mode with equal quality and power for all channels, true to the original sound.

The power amplifier circuit adopts a discrete-circuit configuration that achieves high-quality surround sound reproduction.

Setup wizard, providing easy-to-follow setup instructions

First select the language when prompted. Then simply follow the instructions displayed on the TV screen to set up the speakers, etc.

Easy to use, Graphical User Interface

This unit is equipped with an easy to see "Graphical User Interface" that uses menu displays and levels. The use of level displays increases operability of the this unit.

Supports HDMI 1.4a with 3D, ARC, Deep Color, "x.v.Color", Auto Lip Sync and HDMI control function (👉 page 5)

This unit can output 3D video signals input from a Blu-ray Disc player to a TV that supports a 3D system. This unit also supports the ARC (Audio Return Channel) function, which reproduces TV sound with this unit via an HDMI cable used for connecting the unit and a TV*.

* The TV should support the ARC function.

4-HDMI inputs and 1-output

The unit is equipped with 4 HDMI input connectors for connecting devices with HDMI connectors, such as a Blu-ray Disc player, game machine, HD video camera, etc.

High definition audio support

The unit is equipped with a decoder which supports high-quality digital audio format for Blu-ray Disc players such as Dolby TrueHD, DTS-HD Master Audio, etc.

M-XPort (marantz-eXtension Port) (👉 page 10)

This unit is equipped with the M-XPort, a marantz original innovation that provides outstanding expandability. You can connect the Wireless Receiver RX101 (sold separately) to this port.

Cautions on handling

• Before turning the power on

Check once again that all connections are correct and that there are no problems with the connection cables.

• Power is supplied to some of the circuitry even when the unit is set to the standby mode. When going on vacation or leaving home for long periods of time, be sure to unplug the power cord from the power outlet.

• About condensation

If there is a major difference in temperature between the inside of the unit and the surroundings, condensation (dew) may form on the operating parts inside the unit, causing the unit not to operate properly.

If this happens, let the unit sit for an hour or two with the power turned off and wait until there is little difference in temperature before using the unit.

• Cautions on using mobile phones

Using a mobile phone near this unit may result in noise. If that occurs, move the mobile phone away from this unit when it is in use.

• Moving the unit





Turn off the power and unplug the power cord from the power outlet. Next, disconnect the connection cables to other system units before moving the unit.











• About care

- Wipe the cabinet and control panel clean with a soft cloth.
- Follow the instructions when using a chemical cleaner.
- Benzene, paint thinner or other organic solvents as well as insecticide may cause material changes and discoloration if brought into contact with the unit, and should therefore not be used.

Basic version

Here, we explain the connections and basic operation methods for this unit.

- **Connections**  [page 4](#)
- **Settings**  [page 11](#)
- **Playback (Basic operation)**  [page 18](#)
- **Selecting a listening mode (Surround mode)**  [page 24](#)

	Connection	 page 6, 7
	Playback	–
	Connection	 page 6, 7
	Playback	 page 19
	Connection	 page 8
	Playback	–
	Connection	 page 6
	Playback	–
	Connection	 page 10
	Playback	–

	Connection	 page 6, 7
	Playback	 page 19
	Connection	 page 6, 8
	Playback	–
	Connection	 page 9
	Playback	 page 19
	Connection	 page 9
	Playback	 page 20

For speaker connections, see [page 31](#),  [page 6](#) “Connecting the speakers”.

Connections

Important information

- Make connections as follows before using this unit. Select an appropriate connection type according to the devices to be connected.
- You may need to make some settings on this unit depending on the connection method. Refer to each description for more information.
- Select the cables (sold separately) according to the devices being connected.

NOTE

- Do not plug in the power cord until all connections have been completed. (When the Setup wizard is running, follow the instructions in the Setup wizard screen for making connections.)
- When running the Setup wizard, turn off the power supply of connected devices.
- When making connections, also refer to the operating instructions of the other devices being connected.
- Be sure to connect the left and right channels properly (left with left, right with right).
- Do not bundle power cords together with connection cables. Doing so can result in noise.

Relationship between video signals and monitor output

[Flow of video signals]

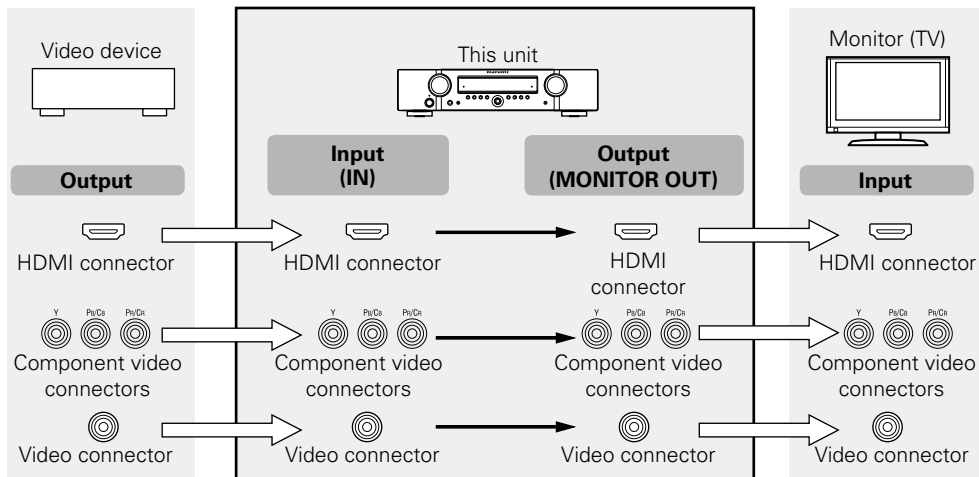

- Resolutions of HDMI-compatible TVs can be checked at "Monitor Info." (page 53).
- HDMI signals cannot be converted into analog signals (page 84).
- Analog signals cannot be converted into HDMI signals (page 84).

Examples of screen display

- Menu screen
- Status display screen
When the input source is switched. When the volume is adjusted.

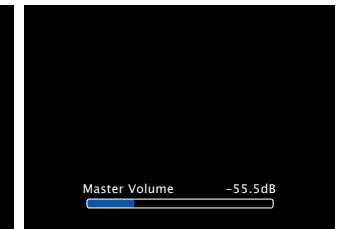
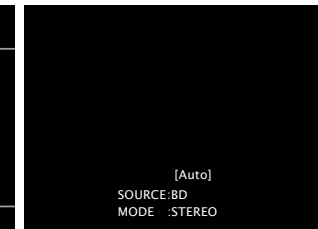
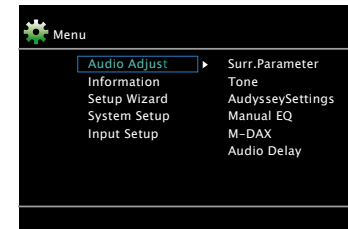

Status display: The operating status appears briefly on the screen when the input source is switched or the volume is changed.

NOTE

- If you operate the menu while playing back 3D video content or computer's resolution (e.g. VGA), the playback video is replaced by the menu screen. The playback video is not displayed behind the menu screen.
- This unit does not show the status display while playing back 3D video content or computer's resolution (e.g. VGA).
- The menu screen and status display are displayed when this unit and a TV are connected by HDMI. Furthermore, the menu screen and status display are not displayed when this unit and a TV are connected by VIDEO and COMPONENT VIDEO.

Connecting an HDMI-compatible device

You can connect up to five HDMI-compatible devices (4-inputs/1-output) to the unit.

HDMI function

This unit supports the following HDMI functions:

- 3D
- Deep Color ([page 85](#))
- Auto Lip Sync ([page 58, 85](#))
- "x.v.Color", sYCC601 color, Adobe RGB color, Adobe YCC601 color ([page 85, 86](#))
- High definition digital audio format
- ARC (Audio Return Channel)
- Content Type
- CEC (HDMI control)

Copyright protection system

In order to play back digital video and audio such as BD-Video or DVD-Video via HDMI connection, both this unit and TV or the player need to support the copyright protection system known as HDCP (High-bandwidth Digital Content Protection System). HDCP is copyright protection technology comprised of data encryption and authentication of the connected AV devices. This unit supports HDCP.

- If a device that does not support HDCP is connected, video and audio are not output correctly. Read the owner's manual of your television or player for more information.

About HDMI cables

- When a device supporting Deep Color is connected, use a cable compatible with "High Speed HDMI cable" or "High Speed HDMI cable with Ethernet".
- When the ARC function is used, connect a device with a "Standard HDMI cable with Ethernet" or "High Speed HDMI cable with Ethernet" for HDMI 1.4a.

HDMI control function ([page 38](#))

This function allows you to operate external devices from the unit and operate the unit from external devices.

NOTE

- The HDMI control function may not work depending on the device it is connected to and its settings.
- You cannot operate a TV or Blu-ray Disc player/DVD player that is not compatible with the HDMI control function.

About 3D function

This unit supports input and output of 3D (3 dimensional) video signals of HDMI 1.4a.

To play back 3D video, you need a TV and player that provide support for the HDMI 1.4a 3D function and a pair of 3D glasses.

NOTE

- When playing back 3D video, refer to the instructions provided in the manual of your playback device together with this manual.
- If you operate the menu while playing back 3D video content, the playback video is replaced by the menu screen. The playback video is not displayed behind the menu screen.
- This unit does not show the status display while playing back 3D video content.
- If 3D video with no 3D information is input, the menu screen and status display on this unit are displayed over the playback video.
- If 2D video is converted to 3D video on the television, the menu screen and status display on this unit are not displayed correctly. To view the menu screen and status display on this unit correctly, turn the television setting that converts 2D video to 3D video off.

About ARC (Audio Return Channel) function

The Audio Return Channel in HDMI 1.4a enables a TV, via a single HDMI cable, to send audio data "upstream" to this unit.

NOTE

- To enable the ARC function, set "HDMI Control" to "ON" ([page 58](#)).
- When connecting a TV that does not support the ARC function, a separate connection using an audio cable is required. In this case, refer to "Connecting a TV" ([page 7](#)) for the connection method.

About Content Type

HDMI 1.4a enables simple, automated picture setting selection with no user intervention.

NOTE

To enable the Content Type, set "Video Mode" to "Auto" ([page 65](#)).

Cables used for connections

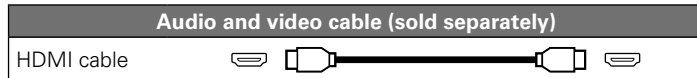

- This interface allows transfer of digital video signals and digital audio signals over a single HDMI cable.

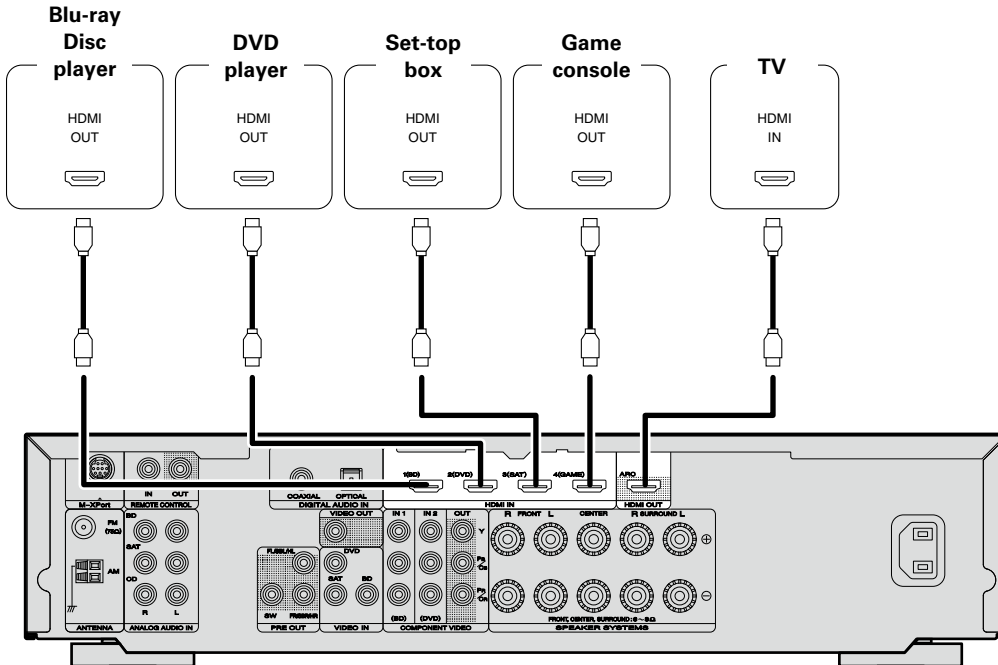

- When this unit is connected to other devices with HDMI cables, connect this unit and TV also with an HDMI cable.
- When connecting a device that supports Deep Color, please use a "High Speed HDMI cable" or "High Speed HDMI cable with Ethernet".
- Video signals are not output if the input video signals do not match the monitor's resolution. In this case, switch the Blu-ray Disc/DVD player's resolution to a resolution with which the monitor is compatible.
- When this unit and monitor are connected with an HDMI cable, if the monitor is not compatible with HDMI audio signal playback, only the video signals are output to the monitor.

NOTE

The audio signal from the HDMI output connector (sampling frequency, number of channels, etc.) may be limited by the HDMI audio specifications of the connected device regarding permissible inputs.

Connecting to a device equipped with a DVI-D connector

When an HDMI/DVI conversion cable (sold separately) is used, the HDMI video signals are converted to DVI signals, allowing connection to a device equipped with a DVI-D connector.

NOTE

- No sound is output when connected to a device equipped with a DVI-D connector. Make separate audio connections.
- Signals cannot be output to DVI-D devices that do not support HDCP.
- Depending on the combination of devices, the video signals may not be output.

Settings related to HDMI connections

Set as necessary. For details, see the respective reference pages.

Input Assign (page 64)

Set this to change the HDMI input connector to which the input source is assigned.

HDMI Setup (page 58)

Make settings for HDMI video/audio output.

- Auto Lip Sync
- HDMI Audio Out
- HDMI Control
- Standby Source
- P.Off Control

NOTE

The audio signal input from the HDMI input connector can be output as an output signal from the HDMI output connector by setting the HDMI audio output destination to TV.

Audio signals input via the Analog/Coaxial/Optical input connectors cannot be output from the HDMI output connector.

Connecting a TV

- Select the connector to use and connect the device.
- For instructions on HDMI connections, see “Connecting an HDMI-compatible device” ([page 5](#)).



To listen to TV audio through this device, use the optical digital connection.

NOTE

The optical connection is not required when a TV compatible with the ARC function (Audio Return Channel HDMI 1.4a standard function) is connected to this unit via an HDMI connection. For details, see “About ARC (Audio Return Channel) function” ([page 5](#)) or refer to the instruction manual for your TV.

Cables used for connections

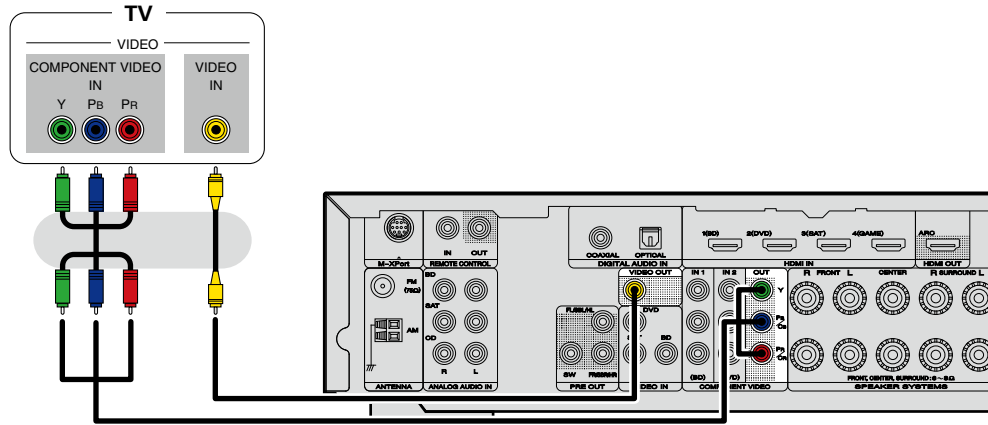
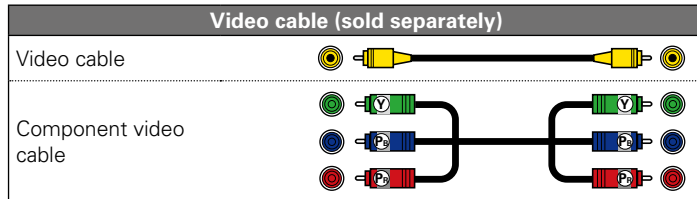

in Set as Necessary

At the time of purchase, the OPTICAL input connector is assigned to “CD”. To use the OPTICAL input connector for the TV audio input, change the settings of “Input Assign” ([page 64](#)) in the menu.

Connecting a Blu-ray Disc player/DVD player

- You can enjoy video and audio from a Blu-ray Disc or DVD.
- Select the connector to use and connect the device.
- For instructions on HDMI connections, see “Connecting an HDMI-compatible device” ([page 5](#)).

Cables used for connections

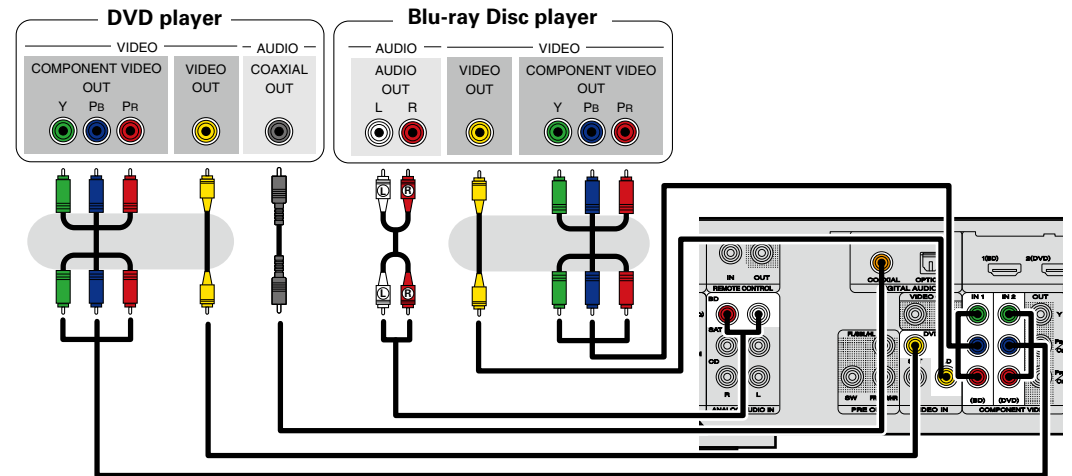
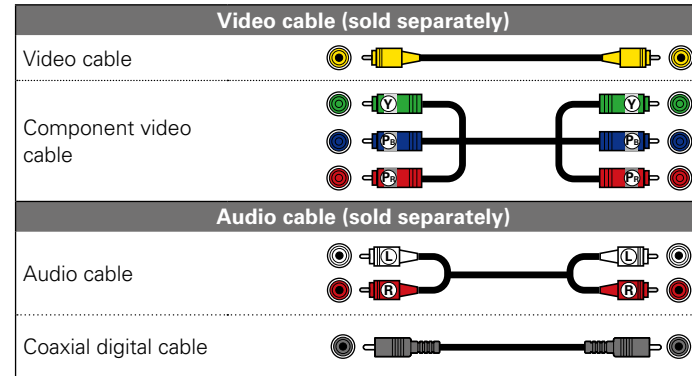

in Set as Necessary

Set this to change the digital input connector or component video input connector to which the input source is assigned.

“Input Assign” ([page 64](#))



When you want to play back HD Audio (Dolby TrueHD, DTS-HD, Dolby Digital Plus, DTS Express) and Multi-channel PCM with this unit, use an HDMI connection ([page 5](#) “Connecting an HDMI-compatible device”).

Connecting a set-top box (Satellite tuner/Cable TV)

- You can watch satellite or cable TV.
- Select the connector to use and connect the device.
- For instructions on HDMI connections, see “Connecting an HDMI-compatible device” (page 5).

Cables used for connections

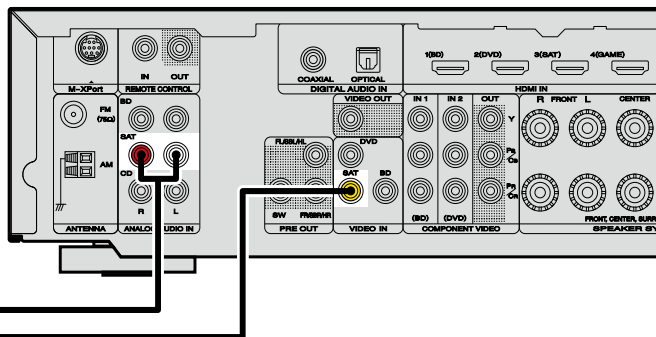
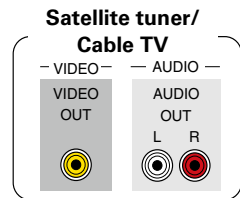
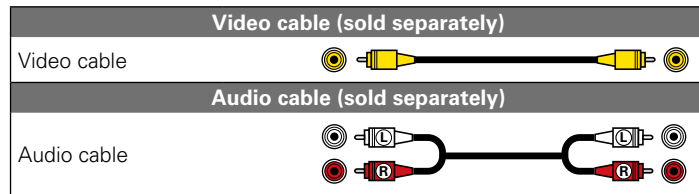

in Set as Necessary

Set this to change the digital input connector or component video input connector to which the input source is assigned.

“Input Assign” (page 64)

Connecting a portable audio player

If a portable player is connected via the AUX INPUT jack of the unit, music from the portable player can be played.

Cables used for connections

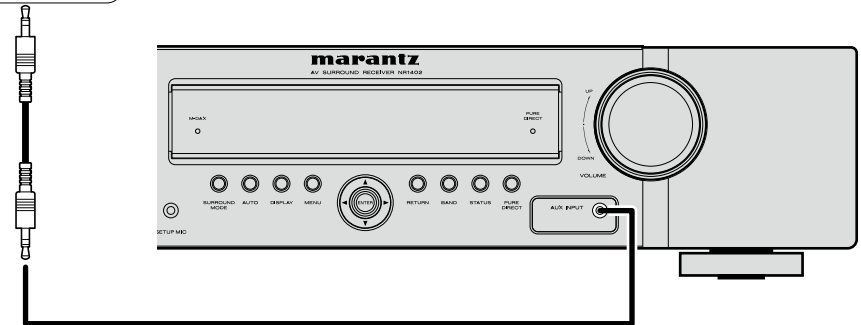
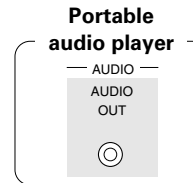
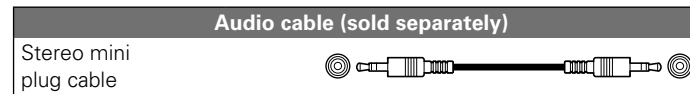

You can enjoy listening to music by connecting a portable audio player via the AUX INPUT jack. In this case, set the input source to “AUX”.

Connecting a CD player

- You can enjoy CD sound.
- Select the connector to use and connect the device.

Cables used for connections

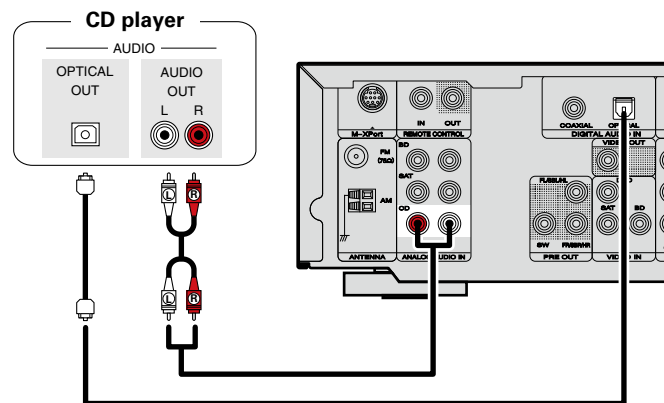
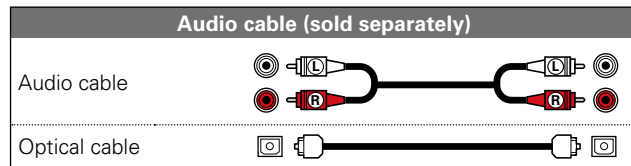

in Set as Necessary

Set this to change the digital input connector to which the input source is assigned.
"Input Assign" (page 64)

Connecting an antenna

- Connect the FM antenna or AM loop antenna supplied with the unit to enjoy listening to radio broadcasts.
- After connecting the antenna and receiving a broadcast signal (page 20 "Listening to FM/AM broadcasts"), fix the antenna with tape in a position where the noise level becomes minimal.

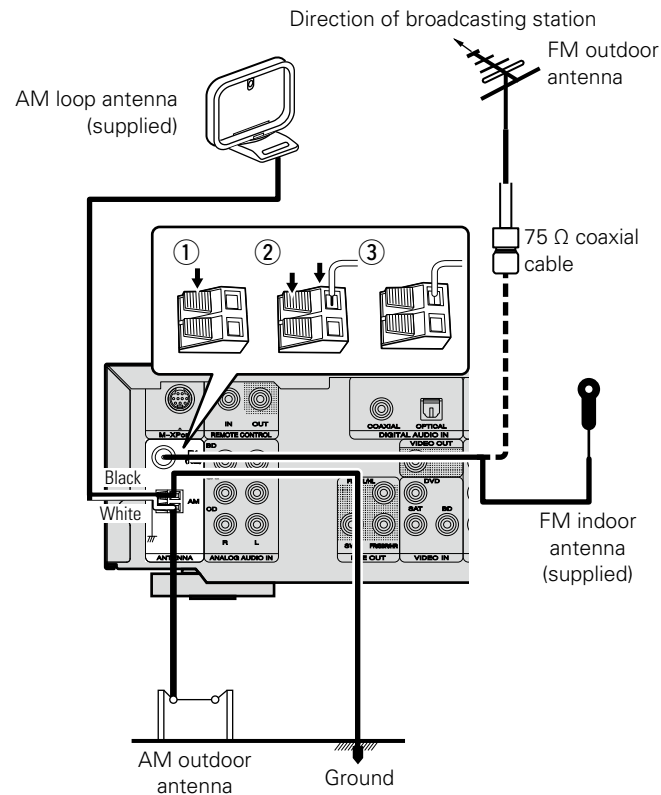

AM loop antenna assembly

- 1 Put the stand section through the bottom of the loop antenna from the rear and bend it forward.
- 2 Insert the projecting part into the square hole in the stand.

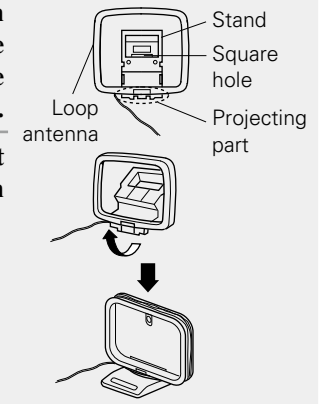

Using the AM loop antenna

Suspending on a wall

Suspend directly on a wall without assembling.

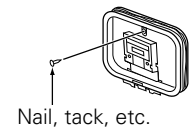

Standing alone

Use the procedure shown above to assemble.

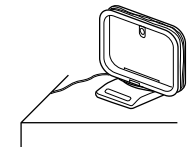

NOTE

- Do not connect two FM antennas simultaneously.
- Even if an external AM antenna is used, do not disconnect the AM loop antenna.
- Make sure the AM loop antenna lead terminals do not touch metal parts of the panel.
- If the signal has noise interference, connect the ground terminal (GND) to reduce noise.
- If you are unable to receive a good broadcast signal, we recommend installing an outdoor antenna. For details, inquire at the retail store where you purchased the unit.

Connecting a wireless receiver (RX101)

By connecting a wireless receiver RX101 (sold separately) to this unit, you can receive and playback audio signals from other devices using the Bluetooth Communication Function.

- Use a Bluetooth device that is A2DP compatible ([page 85](#) "A2DP").
- You can also use wireless receiver RX101 as an external IR receiver.
- For instructions on the wireless receiver settings, refer to the RX101's operating instructions.

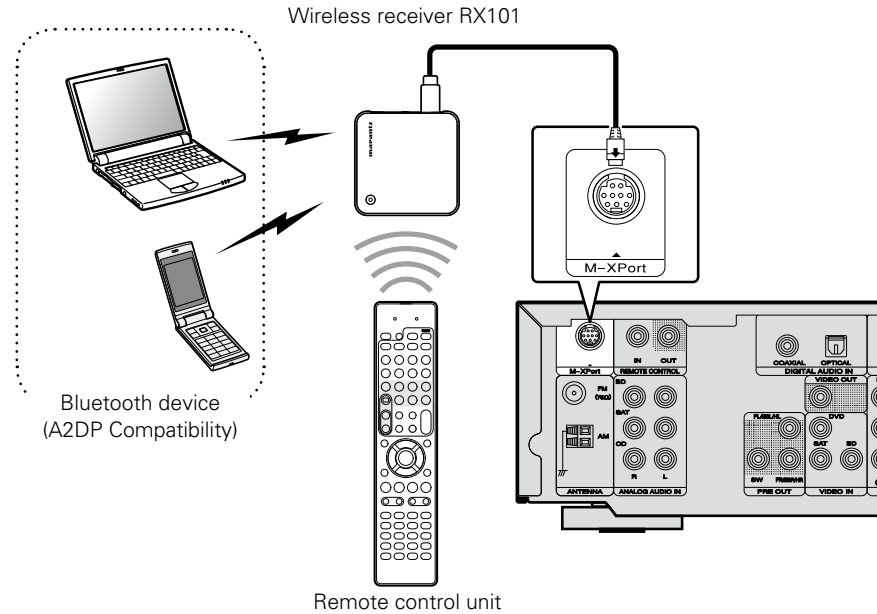

You can enjoy listening to music by connecting a wireless receiver via the M-XPport input connector. In this case, set the input source to "M-XPport".

NOTE

To use wireless receiver RX101 as external IR receiver, set the remote sensor function of this unit to disable ([page 67](#) "Remote control settings").

Settings

Here, we explain “Audyssey® Auto Setup”, which allows you to automatically make the optimal settings for your speakers.

❑ Set up speakers (Audyssey® Auto Setup)

(👉 [page 11](#))

Playback (Basic operation) (👉 [page 18](#))

Selecting a listening mode (Surround mode)

(👉 [page 24](#))

Playback (Advanced operation) (👉 [page 38](#))



Set up speakers (Audyssey® Auto Setup)



The acoustic characteristics of the connected speakers and listening room are measured and the optimum settings are made automatically. This is called “Audyssey® Auto Setup”.

To perform measurement, place the setup microphone in multiple locations all around the listening area. For best results, we recommend you measure in six positions, as shown in the illustration (up to six positions).

- When performing Audyssey® Auto Setup, Audyssey MultEQ®/Audyssey Dynamic EQ®/Audyssey Dynamic Volume® functions become active (👉 [page 50, 51](#)).
- To set up the speakers manually, use “Speaker Setup” (👉 [page 55](#)) on the menu.

NOTE

- Make the room as quiet as possible. Background noise can disrupt the room measurements. Close windows, silence cell phones, televisions, radios, air conditioners, fluorescent lights, home appliances, light dimmers, or other devices as measurements may be affected by these sounds.
- Cell phones should be placed away from all audio electronics during the measurement process as Radio Frequency Interference (RFI) may cause measurement disruptions (even if the cell phone is not in use).
- Do not unplug the setup microphone from the main unit until Audyssey® Auto Setup is completed.
- Do not stand between the speakers and setup microphone or allow obstacles in the path while the measurements are being made. This will cause inaccurate readings.
- Loud test sounds may be played during Audyssey® Auto setup. This is part of normal operation. If there is background noise in room, these test signals will increase in volume.
- Operating **VOLUME +, -** during the measurements will cancel the measurements.
- Measurement cannot be performed when headphones are connected.

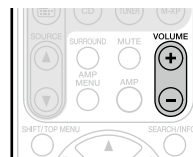

About setup microphone placement

- Measurements are performed by placing the setup microphone successively at multiple positions throughout the entire listening area, as shown in **[Example ①]**. For best results, we recommend you measure in six positions, as shown in the illustration (up to six positions).
- Even if the listening environment is small as shown in **[Example ②]**, measuring at multiple points throughout the listening environment results in more effective correction.

[Example ①]

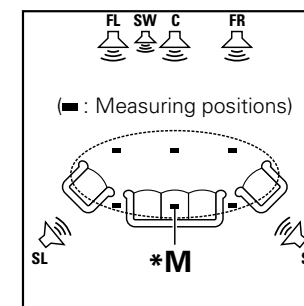

[Example ②]

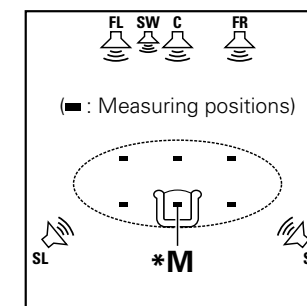

FL Front speaker (L)
FR Front speaker (R)
C Center speaker

SW Subwoofer
SL Surround speaker (L)
SR Surround speaker (R)

About the main listening position (*M)

The main listening position is the position where listeners would normally sit or where one would normally sit alone within the listening environment. Before starting Audyssey® Auto Setup, place the setup microphone in the main listening position. Audyssey MultEQ® uses the measurements from this position to calculate speaker distance, level, polarity, and the optimum crossover value for the subwoofer.

1 Set up the microphone

Mount the setup microphone on a tripod or stand and place it in the main listening position.

When placing the setup microphone, adjust the height of the sound receptor to the level of the listener's ear.

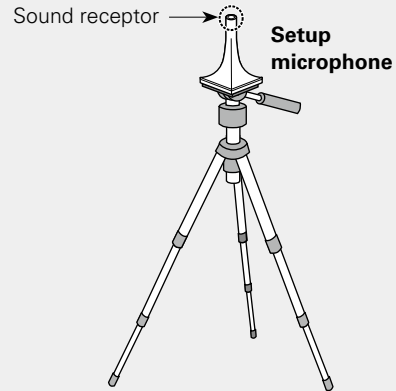

If you do not have a tripod or stand, set up the microphone on, for example, a seat without a back.

NOTE

- Do not hold the setup microphone in your hand during measurements.
- Avoid placing the setup microphone close to a seat back or wall as sound reflections may give inaccurate results.

2 Set up the subwoofer

If using a subwoofer capable of the following adjustments, set up the subwoofer as shown below.

□ When using a subwoofer with a direct mode

Set the direct mode to "On" and disable the volume adjustment and crossover frequency setting.

□ When using a subwoofer without a direct mode

Make the following settings:

- **Volume** : "12 o'clock position"
- **Crossover frequency** : "Maximum/Highest Frequency"
- **Low pass filter** : "Off"
- **Standby mode** : "Off"

3 Set up the remote control unit

□ Set up the operation mode

Press **AMP** to set the remote control unit to AMP-operation mode.

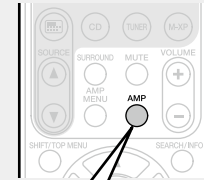

Press AMP

STEP 1 Preparation

4 Connect the setup microphone to the SETUP MIC jack of this unit.

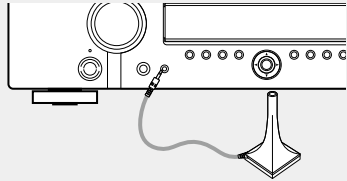

When the setup microphone is connected, the following screen is displayed.

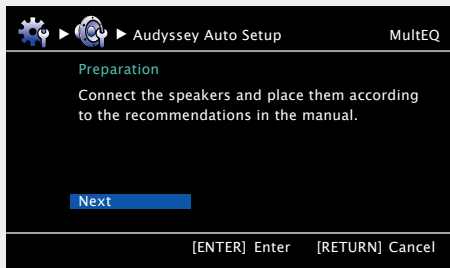

5 Select “Next” and then press ENTER.

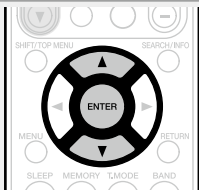

STEP 2 Detect & Measure (Main)

6 Use Δ / ∇ to select “Auto Setup Start” and then press ENTER.

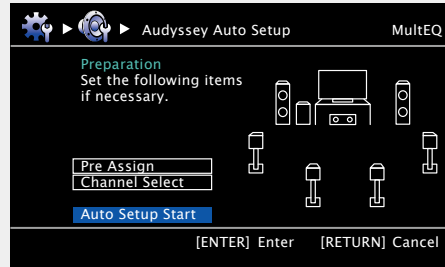

Here, we explain setup using the example of 5.1-channel speaker playback.

For settings other than 5.1-channel surround, select “Pre Assign” and perform step 4 to 5 of “Set up “Pre Assign”” (page 35). If unused channels are set with “Channel Select”, measuring time can be shortened. For setting, perform steps 7 to 11 of “Set up “Channel Select”” (page 36).

- In STEP 2, you will perform measurements at the main listening position.
- This step automatically checks the speaker configuration and speaker size, and calculates the channel level, distance, and crossover frequency. It also corrects distortion in the listening area.

7 Select “Measure” and then press ENTER.

When measuring begins, a test tone is output from each speaker.

- Measurement requires several minutes.

8 The detected speakers are displayed.

- The illustration below shows an example of when the front speakers, center speaker, subwoofer, and surround speakers have been detected.

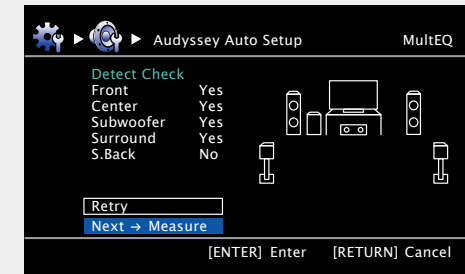

NOTE

If a connected speaker is not displayed, the speaker may not be connected correctly. Check the speaker connection.

9 Use Δ / ∇ to select “Next → Measure” and then press ENTER.

STEP 2 (Continued) Detect & Measure (Main)

NOTE

If "Caution!" is displayed:

Go to "Error messages" (page 16), check any related items, and perform the necessary procedures.

If the problem is resolved, return and restart "Audyssey® Auto Setup".

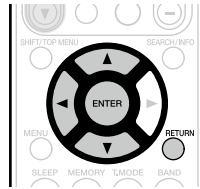

When performing Audyssey® Auto Setup over again

Press Δ / ∇ to select "Retry", and then press **ENTER**.

When measuring has stopped

- ① Press **RETURN**, to the "Cancel Auto Setup?" prompt is displayed.
- ② Press \leftarrow to select "Yes", then press **ENTER**.

Setting up the speakers again

Repeat the operation from step 4 of **STEP 1 Preparation**.

STEP 3 Measure (2nd – 6th)

- In STEP 3, you will perform measurements at multiple positions (two to six positions) other than the main listening position.
- Just one position can be measured but measuring multiple positions increases the accuracy of the correction of acoustic distortion within the listening area.

10 Move the setup microphone to position 2, use Δ / ∇ to select "Measure", and then press **ENTER**.

The measurement of the second position starts. Measurements can be made in up to six positions.

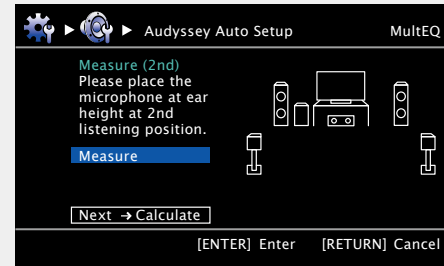
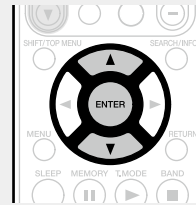

If you want to omit measurements from the next position onward, select "Next \rightarrow Calculate".
(Go to **STEP4 Calculate**)

11 Repeat step 10, measuring positions 3 to 6.

When measurement of position 6 is completed, a "Measurements finished." message is displayed.

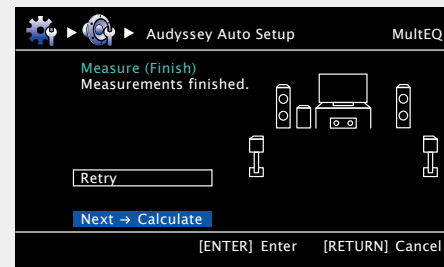

STEP 4 Calculate

12 On the **STEP 3** screen, use Δ / ∇ to select "Next \rightarrow Calculate", and then press **ENTER**.

Measuring results are analyzed, and the frequency response of each speaker in the listening room is determined.

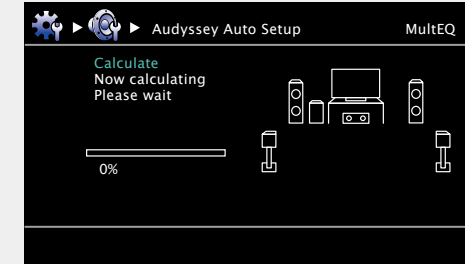

- Analysis takes several minutes to complete. The time required for this analysis depends on the number of speakers connected. The more connected speakers there are, the longer it takes to perform analysis.

STEP 5 Check

- 13** Use Δ / ∇ to select the item you want to check, and then press **ENTER**.

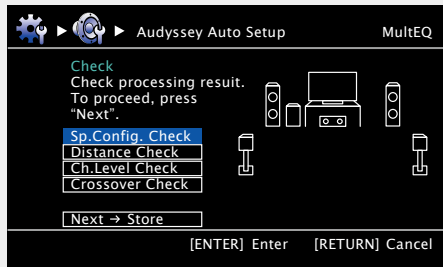
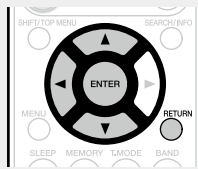

- Subwoofers may measure a greater reported distance than the actual distance due to added electrical delay common in subwoofers.
- If you want to check another item, press **RETURN**.

- 14** Use Δ / ∇ to select "Next → Store" and then press **ENTER**.

NOTE

- If the result differs from the actual connection status, or if "Caution!" is displayed, see "Error messages" ([page 16](#)). Then carry out Audyssey® Auto Setup again.
- If you change speaker positions or orientation, perform Audyssey® Auto Setup again to find the optimal equalizer settings.

STEP 6 Store

- 15** Select "Store" and then press **ENTER**.
Save the measurement results.

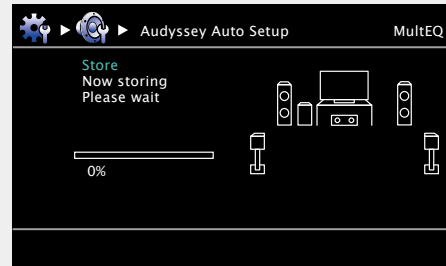
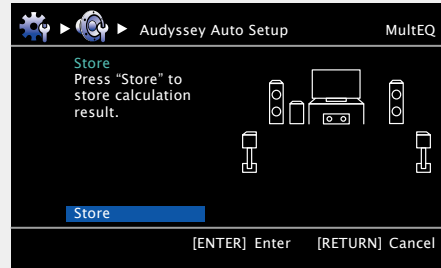

- Saving the results requires about 10 seconds.
- If the measuring results are not to be saved, press **RETURN**. A message "Cancel Auto Setup?" will be displayed. Press \triangleleft then select "Yes". All the measured Audyssey® Auto Setup data will be erased.
- During saving of measurements results, "Now storing Please wait" is displayed. When saving is completed, "Storing complete. Auto Setup is now finished." is displayed.

NOTE

During saving of measurement results, be sure not to turn off the power.

Finish

- 16** Unplug the setup microphone from the unit's **SETUP MIC** jack.

- 17** Set Audyssey Dynamic Volume®.

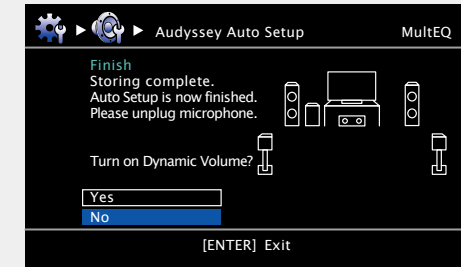

- This feature adjusts the output volume to the optimal level while constantly monitoring the level of the audio input to the unit. Optimal volume control is performed automatically without any loss in the dynamism and clarity of the sound when, for example, the volume suddenly increases for commercials shown during television programs.

☐ When turning Dynamic Volume® on

- Use Δ to select "Yes", and then press **ENTER**. The unit automatically enters "Medium" mode.

☐ When turning Dynamic Volume® off

- Use ∇ to select "No", and then press **ENTER**.

NOTE

After performing Audyssey® Auto Setup, do not change the speaker connections or subwoofer volume. In event of a change, perform Audyssey® Auto Setup again.

Error messages

NOTE

- An error message is displayed if Audyssey® Auto Setup could not be completed due to speaker placement, the measurement environment, etc. If this happens, check the relevant items, be sure to take the necessary measures, then perform Audyssey® Auto Setup over again.
- If the result still differs from the actual connection status after remeasurement or the error message still appears, it is possible that the speakers are not connected properly. Turn this unit off, check the speaker connections and repeat the measurement process from the beginning.
- Be sure to turn off the power before checking speaker connections.

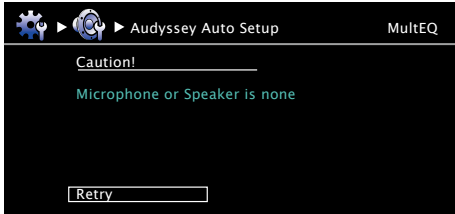
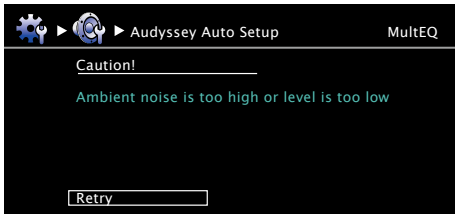
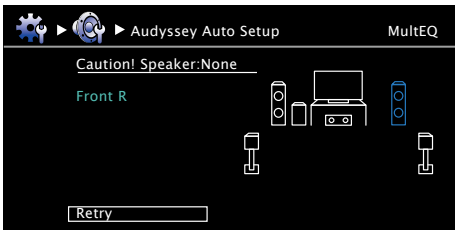
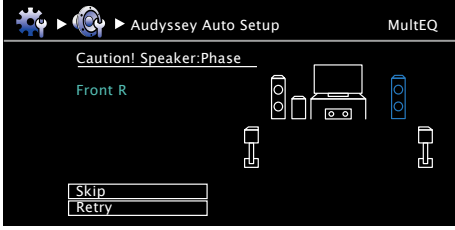
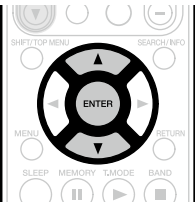
Examples	Error details	Measures
	<ul style="list-style-type: none"> • The connected setup microphone is broken, or a device other than the supplied setup microphone is connected. • Not all speakers could be detected. • The front L speaker was not properly detected. 	<ul style="list-style-type: none"> • Connect the included setup microphone to the SETUP MIC jack of this unit. • Check the speaker connections.
	<ul style="list-style-type: none"> • There is too much noise in the room for accurate measurements to be made. • Speaker or subwoofer sound is too low for accurate measurements to be made. 	<ul style="list-style-type: none"> • Either turn off any device generating noise or move it away. • Perform again when the surroundings are quieter. • Check the speaker installation and the direction in which the speakers are facing. • Adjust the subwoofer's volume.
	<ul style="list-style-type: none"> • The displayed speaker could not be detected. (The screen on the left indicates that the front right speaker cannot be detected.) 	<ul style="list-style-type: none"> • Check the connections of the displayed speaker.
	<ul style="list-style-type: none"> • The displayed speaker is connected with the polarity reversed. (The screen on the left indicates that the polarity phases of the front right speakers are reversed.) 	<ul style="list-style-type: none"> • Check the polarity of the displayed speaker. • For some speakers, this error message may be displayed even if the speaker is properly connected. If you are sure the connection is correct, press $\Delta \nabla$ to select "Skip", then press ENTER. 

Parameter Check

This function enables you to check the measurement results and equalizer characteristics after Audyssey® Auto Setup.

1 Use Δ / ∇ to select “Parameter Check” and then press **ENTER**.

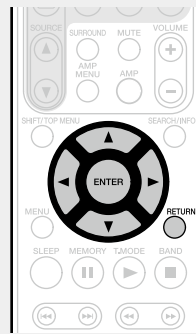
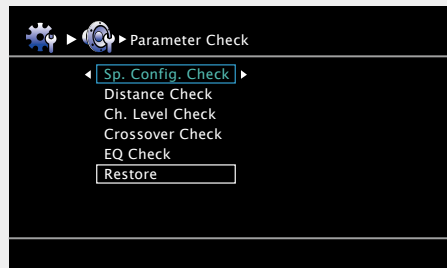
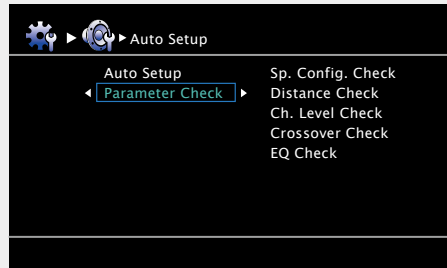

2 Use Δ / ∇ to select the item you want to check, then press **ENTER** or \triangleright .

Measurement results for each speaker are displayed.

Sp. Config. Check Check the speaker configuration.

Distance Check Check the distance.

Ch. Level Check Check the channel level.

Crossover Check Check the crossover frequency.

EQ Check Check the equalizer.

- If “EQ Check” is selected, press Δ / ∇ to select equalizing curve (“Audyssey” or “Audyssey Flat”) to be checked.

Use \triangleleft / \triangleright to switch the display between the different speakers.

3 Press **RETURN**.

The confirmation screen reappears. Repeat step 2.

Retrieving Audyssey® Auto Setup settings

If you set “Restore” to “Yes”, you can return to Audyssey® Auto Setup measurement result (value calculated at the start by MultEQ®) even when you have changed each setting manually.

Playback (Basic operation)

Settings (👉 page 11)

- ❑ **Selecting the input source** (👉 page 18)
- ❑ **Adjusting the master volume** (👉 page 19)
- ❑ **Turning off the sound temporarily** (👉 page 19)

- ❑ **Playing a Blu-ray Disc player/DVD player** (👉 page 19)
- ❑ **Playing a CD player** (👉 page 19)
- ❑ **Tuning in radio stations** (👉 page 20)

Selecting a listening mode (Surround mode) (👉 page 24)

Playback (Advanced operation) (👉 page 38)

Important information

Before starting playback, make the connections between the different devices and the settings on the unit.

NOTE

Also refer to the operating instructions of the connected devices when playing them.

Selecting the input source

Press the input source select button (**BD, DVD, SAT, TV, CD, TUNER or M-XP**) twice to be played back.

When an input source select button (**BD, DVD, SAT, TV, CD, TUNER or M-XP**) is pressed once, the unit switches to device selected by the operating mode of the remote control. If the input source select button is then pressed again twice, the input source for the unit is switched.

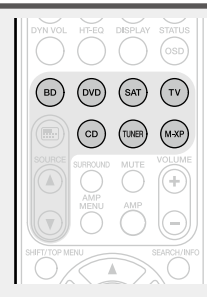

Select input source "AUX" to play back music from an audio system connected to the AUX INPUT jack. The input source "GAME" is selected to playback from a game device connected to GAME connector of HDMI IN. Select the input source "AUX" or "GAME" using one of the following methods.

- "Source Select" menu
(Using the "Source Select" menu" provided on the right)
- **SOURCE ▲▼** button on the remote control unit
(Using the **SOURCE ▲▼** button on the remote control unit" (👉 page 19))
- **INPUT SELECTOR** knob on the main unit
(Using the knob on the main unit" (👉 page 19))

You can also use the following operation to select an input source.

❑ Using the "Source Select" menu

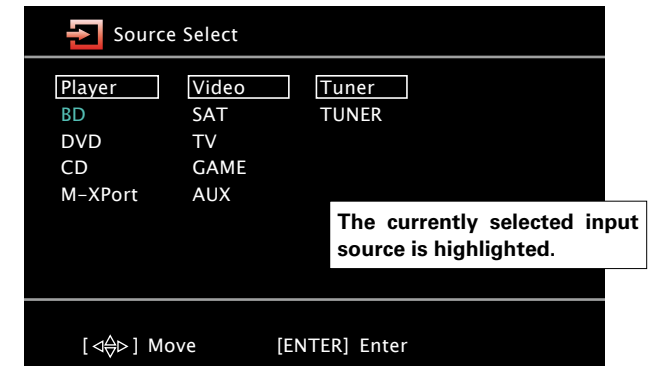

- ① Press .
Display the "Source Select" menu.
- ② Use to select the input source, then press **ENTER**.
The input source is set and the source selection menu is turned off.

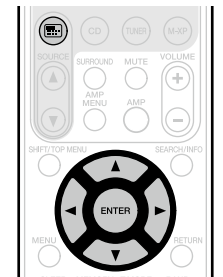

- Input sources that are not going to be used can be set ahead of time. Make this setting at "Source Delete" (👉 page 59).
- To turn off the source selection menu without selecting an input source, press again.
- When is pressed, the AMP-operation mode starts automatically (👉 page 68).

Using the SOURCE ▲ ▼ button on the remote control unit

Press **SOURCE ▲** or **SOURCE ▼**.

- Every time you press **SOURCE ▲** or **SOURCE ▼**, the input source switches in the following order.

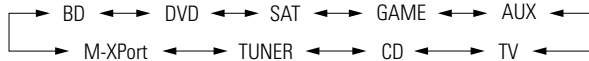
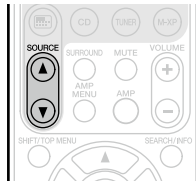

Using the knob on the main unit

Turn **INPUT SELECTOR**.

- Every time you turn **INPUT SELECTOR**, the input source switches in the following order.



Adjusting the master volume

Use **VOLUME +, -** to adjust the volume.

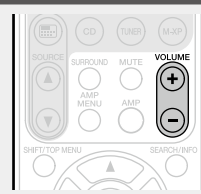

- When the "Volume Display" setting (page 59) is "Relative" [Adjustable range]

--- -80.5dB - 18.0dB

- When the "Volume Display" setting (page 59) is "Absolute" [Adjustable range] 0.0 - 99.0

- The variable range differs according to the input signal and channel level setting.



You can also operate via the main unit. In this case, perform the following operations.
Turn **VOLUME** to adjust the volume.

Turning off the sound temporarily

Press **MUTE**.

- "MUTE" indicator on the display lights.
-  appears on a TV screen.

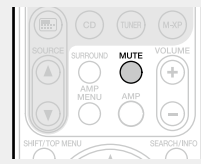

- The sound is reduced to the level set at "Mute Level" (page 59).
- To cancel, press **MUTE** again. Muting can also be canceled by adjusting the master volume.

Playing a Blu-ray Disc player/DVD player

The following describes the procedure for playing Blu-ray Disc player/DVD player.

1 Prepare for playback.

- ① Turn on the power of the TV, subwoofer and player.
- ② Change the TV input to the input of this unit.
- ③ Load the disc in the player.



2 Press ON to turn on power to the unit.

3 Press BD or DVD twice to switch an input source for a player used for playback.

4 Play the device connected to this unit.

- Make the necessary settings on the player (language setting, subtitles setting, etc.) beforehand.

Playing a CD player

The following describes the procedure for playing CD player.

1 Prepare for playback.

- ① Turn on the power of the subwoofer and player.
- ② Load the disc in the player.



2 Press ON to turn on power to the unit.

3 Press CD twice to switch an input source for a player used for playback.

4 Play the device connected to this unit.

Tuning in radio stations

Listening to FM/AM broadcasts

1 Press **TUNER** twice to switch the input source to “TUNER”.

2 Press **BAND** to select “FM” or “AM”.

FM When listening to an FM broadcast.

AM When listening to an AM broadcast.

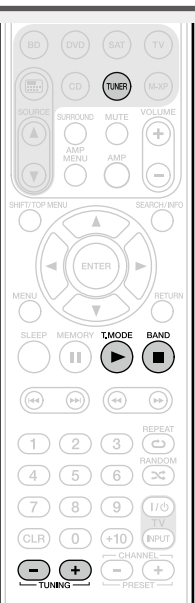
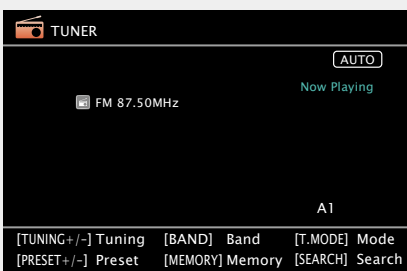

3 Tune in the desired broadcast station.

1 To tune in automatically (Auto tuning)

Press **T.MODE** to light the “AUTO” indicator on the display, then use **TUNING +** or **TUNING -** to select the station you want to hear.

2 To tune in manually (Manual tuning)

Press **T.MODE** to turn off the display’s “AUTO” indicator, then use **TUNING +** or **TUNING -** to select the station you want to hear.



- You can also operate via the main unit. In this case, perform the following operations.
Press **BAND** to select “FM” or “AM”.
Press $\Delta \nabla$ to select the station you want to hear.
- If the desired station cannot be tuned in with auto tuning, tune it in manually.
- When tuning in stations manually, press and hold **TUNING +** or **TUNING -** to change frequencies continuously.
- The time (default : 30 sec) for which the menu are displayed can be set at menu “Tuner” (page 60). Press $\Delta \nabla < \triangleright$ to return to the original screen.

❑ Presetting radio stations (Manual preset)

Your favorite broadcast stations can be preset so that you can tune them in easily. Up to 56 stations can be preset.

- Stations can be preset automatically at “Auto Preset” (page 63). If “Auto Preset” is performed after performing “Manual preset”, the “Manual preset” settings will be overwritten.

1 Tune in the broadcast station you want to preset.

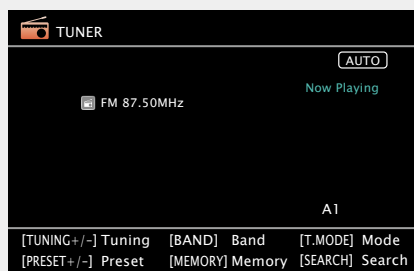

2 Press **MEMORY**.

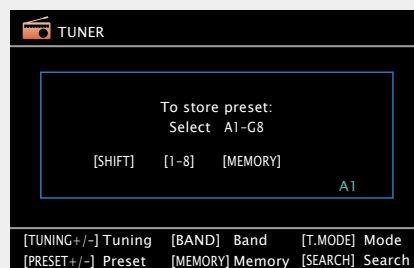

3 Press **SHIFT/TOP MENU** to select the block (A to G) in which the channel (1 to 8 per a block) is to be preset, then press **PRESET +**, **PRESET -** or **1 - 8** to select the preset number.

4 Press **MEMORY** again to complete the setting.

- To preset other stations, repeat steps 1 to 4.

Default settings

Block (A – G) and Channel (1 – 8)	Default Settings
A1 – A8	87.50 / 89.10 / 98.10 / 108.00 / 90.10 / 90.10 / 90.10 / 90.10 MHz
B1 – B8	522 / 603 / 999 / 1404 / 1611 kHz, 90.10 / 90.10 / 90.10 MHz
C1 – C8	90.10 MHz
D1 – D8	90.10 MHz
E1 – E8	90.10 MHz
F1 – F8	90.10 MHz
G1 – G8	90.10 MHz

Specify a name for the preset broadcast station (Preset Name) (page 63)

Listening to preset stations

1 Press **SHIFT/TOP MENU** to select the memory block (A to G).

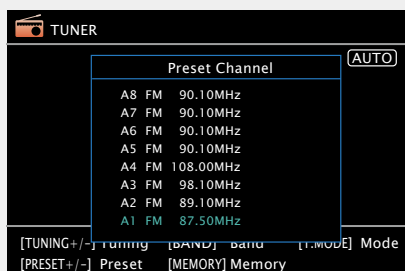

2 Press **PRESET +**, **PRESET -** or **1 - 8** to select the desired preset channel.



You can also operate via the main unit. In this case, perform the following operations.
Press $\triangleleft \triangleright$ to select a preset radio station.

Direct frequency tuning

You can enter the receiving frequency directly to tune in.

1 Press **SEARCH/INFO**.

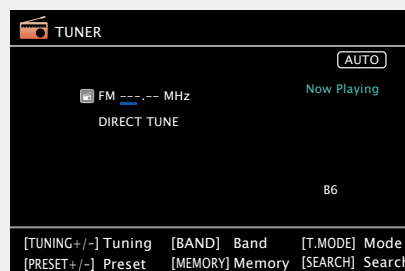

2 Input frequencies using the **0 - 9**.

- If \triangleleft is pressed, the immediately preceding input is cancelled.

3 When setting is completed, press **ENTER**.

The preset frequency is tuned in.

RDS (Radio Data System)

Note that the RDS function only works when receiving RDS compatible stations.

RDS (works only on the FM band) is a broadcasting service which allows a station to send additional information along with the regular radio program signal.

NOTE

The operations described as follows using **SEARCH/INFO** will not function in areas in which there are no RDS broadcasts.

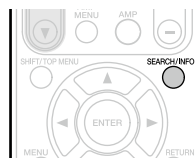

RDS search

Use this function to automatically tune to FM stations that provide the RDS service.

1 Press **TUNER** twice to switch the input source to “TUNER”.

2 Press **SEARCH/INFO** to select “RDS”.

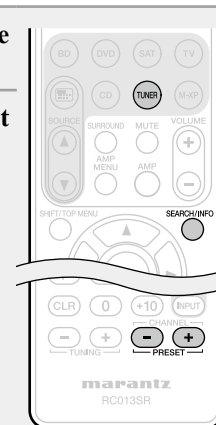
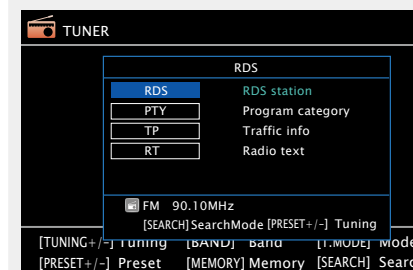

3 Press **PRESET +** or **PRESET -**.

The search for RDS stations begins automatically.

- If no RDS stations are found with the above operation, all the reception bands are searched.
- When a broadcast station is found, that station's name appears on the display.
- If no RDS station is found when all the frequencies have been searched, “NO RDS” is displayed.



If you press **PRESET +** or **PRESET -** within 5 seconds after the broadcast station name is shown on the display, you can search for a different station.

PTY (Program Type)

PTY identifies the type of RDS program.
The program types and their displays are as follows:

NEWS	News	WEATHER	Weather
AFFAIRS	Current Affairs	FINANCE	Finance
INFO	Information	CHILDREN	Children's program
SPORT	Sports	SOCIAL	Social Affairs
EDUCATE	Education	RELIGION	Religion
DRAMA	Drama	PHONE IN	Phone In
CULTURE	Culture	TRAVEL	Travel
SCIENCE	Science	LEISURE	Leisure
VARIED	Varied	JAZZ	Jazz Music
POP M	Pop Music	COUNTRY	Country Music
ROCK M	Rock Music	NATION M	National Music
EASY M	Easy Listening Music	OLDIES	Oldies Music
LIGHT M	Light Classical	FOLK M	Folk Music
CLASSICS	Serious Classical	DOCUMENT	Documentary
OTHER M	Other Music		

PTY search

Use this function to find RDS stations broadcasting a designated program type (PTY).

1 Press TUNER twice to switch the input source to "TUNER".

2 Press SEARCH/INFO to select "PTY".

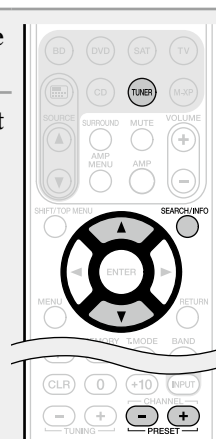
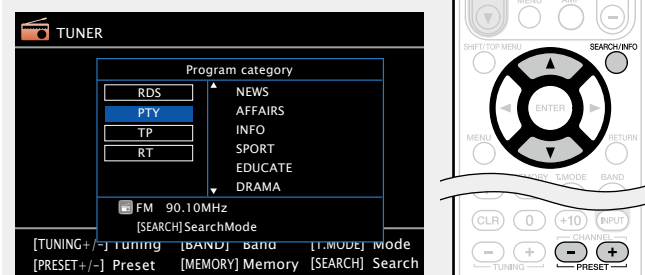

3 Watching the display, press Δ / ∇ to call out the desired program type.

4 Press PRESET + or PRESET -.
PTY search begins automatically.

- If there is no station broadcasting the designated program type with the above operation, all the reception bands are searched.
- The station name is displayed on the display after searching stops.
- If no station broadcasting the designated program type is found when all the frequencies have been searched, "NO PROGRAMME" is displayed.



If you press **PRESET +** or **PRESET -** within 5 seconds after the broadcast station name is shown on the display, you can search for a different station.

TP (Traffic Program)

TP identifies programs that carry traffic announcements.
This allows you to easily find out the latest traffic conditions in your area before leaving home.

TP search

Use this function to find RDS stations broadcasting traffic programs (TP stations).

1 Press TUNER twice to switch the input source to "TUNER".

2 Press SEARCH/INFO to select "TP".

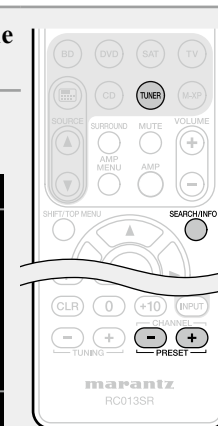
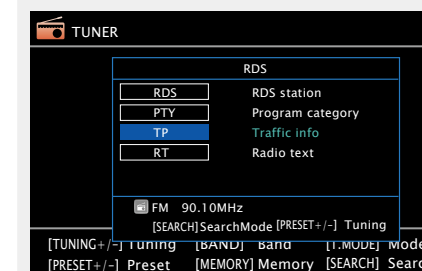

3 Press PRESET + or PRESET -.
TP search begins automatically.

- If no TP station is found with the above operation, all the reception bands are searched.
- The station name is displayed on the display after searching stops.
- If no other TP station is found when all the frequencies have been searched, "NO PROGRAMME" is displayed.



If you press **PRESET +** or **PRESET -** within 5 seconds after the broadcast station name is shown on the display, you can search for a different station.

RT (Radio Text)

RT allows RDS stations to send text messages that appear on the display.

“RT” appears on the display when radio text data is received.

1 Press **TUNER** twice to switch the input source to “TUNER”.

2 Press **SEARCH/INFO** to select “RT”.

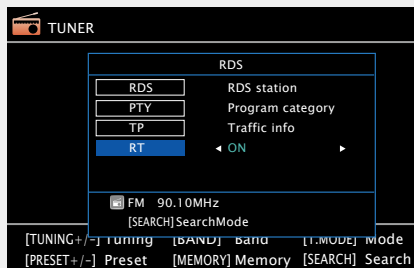

- While receiving an RDS broadcast station, the text data broadcast from the station is displayed.
- To turn the display off, press $\triangleleft \triangleright$.
- If no text data is being broadcast, “NO TEXT DATA” is displayed.

Tuner (FM/AM) operation

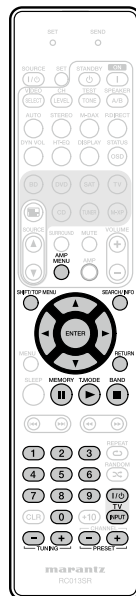

Operation buttons	Function
AMP MENU	Amp menu
SHIFT/TOP MENU	Preset channel block selection
SEARCH/INFO	Direct frequency tuning / RDS Search
$\triangle \nabla \triangleleft \triangleright$	Cursor operation
ENTER	Enter
RETURN	Return
MEMORY	Preset memory registration
T.MODE	Switch search modes
BAND	FM/AM switching
0 - 9	Preset channel selection (1 - 8) / Direct frequency tuning (0 - 9)
TV I/⏻	TV power on/standby (Default : marantz)
TV INPUT	Switch TV input (Default : marantz)
TUNING +, -	Tuning (up/down)
PRESET +, -	Preset channel selection

Switching the tuning increment

The tuning increment factory settings are 9 kHz for AM, and 0.05 MHz for FM.

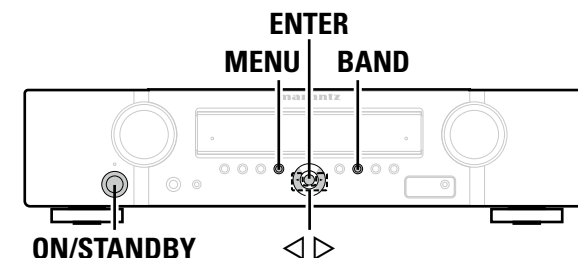

- 1** While pressing down **MENU** and **BAND**, press **ON/STANDBY** to turn on the power. “AM9/FM50” appears on the display.
- 2** Press $\triangleleft \triangleright$. “AM10/FM200” appears on the display, and the tuning increment is switched to AM and FM are 10 kHz and 0.2 MHz.
- 3** Press **ENTER**.
- 4** Press **ON/STANDBY**.

- The tuner preset memory will be cleared if this operation is performed.
- This setting will not revert to the default values even when the microprocessor is reset.

Selecting a listening mode (Surround mode)

This unit can play input audio signals in multi-channel surround mode or in stereo mode.
Select a listening mode suitable for the playback contents (movie, music, etc.) or according to your liking.

Selecting a listening mode

1 Play the selected device (📖 [page 19](#)).

2 Press **SURROUND**, **AUTO**, **STEREO** or **P.DIRECT** to select a listening mode.

- Each time **SURROUND**, **AUTO**, **STEREO** or **P.DIRECT** is pressed, the listening mode is switched.

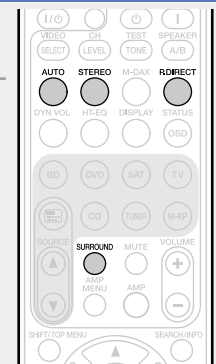

- SURROUND** Various types of surround sound can be selected to match the source being played back. Press **SURROUND** until the desired surround mode is reached.
- AUTO** This mode detects the type of input digital signal, and automatically selects the corresponding mode for playback.
- STEREO** Switches the listening mode to Stereo mode.
- P.DIRECT** Switches the listening mode to DIRECT or PURE DIRECT mode. In DIRECT mode, the audio is played back exactly how it was recorded. When PURE DIRECT mode is selected, the PURE DIRECT indicator on the unit lights.







The listening mode can also be selected in the same way for the **SURROUND MODE**, **AUTO** and **PURE DIRECT** on the main unit.

Listening mode

- The following listening modes can be selected using the **SURROUND**, **AUTO**, **STEREO** and **P.DIRECT** buttons.
- Adjust the sound field effect with the menu "Surr.Parameter" (page 49) to enjoy your favorite sound mode.

Operation button	Input signal	Listening mode
SURROUND 	2-channel *1	AUTO *2
		STEREO
		DOLBY PLIIx Movie *3
		DOLBY PLII Movie *3
		DOLBY PLIIx Music *3
		DOLBY PLII Music *3
		DOLBY PLIIx Game *3
		DOLBY PLII Game *3
		DOLBY Pro Logic *3
		DTS NEO:6 Cinema *3
		DTS NEO:6 Music *3
		DOLBY PLIIz Height *3
		MULTI CH STEREO
		VIRTUAL
	Multi-channel *4	AUTO *2
		STEREO
	Dolby Digital	DOLBY DIGITAL
		DOLBY DIGITAL EX
		DOLBY DIGITAL + PLIIx Movie
		DOLBY DIGITAL + PLIIx Music
	Dolby TrueHD	DOLBY DIGITAL + PLIIz
		DOLBY TrueHD
		DOLBY TrueHD + EX
		DOLBY TrueHD + PLIIx Movie
	Dolby Digital Plus	DOLBY TrueHD + PLIIx Music
		DOLBY TrueHD + PLIIz
		DOLBY DIGITAL Plus
		DOLBY DIGITAL Plus + EX
	DTS	DOLBY DIGITAL Plus + PLIIx Movie
		DOLBY DIGITAL Plus + PLIIx Music
		DOLBY DIGITAL Plus + PLIIz
		DTS SURROUND
		DTS ES DSCRT 6.1
DTS ES MTRX 6.1		
DTS 96/24		
DTS 96 ES MTRX		
DTS ES DSCRT		
DTS + NEO:6		
DTS + PLIIx Movie		
DTS + PLIIx Music		
DTS + PLIIz		

Operation button	Input signal	Listening mode
SURROUND 	DTS-HD / DTS Express	DTS-HD HI RES
		DTS-HD MSTR
		DTS Express
		DTS-HD + NEO:6
		DTS-HD + PLIIx Movie
		DTS-HD + PLIIx Music
	PCM multi-channel	DTS-HD + PLIIz
		MULTI CH IN
		MULTI CH IN 7.1
		MULTI IN + Dolby EX
Multi-channel *4	MULTI IN + PLIIx Movie	
	MULTI IN + PLIIx Music	
	MULTI IN + PLIIz	
AUTO 	All	AUTO *2
STEREO 	All	STEREO
P.DIRECT 	All	DIRECT PURE DIRECT AUTO *2

- *1 2-channel also includes analog input.
- *2 When AUTO mode is selected, the surround mode that is compatible with the input signal is used for playback.
- *3 This mode plays back 2-channel source in 5.1 or 7.1-channel playback. It cannot be selected when headphones are used, or when only front speakers are used.
- *4 Some listening modes cannot be selected, depending on the audio format or number of channels of the input signal. For details, see "Types of input signals, and corresponding surround modes" (page 82).

NOTE

When you use headphones, you can choose the VIRTUAL, STEREO, DIRECT and PURE DIRECT mode.

Views on the TV screen or display

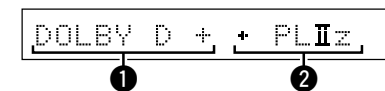

- Shows a decoder to be used.
 - A DOLBY DIGITAL Plus decoder is displayed as "DOLBY D +".
- Shows a decoder that creates sound output from the surround back speakers.
 - "+ PLIIz" indicates the front height sound from front height speakers.

□ **Description of listening mode types**

Dolby listening mode

Listening mode type	Description
DOLBY PLIIx*1	This mode can be selected when a Dolby Pro Logic IIx decoder is used to play back 2-channel source in 6.1/7.1-channel surround sound including the surround back channel. By adding the surround back channel, a stronger surround feeling is obtained compared to Dolby Pro Logic II. There are three playback modes: "Movie" mode that is optimized for movie playback, "Music" mode that is optimized for music playback, and "Game" mode that is optimized for game play.
DOLBY PLII	This mode can be selected when a Dolby Pro Logic II decoder is used to play back 2-channel source in 5.1-channel surround sound with a natural, realistic feel.
DOLBY Pro Logic	This mode can be selected when a DOLBY Pro Logic decoder is used to play 2-channel source in 4.1-channel surround sound (Left/Center/Right/Surround Mono).
DOLBY PLIIz*2	This mode can be selected when a Dolby Pro Logic IIz decoder is used to play back 2-channel source in 7.1-channel surround sound with added front height channel. By adding a front height channel, the vertical expression is emphasized, improving the three-dimensionality of the sound.
DOLBY DIGITAL	This mode can be selected when playing sources recorded with Dolby Digital.
DOLBY DIGITAL EX*1	This mode improves the depth, dimension, and expressiveness of the sound stage by sound field playback including surround back channels.
DOLBY TrueHD	This mode can be selected when playing sources recorded in Dolby TrueHD.
DOLBY DIGITAL Plus	This mode can be selected when playing sources recorded with Dolby Digital Plus.

*1 This can be selected when "Speaker Config." – "S.Back" is not set to "None".

*2 This can be selected when "Speaker Config." – "F.Height" is not set to "None".

DTS listening mode

Listening mode type	Description
DTS NEO:6	This mode can be selected when a DTS NEO:6 decoder is used to play back 2-channel source in 6.1/7.1-channel surround sound including the surround back channel. There is a "Cinema" mode optimized for movie playback, and a "Music" mode optimized for music playback.
DTS SURROUND	This mode can be selected when playing sources recorded in DTS.
DTS ES DSCRT6.1*	This mode can be selected when playing sources recorded in DTS-ES. Provides optimum playback of DTS-ES Discrete signals using surround back.
DTS ES MTRX6.1*	This mode can be selected when playing sources recorded in DTS-ES. Surround back channel data encoded in DTS-ES Matrix recording software is played from the surround back channel.
DTS 96/24	This mode can be selected when playing sources recorded in DTS 96/24.
DTS-HD	This mode can be selected when playing sources recorded in DTS-HD.
DTS Express	This mode can be selected when playing sources recorded in DTS Express.

* This can be selected when "Speaker Config." – "S.Back" is not set to "None".

PCM multi-channel listening mode

Listening mode type	Description
MULTI CH IN	This mode can be selected when playing multi-channel PCM sources .

marantz original listening mode

Listening mode type	Description
MULTI CH STEREO	This mode is for enjoying stereo sound from all speakers. The same sound as that from the front speakers (L/R) is played back at the same level from the surround speakers (L/R) and surround back speakers (L/R).
VIRTUAL	This mode is for enjoying surround effects using only the front speakers or headphones.
AUTO	In this mode, the type of digital signal input, such as Dolby Digital, Dolby TrueHD, Dolby Digital Plus, Dolby Digital EX, DTS, DTS-HD, DTS-ES, PCM (multi-channel) is detected, and the playback mode switches automatically to the corresponding mode. If the input signal is analog or PCM (2-channel), stereo playback is used.

STEREO listening mode

Listening mode type	Description
STEREO	This is the mode for playing in stereo. The tone can be adjusted. <ul style="list-style-type: none"> • Sound is output from the front left and right speakers and subwoofer. • If multichannel signals are input, they are mixed down to 2-channel audio and are played.

Direct listening mode

Listening mode type	Description
DIRECT	This mode plays back tracks at high sound quality without passing through the sound quality adjustment circuits. <ul style="list-style-type: none"> • Surround back signals or front height signals are not created.
PURE DIRECT	This mode plays back tracks at the closest to the original sound quality. Turn the display of the amplifier off to stop the analogue video circuit. This suppresses the source of noise that affects sound quality. <ul style="list-style-type: none"> • Surround back signals or front height signals are not created.



In Direct listening mode, the following items cannot be adjusted.







- Tone ([page 50](#))
- MultEQ® ([page 50](#))
- Dynamic EQ® ([page 51](#))
- Dynamic Volume® ([page 51](#))
- M-DAX ([page 52](#))

NOTE

- Video signals are only output when HDMI signals are played in the PURE DIRECT mode.
- When in the PURE DIRECT mode, the menu screen is not displayed.

Advanced version

Here, we explain functions and operations that let you make better use of this unit.

- **Speaker installation/connection (Advanced)**  [page 29](#)
- **Connections (Advanced connection)**  [page 37](#)
- **Playback (Advanced operation)**  [page 38](#)
- **How to make detailed settings**  [page 43](#)
- **Other settings**  [page 67](#)
- **Operating the connected devices by remote control unit**  [page 68](#)

Speaker installation/connection (Advanced)

Here we describe the installation, connection and setup methods for speakers other than 5.1-channel speakers. For the installation, connection and setup methods for 5.1-channel speakers, see [page 4](#) "Setup Wizard".

Use **Audyssey® Auto Setup** function of this unit to automatically detect the number of connected speakers and perform optimal settings for the speakers to be used.

Procedure for speaker settings

Install

Connect ([page 31](#))

Set up speakers ([page 35](#))

Install

This unit is compatible with Dolby Pro Logic IIz ([page 85](#)), which offers an even wider and deeper surround sensation. When using Dolby Pro Logic IIz, install front height speakers.



Install the surround back speakers in a position 60 to 90 cm higher than ear level.

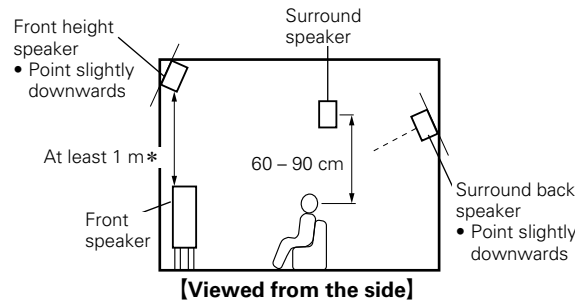

* Recommended for Dolby Pro Logic IIz

NOTE

It is not possible to use the surround back speakers and front height speakers simultaneously.

When 7.1ch (Surround back speaker) installed

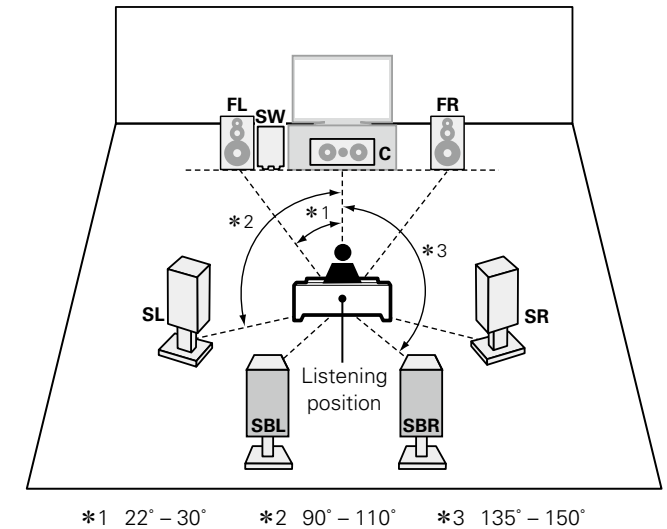

[Speaker abbreviations]

- | | |
|-----------------------------|--------------------------------------|
| FL Front speaker (L) | SL Surround speaker (L) |
| FR Front speaker (R) | SR Surround speaker (R) |
| C Center speaker | SBL Surround back speaker (L) |
| SW Subwoofer | SBR Surround back speaker (R) |

When 7.1ch (Front height speaker) installed

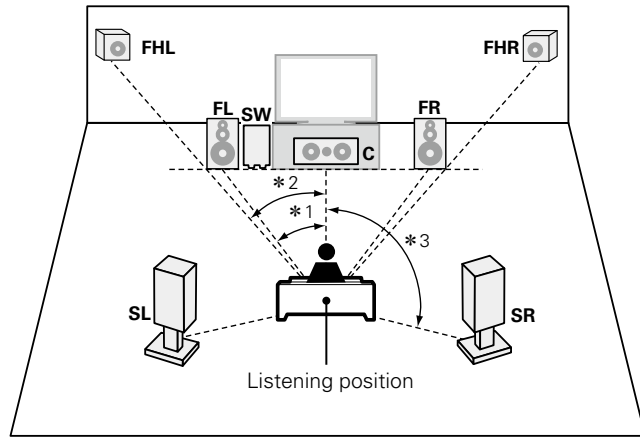

*1 22° - 30° *2 22° - 45° *3 90° - 110°

[Speaker abbreviations]

- FL** Front speaker (L)
- FR** Front speaker (R)
- C** Center speaker
- SW** Subwoofer
- SL** Surround speaker (L)
- SR** Surround speaker (R)
- SB** Surround back speaker
- FHL** Front height speaker (L)
- FHR** Front height speaker (R)

When 6.1ch (Surround back speaker) installed

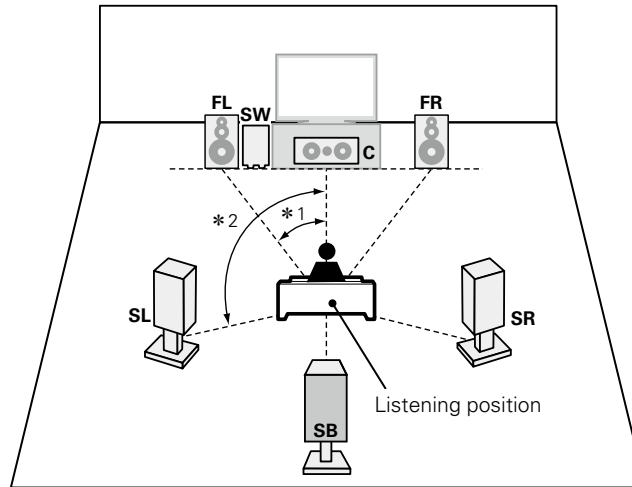

*1 22° - 30° *2 90° - 110°

When 2.1ch speakers installed

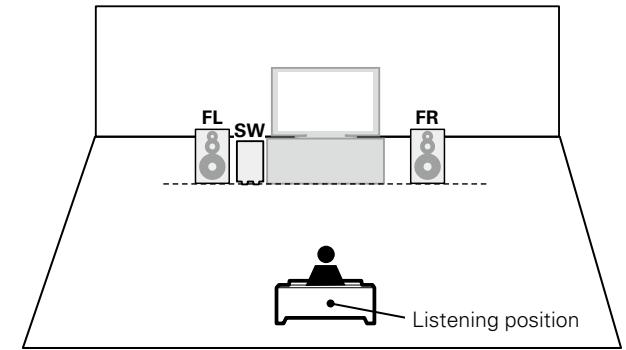

Connect

- For the method of connecting 5.1-channel speakers, see [page 6](#) “Connecting the speakers”.
- For the method of connecting the TV, see [page 3](#) “Connect this unit to the television using an HDMI cable (sold separately)”.

7.1-channel (Surround back speaker) connection

The illustration on the right shows a connection example for performing 7.1-channel playback using the surround back speakers.

To perform 7.1-channel playback using the surround back speakers, set “Pre Assign” to “NORMAL” in steps 3 and 4 for “Set up “Pre Assign”” ([page 35](#)).

Also use the “Speaker Config.” setting ([page 55](#)) to set “S.Back” to “2spkr”.

NOTE

- A power amplifier (sold separately) is required for this connection.
- For speaker cable connections, see [page 6](#) “Connecting the speakers”.
- Connect so that the speaker cable core wires do not protrude from the speaker terminal. The protection circuit may be activated if the core wires touch the rear panel or if the + and – sides touch each other ([page 86](#) “Protection Circuit”).
- Never touch the speaker terminals while the power supply is connected. Doing so could result in electric shock (When the Setup wizard is running, follow the instructions in the Setup wizard screen for making connections.).
- Use speakers with the speaker impedances shown below.

Speaker terminals	Speaker impedance
FRONT	6 – 8 Ω
CENTER	
SURROUND	

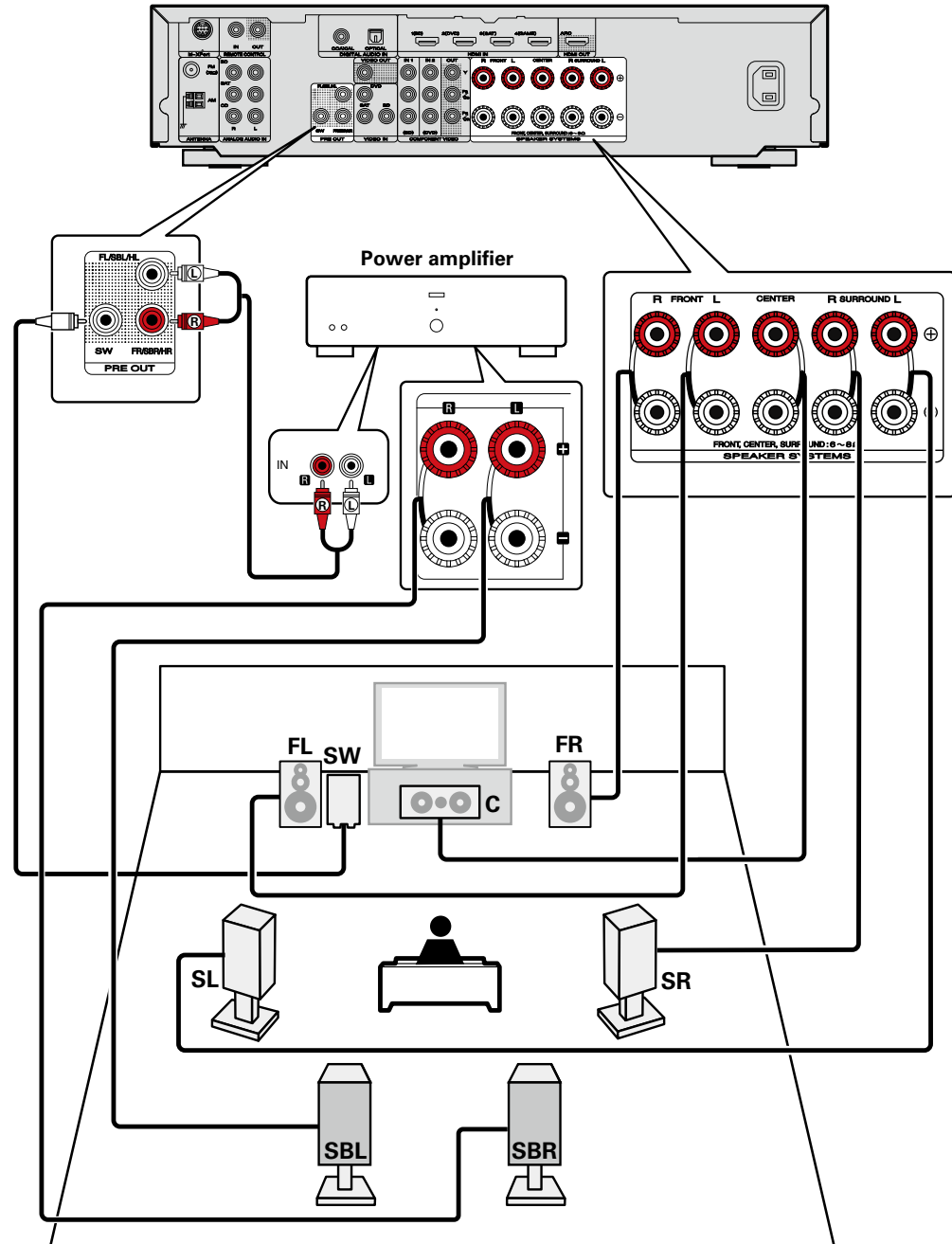

7.1-channel (Front height speaker) connection

The illustration on the right shows a connection example for performing 7.1-channel playback using the front height speakers.

To perform 7.1-channel playback using the front height speaker, set "Pre Assign" to "F.HEIGHT" in steps 3 and 4 for "Set up "Pre Assign"" ([page 35](#)).

NOTE

- A power amplifier (sold separately) is required for this connection.
- For speaker cable connections, see [page 6](#) "Connecting the speakers".
- For speaker impedance, see [page 31](#).

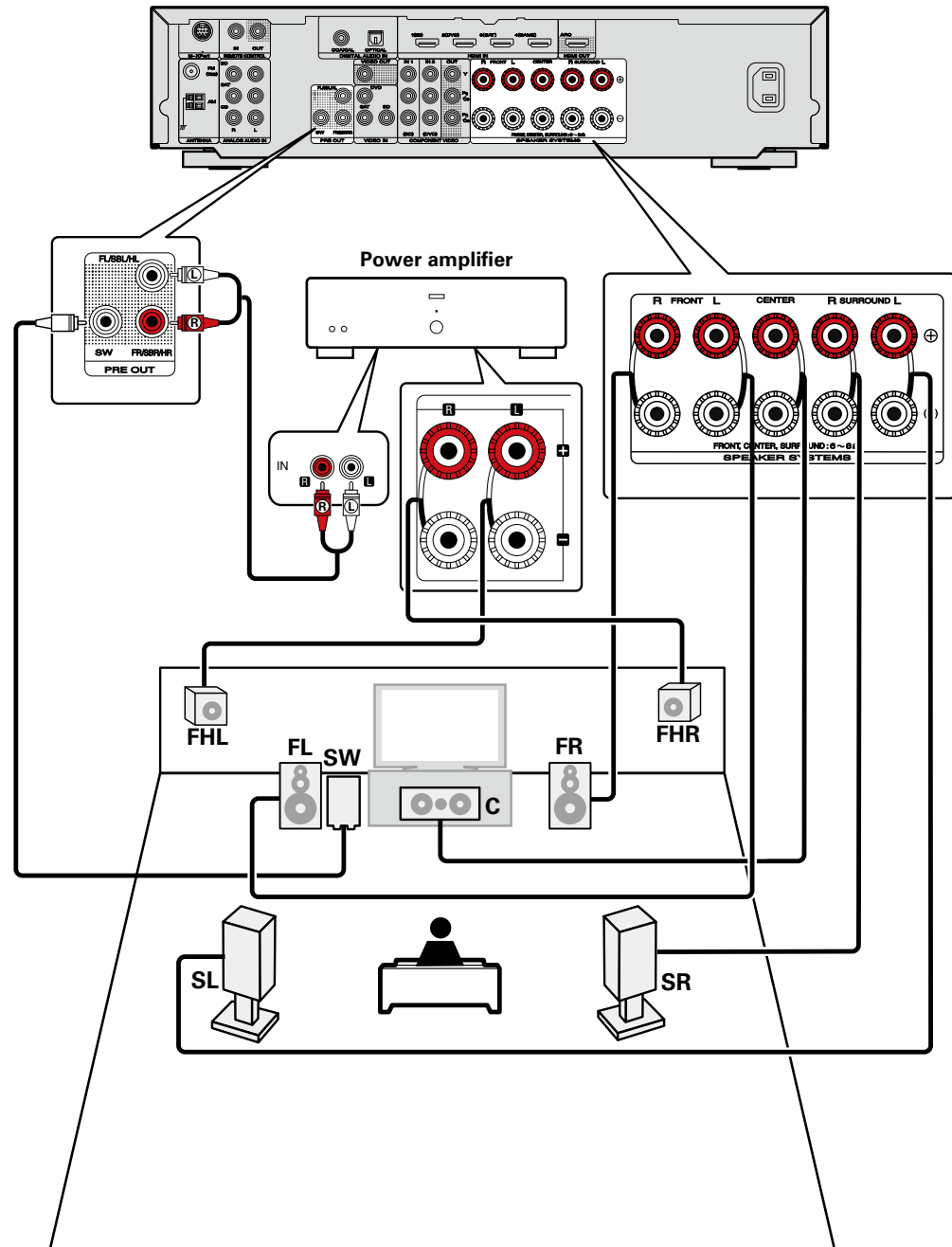

6.1-channel (Surround back speaker) connection

If using only one surround back speaker (with a 6.1-channel connection), connect to the "L" side of the FL/SBL/HL connector.

For speaker settings in this case, see "When 6.1ch (Surround back speaker) installed" ([page 30](#)).

To perform 6.1-channel playback using the surround back speaker, set "Pre Assign" to "NORMAL" in steps 3 and 4 for "Set up "Pre Assign"" ([page 35](#)).

Also use the "Speaker Config." setting ([page 55](#)) to set "S.Back" to "1spkr".

NOTE

- A power amplifier (sold separately) is required for this connection.
- For speaker cable connections, see [page 6](#) "Connecting the speakers".
- For speaker impedance, see [page 31](#).

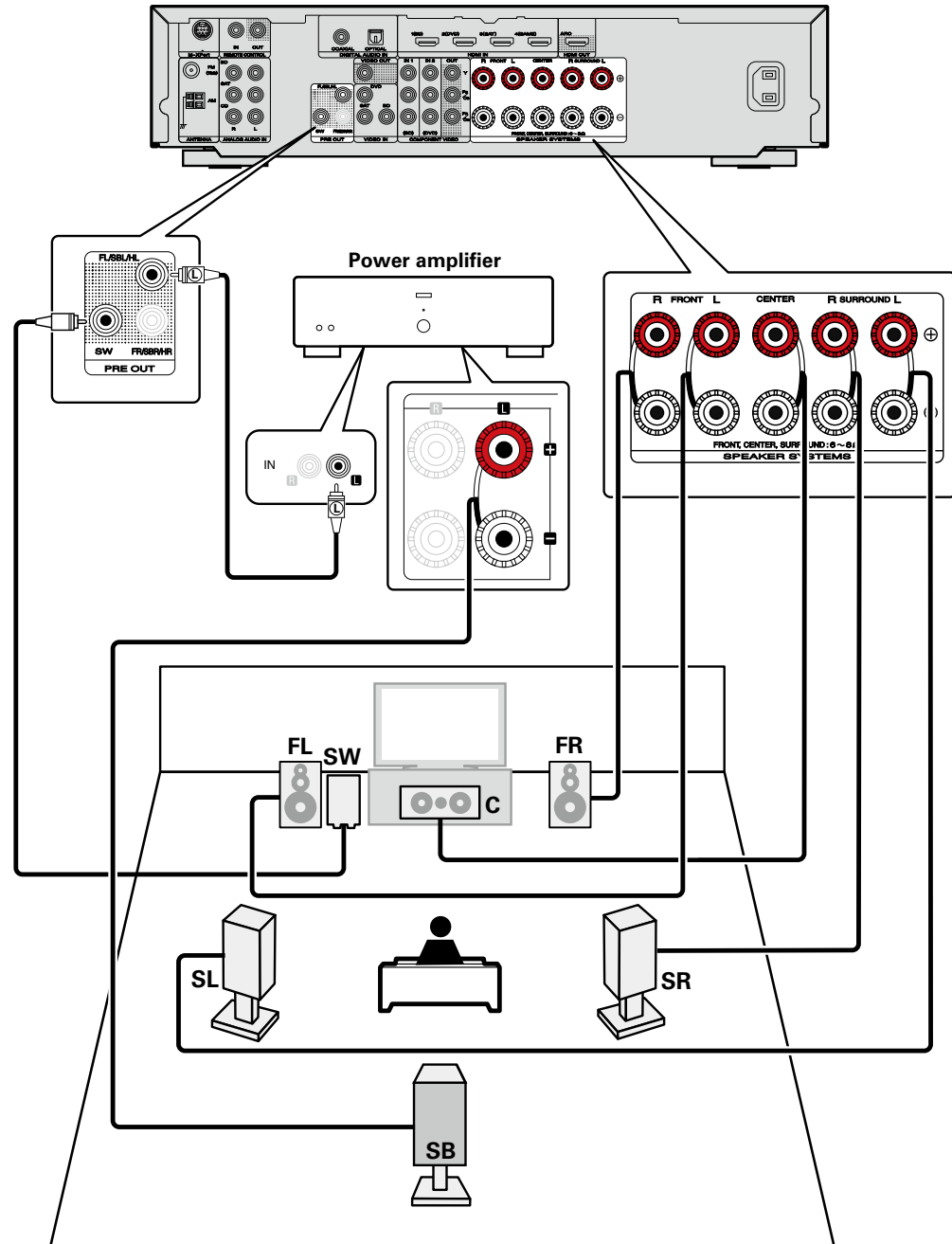

2.1-channel connection

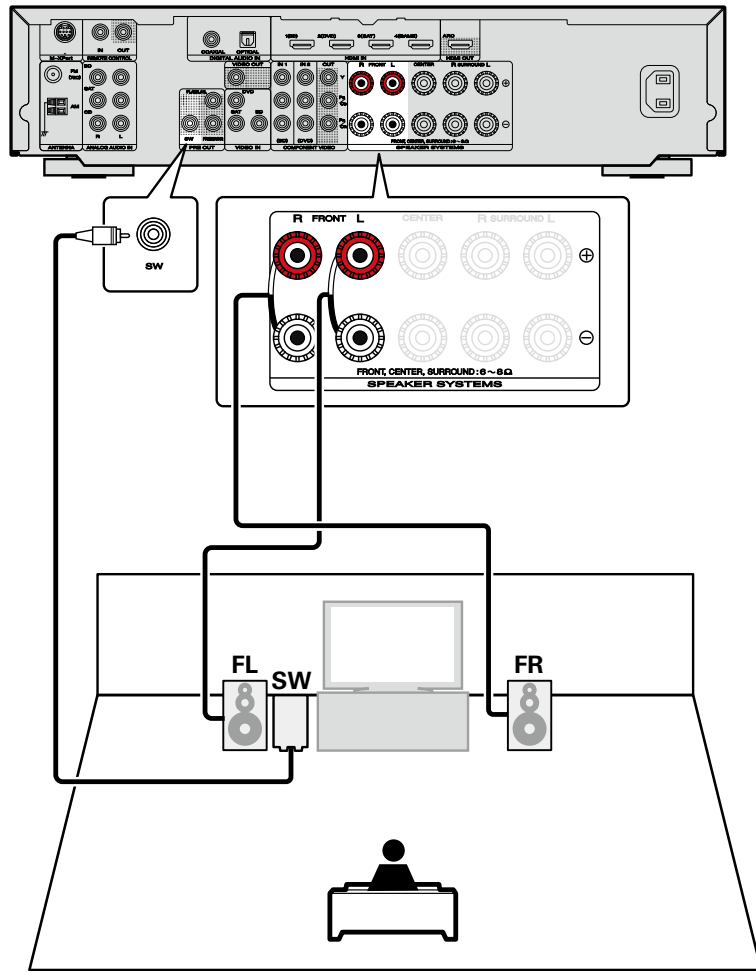

- NOTE**
- For speaker cable connections, see [page 6](#) "Connecting the speakers".
 - For speaker impedance, see [page 31](#).



The PRE OUT connectors can be used to connect front speakers. In this case, follow procedures 3 and 4 in "Set up "Pre Assign"" ([page 35](#)), and set "Pre Assign" to "FRONT".

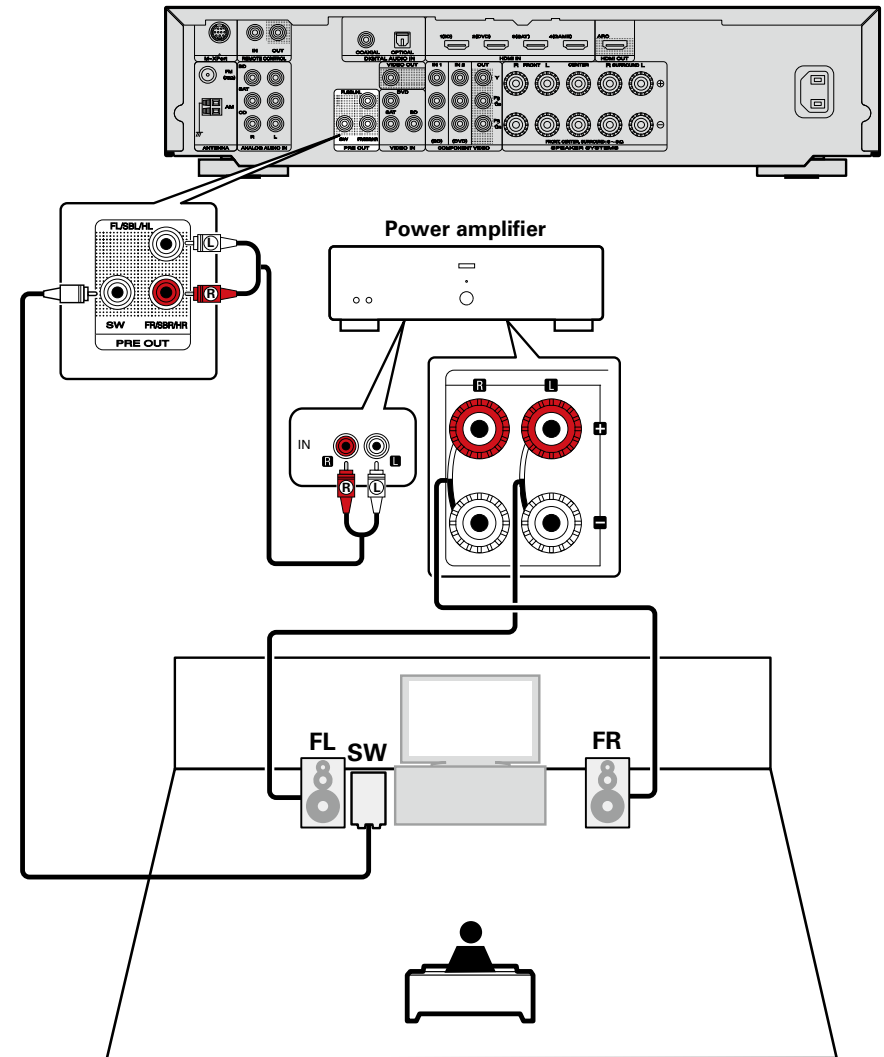

Set up speakers

 around items indicate the settings.

Here we describe how to set up speakers other than 5.1-channel speakers.

For the method of setting up 5.1-channel speakers, see [page 4 “Setup Wizard”](#).

First install and connect the speakers to this unit.

Before Auto Setup measurement, the settings shown below can be made.

- Changing the amplifier assignment (Pre Assign)
The signal output from the FL/SBL/HL and FR/SBR/HR connectors on PRE OUT of the amplifier can be switched in accordance with the speaker environment ([page 35](#) “Set up “Pre Assign””).
- Setting the channels to be used (Channel Select)
If channels that are not to be used are set in advance, measurement for the set channels is skipped, and measuring time can be reduced. You can also change the number of surround back speakers ([page 36](#) “Set up “Channel Select””).

1 Set up the remote control unit

Set up the operation mode
Press **AMP** to set the remote control unit to AMP-operation mode.

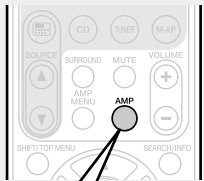

Press AMP

2 Connect the setup microphone.

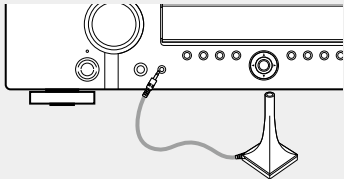

When the setup microphone is connected, the following screen is displayed.

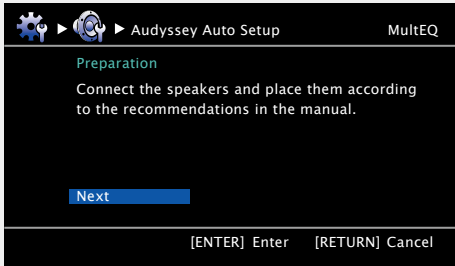

Next
[ENTER] Enter [RETURN] Cancel

3 Select “Next”, and then press ENTER.

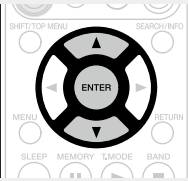

4 Set up “Pre Assign”

Use Δ / ∇ to select “Pre Assign”, and then press **ENTER**.

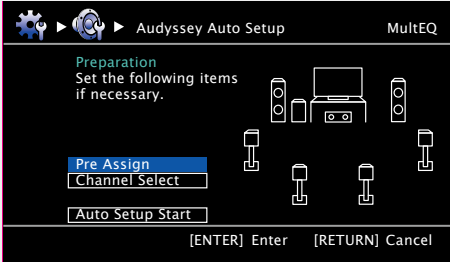

Pre Assign
Channel Select
Auto Setup Start
[ENTER] Enter [RETURN] Cancel



Pre Assign ◀ NORMAL ▶
[RETURN] Return

5 Use ◀ ▶ to select the configuration of the connected speakers.

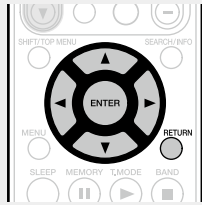

NORMAL Set for connecting the surround back speakers to the FL/SBL/HL and FR/SBR/HR connectors in PRE OUT.

F.HEIGHT Set for connecting the front height speakers to the FL/SBL/HL and FR/SBR/HR connectors in PRE OUT.

FRONT Set for connecting the front speakers to the FL/SBL/HL and FR/SBR/HR connectors in PRE OUT.

6 Press RETURN to exit the “Pre Assign” setting.

7 Set up “Channel Select”

Use ▲▼ to select “Channel Select”, and then press ENTER.

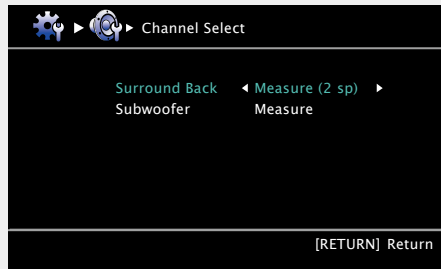
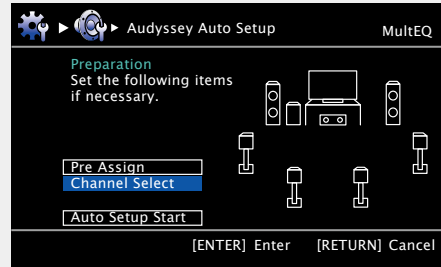

8 Use ▲▼ to select a channel.

Surround Back Select the number of surround back speakers to be used. In this case, go to step 9.
 • “Surround Back” can be set when “Pre Assign” is set to “NORMAL”.

Subwoofer Select for no subwoofer to be used. In this case, go to step 10.

9 Use ◀ ▶ to set whether or not a surround back channel is measured.

Measure (2 sp) Set for measuring two surround back speakers.

Measure (1 sp) Set for measuring a surround back speaker.

Skip Set for no measuring of a surround back speaker.

10 Use ◀ ▶ to set whether or not a subwoofer channel is measured.

Measure Set for measuring a subwoofer.

Skip Set for no measuring of a subwoofer.

11 Press RETURN. Proceed to [page 13](#) **STEP 1 Preparation** step 6.

NOTE

After performing Audyssey® Auto Setup, do not change the speaker connections or subwoofer volume. In event of a change, perform Audyssey® Auto Setup again.

Connections (Advanced connection)

Connecting the remote control connectors

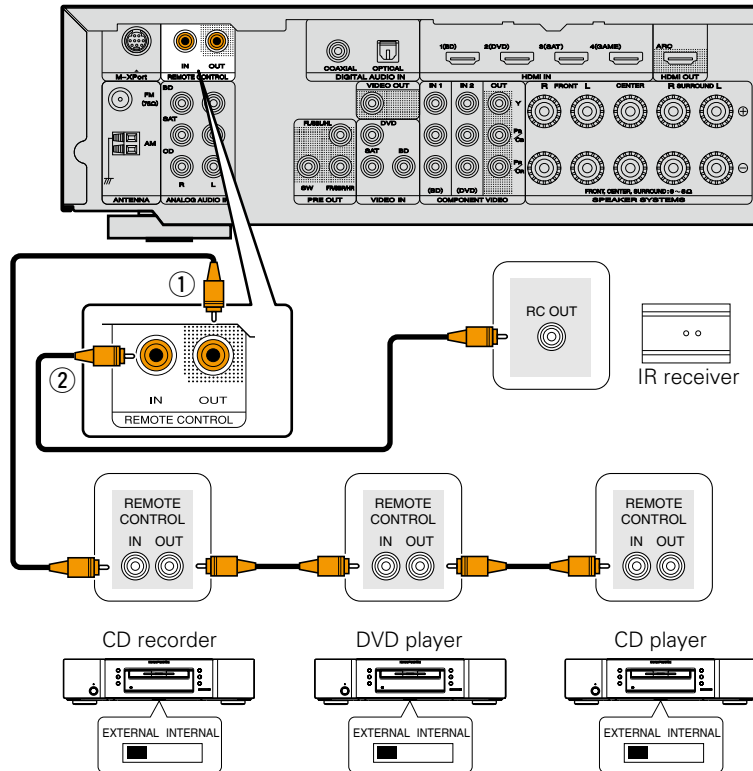

- ① You can control other marantz products through this unit with the remote control unit by connecting the REMOTE CONTROL connectors on each unit.
 - The signal transmitted from the remote control unit is received by the remote sensor on this unit. Then the signal is sent to the connected device through REMOTE CONTROL connector. Therefore you need to aim the remote control only at the this unit.
 - Set the remote control switch located on the rear panel of the connected audio component to "EXTERNAL" or "EXT." to use this feature.
 - If a marantz power amplifier (excluding certain models) is connected to any of these connectors, the power of the power amplifier switches to on/standby in conjunction with the **ON/STANDBY** button of the this unit.
- ② Whenever external infrared sensors or similar devices are connected to REMOTE CONTROL IN connector of the this unit, be sure to always disable operation of the infrared sensor on the this unit ([page 67](#) "Remote control settings").

NOTE

Be sure to set to "enable" when external infrared sensors or similar devices are not connected. Otherwise, the unit will be unable to receive remote control commands.

Playback (Advanced operation)

Settings (🔗 page 11)

Playback (Basic operation) (🔗 page 18)

Selecting a listening mode (Surround mode)
(🔗 page 24)

- ❑ HDMI control function (🔗 page 38)
- ❑ Sleep timer function (🔗 page 39)
- ❑ Adjusting the volume of the speakers
(🔗 page 40)
- ❑ Dual backup memory function (🔗 page 41)
- ❑ Panel lock function (🔗 page 41)
- ❑ Various memory functions (🔗 page 42)

Convenient functions

HDMI control function

If you connect the unit and an HDMI control function compatible TV or player with an HDMI cable and then enable the HDMI control function setting on each device, the devices will be able to control each other.

❑ Operations possible by HDMI control

- This unit power off can be linked to the TV power off step.
- You can switch audio output devices with a TV operation.
When you set "Output audio from amp" in the TV audio output setup operation, you can switch the amp power on.
- You can adjust this unit volume in the TV volume adjustment operation.
- You can switch this unit input sources through linkage to TV input switching.
- When playing the player, this unit input source switches to the source for that player.
- If you switch the input source of the unit to "TV", you can play TV audio with this unit (🔗 page 5 "About ARC (Audio Return Channel) function").
- When "HDMI Control" (🔗 page 58) in the menu is set to "ON", signals input to the HDMI input connector are output to the television or other device connected to the HDMI output connector, even if the power of this unit is in standby (pass-through function).



- To play the audio of a TV that does not support the ARC function with the unit, connect the TV with an optical digital connection.
- To use the pass-through function, connect an HDMI connection device that is compatible with HDMI control.

❑ Setting procedure

- 1** Set the HDMI output connector corresponding with the HDMI control function.
Set "HDMI Control" (🔗 page 58) to "ON".
- 2** Turn the power on for all the devices connected by HDMI cable.
- 3** Set the HDMI control function for all devices connected by HDMI cable.
 - Please consult the operating instructions for the connected devices to check the settings.
 - Carry out steps 2 and 3 should any of the devices be unplugged.
- 4** Switch the television input to the HDMI input connected to this unit.
- 5** Switch this unit input to the HDMI input source and check if the picture from the player is ok.
- 6** When you turn the TV's power to standby, check that the power of this unit also goes to standby.



If the HDMI control function does not operate properly, check the following points.

- Is the TV or player compatible with the HDMI control function?
- Is "HDMI Control" (🔗 page 58) set to "ON"?
- Is "P.Off Control" (🔗 page 58) set to "All" or "Video"?
- Are the HDMI control function settings of all devices correct?

NOTE

- When “HDMI Control” is set to “ON”, it consumes more standby power.
- The HDMI control function controls operations of a TV that is compatible with the HDMI control function. Make sure that the TV and HDMI are connected when you perform HDMI control.
- Some functions may not operate depending on the connected TV or player. Check the owner’s manual of each device for details beforehand.
- When “P.Off Control” on the menu is set to “OFF” ([page 58](#)), this unit is not set to standby even if the connected device is in the standby mode.
- When connection changes are implemented, such as adding connections to HDMI devices, linked operations may be initialized. In this case, you will need to reconfigure the settings.
- When “HDMI Control” is set to “ON”, it is not possible to assign an HDMI connector to “TV” at “Input Assign” ([page 64](#)).
- Should any of the operations below be performed, the interlocking function may be reset, in which case, repeat steps 2 and 3.
 - “Input Assign” – “HDMI” ([page 64](#)) setting has changed.
 - There is a change to the connection between the devices and the HDMI, or an increase in devices.

Sleep timer function

The power automatically goes into standby once the set time has elapsed.

This is convenient for playing sources while going to sleep.

Press SLEEP and display the time you want to set.

The “SLEEP” indicator on the display lights.

- The time switches as shown below each time **SLEEP** is pressed.

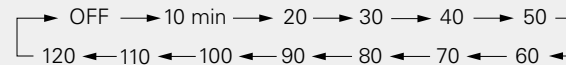
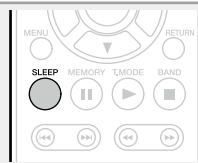
**To confirm the countdown time before putting the unit to sleep**

Press **SLEEP**.

“Sleep : *min” appears on the display.

* Countdown time

To cancel the sleep timer

Press **SLEEP** to set “OFF”.

The “SLEEP” indicator on the display turns off.



The sleep timer setting is canceled if this unit’s power is set to standby.

Adjusting the volume of the speakers

You can adjust the channel level either according to the playback sources or to suit your taste, as described below.

Adjusting the volume of the different speakers

1 Press **AMP** to set the remote control unit to AMP-operation mode.

2 Press **CH LEVEL**.

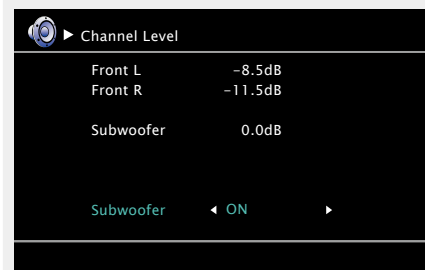

3 Use **Δ**/**∇** to select the speaker.

The speaker that can be set switches each time one of the buttons is pressed.

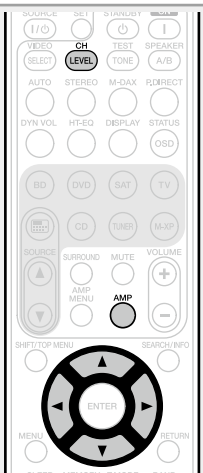

4 Use **◀**/**▶** to adjust the volume.

- You can directly turn "OFF" the subwoofer outputs during 2-channel playback in DIRECT or STEREO mode. Select "Subwoofer" and use **◀**/**▶** to select "ON" or "OFF".

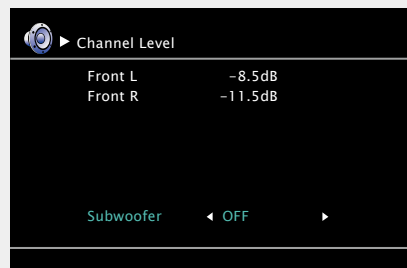

When a headphone jack is inserted, the headphone channel level can be adjusted.

Adjusting the volume of groups of speakers (Fader function)

This function lets you adjust (fade) the sound all at once from the front (front speaker / front height speaker / center speaker) or rear (surround speaker / surround back speaker).

1 Press **AMP** to set the remote control unit to AMP-operation mode.

2 Press **CH LEVEL**.

3 Press **∇** to select "Fader", then select the item to be adjusting using **◀**/**▶**.

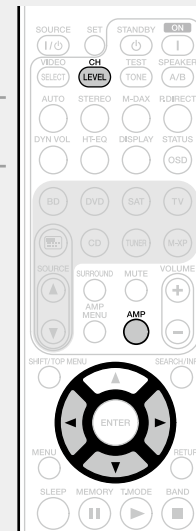
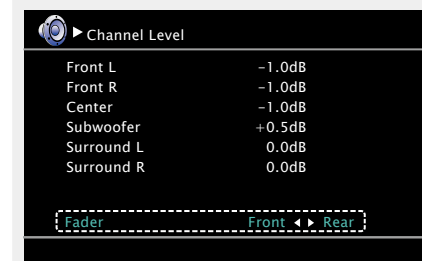

4 Use **◀**/**▶** to adjust the volume of the speakers. (◀ : front, ▶: rear)



- The fader function does not affect the subwoofer.
- The fader can be adjusted until the volume of the speaker is adjusted to the lowest value of -12 dB.

Dual backup memory function

The unit stores settings information in nonvolatile memory even when the main power supply is turned off. Using the Dual Backup Memory function, you can write settings information to another memory area to back up saved settings for recovery anytime as needed.

Remembering set details (Backup)

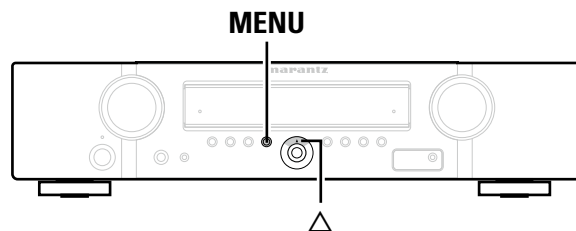

Set the unit in the state you want remembering, and press and hold **Δ** and **MENU** for at least 3 seconds. "MEMORY SAVING" is shown in the display, and the setting details are remembered.

NOTE

- The volume is not remembered.
- If remembered details are overwritten, the previously remembered contents are deleted.

Recalling remembered details (Recovery)

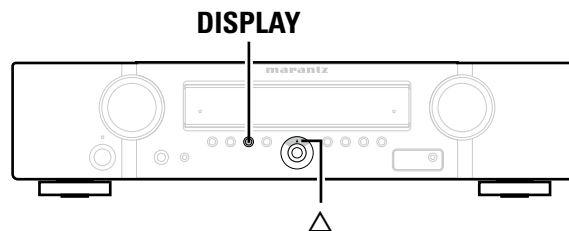

Press and hold **Δ** and **DISPLAY** together for at least 3 seconds. "MEMORY LOAD" is shown in the display, and the remembered details are recalled.

NOTE

- If there is no remembered data, "NO BACKUP" is shown in the display, and no remembered details are recalled.
- As the volume cannot be recalled, it returns to the factory setting volume.

Panel lock function

To prevent accidental operation of this unit, you can disable operation of the buttons on the front panel.

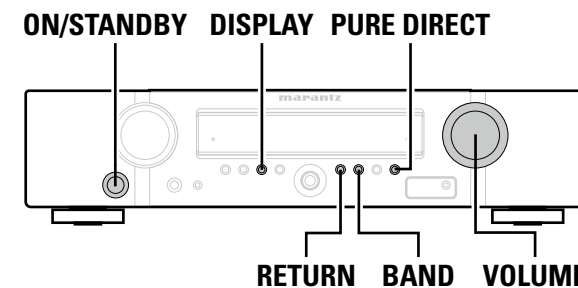

Disabling all key button operations

Press **ON/STANDBY** while you press and hold **PURE DIRECT** and **BAND** with the unit in standby mode. "Panel Lock:ON" appears on the display and all button operations except **ON/STANDBY** are disabled.

Disabling all button operations except VOLUME

Press **ON/STANDBY** while you press and hold **PURE DIRECT** and **DISPLAY** with the unit in standby mode. "Panel Lock:ON" appears on the display and all button operations except **ON/STANDBY** and **VOLUME** are disabled.

Canceling the Panel lock function

Press **ON/STANDBY** while you press and hold **PURE DIRECT** and **RETURN** with the unit in standby mode. The Panel lock function is canceled.



Even when the Panel lock function is set, you can operate the unit using the remote control unit.

Various memory functions

❑ Personal memory plus function

This function sets the settings (input mode, surround mode, HDMI output mode, MultEQ®, Dynamic EQ®, audio delay etc.) last selected for the individual input sources.



The surround parameters, tone settings and the volumes of the different speakers are stored for the individual surround modes.

❑ Last function memory



This function stores the settings which were made before going into the standby mode.

When the power is turned back on, the settings are restored.

How to make detailed settings

Menu map

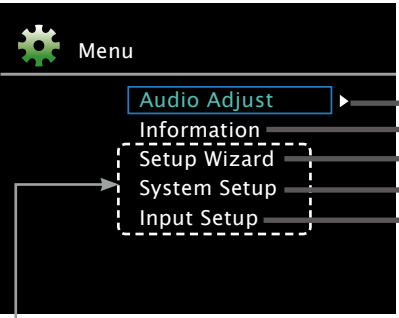
For menu operation, connect a TV to this unit and display the menu on the TV screen. For menu operations, see the following page.

Setting items	Detailed items	Description	Page
	Audio Adjust		
	Surr.Parameter	Adjusts surround sound parameters.	49
	Tone	Adjusts the tonal quality of the sound.	50
	Audyssey Settings	Makes Audyssey MultEQ®, Audyssey Dynamic EQ® and Audyssey Dynamic Volume® settings.	50
	Manual EQ	Uses the graphic equalizer to adjust the tone of each speaker.	52
Information	M-DAX	Expands the low and high frequency components of compressed audio to enable richer audio playback.	52
	Audio Delay	Compensates for incorrect timing between video and audio.	52
	Status	Shows information about current settings.	53
Setup Wizard	Audio Signal	Shows information about audio input signals.	53
	HDMI Information	Displays the HDMI input/output signals and HDMI monitor information.	53
System Setup		Perform the installation, connection, and setup procedures to prepare the unit for operation following guidance.	4
Input Setup 	Speaker Setup	Sets the speaker size and distance, the channel level, etc.	55
	HDMI Setup	Makes settings for HDMI video/audio output.	58
	Audio Setup	Makes settings for audio playback.	59
	Option Setup	Makes various other settings.	59
	Language	Sets the language for display the menu on the TV screen.	61
	Auto Preset	Uses the auto preset function to program radio stations.	63
	Preset Skip	Sets the preset memories that you do not want to display when tuning.	63
	Preset Name	Assigns name to a preset memory.	63
	Input Assign	Changes input connector assignment.	64
	Video	Makes the video settings.	65
Input Mode	Sets the audio input mode and decode mode.	66	
Rename	Changes the display name for this source.	66	
Source Level	Adjusts the playback level of the audio input.	66	

Items that only need to be set once

Set these for example upon purchase. Once these items are set, there is no need to set them again unless the speaker layout or the connected speakers have been changed.

Displayed items of the "Input Setup" menu differs, depending on the selected input source.

Examples of menu screen displays

Typical examples are described below.

[Example 1] Menu selection screen (Top menu)

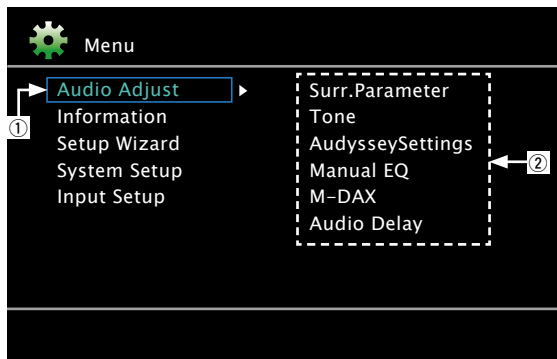

- ① Currently selected setup item
- ② List of currently selected setup subcategory

Press ▾ to select "System Setup" and then press ▷. (Or press ENTER.)

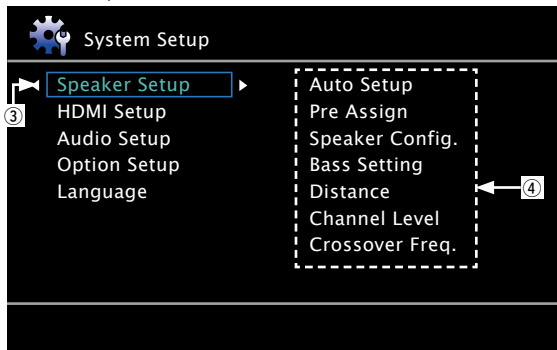

- ③ Selected setup item
- ④ Options of the selected setup item

[Example 2] Audyssey® Auto Setup screen (with illustration)

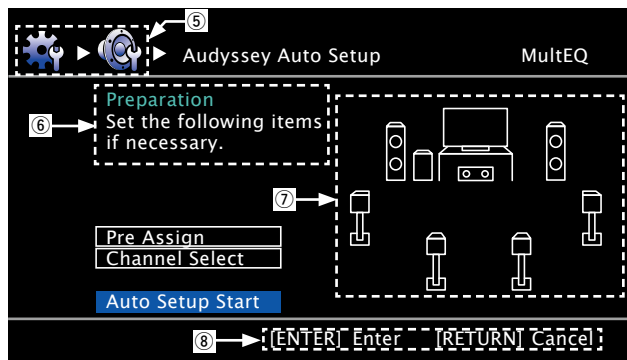

- ⑤ History icon
- ⑥ Operation guidance text
- ⑦ Illustration
- ⑧ Operation button guidance

List

Selected item

- Switch the selected item using △▽.

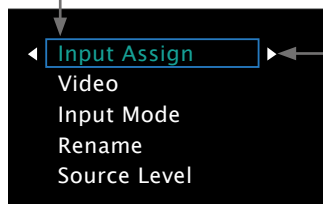

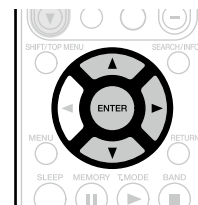

Proceed to the subcategory
(Use ▷ or ENTER to switch.)

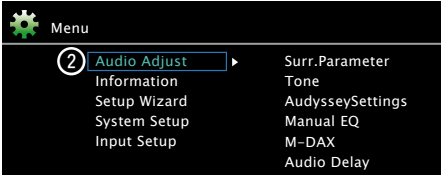
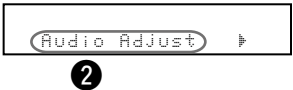
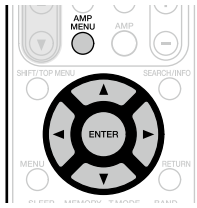
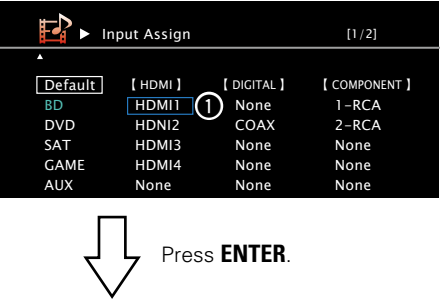
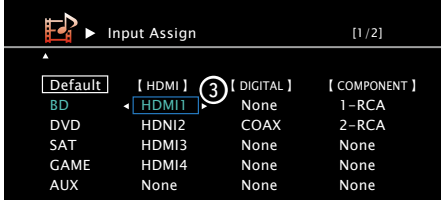

Examples of menu and front display

Below we describe typical examples of displays on the TV screen and on the set's display window.

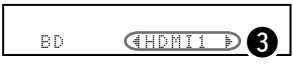
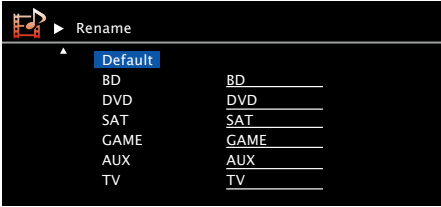
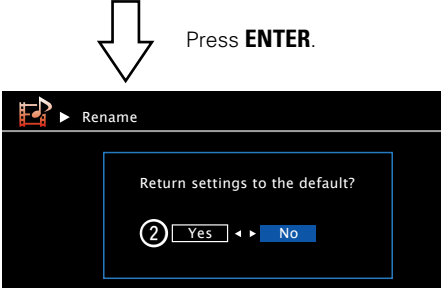
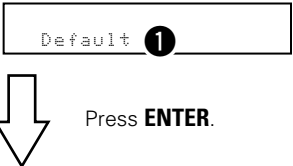
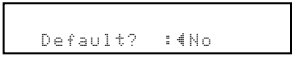
	Menu display	Front display	Description
Top menu display			<ol style="list-style-type: none"> 1 Press AMP MENU to display the menu screen. 2 TV screen: Displays the selected line. Display: Displays the selected item. • Use $\Delta \nabla$ to move to the item you want to set. 
Display when changing settings	 	 	<ol style="list-style-type: none"> 1 TV screen: Displays the selected line. Display: Displays the selected item. • Use $\Delta \nabla$ to move to the item you want to set. 2 Press ENTER to set to the mode in which the setting can be made. 3 $\blacktriangleleft \blacktriangleright$ is displayed at the sides of items whose setting can be changed. Use $\blacktriangleleft \blacktriangleright$ to change to the desired setting.
Display when resetting	 	 	<ol style="list-style-type: none"> 1 Press Δ to select "Default", then press ENTER. 2 Press \blacktriangleleft to select "Yes", then press ENTER.

Inputting characters

You can change the names as desired using the "Preset Name" (page 63) and "Rename" (page 66).

For inputting characters, there are two methods, as shown below.

Method for inputting characters

Method	Operations
Using the keyboard screen	<ul style="list-style-type: none"> Operating with the remote control unit. Select a character on the TV screen to input characters.
Using the cursor buttons (Cursor mode screen)	<ul style="list-style-type: none"> Operating with the remote control unit. Use $\Delta \nabla \triangleleft \triangleright$ and ENTER to input characters.

Keyboard screen

Display of a keyboard input screen

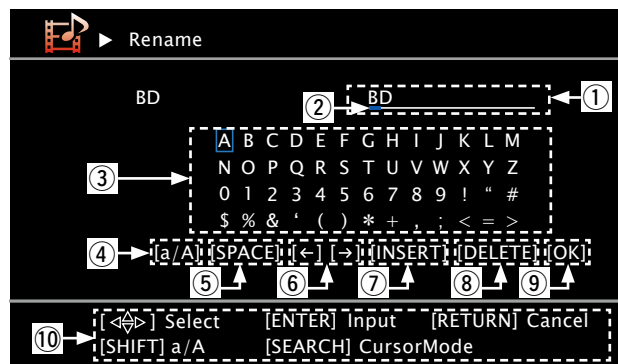

- ① Character input section (Maximum 8 characters)
- ② Cursor
- ③ Keyboard section
- ④ Uppercase and lowercase switch key
- ⑤ Space key
- ⑥ Cursor keys
- ⑦ Insert key
- ⑧ Delete key
- ⑨ OK key
- ⑩ Guide for operation buttons

Using the keyboard screen

1 Display the screen for inputting characters (page 43 "Menu map").

2 Select a character to be changed.
① Press $\Delta \nabla \triangleleft \triangleright$ to select [←] or [→].

② Press **ENTER** to place the cursor at the character to be changed.

Each time **ENTER** is pressed, the cursor moves by one character.

3 Select a character to be input with $\Delta \nabla \triangleleft \triangleright$ then press **ENTER**.

- The types of characters that can be input are as shown below.

[Upper case characters/Numbers/Symbols]
 ABCDEFGHIJKLMNOPQRSTUVWXYZ
 0123456789
 ! " # \$ % & ' () * + , ; < = >
[Lower case characters/Numbers/Symbols]
 abcdefghijklmnopqrstuvwxyz
 0123456789
 . @ - _ / : ~ ? [\] ^ ` { | }

- When you press **SHIFT/TOP MENU** while you type in, you can change uppercase characters to lowercase and vice versa.

4 Repeat steps 2 and 3 to change the name.

5 Use $\Delta \nabla \triangleleft \triangleright$ to select [OK], then press **ENTER**.

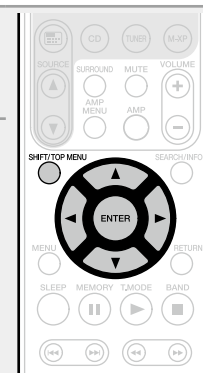

Cursor mode screen

Display of a cursor mode screen

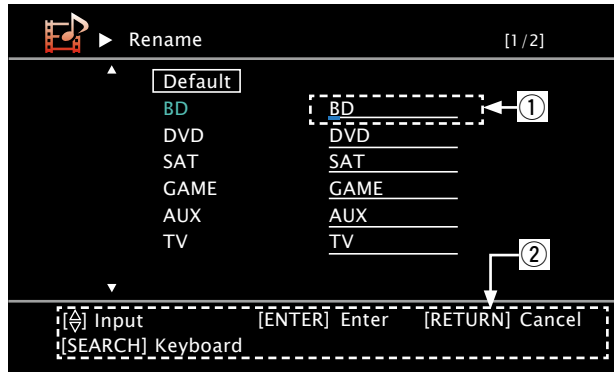

- ① Character input section (Maximum 8 characters)
- ② Guide for operation buttons

Using the cursor buttons

- 1** Display the screen for inputting characters (page 43 “Menu map”).
- 2** Press **SEARCH/INFO** while a keyboard screen is displayed.
A cursor mode screen is displayed.
- 3** Use **< >** to set the cursor to the character you want to change.
- 4** Use **△ ▽** to change the character, then press **ENTER**.
 - The types of characters that can be input are as shown below.

[Upper case characters]
 ABCDEFGHIJKLMNOPQRSTUVWXYZ
[Lower case characters]
 abcdefghijklmnopqrstuvwxyz
[Symbols] ! " # \$ % & ' () * + , - . / : ; <
 = > ? @ [\] ^ _ ` { | } ~
[Numbers] 0 1 2 3 4 5 6 7 8 9 (Space)

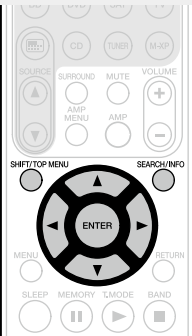
 - When you press **SHIFT/TOP MENU** while you type in, you can change uppercase characters to lowercase and vice versa.
- 5** Repeat steps 3 and 4 to change the name then press **ENTER** to register it.



The sound being played in the surround mode can be adjusted to your liking. The items (parameters) that can be adjusted depend on the signal being input and the currently set surround mode. For details on the adjustable parameters, see “Surround modes and surround parameters” ([page 80](#)).

NOTE

Some setting items cannot be set while playback is stopped. Make the settings during playback.

Menu operation

1 Press **AMP MENU** to set the remote control unit to **AMP-operation mode**.

The menu is displayed on the TV screen.

2 Use Δ / ∇ to select the menu to be set or operated.

3 Press **ENTER** or \blacktriangleright to enter the setting.

- To return to the previous item, press **RETURN**.
- Exiting the Menu, press **AMP MENU** while the menu is displayed. The menu display disappears.

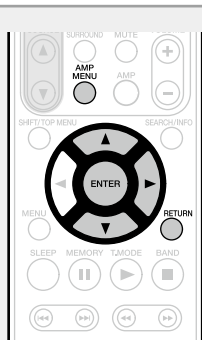

Items that can be set with the “Audio Adjust” procedure

Surr.Parameter ([page 49](#))

Tone ([page 50](#))

Audyssey Settings ([page 50](#))

Manual EQ ([page 52](#))



M-DAX ([page 52](#))

Audio Delay ([page 52](#))

Surr.Parameter

Default settings are underlined.

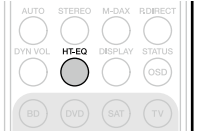

Adjust surround sound parameters. It may not be possible to set this item depending on the input signal (refer to [page 80](#) "Surround modes and surround parameters").

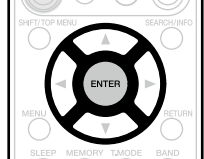
Setting items	Setting details
HT-EQ Soften the treble range of movie soundtracks for better understanding.	ON : "HT-EQ" is used. OFF : "HT-EQ" is not used.  This can also be set by pressing HT-EQ . 
DRC Compress dynamic range (difference between loud and soft sounds).	Auto : Automatic dynamic range compression on/off control according to source. This can be set in the Dolby TrueHD mode. Low / Middle / High : These set the compression level. OFF : Dynamic range compression always off.
D.Comp Compress dynamic range (difference between loud and soft sounds).	OFF : Turn dynamic range compression off. Low / Middle / High : These set the compression level.
LFE Adjust the low-frequency effects level (LFE).	-10dB - 0dB  For proper playback of the different sources, we recommend setting to the values below. <ul style="list-style-type: none"> • Dolby Digital sources : "0dB" • DTS movie sources : "0dB" • DTS music sources : "-10dB"
C.Image Assign center channel signal to front left and right channels for wider sound.	0.0 - 1.0 (0.3)
Panorama Assign front L/R signal also to surround channels for wider sound.	ON : Set. OFF : Do not set.
Dimension Shift sound image center to front or rear to adjust playback balance.	0 - 6 (3)

Setting items	Setting details
C.Width Assign center channel signal to front left and right channels for wider sound.	0 - 7 (3)
Height Gain Control the front height channel volume.	Low : Reduce the front height channel volume. Middle : Front height channel sound is output with standard sound volume. High : Increase the front height channel volume. <div style="background-color: #e91e63; color: white; padding: 5px; text-align: center; font-weight: bold; margin-top: 10px;">NOTE</div> "Height Gain" is displayed for the following settings. <ul style="list-style-type: none"> • When "Pre Assign" (page 55) is set to "F.HEIGHT". • When the "Speaker Config." - "F.Height" setting (page 56) is set other than to "None". • When surround mode is "PLIIZ" or the PLIIZ decoder is used.
Default The "Surr.Parameter" settings are returned to the default settings.	Yes : Reset to the defaults. No : Do not reset to the defaults.  When you select "Default" and press ENTER , the "Return settings to the default?" prompt is displayed. Select either "Yes" or "No", and press ENTER . 

Tone

Adjust the tonal quality of the sound.

Setting items	Setting details
Tone Control Set the tone control function to ON and OFF.	ON : Allow tone adjustment (bass, treble). OFF : Playback without tone adjustment.  "Tone Control" can be set when "Dynamic EQ®" (page 51) is set to "OFF". <div style="background-color: #f08080; color: white; padding: 2px; display: inline-block; margin-top: 5px;">NOTE</div> The tone cannot be adjusted in the "DIRECT" mode.
Bass Adjust low frequency range (bass).	-6dB - +6dB  "Bass" can be set when "Tone Control" is set to "ON".
Treble Adjust high frequency range (treble).	-6dB - +6dB  "Treble" can be set when "Tone Control" is set to "ON".



Audyssey Settings

Default settings are underlined.

Set Audyssey MultEQ®, Audyssey Dynamic EQ® and Audyssey Dynamic Volume®. These can be selected after Audyssey® Auto Setup has been performed. For additional information on Audyssey technology, please see [page 85](#).





NOTE



- If you have not performed Auto Setup, or if you change the speaker settings after performing Auto Setup, you may not be able to select Dynamic EQ®/Dynamic Volume®. In this case, either perform Audyssey® Auto Setup over again or perform "Restore" ([page 17](#)) to return to the settings after Audyssey® Auto Setup was run.
- When HD Audio for which the sampling frequency exceeds 96 kHz is played back, the "Audyssey Settings" cannot be set.

Setting items	Setting details
MultEQ® MultEQ® corrects both time and frequency response problems in the listening area based on Audyssey® Auto Setup calibration. We recommend "Audyssey". MultEQ® is the prerequisite function for Dynamic EQ® and Dynamic Volume®.	Audyssey : Optimize the frequency response of all speakers. Audyssey Byp.L/R : Optimize frequency response of speakers except front L and R speakers. Audyssey Flat : Optimize frequency response of all speakers to flat response. Manual : Apply frequency response set with "Manual EQ" (page 52). OFF : Turn "MultEQ®" equalizer off.  <ul style="list-style-type: none"> • "Audyssey", "Audyssey Byp. L/R" and "Audyssey Flat" can be selected after Audyssey® Auto Setup has been performed. "Audyssey" is automatically selected after performing Audyssey® Auto Setup. When "Audyssey", "Audyssey Byp. L/R" or "Audyssey Flat" is selected,  illuminates. • After running Audyssey® Auto Setup, if the Speaker Configuration, Distance, Channel Level, and Crossover Frequency have changed without increasing the number of speakers measured, only  illuminates. <div style="background-color: #f08080; color: white; padding: 2px; display: inline-block; margin-top: 5px;">NOTE</div> <ul style="list-style-type: none"> • "MultEQ®" and "Manual" cannot be selected when "EQ Customize" is set to "Not Used" (page 59). • When using headphones, "MultEQ®" is automatically set to "OFF".



"MultEQ®", "Dynamic EQ®" and "Dynamic Volume®" settings are stored for each input source.

Setting items	Setting details
<p>Dynamic EQ® Solve the problem of deteriorating sound quality as volume is decreased by taking into account human perception and room acoustics. Works with MultEQ®.</p>	<p>ON : Use Dynamic EQ®. OFF : Do not use Dynamic EQ®.</p> <p>  or  is displayed when set to "ON".</p>
<p>Reference Offset Audyssey Dynamic EQ® is referenced to the standard film mix level. It makes adjustments to maintain the reference response and surround envelopment when the volume is turned down from 0 dB. However, film reference level is not always used in music or other non-film content. Dynamic EQ® Reference Level Offset provides three offsets from the film level reference (5 dB, 10 dB, and 15 dB) that can be selected when the mix level of the content is not within the standard.</p>	<p>0dB (Film Ref) : This is the default setting and should be used when listening to movies. 5dB : Select this setting for content that has a very wide dynamic range, such as classical music. 10dB : Select this setting for jazz or other music that has a wider dynamic range. This setting should also be selected for TV content as that is usually mixed at 10 dB below film reference. 15dB : Select this setting for pop/rock music or other program material that is mixed at very high listening levels and has a compressed dynamic range.</p> <p> Setting is enabled when "Dynamic EQ®" is "ON" (page 51).</p>

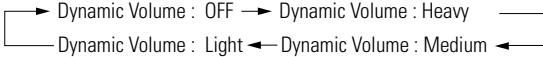

Setting items	Setting details
<p>Dynamic Volume® Solve the problem of large variations in volume level between TV, movies and other content (between quiet passages and loud passages, etc.) by automatically adjusting to the user's preferred volume setting.</p>	<p>Heavy : Most adjustment to loudest and softest sounds. Medium : Medium adjustment to loudest and softest sound. Light : Least adjustment to loudest and softest sounds. OFF : Do not use "Dynamic Volume®".</p> <p>  is displayed when set to "Heavy", "Medium" or "Light".</p> <ul style="list-style-type: none"> If "Dynamic Volume®" is set to "Yes" in Auto Setup (page 15), the setting is automatically changed to "Medium". This can also be set by pressing DYN VOL. <p>Each time DYN VOL is pressed, the setting is changed as shown below.</p> <p style="text-align: center;">  </p>



Manual EQ

Default settings are underlined.

Use the graphic equalizer to adjust the tone of each speaker.
 "Manual EQ" can be set when "MultEQ®" setting ([page 50](#)) is "Manual".

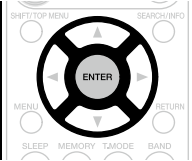
Setting items	Setting details
Adjust Channel Correct the tone of each speaker.	① Select the speaker tone adjustment method. All : Adjust the tone of all speakers together. L/R : Adjust the tone of left and right speakers together. Each : Adjust the tone of each speaker. ② Select the speaker. ③ Select the adjustment frequency band. 63Hz / 125Hz / 250Hz / 500Hz / 1kHz / 2kHz / 4kHz / 8kHz / 16kHz • Select the speakers you want to adjust when "L/R" or "Each" is selected. ④ Adjust the level. -20.0dB – +6.0dB (0.0dB)
Curve Copy Copy "Audyssey Flat" curve from MultEQ®.	Yes : Copy. No : Do not copy.  <ul style="list-style-type: none"> "Curve Copy" is displayed after Audyssey® Auto Setup has been performed. When you select "Curve Copy" and press ENTER, the "Set EQ curve to Audyssey Flat?" prompt is displayed. Select either "Yes" or "No", and press ENTER.
Default The "Manual EQ" settings are returned to the default settings.	Yes : Reset to the defaults. No : Do not reset to the defaults.  When you select "Default" and press ENTER , the "Return settings to the default?" prompt is displayed. Select either "Yes" or "No", and press ENTER . 

M-DAX

Default settings are underlined.

Compressed audio formats such as MP3, WMA (Windows Media Audio) and MPEG-4 AAC reduce the amount of data by eliminating signal components that are hard for the human ear to hear. The M-DAX function generates the signals eliminated upon compression, restoring the sound to conditions near those of the original sound before compression. It also corrects the sense of volume of the bass to obtain richer sound with compressed audio signals.

Setting details

- OFF** : Do not use M-DAX.
- Low** : Optimized mode for compressed sources with normal highs.
- Mid** : Apply suitable bass and treble boost for all compressed sources.
- High** : Optimized mode for compressed sources with very weak highs.



- This item can be set with analog signals or PCM signal (fs = 44.1/48 kHz) is input.
- "M-DAX" settings are stored for each input source.
- When set to "OFF", the M-DAX indicator on the front panel switches off.
- This cannot be set when the surround mode is set to "DIRECT".
- This can also be set by pressing **M-DAX**.

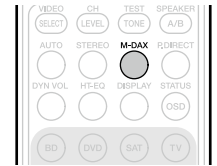

Audio Delay

Default settings are underlined.

While viewing video, manually adjust the time to delay audio output.

Setting details

0ms – 200ms



- This item can be set within the range of 0 to 100 ms when "Auto Lip Sync" ([page 58](#)) is set to "ON" and when a TV compatible with Auto Lip Sync is connected.
- Store "Audio Delay" for each input source.
- Audio Delay for game mode can be set when "Video Mode" ([page 65](#)) is set to "Auto" or "Game".



Show information about receiver settings, input signals, etc.

Items	Setting details
Status Show information about current settings.	The information displayed differs according to the input source. Select Source / Name / Surround Mode / Input Mode / Decode Mode / Assign / Video Select / Video Mode / Content Type etc.
Audio Signal Show information about audio input signals.	Surround Mode : The currently set surround mode. Signal : The input signal type. fs : The input signal's sampling frequency. Format : The number of channels in the input signal (front, surround, LFE). Offset : The dialogue normalization correction value. Flag : This is displayed when inputting signals including a surround back channel. "MATRIX" is displayed with Dolby Digital EX and DTS-ES Matrix signals, "DISCRETE" with DTS-ES Discrete signals. <div style="border: 1px solid black; padding: 5px; text-align: center;"> <p>Dialogue normalization function</p> <p>This function is automatically activated when playing Dolby Digital sources. It automatically corrects the standard signal level for individual program sources. The correction value can be checked using the STATUS on the main unit.</p> <div style="border: 1px solid black; padding: 2px; display: inline-block; margin: 5px auto;"> Offset - 4dB </div> <p>The figure is the corrected value. This cannot be changed.</p> </div>
HDMI Information Show information about HDMI input/output signals and monitor.	Signal Info. <ul style="list-style-type: none"> • Resolution / Color Space / Pixel Depth Monitor Info. <ul style="list-style-type: none"> • Interface / Support Resolution



Even if **STATUS OSD** is pressed, the Information screen (Status, Audio Signal, HDMI Information) can be displayed.

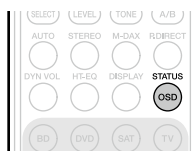



Set when changing Audyssey® Auto Setup settings, or when changing the audio, video, display or other settings.

- If you change the speaker settings after performing Audyssey® Auto Setup, it will not be possible to set Audyssey MultEQ®, Audyssey Dynamic EQ® and Audyssey Dynamic Volume® (page 50, 51).
- Can be used without changing the settings. Please set if necessary.

Menu operation

1 Press **AMP MENU** to set the remote control unit to **AMP-operation mode**.

The menu is displayed on the TV screen.

2 Press Δ / ∇ to select the menu to be set or operated.

3 Press **ENTER** or \triangleright to enter the setting.

- To return to the previous item, press **RETURN**.
- Exiting the Menu, press **AMP MENU** while the menu is displayed. The menu display disappears.

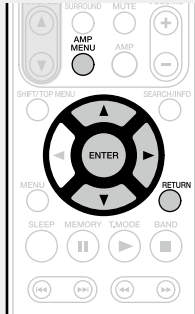

Items that can be set with the "System Setup" procedure

Speaker Setup (page 55)

HDMI Setup (page 58)

Audio Setup (page 59)

Option Setup (page 59)

Language (page 61)



Speaker Setup

Default settings are underlined.



Perform when setting the speakers manually or when changing settings made in Audyssey® Auto Setup.

- If you change the speaker settings after performing Audyssey® Auto Setup, it will not be possible to select Audyssey MultEQ®, Audyssey Dynamic EQ® and Audyssey Dynamic Volume® ([page 50, 51](#)).
- "System Setup" can be used without changing the settings. Please set if necessary.

Setting items	Setting details
<p>Pre Assign The signal output from the FL/SBL/HL and FR/SBR/HR connectors on PRE OUT of the amplifier can be switched in accordance with the speaker environment.</p>	<p>NORMAL : Set for connecting the surround back speakers to the FL/SBL/HL and FR/SBR/HR connectors in PRE OUT. F.HEIGHT : Set for connecting the front height speakers to the FL/SBL/HL and FR/SBR/HR connectors in PRE OUT. FRONT : Set for connecting the front speakers to the FL/SBL/HL and FR/SBR/HR connectors in PRE OUT.</p> <p> A power amplifier (sold separately) is required for this connection.</p>
<p>Speaker Config. Select speaker configuration and size (bass reproduction capability).</p> <p>NOTE Do not use the outward shape of the speaker to determine selection of a "Large" or "Small" speaker. Instead, use the frequencies set in "Crossover Freq." (page 57) as the standard for determining bass reproduction capability.</p>	<p>Front : Set the front speaker size.</p> <ul style="list-style-type: none"> • Large : Use a large speaker that can adequately play back low frequencies. • Small : Use a small speaker that has inadequate playback capacity for low frequencies. <p></p> <ul style="list-style-type: none"> • When "Subwoofer" is set to "No", "Front" is automatically set to "Large". • When "Front" is set to "Small", "Center", "Surround", "S.Back" and "F.Height" can not be set to "Large". <p>Center : Set the presence and size of the center speaker.</p> <ul style="list-style-type: none"> • Large : Use a large speaker that can adequately play back low frequencies. • Small : Use a small speaker that has inadequate playback capacity for low frequencies. • None : Select when a center speaker is not connected. <p> "Large" is not displayed when "Front" is set to "Small".</p>

Setting items	Setting details
<p>Speaker Config. (Continued)</p>	<p>Subwoofer : Set the presence of a subwoofer.</p> <ul style="list-style-type: none"> • Yes : Use a subwoofer. • No : Select when a subwoofer is not connected. <p> When "Front" is set to "Small", "Subwoofer" is automatically set to "Yes".</p> <p>Surround : Set the presence and size of the surround speakers.</p> <ul style="list-style-type: none"> • Large : Use a large speaker that can adequately play back low frequencies. • Small : Use a small speaker that has inadequate playback capacity for low frequencies. • None : Select when the surround speakers are not connected. <p></p> <ul style="list-style-type: none"> • When "Surround" is set to "Large", "S.Back" and "F.Height" can be set to "Large". • When "Surround" is set to "None", "S.Back" and "F.Height" are automatically set to "None". <p>S.Back : Set the presence, size and number of surround back speakers.</p> <ul style="list-style-type: none"> • Large : Use a large speaker that can adequately play back low frequencies. • Small : Use a small speaker that has inadequate playback capacity for low frequencies. • None : Select when the surround back speakers are not connected. <ul style="list-style-type: none"> • 2spkr : Use two surround back speakers. • 1spkr : Use only one surround back speaker. When you select this setting, connect the surround back speaker to the left (L) channel. <p> Even when the "S.Back" setting is other than "None", sound may not be emitted from the surround back speaker, depending on the playback source.</p> <p>NOTE When "Pre Assign" setting (page 55) is "NORMAL", you can make the "S.Back" setting.</p>

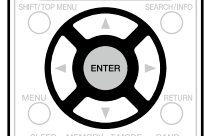
Setting items	Setting details
Speaker Config. (Continued)	<p>F.Height : Set the presence and size of the front height speakers.</p> <ul style="list-style-type: none"> • Large : Use a large speaker that can adequately play back low frequencies. • Small : Use a small speaker that has inadequate playback capacity for low frequencies. • None : Select when the front height speakers are not connected. <p>NOTE</p> <p>When “Pre Assign” setting (page 55) is “F.HEIGHT”, you can make the “F.Height” setting.</p>
Bass Setting Set subwoofer and LFE signal range playback.	<p>Subwoofer Mode : Select low range signals to be reproduced by subwoofer.</p> <ul style="list-style-type: none"> • LFE : The low range signal of the channel set to “Small” speaker size is added to the LFE signal output from the subwoofer. • LFE+Main : The low range signal of all channels is added to the LFE signal output from the subwoofer. <p></p> <ul style="list-style-type: none"> • “Subwoofer Mode” can be set when “Speaker Config.” – “Subwoofer” (page 55) is set to “Yes”. • Play music or a movie source and select the mode offering the strongest bass. • Select “LFE+Main” if you want the bass signals to always be produced from the subwoofer. <p>NOTE</p> <p>If “Front” and “Center” for “Speaker Config.” are set to “Large”, and “Subwoofer Mode” is set to “LFE”, no sound may be output from the subwoofers, depending on the input signal or selected surround mode.</p> <p>LPF for LFE : Set LFE signal playback range. Set this when you want to change the playback frequency of the subwoofer.</p> <ul style="list-style-type: none"> • 80Hz / 90Hz / 100Hz / 110Hz / 120Hz / 150Hz / 200Hz / 250Hz

Setting items	Setting details
Distance Set distance from listening position to speakers. Measure beforehand the distance from the listening position to each speaker.	<p>Unit : Set the unit of distance.</p> <ul style="list-style-type: none"> • Meters / Feet <p>Step : Set the minimum variable width of the distance.</p> <ul style="list-style-type: none"> • 0.1m / 0.01m • 1ft / 0.1ft <p>Default : The “Distance” settings are returned to the default settings.</p> <ul style="list-style-type: none"> • Yes : Reset to the defaults. • No : Do not reset to the defaults. <p> When you select “Default” and press ENTER, the “Return settings to the default?” prompt is displayed. Select either “Yes” or “No”, and press ENTER.</p>  <p>Front L / Front R / Center / Subwoofer / Surround L / Surround R / S.Back L* / S.Back R* / F.Height L / F.Height R : Select the speaker.</p> <p>* When the “Speaker Config.” – “S.Back” setting (page 55) is set to “1spkr”, “S.Back” is displayed.</p> <ul style="list-style-type: none"> • 0.00m – 18.00m / 0.0ft – 60.0ft : Set the distance. <p></p> <ul style="list-style-type: none"> • The speakers that can be selected differ depending on the “Pre Assign” (page 55) and “Speaker Config.” (page 55) settings. • Default settings : Front L / Front R / Center / Subwoofer / F.Height L / F.Height R : 3.60 m (12.0 ft) Surround L / Surround R / S.Back L / S.Back R : 3.00 m (10.0 ft) • Set the difference in the distance between the speakers to less than 6.00 m (20.0 ft). <p>NOTE</p> <p>Speakers set to “None” in “Speaker Config.” (page 55) are not displayed.</p>

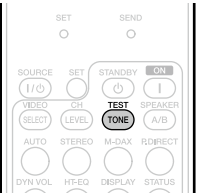
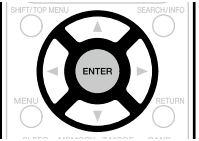

Setting items	Setting details
<p>Channel Level Set the volume of the test tone to be the same when it is output from each speaker.</p>	<p>Test Tone Start : Output test tone.</p> <ul style="list-style-type: none"> • Front L / F.Height L / Center / F.Height R / Front R / Surround R / S.Back R* / S.Back L* / Surround L / Subwoofer : Select the speaker. * When the "Speaker Config." – "S.Back" setting (page 55) is set to "1spkr", "S.Back" is displayed. • -12.0dB – +12.0dB (0.0dB) : Adjust the volume.  <ul style="list-style-type: none"> • When "Channel Level" is adjusted, the adjusted values are set for all the surround modes. To adjust the channel level separately for the different surround modes, use the operation see page 40. • When you press TEST TONE, you can enter this setting item immediately. <p>NOTE</p> <ul style="list-style-type: none"> • Speakers set to "None" in the "Speaker Config." (page 55) settings are not displayed. • When a headphones jack is inserted in the PHONES jack of this unit, the "Channel Level" is not displayed. <p>Default : The "Channel Level" settings are returned to the default settings.</p> <ul style="list-style-type: none"> • Yes : Reset to the defaults. • No : Do not reset to the defaults.  <ul style="list-style-type: none"> • When you select "Default" and press ENTER, the "Return settings to the default?" prompt is displayed. Select either "Yes" or "No", and press ENTER.



Setting items	Setting details
<p>Crossover Freq. Set the maximum frequency of the bass signal output from each channel to the subwoofer. Set the Crossover Frequency to suit the bass reproduction capability of the speaker being used.</p>	<p>Crossover : Set the crossover frequency.</p> <ul style="list-style-type: none"> • 40Hz / 60Hz / 80Hz / 90Hz / 100Hz / 110Hz / 120Hz / 150Hz / 200Hz / 250Hz <p>Advanced : Specify crossover frequency for each speaker.</p> <ul style="list-style-type: none"> • Front / Center / Surround / S.Back / F.Height : Select the speaker. • 40Hz / 60Hz / 80Hz / 90Hz / 100Hz / 110Hz / 120Hz / 150Hz / 200Hz / 250Hz : Set the crossover frequency.  <ul style="list-style-type: none"> • "Crossover Freq." can be set when the "Bass Setting" – "Subwoofer Mode" (page 56) setting is "LFE+Main", or when you have a speaker that is set to "Small". • Always set the crossover frequency to "80Hz". When using small speakers, however, we recommend setting the crossover frequency to a higher frequency. • For speakers set to "Small", sound below the crossover frequency is cut from the sound output. The cut bass sound is output from the subwoofer or front speakers. • The speakers that can be set when "Advanced" is selected differ depending on to the "Subwoofer Mode" setting (page 56). <ul style="list-style-type: none"> • When "LFE" is selected, speakers set to "Small" at "Speaker Config." can be set. If the speakers are set to "Large", "Full Band" is displayed and the setting cannot be made. • If set to "LFE+Main", this setting can be made regardless of the speaker size.

HDMI Setup

Default settings are underlined.

Make settings for HDMI video/audio output.

Setting items	Setting details
Auto Lip Sync Make automatic compensation for timing shift in audio and video output.	ON : Compensated. OFF : Not compensated.
HDMI Audio Out Select HDMI audio output device.	AMP : Play back through speakers connected to the unit. TV : Play back through TV connected to the unit.  <ul style="list-style-type: none"> The audio signal input from the HDMI input connector can be output as an output signal from the HDMI output connector by setting the HDMI audio output destination to TV. Audio signals input via the Analog/Coaxial/Optical input connectors cannot be output from the HDMI output connector. When the HDMI control function is activated, priority is given to the TV audio setting (page 38 "HDMI control function").
HDMI Control You can link operations with devices connected to HDMI and compatible with HDMI Control.	ON : Use HDMI control function. OFF : Do not use HDMI control function.  <ul style="list-style-type: none"> When a device that is not compatible with the HDMI control function is connected, set "HDMI Control" to "OFF". Please consult the operating instructions for each connected device to check the settings. Refer to "HDMI control function" (page 38) for more information about the HDMI control function. <p>NOTE</p> <ul style="list-style-type: none"> When "HDMI Control" is set to "ON", it consumes more standby power. If you are not using this unit for an extended period, it is recommended that you unplug the power cord from the power outlet. "HDMI Control" does not work when the power to the device is off. Either turn power on or set to standby. The HDMI control function controls operations of a TV that is compatible with the HDMI control function. Make sure that the TV and HDMI are connected when you perform HDMI control. If the "HDMI Control" settings have been changed, always reset the power to connected devices after the change.

Setting items	Setting details
Standby Source Sets the HDMI input source to put into standby when the power is on.	Last : This item is set at the last-used input source. HDMI1 / HDMI2 / HDMI3 / HDMI4 : Put the respective input source into standby.  "Standby Source" can be set when "HDMI Control" is set to "ON".
P.Off Control Links the power standby of this unit to external devices.	All : If power to a connected TV is turned off independently of the input source, power to this unit is automatically set to standby. Video : If power to a connected TV is turned off when the input source is BD / DVD / TV / SAT / GAME / AUX, power to this unit is automatically set to standby. OFF : This unit does not link with power to a TV.  "P.Off Control" can be set when "HDMI Control" is set to "ON".



Audio Setup

Default settings are underlined>.

Make settings for audio playback.

Setting items	Setting details
EQ Customize Set the disengaged equalizers to not display when MultEQ® XT is selected.	Manual : Set when not using the “Manual” equalizer. • Used : Use. • Not Used : Do not use. <hr/> Audyssey Flat : Set when not using “Audyssey Flat” equalizer. • Used : Use. • Not Used : Do not use. <hr/> Set so that “Audyssey Flat” settings can be made when Audyssey® Auto Setup is performed.
	Audyssey Byp. L/R : Set when not using “Audyssey Byp. L/R” equalizer. • Used : Use. • Not Used : Do not use. <hr/> Set so that “Audyssey Byp. L/R” settings can be made when Audyssey® Auto Setup is performed.







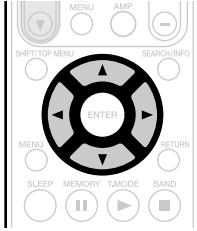

Option Setup

Default settings are underlined>.

Make various other settings.

Setting items	Setting details
Volume Control Set the volume setting.	Volume Display : Set how volume is displayed. • Relative : Display $-dB$ (Min), in the range -80.5 dB to 18 dB. • Absolute : Display in the range 0 (Min) to 99. <hr/> The “Volume Display” setting is applied also to the “Volume Limit” and “Power On Level” display method.
	Volume Limit : Make a setting for maximum volume. • OFF : Do not set a maximum volume. • -20dB (61) / -10dB (71) / 0dB (81)
	Power On Level : Define the volume setting that is active when the power is turned on. • Last : Use the memorized setting from the last session. • --- (0) : Always use the muting on condition when power is turned on. • -80dB - 18dB (1 - 99) : The volume is adjusted to the set level.
	Mute Level : Set the amount of attenuation when muting is on. • Full : The sound is muted entirely. • -40dB : The sound is attenuated by 40 dB down. • -20dB : The sound is attenuated by 20 dB down.
Source Delete Remove from the display input sources that are not used.	BD / DVD / SAT / GAME / AUX / TV / CD / TUNER / M-XPort : Select input source that is not used. • ON : Use this source. • Delete : Do not use this source.
	<div style="border: 1px solid black; padding: 5px; margin-bottom: 10px;"> <p style="text-align: center; background-color: #f08080; display: inline-block; border-radius: 5px; padding: 2px 5px;">NOTE</p> </div> Input sources set to “Delete” cannot be selected using the input source select button.

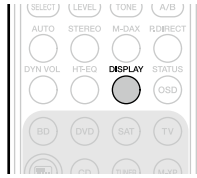
Setting items	Setting details
GUI Make the settings related to displays on the TV screen.	<p>Screensaver : Make screensaver settings.</p> <ul style="list-style-type: none"> • ON : The screensaver is activated during menu display, Tuner screen display if no operation is performed for an approximately 5-minute continuous period. When you press $\Delta \nabla \triangleleft \triangleright$, the screensaver is cancelled and the screen before that screen saver started is displayed. • OFF : Screensaver is not activated.  <p>Format : Set the video signal format to be output for the TV you are using.</p> <ul style="list-style-type: none"> • NTSC : Select NTSC output. • PAL : Select PAL output. <p> "Format" can also be set by the following procedure. However, the menu screen is not displayed.</p> <ol style="list-style-type: none"> 1. Press and hold the main unit's MENU and ENTER for at least 3 seconds. "V.Format:<PAL>" appears on the display. 2. Press the main unit's $\triangleleft \triangleright$ and set the video signal format. 3. Press the main unit's ENTER to complete the setting. <p>NOTE</p> <p>When a format other than the video format of the connected TV is set, the picture will not be displayed properly.</p> <p>Text : Display the details of operation when switching surround mode, input mode, etc.</p> <ul style="list-style-type: none"> • ON : Turn display on. • OFF : Turn display off. <p>Master Volume : Display the master volume during adjustment.</p> <ul style="list-style-type: none"> • Bottom : Display at the bottom. • Top : Display at the top. • OFF : Turn display off. <p> When the master volume display is hard to see when superimposed on movie subtitles, set to "Top".</p> <p>Tuner : Set the tuner screen display time when the input source is "Tuner".</p> <ul style="list-style-type: none"> • Always : Show display continuously. • 30s : Show display for 30 seconds after operation. • 10s : Show display for 10 seconds after operation. • OFF : Turn display off.

Setting items	Setting details
Display Set the display on/off setting.	<p>ON : Display is always on.</p> <p>Auto OFF : Display is off except when showing the status display.</p> <p>OFF : Display is always off.</p> <p> This can also be set by pressing DISPLAY. Each time DISPLAY is pressed, the setting is changed as shown below.</p>   <p>Setup Lock Protect settings from inadvertent change.</p> <p>ON : Turn protection on.</p> <p>OFF : Turn protection off.</p> <p> When canceling the setting, set "Setup Lock" to "OFF".</p> <p>NOTE</p> <p>When "Setup Lock" is set to "ON", the settings listed below can no longer be changed. Also, "Setup Lock!" is displayed if you attempt to operate related settings.</p> <ul style="list-style-type: none"> • Menu operations • M-DAX • HT-EQ • Channel Level • Dynamic Volume® • Display settings

Language

Default settings are underlined.

Set the language for display on the menu screen.

Setting details

English / Deutsch / Français



"Language" can also be set by the following procedure. However, the menu screen is not displayed.

1. Press and hold the main unit's **MENU** and **ENTER** for at least 3 seconds.

"V.Format:<PAL>" appears on the display.

2. Press the main unit's **STATUS** and set "Lang:<ENGLISH >".

3. Press the main unit's \triangleleft and set the language.

4. Press the main unit's **ENTER** to complete the setting.



Perform settings related to input source playback.

- You do not have to change the settings to use the unit. Make settings when needed.

Menu operation

1 Press **AMP MENU** to set the remote control unit to **AMP-operation mode**.

The menu is displayed on the TV screen.

2 Use Δ / ∇ to select the menu to be set or operated.

3 Press **ENTER** or \triangleright to enter the setting.

- To return to the previous item, press **RETURN**.
- Exiting the Menu, press **AMP MENU** while the menu is displayed. The menu display disappears.

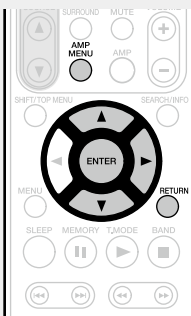

Important information

□ About the display of input sources

In this section, the configurable input sources for each item are shown as follows.

BD DVD SAT GAME AUX TV CD TUNER M-XPort

NOTE

Input sources that have been set to "Delete" at "Source Delete" ([page 59](#)) cannot be selected.

Items that can be set with the "Input Setup" procedure

Auto Preset ([page 63](#))

Preset Skip ([page 63](#))

Preset Name ([page 63](#))

Input Assign ([page 64](#))

Video ([page 65](#))

Input Mode (Audio) ([page 66](#))

Rename ([page 66](#))

Source Level (Audio) ([page 66](#))

Auto Preset

Use the auto preset function to program radio stations.

Setting items	Setting details
Start Start the auto preset process. TUNER	 If an FM station cannot be preset automatically, select the desired station by tuning it in manually, then preset it manually.

Preset Skip

Default settings are underlined.

Set preset channel to be skipped when selecting.

Setting items	Setting details
Block Select the preset memory block. TUNER	<u>A / B / C / D / E / F / G</u>
Block Presets Skip all channels of the selected preset memory blocks. TUNER	<u>ON</u> : Display the selected preset memory block. <u>Skip</u> : Do not display the selected preset memory block.
A1 – G8 Set by individual preset channels in the currently selected preset memory block. TUNER	<u>ON</u> : Display the selected preset channel. <u>Skip</u> : Do not display the selected preset channel.  If you set “Block Presets” to “Skip”, you can skip by blocks (A – G).

Preset Name

Assign name to a preset memory.

Setting items	Setting details
Block Select the preset memory block. TUNER	<u>A / B / C / D / E / F / G</u>
A1 – G8 Change the display name of the selected channel. TUNER	<ul style="list-style-type: none"> Up to eight characters can be input. For character input, see page 46.
Default The changed preset name is returned to the default setting.	<u>Yes</u> : Reset to the defaults. <u>No</u> : Do not reset to the defaults.  If you select “Default” and press ENTER , the message “Return settings to the default?” is displayed. Select “Yes” or “No”, and then press ENTER .

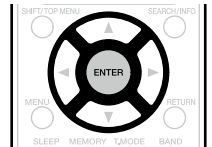

Input Assign

Examples of "Input Assign" menu screen displays

This screen appears when the "Input Setup" – "each input source" – "Input Assign" menu is selected. Use the "Input Assign" menu to change the ② HDMI input connectors, ③ Digital input connectors, and ④ component input connectors that are assigned to the ① input sources in default settings.

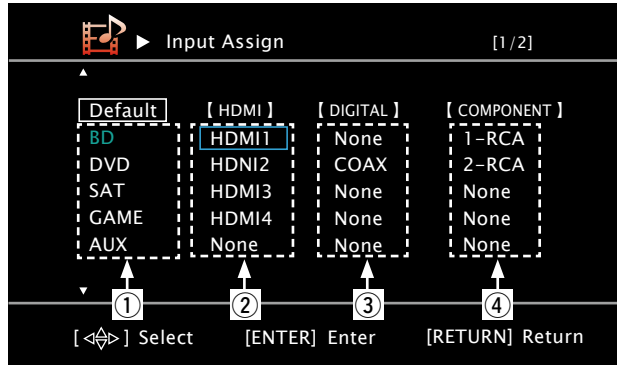

Input assignments menu operations

- 1** Use $\Delta \nabla \triangleleft \triangleright$ to move the highlight to the item you want to set.
- 2** Press **ENTER**, then use $\triangleleft \triangleright$ to select the input connector to be assigned.
- 3** Press **ENTER** to register the setting.

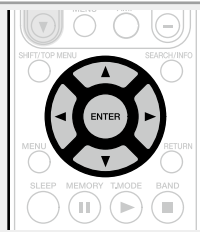

Setting items	Setting details																				
HDMI Set this to change the HDMI input connectors assigned to the input sources. <div style="display: flex; flex-wrap: wrap; gap: 5px;"> BD DVD SAT </div> <div style="display: flex; flex-wrap: wrap; gap: 5px;"> GAME AUX TV </div>	HDMI 1 / HDMI 2 / HDMI 3 / HDMI 4 None : Do not assign an HDMI input connector to the selected input source. • At time of purchase, the settings of the different input sources are as shown below.																				
	<table border="1"> <tr> <td>Input source</td> <td>BD</td> <td>DVD</td> <td>SAT</td> <td>GAME</td> </tr> <tr> <td>Default setting</td> <td>HDMI 1</td> <td>HDMI 2</td> <td>HDMI 3</td> <td>HDMI 4</td> </tr> </table>	Input source	BD	DVD	SAT	GAME	Default setting	HDMI 1	HDMI 2	HDMI 3	HDMI 4	<table border="1"> <tr> <td>Input source</td> <td>AUX</td> <td>TV</td> </tr> <tr> <td>Default setting</td> <td>None</td> <td>None</td> </tr> </table>			Input source	AUX	TV	Default setting	None	None	
Input source	BD	DVD	SAT	GAME																	
Default setting	HDMI 1	HDMI 2	HDMI 3	HDMI 4																	
Input source	AUX	TV																			
Default setting	None	None																			
DIGITAL Set this to change the digital input connectors assigned to the input sources. <div style="display: flex; flex-wrap: wrap; gap: 5px;"> BD DVD SAT </div> <div style="display: flex; flex-wrap: wrap; gap: 5px;"> GAME AUX TV </div> <div style="display: flex; flex-wrap: wrap; gap: 5px;"> CD </div>	COAX (coaxial) / OPT (optical) None : Do not assign a digital input connector to the selected input source. • At time of purchase, the settings of the different input sources are as shown below.																				
	<table border="1"> <tr> <td>Input source</td> <td>BD</td> <td>DVD</td> <td>SAT</td> <td>GAME</td> </tr> <tr> <td>Default setting</td> <td>None</td> <td>COAX</td> <td>None</td> <td>None</td> </tr> </table>	Input source	BD	DVD	SAT	GAME	Default setting	None	COAX	None	None	<table border="1"> <tr> <td>Input source</td> <td>AUX</td> <td>TV</td> <td>CD</td> </tr> <tr> <td>Default setting</td> <td>None</td> <td>None</td> <td>OPT</td> </tr> </table>			Input source	AUX	TV	CD	Default setting	None	None
Input source	BD	DVD	SAT	GAME																	
Default setting	None	COAX	None	None																	
Input source	AUX	TV	CD																		
Default setting	None	None	OPT																		

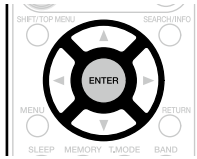
Setting items	Setting details																
<p>COMPONENT Set this to change the digital input connectors assigned to the input sources.</p> <p>BD DVD SAT GAME AUX TV</p>	<p>1-RCA / 2-RCA None : Do not assign a component video input connector to the selected input source.</p> <ul style="list-style-type: none"> At time of purchase, the settings of the different input sources are as shown below. <table border="1"> <thead> <tr> <th>Input source</th> <th>BD</th> <th>DVD</th> <th>SAT</th> <th>GAME</th> </tr> </thead> <tbody> <tr> <td>Default setting</td> <td>1-RCA</td> <td>2-RCA</td> <td>None</td> <td>None</td> </tr> </tbody> </table> <table border="1"> <thead> <tr> <th>Input source</th> <th>AUX</th> <th>TV</th> </tr> </thead> <tbody> <tr> <td>Default setting</td> <td>None</td> <td>None</td> </tr> </tbody> </table> <p> An input source to which an component video input connector cannot be assigned is displayed as “---”.</p>	Input source	BD	DVD	SAT	GAME	Default setting	1-RCA	2-RCA	None	None	Input source	AUX	TV	Default setting	None	None
Input source	BD	DVD	SAT	GAME													
Default setting	1-RCA	2-RCA	None	None													
Input source	AUX	TV															
Default setting	None	None															
<p>Default The “Input Assign” settings are returned to the default settings.</p>	<p>Yes : Reset to the defaults. No : Do not reset to the defaults.</p> <p> If you select “Default” and press ENTER, the message “Return settings to the default?” is displayed. Select “Yes” or “No”, and then press ENTER.</p> 																

Video

Default settings are underlined.

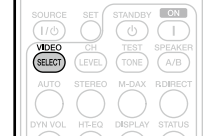

Set the source video.

Setting items	Setting details
<p>Video Select Video of another input source is played back combined with the playing audio.</p>	<p>Source : Play the picture and sound of the input source. BD / DVD / SAT / GAME / AUX / TV : Select video input source to view. This can be set for individual input sources.</p> <p></p> <ul style="list-style-type: none"> “GAME”, “AUX” and “TV” can be selected only when a component video connector is assigned as an input source. Buttons on the remote control unit can be used for operations. <ul style="list-style-type: none"> Press VIDEO SELECT until the desired picture appears. To cancel, press VIDEO SELECT to select “Source”.  <p>NOTE</p> <ul style="list-style-type: none"> It is not possible to select HDMI input signals. Input sources for which “Delete” is selected at “Source Delete” (page 59) cannot be selected.
<p>Video Mode Make settings for video processing.</p> <p>BD DVD GAME AUX TV</p>	<p>Auto : Process video automatically based on the HDMI content information. Game : Always process video appropriate for game content. Movie : Process video normally.</p> <p> If “Video Mode” is set to “Auto”, the mode is switched according to the input contents.</p>

Input Mode (Audio)

Default settings are underlined.

The input modes available for selection may vary depending on the input source.

Setting items	Setting details						
<p>Input Mode Set the audio input modes for the different input sources. It is normally recommended to set the audio input mode to "Auto".</p>	<p>Auto : Automatically detect input signal and perform playback. HDMI : Play only signals from HDMI input. Digital : Play only signals from digital input. Analog : Play only signals from analog input.</p> <p> <ul style="list-style-type: none"> "HDMI" can be set for input sources for which "HDMI" is assigned at "Input Assign" (page 64). "Digital" can be set for input sources for which "DIGITAL" is assigned at "Input Assign" (page 64). If the input source is set to "GAME" or "TV", it cannot be set to "Analog". When digital signals are properly input, the DIG indicator lights on the display. If the DIG indicator does not light, check the digital input connector assignment and the connections. If "HDMI Control" is set to "ON" and a TV compatible with the ARC is connected via the HDMI MONITOR connectors, the input mode whose input source is "TV" is fixed to ARC. </p>						
<p>Decode Mode Set the audio decode mode for input source.</p> <table border="1"> <tr> <td>BD</td> <td>DVD</td> <td>SAT</td> </tr> <tr> <td>GAME</td> <td>AUX</td> <td>TV</td> </tr> </table>	BD	DVD	SAT	GAME	AUX	TV	<p>Auto : Detect type of digital input signal and decode and play automatically. PCM : Decode and play only PCM input signals. DTS : Decode and play only DTS input signals.</p> <p> <ul style="list-style-type: none"> This item can be set for input sources for which "HDMI" or "DIGITAL" is assigned at "Input Assign" (page 64). Normally set this mode to "Auto". Set "PCM" and "DTS" when inputting the corresponding input signal. </p>
BD	DVD	SAT					
GAME	AUX	TV					

Rename

Change the display name of the selected input source.

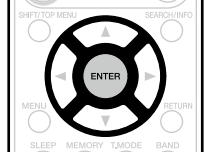
Setting items	Setting details
<p>Rename Change the display name of the selected input source.</p>	<ul style="list-style-type: none"> Up to eight characters can be input. For character input, see page 46.
<p>Default The input source name is returned to the default setting.</p>	<p>Yes : Reset to the defaults. No : Do not reset to the defaults.</p> <p> If you select "Default" and press ENTER, the message "Return settings to the default?" is displayed. Select "Yes" or "No", and then press ENTER.</p> 

Source Level (Audio)

Default settings are underlined.

- This function corrects the playback level of the selected input source's audio input.
- Make this setting if there are differences in the input volume levels between the different sources.

Setting details

-12dB - +12dB (0dB)

-  The analog input level and digital input level can be adjusted independently for input sources for which "HDMI" or "DIGITAL" is assigned at "Input Assign" ([page 64](#)).

Other settings

Remote control settings

- When you connect a remote control receiver unit (purchased separately) to the REMOTE CONTROL IN connector of this unit, use the following procedure to disable the remote sensor function of this unit.
- The remote sensor function of remote control signals is enabled by default.

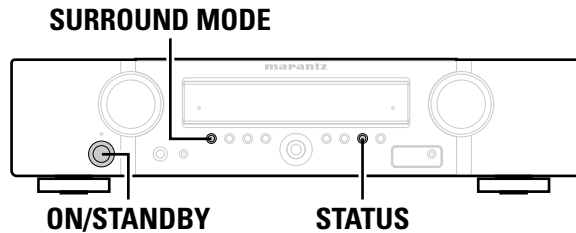

❑ Disabling the sensor function of the remote control unit

When the main unit is in standby mode, press **ON/STANDBY** while holding down **SURROUND MODE** and **STATUS** on the main unit.

"Remote Lock:ON" is shown on the display, and the infrared light receiving function is disabled.

❑ Enabling the remote sensor function

When the main unit is in standby mode, press **ON/STANDBY** while holding down **SURROUND MODE** and **STATUS** on the main unit.

The infrared light receiving function on the main unit is enabled.

NOTE

If a remote control receiver unit (purchased separately) is not connected, do not perform this setting. If you do, you will not be able to operate this unit using the remote control unit.

Operating the connected devices by remote control unit

Registering the supplied preset codes in the remote control unit enables you to operate devices made by other manufacturers.

Operating AV devices

1 Press the input source select button (page 18).

The operation mode of the remote control unit is switched as shown in the table.



NOTE

Press the input source select buttons once to switch the operation mode of the remote control unit supplied with this unit. Press the input source select buttons twice consecutively to switch the operation mode of the remote control unit and input source of this unit.

Input source select button	Input source of this unit	Operation mode
		Devices controllable with the remote control unit
*	BD	Device registered on the BD button
*	DVD	Device registered on the DVD button
*	SAT	Device registered on the SAT button
*	TV	Device registered on the TV button
*	CD	marantz CD player
	TUNER	Radio of this unit
	M-XPport	Device registered on the M-XP button

* If a preset code is registered for this button, the remote control unit of this unit can control another devices.



When is pressed, the AMP-operation mode starts automatically.

NOTE

If the mode of the remote control unit is set to other than AMP-operation mode, press **AMP** to switch the remote control unit to the AMP-operation mode to perform the following operations:

- For setting the channel level of the unit by pressing **CH LEVEL**.
- For performing direct playback.
- For using the Video Select function.
- For using the sleep timer function.
- For switching the M-DAX function.
- For directly selecting "AUTO" and "STEREO" of the listening modes.
- For using the test tone function.
- For using the HT-EQ function.

2 Operate this unit or the device whose input source is switched.

- For details, refer to the operating instructions for each device. For operations of TUNER, see the following pages.
- TUNER (page 23)

Registering preset codes

When preset codes are registered in the included remote control unit, it can then be used to operate any devices you have, such as DVD players or TVs made by different manufacturers.

NOTE

- No preset codes other than **BD**, **DVD**, **SAT**, **TV** and **CD** can be registered.
- In the factory settings, remote control codes for all marantz products are registered.

Buttons used for operating the devices

- 1 **SOURCE I/⏻**
For switching power of each device on or off.
- 2 **△▽◀▶, ENTER**
For menu operation of each device.
- 3 **MENU, SHIFT/TOP MENU**
For displaying the menu of each device.
- 4 **⏮, ▶, ■, ◀, ▶▶, ▶▶▶, ◀◀, ▶▶▶▶**
- 5 Number button (**0 - 9, +10**)
- 6 **PRESET +, PRESET -**
- 7 **TV I/⏻, TV INPUT**
For operating a TV
This button is enabled in any mode.

For details on operation with the remote control unit, see pages [23](#), [71](#), [72](#).

Registering preset codes

The following two methods can be used for registering the reset code.

- 1 Entering a 4-digit code
- 2 Scanning the code table

1 Entering a 4-digit code

See the preset code list table for the code to be input.

- 1 Press and hold down the input source select buttons for the appliance to control, and press **SET** until the SET indicator blinks.

- 2 Press the 4-digit code for the appliance using **0 - 9** (code table at the end of this book).

When the procedure is successful, the SEND indicator blinks twice.

NOTE

If the SEND indicator did not blink twice, then repeat steps 1 and 2 and try entering the same code again.

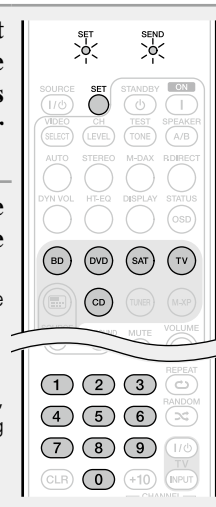

2 Scanning the code table

- 1 Switch the power of the appliance to which you want to register the preset code to ON.

- 2 Press and hold down the input source select buttons for the appliance to control, and press **SET** until the SET indicator blinks.

- 3 Aim the remote control at the appliance and slowly alternate between pressing **SOURCE ▲** and **SOURCE I/⏻** for the appliance.

- 4 When the power of the appliance that you want to register has turned off, release the button.

- 5 Press **ENTER**.
When the procedure is successful, the SEND indicator blinks twice.

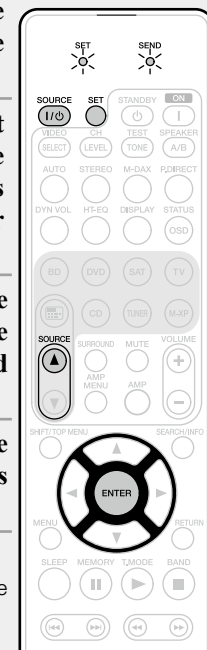

Check the registered preset code

1 Press and hold down the input source select buttons for the appliance to control, and press **SET** until the **SET** indicator blinks.

2 Press **SEARCH/INFO**.
The **SEND** indicator blinks twice.

3 To view the code for first digit, press **1**.

Count the number of times the **SEND** indicator blinks (e.g. 3 blinks = 3) and write down the number.

- If a code digit is "0", the **SEND** indicator does not blink.

4 Then press **2** to check the second digit of the code. Now press **3** and **4** to check the third and fourth digits of the code.

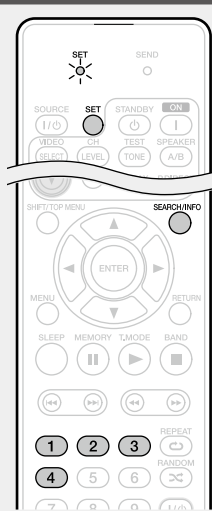

Default settings for preset codes

The devices shown below are registered for each input source button as default. Settings can be changed according to the devices to be used.

1 Press and hold down the input source select buttons for the appliance to control, and press **SET** until the **SET** indicator blinks twice.

2 Enter the appropriate preset code (4 digits) from the table below.

The **SEND** indicator blinks twice.

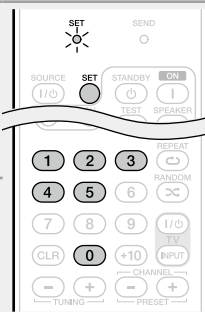

Input source select buttons	Category	Brand	Preset code
BD	Blu-ray Disc player	marantz	5000
DVD	DVD player	marantz	2000
TV	Television	marantz	1000
SAT	Satellite set top box	marantz	4000
CD	CD player	marantz	3000

NOTE

After this procedure, the selected source reset to its initial code.

Operating devices

The supplied remote control unit can control a device other than this unit.

1 Press the input source select button to which the preset code for the device you want to operate has been registered (page 68).



2 Operate the device.

• For details, refer to the device's operating instructions.

Blu-ray Disc player / HD-DVD player / DVD player / DVD recorder operation

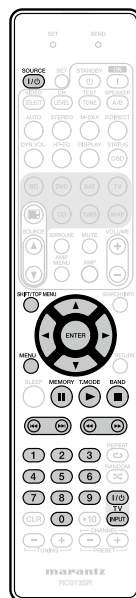

Operation buttons	Function
SOURCE I / ⏻	Power on/standby
SHIFT/TOP MENU	Top menu
△▽◀▶	Cursor operation
ENTER	Enter
MENU	(Popup) Menu
⏸	Pause
▶	Playback
■	Stop
⏮ ⏪ ⏩ ⏭	Auto search (cue)
⏮ ⏪ ⏩ ⏭	Manual search (fast-reverse/fast-forward)
0 - 9	Select title, chapter or channel selection
TV I / ⏻	TV power on/standby (Default : marantz)
TV INPUT	Switch TV input (Default : marantz)

CD player operation

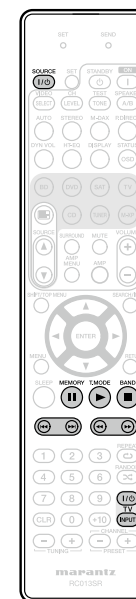

Operation buttons	Function
SOURCE I / ⏻	Power on/off
⏸	Pause
▶	Playback
■	Stop
⏮ ⏪ ⏩ ⏭	Auto search (cue)
⏮ ⏪ ⏩ ⏭	Manual search (fast-reverse/fast-forward)
TV I / ⏻	TV power on/standby (Default : marantz)
TV INPUT	Switch TV input (Default : marantz)

TV operation

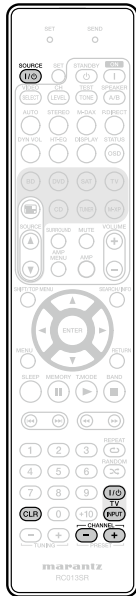

Operation buttons	Function
SOURCE I / ⏻	TV power on/standby (Default : marantz)
CLR	Clear the inputting
TV I / ⏻	TV power on/standby (Default : marantz)
TV INPUT	Switch TV input (Default : marantz)
CHANNEL +, -	Switch channels (up/down)



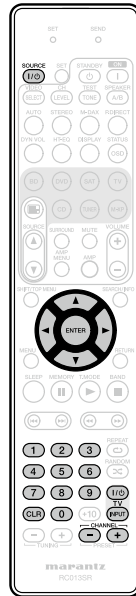



Set top box for satellite (SAT) operation



Operation buttons	Function
SOURCE I / ⏻	Power on/standby
△▽◀▶	Cursor operation
ENTER	Enter
0 - 9	Channel selection
CLR	Clear the inputting
TV I / ⏻	TV power on/standby (Default : marantz)
TV INPUT	Switch TV input (Default : marantz)
CHANNEL +, -	Switch channels (up/down)

Information

Here, we list various information related to this unit.
Please refer to this information as needed.

- Part names and functions  [page 74](#)
- Other information  [page 79](#)
- Troubleshooting  [page 87](#)
- Specifications  [page 90](#)
- Index  [page 91](#)
- List of preset codes  [page 93](#)

Part names and functions

Front panel

For buttons not explained here, see the page indicated in parentheses ().

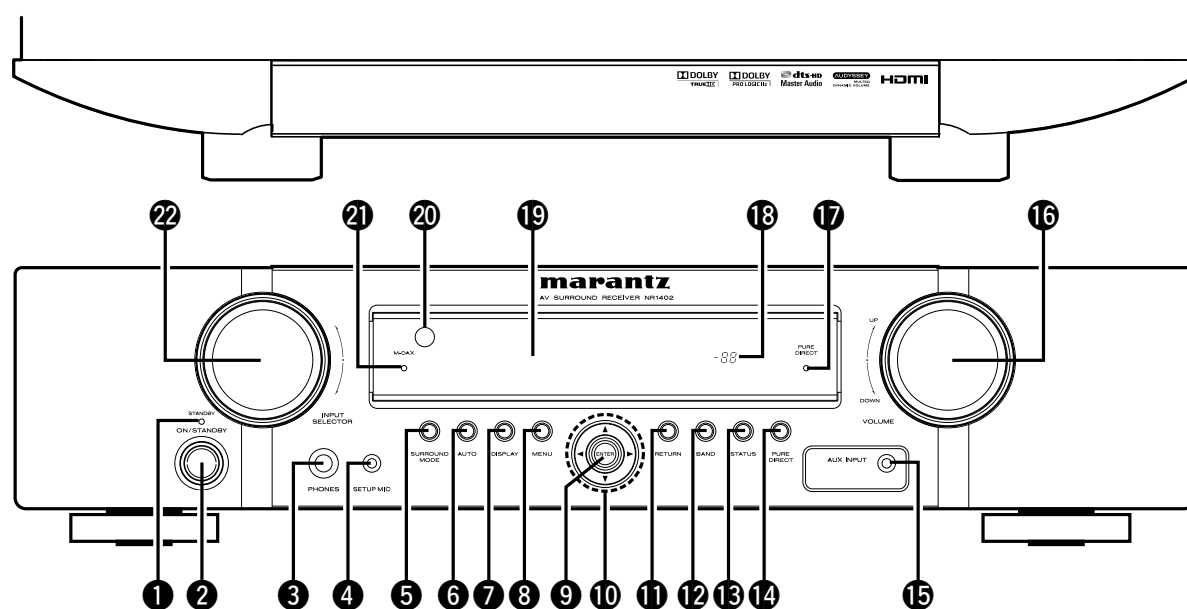

- | | | | | | |
|---|-----------------------|---------------------------------------|---|---------------------------------------|---|
| 1 Power indicator (STANDBY) | (5) | 4 SETUP MIC jack | (13 , 35) | 14 PURE DIRECT button | (24 , 41) |
| 2 Power operation button (ON/STANDBY) | (5) | 5 SURROUND MODE button | (24 , 67) | 15 AUX INPUT jack | (8) |
| Turns power to this unit on and off (standby). | | 6 AUTO button | (24) | 16 VOLUME control knob | (19) |
| 3 Headphones jack (PHONES) | | 7 DISPLAY button | (41 , 60) | 17 PURE DIRECT indicator | (24) |
| When the headphones are plugged into this jack, audio will no longer be output from the connected speakers. | | 8 MENU button | (41 , 48 , 60) | 18 Master volume indicator | |
| NOTE | | 9 ENTER button | (45 , 46 , 48 , 60 , 67) | 19 Display | (75) |
| To prevent hearing loss, do not raise the volume level excessively when using headphones. | | 10 Cursor buttons (▲▼◀▶) | (41 , 45 , 46 , 48 , 60 , 67) | 20 Remote control sensor | (78) |
| | | 11 RETURN button | (48) | 21 M-DAX indicator | (52) |
| | | 12 BAND button | (20 , 41) | 22 INPUT SELECTOR knob | (19) |
| | | 13 STATUS button | (53 , 61 , 67) | | |

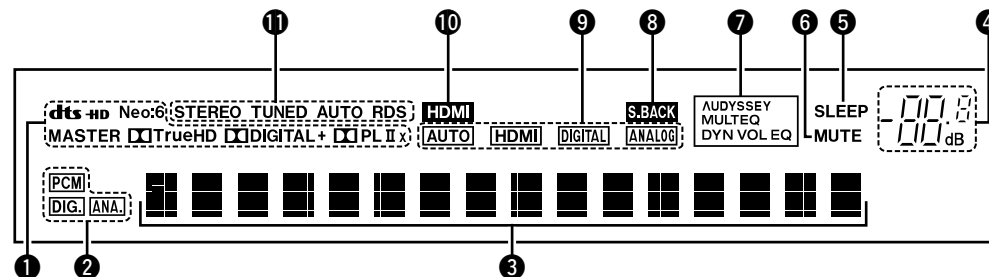

1 Decoder indicators

These light when the respective decoders are operating.

2 Input signal indicators

3 Information display

The input source name, surround mode, setting values and other information are displayed here.

4 Master volume indicator

5 Sleep timer indicator

This lights when the sleep mode is selected ([page 39](#)).

6 MUTE indicator

This lights when the mute mode is selected ([page 19](#)).

7 Audyssey® indicators

Light up as follows, depending on the setting of "MultEQ®" ([page 50](#)), "Dynamic EQ®" ([page 51](#)) and "Dynamic Volume®" ([page 51](#)).

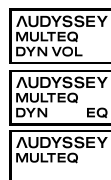

When "MultEQ®", "Dynamic EQ®" and "Dynamic Volume®" are "ON".

When "MultEQ®" and "Dynamic EQ®" are "ON" and "Dynamic Volume®" is "OFF".

When "MultEQ®" is "ON" and "Dynamic EQ®" and "Dynamic Volume®" are "OFF".

8 Surround back indicator

This lights when audio signals are being output from the surround back speakers ([page 55](#)).

9 Input mode indicators

Set the audio input modes for the different input sources ([page 66](#)).

10 HDMI indicator

This lights when playing using HDMI connections.

11 Tuner reception mode indicators

These light according to the reception conditions when the input source is set to "TUNER".

STEREO : In the FM mode, this lights up when receiving stereo broadcasts.

TUNED : Lights up when the broadcast is properly tuned in.

AUTO : Lights up when in the auto tuning mode.

RDS : Lights up when receiving RDS broadcasts.

Rear panel

See the page indicated in parentheses ().

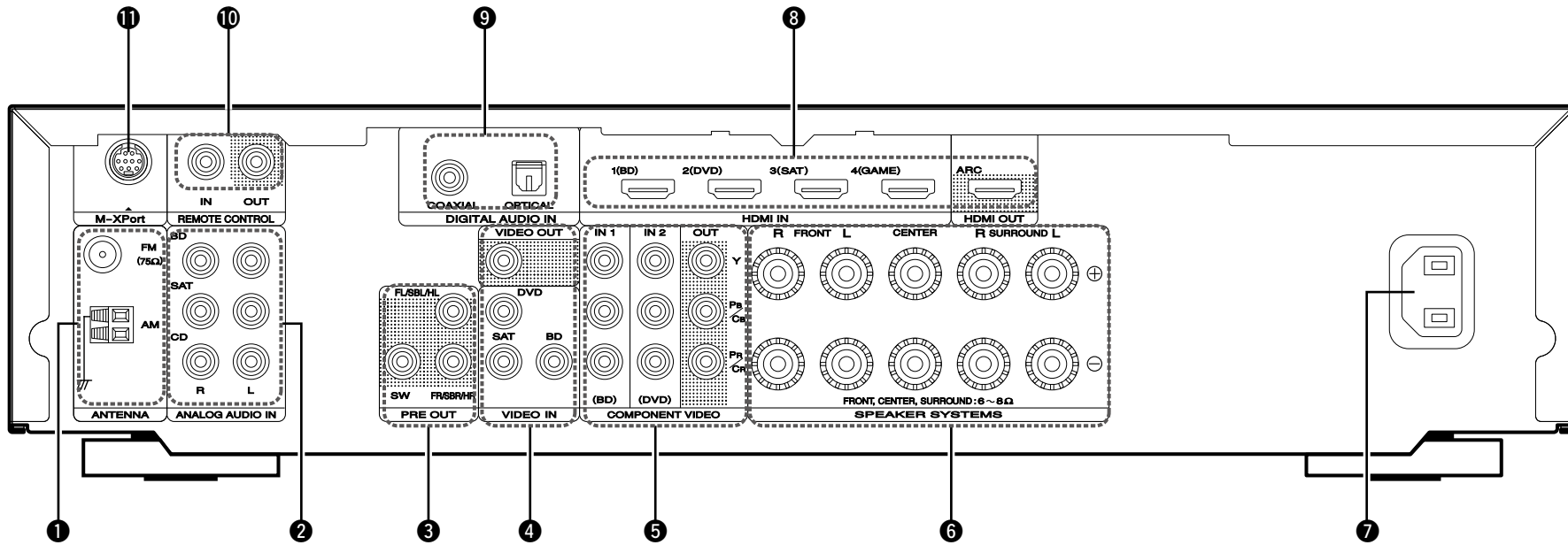

- 1** FM/AM antenna terminals (9)
- 2** Analog audio connectors (7, 8, 9)
- 3** PRE OUT connectors (6, 31, 32, 33, 34)
- 4** VIDEO connectors (7, 8)
- 5** COMPONENT VIDEO connectors (7, 8)
- 6** Speaker terminals (6, 31, 32, 33, 34)
- 7** AC inlet (AC IN) (5)
- 8** HDMI connectors (3, 6)
- 9** Digital audio connectors (7, 9)
- 10** REMOTE CONTROL connectors (37)
- 11** M-XPort connector (10)

NOTE

Do not touch the inner pins of the connectors on the rear panel. Electrostatic discharge may cause permanent damage to the unit.

Remote control unit

For buttons not explained here, see the page indicated in parentheses ().

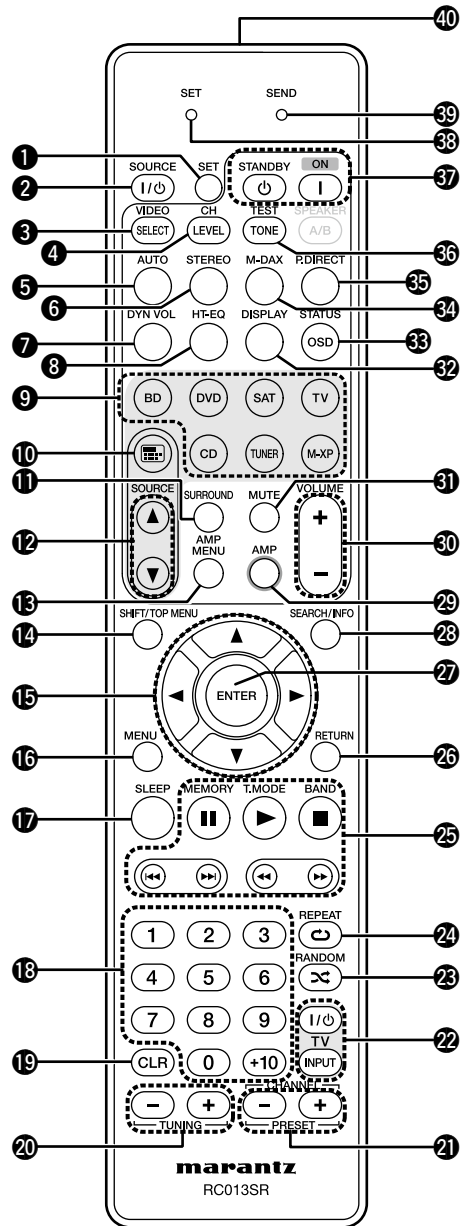

- 1 SET button (69, 70)
- 2 SOURCE power button (I/⏻) (69, 71, 72)
- 3 VIDEO SELECT button (65)
- 4 Channel level button (CH LEVEL) (40)
- 5 AUTO button (24)
- 6 STEREO button (24)
- 7 Audyssey Dynamic Volume® button (DYN VOL) (51)
- 8 HT-EQ button (49)
- 9 Input source select buttons (18)
- 10 Source select menu button (⏏) (18)
- 11 SURROUND button (24)
- 12 Source select buttons (SOURCE ▲▼) (19)
- 13 AMP MENU button (44, 48, 54, 62)
- 14 SHIFT/TOP MENU button (20, 21, 46)
- 15 Cursor buttons (△▽◀▶) (45, 46, 48, 54, 62)
- 16 MENU button (71)
- 17 SLEEP button (39)
- 18 Number buttons (20, 69, 70)
- 19 Clear button (CLR) (20, 21)
- 20 TUNING buttons (+, -) (20)
- 21 PRESET buttons (+, -) (20, 21)
- 22 TV operation buttons (TV I/⏻ / INPUT) (23, 71, 72)
- 23 RANDOM button (∞) (78)
- 24 REPEAT button (↺) (71, 72)
- 25 System buttons (71, 72)
 - Pause button (⏸)
 - Play button (▶)
 - Stop button (■)
 - Skip button (⏮, ⏭)
 - Search button (⏪, ⏩)
- MEMORY button (20)
- Tuner mode button (T.MODE) (20)
- FM/AM band switching button (BAND) (20)
- 26 RETURN button (48, 54, 62)
- 27 ENTER button (45, 46, 48, 54, 62)
- 28 SEARCH/Information (INFO) button (21, 47, 70)
- 29 AMP button (12, 35, 68)
- 30 Master volume control buttons (VOLUME +, -) (19)
- 31 Muting button (MUTE) (19)
- 32 DISPLAY button (60)
- 33 STATUS OSD button (53)
- 34 M-DAX button (52)
- 35 Pure direct button (P.DIRECT) (24)
- 36 TEST TONE button (57)
- 37 Power buttons (ON/STANDBY) (69, 70)
- 38 SET indicator (69, 70)
- 39 SEND indicator (69, 70)
- 40 Remote control signal transmitter (78)

NOTE

The **SPEAKER A/B** button cannot be used.

Inserting the batteries

- ① Remove the rear lid in the direction of the arrow and remove it.
- ② Load the two batteries properly as indicated by the marks in the battery compartment.

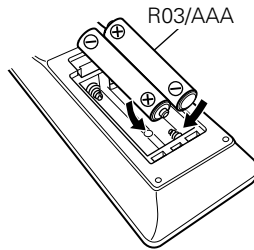
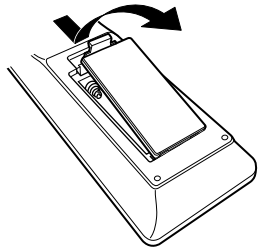

- ③ Put the rear cover back on.

NOTE

- Insert the specified batteries in the remote control unit.
- Replace the batteries with new ones if the set does not operate even when the remote control unit is operated close to the unit. (The supplied batteries are only for verifying operation.)
- When inserting the batteries, be sure to do so in the proper direction, following the ⊕ and ⊖ marks in the battery compartment.
- To prevent damage or leakage of battery fluid:
 - Do not use a new battery together with an old one.
 - Do not use two different types of batteries.
 - Do not attempt to charge dry batteries.
 - Do not short-circuit, disassemble, heat or dispose of batteries in flames.
 - Do not keep the battery in a place exposed to direct sunlight or in places with extremely high temperatures, such as near a heater.
- If the battery fluid should leak, carefully wipe the fluid off the inside of the battery compartment and insert new batteries.
- Remove the batteries from the remote control unit if it will not be in use for long periods.
- Used batteries should be disposed of in accordance with the local regulations regarding battery disposal.
- The remote control unit may function improperly if rechargeable batteries are used.

Operating range of the remote control unit

Point the remote control unit at the remote sensor when operating it.

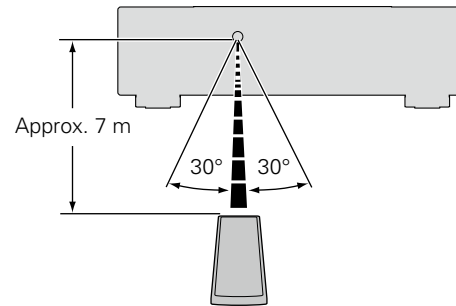

NOTE





- The set may function improperly or the remote control unit may not operate if the remote control sensor is exposed to direct sunlight, strong artificial light from an inverter type fluorescent lamp or infrared light.
- When using 3D video devices that transmit radio communication signals (such as infrared signals etc) between the various units (such as the monitor, 3D glasses, 3D transmitter unit etc), the remote control unit may not operate due to interference from those radio communication signals. If this occurs, adjust the direction and distance of the 3D communication for each unit, and check that the remote control unit operation is not affected by these signals.

Other information

- ❑ **Trademark information** ([page 79](#))
- ❑ **Surround** ([page 80](#))
- ❑ **Relationship between video signals and monitor output** ([page 84](#))
- ❑ **Explanation of terms** ([page 85](#))

Trademark information

This product uses the following technologies:

 	<p>Manufactured under license from Dolby Laboratories. "Dolby", "Pro Logic" and the double-D symbol are trademarks of Dolby Laboratories.</p>
	<p>Manufactured under license under U.S. Patent #'s: 5,451,942; 5,956,674; 5,974,380; 5,978,762; 6,226,616; 6,487,535; 7,212,872; 7,333,929; 7,392,195; 7,272,567 & other U.S. and worldwide patents issued & pending. DTS and the Symbol are registered trademarks, & DTS-HD, DTS-HD Master Audio, and the DTS logos are trademarks of DTS, Inc. Product includes software. © DTS, Inc. All Rights Reserved.</p>
	<p>HDMI, the HDMI Logo and High-Definition Multimedia Interface are trademarks or registered trademarks of HDMI Licensing LLC in the United States and other countries.</p>
	<p>Manufactured under license from Audyssey Laboratories™. U.S. and foreign patents pending. Audyssey MultEQ® is a registered trademark of Audyssey Laboratories. Audyssey Dynamic EQ® is a registered trademark of Audyssey Laboratories. Audyssey Dynamic Volume® is a registered trademark of Audyssey Laboratories.</p>

Surround

This unit is equipped with a digital signal processing circuit that lets you play program sources in the surround mode to achieve the same sense of presence as in a movie theater.

Surround modes and surround parameters

This table shows the speakers that can be used in each surround mode and the surround parameters adjustable in each surround mode.

Symbols in the table

- This indicates the audio output channels or surround parameters that can be set.
- ⊙ This indicates the audio output channels. The output channels depend on the settings of "Speaker Config." (page 55).

Surround mode (page 24)	Channel output						Surr.Parameter (page 49)			
	Front L/R	Center	Surround L/R	Surround Back L/R	Front Height L/R	Subwoofer	HT-EQ (page 49)	DRC *4 (page 49)	D. Comp *5 (page 49)	LFE *6 (page 49)
DIRECT/PURE DIRECT (2channel)*1	○					⊙*3		○	○	
DIRECT/PURE DIRECT (Multi-channel)*1	○	⊙	⊙	⊙*2	⊙*2	⊙		○	○	○
STEREO	○					⊙		○	○	○
MULTI CH IN	○	⊙	⊙	⊙	⊙	⊙	○			○
DOLBY PRO LOGIC IIz	○	⊙	⊙		⊙	⊙	○	○	○	
DOLBY PRO LOGIC IIx	○	⊙	⊙	⊙		⊙	○	○	○	
DOLBY PRO LOGIC II	○	⊙	⊙			⊙	○	○	○	
DTS NEO:6	○	⊙	⊙	⊙		⊙	○	○	○	
DOLBY DIGITAL	○	⊙	⊙	⊙	⊙	⊙	○		○	○
DOLBY DIGITAL Plus	○	⊙	⊙	⊙	⊙	⊙	○		○	○
DOLBY TrueHD	○	⊙	⊙	⊙	⊙	⊙	○	○		○
DTS SURROUND	○	⊙	⊙	⊙	⊙	⊙	○		○	○
DTS 96/24	○	⊙	⊙	⊙	⊙	⊙	○		○	○
DTS-HD	○	⊙	⊙	⊙	⊙	⊙	○		○	○
DTS Express	○	⊙	⊙	⊙	⊙	⊙	○		○	○
MULTI CH STEREO	○	⊙	⊙	⊙	⊙	⊙	○	○	○	○
VIRTUAL	○					⊙		○	○	○

- *1 During playback in PURE DIRECT mode, the surround parameters are the same as in DIRECT mode.
- *2 A signal for each channel contained in an input signal is output as audio.
- *3 Only when "Subwoofer Mode" is set to "LFE+Main" (page 56), sound is output from the subwoofer.
- *4 This item can be selected when a Dolby TrueHD signal is played.
- *5 This item can be selected when a Dolby Digital or DTS signal is played.
- *6 This item can be selected when a Dolby Digital or DTS signal or DVD-Audio is played.

Surround mode (page 24)	Surr.Parameter (page 49)				Tone *8 (page 50)	Audyssey Settings*9 (page 50)			M-DAX *12 (page 52)	
	Height Gain *7 (page 49)	PRO LOGIC II/IIx Music mode only				C.Image (page 49)	MultEQ® (page 50)	Dynamic EQ® *10 (page 51)		Dynamic Volume® *11 (page 51)
		Panorama (page 49)	Dimension (page 49)	C.Width (page 49)						
DIRECT/PURE DIRECT (2channel)*1										
DIRECT/PURE DIRECT (Multi-channel)*1										
STEREO					<input type="radio"/>	<input type="radio"/>	<input type="radio"/>	<input type="radio"/>	<input type="radio"/>	
MULTI CH IN	<input type="radio"/>				<input type="radio"/>	<input type="radio"/>	<input type="radio"/>	<input type="radio"/>	<input type="radio"/>	
DOLBY PRO LOGIC IIz	<input type="radio"/>				<input type="radio"/>	<input type="radio"/>	<input type="radio"/>	<input type="radio"/>	<input type="radio"/>	
DOLBY PRO LOGIC IIx		<input type="radio"/>	<input type="radio"/>	<input type="radio"/>	<input type="radio"/>	<input type="radio"/>	<input type="radio"/>	<input type="radio"/>	<input type="radio"/>	
DOLBY PRO LOGIC II		<input type="radio"/>	<input type="radio"/>	<input type="radio"/>	<input type="radio"/>	<input type="radio"/>	<input type="radio"/>	<input type="radio"/>	<input type="radio"/>	
DTS NEO:6				<input type="radio"/>	<input type="radio"/>	<input type="radio"/>	<input type="radio"/>	<input type="radio"/>	<input type="radio"/>	
DOLBY DIGITAL	<input type="radio"/>				<input type="radio"/>	<input type="radio"/>	<input type="radio"/>	<input type="radio"/>		
DOLBY DIGITAL Plus	<input type="radio"/>				<input type="radio"/>	<input type="radio"/>	<input type="radio"/>	<input type="radio"/>		
DOLBY TrueHD	<input type="radio"/>				<input type="radio"/>	<input type="radio"/>	<input type="radio"/>	<input type="radio"/>		
DTS SURROUND	<input type="radio"/>				<input type="radio"/>	<input type="radio"/>	<input type="radio"/>	<input type="radio"/>		
DTS 96/24	<input type="radio"/>				<input type="radio"/>	<input type="radio"/>	<input type="radio"/>	<input type="radio"/>		
DTS-HD	<input type="radio"/>				<input type="radio"/>	<input type="radio"/>	<input type="radio"/>	<input type="radio"/>		
DTS Express	<input type="radio"/>				<input type="radio"/>	<input type="radio"/>	<input type="radio"/>	<input type="radio"/>		
MULTI CH STEREO					<input type="radio"/>	<input type="radio"/>	<input type="radio"/>	<input type="radio"/>	<input type="radio"/>	
VIRTUAL					<input type="radio"/>	<input type="radio"/>	<input type="radio"/>	<input type="radio"/>	<input type="radio"/>	

- *1 During playback in PURE DIRECT mode, the surround parameters are the same as in DIRECT mode.
- *7 This item can be set when surround mode is "PLIIz" or PLIIz decoder is used.
- *8 This item cannot be set when "Dynamic EQ®" (page 51) is set to "ON".
- *9 For HD Audio whose sampling frequency of an input signal is more than 96 kHz, this sound parameter cannot be set.
- *10 This item cannot be set when "MultEQ®" (page 50) is set to "OFF" or "Manual".
- *11 This item cannot be set when "Dynamic EQ®" (page 51) is set to "OFF".
- *12 This item can be set when the input signal is analog, PCM 48 kHz or 44.1 kHz.

Types of input signals, and corresponding surround modes

This table shows the input signal that can be played in each surround mode. Check the audio signal of the input source then select the surround mode.

Symbols in the table

○ This indicates the selectable surround mode.

Surround mode (page 24)	NOTE	Input signal types and formats														
		ANALOG	PCM		DTS-HD		DTS				DOLBY		DOLBY DIGITAL			
			PCM (multi ch)	PCM (2ch)	DTS-HD Master Audio	DTS-HD High Resolution Audio	DTS EXPRESS	DTS ES DSCRT (With Flag)	DTS ES MTRX (With Flag)	DTS (5.1ch)	DTS 96/24	DOLBY TrueHD	DOLBY DIGITAL Plus	DOLBY DIGITAL EX (With Flag)	DOLBY DIGITAL EX (With no Flag)	DOLBY DIGITAL (5.1/5/4ch/3ch)
DTS SURROUND																
DTS-HD MSTR					○											
DTS-HD HI RES						○										
DTS ES DSCRT6.1	*1*3								○							
DTS ES MTRX6.1	*1*3									○						
DTS SURROUND									○	○						
DTS 96/24											○					
DTS (-HD) + PLIIx MOVIE	*2*3				○	○	○			○	○	○				
DTS (-HD) + PLIIx MUSIC	*1*3				○	○	○			○	○	○				
DTS (-HD) + PLIIz	*4				○	○	○	○		○	○	○				
DTS EXPRESS							○									
DTS (-HD) + NEO:6	*1*3				○	○	○			○	○	○				
DTS NEO:6 CINEMA		○		○												○
DTS NEO:6 MUSIC		○		○												○
DOLBY SURROUND																
DOLBY TrueHD												○				
DOLBY DIGITAL+													○			
DOLBY DIGITAL EX	*1*3												○	○	○	
DOLBY (D+) (HD) +EX	*1*3												○	○	○	
DOLBY DIGITAL													○	○	○	
DOLBY (D) (D+) (HD) +PLIIx MOVIE	*2*3												○	○	○	
DOLBY (D) (D+) (HD) +PLIIx MUSIC	*1*3												○	○	○	
DOLBY (D) (D+) (HD) +PLIIz	*4												○	○	○	
DOLBY PRO LOGIC IIx MOVIE	*1*3	○		○												○
DOLBY PRO LOGIC IIx MUSIC	*1*3	○		○												○
DOLBY PRO LOGIC IIx GAME	*1*3	○		○												○
DOLBY PRO LOGIC IIz	*4	○		○												○
DOLBY PRO LOGIC II MOVIE		○		○												○
DOLBY PRO LOGIC II MUSIC		○		○												○
DOLBY PRO LOGIC II GAME		○		○												○
DOLBY PRO LOGIC		○		○												○

- *1 If "Speaker Config." - "S.Back" (page 55) is set to "None", this surround mode cannot be selected.
- *2 If "Speaker Config." - "S.Back" (page 55) is set to "1spkr" or "None", this surround mode cannot be selected.
- *3 This surround mode can be selected when "Pre Assign" (page 55) is set to "NORMAL".
- *4 If "Speaker Config." - "F.Height" (page 56) is set to "None", this surround mode cannot be selected.

Surround mode (page 24)	NOTE	Input signal types and formats																
		ANALOG	PCM		DTS-HD		DTS					DOLBY		DOLBY DIGITAL				
			PCM (multi ch)	PCM (2ch)	DTS-HD Master Audio	DTS-HD High Resolution Audio	DTS EXPRESS	DTS ES DSCRT (With Flag)	DTS ES MTRX (With Flag)	DTS (5.1ch)	DTS 96/24	DOLBY TrueHD	DOLBY DIGITAL Plus	DOLBY DIGITAL EX (With Flag)	DOLBY DIGITAL EX (With no Flag)	DOLBY DIGITAL (5.1/5/4ch/3ch)	DOLBY DIGITAL (2ch)	
MULTI CH IN																		
MULTI CH IN			<input type="radio"/>															
MULTI CH IN + PLIIx MOVIE	*2*3		<input type="radio"/>															
MULTI CH IN + PLIIx MUSIC	*1*3		<input type="radio"/>															
MULTI CH IN + PLIIz	*4		<input type="radio"/>															
MULTI CH IN + Dolby EX	*1*3		<input type="radio"/>															
MULTI CH IN 7.1	*3		<input type="radio"/>															
DIRECT		<input type="radio"/>	<input type="radio"/>	<input type="radio"/>	<input type="radio"/>	<input type="radio"/>	<input type="radio"/>	<input type="radio"/>	<input type="radio"/>	<input type="radio"/>	<input type="radio"/>	<input type="radio"/>	<input type="radio"/>	<input type="radio"/>	<input type="radio"/>	<input type="radio"/>	<input type="radio"/>	<input type="radio"/>
PURE DIRECT		<input type="radio"/>	<input type="radio"/>	<input type="radio"/>	<input type="radio"/>	<input type="radio"/>	<input type="radio"/>	<input type="radio"/>	<input type="radio"/>	<input type="radio"/>	<input type="radio"/>	<input type="radio"/>	<input type="radio"/>	<input type="radio"/>	<input type="radio"/>	<input type="radio"/>	<input type="radio"/>	<input type="radio"/>
MULTI CH STEREO		<input type="radio"/>	<input type="radio"/>	<input type="radio"/>	<input type="radio"/>	<input type="radio"/>	<input type="radio"/>	<input type="radio"/>	<input type="radio"/>	<input type="radio"/>	<input type="radio"/>	<input type="radio"/>	<input type="radio"/>	<input type="radio"/>	<input type="radio"/>	<input type="radio"/>	<input type="radio"/>	<input type="radio"/>
VIRTUAL		<input type="radio"/>	<input type="radio"/>	<input type="radio"/>	<input type="radio"/>	<input type="radio"/>	<input type="radio"/>	<input type="radio"/>	<input type="radio"/>	<input type="radio"/>	<input type="radio"/>	<input type="radio"/>	<input type="radio"/>	<input type="radio"/>	<input type="radio"/>	<input type="radio"/>	<input type="radio"/>	<input type="radio"/>
STEREO		<input type="radio"/>	<input type="radio"/>	<input type="radio"/>	<input type="radio"/>	<input type="radio"/>	<input type="radio"/>	<input type="radio"/>	<input type="radio"/>	<input type="radio"/>	<input type="radio"/>	<input type="radio"/>	<input type="radio"/>	<input type="radio"/>	<input type="radio"/>	<input type="radio"/>	<input type="radio"/>	<input type="radio"/>

- *1 If "Speaker Config." - "S.Back" ([page 55](#)) is set to "None", this surround mode cannot be selected.
- *2 If "Speaker Config." - "S.Back" ([page 55](#)) is set to "1spkr" or "None", this surround mode cannot be selected.
- *3 This surround mode can be selected when "Pre Assign" ([page 55](#)) is set to "NORMAL".
- *4 If "Speaker Config." - "F.Height" ([page 56](#)) is set to "None", this surround mode cannot be selected.

Relationship between video signals and monitor output

Input connector			Output connector			Menu displayed		
HDMI	COMPONENT	VIDEO	HDMI	COMPONENT	VIDEO	HDMI	COMPONENT	VIDEO
×	×	×	×	×	×	Only the menu is displayed	×	×
×	×	○	×	×	○ <VIDEO>	Only the menu is displayed	×	× (VIDEO)
×	○	×	×	○ <COMPONENT>	×	Only the menu is displayed	× (COMPONENT)	×
×	○	○	×	○ <COMPONENT>	○ <VIDEO>	Only the menu is displayed	× (COMPONENT)	× (VIDEO)
○	×	×	○ <HDMI>	×	×	○ (HDMI)	×	×
○	×	○	○ <HDMI>	×	○ <VIDEO>	○ (HDMI)	×	× (VIDEO)
○	○	×	○ <HDMI>	○ <COMPONENT>	×	○ (HDMI)	× (COMPONENT)	×
○	○	○	○ <HDMI>	○ <COMPONENT>	○ <VIDEO>	○ (HDMI)	× (COMPONENT)	× (VIDEO)

○ Video signal input present
 × No video signal input

○ < > The input signal between the < > marks is output.
 × No video signal output

○ () Superimposed on the picture indicated in ().
 × () Only the picture in () is output.

NOTE

- If you operate the menu while playing back 3D video content or computer's resolution (e.g. VGA), the playback video is replaced by the menu screen. The playback video is not displayed behind the menu screen.
- This unit does not show the status display while playing back 3D video content or computer's resolution (e.g. VGA).

Explanation of terms

A

A2DP

A2DP is one profile of Bluetooth defined for in-car devices or AV devices that use wireless communication instead of a cable.

Adobe RGB color, Adobe YCC601 color

Like "x.v.Color", each of these color spaces defines a palette of available colors that is larger than the traditional RGB color model.

Audyssey Dynamic EQ®

Audyssey Dynamic EQ® solves the problem of deteriorating sound quality as volume is decreased by taking into account human perception and room acoustics. Audyssey Dynamic EQ® works in tandem with Audyssey MultEQ® to provide well-balanced sound for every listener at any volume level.

Audyssey Dynamic Volume®

Audyssey Dynamic Volume® solves the problem of large variations in volume level between television programs, commercials, and between the soft and loud passages of movies. Audyssey Dynamic EQ® is integrated into Dynamic Volume® so that as the playback volume is adjusted automatically, the perceived bass response, tonal balance, surround impression, and dialog clarity remain the same.

Audyssey MultEQ®

Audyssey MultEQ® is a room equalization solution that calibrates any audio system so that it can achieve optimum performance for every listener in a large listening area. Based on several room measurements, MultEQ® calculates an equalization solution that corrects for both time and frequency response problems in the listening area and also performs a fully automated surround system setup.

Auto Lip Sync

If you connect the unit to a TV that supports the Auto Lip Sync function, it can automatically correct delay between the audio and video.

B

Bluetooth

Bluetooth is a short-distance wireless communication technology used for connecting handheld devices several meters apart. This enables notebook computers, PDA s, mobile phones, etc. to connect without a cable for transmitting audio and data.

D

Deep Color

This technology allows expression of more number of colors than the conventional 8 bits and can reproduce colors close to natural ones without color streak.

Dolby Digital

Dolby Digital is a multi-channel digital signal format developed by Dolby Laboratories.

A total of 5.1 channels are played: 3 front channels ("FL", "FR" and "C"), 2 surround channels ("SL" and "SR") and the "LFE" channel for low frequencies.

Because of this, there is no crosstalk between channels and a realistic sound field with a "three-dimensional" feeling (sense of distance, movement and positioning) is achieved.

A realistic, powerful sense of presence is achieved when playing movie sources in AV rooms as well.

Dolby Digital EX

Dolby Digital EX is a 6.1-channel surround format proposed by Dolby Laboratories that allows users to enjoy in their homes the "DOLBY DIGITAL SURROUND EX" audio format jointly developed by Dolby Laboratories and Lucas Films.

The 6.1 channels of sound, including surround back channels, provide improved sound positioning and expression of space.

Dolby Digital Plus

Dolby Digital Plus is an improved Dolby Digital signal format that is compatible with up to 7.1 channels of discrete digital sound and also improves sound quality thanks to extra data bit rate performance. It is upwardly compatible with conventional Dolby Digital, so it offers greater flexibility in response to the source signal and the conditions of the playback device.

Dolby Pro Logic II

Dolby Pro Logic II is a matrix decoding technology developed by Dolby Laboratories.

Regular music such as that on CDs is encoded into 5 channels to achieve an excellent surround effect. The surround channel signals are converted into stereo and full band signals (with a frequency response of 20 Hz to 20 kHz or greater) to create a "three-dimensional" sound image offering a rich sense of presence for all stereo sources.

Dolby Pro Logic IIx

Dolby Pro Logic IIx is a further improved version of the Dolby Pro Logic II matrix decoding technology. Audio signals recorded in 2 channels are decoded to achieve a natural sound with up to 7.1 channels. There are three modes: "Music" suited for playing music, "Movie" suited for playing movies, and "Game" which is optimized for playing games.

Dolby Pro Logic IIz

Dolby Pro Logic IIz introduces a new dimension to Home Entertainment through the addition of a pair of front height channels. Compatible with stereo, 5.1-channel and 7.1-channel content, Dolby Pro Logic IIz provides enhanced spaciousness, depth and dimension to movies, concert video and video game playback while maintaining the full integrity of the source mix.

Dolby Pro Logic IIz identifies and decodes spatial cues that occur naturally in all content, directing this information to the front height channels, complementing the performance of left and right surround sound speakers. Content that is encoded with Dolby Pro Logic IIz height channel information can be even more revealing, with perceptually discrete height channel information bringing an exciting new dimension to home entertainment.

Dolby Pro Logic IIz, with front height channels is also an ideal alternative for households that cannot support the placement of back surround speakers of a typical 7.1-channel system but may have bookshelf space available to support the addition of height speakers.

Dolby TrueHD

Dolby TrueHD is a high definition audio technology developed by Dolby Laboratories, using lossless coding technology to faithfully reproduce the sound of the studio master.

This format provides the facility to support up to 8 audio channels with a sampling frequency of 96kHz/24bit resolution and up to 6 audio channels with a sampling frequency of 192kHz/24bit resolution. Dolby TrueHD is adopted for applications that put very high importance on sound quality.

Downmix

This function converts the number of channels of surround audio to less number of channels and plays back.

DTS

This is an abbreviation of Digital Theater System, which is a digital audio system developed by DTS. When playing back audio by connecting this system with a device such as DTS amplifier, accurate sound field position and realistic sound effect as if you are in a movie theater can be obtained.

DTS 96/24

DTS 96/24 is a digital audio format enabling high sound quality playback in 5.1 channels with a sampling frequency of 96 kHz and 24 bit quantization on DVD-Video.

DTS Digital Surround

DTS Digital Surround is the standard digital surround format of DTS, Inc., compatible with a sampling frequency of 44.1 or 48 kHz and up to 5.1 channels of digital discrete surround sound.

DTS-ES™ Discrete 6.1

DTS-ES™ Discrete 6.1 is a 6.1-channel discrete digital audio format adding a surround back (SB) channel to the DTS digital surround sound.

Decoding of conventional 5.1-channel audio signals is also possible according to the decoder.

DTS-ES™ Matrix 6.1

DTS-ES™ Matrix 6.1 is a 6.1-channel discrete digital audio format inserting a surround back (SB) channel to the DTS digital surround sound through matrix encoding. Decoding of conventional 5.1-channel audio signals is also possible according to the decoder.

DTS Express

DTS Express is an audio format supporting low bit rates (max. 5.1 channels, 24 to 256 kbps).

DTS-HD

This audio technology provides higher sound quality and enhanced functionality than the conventional DTS and is adopted as an optional audio for Blu-ray Disc. This technology supports multi-channel, high data transfer speed, high sampling frequency, and lossless audio playback. Maximum 7.1-channels are supported in Blu-ray Disc.

DTS-HD High Resolution Audio

DTS-HD High Resolution Audio is an improved version of the conventional DTS, DTS-ES and DTS 96/24 signals formats, compatible with sampling frequencies of 96 or 48 kHz and up to 7.1 channels of discrete digital sound. High data bit rate performance provides high quality sound. This format is fully compatible with conventional products, including conventional DTS digital surround 5.1-channel data.

DTS-HD Master Audio

DTS-HD Master Audio is a lossless audio format created by Digital Theater System (DTS). This format provides the facility to support up to 8 audio channels with a sampling frequency of 96kHz/24bit resolution and up to 6 audio channels with a sampling frequency of 192kHz/24bit resolution. It is fully compatible with conventional products, including conventional DTS digital surround 5.1-channel data.

DTS NEO:6™ Surround

DTS NEO:6™ is a matrix decoding technology for achieving 6.1-channel surround playback with 2-channel sources. It includes “DTS NEO:6 Cinema” suited for playing movies and “DTS NEO:6 Music” suited for playing music.

Dynamic range

The difference between the maximum undistorted sound level and the minimum discernible level above the noise emitted by the device.

H**HDCP**

When transmitting digital signals between devices, this copyright protection technology encrypts the signals to prevent content from being copied without authorization.

HDMI

This is an abbreviation of High-Definition Multimedia Interface, which is an AV digital interface that can be connected to a TV or amplifier. Video signal and audio signal can be connected using 1 cable.

L**LFE**

This is an abbreviation of Low Frequency Effect, which is an output channel that emphasizes low frequency effect sound. Surround audio is intensified by outputting 20 Hz to 120 Hz deep bass.

P**Pairing**

Pairing is an operation required for settings to connect two Bluetooth devices. Pairing enables Bluetooth devices to access each other.

Progressive (sequential scanning)

This is a scanning system of video signal that displays 1 frame of video as one image. Compared to the interlace system, this system provides images with less flickering and bleeding.

Protection Circuit

This is a function to prevent damage to devices within the power supply when an abnormality such as an overload, excess voltage occurs or temperature for any reason.

In this unit, the power indicator blinks and the unit enters standby mode when an abnormality occurs.

S**Sampling frequency**

Sampling involves taking a reading of a sound wave (analog signal) at regular intervals and expressing the height of the wave at each reading in digitized format (producing a digital signal).

The number of readings taken in one second is called the “sampling frequency”. The larger the value, the closer the reproduced sound is to the original.

Speaker impedance

This is an AC resistance value, indicated in Ω (ohms). Greater power can be obtained with this value smaller.

sYCC601 color

Like “x.v.Color”, each of these color spaces defines a palette of available colors that is larger than the traditional RGB color model.

X**x.v.Color**

This function lets HDTVs display colors more accurately. It enables display with natural, vivid colors. “x.v.Color” is a Sony registered trademark.

Troubleshooting

If a problem should arise, first check the following:

1. Are the connections correct?



2. Is the set being operated as described in the owner's manual?

3. Are the other devices operating properly?

If this unit does not operate properly, check the items listed in the table below. Should the problem persist, there may be a malfunction.

In this case, disconnect the power immediately and contact your store of purchase.



[General]

Symptom	Cause/Solution	Page
Power does not turn on.	<ul style="list-style-type: none"> Check whether the power plug is correctly inserted into the power outlet. The protection circuit is active. Disconnect the power plug from the electric outlet, wait 5 to 10 seconds and then insert it back into the outlet. 	 5 86
	<ul style="list-style-type: none"> Set "Display" on the menu to something other than "OFF". 	60
The power indicator is blinking red in intervals of approximately 2 seconds.	<ul style="list-style-type: none"> The temperature inside the unit has risen. Please turn off power once, and re-apply the power after the temperature has fallen sufficiently. Please re-install this unit in a place having good ventilation. 	- -
	<ul style="list-style-type: none"> Please use speakers which have the specified impedance. The speaker cable has shorted (is touching). Firmly twist the core wire in the speaker cable, and then re-connect it to the speaker terminal. 	 6 , 31  6
After turning on the power, the power indicator is blinking red in intervals of approximately 0.5 seconds.	<ul style="list-style-type: none"> This unit amplifier circuit has failed. Turn off the power and please contact the marantz service adviser. 	-
Set does not operate properly.	<ul style="list-style-type: none"> Reset the microprocessor. 	89

[HDMI]

Symptom	Cause/Solution	Page
No audio is output with HDMI connection.	<ul style="list-style-type: none"> Check the connection of the HDMI connectors. When outputting HDMI audio from the speakers, set "HDMI Audio Out" on the menu to "AMP". When outputting HDMI audio from a TV, set "HDMI Audio Out" on the menu to "TV". 	6 58 58
No video is output with HDMI connection.	<ul style="list-style-type: none"> Check the connection of the HDMI connectors. Set the input source to match the connected HDMI connector. Check whether the TV is compatible with copyright protection (HDCP). If connected to a device not compatible with HDCP, video will not be output correctly. 	6 6 , 18 5
When the following operations are performed on devices compatible with HDMI control, the same operations occur on this unit. <ul style="list-style-type: none"> Power ON/OFF Switching audio output devices Adjust volume Switch input source 	<ul style="list-style-type: none"> Set "HDMI Control" in the menu to "OFF". <p>Furthermore, if you do not want to link the power off operation with devices compatible with HDMI control, set "P.Off Control" in the menu to "OFF".</p>	38 , 58

[Video]

Symptom	Cause/Solution	Page
No picture appears.	<ul style="list-style-type: none"> Check the TV connection. Set the TV input correctly. 	 3  3

[Audio]

Symptom	Cause/Solution	Page
Audio is not output.	<ul style="list-style-type: none"> • Check the connections for all devices. • Check the speaker connections and configurations. • Check whether the audio device power is turned on. • Adjust the master volume. • Cancel the mute mode. • Select a suitable input source. • Select a suitable input mode. • Disconnect the headphones. No sound is output from the speakers when headphones are connected. 	3 , 6 , 7 , 8 , 9 , 10 6 , 55 , 56 – 19 19 18 66 74
No sound is produced from surround speaker.	<ul style="list-style-type: none"> • Check if the surround speakers are connected to the SURROUND terminals. 	–
No sound is produced from surround back speaker.	<ul style="list-style-type: none"> • Check if "Pre Assign" is set appropriately in order to output audio from the surround back speakers. • Set "Speaker Config." – "S.Back" on the menu to something other than "None". • Set the surround mode to something other than "STEREO" and "VIRTUAL". 	55 55 24
No sound is produced from front height speaker.	<ul style="list-style-type: none"> • Check if "Pre Assign" is set appropriately in order to output audio from the front height speakers. • Set "Speaker Config." – "F.Height" on the menu to something other than "None". 	55 56
No sound is produced from subwoofer.	<ul style="list-style-type: none"> • Check the subwoofer connections. • Turn on the subwoofer's power. • Set "Speaker Config." – "Subwoofer" on the menu to "Yes". • If "Front" and "Center" for "Speaker Config." are set to "Large", and "Subwoofer Mode" is set to "LFE", no sound may be output from the subwoofers, depending on the input signal or selected surround mode. 	6 , 31 , 32 – 55 55 , 56
DTS sound is not output.	<ul style="list-style-type: none"> • Set "Decode Mode" on the menu to "Auto" or "DTS". 	66
Dolby TrueHD, DTS-HD, Dolby Digital Plus audio is not output.	<ul style="list-style-type: none"> • Make HDMI connections. 	6

Symptom	Cause/Solution	Page
Dolby PLII mode or DTS NEO:6 mode cannot be selected.	<ul style="list-style-type: none"> • Check that "Speaker Config." – "Center" or "Surround" is set to other than "None". If the speaker system is 2.0/2.1ch, this surround mode cannot be selected. • When headphones are used, Dolby PLII or DTS NEO:6 cannot be selected. 	55 –
Audyssey MultEQ®, Audyssey Dynamic EQ® and Audyssey Dynamic Volume® cannot be selected.	<ul style="list-style-type: none"> • Switch the surround mode to other than "DIRECT" or "PURE DIRECT". • When headphones are used, MultEQ®, Dynamic EQ® and Dynamic Volume® cannot be selected. 	24 –
Dynamic EQ® and Dynamic Volume® cannot be selected.	<ul style="list-style-type: none"> • Run Audyssey® Auto Setup. 	11 , 35
M-DAX cannot be selected.	<ul style="list-style-type: none"> • Check that an analog signal or PCM signal (fs=44.1/48 kHz) is input. For playback of multichannel signals such as Dolby Digital or DTS surround, M-DAX cannot be used. • Switch the surround mode to other than "DIRECT" or "PURE DIRECT". 	52 24

[Radio]

Symptom	Cause/Solution	Page
Reception fails, or there is a lot of noise or distortion.	<ul style="list-style-type: none"> • Change the antenna orientation or position. • Separate the AM loop antenna from the unit. • Use an FM outdoor antenna. • Separate the antenna from other connection cables. 	9 9 9 9

[M-XPort]

Symptom	Cause/Solution	Page
Audio is not output when a wireless receiver (RX101 is connected).	<ul style="list-style-type: none">• Check that the Bluetooth device and Wireless receiver (RX101) are correctly paired.	10 , 86

[Remote Control Unit]

Symptom	Cause/Solution	Page
The set cannot be operated with the remote control unit.	<ul style="list-style-type: none">• Batteries are worn out. Replace with new batteries.• Operate the remote control unit within a distance of about 7 m from this unit and at an angle of within 30°.• Remove any obstacle between this unit and the remote control unit.• Insert the batteries in the proper direction, checking the ⊕ and ⊖ marks.• The set's remote control sensor is exposed to strong light (direct sunlight, inverter type fluorescent bulb light, etc.). Move the set to a place in which the remote control sensor will not be exposed to strong light.• The operation mode does not match the settings of the device to operate. Check the operation mode.	78 78 78 78 68

Resetting the microprocessor

Perform this procedure if the display is abnormal or if operations cannot be performed. When the microprocessor is reset, all the settings are reset to their default values.

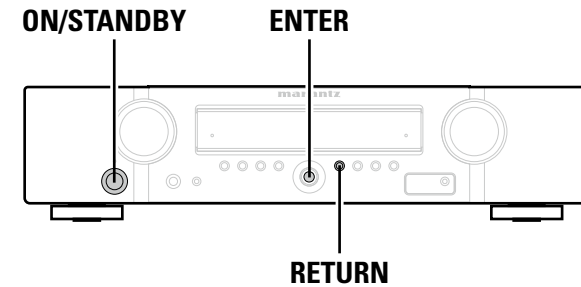

- 1 Turn off the power using ON/STANDBY.**
- 2 Press ON/STANDBY while simultaneously pressing ENTER and RETURN.**
- 3 Once the display starts flashing at intervals of about 1 second, release the two buttons.**



If in step 3 the display does not flash at intervals of about 1 second, start over from step 1.

Specifications

□ Audio section

• Power amplifier

Rated output:

Front:
50 W + 50 W (8 Ω, 20 Hz – 20 kHz with 0.08 % T.H.D.)

Center:
50 W (8 Ω, 20 Hz – 20 kHz with 0.08 % T.H.D.)

Surround:
50 W + 50 W (8 Ω, 20 Hz – 20 kHz with 0.08 % T.H.D.)

Maximum effective output power:

Front:
75 W + 75 W (6 Ω, 1 kHz with 10 % T.H.D.)

Center:
75 W (6 Ω, 1 kHz with 10 % T.H.D.)

Surround:
75 W + 75 W (6 Ω, 1 kHz with 10 % T.H.D.)

• Output connectors:

6 – 8 Ω

• Analog

Input sensitivity/Input impedance: 130 mV/47 kΩ

Frequency response: 10 Hz – 100 kHz — +1, –3 dB (DIRECT mode)

S/N: 98 dB (IHF–A weighted, DIRECT mode)

□ Video section

• Standard video connectors

Input/output level and impedance: 1 Vp-p, 75 Ω

Frequency response: 5 Hz – 10 MHz — 0, –3 dB

• Color component video connector

Input/output level and impedance: Y (brightness) signal — 1 Vp-p, 75 Ω

P_B / C_B signal — 0.7 Vp-p, 75 Ω

P_R / C_R signal — 0.7 Vp-p, 75 Ω

Frequency response: 5 Hz – 60 MHz — 0, –3 dB

□ Tuner section

	[FM]	[AM]
Receiving Range:	87.5 MHz – 108.0 MHz	522 kHz – 1611 kHz
Usable Sensitivity:	1.2 μV (12.8 dBf)	18 μV
50 dB Quieting Sensitivity:	MONO 2.0 μV (17.3 dBf)	
	STEREO 42 μV (34.5 dBf)	
S/N (IHF-A):	MONO 72 dB (IHF–A weighted, DIRECT mode)	
	STEREO 67 dB (IHF–A weighted, DIRECT mode)	
Total harmonic Distortion (at 1 kHz):	MONO 0.3 %	
	STEREO 0.7 %	

□ General

Power supply: AC 230 V, 50/60 Hz

Power consumption: 180 W

0.2 W (Standby)

3 W (CEC standby)

For purposes of improvement, specifications and design are subject to change without notice.

Index

Numerics

2.1-channel	30, 34
3D	5
6.1-channel	30, 33
7.1-channel	29, 30, 31, 32

A

A2DP	10, 85
Accessories	1
Adjust Channel	52
Adjusting the master volume	19
Adobe RGB color / Adobe YCC601 color	85
AM loop antenna	9
ARC	5
Audio Adjust	48
Audio Delay	52
Audio Setup	59
Audyssey® Auto Setup	11, 35
Audyssey Dynamic EQ®	51, 85
Audyssey Dynamic Volume®	51, 85
Audyssey MultEQ®	50, 85
Audyssey Settings	50
Auto Lip Sync	58, 85
Auto Preset	63
Auto Setup	11, 35

B

Bass	50
Bass Setting	56
Bluetooth	10, 85

C

Cable	
Audio cable	7, 8, 9
Coaxial digital cable	7
Component video cable	7
HDMI cable	6
Optical cable	9
Stereo mini plug cable	8
Video cable	7, 8
Channel Level	40, 41, 57
Characters	46
C.Image	49
Condensation	2

Connection	
Antenna	9
Blu-ray Disc player	6, 7
Cable TV	8
CD player	9
DVD player	6, 7
Game console	6
HDMI	5
Portable audio player	8
Remote control jacks	37
Satellite tuner	8
Set-top box	6, 8
Speaker	31
TV	6, 7
Wireless receiver	10
Content Type	5
Crossover Freq.	57
Curve Copy	52
C.Width	49

D

D.Comp	49
Decode Mode	66
Deep Color	5, 85
Dimension	49
Display	60, 75
Distance	56
Dolby	
Dolby Digital	85
Dolby Digital EX	85
Dolby Digital Plus	85
Dolby Pro Logic II	85
Dolby Pro Logic IIx	85
Dolby Pro Logic IIz	29, 85
Dolby TrueHD	85
Downmix	85
DRC	49
DTS	85
DTS 96/24	85
DTS Digital Surround	85
DTS-ES Discrete 6.1	85
DTS-ES Matrix 6.1	85
DTS Express	86
DTS-HD	86
DTS-HD High Resolution Audio	86
DTS-HD Master Audio	86
DTS NEO:6™ Surround	86
Dual backup memory function	41
Dynamic EQ®	51
Dynamic range	86
Dynamic Volume®	51

E

EQ Customize	59
Error messages (Auto Setup)	16

F

Fader function	40
F.Height	56
FM/AM	20
FM indoor antenna	9
Front height speaker	30, 32
Front Panel	74

G

GUI	60
-----	----

H

HDCP	5, 86
HDMI	5, 86
HDMI 1.4a	5
HDMI Audio Out	58
HDMI Control	38, 58
HDMI Setup	58
Headphones	74
Height Gain	49
HT-EQ	49

I

Information	53
Audio Signal	53
HDMI Information	53
Status	53
Input Assign	64
Input Mode	66
Input Setup	62
Input signal	82
Inputting characters	46

L

Language	61
LFE	49, 86
Listening mode	24
Listening position	11

M

Manual EQ	52
Master volume	60
M-DAX	52
Menu map	43
MultEQ®	50
Mute Level	59

O

Option Setup	59
Display	60
GUI	60
Setup Lock	60
Source Delete	59
Volume Control	59

P

Pairing	86
Panel lock function	41
Panorama	49
Parameter Check	17
Playback	
Blu-ray Disc player	19
CD player	19
Direct	27
DVD player	19
FM/AM	20
PTY	22
Pure direct	27
RDS	21
RT	23
Stereo	27
TP	22
P.Off Control	58
Power On Level	59
Pre Assign	55
Preset codes	69
Preset Name	63
Preset Skip	63
Presetting radio stations	20
Progressive	86
Protection circuit	86
PTY	22

R	
RDS	21
Rear panel	76
Reference Offset	51
Remote control settings	67
Remote control unit	68, 77
Inserting the batteries	78
Operating AV devices	68
Operating devices	71
Registering Preset Codes	69
Rename	66
Resetting the microprocessor	89
RT	23

S	
Sampling frequency	86
Screensaver	60
Selecting the input source	18
Setup Lock	60
Sleep timer	39
Source Delete	59
Source Level	66
Speaker	
Connect	31
Install	29
Set up	11, 35
Speaker Config.	55
Speaker impedance	86
Speaker Setup	55
Standby Source	58
Subwoofer setting	12
Surround back speaker	29, 30, 31, 33
Surround mode	24, 80
Surr.Parameter	49
sYCC601 color	86
System Setup	54

T	
Tone	50
Tone Control	50
TP	22
Trademark	79
Treble	50
Troubleshooting	87
Turning off the sound temporarily	19

V	
Video	65
Video Mode	65
Video Select	65
Volume Control	59
Volume Display	59
Volume Limit	59

X	
x.v.Color	5, 86

List of preset codes

Device select : BD

Blu-ray Disc Player

D	Denon	5034, 5035, 5036
H	Hitachi	5031, 5032, 5033
I	Integra	5013
J	JWC	5014, 5015, 5017, 5018, 5019, 5020
L	LG	5010, 5011
M	marantz	5000, 5026, 5027
	Mitsubishi	5024, 5025
O	Onkyo	5013
P	Panasonic	5001, 5002, 5003
	Philips	5004
	Pioneer	5005
R	RCA	5012
S	Samsung	5005
	Sharp	5028, 5029, 5030
	Sony	5007, 5008, 5009, 5016
T	Toshiba	5012
Y	Yamaha	5021, 5022, 5023

Device select : DVD

DVD Player

A	Aiwa	2036, 2037
	Apex	2012, 2017, 2018, 2019, 2021, 2034
B	BOSE	2038, 2039, 2063
D	Denon	2047, 2048
F	Funai	2049
G	GE	2009, 2020, 2029, 2033
H	Harman Kardon	2061
	Hitachi	2008, 2012, 2031
J	JVC	2006, 2010, 2040, 2041, 2042, 2043
K	Kenwood	2053, 2054
	Koss	2058
M	Magnavox	2007, 2011, 2023, 2025
	marantz	2025, 2065
	Mitsubishi	2011, 0215
O	Onkyo	2062
	Oritron	2009, 2030
P	Panasonic	2003, 2015, 2016, 2055
	Philips	2007, 2011, 2058
	Pioneer	2002, 2014, 2056
	Proscan	2009, 2020, 2032
R	RCA	2005, 2009, 2020, 2035, 2057

S	Sampo	2041
	Samsung	2008, 2012, 2022, 2024, 2027
	Sanyo	2050, 2052
	Sharp	2044, 2045
	Sherwood	2051
	Sony	2001, 2013, 2059
T	Toshiba	2004, 2008, 2026, 2028
Y	Yamaha	2046, 2060
Z	Zenith	2010

Device select : SAT

Satellite Receiver

A	Alphastar	4027
	Amstrad	4047, 4050
	Atsky	4048
B	B Sky B	4021, 4045
C	Chaparral	4039
D	DIRECTV	4001, 4016
	DISH Network	4030
	Drake	4026
E	EchoStar	4007, 4017, 4018, 4019, 4020
	Eurosky	4047, 4056
	Express Vu	4017
F	Foxtel	4051
	Fujitsu	4025
G	GE	4002, 4008, 4009
	General Instruments	4036, 4037
	Gradiente	4044, 4057
H	Hitachi	4001, 4015
	Hughes	4001, 4016
	Humax	4049, 4050, 4051
J	Janeil	4025
	JVC	4017
M	Mitsubishi	4001
O	Optima	4048
P	Panasonic	4004, 4010
	Philips	4031, 4035, 4044, 4057
	Proscan	4002, 4008, 4009, 4011
R	Radio Shack	4036, 4037
	RCA	4002, 4008, 4009, 4029
	Realistic	4040
	Rural Cable	4036
S	Samsung	4022, 4027, 4050
	Schneider	4041
	SKY	4044, 4045, 4057
	Skyplus	4048

	Skysat	4041, 4047, 4056
	Sony	4003, 4012, 4014
	Star Choice	4032
	Star Trak	4024
	STS	4038
	SuperDish	4028
T	Teac	4049
	Thomson	4056
	Toshiba	4001, 4034
U	Uniden	4005, 4006, 4013
	Universum	4056
V	Video Pall	4025
Z	Zenith	4023, 4025, 4033

Device select : TV

Television

A	Acer	1141
	Admiral	1002, 1009, 1089
	Aiko	1059
	Aiwa	1117, 1118
	Akai	1001
	Amtron	1023
	Anam	1113
	Anam National	1023, 1069, 1092
	AOC	1003, 1024, 1049, 1127
	Audiovox	1023
B	Bell & Howell	1009, 1025
	Benq	1104, 1142
	Broksonic	1003, 1097, 1098, 1113
C	Celebrity	1001
	Citizen	1003, 1013, 1023, 1026, 1059, 1063
	Colortyme	1003, 1043
	Contec	1113
	Contec/Cony	1023, 1045, 1047
	Craig	1020, 1022, 1023, 1113
	Crown	1023, 1067
	Curtis Mathes	1003, 1013, 1025, 1026, 1062, 1103, 1110
D	Daewoo	1003, 1013, 1024, 1035, 1036, 1059, 1084, 1101
	Daytron	1003, 1013, 1016
	Dimensia	1103, 1110
	Dumont	1003, 1010, 1153
E	Electroband	1001
	Electrohome	1001, 1003, 1069, 1133
		1003, 1013, 1015, 1020, 1021, 1022, 1023, 1025, 1038, 1044, 1045, 1048, 1055, 1061, 1094, 1096, 1099, 1101, 1113

	Envision	1003
F	Fisher	1025, 1051, 1091, 1160
	Fujitsu	1038, 1124, 1125, 1155
	Funai	1023, 1038, 1113
G	Gateway	1150
	GE	1003, 1018, 1022, 1046, 1054, 1069, 1085, 1103, 1110, 1113, 1133, 1136, 1153
	Goldstar	1003, 1013, 1024, 1030, 1045, 1080, 1100
		1112, 1154
H	Hallmark	1003
	Hisense	1116
	Hitachi	1003, 1012, 1031, 1032, 1037, 1041, 1045, 1047, 1065, 1068, 1082, 1088, 1094, 1139, 1140, 1145, 1159
I	Infinit	1067
J	Janeil	1134
	JBL	1067
	JC Penney	1003, 1013, 1018, 1019, 1024, 1026, 1046, 1047, 1054, 1063, 1083, 1085, 1100, 1103, 1110, 1112, 1133, 1154
	Jensen	1003
	JVC	1028, 1029, 1045, 1047, 1050, 1060, 1065
K	Kawasho	1001, 1003
	Kenwood	1003
	Kloss Novabeam	1023, 1056, 1057, 1134
	KTV	1013, 1023, 1033, 1034, 1073, 1099, 1113
L	LG	1024, 1030
M	M.Wards	1002, 1009, 1038
	Magnavox	1003, 1052, 1053, 1056, 1057, 1063, 1067, 1081, 1106
	marantz	1003, 1031, 1067, 1122
	Mitsubishi	1003, 1024, 1051, 1115, 1122, 1133
	Motorola	1014, 1069
N	NEC	1003, 1012, 1024, 1043, 1069
	NET-TV	1137, 1150
O	Orion	1020, 1096
P	Panasonic	1017, 1067, 1069, 1095, 1111
	Philips	1003, 1011, 1045, 1052, 1054, 1056, 1057, 1058, 1063, 1067, 1069, 1106
	Pioneer	1003, 1018, 1037, 1070, 1071, 1094, 1145, 1147, 1149
	Plasm SYNC	1135
	Portland	1003, 1013, 1024, 1059
	Price Club	1026
	Prism	1018
	Proscan	1004, 1005, 1006, 1007, 1008, 1085, 1103, 1110
	Proton	1003, 1045
Q	Quasar	1010, 1069, 1073, 1111, 1153

R	Radio Shack	1003, 1013, 1015, 1023, 1024, 1025, 1045, 1100, 1103, 1110, 1113
		1003, 1004, 1005, 1006, 1007, 1008, 1014, 1024, 1049, 1069, 1075, 1079, 1085, 1087, 1088, 1093, 1094, 1101, 1103, 1110, 1113, 1153
	RCA	1013, 1015, 1023, 1025, 1045, 1100, 1103, 1110
	Realistic	1013, 1015, 1023, 1025, 1045, 1100, 1103, 1110
	Runco	1010, 1153
S	Sampo	1150
	Samsung	1003, 1013, 1024, 1026, 1040, 1045, 1062, 1078, 1083, 1090, 1100, 1105, 1114, 1120, 1121, 1146, 1148, 1157
	Sansui	1119
	Sanyo	1003, 1025, 1051, 1072, 1077, 1091, 1156, 1157, 1158
	Sharp	1003, 1013, 1014, 1015, 1045, 1055, 1064, 1066, 1076, 1089, 1123
	Signature	1009
	Sony	1001, 1102, 1108
	Soundesign	1003, 1023, 1038, 1063, 1113
	Starlite	1023
	Supre-Macy	1134
	Sylvania	1003, 1039, 1042, 1052, 1053, 1056, 1057, 1063, 1067, 1089, 1151
	Symphonic	1023, 1039, 1044
T	Tandy	1014
	Tatung	1069
	Technics	1018
	Techwood	1003, 1018
	Teknika	1003, 1009, 1013, 1023, 1024, 1026, 1038, 1045, 1047, 1059, 1063, 1111, 1113
	Telecaption	1074
	Toshiba	1003, 1019, 1025, 1026, 1042, 1074, 1098, 1107, 1111, 1135, 1136
	Totevision	1013
U	Universal	1046, 1054
V	Video Concepts	1113
	Viewsonic	1006, 1022, 1109, 1128, 1129, 1130, 1131, 1138, 1143, 1145, 1150
W	Wards	1003, 1009, 1015, 1024, 1038, 1044, 1046, 1052, 1054, 1056, 1057, 1067, 1086, 1103, 1110
	White Westinghouse	1001, 1101
Y	Yamaha	1003, 1024
Z	Zenith	1003, 1009, 1010, 1132, 1144, 1153

Device select : CD

CD Player

A	AIWA	3001
	AKAI	3004
	AUDIO	3007
	AUDIO LABS	3008
C	CALIFORNIA	3008
	CARVER	3010, 3011, 3009
	CASIO	3012, 3020
	Curtis	3020, 3012
D	Denon	3013
E	Emerson	3014
F	FISHER	3011, 3016, 3018
G	GE	3019
	GENEXXA	3014, 3021, 3020
H	HARMON	3022, 3023, 3051
	Hitachi	3020
I	INKEL	3024
J	JC penney	3012, 3020, 3025
	JVC	3026, 3027
K	KARDON	3022, 3051, 3023
	Kenwood	3028
	KRELL	3010
L	LUXMAN	3035, 3036, 3037, 3038
	LX I	3012, 3020, 3014
M	Magnavox	3010, 3039, 3040
	marantz	3010, 3041, 3042, 3043
	MATHES	3012, 3020
	MCS	3012, 3020
	MGA	3023
	MISSION	3010
	Mitsubishi	3023
N	NAD	3034, 3045
	NAKAMICHI	3046
	NEC MCS	3025
	NIKKO	3007, 3016
O	Onkyo	3049, 3050, 3051, 3052, 3055, 3102, 3103
	OPTIMUS	3011, 3014, 3020, 3028, 3054, 3056, 3057
P	Panasonic	3008, 3060, 3061
	Philips	3009, 3010, 3010, 3040
	Pioneer	3020, 3021, 3062, 3063, 3064
Q	Quasar	3008
R	RCA	3011, 3014, 3068
	Realistic	3011, 3014, 3020, 3042, 3054, 3057
	ROTEL	3010
	RS ORIGINAL	3070
S	SAE	3010, 3083
	Samsung	3071

	Sansui	3014, 3068
	Sanyo	3011, 3018
	SCOTT	3014
	SEARS	3012, 3014, 3020, 3028, 3042
	Sharp	3028, 3042
	Sherwood	3042, 3056, 3070, 3024
	SHURE	3025
	Sony	3039, 3079, 3080, 3081, 3082, 3097, 3098, 3099, 3100, 3101
	Sylvania	3010
	Symphonic	3083
T	Teac	3016, 3042, 3057, 3083, 3084, 3085, 3086
	TECHNICA	3007, 3008, 3061
	THETA DIGITAL	3040
	Toshiba	3045
V	Victor	3026
Y	Yamaha	3007, 3089, 3090, 3091, 3092
Z	Zenith	3016

Dimensions

Unit : mm

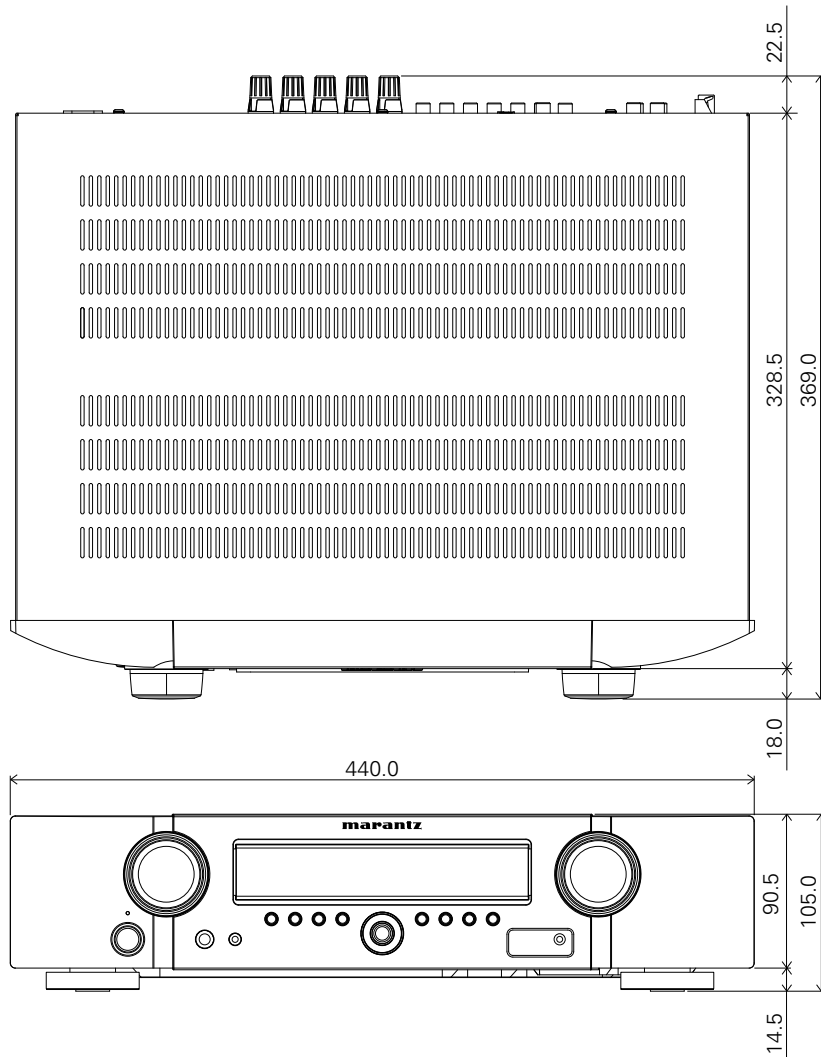

Weight : 8.2 kg

www.marantz.com

You can find your nearest authorized distributor or dealer on our website.

marantz[®] is a registered trademark.