

UHF BAND

WIRELESS MICROPHONE SYSTEM

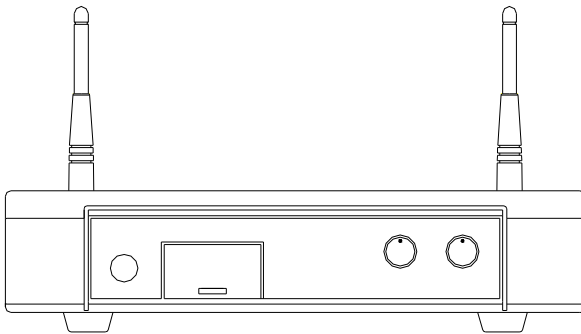
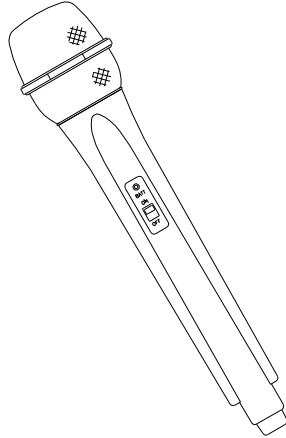

WIRELESS MICROPHONE SYSTEM

Table of Contents

1. Introduction	1
2. Safety	1
3. Environment	1
4. Wireless Top Ten	1
5. Product Description	2
5.1 Receiver	
5.2 Handheld Microphone	
5.3 Bodypack Transmitter	
6. Basic Connections	7
7. Setting Up	8
7.1 Connecting the receiver to a mixer or an amplifier	
7.2 Connecting the receiver to power	
7.3 Inserting batteries into the handheld / bodypack transmitter	
7.4 Setting up the handheld transmitter	
7.5 Setting up the bodypack transmitter	
8. Trouble-shooting	9
9. System Feature	10
10. System Specification	10



FCC Statement

This device complies with part 15 of the FCC rules. Operation is subject to the following two conditions: (1) This device may not cause harmful interference and (2) This device must accept any interference received, including interference that may cause undesired operation

Notice : The changes or modifications not expressly approved by the party responsible for compliance could void the user's authority to operate the equipment.

IMPORTANT NOTE: To comply with the FCC RF exposure compliance requirements, no change to the antenna or the device is permitted. Any change to the antenna or the device could result in the device exceeding the RF exposure requirements and void user's authority to operate the device.

1. Introduction

Thank you for purchasing our product. This wireless microphone system operates in UHF band frequency with synthesizer controlled. Each system with 15 or 16 selectable frequencies via Phase Locked Loop (PLL) circuitry makes it easy to choose non-interfered channels. Please read this instruction manual carefully before operating the system. This manual covers the function and operation of the wireless microphone system.

2. Safety

- Do not spill liquid on the appliance and do not drop it on a hard concrete floor.
- Do not place the appliance near heat sources such as radiators, amplifier, or etc. Do not expose it to direct sunlight, extremely dust, excessive moisture, or vibration.
- Take out the battery from transmitter, if the appliance has been not used for a longer period. This will avoid the damage resulting from a defective leaking battery

3. Environment

- Do not throw used batteries into a fire or garbage bin with domestic rubbish. Be sure to dispose of used batteries in accordance with local waste disposal rules.
- When disposing the equipment, remove the batteries, separate the case, circuit boards, and cables, and dispose of all components in accordance with local waste disposal rules.

4. Wireless Note

- Before setting up, make sure that the transmitter and receiver are tuned to the same frequency.
- Do not use two transmitters in the same frequency.
- Use good quality batteries to avoid the damage resulting from a defective leaking battery.
- Turn the volume control on the receiver to adjust receiver output level to match input level requirements of a mixer or amplifier.
- If undesirable noise occurs, adjust the antenna or SQUELCH control on receiver in clockwise to suppress it. The higher squelch control, the lower the sensitivity of the receiver and decrease the service area of the system.
- To avoid interference, do not put the receiver too near metal object and avoid obstructions between transmitter and receiver.
- Avoid the interference from TV, radio, other wireless appliances and etc.

**UHF**

Wireless Microphone

5. Product Description

5.1 Receiver

The stationary receivers are used with all our 16-channel selectable transmitters. The receiver operates in UHF band frequency with PLL synthesized control. Powered by 12V DC.

Single Channel, Diversity

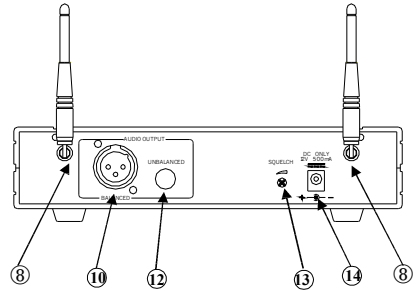
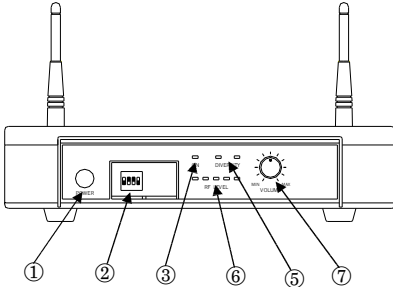

Single Channel, Non-Diversity

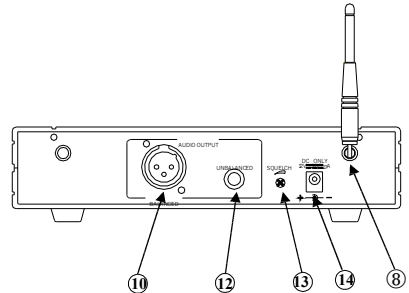
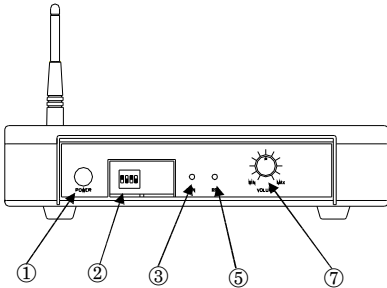

Dual Channel, Non-Diversity

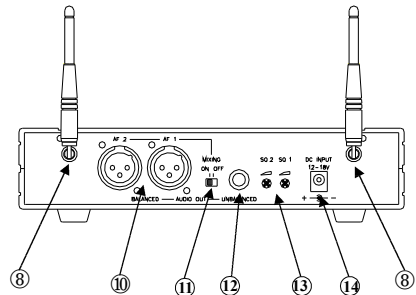
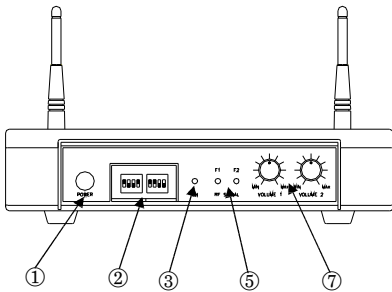

Dual Channel, Diversity

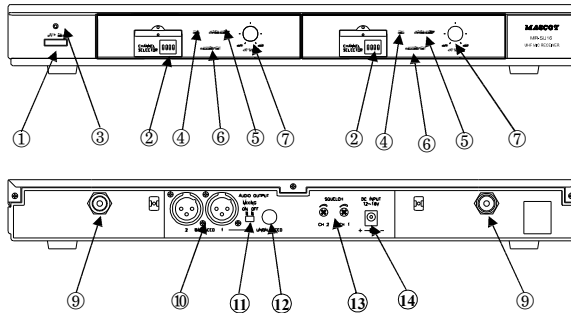

1. **Power:** Power on pushbutton switch.
2. **Channel Selector:** 15 or 16 different selectable frequencies as below.

CH 1	CH 2	CH 3	CH 4
CH 5	CH 6	CH 7	CH 8
CH 9	CH 10	CH 11	CH 12
CH 13	CH 14	CH 15	CH 16

3. **Power Indicator:** The indicator LED lights when the receiver is ready to operate.
4. **AF Indicator:** The indicator glows to indicate that audio signal has been received.
5. **RF Indicator:** This LED lights to indicate that signal is being received.
6. **RF Level Indicators:** Five LEDs per RF antenna channel glow to indicate RF signal strength. The more LEDs that glow, the stronger the received signal. If none of these LEDs glow, no signal is being received.
7. **Level Control:** This rotary control adjusts the receiver's output level from the microphone to line level for matching the input sensitivity of the mixer or amplifier.
8. **Antenna:** Fixed-length UHF antenna permanently mounted either on the front or on rear panel.
9. **Antenna Input Connector:** TNC-type connectors provide connection to the supplied antennas or to coaxial cable used with an antenna divider, antenna boosters or remote antennas.
10. **Balanced Output:** Balanced 3-pin XLR audio output for connecting to, e.g., a microphone input on a mixing console.
11. **Unbalanced Output:** Unbalanced 6.3mm mono jack audio output for connecting to, e.g., a guitar amplifier.
12. **Mixing Switch:** When the MIXING switch is in the OFF position, the XLR output for channels 1 and 2 are separate. When the MIXING switch is in the ON position, the XLR output for channels 1 and 2 are mixed, so that both XLR outputs have combined signal from both channel 1 and channel 2.



13. **Squelch Adj. :** The squelch adjusts the output level to prevent from the external noise. Setting the squelch too high will reduce the range of the system. Set the squelch to minimum before turning the receiver on.
14. **DC Jack:** DC input connector for the supplied AC adapter.

To combine two receivers in a 19" standard rack by using 2 short L type plastics racks (L2) and 2 metal connecting plates (C1). (Each system includes a L2 and a C1.)

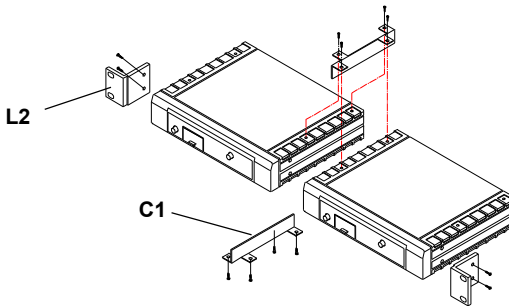

To mount a receiver in a 19" standard rack by using 2 L type long metal racks (L1). (L1 is an optional product, so please purchase extra in local shops.)

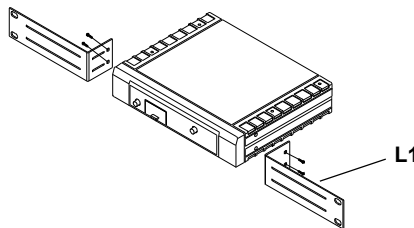

5.2 Handheld Microphone

The handheld microphone operates in UHF band frequency with PLL synthesized control. UHF 16 preprogrammed selectable frequencies to avoid interference. Uni-directional dynamic or uni-directional condenser capsules with different characters for various choices. Use 1.5V x 2 AA size batteries for low operating cost.

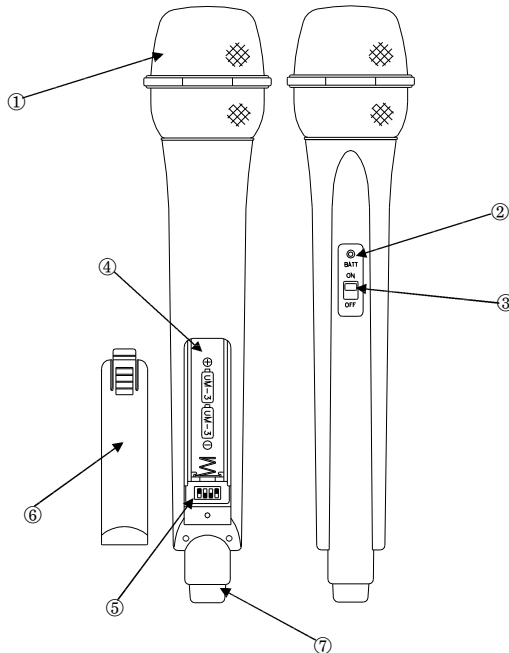

1. **Grille:** Protects the microphone capsule and helps reduce breath sounds and wind noise. The grille for the various microphone capsules differ in appearance.
2. **Low Battery LED:** LED indicates battery life status. Switching the power to "ON", the LED flashing once indicates that the transmitter has sufficient power. If the LED stayed on, it indicates that the battery has insufficient power and should be changed soon. If the status LED fails to flash, the battery is either dead or not positioned correctly, and you should correct the positioning or change the battery.
3. **On/off Switch:** Turns transmitter power on and off.
4. **Battery Compartment:** Insert two AAA batteries into the compartment and make sure that the polarity of batteries is correct.
5. **Channel Selector:** Changes transmitter Channel setting.
6. **Battery Cover:** Push to expose battery compartment and Group/Channel selector.
7. **Antenna:** Built-in high gain helical antenna.



UHF

Wireless Microphone

5.3 Bodypack Transmitter

The bodypack transmitter operates in UHF band frequency with PLL synthesized control. UHF 16 preprogrammed selectable frequencies to avoid interference. Uni-directional condenser capsules with different characters for various choices. Use 1.5V x 2 AA size batteries for low operating cost.

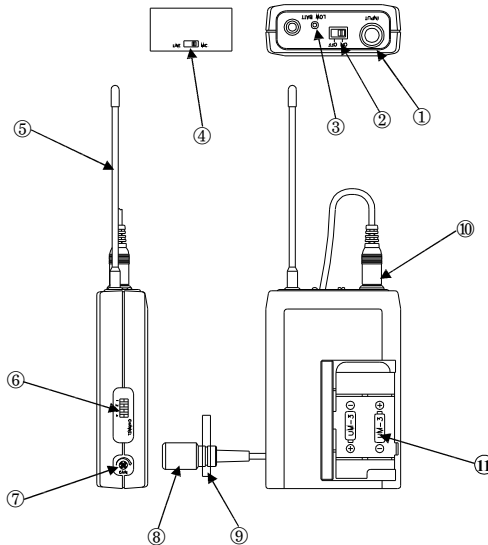

1. **Mini XLR /3.5φ connector:** The included electret lapel microphone is inserted into the connector on transmitter.
2. **On/Off Switch:** Turns transmitter power on and off.
3. **Low Battery LED:** LED indicates battery life status. Switching the power to "ON", the LED flashing once indicates that the transmitter has sufficient power. If the LED stayed on, it indicates that the battery has insufficient power and should be changed soon. If the status LED fails to flash, the battery is either dead or not positioned correctly, and you should correct the positioning or change the battery.
4. **Mic/Line Selector (optional for use with mini XLR connector) :** The switch sets the audio input either to microphone level or line level.
5. **Antenna:** Permanently connected, helical antenna.
6. **Channel Selector:** Changes transmitter Channel setting.
7. **Gain:** The rotary control adjusts the sensitivity of the transmitter's audio to the level of the connected lapel microphone or instrument.
8. **Mic Unit:** The uni-directional electret condenser unit features the wide frequency response for warm, rich bass and clear sound.
9. **Tie Clip:** To clip on the tie or lapel for free-movement.
10. **Cable:** With mini XLR jack or 3.5φ screw type plug cable to connect the transmitter.
11. **Battery Compartment:** Insert two AA batteries into the compartment and make sure that the polarity of batteries is correct.

6. Basic Connections

Connect the receiver output to the mixer or amplifier input, using a standard audio cable with 3-pin XLR connectors or 6.3 ϕ phone plugs. Never use the balanced and unbalanced audio outputs at the same time! This may cause signal loss or increased noise.

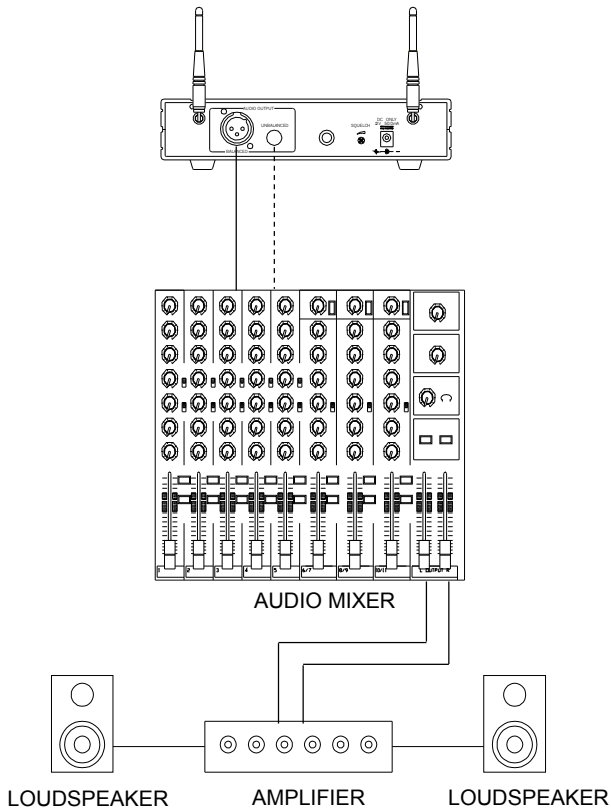

7. Setting Up

NOTICE: Prior to setting up, check that the transmitter and receiver are tuned to the same frequency. Two or above transmitters operating in the same frequency can not be used at the same time and area, so please select the different frequencies which can be used simultaneously at local area.

7.1 Connecting the receiver to an audio mixer or an amplifier

In order to make sure the sound quality and avoid distortion, please adjust the volume level according to following instructions.



- When using a standard audio cable with 3-pin XLR connectors or 6.3 ϕ phone plugs to plug into the MIC IN on the audio mixer or on the amplifier, please turn the Volume Level Control on the receiver to around 1 o'clock position, the output level for balanced and unbalanced output is about at 77mV.

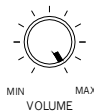

- When using a standard audio cable with 3-pin XLR connectors or 6.3 ϕ phone plugs to plug into the LINE IN on the mixer, please turn the Volume Level Control to around MAX. on the receiver position, the output level for unbalanced and balanced output is about at 770mV.

Never use the balanced and unbalanced audio outputs at the same time! This may cause signal loss or increased noise.

7.2 Connecting the receiver to power

- Point the antennas upward.
- Check that the voltage of the supplied AC adapter conforms to the voltage (AC110 or 220) available in local area. Using the wrong AC adapter may cause irreparable damage to the unit.
- Plug the feeder cable of the supplied AC adapter into DC IN socket on the receiver. Then plug the AC adapter into a power outlet.

7.3 Inserting batteries into the handheld microphone / bodypack transmitter

- Push to open the battery cover and insert batteries into the battery compartment conforming to the polarity (+)(-) marks. The transmitter can not work with incorrectly inserted batteries.
- When push the ON/OFF switch to "ON" to switch the power on, the LED will flash momentarily. If the battery has sufficient power, the LED flashes once. If the LED stayed on, it indicates that the battery has insufficient power and should be changed soon. If the status LED fails to flash, the battery is either dead or not positioned correctly, and you should correct the positioning or change the battery.
- Push back the battery cover to click it shut.

7.4 Setting up the handheld microphone transmitter

- Switch the receiver power on and check the frequency and volume level.
- Switch the transmitter and hi-fi appliance (amplifier, tape deck etc.) power on.

Test the microphone and adjust the levels on your audio mixer or amplifier.

7.5 Setting up the bodypack transmitter

A. Connecting a microphone

- Open the battery cover. Push the MIC/LINE switch to “MIC” and use the supplied screwdriver to adjust the GAIN at appropriate position.
- Plug the mini XLR connector end of the microphone cable into the audio input connector on the bodypack transmitter.
- Switch the transmitter and hi-fi appliance (amplifier, tape deck etc.) power on.
- Test the microphone and adjust the levels on your mixer or amplifier.

B. Connecting an instrument

- Open the battery cover. Push the MIC/LINE switch to “LINE” and use the supplied screwdriver to adjust the GAIN at appropriate position.
- Plug the 6.3φ phone plug of the optional guitar cable to the output jack on the instrument and the mini XLR (3.5φ plug) into audio input connector on the bodypack transmitter.
- Switch the transmitter and hi-fi appliance (amplifier, tape deck etc.) power on.
- Play the instrument for testing and adjust the levels on your mixer or amplifier.

MIC/LINE switch is an optional function only for use with mini XLR connector.

NOTICE

1. Before checking sound, move the transmitter around the area where you use the system to look for dead spots. If you find any dead spot, change the receiver position. If it does not work, avoid such places.
2. If undesirable noise occurs, adjust the SQUELCH control on receiver in clockwise to suppress it.

The higher squelch control, the lower the sensitivity of the receiver and decrease the service area of the system.



8. Trouble-shooting

Problem	Solution
No sound	<ul style="list-style-type: none">➤ Check the power supply of the microphone and receiver.➤ Check that the transmitter and receiver are tuned to the same frequency.➤ Check whether the hi-fi appliance is switched on and the receiver output is connected to mixer or amplifier input.➤ Check whether transmitter is too far away from receiver or SQUELCH control set too high.➤ Check whether receiver is located too near metal object or there are obstructions between transmitter and receiver.
Sound interference	<ul style="list-style-type: none">➤ Check the antenna location.➤ When using 2 or above microphone sets simultaneously, make sure that the chosen frequencies are not interfered.➤ Check whether the interference comes from other wireless microphones, TV, radio and etc.
Distortion	<ul style="list-style-type: none">➤ Check the gain control (Mic Adj.) for bodypack transmitter is set too high or too low.➤ Check whether the interference comes from other wireless microphones, TV, radio and etc.

9. System Feature

- Operating in UHF band frequency with synthesizer controlled.
- The wireless microphone system with 16 selectable frequencies via Phase Locked Loop (PLL) circuitry makes it easy to choose non-interfered channels.
- Diversity with two antennas to ensure the reception quality.
- Super high sensitivity, extremely low noise transmission and reception.
- SMT assembled PCB module ensures the quality and stability.

10. System Specification

Receiver

- Carrier Frequency Range : UHF band
- Frequency Stability : $\pm 0.005\%$
- S/N ratio : $> 94\text{dB}$, at 48KHz deviation and 60dB μ V antenna input
- Maximum Deviation : $\pm 48\text{KHz}$
- Image and Spurious Rejection : 80 dB minimum
- Receiving Sensitivity : 8 dB μ V.
- Selectivity : $> 50\text{dB}$
- AF Response : 50Hz to 15KHz ($\pm 3\text{dB}$)
- T.H.D. : $< 1\%$ (at 1KHz)
- Audio Output : Balanced and unbalanced audio outputs
- Current consumption : 500mA $\pm 10\text{mA}$
- Power Supply : 12V DC
- Dimensions : 420(W) x 180(D) X 45(H) mm

Handheld/Bodypack Transmitter

- Carrier Frequency Range : UHF band
- RF Power Output : 10mW (max.)
- Oscillation Mode : PLL synthesized
- Frequency Stability : $\pm 0.005\%$
- Maximum Deviation : $\pm 48\text{KHz}$
- Spurious Emission : More than 60dB below carrier frequency
- T.H.D. : Less than 1% (at 1KHz)
- Microphone Capsule : **Handheld:** uni-directional dynamic or uni-directional electret condenser unit
Lavalier: uni-directional electret condenser unit
- Operating voltage : DC 1.5V x 2 AA size batteries
- Current consumption : 65mA $\pm 5\text{mA}$
- Dimension (mm) : UF-16A: 56 ϕ x263mm; UT-16A: 64(W)x97(H)x24(D)

DESIGN AND SPECIFICATIONS SUBJECT TO CHANGE WITHOUT NOTICE.

UHF

Wireless Microphone

