

# INSTRUCTION MANUAL FOR MICROWAVE LEVEL METER

TYPE  
MWLM-PR26

## Contents

Safety precautions	1
1 . Overview	2
2 . Measurement principle	2
3 . Specifications	2
4 . System configuration	4
5 . Dimensions	5
6 . Installation	8
7 . Wiring	11
8 . LCD adjustment unit	12
9 . Start-up	12
10 . Parameter setting	13
11 . Troubleshooting	20
12 . Menu structure	21

An operator should read carefully this instruction manual and conduct correct handling.



**MATSUSHIMA**  
MACHINERY LABORATORY Co., LTD.

1-8-18 Norimatsu-Higashi, Yahatanishi-ku, Kitakyushu 807-0837 Japan  
Phone No. (8193)691-3731 Fax No. (8193)691-3735  
E-mail: info@matusima.co.jp

## Safety precautions

- Be sure to thoroughly read the instruction manual before using the products.
- Keep the instruction manual in a safe, convenient location for future reference.
- All or part of the contents described in this manual may be changed without any notice.
- Due to our constant striving for further improvement of products, parts or products that differ from those described in this manual may be substituted.



### **WARNING** (Failure to observe this WARNING may cause a fatal or serious injury.)

- Be sure to confirm that any peripheral equipment does not move before installation work. In addition, observe safety requirements for installation work where high-place work is expected.
- Be sure to turn off the power source before wiring, mounting and transportation work. (Failure to observe this WARNING may result in an electric shock/ injury or equipment damage due to short-circuit.)
- Carry out wiring work correctly with reference to a proper drawing.
- Never disassemble the equipment. (Failure to observe this WARNING may result in an electric shock.)
- Do not open the cover under an explosive environmental condition when power is entered. (Failure to observe this WARNING may result in an injury or equipment damage.)
- Do not place or store the equipment in any hostile environmental place where it will be subjected to direct sunlight, rain, water droplet, hazardous gas / water, etc..



### **CAUTION** (Failure to observe this CAUTION may cause a moderate injury or equipment damage.)

- Do not use the equipment for any purpose other than the original purpose of use.
- Be sure to confirm the specification of equipment and use the equipment within the range of specification. (Mounting conditions such as temperature, power source, frequency, etc.)
- Make sure a correct wiring before applying power source.
- Do not have a shock or strong impact to the equipment. (Failure to observe this CAUTION may result in equipment damage.)
- Be sure to connect necessary terminals (grounding, etc.).
- Remove all wiring to the equipment before doing electrical welding work near the equipment.
- Do not forcedly bend or pull the lead wire also do not use unnecessarily long wire.
- Tighten the cover, lead outlet, etc. properly so that dust, rainwater, etc. do not enter inside the equipment.
- Do not use the equipment under a corrosive condition (NH<sub>3</sub>, SO<sub>2</sub>, Cl<sub>2</sub>, etc.).
- Be sure to tighten the cable grand so that outer air does not enter inside the equipment.
- When applying piping connection such as conduit, etc. instead of cable gland, apply putty or equivalents On the cable entry so that outer air does not enter inside the equipment.



### **IMPORTANT** (indicates notes or information to help customers.)

#### Limitations of Warranty:

- Warranty period shall be one year from the date of delivery (ex-factory).
- Any damage of any other products that have occurred for use of the equipment is not covered by this warranty. Also any loss induced by failure or malfunction of the equipment is not covered by this warranty.
- Failure or malfunction caused by following are not covered by this warranty:
  - a. Modification or repair by a party other than MATSUSHIMA's authorized personnel, or replacement of parts not recommended by MATSUSHIMA.
  - b. Inadequate storage, installation, use, inspection or maintenance that does not comply with specifications.
  - c. Cause for any peripheral equipment or device.
  - d. Accident beyond control and force majeure (fire, earthquake, flood, riots, etc.).

Lack of instructions to MATSUSHIMA for information or safety requirements that can be predicted only by customers' side.

This warranty conditions do not limit customers' legal right.

Price for the equipment does not include any charge for services such as commissioning, supervising, etc..

## 1. Overview

Microwave level meter measures level of bulk solids and liquids in the storage vessels without physical contact to measuring material. This model of level meter doesn't need separate output unit, which 4..20mA current output signal is carried by same two wires for power supply.

## 2. Measurement principle

The level meter transmits microwaves at constant intervals, and receives echoes (reflection of transmitted waves) from the surface of material under measurement. The time difference between transmission and reception of microwave is processed by microcomputer to accurately determine level of stored materials.

## 3. Specifications

### 3-1.General Specifications

Table1. Standard specification

Model	MWLM-PR26C1G	MWLM-PR26H1G	MWLM-PR26H3G / F / S	MWLM-PR26H7G / F / S
Applications	For liquid		For powder	
Antenna	Corn	Small horn	Horn	
Power Supply ( 1 )	DC 20 to 32V			
Power consumption	Max. 704mW			
Mounting ( 2 )	G2 screws	G1 screws	G : G1 1/2 screws F : JIS5K65A flange S : JIS10K100A swiveling flange	G : G1 1/2 screws F : JIS10K100A flange S : JIS10K100A swiveling flange
Dead Zone	0.5m below the antenna		0.3m below the antenna	
Max Measurable Distance ( 3 )	10m		35m	70m
Transmitting frequency	Approx. 26GHz			
Transmitting cycle	Every 83ms			
Beam angle ( -3dB )	Approx. 24deg. (Approx.48deg. side beam)		Approx. 14deg. (Approx.28deg. side beam)	Approx. 8deg. (Approx.16deg. side beam)
Resolution	1mm			
Allowable Fluctuation Rate	10cm / s			
Accuracy ( 3 )	Repeatability	Within 2m or less : $\pm 30\text{mm}$ Within 2m or more : $\pm 20\text{mm}$ or $\pm 0.04\%$ of measurement range (Whichever is greater)		
	Temp. error	0.06% / 10K		
Ambient Temp. ( 4 )	Housing	-40 ~ +60 (With LCD : -20 ~ +60 ) (Note : 1h warm-up operation required at -40 )		
	Antenna	-40 to +150		
Allowable pressure	500kPa	1MPa	G : 1MPa , F : 490kPa , S : 10kPa	G : 1MPa , F : 250kPa , S : 10kPa
Material	Housing	ADC		
	Antenna	PTFE	SUS304	SUS316L
Protection ( 5 )	Housing	IP66 (Housing cover and lead outlet must be closed.)		
	Antenna	IP67		
Lead outlet	1-G1/2 (Applicable size : 8 ~ 12mm)			
Output signal	DC4 to 20mA $\times$ 1 (Resistive load Max.499 )			
Integral Time	0 ~ 999s			
Mass	Approx. 1.9kg	Approx. 1.6kg	G : Approx. 2.3kg F : Approx. 4.4kg S : Approx. 5.6kg	G : Approx. 2.7kg F : Approx. 5.3kg S : Approx. 6.0kg
Accessories ( option )	LCD Adjustment unit (GRAPHIC COM2)、Data communication cable (HM-USB-ISO) PC Adjustment software (MDTM)			

- 1) Power supply ripple voltage must be less than 0.2Vp-p.  
Noise and surges should not be interfered. (Recommended)

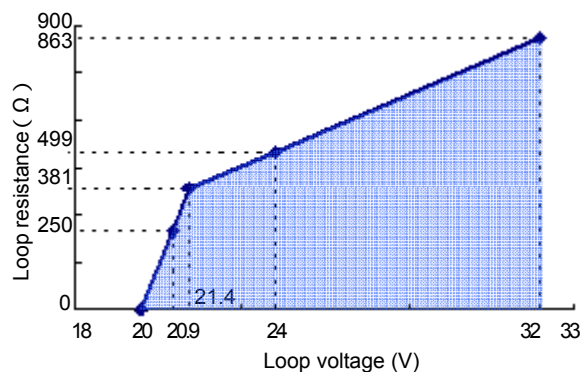

Fig.1. Loop voltage versus loop resistance

- 2) When mount on a short stand pipe, install the level meter so that the end of the antenna protrude from the short stand pipe.
- 3) The measurement range and accuracy are guaranteed only when, antenna is pointed at an angle perpendicular to the material surface, temperature is normal (15 °C), permittivity is more than two at high pressure, and no any presence of airborne dust, vapor, and agitated foam.  
If these conditions are not satisfied, the measurement range and accuracy may differ according to the measurement conditions.
- 4) Ensure that freezing and/or condensing will not occur inside the electronic unit.
- 5) Take care that water may enter and damage the equipment, if lead outlet not tighten firmly or loosen. When the equipment operated in the presence of process gases and/or fluids, those materials may penetrate through resin of cone antenna and damage the equipment, specially corrosive gases such as H<sub>2</sub>S, HCl and HF.

### 3-2. Authentication

#### FCC and IC conformity (only for USA/Canada)

- This device complies with part 15 of the FCC Rules. Operation is subject to the following two conditions: (1) This device may not cause harmful interference, and (2) this device must accept any interference received, including interference that may cause undesired operation.
- Changes or modifications not expressly approved by the manufacturer could void the user's authority to operate the equipment
- This device complies with Industry Canada licence-exempt RSS standard(s). Operation is subject to the following two conditions: (1) this device may not cause interference, and (2) this device must accept any interference, including interference that may cause undesired operation of the device.  
  
FCC ID : PVK-MWLM-PR26  
IC : 10700A-MWLMPR26
- RF Exposure: A distance of 20 cm shall be maintained between the antenna, and the transmitter may not be co-located with any other transmitter or antenna.
- This device shall be installed and operated in a completely enclosed container to prevent RF emissions, which otherwise can interference with aeronautical navigation. Installation shall be done by trained installers, in strict compliance with the manufacture's instructions.
- This device shall be installed only by professionally training individuals inside closed containers at permanent fixed positions, pointing in a downward direction.
- The use of this device is on a "no-interference, no protection" basis. That is, the user shall accept operations of high-powered radar in the same frequency band which may interfere with or damage this device. However, level probing devices found to interference with primary licensing operations will be required to be removed at the user's expense.

#### 4. System configuration

This device is two wired which 4..20mA current output signal and power supply are carried on the same two wire cable.

- Power supply : Nominal DC 24V
- Output current signal : DC 4 to 20mA
- Load resistance : Max. 499 Ohm for 24V (total of load resistor 250 Ohm plus cable resistance).  
For other configurations, please refer to graph shown in Fig.1.
- Cable size : 0.3mm<sup>2</sup> to 1.25 mm<sup>2</sup> (AWG 22 to 16)

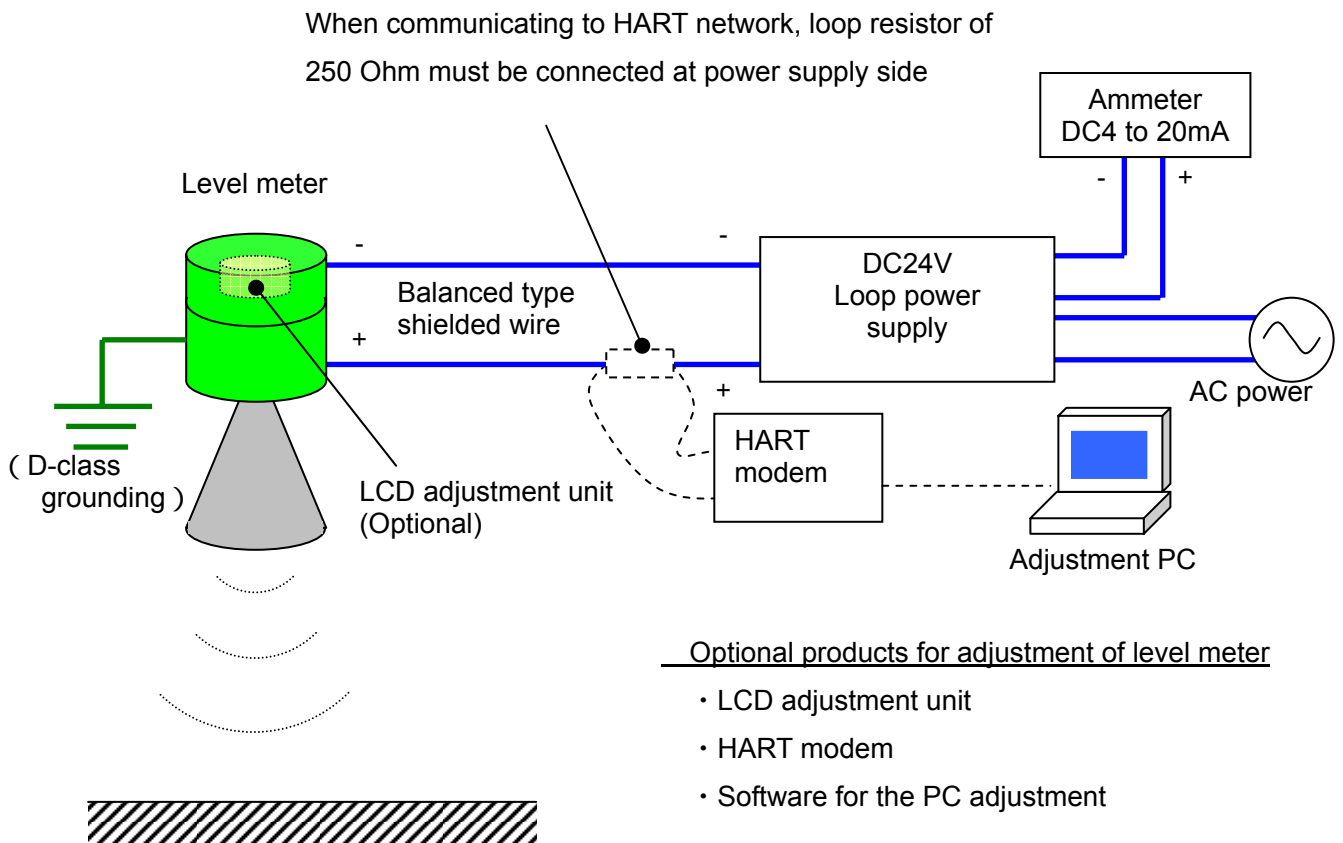

Fig. 2. System configuration example

## 5. Dimensions (Units : mm)

### Liquid

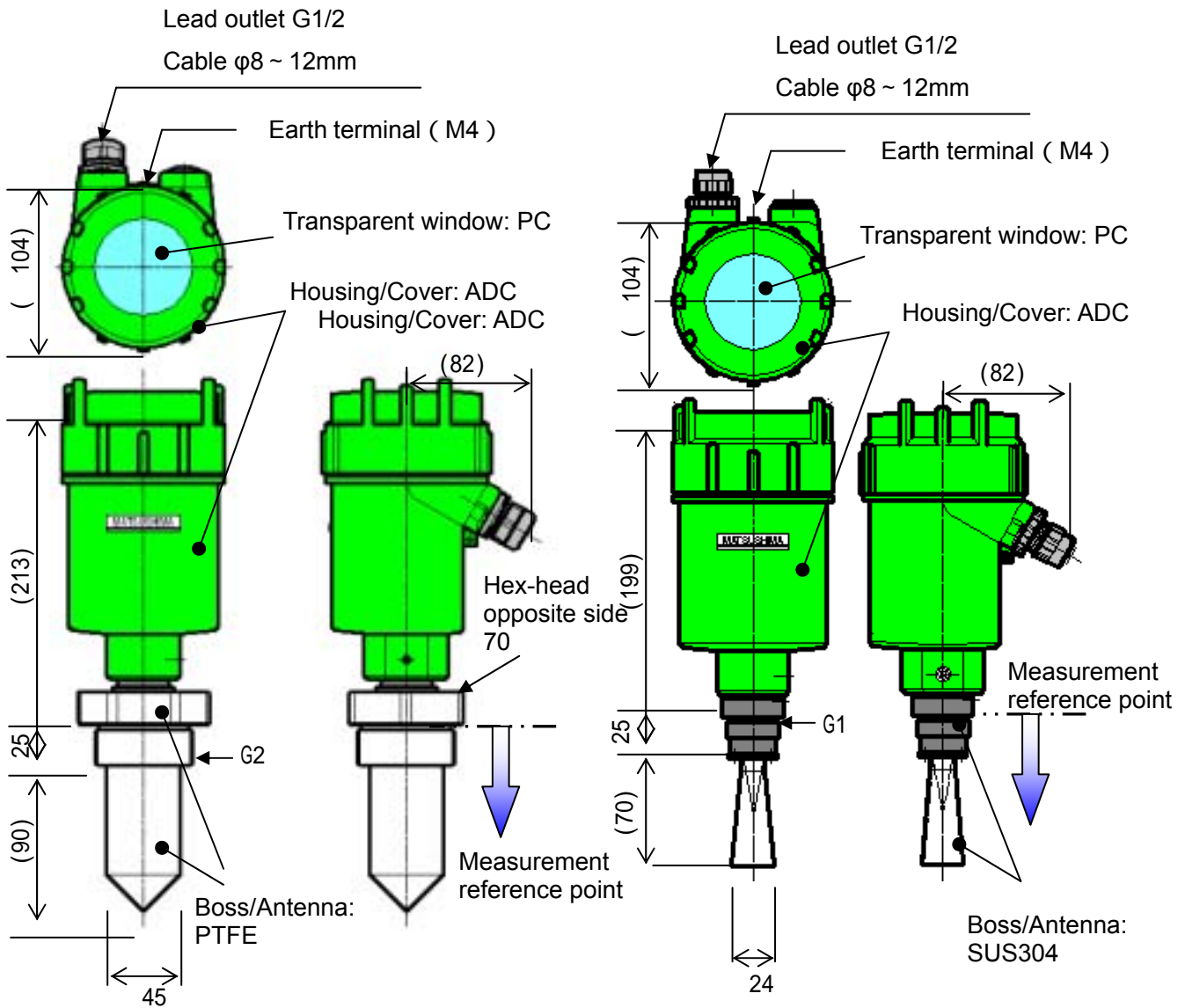

Fig. 3. External dimensions for liquid type

Refer to external dimensions for measurement reference point.  
Basically upper part of mounting compartment is measurement reference point.

Solid-1

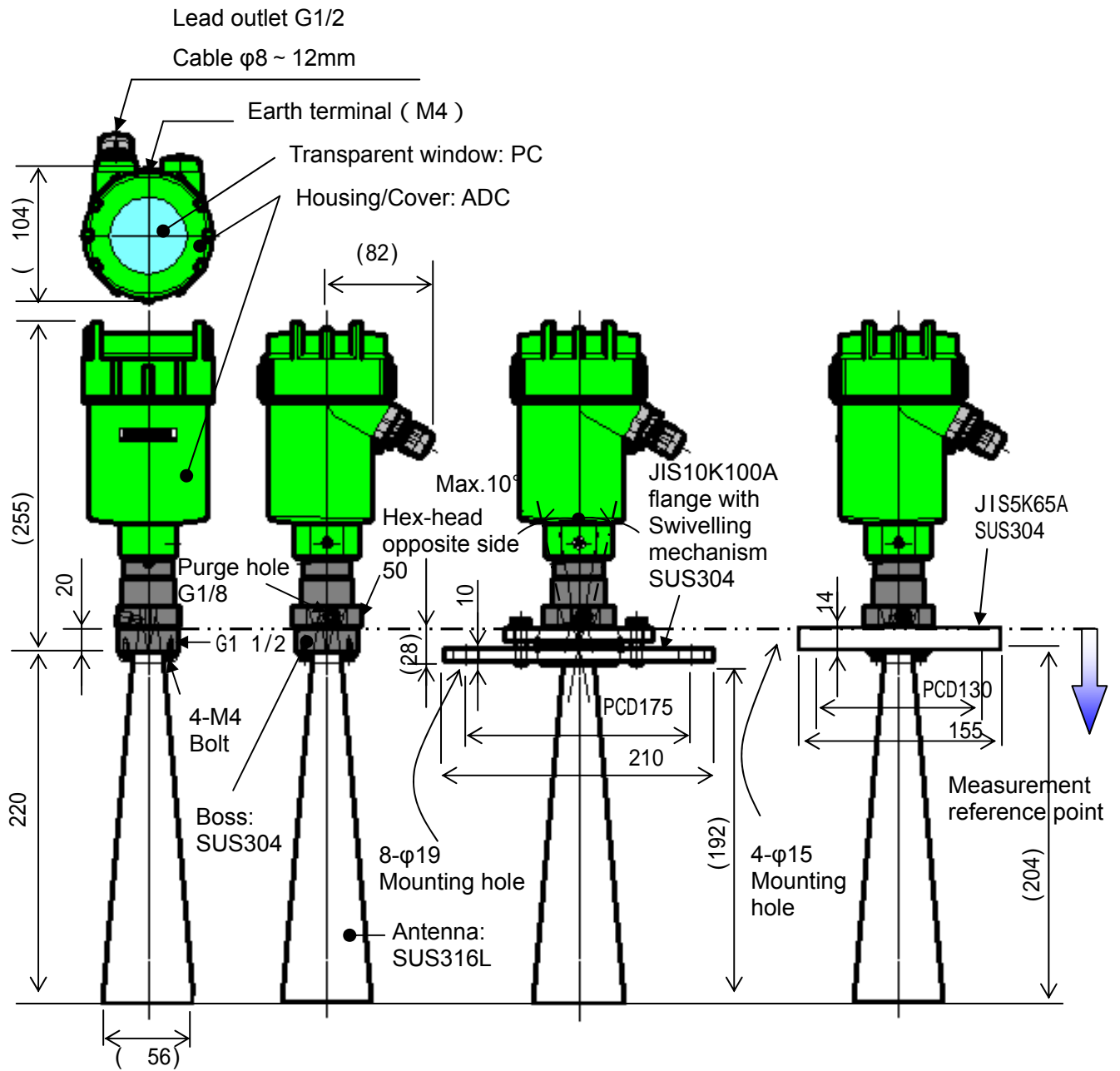

Fig. 4-1. External dimensions for solid type

Refer to external dimensions for measurement reference point.

Basically upper part of mounting compartment is measurement reference point.

Solid-2

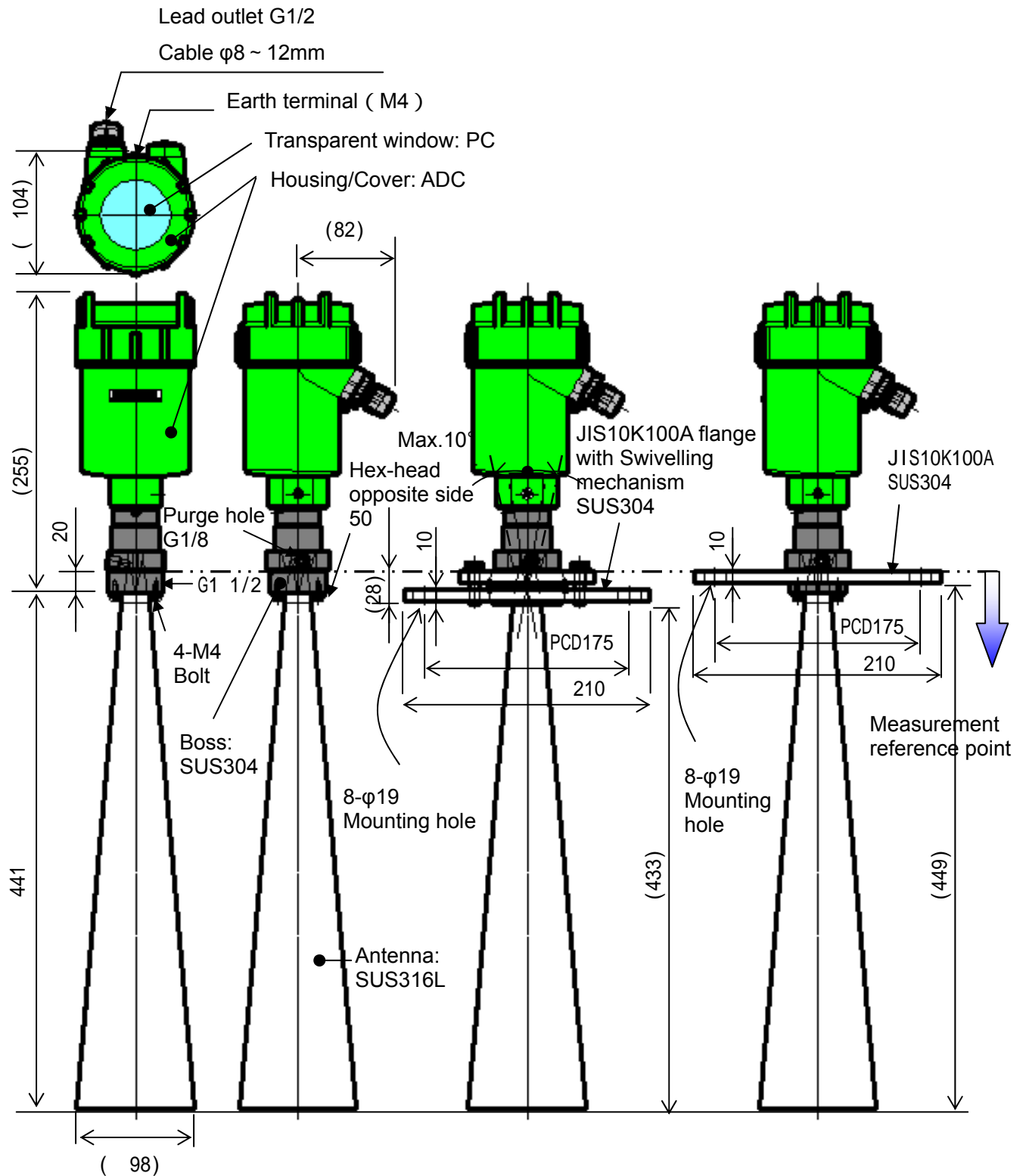

Fig. 4-2. External dimensions for solid type

Refer to external dimensions for measurement reference point.

Basically upper part of mounting compartment is measurement reference point.



## 6. Installation

### 6-1. Installation

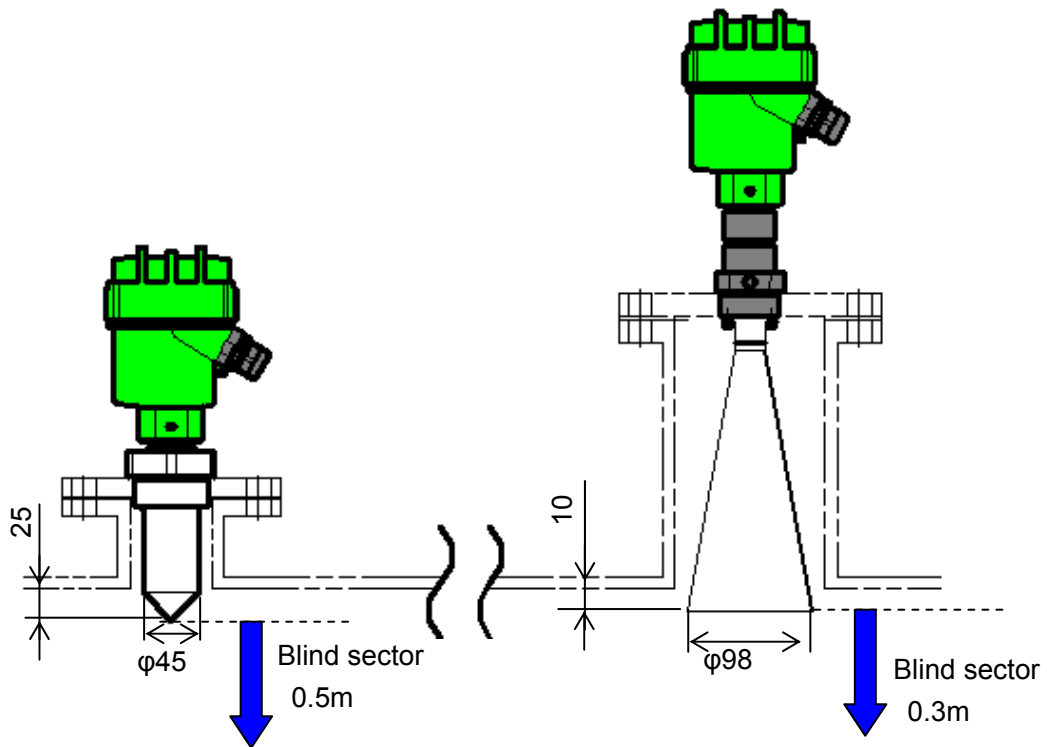

Fig. 5. Installation for liquid and for solid

- If material surface enter to the blind sector, a stand pipe shall be used to ensure that material surface can not reach the blind sector of the level meter. But if the material surface will not enter the blind sector, then stand pipe should not be used.
- If length of stand pipe is longer than required, such that antenna end is not protruded from stand pipe, then it causes malfunction of instrument.
- When required stand pipe length is longer than antenna, please use cone shape stand and ensure radiation angle including the side beam.  
Keep radiation free of interference from the stand pipe.

#### 【Recommended height of stand pipe】

Solid: The end of the horn antenna must be protruded a minimum of 10mm from the stand pipe.

Liquid: The end of the antenna must be protruded a minimum of 25mm from the stand pipe.

#### 【Calculation of radiation angle expansion】

Solid : Distance from meas. reference point  $\times \tan 16^\circ + \phi 98$  (Antenna diameter)

Solid : Distance from meas. reference point  $\times \tan 28^\circ + \phi 56$  (Antenna diameter)

Liquid : Distance from meas. reference point  $\times \tan 48^\circ + \phi 45$  (Antenna diameter)

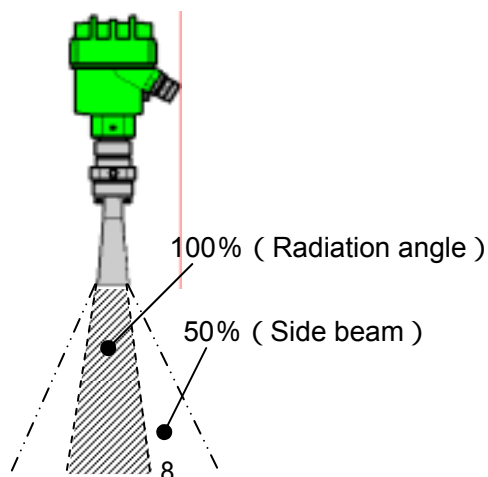

Fig. 6. Radiation angle and side beam reference

6-2. Installation precautions

- Set the value of 100%(20mA) level so that the blind sector is secured. Setting the 100%(20mA) level within the blind sector will cause a malfunction of the instrument.
- Avoid too long stand pipe to prevent malfunction of the instrument.

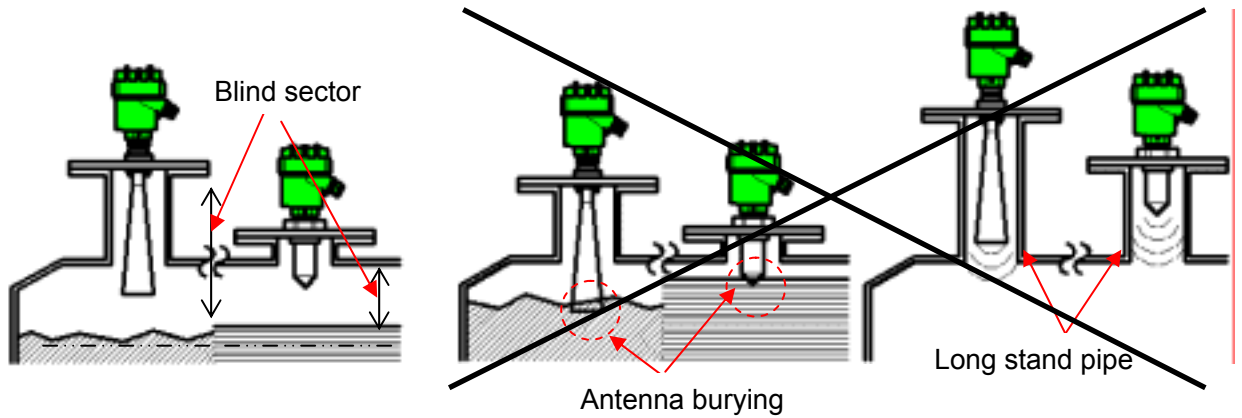

Fig. 7. Installation precaution (1)

- Do not install instrument close to inlet of material under measurement.
- Do not install any interfering instruments within the side beam, because reflections from beams, pipes, and other supports within the tank will cause false echoes.

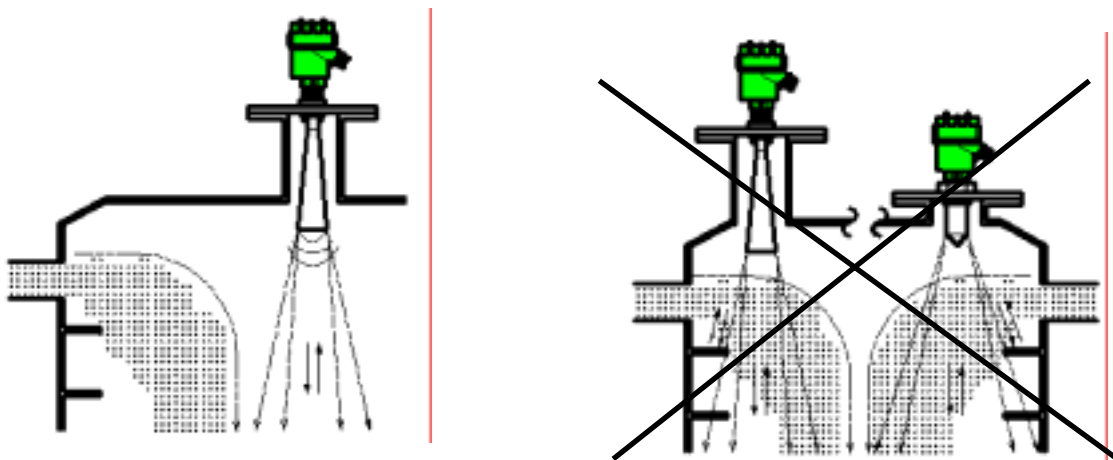

Fig. 8. Installation precaution (2)

- Provide shielding to minimize noise or unwanted reflections, when crossbeams, and other supports are installed within the tank.

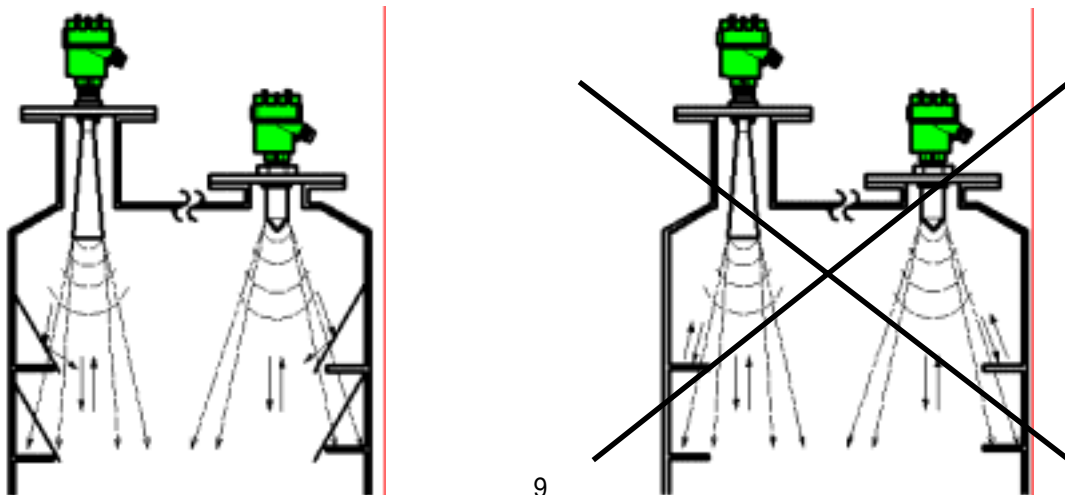



Fig. 9. Installation precaution (3)

**【 False reflections 】**

In environments where interfering signals are generated, level meter may indicate incorrect measurements results. False reflections up to a certain level of strength can be suppressed by executing the echo learning function. However, the level meter's installed position must be changed if true echoes cannot be received or if the reflection level (measured in dB) is extremely low. When there are obstructions such as crossbeams, pipes, or level switches in the tank, install the level meter in a position where there is no obstruction within its radiation angle.

 **Important :** It is not possible to specify the range of false reflections in dB that can be suppressed by the learning function because the level of true echo from the surface of material differs depending on the level meter installation conditions and measuring material type. The general guideline for the level of false reflections that can be suppressed by the learning function is one third (1/3) of true echo level.

- Install protection such as a simple roof above the Level Meter to avoid exposure to direct sunlight.

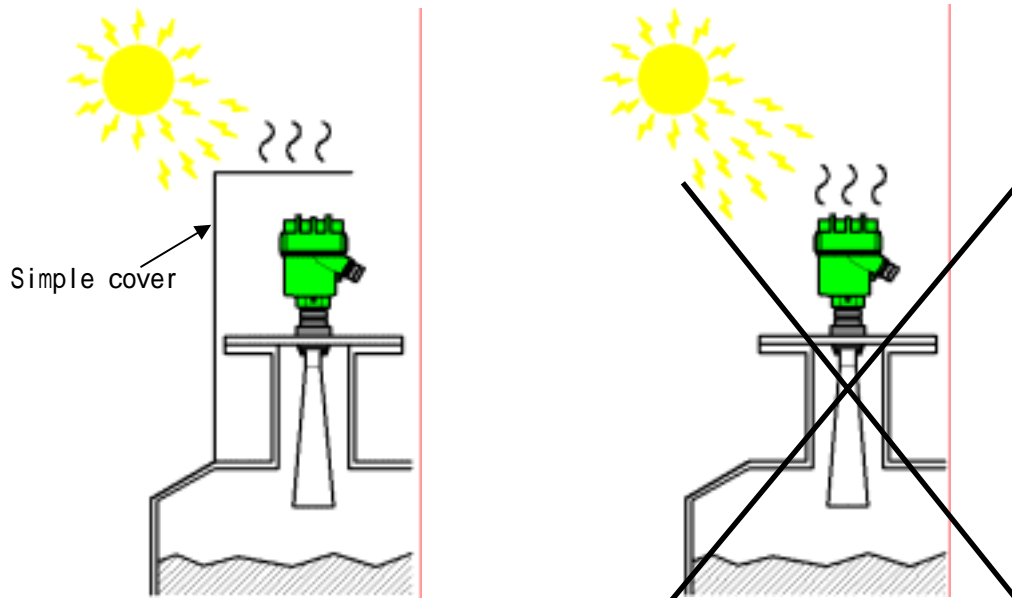

Fig. 10. Installation precaution (4)

## 7. Wiring

- 7-1. Unscrew the cover. (Rotate counterclockwise)
- 7-2. If an optional LCD adj. unit is attached, remove it. (Rotate counterclockwise or to direction "OPEN").
- 7-3. Open the wire entry of terminal block by pushing on the actuating lever with flat screwdriver. (Recommended flat screwdriver: Axis diameter 3mm and blade tip size 2.6mm)
- 7-4. Insert wires as shown on the panel, positive (+) to terminal entry No.1 and negative (-) to terminal No.2. Please wire so that there is no mistake. Release actuating lever of the terminal.
- 7-5. Connect the ground wire to internal earth ground terminal.
- 7-6. Attach the LCD adj. unit if it had been installed.
- 7-7. Screw the cover on tightly.



### Important:

The size of the acceptable cable is max. 1.25mm<sup>2</sup> (0.3mm<sup>2</sup> to 1.25 mm<sup>2</sup>). (AWG22 to 16)



### Warning:

Do wiring when the instrument is powered OFF. Avoid short circuit and reverse polarity.

The instrument must be supplied with DC power supply, do not apply different voltage.

Tighten the cover and lead outlet firmly after wiring completed.

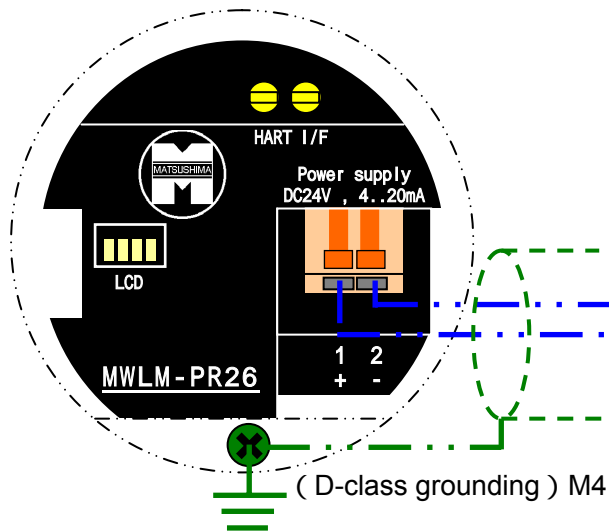

Fig. 13. Connection example

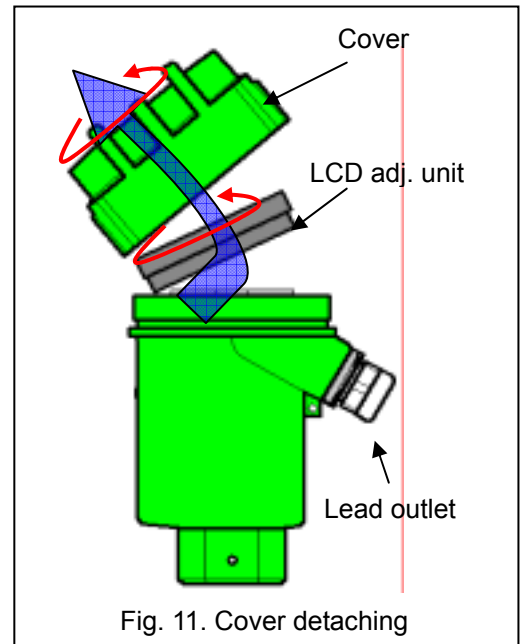

Fig. 11. Cover detaching

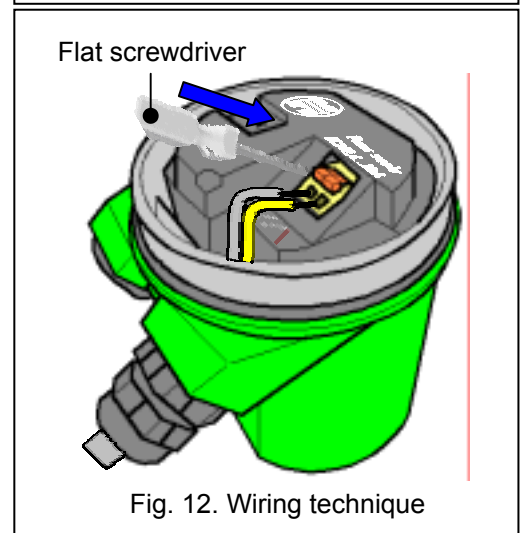
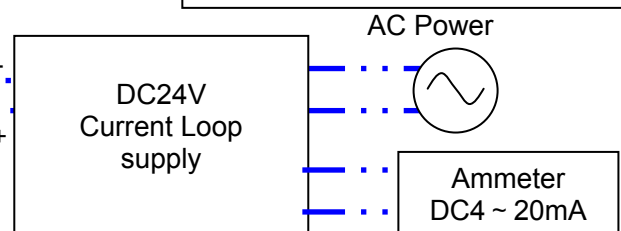

Fig. 12. Wiring technique



Left figure shows that LCD Adj. unit removed. Do not touch to the LCD Adj. unit connection terminal, while instrument is powered on.

## 8. LCD adjustment unit (GRAPHIC COM II) Optional



Fig. 14. LCD adjustment unit

Table 2. Key functions

No.	Key	Function
1.	Esc	- Interrupt entry (cancel) - Returns to previous screen
2.	+	- Moves cursor - Change value - Change Y axis (reflection) of waveform
3.	→	- Moves cursor to the left - Change X axis (distance) of waveform
4.	Ent	- Enters to menu - Accepts value - Shifts to next screen
5.	Display	Displays parameters and waveforms

## 9. Start - up

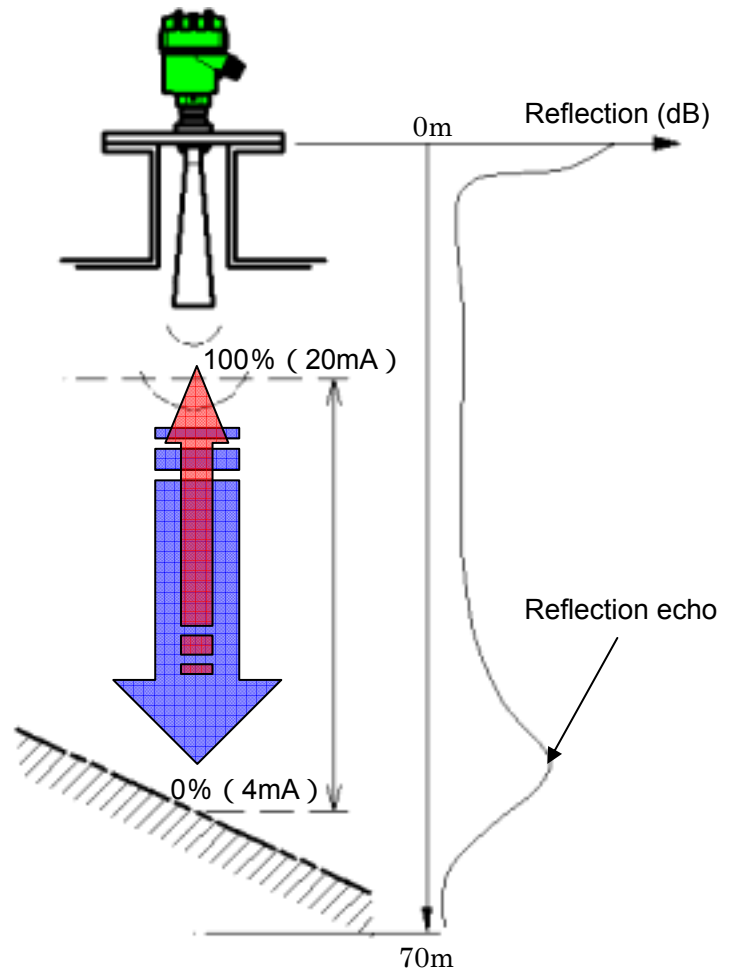
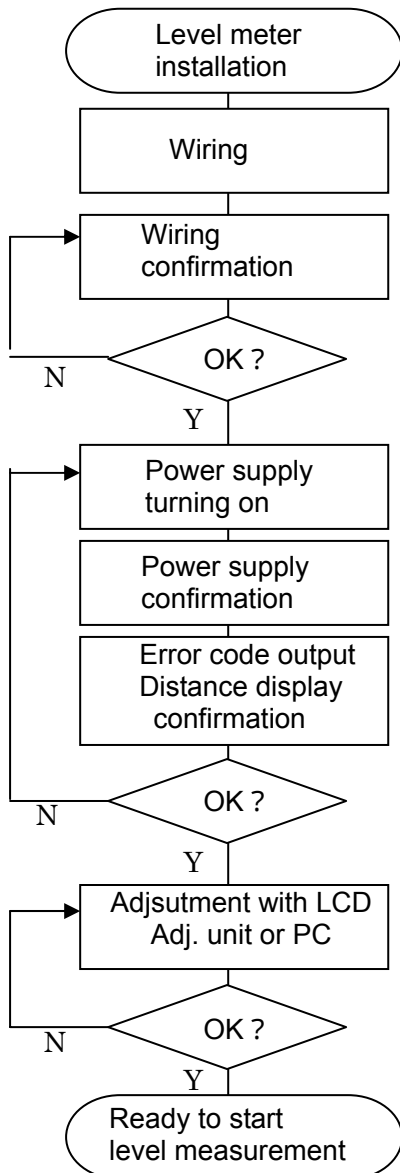

Fig. 16. Measurement range

"LCD adj. unit", "Software for PC adjustment" and "HART modem" are optional products.

For the error code details, please refer to "Instruction manual for LCD adjustment unit" and "Operating manual for adjustment software Matsushima DTM".

Fig.15. Start - up

## 10. Parameter setting

### 10.1 Measurement span

Sets measurement span corresponding to the process level of 100% and 0%.

Distance: Distance from level meter measuring reference point to material surface

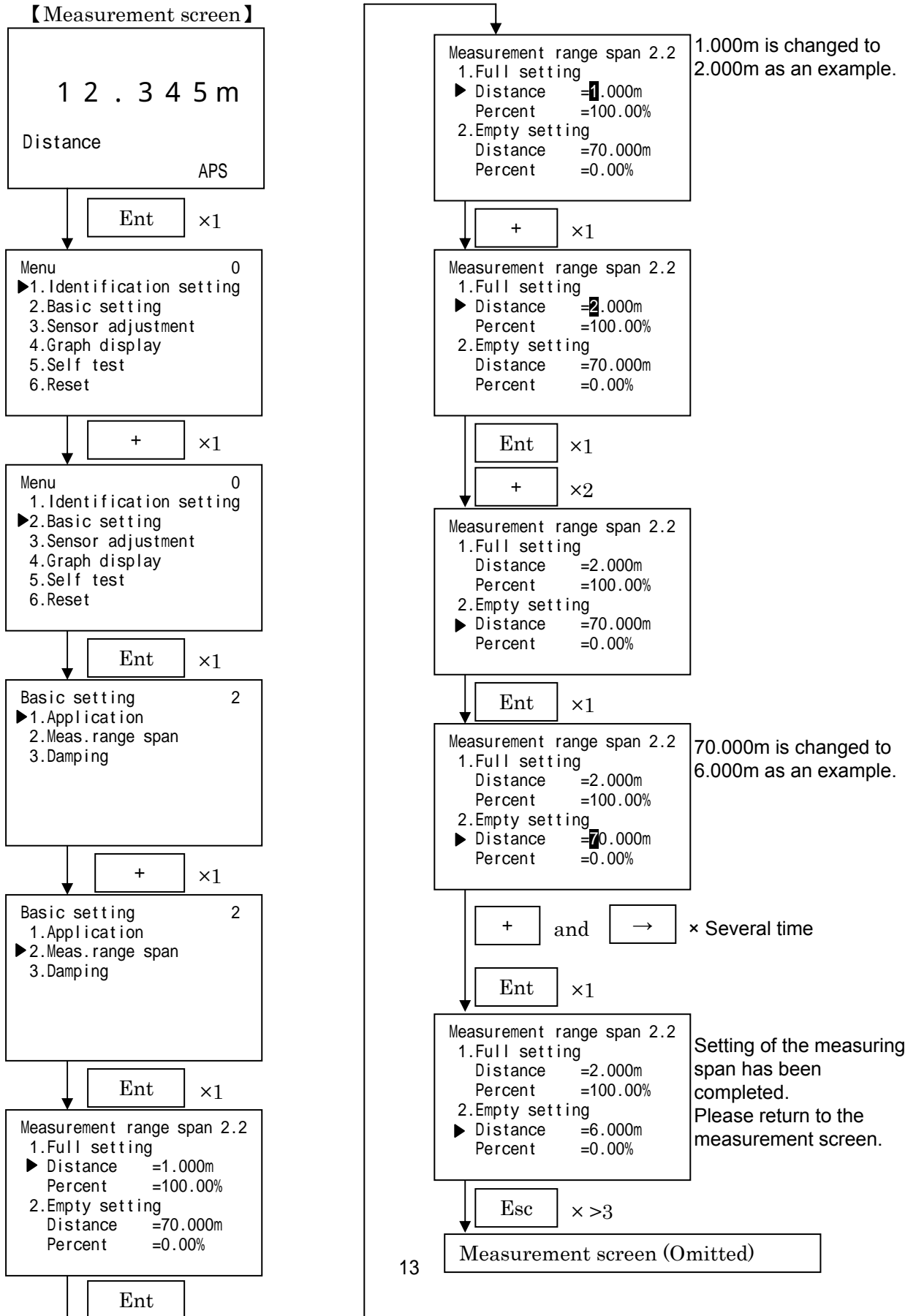

### 10-2. Damping

Sets time constant for the damping filter. The damping filter smooth the response to a sudden change in process level. This time can be set between 0 and 999 seconds.

Keep in mind that the reaction time of the entire measurement will be longer and the sensor will react to measured value changes with a delay)

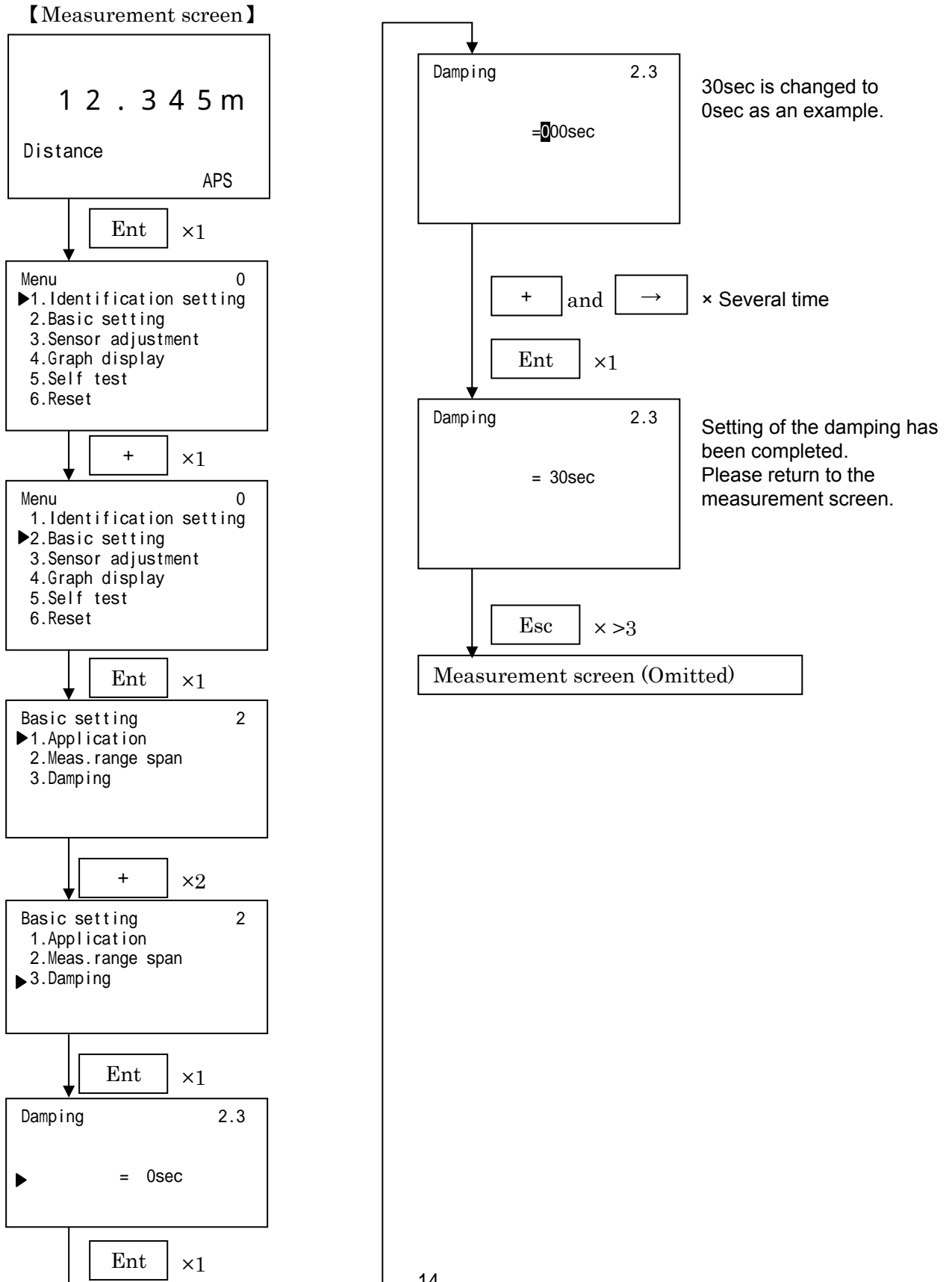

### 10-3. Current output

Selects the 4..20mA current output mode corresponding to the process level 0-100% and alarm current value.

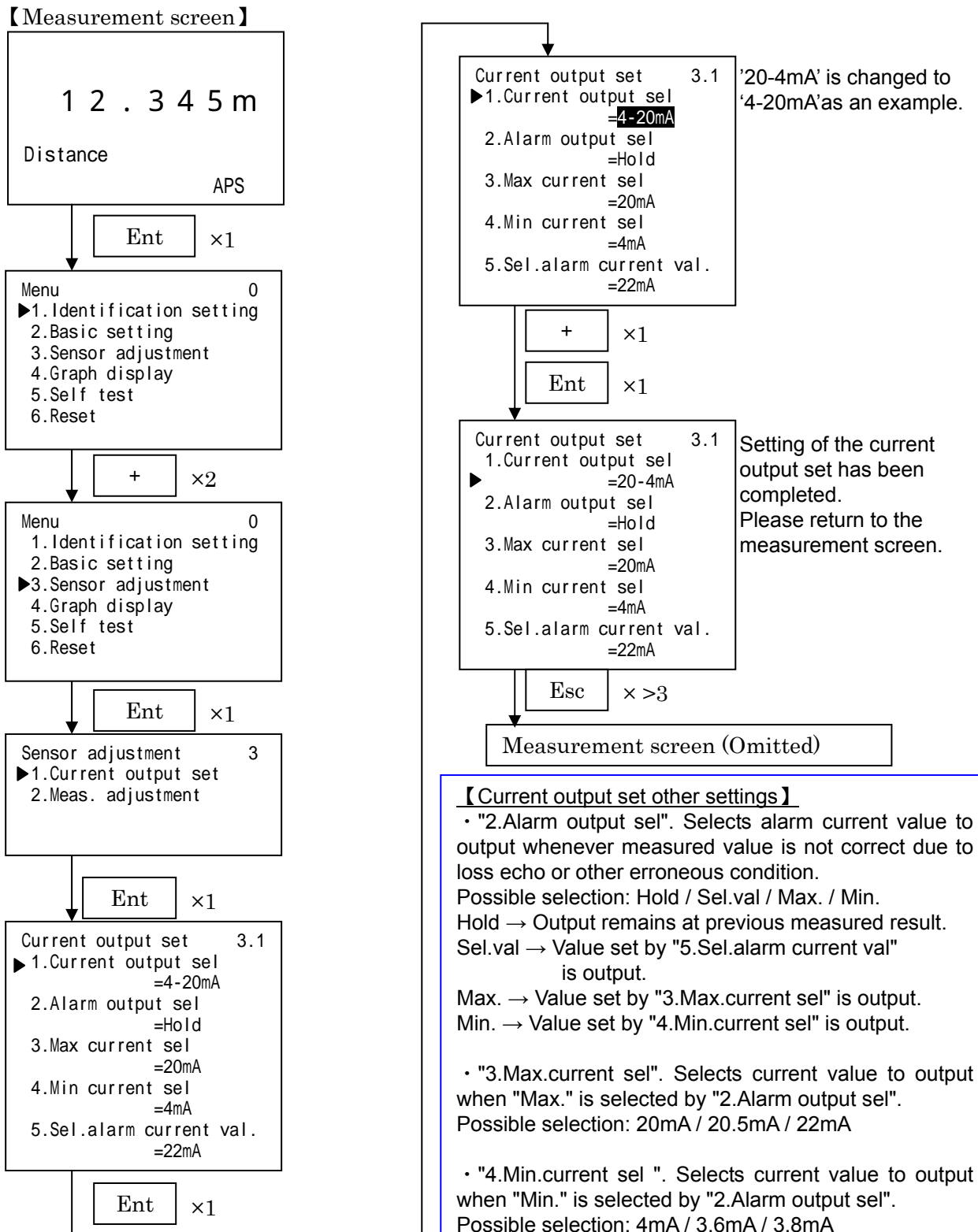

#### 【Current output set other settings】

- "2.Alarm output sel". Selects alarm current value to output whenever measured value is not correct due to loss echo or other erroneous condition.  
Possible selection: Hold / Sel.val / Max. / Min.  
Hold → Output remains at previous measured result.  
Sel.val → Value set by "5.Sel.alarm current val" is output.  
Max. → Value set by "3.Max.current sel" is output.  
Min. → Value set by "4.Min.current sel" is output.
- "3.Max.current sel". Selects current value to output when "Max." is selected by "2.Alarm output sel".  
Possible selection: 20mA / 20.5mA / 22mA
- "4.Min.current sel ". Selects current value to output when "Min." is selected by "2.Alarm output sel".  
Possible selection: 4mA / 3.6mA / 3.8mA
- "5.Sel.alarm current val". Sets current value to output when "Sel.val" is selected by "2.Alarm output sel".  
Setting range: 3.6mA to 22.0mA

#### Meaning of "Current output sel" item

- ▮ 4-20mA ▮ = 100%Level(Upper level) : 20mA  
0%Level(Lower level) : 4mA
- ▮ 20-4mA ▮ = 100%Level(Upper level) : 4mA  
0%Level(Lower level) : 20mA



#### 10-4. Echo learning of false echo

Sets mask to unwanted reflections (false echoes or noise echoes) being received from obstructions within a tank.



**Important : In most cases sets distance from level meter to unwanted reflections as echo learning distance. If there is true echo between the level meter and the masking distance, then echo learning distance shall be set as distance to true echo. Actual distance to mask will be around 1m less than the entered value.**

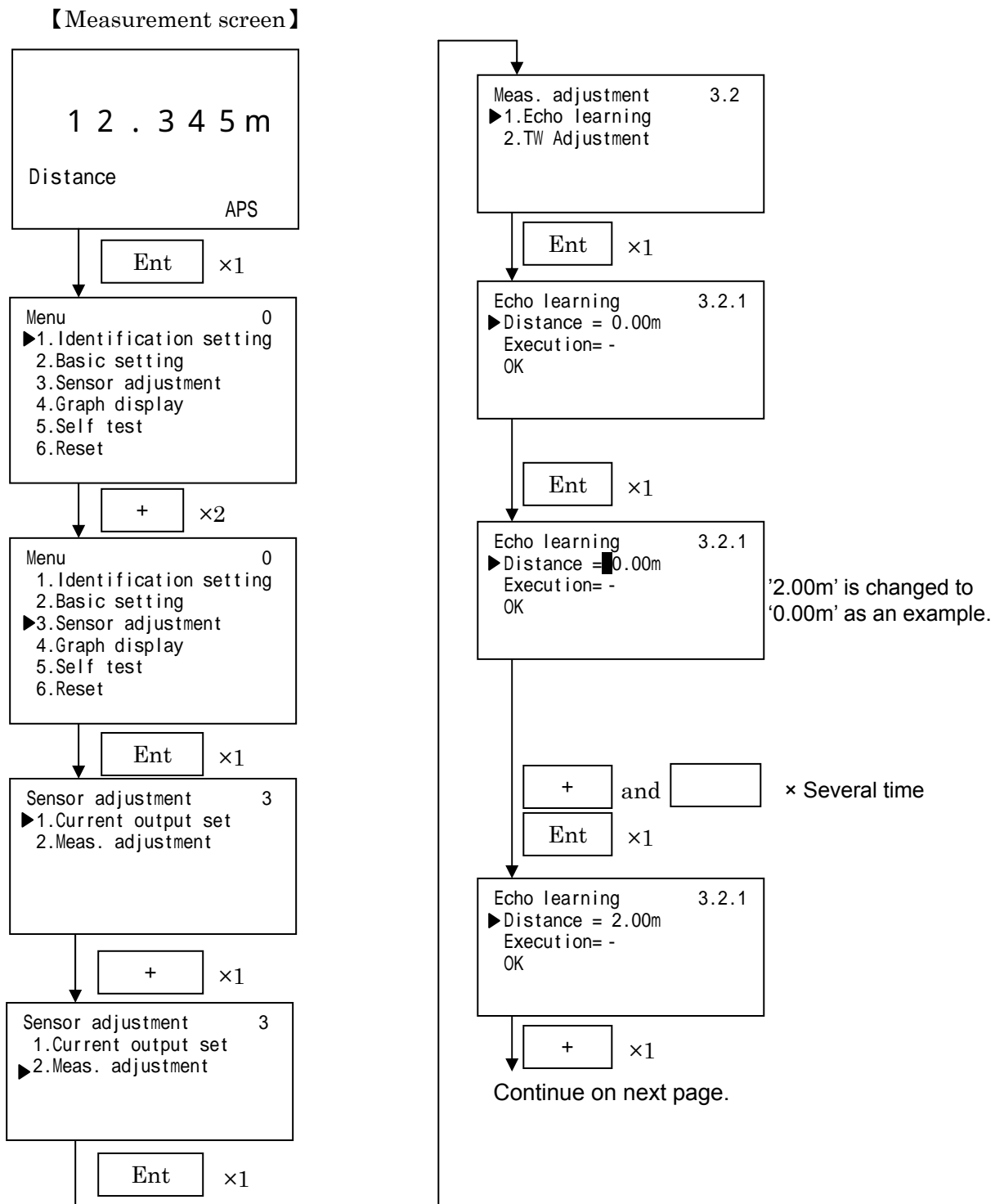

Continued from previous page.

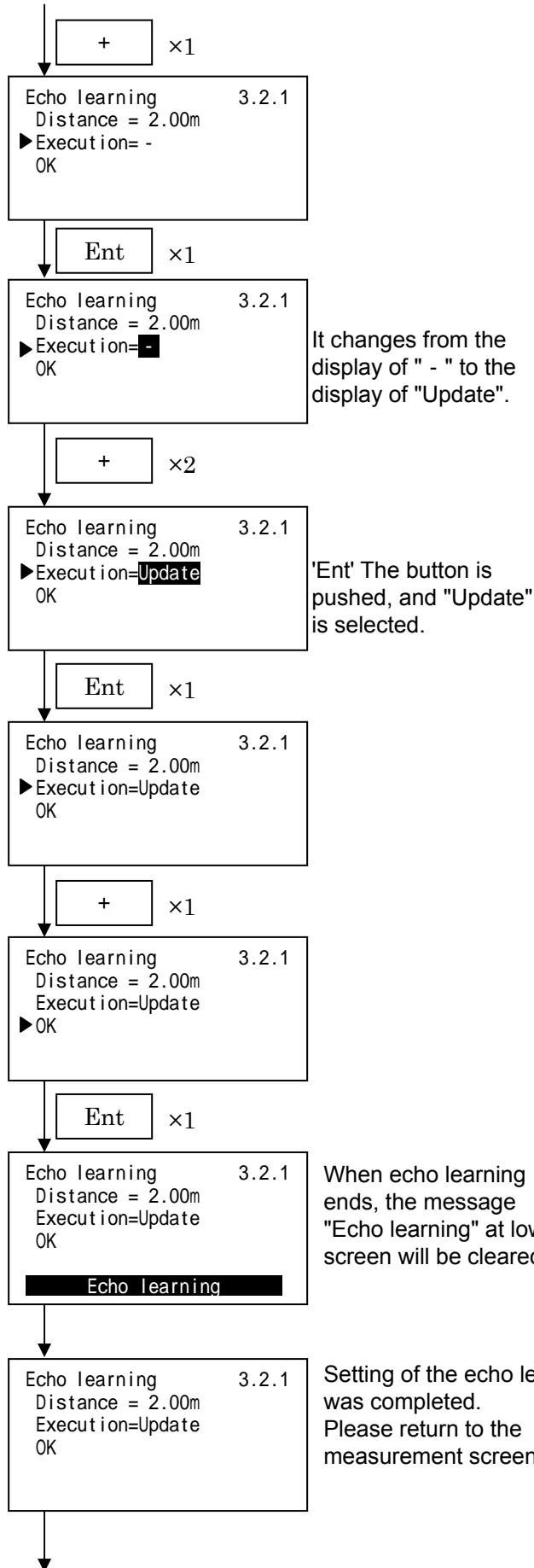

• "Selectable execution  
【Clear / Update / Addition】

Clear : Deletes all echo learning data.

Update : Deletes current echo learning data and writes new data.

Addition : Addition of echo learning data  
The data that had been input in the past is not deleted and new data is added.

Esc × >3

Measurement screen (Omitted)

### 10-5. Reset

There are two reset options. Use "Measuring reset" to restart measurement without affecting parameters. Use "Parameter reset" to reset parameters to the default settings.



#### Important : "Parameter reset"

- **Parameter reset returns various parameters to instrument default. Please take note of current settings before execute parameter reset.**
- **It is possible to clear echo learning range and strength by using the optional PC software, but echo learning setting described in article 10-4 does not clear even when reset is executed.**
- **There are two reset types described above, but there is menu item "Factory reset" might be displayed. This reset type used at factory setting and user can not apply this reset.**

【Measurement screen】

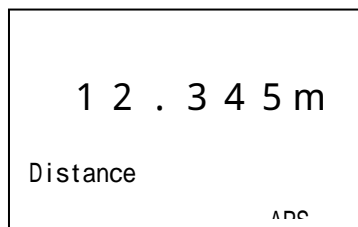

Ent ×1

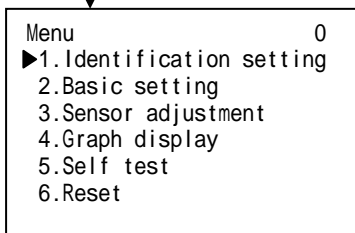

+ ×5

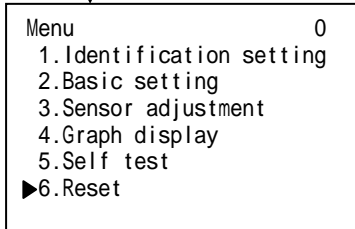

Ent ×1

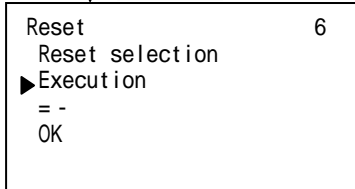

Ent ×1

+ ×2

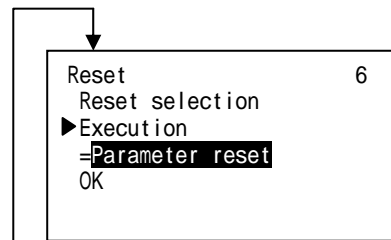

'Parameter reset' is changed to '-' as an example.

Ent ×1

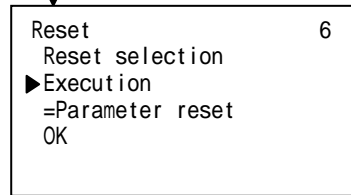

+ ×1

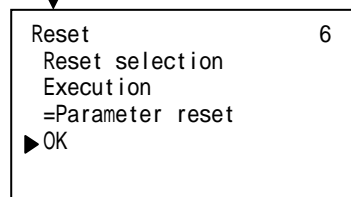

Ent ×1

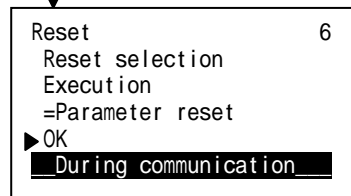

When reset completed, "Communication" display will be cleared.

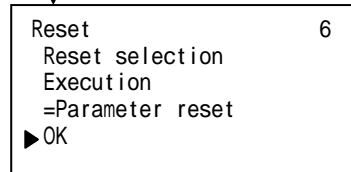

Click Esc three times to return to measurement screen.

Esc × >3

Measurement screen (Omitted)

## 10-6. Current output test

Allows you to input simulation value in order to test the functioning of the current output.



**Important :** When you are ready to end the simulation, click on 'Esc' to return the instrument to the actual level measurement.

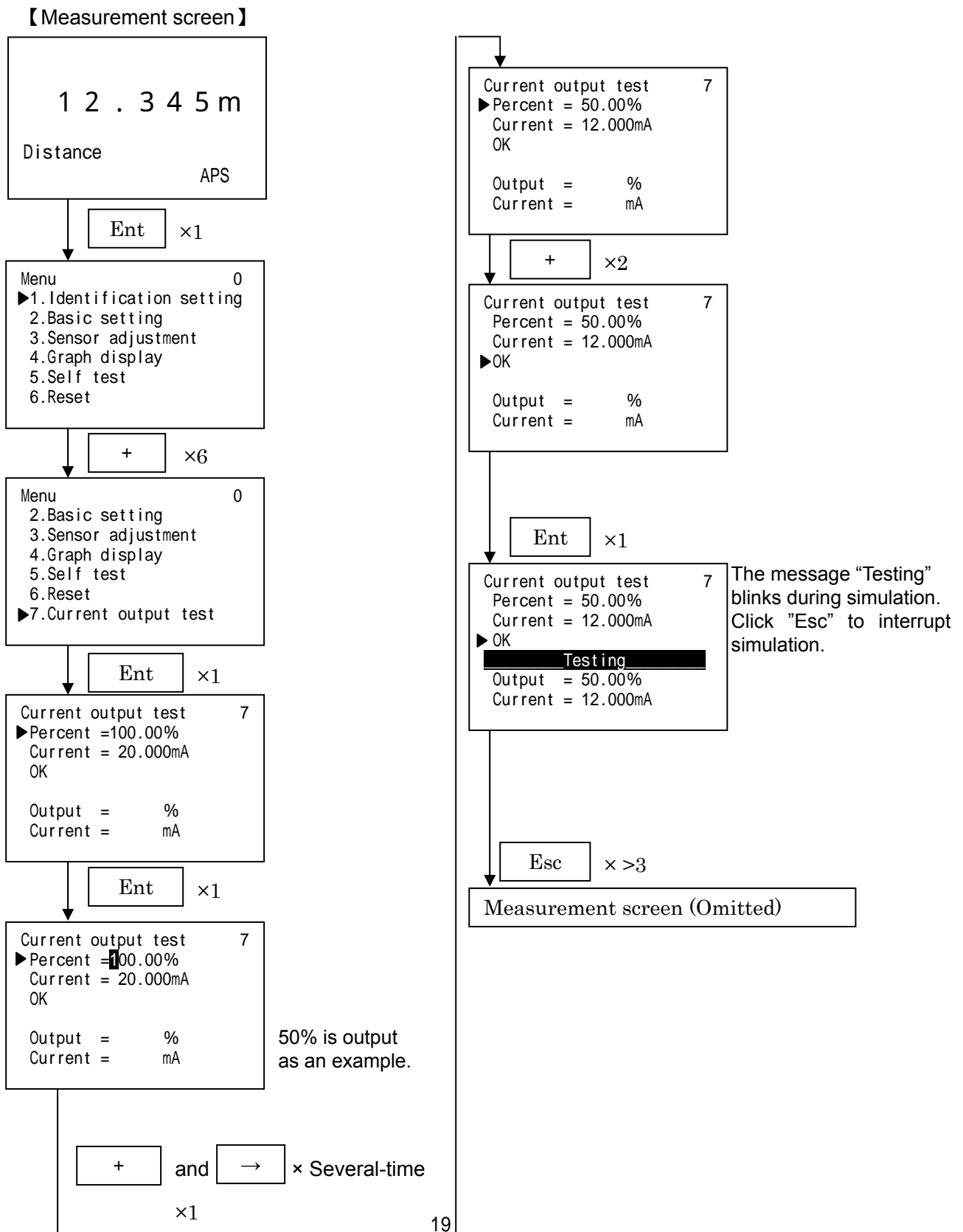

In this manual, only setup steps of the typical parameters have been described.  
Please refer to "Instruction manual for LCD adjustment unit" and "Operating manual for adjustment software Matsushima DTM" for other settings.

## 11 . Troubleshooting

If you encounter any problems, first check if they are described in this section, then execute suggested corrective actions.

Table 3. Troubleshooting

No.	Problem	Check the following	Corrective actions
1	Powered ON the device, but screen is blank	<ul style="list-style-type: none"> <li>• Are wiring connections correct ?</li> <li>• Check whether the power is supplied to the device?</li> </ul>	<ul style="list-style-type: none"> <li>• Correct the wiring</li> <li>• Supply power to the device</li> </ul>
2	Measured level reading higher than material level	<ul style="list-style-type: none"> <li>• Are there any obstructions between antenna and material surface to be measured ?</li> <li>• Are there any inlet streams of material under measurement within the radiation angle</li> </ul>	<ul style="list-style-type: none"> <li>• Execute echo learning to mask false echo from the obstacle</li> <li>• Change the level meter position</li> </ul>
3	Measured level reading lower than material level	<ul style="list-style-type: none"> <li>• Check whether the material surface entered to the blind sector ?</li> </ul>	<ul style="list-style-type: none"> <li>• Change level meter installation</li> </ul>

Table 4. Error codes

No.	Error code	Error type	Description	Corrective actions
1	E8000	SRAM Error	SRAM failure	Turn off device power and turn on again
2	E4000	EEPROM Error	EEPROM failure	
3	E2000	MIC Error	MIC unit failure	
4	E1000	Trig Error	Trigger signal lost	
5	E0800	LCD Error	LCD adj. unit failure	
6	E0400	Charge Error	Charge circuit failure	
7	E0200	I2C Checksum error	Communication between level meter and LCD adj. unit failed	Ensure LCD adj. unit attached properly
8	S.CPU	Level meter not responding	No response from level meter	Turn off device power and turn on again
9	S.I2C	I2C Checksum error	Communication between level meter and LCD adj. unit failed	Ensure LCD adj. unit attached properly
10	E0080	Lost echo	<ul style="list-style-type: none"> <li>• Reflection echo is currently being detected</li> <li>• There is no reflection echo</li> <li>• There is no reflection echo in the measurement span</li> </ul>	<ul style="list-style-type: none"> <li>• Check whether there are adhesives in the horn antenna. If there is adhesives, clean the horn antenna</li> <li>• Optimize measurement span</li> </ul>
11	E0008	Min. meas. limit over	Measured distance is lower than "Min. meas. limit"	Check setting for Min. and Max.meas. limit over, and Upper and Lower range limit over. If you set invalid then error message must be clear. Please note that those settings can be altered by optional PC software only. You can not change by LCD adj. unit
12	E0004	Max. meas. limit over	Measured distance is higher than "Max. meas. limit".	
13	E0002	Upper range limit over (100% over)	Measured distance exceeds "Upper range limit over (100% over)".	
14	E0001	Lower range limit over (0% over)	Measured distance undergoes "Lower range limit over (0% over)".	

Error message No.11 to 14 will be displayed, only when appropriate settings are set to "Valid" by PC adjustment software Matsushima DTM. The default settings are "Invalid".

**If problem persists, please contact your local Matsushima sales office.**

Table 5. Periodic inspection

No.	Item	Descriptions	Interval (standard)
1	Check of	• Confirm whether there is damage on housing etc.	Every 12 months

	appearance	<ul style="list-style-type: none"> <li>• Tighten the cover and lead outlet</li> <li>• Tighten the bolt for installation fixture</li> </ul>	
2	Check of antenna	• Clean the antenna (Solid: Inside , Liquid: Outside)	Every 6 to 12 months



**Important: Standard periodic inspection interval differs depending on measurement condition and measuring material.**

## 12 . Menu structure

□ All values shown here are parameter defaults.

Main menu

