



THE JOKER™ HAS CARJACKED A GOTHAM CITY POLICE CAR!

THE JOKER™ IS ON THE LOOSE DRIVING A "REPAINTED" POLICE CAR IN HOT WHEELS® AI BATMAN™ ARKHAM ASYLUM™ CHASE EDITION!
USE ARTIFICIAL INTELLIGENCE TO HELP STEER YOUR VEHICLE! CHOOSE FROM 3 CHASE MODES AND 3 SKILL LEVELS TO PROGRAM YOUR CONTROLLER. RACE TO SEE WHO WILL CRASH THROUGH THE GATES OF ARKHAM ASYLUM™ FIRST. BUT BEWARE! THE JOKER™ CAN TRICK YOU AT ANY TIME WITH THE JOKER™ ACID, A TIRE BLOWOUT, OR OTHER BATTLE ATTACKS!

Check out videos and lots more at: hotwheels.com/ai

ARKHAM ASYLUM™ CHASE EDITION RACING GUIDE



service.mattel.com
HOTWHEELS.COM

CAUTION: To prevent entanglement, keep all hair away from the wheels.

COLORS AND DECORATIONS MAY VARY.
REQUIRES 6 X AA & 6 X AAA
BATTERIES (NOT INCLUDED).
DISPOSE OF BATTERIES SAFELY.

KEEP THESE INSTRUCTIONS FOR FUTURE REFERENCE
AS THEY CONTAIN IMPORTANT INFORMATION.



Based on DC Comics Characters.

BATMAN V SUPERMAN: DAWN OF JUSTICE and all related characters and elements © & ™ DC Comics and Warner Bros. Entertainment Inc. (s17)



2.4 GHz



8+

©2017 Mattel. All Rights Reserved. ® and ™ designate U.S. trademarks of Mattel, except as noted. Mattel, Inc., 636 Girard Avenue, East Aurora, NY 14052, U.S.A. Consumer Services 1-800-524-8697. Mattel U.K. Ltd., Vanwall Business Park, Maidenhead SL6 4UB. Helpline 01628 500303. Mattel Australia Pty., Ltd., Richmond, Victoria. 3121. Consumer Advisory Service - 1300 135 312. Mattel South Africa (PTY) LTD, Office 102 I3, 30 Melrose Boulevard, Johannesburg 2196. Mattel East Asia Ltd., Room 503-09, North Tower, World Finance Centre, Harbour City, Tsimshatsui, HK, China. Tel.: (852) 3185-6500. Diimport & Diedarkan Oleh: Mattel Southeast Asia Pte. Ltd., No 19-1, Tower 3 Avenue 7, Bangsar South City, No 8, Jalan Kerinchi, 59200 Kuala Lumpur, Malaysia. Tel: 03-78803817, Fax: 03-78803867.

THE FUTURE OF STREET RACING IS HERE!

Batman™ and **The Joker™** square off in **HOT WHEELS®** most tire-roasting high tech chase ever!

- 180mph scale speeds

- Fender rubbing, side-by-side chase action!

- Pit stops, battle attacks and more!

The Chase is On!

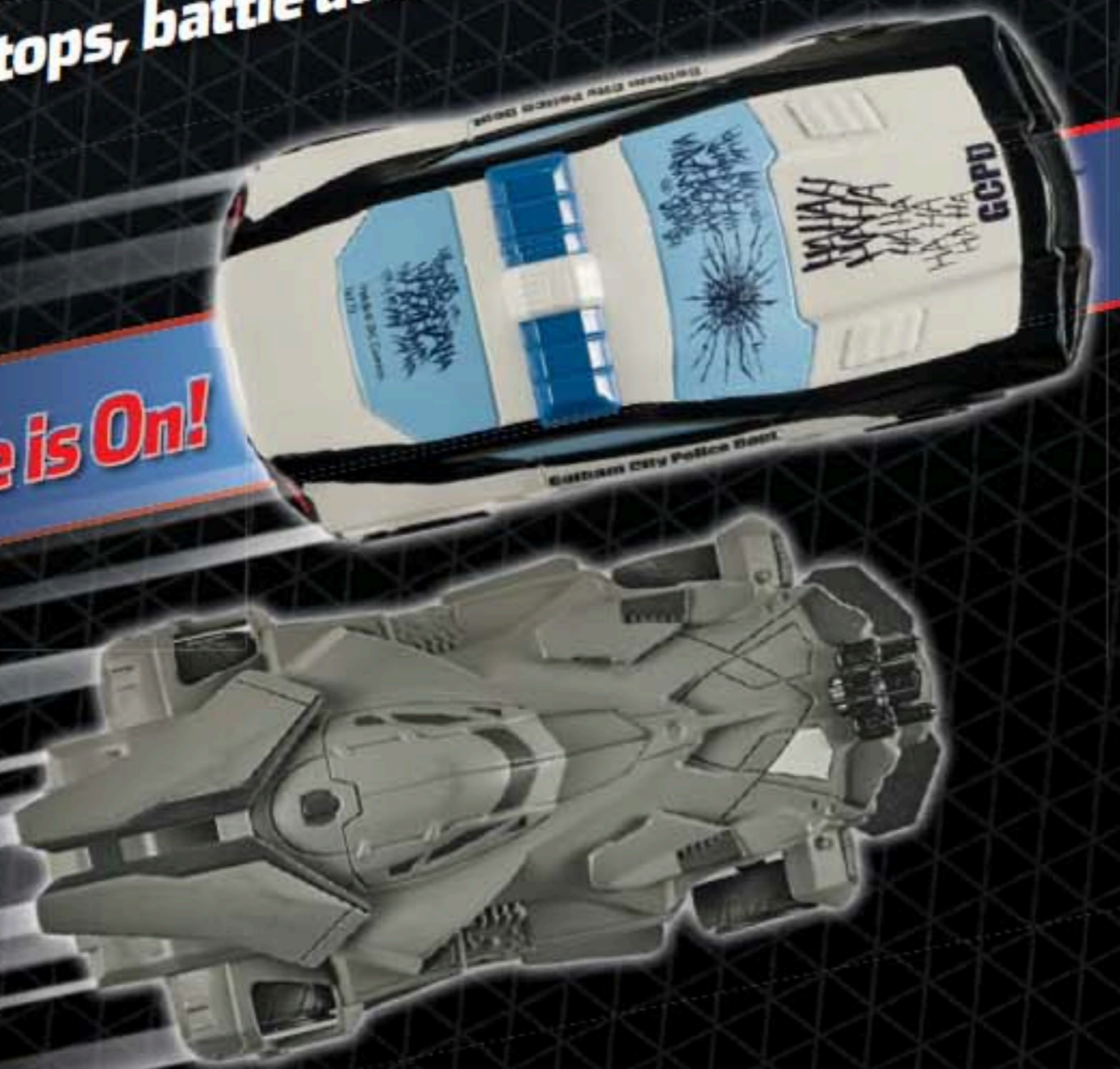

BATTERY SAFETY

In exceptional circumstances batteries may leak fluids that can cause a chemical burn injury or ruin your product. To avoid battery leakage:

- Non-rechargeable batteries are not to be recharged.
- Rechargeable batteries are to be removed from the product before being charged.
- Rechargeable batteries are only to be charged under adult supervision.
- Do not mix alkaline, standard (carbon-zinc), or rechargeable batteries.
- Do not mix old and new batteries.
- Only batteries of the same or equivalent type as recommended are to be used.
- Batteries are to be inserted with the correct polarity.
- Exhausted batteries are to be removed from the product.
- The supply terminals are not to be short-circuited.
- Dispose of battery(ies) safely.
- Do not dispose of this product in a fire. The batteries inside may explode or leak.



Protect the environment by not disposing of this product or any batteries with household waste. This symbol indicates that this product shall not be treated as household waste. Check your local authority for recycling advice and facilities.

FOR PRODUCT SOLD IN USA

This device complies with Part 15 of the FCC Rules. Operation is subject to the following two conditions:
(1) This device may not cause harmful interference, and (2) this device must accept any interference received, including interference that may cause undesired operation.

- This equipment has been tested and found to comply with the limits for a Class B digital device, pursuant to part 15 of the FCC rules. These limits are designed to provide reasonable protection against harmful interference in a residential installation. This equipment generates, uses and can radiate radio frequency energy and, if not installed and used in accordance with the instructions, may cause harmful interference to radio communications. However, there is no guarantee that interference will not occur in a particular installation. If this equipment does cause harmful interference to radio or television reception, which can be determined by turning the equipment off and on, the user is encouraged to try to correct the interference by one or more of the following measures:

- Reorient or relocate the receiving antenna.
 - Increase the separation between the equipment and receiver.
 - Connect the equipment into an outlet on a circuit different from that to which the receiver is connected.
 - Consult the dealer or an experienced radio/TV technician for help.
- NOTE: Changes or modifications not expressly approved by the manufacturer responsible for compliance could void the user's authority to operate the equipment.

HOT WHEELS® Ai TROUBLESHOOTING

TABLE OF CONTENTS

If your HOT WHEELS® Ai Race System isn't working like it should, try these troubleshooting tips.

- SYMPTOM**
- Vehicle will not pair with the controller
 - Vehicle and/or controller continually switches off or restarts
 - Vehicle running slowly / Controller says "Vehicle Batteries Low"
 - Controller says "Connection Lost"
 - Controller frequently says "Connection Lost" after replacing all batteries
 - More than one vehicle pairs with one controller
 - Vehicles slide off of the track at the bends even at low speed
 - The controller is not speaking the language I require
 - Vehicle is driving itself during the Hero mode
 - Controller volume is low
 - Vehicle won't steer into the pit lane
 - Vehicle comes off track in Recon mode
 - Laps not being counted
 - Vehicle does not drive straight in RC/Patrol mode
 - Vehicle does not steer properly

CAUSE

- Batteries in the vehicle or controller are low on power
- Batteries are low or faulty
- Vehicle batteries are low
- Vehicle batteries low (likely) or controller batteries low (possible)
- Interference from other 2.4GHz equipment including WiFi
- Vehicles were turned on simultaneously
- Dust or dirt on the track or vehicle tires or direct sunlight on the track
- Incorrect language set at startup
- Vehicle is set in Ai car mode
- Controller may be set to low volume
- Player does not slow down and steer right to enter the pit lane
- Dust on vehicle tires, sensor windows or Smart Track™/ Track pieces separated
- Dust on sensor windows
- Steering out of alignment
- Vehicle tires/body not fitting correctly

SOLUTION

- Replace old batteries with high quality alkaline batteries
- Replace old batteries with high quality alkaline batteries
- Replace old batteries with high quality alkaline batteries
- Replace vehicle batteries, if the problem persists, replace controller batteries
- Turn off or move away from other sources of 2.4GHz transmissions
- Turn off all vehicles and controllers then turn each controller and vehicle on in turns
- Clean track and tires gently with a clean damp cloth and ensure there is no direct sunlight on the track
- Switch on the controller while holding down the "X" button
- Restart the race
- Increase volume in the system settings menu (see page 8)
- Slow down and steer right to enter the pit lane.
- Wipe with a clean cloth/Check that track pieces are joined correctly with no lumps underneath
- Wipe with a clean cloth
- Adjust steering alignment (see page 15)
- Check tires are securely on the wheel covers/Check body frame is properly attached to the chassis

TROUBLESHOOTING FOR CONTROLLER PLUS CARTRIDGE KIT (SOLD SEPARATELY)

The cartridge was removed while the controller was still on.

1. Turn the controller off.
2. Plug the cartridge cable back into the controller.
3. Turn the controller back on.

Important: Remember to always turn the controller off before disconnecting the cartridge.

*For a full controller reset, remove the batteries from the controller and press the power button for 5 seconds, then reinsert the batteries.

Cartridge sold separately, subject to availability.

- 4 ARKHAM ASYLUM™ CHASE EDITION KIT
- 5 QUICK START! RC/PATROL MODE
- 6 BUILD YOUR SMART TRACK™
- 8 USE YOUR GAMING CONTROLLER
- 8 CUSTOMIZE CONTROLLER SETTINGS
- 9 RECON MODE
- 10 TRAINING MODE
- 11 HERO MODE
- 12 HERO MODE FEATURES
- 13 PIT STOPS
- 13 RC ASSIST
- 14 VEHICLE CUSTOMIZATION
- 15 ADJUST STEERING ALIGNMENT
- 15 FACTORY RESET
- 16 Ai SYSTEM CARE
- 17 HINTS & TIPS
- 18 TROUBLESHOOTING
- 19 BATTERY SAFETY

CHECK OUT VIDEOS AND LOTS MORE AT:
HOTWHEELS.COM/Ai

ALL SYSTEMS GO!



CHASE EDITION KIT

2 HOT WHEELS® Ai SMART CARS



GCPD SQUAD CAR
GOTHAM CITY POLICE DEPARTMENT



BATMOBILE™

2 GAMING CONTROLLERS



24 SMART TRACK™ PIECES

1 ARKHAM ASYLUM™ GATE

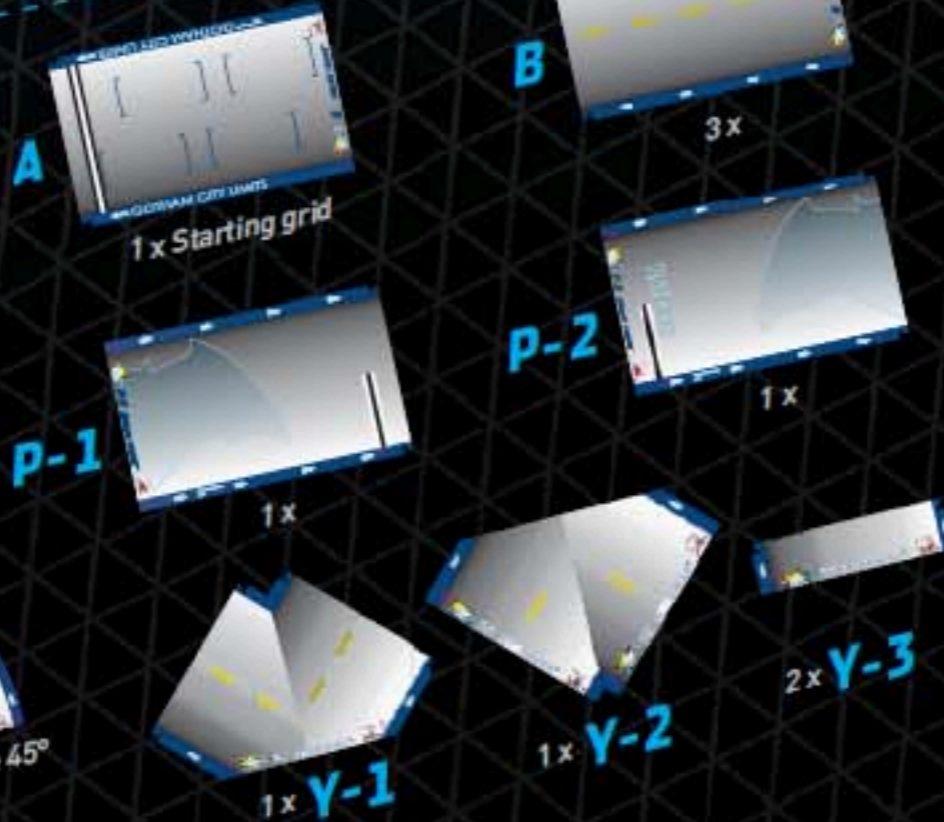

SYSTEM CARE CONTINUED

Do not step on track.



Do not leave track in direct sunlight for prolonged periods.



- Always pack the track flat.
- Do not fold or crease.
- Keep SMART TRACK™ pieces stored in the included Storage Case and ALWAYS pack the track flat and ensure there are no creases.



HINTS AND TIPS

- Works best away from high voltage power lines, large buildings and walls.
- Hold controller antenna up for best performance.
- If controller is accidentally dropped in the water, remove battery(ies) and allow controller to air dry. Replace with fresh battery(ies) before operation.
- **Play Safely!** - Do not drive vehicle on coarse surfaces, off-road or in the street!

HOT WHEELS® Ai SYSTEM CARE

QUICK START! RC / PATROL MODE

For the best HOT WHEELS® Ai performance, always keep your Ai Street Racing System in prime operating condition.

VEHICLE CARE

- Use a clean damp cloth when cleaning the SMART CAR frame and tires.



- Use a clean dry cloth when wiping down your chassis and track sensors.

SMART TRACK™ CARE

Clean SMART TRACK™ with a lightly damp cloth. Do not build track on a slippery surface.



1

PREP YOUR RACE CAR & GAMING CONTROLLER

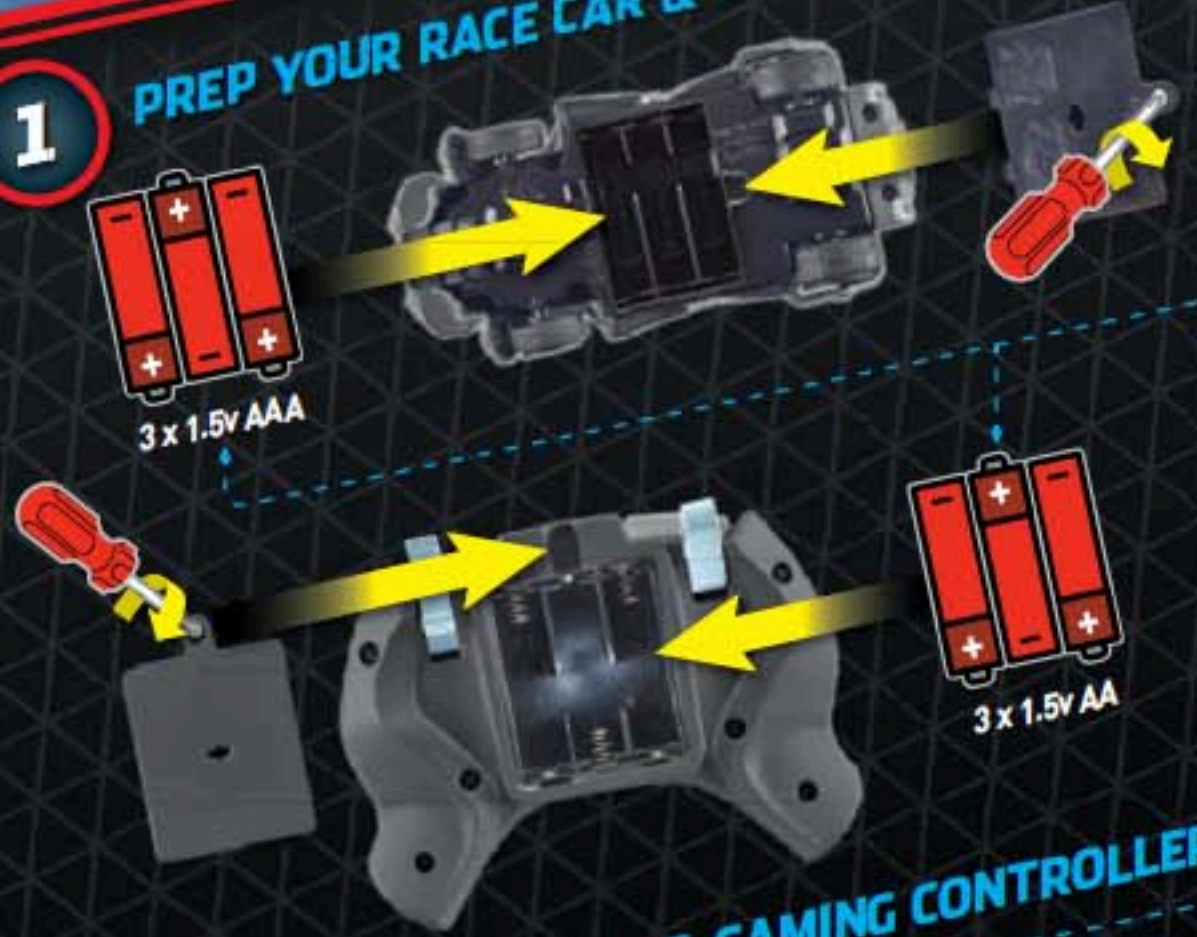

- Open and close the battery cover with a Phillips head screwdriver (not included).
- Batteries not included. Dispose of batteries safely.

- Languages available:
English
German
Russian
Castilian Spanish
Latin American Spanish
French
Italian

2

SYNC YOUR RACE CAR & GAMING CONTROLLER



- Press the button to POWER ON your controller.
- If playing for the first time (or after loading a new set of batteries) you will be asked to select a language.
- Use the STEERING STICK to toggle left and right until you hear the language you want to play in.
- Press the button to select.
- Turn the vehicle power switch to I and listen for confirmation.

3

RC / PATROL MODE!



- Press the button to engage Patrol mode and race on track or off without the Ai track assistance. You're in control!
- Vehicles are not recommended for rough terrain or outdoor play.

BUILD YOUR SMART TRACK™

HOT WHEELS® AI SMART TRACK™ is specially constructed of a durable and flexible lightweight vinyl material with a special finish that allows vehicle track sensors to interpret the position of your **SMART CAR** on the track!

1 CONNECT



Setting up SMART TRACK™ is easy. Insert tabs in slots as shown at left.

2 ADDING THE PIT LANE



3 DISCONNECT

Take track apart by pulling tabs out of the slots as shown. Be careful not to pull the tabs at an angle as this may cause the tab or slot to tear or split.

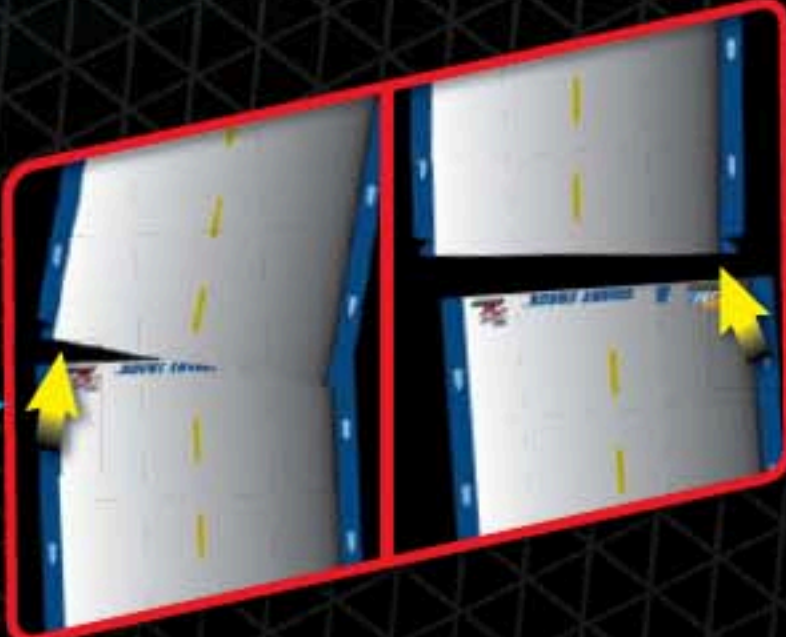

ADJUST STEERING ALIGNMENT

From time to time (especially after you crash), you may need to adjust the steering on your **HOT WHEELS® AI SMART CARS**. It's easy!

1. Connect the vehicle and push the button.
2. Use the steering stick to toggle left or right through the editable settings for ADJUST STEERING.
3. Push the button and follow the voice prompts.
4. Drive your SMART CAR slowly backward and forward without steering to see if it runs towards the left or right.
5. Correct the steering by pushing the steering stick in the opposite direction of the way the SMART CAR runs towards.
6. Each time you turn the steering stick left or right, you will hear a 'beep' that confirms you have adjusted the steering one notch in that direction.
7. Once you are done, press the button to return to the main menu.



ADJUST STEERING

FACTORY RESET

You can return your controller to the original factory settings at any time. **Here's how!**

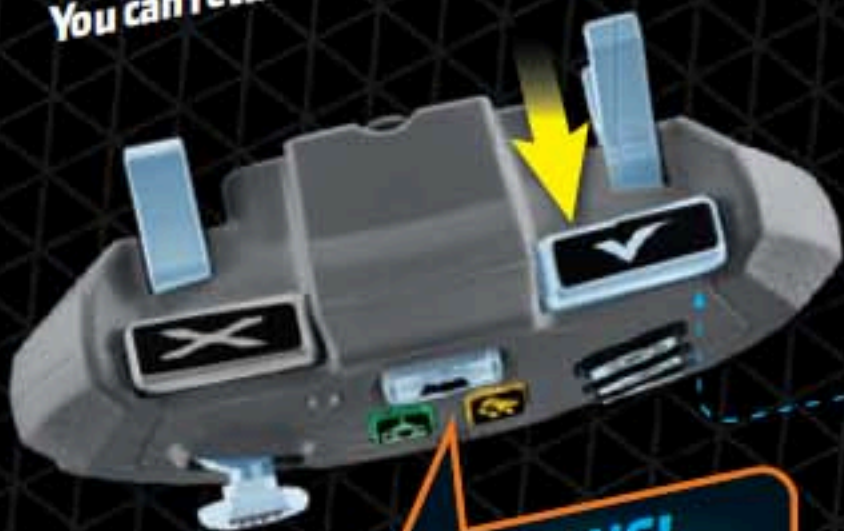

WARNING! FACTORY RESET!

1. Connect the SMART CAR and push the button.
2. Use the steering stick to toggle left or right through the editable settings for FACTORY RESET.
3. Push the button.
4. After you hear the WARNING voice prompt, press the button again to confirm.
5. A series of 'beep's will play to confirm you have reset your controller to original factory status.

VEHICLE CUSTOMIZATION

HOT WHEELS® AI lets you customize your race vehicle by swapping SMART CAR frames and wheel covers.

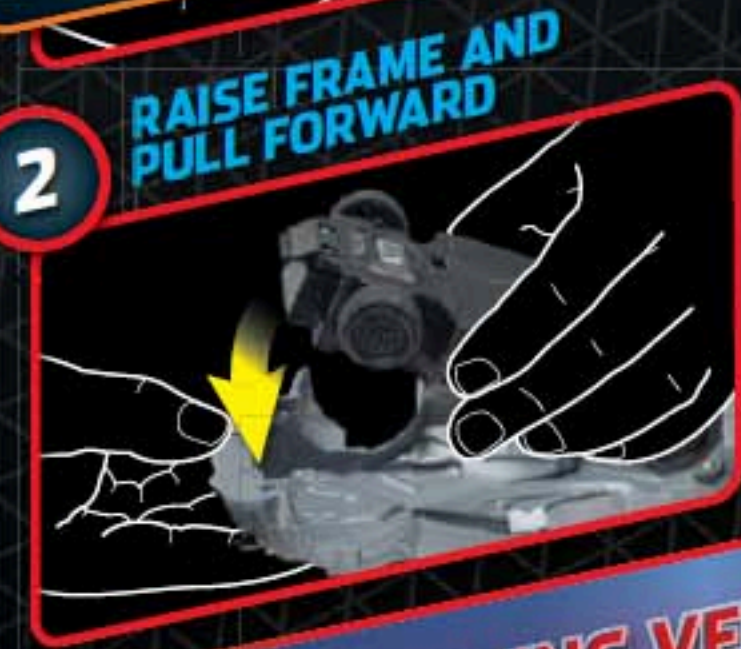

CHANGING VEHICLE WHEEL COVERS



4 ADDING ARKHAM ASYLUM™ GATE

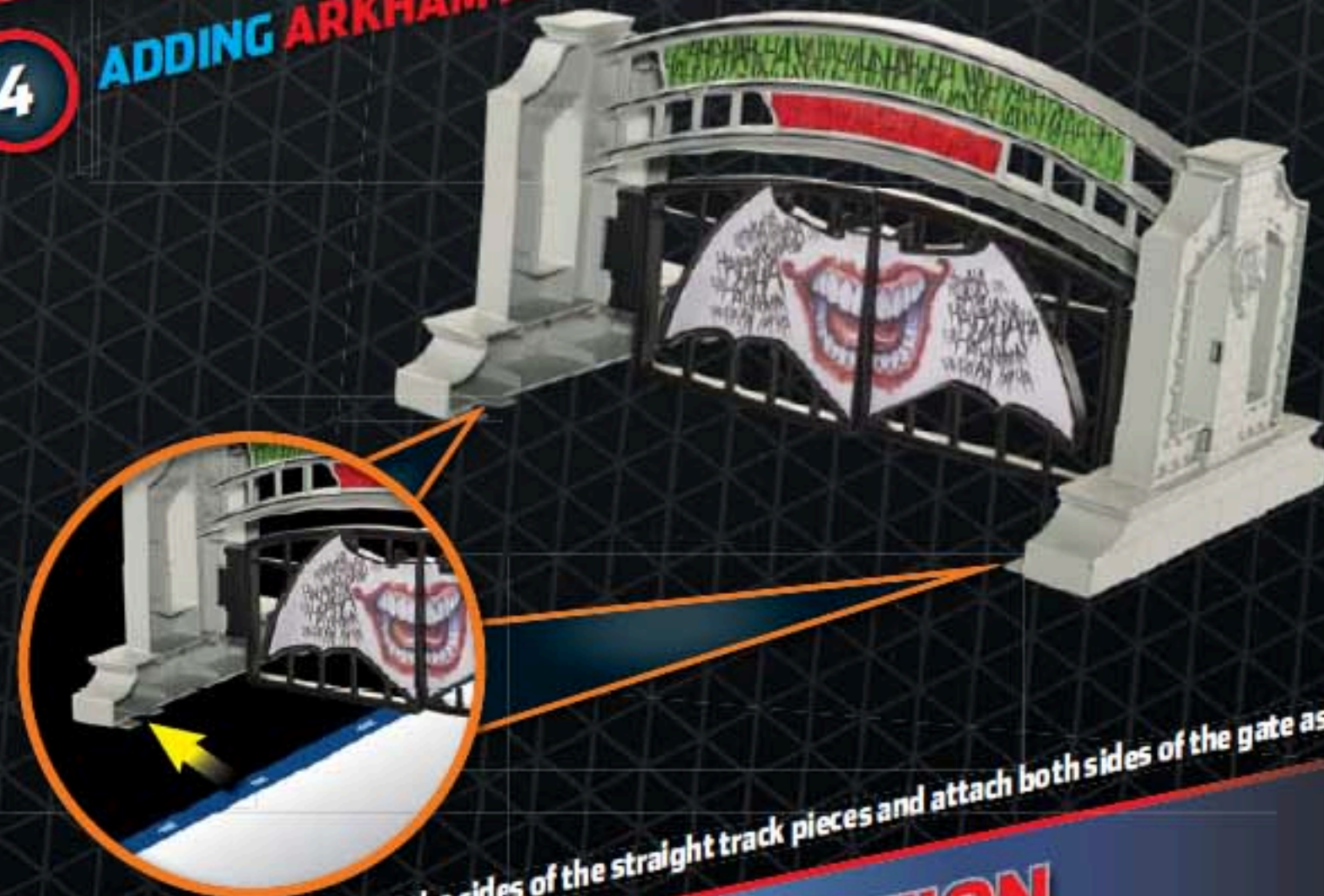

Look for the additional slots on the sides of the straight track pieces and attach both sides of the gate as shown.

TRACK CONFIGURATION

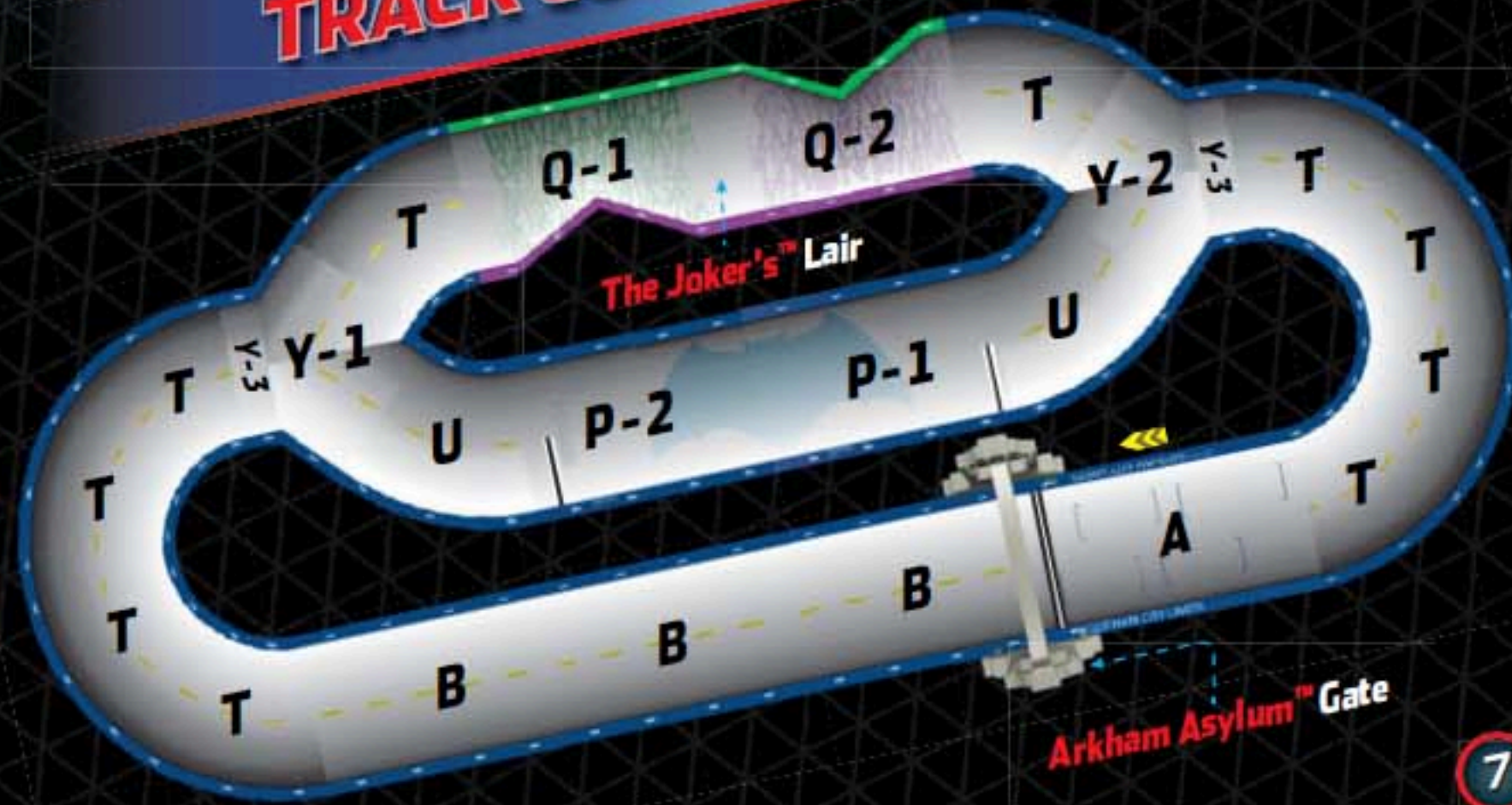

USE YOUR GAMING CONTROLLER

TIME FOR A PIT STOP!

The **GAMING CONTROLLER** gives you the power to control your vehicle and set up the race!



• These controls can only be used when racing on **HOT WHEELS® SMART TRACK™**.

When you run out of Battle Attacks ⚠️ you will need to make a **PIT STOP** to reload. Steer to the pit lane and carefully drive **IN** and **OUT** of the pit.

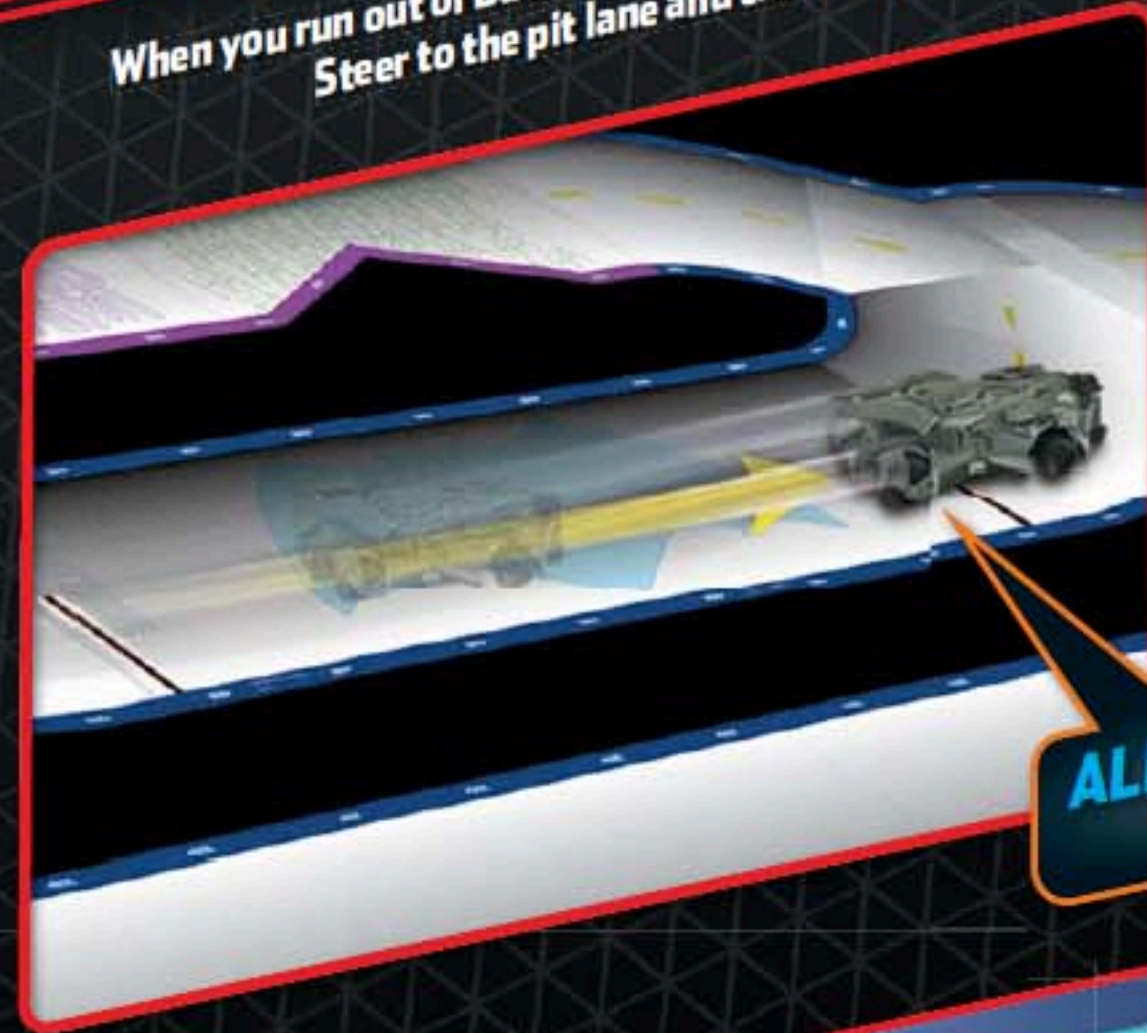

• **IMPORTANT:** You need to manually **STEER RIGHT** to enter the pit lane, or you will automatically be detoured to **the Joker's™ Lair**.
 • After you successfully PIT you will hear a confirmation voice prompt and the battle attacks are now reloaded.

ALL SYSTEMS GO!

CUSTOMIZE GAMING CONTROLLER SETTINGS

Your **GAMING CONTROLLERS** and **SMART CARS** come ready to race right out of the box. Use them the way they are or tweak their performance.

- Press the button.
- Use the **STEERING STICK** to toggle left and right through the editable settings.



VRRROOM!

SPEAKER VOLUME

- Press the button to enter.
- Toggle left and right to adjust the controller volume from 1 to 5.
- Then press the button to confirm.

ENGINE SOUNDS

- Press the button to enter.
- Toggle left and right to turn engine sounds ON and OFF.
- Then press the button to confirm.

RC ASSIST

- In **TRAINING** and **HERO** modes, if at any time you drive off-track, or want to temporarily disable track assistance, you can push the button to activate **RC ASSIST**.
- This mode allows you to navigate back to track fully under your control. A slow BEEP will alert you that you are in **RC ASSIST** mode, press the button again to deactivate and re-engage the sensors once you are back on track.



ADJUST STEERING (Page 15)
FACTORY RESET (Page 15)

HERO MODE FEATURES

HERO MODE has **3 SKILL LEVELS**, each with its own unique set of gameplay features.

1

ROOKIE

For Hot Wheels® AI newbies, ROOKIE level provides:

- HIGH track assistance
- Limited acceleration and steering
- No battle attacks

There's no chance of driving off-track, so go ahead and step on the gas!

2

SIDEKICK

For more skilled players, SIDEKICK level offers:

- MEDIUM track assistance
- MODERATE acceleration and steering
- Two battle attacks (Engine Failures and Missed Gears)

Watch your speed on the turns or you may race off-track.

3

ADVANCED

For experienced players, ADVANCED level offers:

- LOW track assistance
- FULL acceleration and steering
- All four battle attacks (Engine Failures, Missed Gears, The Joker™ Acid and Tire Blowouts)

This is the ultimate Hot Wheels® AI race experience, GAME ON!

BATTLE ATTACKS are only available in SIDEKICK and ADVANCED levels:

- Press the Battle Attack trigger to launch an attack at the player ranked ahead of you. If you are in 1st place, your attack will hit the 2nd place-ranked car.
- There are four different battle attacks in Hot Wheels® AI and each one affects your SMART CAR performance differently:

ENGINE FAILURE: Slows your vehicle to a crawl.

MISSED GEAR: Temporarily impacts vehicle speed.

THE JOKER™ ACID (ADVANCED LEVEL ONLY) - SPIN OUT!

TIRE BLOWOUT (ADVANCED LEVEL ONLY) - Vehicle slows and swerves to the side of the track.

• Use battle attacks wisely as you only start the race with 3. Once they are gone, you must make a pit stop to reload them. (NOTE: RECON cars will not fire weapons unless you fire first. Once you do, it's battle on!)

• Each time you pit and reload your battle attacks, all RECON cars will reload automatically.

RACING OFF TRACK

- If you get hit by a battle attack or take a turn too fast and race off the track, activate the RC ASSIST mode to disengage the track sensors and steer back to the track. IMPORTANT: If racing in RECON MODE, your car must be placed back on the track by hand.



WHOA!

RECON MODE

Want to watch the AI SMART CARS race around your custom track entirely on their own? Place your vehicle on the starting line and then choose the RECON mode for the ultimate hands-free race.

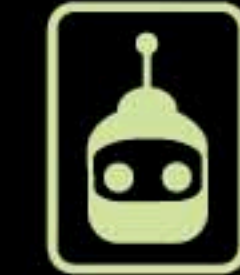

RECON MODE

- Press the  button to see your car race around the track entirely on its own!



RECON MODE!

HONE YOUR SKILLS IN TRAINING MODE!

Want to hit the track fast and go for your fastest lap time? Then **TRAINING MODE** is for you!

1

- Press the  button
- Press the  button to choose your SKILL LEVEL



CAREFUL!
In Advanced level the AI Track Assistance is turned way down, so you have to turn your racing skills way up. Watch your speed on the turns or you WILL spin out and race off track!

2 PLACE YOUR VEHICLE BEHIND THE STARTING LINE!



10

- ROOKIE**
High track assistance and limited acceleration for Hot Wheels® Ai newbies.
- SIDEKICK**
More power and more control for experienced players.
- ADVANCED**
Low track assistance and HIGH power for real speed demons.

- NOTE:** Always place vehicles on track so they race in a clockwise direction. Racing the wrong direction will severely affect the steering and performance of your Ai vehicles.
- Press the  button and wait for the starting command.
 - In TRAINING MODE the gaming controller will give you updates on lap times and your FASTEST LAP. Drive carefully and try to beat your best time.
 - Press the  button at any time to hear your FASTEST LAP time again.
 - You can exit TRAINING MODE at ANY time, simply press the  button to Exit.
 - When asked if you want to EXIT mode, press the  button again.

HERO MODE

Ready to compete against friends or challenge HOT WHEELS® Ai vehicles controlled by Artificial Intelligence? Then it's time for **HERO MODE!**

1



SETTING UP A RACE

- Press the  button.
- IMPORTANT!** The first controller to select HERO MODE will automatically become Player 1 and control the race and all race settings.
- Press the  button to choose your SKILL LEVEL, Rookie, Sidekick, Advanced.

2

ADDING AI CONTROLLED VEHICLES

- Connect your gaming controller and vehicle in turns.
- Press the  button.
- Wait to hear a confirmation voice prompt.
- Choose  after joining the race, but BEFORE placing vehicle on the track.
- NOTE:** Ai cars will automatically be set to the same SKILL LEVEL as Player 1 (the race host).
- Place the Ai vehicle on the starting grid and press the  button.
- When all vehicles are ready behind the starting line, player 1 must press the  button and wait for the starting command.

- Press the  button.
- Choose the number of laps.
- Use the STEERING STICK to toggle left and right to set the number of laps.
- When you hear the number of laps you want, press the  button.
- Place your vehicle on the starting grid and wait for other players.
- Other players can join the race too, either vehicles controlled by friends or vehicles controlled by Hot Wheels® Ai.
- To add friend-controlled vehicles:
 - Connect your gaming controller and vehicle in turns.
 - Press the  button.
 - Wait to hear a confirmation voice prompt.
 - Place your vehicle on the starting grid.

- In HERO MODE the gaming controller will give you updates on lap number, race position, battle attacks if any and alert you when you need to Pit.
- Press the  button at any time to hear your player number and fastest lap time.
 - You can exit HERO MODE at ANY time, simply press the  button to Exit.
 - When asked to EXIT, press the  button. If you are Player 1, this will end the race for all Players.
 - NOTE:** During the race, any Players except Player 1 can drop out at any time while others continue to race.

YOU'VE JOINED THE CHASE!



11