

Barbie

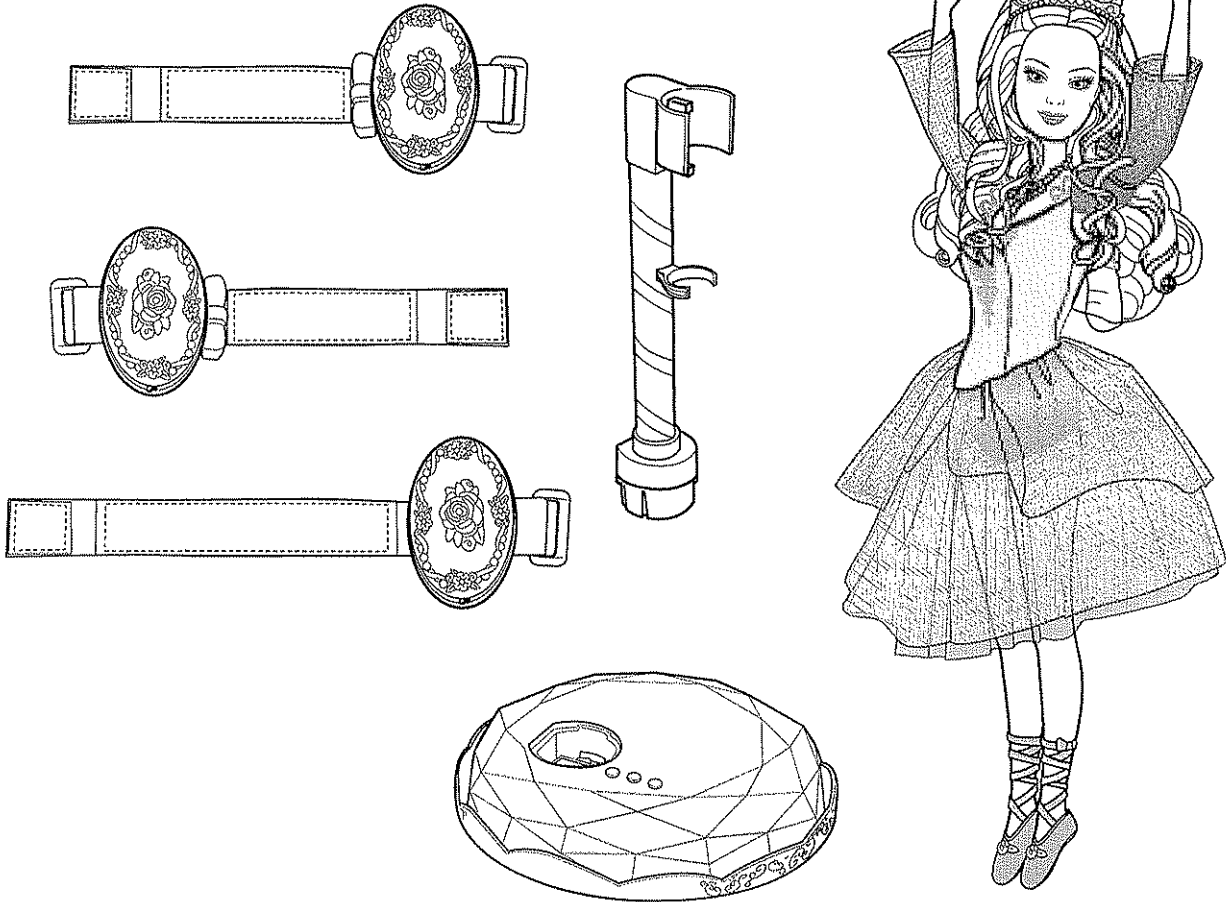

## Instructions

Toy requires 4 "AA" and 6 "AAA" Alkaline batteries (not included).

Colours and decorations may vary from those shown.

**Contents:** Please remove everything from the package and compare to the contents shown here. If any items are missing, please contact your local Mattel office. Keep these instructions for future reference as they contain important information.

J8865-0920G1

 **WARNING:**  
CHOKING HAZARD - Small parts.  
Not for children under 3 years.

**ADVERTENCIA:**  
PUEDE CAUSAR ASFIXIA.  
No recomendable para menores de  
3 años. Contiene piezas pequeñas.

3+



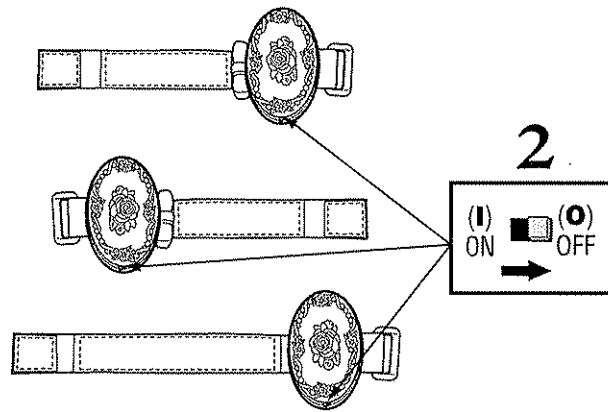
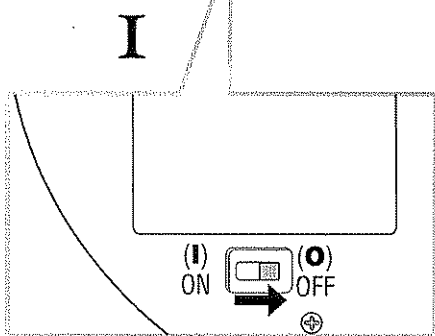
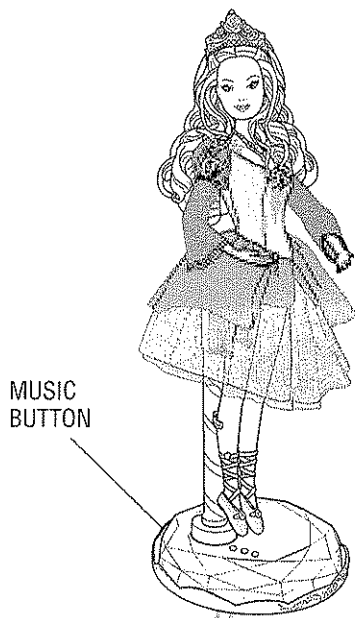

**“PLAY WITH DOLL AWAY FROM BASE”:**

1. Turn dance base ON (I)/OFF (O) switch to OFF (O).
2. Turn controllers ON (I)/OFF (O) switches to OFF (O) and remove from child’s wrists and foot.
3. Child may now play with doll away from dance base.
4. When finished with play, pose doll on base to display.

*Doll cannot dance or stand alone.*

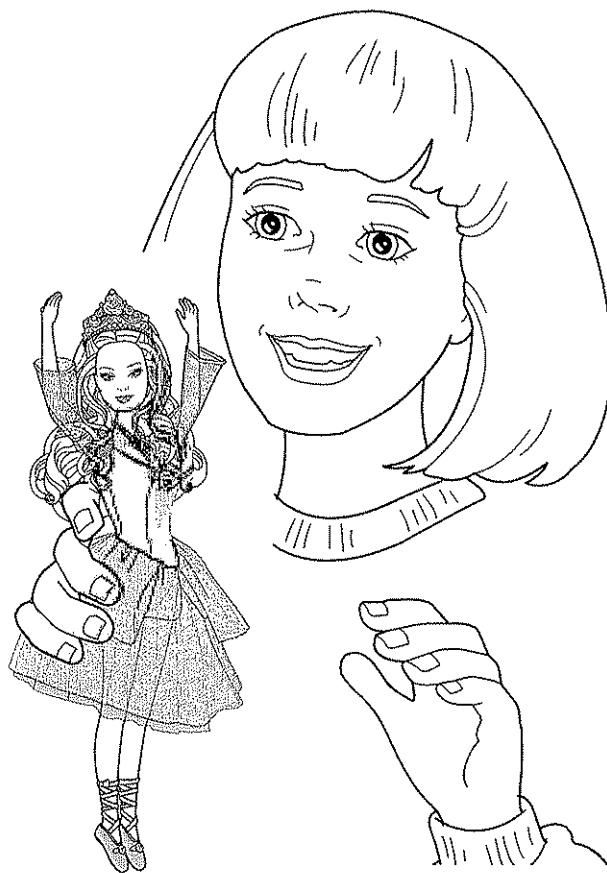
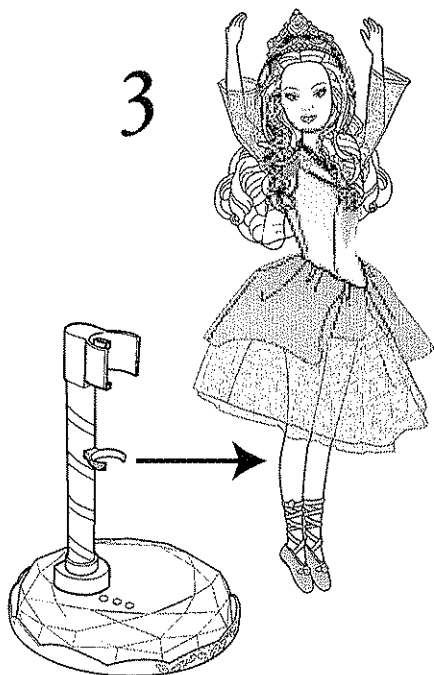

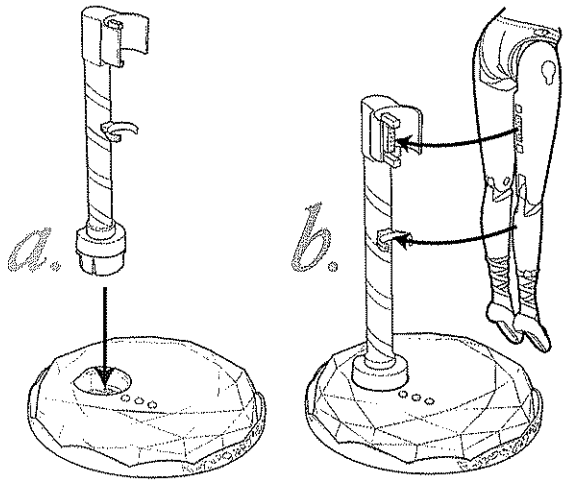

Fasten doll stand onto base.

Attach doll onto stand and place base on smooth, flat surface. If played with on a table, place it at least 6" from the edge.

Turn base, left wrist, right wrist and right leg controllers ON (I)/OFF (O) switches to ON (I).

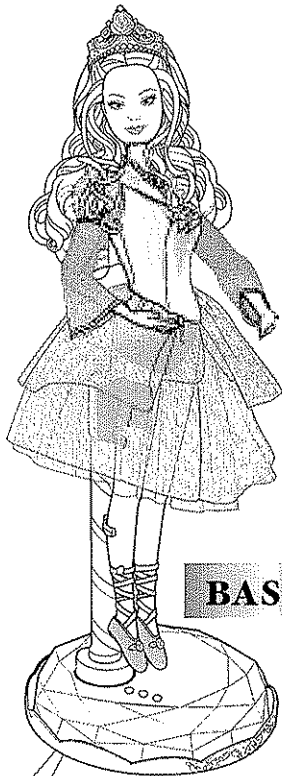

**BASE**



**3 ways to play!**

*She'll teach you!*

"Very good!"

*Dance together!*

*She performs!*

MODE  
BUTTONS

MUSIC  
BUTTON

4

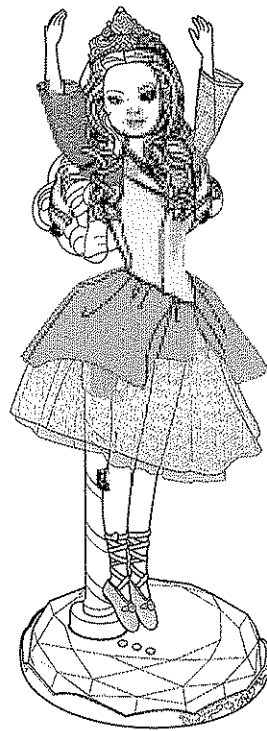

## *Quick Tips*

1. Move the controllers closer to the base and restart the unit again if doll does not respond.
2. When the doll slows down, or the sounds become garbled, change the batteries.
3. Position controllers correctly on wrists and leg and stand within 6 feet of base.
4. Product works best indoors away from direct sunlight and unobstructed by other objects.
5. One set of controllers will operate multiple dolls with the same frequency (49 MHz).  
Multiple controllers used in close proximity will cause interference and poor performance.
6. Doll's arms and legs may be repositioned manually. If a "clicking" sound is heard, that is normal.
7. If doll's hands get stuck in dolls hair or clothing, bend doll's arms to move them out of the way.
8. Always turn switches OFF (O) and remove all batteries for storage.
9. If not played with for a while, toy will go into a "sleep" mode. Press any button to "wake up" toy.
10. The child may switch the wrist and ankle controllers to the opposite arms/leg, which will allow the child's and doll's same arms/legs to move rather than to mirror image each other.

## *Safety Precautions*

Adults, this toy is recommended for children 3 years of age and older. To ensure that the child's play is both safe and fun, please review the operating instructions and these general rules with the child.

- DO NOT pick up doll while in motion.
- Keep child's fingers, hair and loose clothing away from the doll when it is switched ON (I).
- To avoid accidental operation, remove batteries when not in use.

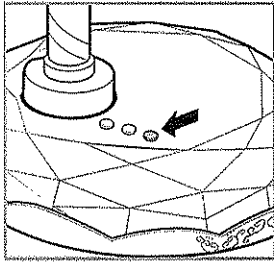

HOT PINK  
BUTTON



"I love dancing  
with you!  
...Begin!"



**"TEACH ME" mode:** Doll shows and tells child how to make one movement at a time, then asks the child to imitate the movement. Press MODE BUTTON any time to go to the next dance sequence.

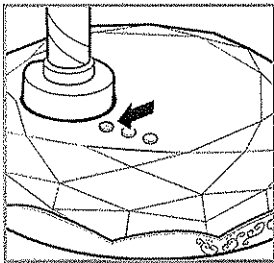

GOLD  
BUTTON



**"PLAY WITH ME" mode:** As child moves both wrists and RIGHT foot to certain positions (up, down, to the front and back), the doll will move her arms and left leg in response.

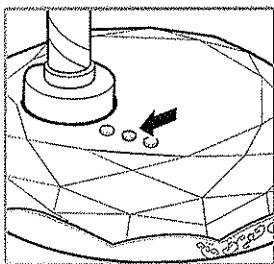

LIGHT PINK  
BUTTON

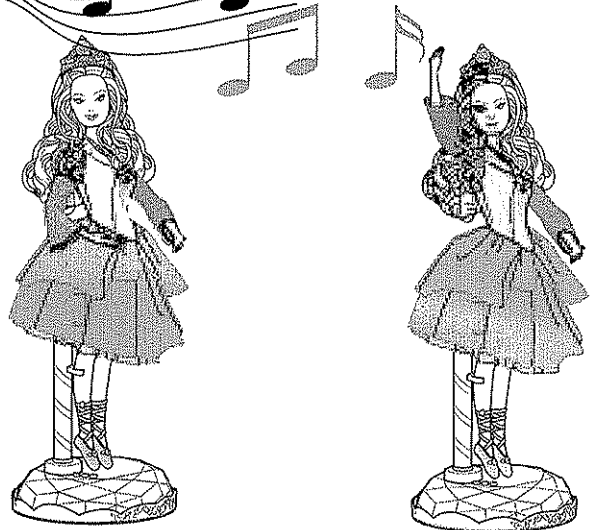
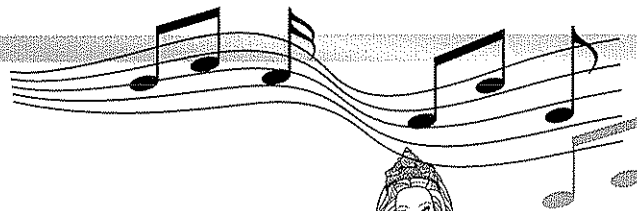

**"PERFORMANCE" mode:** Doll performs multiple dance routines while music plays. Press MODE BUTTON any time to go to the next dance sequence.

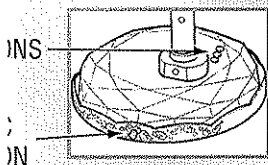

To play with toy with music off, press the MUSIC BUTTON. Press once more to play music again.

When ON (I)/OFF (O) button is switched OFF (O) and then back to ON (I), the doll will start at the first dance.

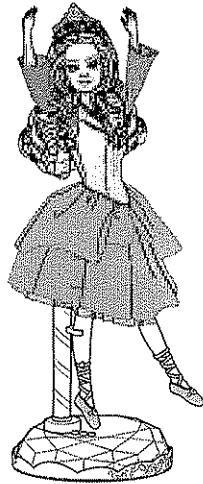
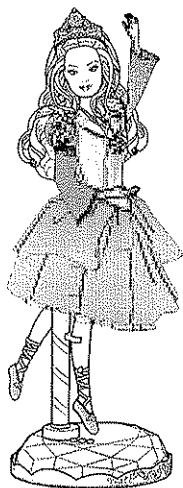
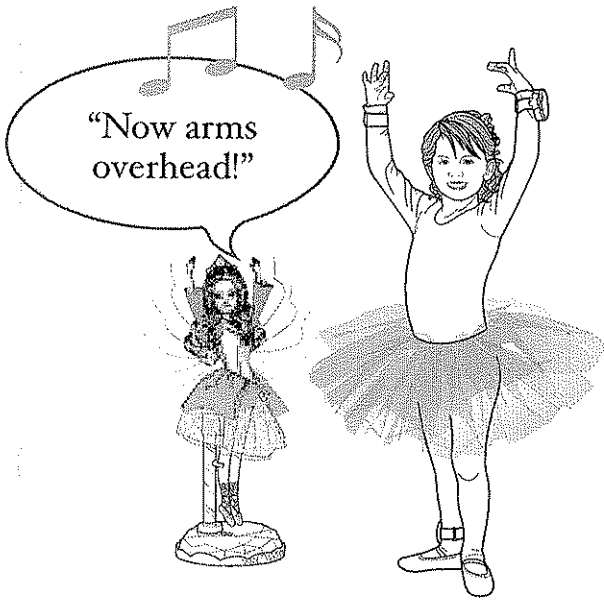

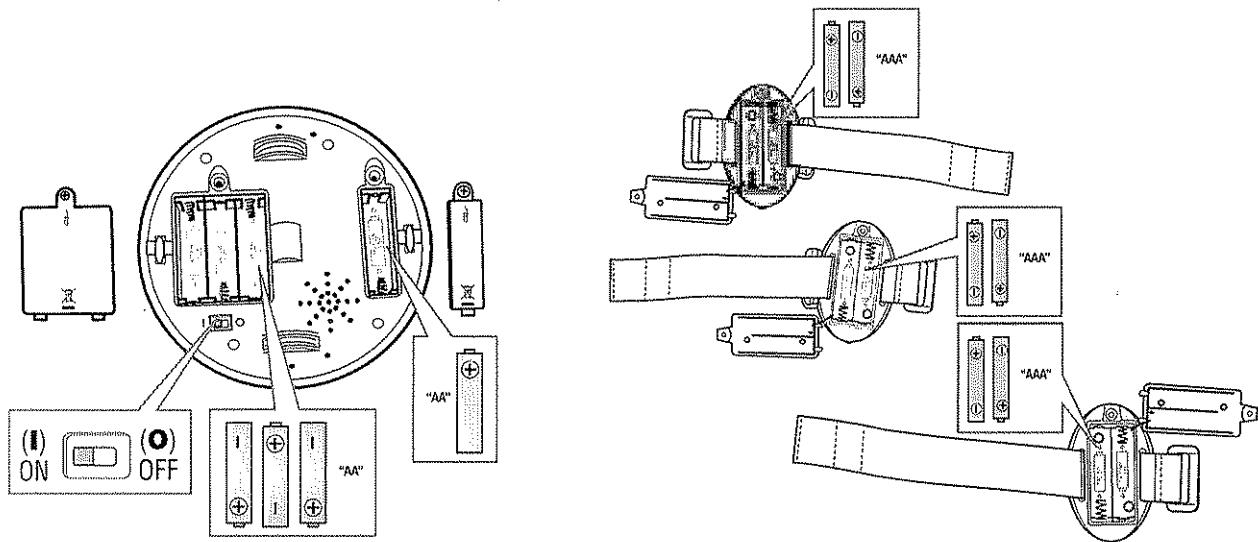

**Battery Installation:** Toy requires 4 "AA" and 6 "AAA" Alkaline batteries (not included) to operate. Use a Phillips head screwdriver (not included) to open battery doors. Insert alkaline batteries as shown. Replace battery covers and screw closed. When the doll does not respond, slows down, or the sounds become garbled, *change all the batteries at the same time for each part*. For longer life use only alkaline batteries. Dispose of batteries safely.

## CONTROLLERS

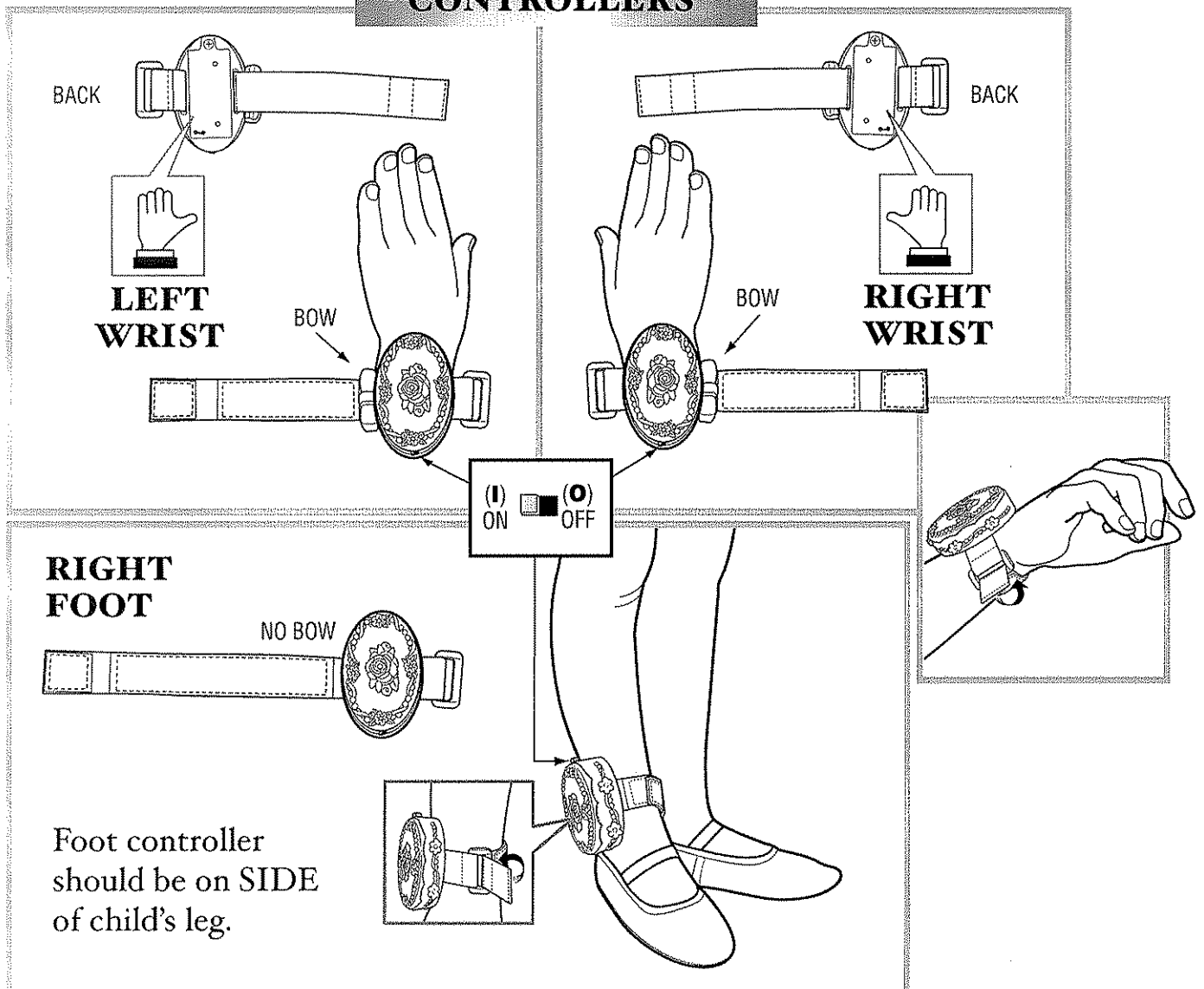



Radio-controlled toy from up to 6 feet (1.8 m) away

**For product sold in Canada • Pour les produits vendus au Canada**

**THIS CLASS B DIGITAL APPARATUS COMPLIES WITH CANADIAN ICES-003.**

**CET APPAREIL NUMÉRIQUE DE LA CLASSE B EST CONFORME À LA NORME NMB-003 DU CANADA.**

**(VALID FOR CANADA ONLY • VALABLE AU CANADA SEULEMENT)**

Operation is subject to the following two conditions :

(1) this device may not cause interference, and (2) this device must accept any interference, including interference that may cause undesired operation of the device.

L'utilisation de ce dispositif est autorisée seulement aux conditions suivantes :

(1) Il ne doit pas produire de brouillage et (2) il doit pouvoir tolérer tout brouillage radioélectrique reçu, même si ce brouillage est susceptible de compromettre son fonctionnement.

Carrier frequency: 49.860MHz

Field strength: 50.9dBuV/m at 3m

This radiocommunication device complies with all the requirements of Industry Canada Standard RSS-310.

Ce dispositif de radiocommunication rencontre toutes les exigences de la norme CNR-310 d'Industrie Canada.

**For product sold in USA**

This device complies with Part 15 of the FCC Rules.

Operation is subject to the following two conditions:

(1) This device may not cause harmful interference, and (2) this device must accept any interference received, including interference that may cause undesired operation of the device.

NOTE: This equipment has been tested and found to comply with the limits for a Class B digital device, pursuant to part 15 of the FCC rules. These limits are designed to provide reasonable protection against harmful interference in a residential installation.

This equipment generates, uses and can radiate radio frequency energy and, if not installed and used in accordance with the instructions, may cause harmful interference to radio communications. However, there is no guarantee that interference will not occur in a particular installation. If this equipment does cause harmful interference to radio or television reception, which can be determined by turning the equipment off and on, the user is encouraged to try to correct the interference by one or more of the following measures:

Reorient or relocate the receiving antenna.

Increase the separation between the equipment and receiver.

Connect the equipment into an outlet on a circuit different from that to which the receiver is connected.

Consult the dealer or an experienced radio/TV technician for help.

Mattel, Inc.

Consumer Relations

636 Girard Ave

East Aurora, NY

(800) 524-8697

NOTE: Changes or modifications not expressly approved by the party responsible for compliance could void the user's authority to operate the equipment.

**BATTERY SAFETY INFORMATION**

In exceptional circumstances batteries may leak fluids that can cause a chemical burn injury or ruin your product. To avoid battery leakage:

- Non-rechargeable batteries are not to be recharged.
- Rechargeable batteries are to be removed from the product before being charged (if designed to be removable).
- Rechargeable batteries are only to be charged under adult supervision (if designed to be removable).
- Do not mix alkaline, standard (carbon-zinc), or rechargeable (nickel-cadmium) batteries.
- Do not mix old and new batteries.
- Only batteries of the same or equivalent type as recommended are to be used.
- Batteries are to be inserted with the correct polarity.
- Exhausted batteries are to be removed from the product.
- The supply terminals are not to be short-circuited.
- Dispose of battery(ies) safely.
- Do not dispose of this product in a fire. The batteries inside may explode or leak.

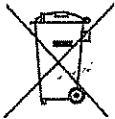

Protect the environment by not disposing of this product with household waste (2002/96/EC).

Check your local authority for recycling advice and facilities.

**CONSUMER INFORMATION**

Need Assistance? Visit [service.mattel.com](http://service.mattel.com) or call 1-800-524-8697 (US and Canada only), M-F 9AM - 7PM & SAT 11AM - 5PM, Eastern.

**SERVICE.MATTEL.COM**

Mattel Canada Inc., Mississauga, Ontario L5R 3W2. You may call us free at 1-800-524-8697.  
Mattel U.K. Ltd., Vanwall Business Park, Maidenhead SL6 4UB. Helpline 01628500303  
Mattel Australia Pty. Ltd., Richmond, Victoria, 3121. Consumer Advisory Service - 1300 135 312.  
Mattel East Asia Ltd., Room 1106, South Tower, World Finance Centre, Harbour City, Tsimshatsui, HK, China. Diimport & Diedarkan Oleh: Mattel SEA Ptd Ltd.(993532-P) Lot 13.5, 13th Floor, Menara Lien Hoe, Persiaran Tropicana Golf Country Resort, 47410 PJ. Tel:03-78803817, Fax:03-78803867. Mattel, Inc., 333 Continental Blvd., El Segundo, CA 90245 U.S.A. Consumer Affairs 1 (800) 524-8697.