



95170-0920



**TYCO® R/C SUPPORT
REGISTER YOUR
VEHICLE 2 WAYS!**

Online...or toll-free!

tycorc.com

1-888-557-TYCO (8926)

If you have questions or problems with your vehicle,
DON'T RETURN IT TO THE STORE...
get help from the EXPERTS! Just click or call.



CAUTION: Surfaces may become hot
and cause burns if electronics get wet. Do
not operate vehicle through water or snow.



OWNER'S MANUAL

Please read thoroughly before operating your vehicle. Keep these instructions for future reference: they contain important information.

MATTEL WHEELS®



I. CONTENTS

- TMH® TONY HAWK SKATEBOARD Vehicle
- Transmitter

FEATURES

- Adaptive Control System™ for world-champ tricks and stunts

- Authentic Tony Hawk rider figure
- Available in 2 frequencies: 27 MHz & 49 MHz (refer to labels on transmitter & vehicle for frequency)
- Range up to 65'/20m

VEHICLE

- ❶ ON/OFF Switch
- ❷ Steering Adjuster
- ❸ Battery Door
- ❹ Battery Compartment

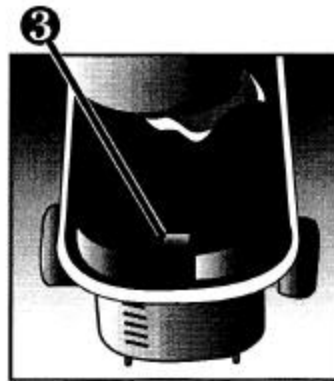
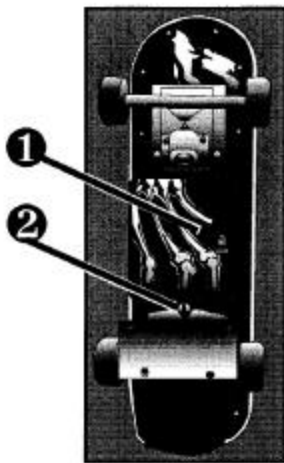

II. QUICK START

 Please read this Owner's Manual thoroughly.

1. Start with a full charge.
2. Turn vehicle switch ON. Activate transmitter to run and control your vehicle.
3. When you're done driving, turn vehicle switch OFF. Remove all batteries for storage.



III. OPERATING YOUR VEHICLE



Your vehicle features the digital Adaptive Control System™ for the ultimate in control...and amazing stunt action. Each transmitter control stick has seven different positions.

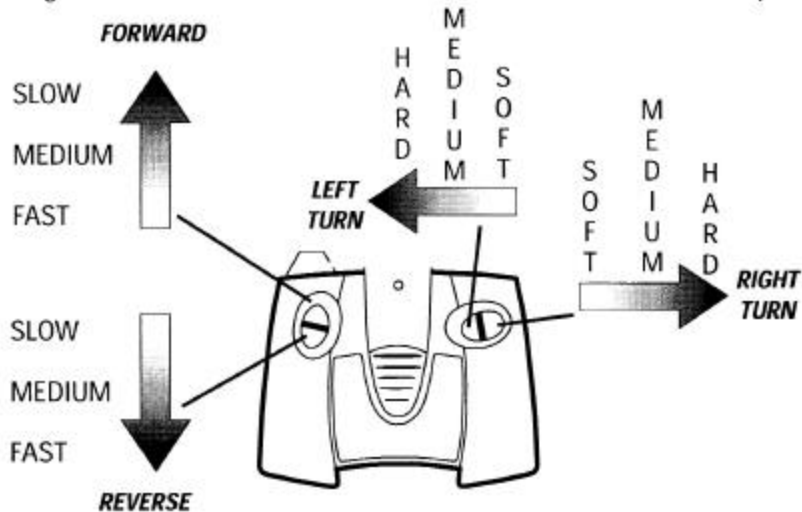

In addition to the control sticks, the transmitter features two action buttons that let you control the skateboarder body...not just the board!

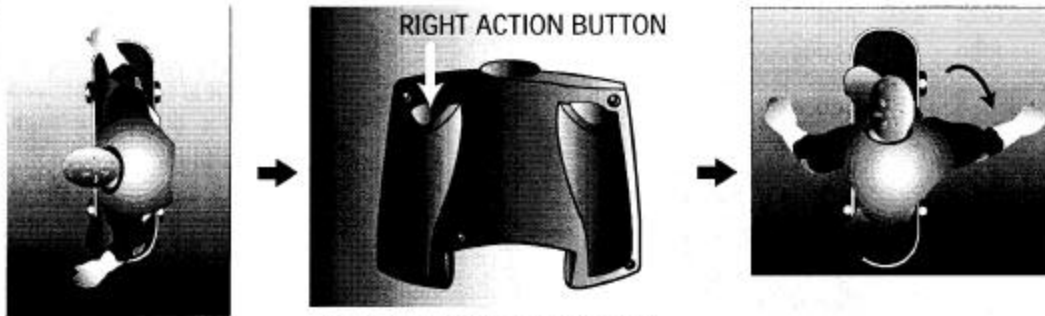

TRANSMITTER (BACK VIEW)



TRANSMITTER (BACK VIEW)



If you push the action button and hold it down, the rider will turn 90°...and it will stay that way until you release the button. If you quickly push and release the action button, the rider will do a super-fast turn and immediately return to its normal position.



IV. TALK THE TALK...STICK THE TRICKS!

With the combination of advanced digital control, seven-position speed and steering, and control over the body and the board, the Tony Hawk Skateboard is the only R/C that can do the stunts a real world-champ skateboarder can do! The Tony Hawk Skateboard is designed and engineered to work like a REAL skateboard...so you'll need to PRACTICE to perfect your technique. Visit our website for more info: tycorc.com

TALK THE TALK!

To be a "pro" skateboarder, you have to talk the talk!

MANUAL: A cool wheelie! The board's front wheels pop up into the air, and the board rides on its rear truck.

TIC TAC: When you "Tic Tac" you rock the board from side to side, weaving back and forth while moving forward or back.

TAIL SLIDE: In a Tail Slide, the back end of the board slides around...180° or a full 360°...and keeps driving in its original direction.

TRANSFER: When a board "transfers," it moves directly from one obstacle to another.

STICK: To "Stick" is to land a trick successfully...and ride away.

STICK THE TRICKS!

This manual shows you how to do some ultra-realistic skateboard tricks. Once you master them, you'll realize you can do lots of other cool stunts! So practice, have fun, and invent some awesome tricks of your own!

GROUND TRICKS

These tricks work best on smooth, flat surfaces.

MANUAL



Push the left stick down all the way to drive in reverse. Once you've accelerated to full speed, quickly push the left stick up and then release it. Your vehicle will jam up into a cool wheelie! For extra stunt action, steer right or left while your vehicle is in wheelie mode. This will cause the vehicle to drop back onto all four wheels, changing direction as it does. This trick works best with a "medium" left or right turn.

TIC TAC



To do this trick, simply steer your board right and left while driving, either forward or reverse. The board will rock from side to side. Try this trick with "medium" and "hard" left and right turns. The cool engineering of the board makes it work just like the real thing!

180° TAIL SLIDE

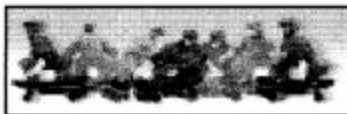

First, push the right action button to rotate the rider so he's facing backward. Now push the left stick down all

the way to drive hard in reverse. Now quickly push the left action button and hold it down, while steering to the right. The board's front truck will swing around to the left. When it comes around 180°, push the left stick forward to keep driving.

RADICAL RECOVERY



Start with the board lying flat on its side. Push either the left or right action button to rotate the rider. His right hand will come around, pivoting the board and bringing it up to an angle. Steer right or left to bring the board all the way up! (This trick will also let you "right" the board if it tips over while you're driving.)



RAMP/OBSTACLE TRICKS

These tricks work best on ramps or other obstacles.

180° SPIN

Push the left stick up to drive up an inclined ramp or half-pipe. Just before you get to the top, hit either the left or right action button, while steering either left or right. The front end of the board will swing around 180°. Keep the left stick pushed up to drive the board forward coming down.



On the down slope, the rider **MUST** be rotated so that he's facing the front of the board.

360° TAIL SLIDE

This trick is similar to the 180° Tail Slide, but it works best on a smooth ramp (or half-pipe), or a very slick, flat surface. Push the right action button to rotate the rider so he's facing backward. Now push the left stick down all the way to drive hard in reverse. Now quickly push the left action button and hold it down, while steering hard to the

right. The board's front truck will swing around to the left. When it comes around a full 360°, push the left stick up to keep driving.

TRANSFER (& STICK)

To "Transfer" from one obstacle to another, push the left stick up (for forward) or down (for reverse), steering left or right to aim toward the obstacle you want to "transfer" to. For maximum stability, push the left or right action button to swing the rider 90° left or right.

V. QUICK TIPS

- 1 When your vehicle starts to lose power, it may lose functions or performance. It's time for a recharge. Your vehicle's running time may change depending on your driving style.
- 2 Radio interference can make your vehicle run badly. Interference can be caused by other R/C vehicles running on the same frequency; electrical wires; large buildings; or CB radios. Try to stay away from these!
- 3 Point your transmitter antenna up - not down toward your vehicle. If your vehicle gets too far away, it won't work properly.
- 4 Don't drive your vehicle in sand or through water or snow. If your vehicle does get wet, wipe with a towel and allow to dry completely.
- 5 Don't store your vehicle near heat or in direct sunlight. Always turn switches OFF and remove all batteries for storage.

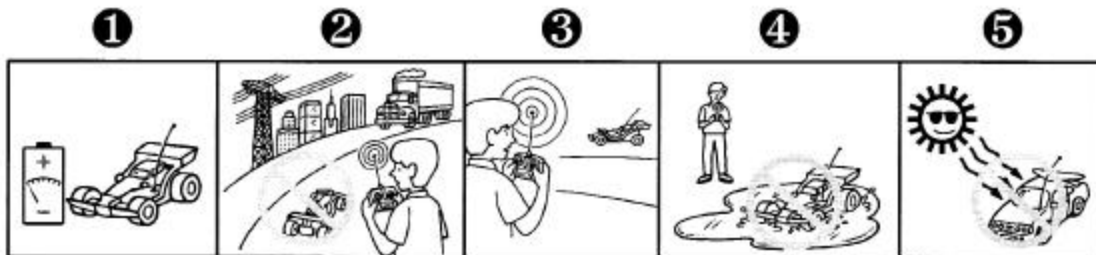

VI. POWER SYSTEM

(Batteries and Charger Not Included)

FOR DETAILED INFORMATION REGARDING VEHICLE BATTERY CHARGING AND SAFETY, PLEASE FOLLOW THE SPECIFIC INSTRUCTIONS THAT CAME WITH YOUR BATTERY PACK AND CHARGER.

- Your vehicle will not operate without the TYCO® R/C TMH® FlexPak® Battery

Pack and Charger. The TMH FlexPak battery pack is designed for use exclusively in TYCO® R/C TMH Power vehicles. It will not work in any 6.0V or 9.6V NiCd battery powered vehicles.

- Your TMH FlexPak battery pack features a unique design (Patent Pending) which allows it to be configured in different ways for use in different TMH power vehicles. This feature allows maximum performance for

each vehicle. To configure your FlexPak battery pack for use in this vehicle, please refer to Section VIII, "Battery Installation."

① TMH® FlexPak® Battery Pack and Charger

② ALSO AVAILABLE
Additional TMH® FlexPak® Battery Pack

Charge additional Battery Packs ahead of time for longer non-stop action!



BATTERY SAFETY INFORMATION

- ✓ Insure that battery polarity is correct.
- ✓ Use only batteries of the type recommended (or equivalent).
- ✓ Do not mix old and new batteries.
- ✓ Do not mix alkaline, standard (carbon-zinc), or rechargeable (nickel-cadmium) batteries.
- ✓ Remove used-up batteries immediately. Remove batteries if vehicle will not be used for a long period.
- ✓ Do not recharge non-rechargeable batteries.
- ✓ Do not short-circuit terminals.
- ✓ Remove rechargeable batteries before recharging (if the batteries are designed to be removable).
- ✓ Recharge batteries only under adult supervision (if the batteries are designed to be removable).
- ✓ Dispose of batteries safely. Do not dispose of batteries (or products containing non-replaceable batteries)

in fire, as batteries may explode or leak.

Battery Performance Note:
For best performance use alkaline batteries (where disposable batteries are called for). If your vehicle is supplied with standard (carbon-zinc) batteries for initial use and/or demonstration purposes, we recommend replacing them with alkaline batteries when necessary. Battery life may vary depending on battery brand.

VII. BATTERY INSTALLATION

VEHICLE

- ① Make sure the FlexPak® battery pack is fully flat, so

that the labels marked 1 and 2 are facing up, as shown.

- ② Release the battery door as shown.
③ Insert the battery pack into the battery compartment

and slide it into the compartment. The battery will flex slightly as you slide it forward to fit in the compartment. Press down to make sure the battery is secure in the compartment.



④ Replace the battery door and lock it, as shown.

⑤ To remove: release the battery door and slide out the battery pack.

Estimated run time for this vehicle: approximately 30 minutes

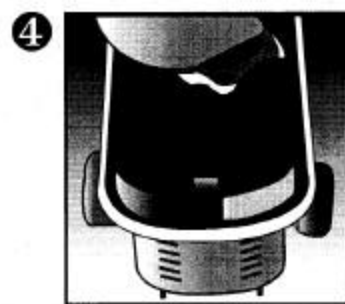
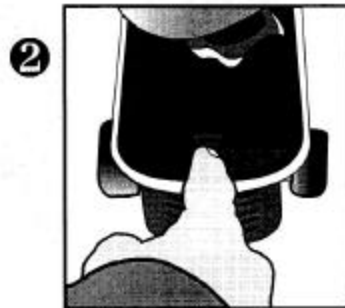
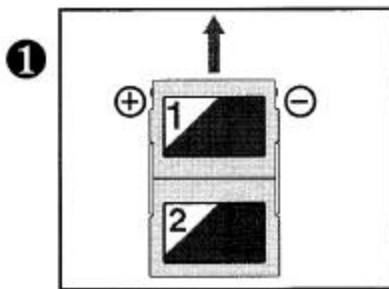

TRANSMITTER

① To install transmitter battery, open battery door as shown.

② 2. Install one 9V battery with polarity (+/-) as shown inside battery compartment.

③ Swing battery door closed and snap shut.

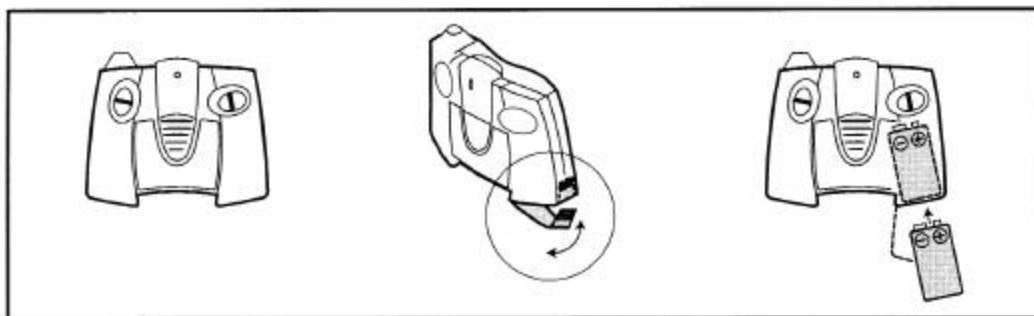

VIII. SAFETY INFORMATION

• Adults, this toy is recommended for children 8 years of age and older. To ensure that the child's play is both safe and fun, please review the operating instructions and these general safety

- rules with the child.
- NEVER drive your vehicle on streets! They're for real cars!
- DO NOT pick up vehicle while in motion.
- Keep fingers, hair and loose clothing away from the tires and the wheel hubs while

- the vehicle is switched ON.
- Adult supervision is recommended when this vehicle is being operated.
- To avoid accidental operation, remove all batteries when not in use.



SYMPTOM

PROBABLE CAUSE

CORRECTION

Vehicle runs slowly or will not run.

- Loose battery connection or vehicle switch not ON.
- Weak or uncharged rechargeable battery.
- Weak transmitter battery.

- Check battery connector and vehicle switch.
- Charge battery or replace.
- Replace with fresh alkaline battery.

Erratic operation or only short range possible.

- Radio interference likely.

- Change location (see point 2 – Quick Tips)

Short battery life.

- Battery not fully charged.

- Recharge TMH® FlexPak® battery pack. For maximum running time, make sure you give your battery pack a full charge.

Vehicle doesn't work after going through water or snow.

- Water in the electronics area.

- Vehicle will take several hours to dry. Allow to dry thoroughly OVERNIGHT before trying again.
- Operate your vehicle in a dry area. Avoid driving in water and snow.

© 2000 Mattel, Inc., Mt. Laurel, NJ 08054 U.S.A. **PRINTED IN CHINA.** All Rights Reserved. ® and ™ designate U.S. trademarks of Mattel, Inc.

Retain this address for future reference: Mattel U.K., Ltd., Vanwall Business Park, Maidenhead SL6 4UB. Mattel Australia Pty., Ltd., Richmond, Victoria 3121 - Consumer Advisory Service: 1800 800 812 (valid only in Australia). Mattel East Asia Limited, 930 Ocean Centre, Harbour City, HK, China.

COMPLIANCE WITH FCC REGULATIONS

THIS DEVICE COMPLIES WITH PART 15 OF FCC RULES. OPERATION OF THIS DEVICE IS SUBJECT TO THE FOLLOWING TWO CONDITIONS:

(1) THIS DEVICE MAY NOT CAUSE HARMFUL INTERFERENCE.

(2) THIS DEVICE MUST ACCEPT ANY HARMFUL INTERFERENCE THAT MAY CAUSE UNDESIRE OPERATION.

This device generates and uses radio frequency energy and if not used prop-

erly may cause interference to radio and television reception. It has been tested and found to comply with the limits set by the FCC, which are designed to provide reasonable protection against such interference.



CAUTION: FCC Regulations state that changes or modifications to this product not expressly approved by the party responsible for compliance could void the user's authority to operate the equipment.

