



CAUTION-ELECTRIC TOY: NOT RECOMMENDED FOR CHILDREN UNDER 6 YEARS OF AGE. AS WITH ALL ELECTRIC PRODUCTS, PRECAUTIONS SHOULD BE OBSERVED DURING HANDLING AND USE TO PREVENT ELECTRIC SHOCK.

INPUT: 120VAC, 0.10VDC, 60Hz, 0.05A. OUTPUT: 11.5VDC, 1.05VA.



**TYCO® R/C SUPPORT
REGISTER YOUR
VEHICLE 2 WAYS!**
Online...or toll-free!

tyco.com
1-888-557-TYCO (8926)

If you have questions or problems with your vehicle,
DON'T RETURN IT TO THE STORE...
get help from the EXPERTS! Just click or call.

Keep these instructions for future reference: they contain important information.
IMPORTANT: Please read all "Consumer Information" (last page) before operating your vehicle.

⚠ CAUTION: Surfaces may become hot and cause burns if electronics get wet. Do not operate vehicle through water or snow.

9.6V R/C

CONTENTS

Vehicle
Transmitter
9.6V NiCd Battery Pack
9.6V NiCd Charger

CHASSIS

Refer to label on transmitter and vehicle for frequency. Do not race vehicles with the same frequency.

BOTTOM VIEW

Steering Adjuster
(adjust, if necessary, to keep vehicle running straight)

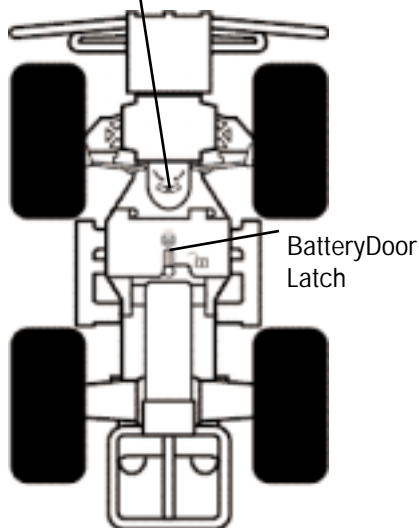

TOP VIEW

On/Off Switch

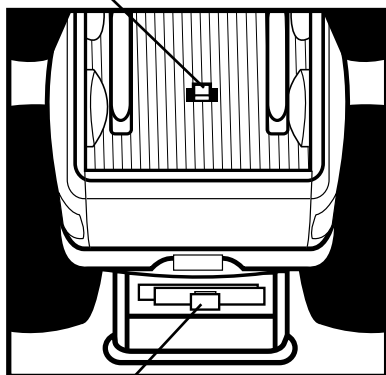

Gear Selector
(high/low)

CONSUMER INFORMATION:

IMPORTANT:

Please read before operating your vehicle.

SAFETY INFORMATION

Note to Adults: To ensure that the child's play is both safe and fun, please review all operating instructions and safety rules with your child.

Safety Tips

- NEVER drive your vehicle on streets! They're for real cars!
- DO NOT pick up vehicle while in motion.
- Keep fingers, hair and loose clothing away from the tires and the wheel hubs while the vehicle is switched ON.
- Adult supervision is recommended when this vehicle is being operated.

- To avoid accidental operation, remove all batteries when not in use.

BATTERY SAFETY INFORMATION

- ✓ Insure that battery polarity is correct.
- ✓ Use only batteries of the type recommended (or equivalent).
- ✓ Do not mix old and new batteries.
- ✓ Do not mix alkaline, standard (carbon-zinc), or rechargeable (nickel-cadmium) batteries.
- ✓ Remove used-up batteries immediately. Remove batteries if vehicle will not be used for a long period.
- ✓ Do not recharge non-rechargeable batteries.
- ✓ Do not short-circuit terminals.
- ✓ Remove rechargeable batteries before

recharging (if the batteries are designed to be removable).

- ✓ Recharge batteries only under adult supervision (if the batteries are designed to be removable).
- ✓ Dispose of batteries safely. Do not dispose of batteries (or products containing non-replaceable batteries) in fire, as batteries may explode or leak.

Battery Performance Note:

For best performance use alkaline batteries (where disposable batteries are called for). If your vehicle is supplied with standard (carbon-zinc) batteries for initial use and/or demonstration purposes, we recommend replacing them with alkaline batteries when necessary. Battery life may vary depending on battery brand.

QUICK TIPS

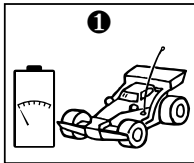

1 When your vehicle starts to lose power, it may lose functions or performance. It's time for fresh batteries (or a recharge). Your vehicle's running time may change depending on your driving style.



2 Radio interference can make your vehicle run badly. Interference can be caused by other R/C vehicles running on the same frequency; electrical wires; large buildings; or CB radios. Try to stay away from these!

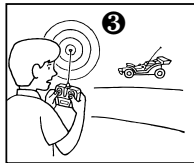

3 Point your transmitter antenna up - not down toward your vehicle. If your vehicle gets too far away, it won't work properly. If your transmitter has a carry-loop feature, make sure the antenna tip is removed from the carry-loop holder and straightened before operating.



4 Don't drive your vehicle in sand or through water or snow.

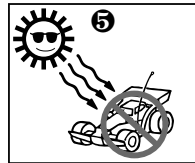

5 Don't store your vehicle near heat or in direct sunlight. Always turn switches OFF and remove all batteries for storage.

TROUBLESHOOTING - PROBLEM? - SOLUTIONS

SYMPTOM	PROBABLE CAUSE	CORRECTION
Vehicle runs slowly or will not run.	<ul style="list-style-type: none"> • Loose battery connection or vehicle switch not ON. • Weak or uncharged rechargeable NiCd battery • Weak transmitter battery. 	<ul style="list-style-type: none"> • Check battery connector and vehicle switch. • Charge battery or replace. • Replace with fresh alkaline battery.
Power indicator light on transmitter does not light.	<ul style="list-style-type: none"> • Transmitter battery weak or not connected. 	<ul style="list-style-type: none"> • Check connections and replace battery if required.
Erratic operation or only short range possible.	<ul style="list-style-type: none"> • Radio interference likely. • Antenna snapped into carry-loop holder (if equipped). 	<ul style="list-style-type: none"> • Change location - see Point 2, "Quick Tips." • Remove antenna tip from carry-loop holder and straighten.
Vehicle doesn't work after going through water or snow.	<ul style="list-style-type: none"> • Water in the electronics area. 	<ul style="list-style-type: none"> • Vehicle will take several hours to dry. Allow to dry thoroughly overnight before trying again. • Avoid driving in water or snow.



POWER SYSTEMS

Please follow the specific instructions on the next page for detailed information regarding NiCd vehicle battery charging and safety.

VEHICLE BATTERY INSTALLATION

1. Rotate battery latch to open position.
2. Insert battery pack into battery compartment and slide it away from latch.
3. Make sure battery pack snaps securely in place and rotate latch to locked position.
4. To remove battery pack: turn latch, slide battery pack toward latch and lift out.

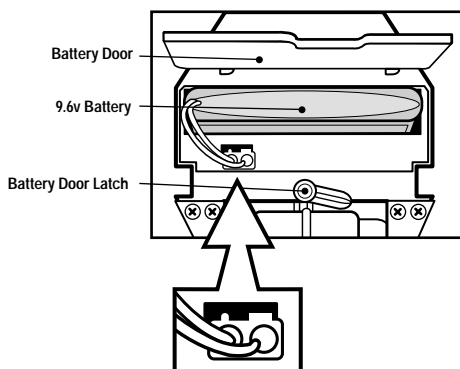

TRANSMITTER BATTERY INSTALLATION

Your transmitter has special shifting features. Please refer to the "SPECIAL FEATURES" page for detailed instructions.

1. To install transmitter battery, open battery door as shown.
2. Install one 9V battery with polarity (+/-) as shown inside battery compartment.
3. Swing battery door closed and snap shut.

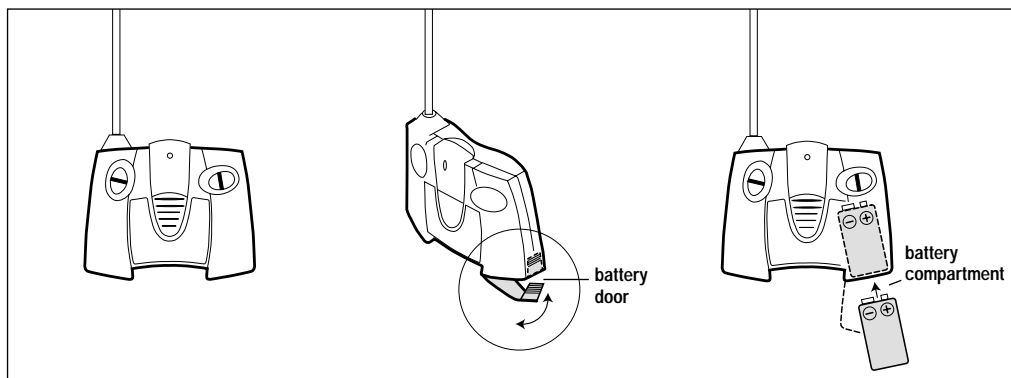
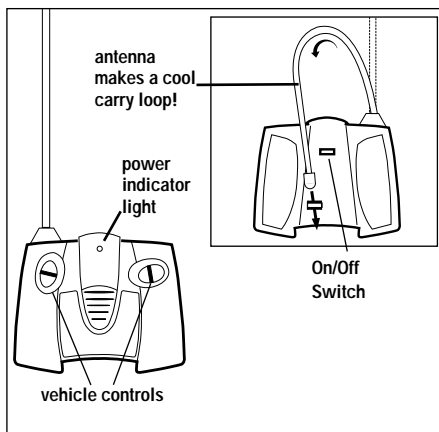

SPECIAL FEATURES

Your transmitter can operate in 3 different modes...for ultimate driving action!

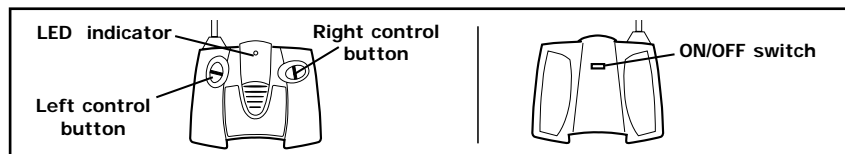

I. SPEEDSHIFTER™ MODE – 3-speed shifting and cool driving sounds

1. Turn the vehicle switch ON. Turn the transmitter ON. Don't press either control button.
2. After 3 seconds you'll hear a shifting sound. You're now in SpeedShifter™ mode! Just like a real driver, you'll have to shift up through the "gears"...from first to third!
3. Press and release either control button to "start" your vehicle.
4. Press the left control button forward to drive forward in first gear. The LED indicator (and a horn beep) will tell you when to shift. To shift, release the shifter control...then push it forward again and hold it down. Your vehicle's speed (and sound) will change when you change "gears." Your vehicle will "downshift" when you turn for more than 1 second.

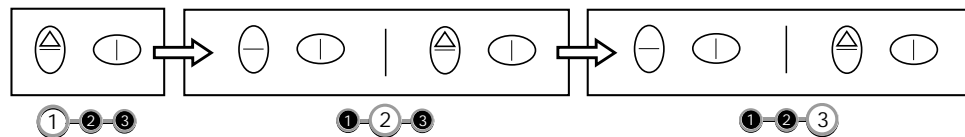

- If you don't shift when the LED comes on, the "motor whine" will tell you that you need to shift.
- If you shift too soon, your "transmission" will make a "grinding" sound...just like a real gearbox.
- Just like a real vehicle, your "transmission" has only one "gear" in reverse.

II. SOUND MODE – high-speed driving...with cool driving sounds

1. Turn the vehicle switch ON. Turn the transmitter ON.
2. Within 3 seconds, press the left control button forward and hold it down until the LED indicator flashes.

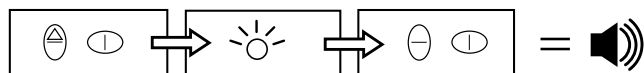

3. Release the control button and the horn will beep. You're now in Sound Mode.
4. Press and release either control button to "start" your vehicle.
5. Use the control buttons to drive with cool driving sounds.

III. MUTE MODE – high-speed driving...without sound

1. Turn the vehicle switch ON. Turn the transmitter ON.
2. Within 3 seconds, press the left control button backward and hold it down until the LED indicator flashes.

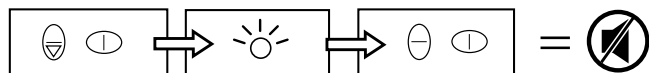

3. Release the control button. You're now in Mute Mode.
4. Use the control buttons to drive your vehicle.

To switch modes at any time, just turn the transmitter OFF, then back ON. Then follow the directions above.

VEHICLE OPERATION – after vehicle is placed in desired mode

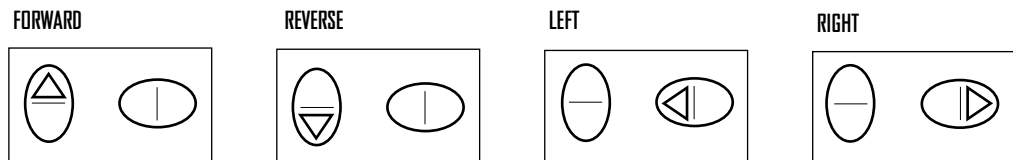

NiCd BATTERY INFORMATION

Please follow these instructions regarding NiCd vehicle battery charging and safety. Use charger only under adult supervision.

BATTERY CHARGING/CARE — 9.6V TURBO® BATTERY

1. Plug wall pack charger into standard 110/120 volt outlet.
2. Connect the wires leading from the battery pack to the wall pack charger connector. Make certain the two connectors are tightly snapped together.
3. To disconnect wires, push down on the connector clip and pull apart.
4. Your battery pack consists of new parts and materials; therefore, you should charge the battery pack for 5½ hours the first two times you charge the battery. Subsequent charges will require only 4 hours.
5. After charging for 4 hours, the battery will feel warm. This condition is normal for fully charged batteries.
6. Charging the battery pack for more than 4 hours will not give you a longer running time. 4 hours is all that is required for a fully charged battery pack.
7. Unlike alkaline batteries, where the power loss is gradual, a NiCd (nickel-cadmium) battery will run for its normal running time, depending on your particular vehicle, and then lose most of its power at once. It is time to recharge the battery pack. Running time will vary, depending upon which R/C vehicle you have.
8. After use, the battery pack will be hot! Wait at least 20 minutes until the battery pack cools before recharging. Recharging a warm or hot battery pack will greatly reduce the number of times your battery pack can be recharged.

RECHARGEABLE BATTERY INFORMATION:

- ✘ DO NOT RECHARGE BATTERY PACK IF IT'S HOT. ALLOW IT TO COOL BEFORE RECHARGING.
- ✘ DO NOT RECHARGE A BATTERY PACK THAT SHOWS LEAKAGE OR CORROSION.
- ✘ DO NOT DISASSEMBLE THE BATTERY PACK. THE BATTERY PACK IS A SEALED RECHARGEABLE NICKEL-CADMIUM BATTERY.
- ✘ DO NOT DISPOSE OF THE BATTERY PACK IN FIRE.
- ✘ EXERCISE CAUTION IN HANDLING A HOT BATTERY PACK.
- ✘ IF BATTERY PACK AND/OR CHARGER ARE WET, THOROUGHLY DRY BEFORE CHARGING.
- ✘ DO NOT RECHARGE NON-RECHARGEABLE BATTERIES.

Note to Adults:

- Remove rechargeable batteries before recharging. Recharge batteries only under adult supervision.
- Regularly examine for damage to the plug, enclosure and other parts. In the event of any damage, the toy must not be used with the transformer until the damage has been repaired.
- This toy is not intended for children under 6 years old. The transformer is not a toy.

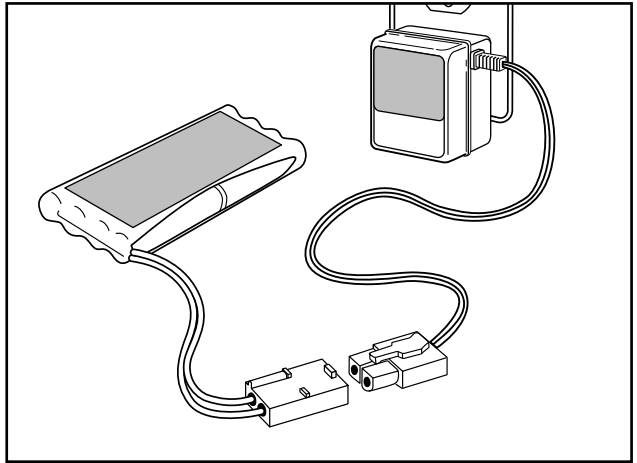

THIS PRODUCT USES A NICKEL-CADMIUM RECHARGEABLE BATTERY PACK. BATTERY MUST BE RECYCLED OR DISPOSED OF PROPERLY. FOR FURTHER INFORMATION REGARDING BATTERIES OR THEIR DISPOSAL PLEASE CALL 1-888-557-TYCO.



90-DAY LIMITED WARRANTY - TYCO® R/C PRODUCTS

Mattel, Inc. warrants to the original consumer purchaser that this product will be free of defects in material and workmanship for ninety (90) days (unless specified in alternate warranties) from the date of purchase. Mattel will repair or replace the product, at our sole option, in the event of such a defect within the warranty period.

In the event of a defect covered under this warranty, first call the toll-free number listed below. Many problems can be solved in this manner. If necessary, you will be instructed to return the product, postage prepaid and insured, to the address below. Enclose your name, address, dated sales receipt, and a brief explanation of the defect. Repair or replacement, and return shipment, will be free of charge. Please return only the defective part or unit, packed securely.

This warranty does not cover damage resulting from unauthorized modification, accident, misuse or abuse. If the product is returned without a dated sales receipt the product may be excluded from coverage under this warranty.

Mattel's liability for defects in material and workmanship under this warranty shall be limited to repair or replacement, at our sole option, and in no event shall we be responsible for incidental, consequential, or contingent damages (except in those states that do not allow this exclusion or limitation). This warranty is exclusive, and is made in lieu of any express or implied warranty. **Valid only in U.S.A.** This warranty gives you specific legal rights and you may have other rights, which vary from state to state. Some states do not allow the exclusion of incidental or consequential damages, so the above exclusions or limitations may not apply to you.

TOLL-FREE NUMBER: 1-888-557-TYCO (8926) (valid only in U.S.A.) Hours: 8:00 A.M. - 6:00 P.M. Eastern Time; Monday - Friday. Expect some delay in January following the holiday season. Please be patient and keep trying the toll-free number.

ADDRESS FOR RETURNS: CONSUMER RELATIONS, 636 GIRARD AVENUE, EAST AURORA, NY 14052

© 2001 Mattel, Inc., Mt. Laurel, NJ 08054 U.S.A.
PRINTED IN CHINA. All Rights Reserved. ® and ™ designate U.S. trademarks of Mattel, Inc.

Retain this address for future reference: **Mattel U.K. Ltd., Vanwall Business Park, Maidenhead SL6 4UB, Mattel Australia Pty. Ltd., Richmond, Victoria 3121 - Consumer Advisory Service: 1800 800 812 (valid only in Australia), Mattel East Asia Limited, 930 Ocean Centre, Harbour City, HK, China.**

COMPLIANCE WITH FCC REGULATIONS

THIS DEVICE COMPLIES WITH PART 15 OF FCC RULES. OPERATION OF THIS DEVICE IS SUBJECT TO THE FOLLOWING TWO CONDITIONS:

- (1) THIS DEVICE MAY NOT CAUSE HARMFUL INTERFERENCE.
- (2) THIS DEVICE MUST ACCEPT ANY HARMFUL INTERFERENCE THAT MAY CAUSE UNDESIRE OPERATION.

This device generates and uses radio frequency energy and if not used properly may cause inter-

ference to radio and television reception. It has been tested and found to comply with the limits set by the FCC, which are designed to provide reasonable protection against such interference.



CAUTION: FCC Regulations state that changes or modifications to this product not expressly approved by the manufacturer responsible for compliance could void the user's authority to operate the equipment.