

Bluetooth CAR FM TRANSMITTER

With 2.1A DUAL USB CAR CHARGER

Model: FMT-9

USER GUIDE



Introduction

This device, Lets you stream music and calls directly from your Bluetooth device to your car FM stereo system. The built-in microphone provides you with an amazing hands free function, it also features a USB and SD card reader that lets you steam your favorite MP3 and WMA tunes to your car's stereo system. Play music files from external device by connecting your music device using the Aux port too. It also can charge your phone using the DUAL USB charging Port. Its Bluetooth chip can be used with a wide range of device which can make can your driving more interesting.

Packing contents:

- Bluetooth device
- Aux-in cable
- IR Remote
- User Guide

Specification:

- Bluetooth version: V2.1
- Frequency range: 88.1-107.9MHZ
- Frequency stability: ± 10 ppml
- Product Input:12-24V
- Charger output: 5V/2.1A(in total)
- Music Format: mp3, wma
- USB(Max capacity): 32GB
- SD Card(Max capacity): 32GB
- Audi input:3.5mm stereo jack.
- Transmit Distance: about 10 m

Features:

- 1.Wirelessly transmit phone call from Bluetooth mobile phone to the car FM stereo system;
- 2.Switch to Hands-free mode automatically from music playing status when receiving calls;
- 3.Built-in Microphone
- 4.Supports music play back from USB AND SD card
- 5.3.5mm Aux jack to support play back from external audio devices.
- 6.Dual USB output to charge for mobile phones and other devices(Output 5V/2.1A)
- 7.Strong and elegant design with LCD frequency display.
- 8.With remote control
- 9.With Voice prompts

Compatibility:

This device may be paired as a hands free kit with any compatible Bluetooth enabled devices.

Precautions:

Please read all safety instruction wan warnings carefully before using this product. Improper use of this product may result in damage to this or attached products. To ensure the production works well, please never use this in the following conditions :

1. Moist or underwater conditions.
2. Conditions near heater or high-temperature service.
3. Conditions with direct and strong sunshine,
4. Conditions with apt falling
5. Never dismantle the product without due permission, otherwise it may nullify the warranty clause.

Appearance:

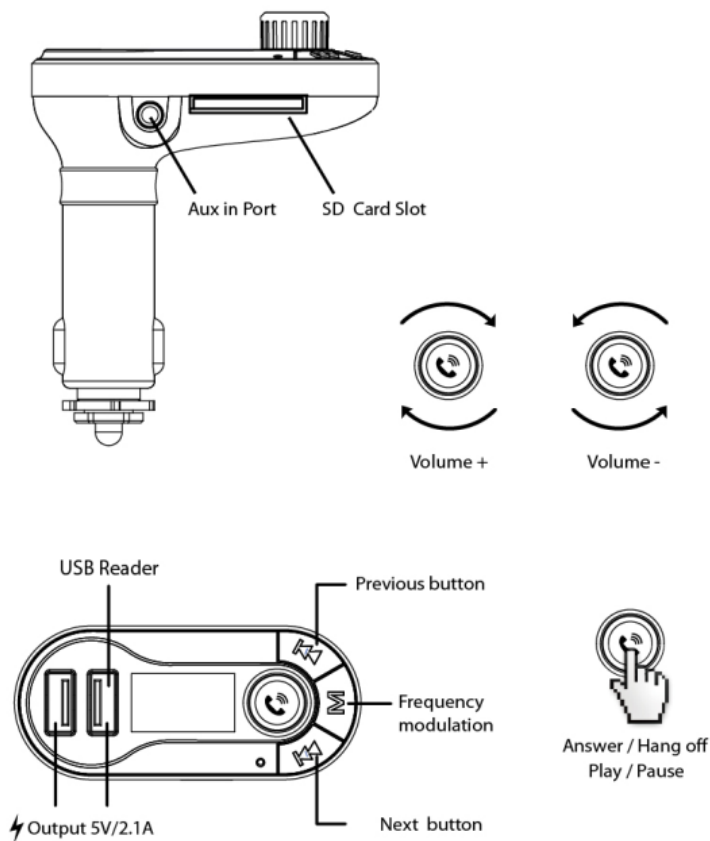

Operation Instructions



Using FM Transmitter function:

1. Plug the FM transmitter into your vehicle's cigarette lighter or power port.
2. Tune your radio to an unused FM frequency, then match the same frequency of this unit.
3. Insert a USB flash drive into the SD card or the inward USB port which containing MP3 files into USB port or memory card slot of this unit accordingly. It will play and transmit the MP3 files automatically. Pay attention, only the inward USB Port can serve as a USB Reader!
4. Line-in function: Use the provided audio cable to connect an MP3/MP4 players or another external device to the AUX input of this unit. When using this function, please stop playback of USB or memory card, and all functions will be controlled by the external device.

Using Bluetooth function:

1. Using Bluetooth for the first time, you need to pair your mobile phone with this unit. Activate your mobile phone's bluetooth function, then search new device. When the mobile phone detects this unit (named as "BT-T66"), please pair and connect by using the original password "0000"
2. In the music playing mode, when there is an incoming call, this unit will automatically switch to telephone mode.







Bluetooth calling

1. Please press the blue "  " knob to answer the incoming call.
2. Please press the blue "  " knob to hang off a call.
3. Press the blue "  " knob twice to dial the last Number.
4. When making a call, you can only dial the phone number by your mobile phone, but once the call connected, you can use the handsfree function to enjoy it.

Using USB charger function:

When this unit powered from car lighter socket, connect the USB port of this unit to your mobile phone with a special USB cable (not included), This unit will serve as mobile phone charger. Pay attention! The Dual USB port outputs 2.1A together, and the smart chip will divide the voltage based on the need of device automatically. But only the outward USB port can charge the iPad!

Quick Guide:

Operation Guide	On FM transmitter	On Remote Controller
1. Answer / hang up the call:	Press "  " button: answer the call Press "  " button: hang off the call	Press "  " button
2. Play and Pause the music:	Press "  " Button: Play the music Press "  " Button again: Pause playing	Press "  " Button
3. Adjust the Volume:	Rotate in clockwise to decrease Volume Rotate anticlockwise to increase Volume	Press "Vol+" to increase the Volume; Press "VOL-" to decrease the Volume;
4. Set frequency:	Press "M" button first, then press "▶▶": increase the frequency Press "◀◀": decrease the frequency	Press "CH+" button: Increase 0.1MHz Press "CH-" button: decrease 0.1MHz Or press the numbers of the frequency what you desired, press "CH+" to confirm.
5. Choose music:	Press "▶▶" Button: Play the next song Press "◀◀" Button: Play the previous song	Press ▶▶ button: Play the next song; Press ◀◀ button: Play the previous song; Or press the number of the song then press ▶/ to confirm
7. Choose EQ:	Support by remote controller only	Press "EQ" button to choose your favorite EQ
8. Switch folder:	Support by remote controller only	Press "folder" button to switch folder

FCC Statement

Changes or modifications not expressly approved by the party responsible for compliance could void the user's authority to operate the equipment.

This equipment has been tested and found to comply with the limits for a Class B digital device, pursuant to Part 15 of the FCC Rules. These limits are designed to provide reasonable protection against harmful interference in a residential installation. This equipment generates uses and can radiate radio frequency energy and, if not installed and used in accordance with the instructions, may cause harmful interference to radio communications. However, there is no guarantee that interference will not occur in a particular installation. If this equipment does cause harmful interference to radio or television reception, which can be determined by turning the equipment off and on, the user is encouraged to try to correct the interference by one or more of the following measures:

- Reorient or relocate the receiving antenna.
- Increase the separation between the equipment and receiver.
- Connect the equipment into an outlet on a circuit different from that to which the receiver is connected.
- Consult the dealer or an experienced radio/TV technician for help

This device complies with part 15 of the FCC rules. Operation is subject to the following two conditions (1) this device may not cause harmful interference, and (2) this device must accept any interference received, including interference that may cause undesired operation