

### Power Source

#### Choosing a Working Voltage

The system can run either on AC 115V (+/-10%) or AC 230V (+/-10%). Slide the AC voltage select switch on both of the two power supply units to the correct position which corresponds with the wall outlet supply voltage.

#### Warning !

Wrong AC Voltage input will harm the power supply and cause serious damage to the Disk Array.

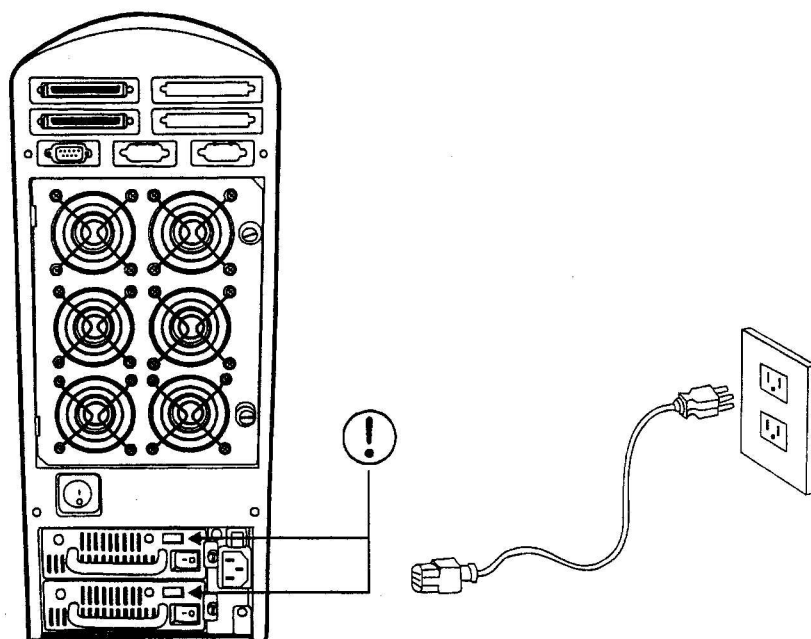

Figure : Power Source

#### ! This Disk Array must be grounded

This Disk Array is supplied with an AC power cord equipped with a 3-wire grounding type plug. This is a safety feature and it is important to only use a 3-wire grounded mains power cord.

### Hard Disk Drives Pre-Setting

1. HDD SCSI Terminator : set " Disable SCSI Terminator ".

#### Important !

You must set disable SCSI terminator to all of these drives even it is on the end the device channel bus.

2. Terminator Power : set " Term. Power from SCSI Bus ".
3. Motor Star option : set " Enable motor start ".
4. Setting the SCSI ID : Pre-setting is not necessary.

By using the Auto SCSI ID assignment design in this Disk Array System, the RAID controller will assign SCSI ID to all of these drives automatically when you connected the SCSI ID cable ( on the HDD tray ) to these drives.

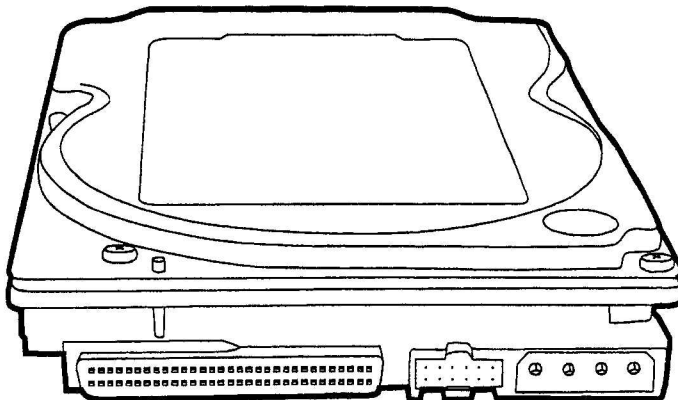

Optional Usage Plug

Figure : Drive Rear View

## Getting Started

### About HDD's Auto SCSI ID# Setting

Common optional SCSI ID Usage Plug :

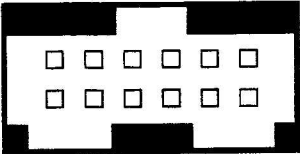
Pin Assignment	Pin	Signal
11 9 7 5 3 1	1	A0
	3	A1
	5	A2
	7	A3
	8	LED Cathode
12 10 8 6 4 2		

\*\*\* You must check the HDD's installation guide before you install the drives, --- if your drives have not this rear optional usage plug or the pin assignment is different from the above common usage plug, then you must set the HDD's SCSI ID# manually as below :

Tray 1 : ID#0  
Tray 2 : ID#1  
Tray 3 : ID#2  
Tray 4 : ID#3  
Tray 5 : ID#0  
Tray 6 : ID#1  
Tray 7 : ID#2  
Tray 8 : ID#3

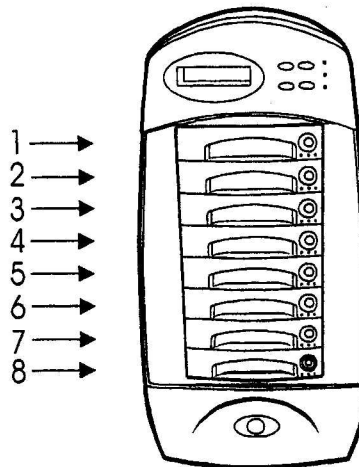

Figure : Manual HDD's SCSI ID setting

#### Important :

If your drive's option usage plug or pin assignment is different from the above, -- Do not connect the SCSI ID cable into the drives.

## Installing the Hard Disk Drives

Step 1 : Open the front cover.

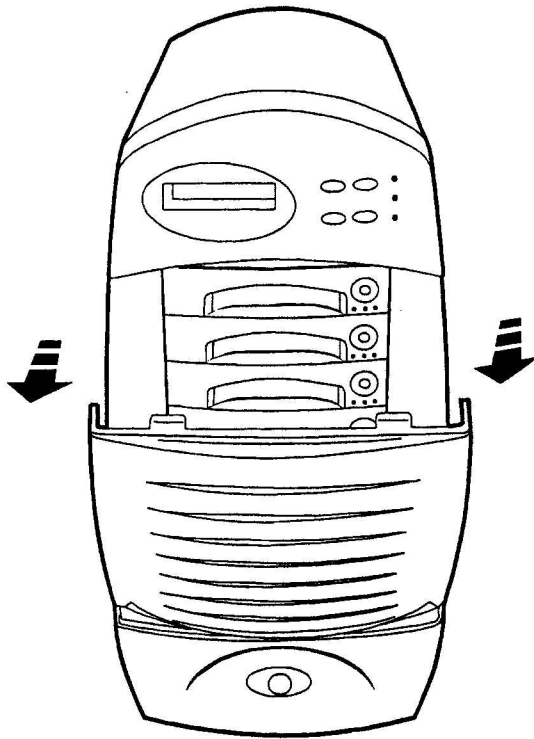

Figure : Installing HDD step 1

## Getting Started

- Step 2 : Unlock the HDD tray by turning the Key-lock to the correct position.  
Step 3 : Gently Pull out the HDD tray.

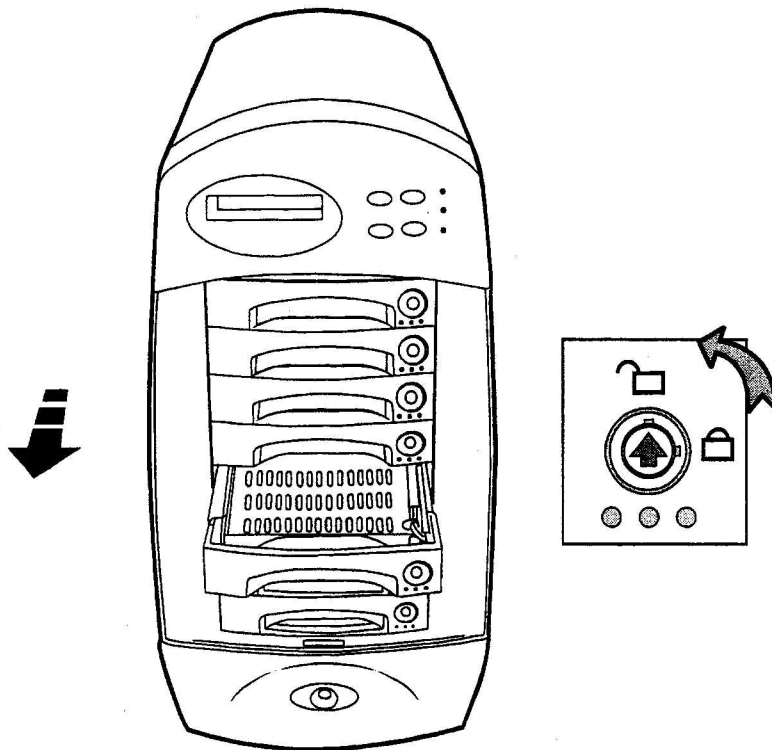

Figure : Installing HDD step 2, 3

## Getting Started

Step 4 : Insert HDD into the tray

Step 5 : Screw in the hard drive.  
( Use the correct size, type and thread )

Step 6 : Cabling, Connect the Data cable , SCSI ID cable  
& Power cable.

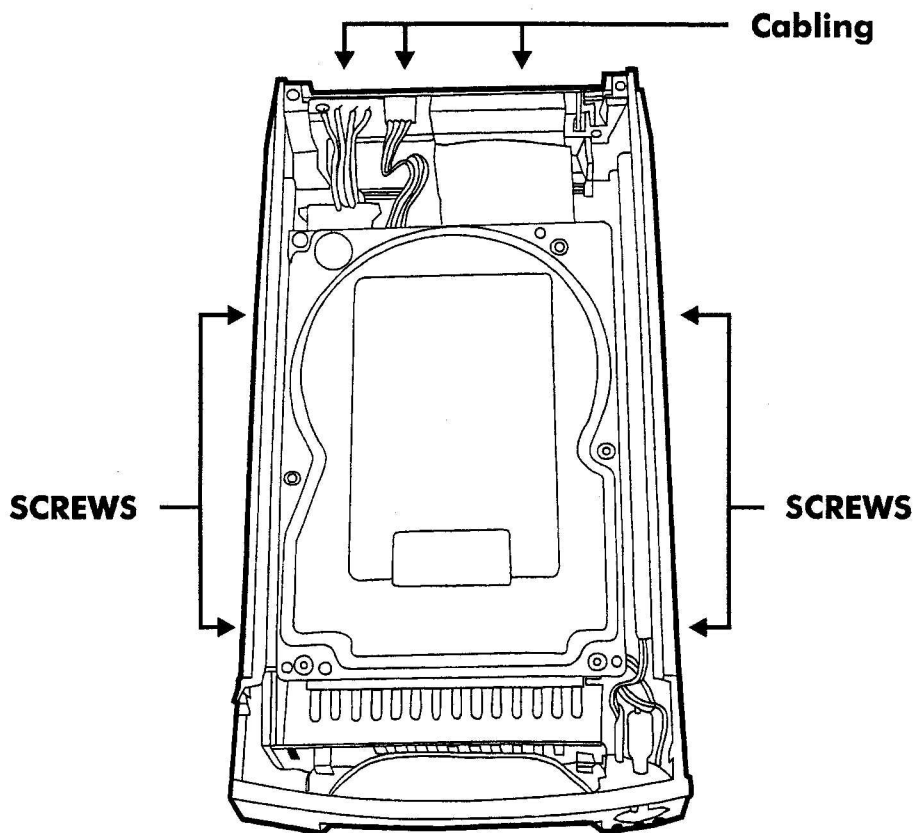

Figure : Installing HDD step 4, 5, 6