

ILLUSTRATED PARTS LIST

MODEL NUMBER M53-140WF

PRODUCT NUMBER 961 41 02-80

MFG. ID. NUMBER 96141028001

McCULLOCH ROTARY LAWN MOWER - MODEL NO. M53-140WF (96141028001) PRODUCT NO. 961 41 02-80

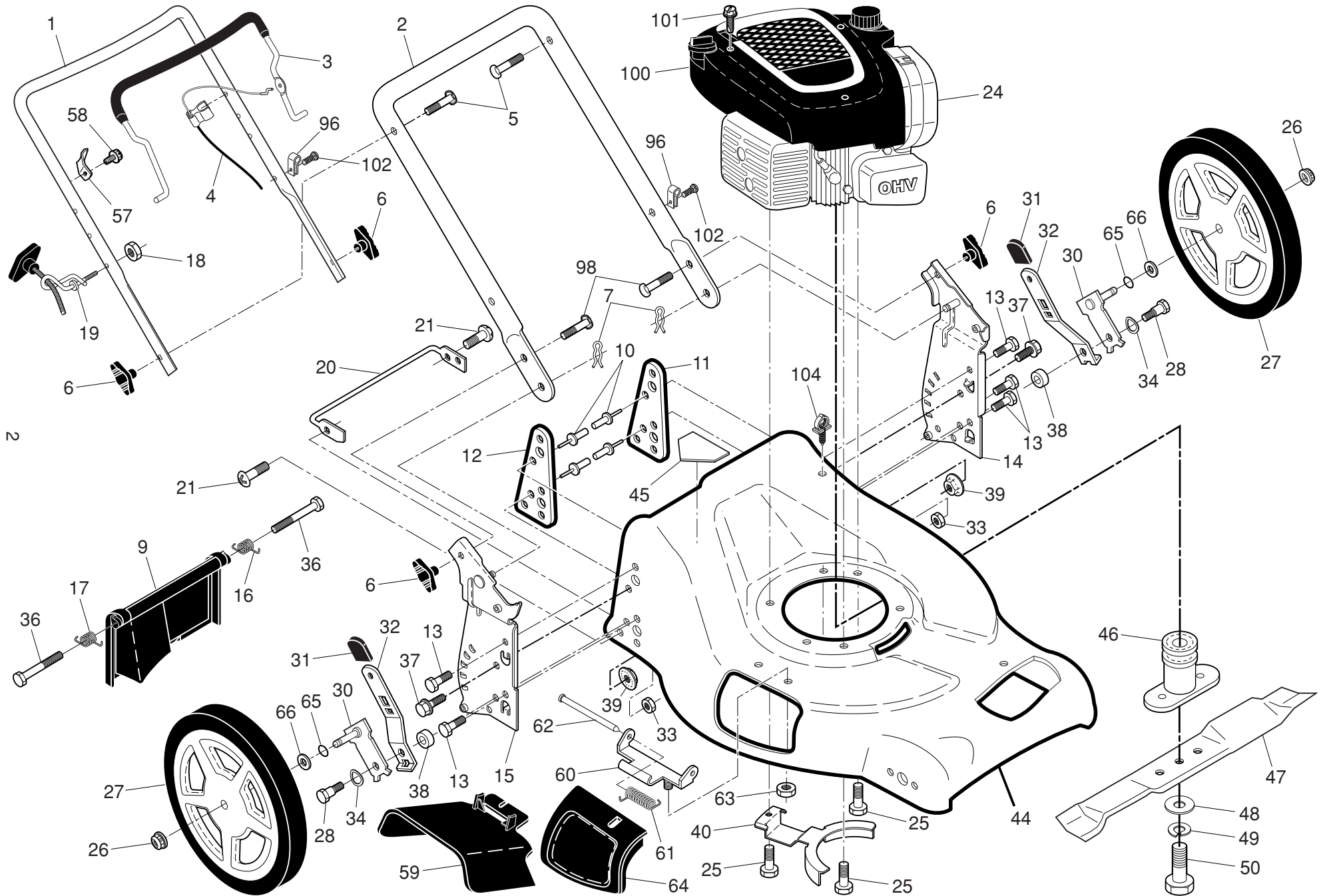

McCULLOCH ROTARY LAWN MOWER - MODEL NO. M53-140WF (96141028001) PRODUCT NO. 961 41 02-80

KEY NO.	PART NO.	DESCRIPTION	KEY NO.	PART NO.	DESCRIPTION
1	580 63 87-02	Upper Handle	37	874 78 05-12	Thread Cutting Screw w/Sems 5/16-18 x 3/4
2	532 43 45-14	Lower Handle	38	532 40 16-29	Spacer
3	580 84 91-04	Control Bar, Molded	39	532 15 53-77	Nut, Hex, Flanged 5/16-18
4	532 42 40-33	Engine Zone Control Cable	40	532 43 50-59	Belt Keeper
5	532 19 15-74	Handle Bolt	44	532 40 92-65	Kit, Lawn Mower Housing (Includes Key Numbers 10, 11, 12 and 45)
6	532 19 19-38	Handle Knob	45	532 18 21-66	Danger Decal
7	532 05 17-93	Hairpin Cotter	46	581 36 71-01	Blade Adapter / Pulley
9	532 40 69-85	Rear Door	47	532 19 93-77	Blade, 21"
10	532 12 84-15	Pop Rivet	48	532 85 10-74	Hardened Washer
11	532 41 05-40	Support Bracket, LH	49	532 85 02-63	Helical Washer 3/8-24 x 1-3/8 Grade 8
12	532 41 05-42	Support Bracket, RH	50	532 85 10-84	Hex Head Machine Screw 3/8-24 x 1-3/8 Grade 8
13	817 06 04-10	Screw 1/4-20 x 5/8	57	532 43 00-34	Upstop Bracket
14	532 43 45-13	Handle Bracket Assembly, LH	58	532 17 88-48	Screw, Hex Washer Head #10-16 x 5/8
15	532 43 45-12	Handle Bracket Assembly, RH	59	532 17 50-71	Discharge Deflector
16	532 40 54-17	Spring, Rear Door, LH	60	532 17 57-35	Hinge Bracket
17	532 40 54-18	Spring, Rear Door, RH	61	532 19 30-00	Hinge Spring
18	532 13 20-04	Nut, Hex	62	532 17 56-50	Hinge Rod
19	532 19 47-88	Rope Guide	63	873 80 04-00	Nut, Hex
20	532 43 61-19	Foot Guard, C.E.	64	532 17 50-66	Mulcher Door
21	817 49 04-16	Screw, Tapping 1/4-20 x 1/2	65	532 19 74-80	O-Ring
24	---	Engine, Briggs & Stratton, Model Number 9P602-0062-H1 (order parts from B&S)	66	532 08 83-48	Washer, Flat
25	532 15 04-06	Hex Head Thread Rolling Screw 3/8-16 x 1-1/8	96	532 19 79-91	Clip, Cable
26	532 40 91-49	Hex Flange Nut	98	872 25 05-05	Bolt, Carriage
27	581 01 03-05	Wheel & Tire Assembly, Rear, 12"	100	580 44 56-01	Shroud, Engine
28	532 40 16-38	Shoulder Bolt 5/16-18 x .33	101	532 18 16-98	Screw, Mounting, Engine Shroud
30	532 41 31-41	Axle Arm Assembly, Rear	102	532 42 81-24	Fastener, Push
31	532 08 78-77	Selector Knob	104	532 14 50-06	Clip, Cable
32	532 40 98-89	Selector Spring	--	532 18 21-91	Decal, Warning (not shown)
33	873 80 05-00	Nut, Hex 5/16-18	--	115 54 34-20	Operator's Manual, European
34	532 40 16-30	Washer, Curved, Cylindrical	--	115 54 34-10	Operator's Manual, Scandinavian
36	532 18 41-93	Bolt	--	115 54 34-50	Operator's Manual, East Bloc
			--	115 54 34-40	Operator's Manual, Baltic

NOTE: All component dimensions given in U.S. inches. 1 inch = 25.4 mm. **IMPORTANT:** Use only Original Equipment Manufacturer (O.E.M.) replacement parts. Failure to do so could be hazardous, damage your lawn mower and void your warranty.

McCULLOCH ROTARY LAWN MOWER - MODEL NO. M53-140WF (96141028001) PRODUCT NO. 961 41 02-80

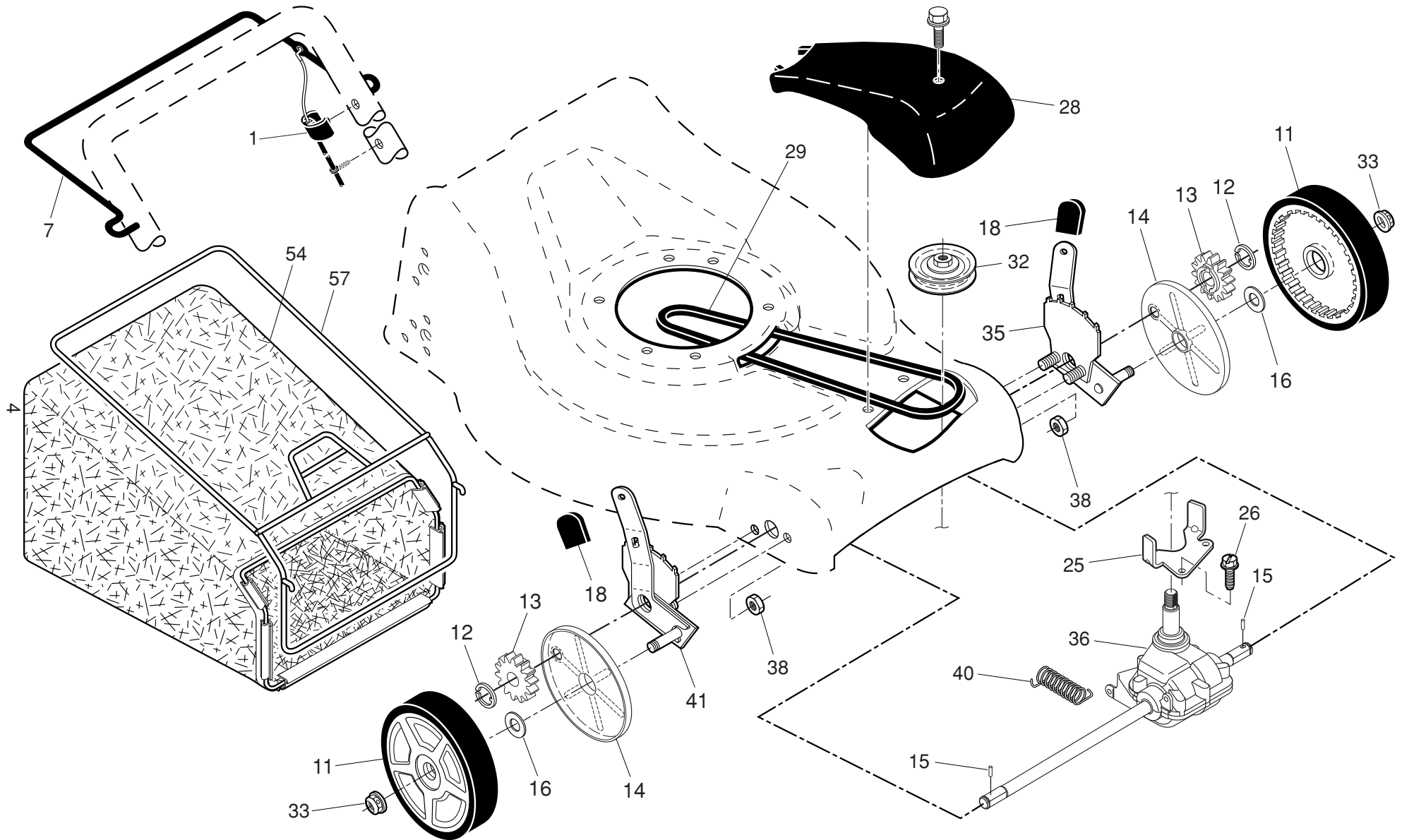

McCULLOCH ROTARY LAWN MOWER - MODEL NO. M53-140WF (96141028001) PRODUCT NO. 961 41 02-80

KEY NO.	PART NO.	DESCRIPTION	KEY NO.	PART NO.	DESCRIPTION
1	581 07 69-01	Drive Control Assembly (Includes Cable)	29	532 19 41-49	V-Belt
7	580 65 93-02	Control Bar, Drive	32	532 44 32-62	Drive Pulley
11	581 00 92-05	Wheel & Tire Assembly, Front (Driven)	33	532 40 91-48	Locknut, Hex
12	812 00 00-58	E-Ring	35	532 43 84-85	Kit, Wheel Adjuster, LH (Includes Knob and Bearing)
13	532 40 38-49	Pinion Assembly	36	532 40 48-33	Gearcase Assembly, Complete
14	581 84 04-01	Dust Cover	38	873 80 04-00	Locknut, Hex 1/4-20
15	532 40 48-45	Pawl, Drive	40	532 40 65-58	Spring
16	532 06 77-25	Washer 1/2 x 1-1/2 x .134	41	532 43 84-86	Kit, Wheel Adjuster, RH (Includes Knob and Bearing)
18	532 08 78-77	Selector Knob	54	580 95 34-04	Grassbag
25	532 43 17-11	Belt Keeper	57	532 41 19-50	Frame, Grassbag
26	532 16 34-09	Screw, Hi-Lo Thread #12 x 5/8			
28	532 43 26-63	Drive Cover Assembly (Includes Mounting Screw and Pushnut)			

5

NOTE: All component dimensions given in U.S. inches. 1 inch = 25.4 mm. **IMPORTANT:** Use only Original Equipment Manufacturer (O.E.M.) replacement parts. Failure to do so could be hazardous, damage your lawn mower and void your warranty.