

McCULLOCH

Electrolux

CABRIO 251 / 25 cc
CABRIO 261 / 25 cc
CABRIO 262 / 25 cc
CABRIO 290 / 29 cc
CABRIO 291 / 29 cc

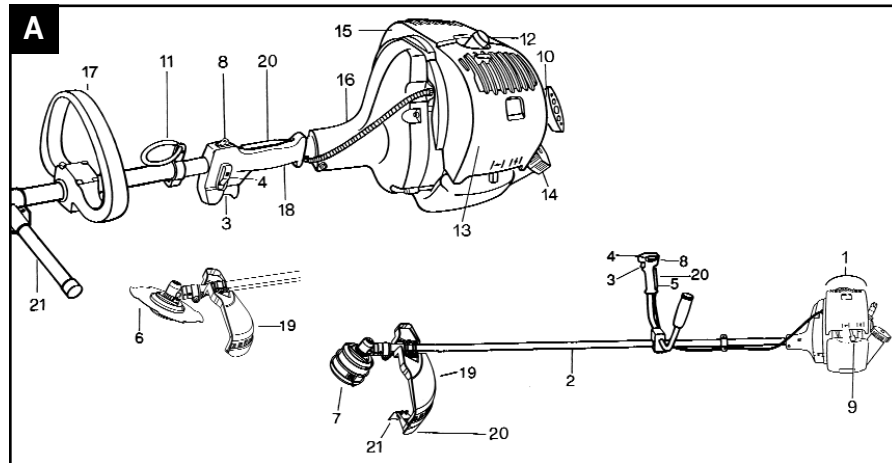
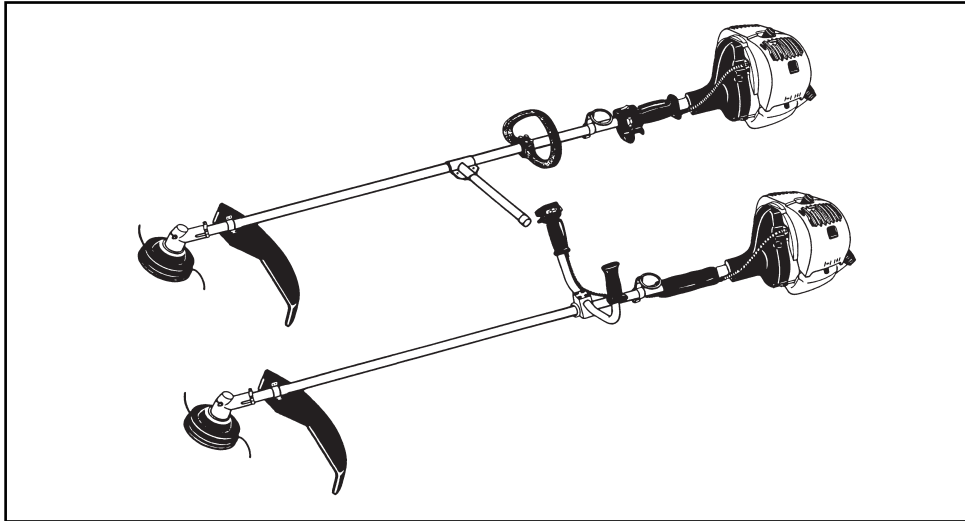

	Partner oil	McCulloch oil	2T oil
	50:1	40:1	25:1
	2%	2,5%	4%
1 ltr	20 cm³	25 cm³	40 cm³
4	80	100	160
5	100	125	200
10	200	250	400
20	400	500	800

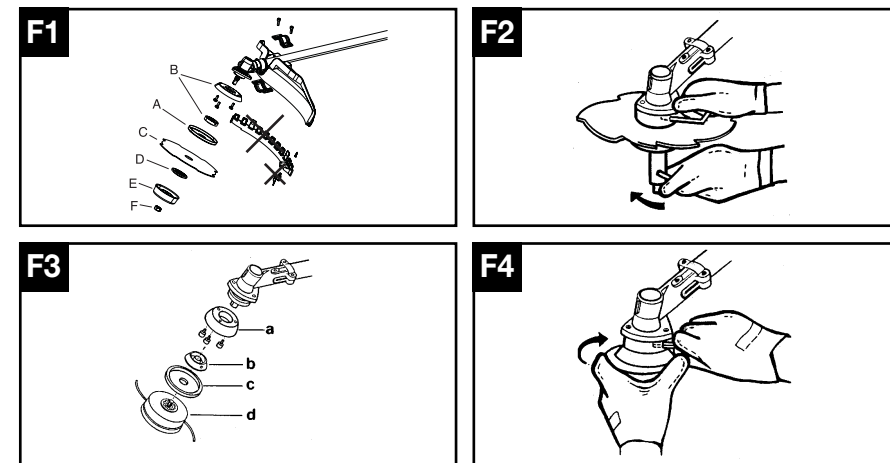
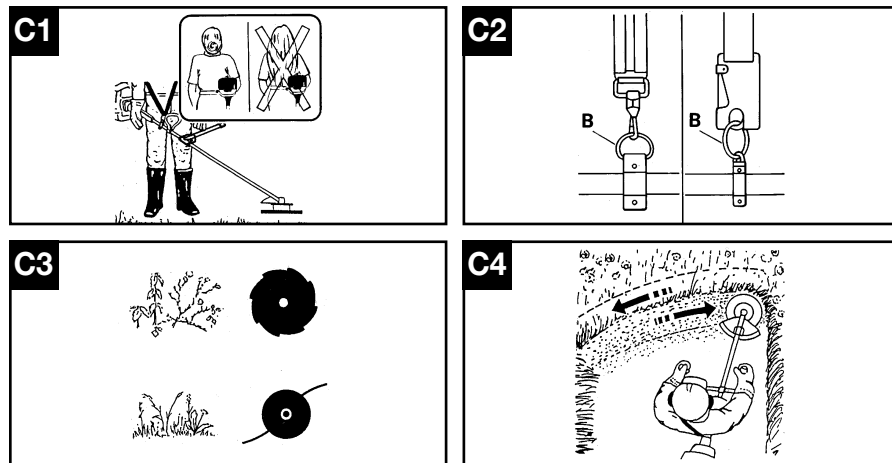
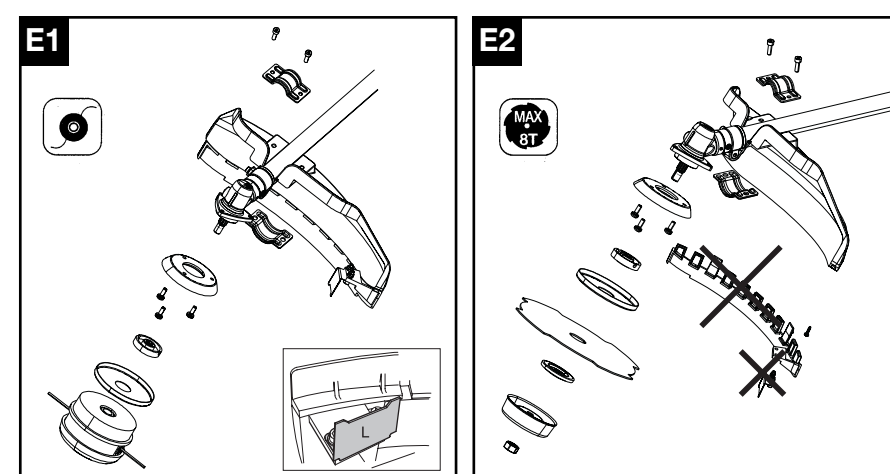
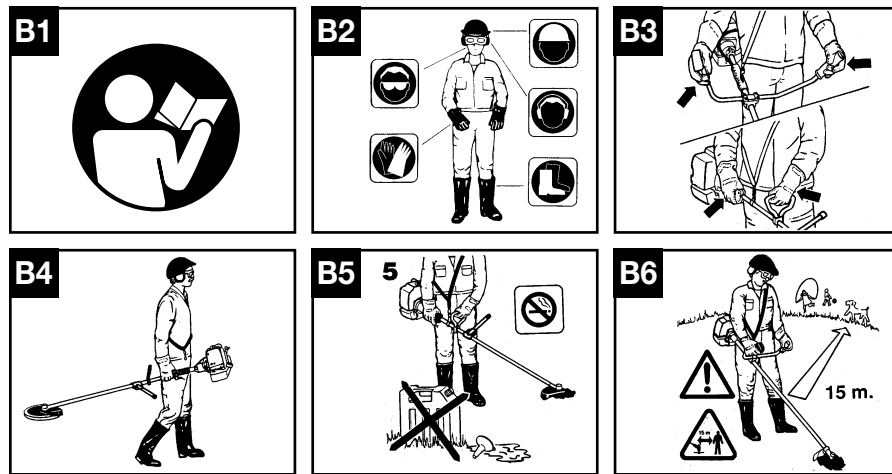

GB INSTRUCTION MANUAL
IMPORTANT INFORMATION: Please read these instructions carefully and make sure you understand them before using this unit. Retain these instructions for future reference.

I LIBRETTO D'ISTRUZIONI
INFORMAZIONI IMPORTANTI: Leggere le istruzioni attentamente e capirle bene prima di usare il prodotto. Conservare per ulteriore consultazione.

F MANUEL D'INSTRUCTIONS
RENSEIGNEMENTS IMPORTANTS: Avant d'utiliser cet appareil, veuillez lire attentivement les instructions et assurez-vous de les avoir comprises. Conservez les instructions pour référence ultérieure.

D BETRIEBSANWEISUNG
WICHTIGE INFORMATION: Lesen Sie diese Hinweise zur Handhabung des Geräts aufmerksam durch. Verwenden Sie es erst, wenn Sie sicher sind, daß Sie alle Anweisungen verstanden haben und gut aufbewahren.

E MANUAL DE INSTRUCCIONES
INFORMACION IMPORTANTE: Lea atentamente las instrucciones y asegúrese de entenderlas antes de utilizar esta aparato. Conserve las instrucciones para la referencia en el futuro.

NL HANDLEIDING
BELANGRIJKE IMPORTANTS: Lees deze handleiding aandachtig en zorg dat u alles begrijpt alvorens de kettingzaag te gebruiken en be-waar ze voor toekomstige raadpleging.

S BRUKSANVISNING
VIKTIG INFORMATION: Läs instruktionerna noggrant och försäkra dig om att du förstår dem innan du använder utrustningen och spara dem för framtida behov.

DK BRUGERHÅNDBOG
VIGTIGE OPLYSNINGER: Læs instruktionerne omhyggeligt, for du bruger enheden og gemme til senere henvisning.

FIN OHJEKIRJA
TÄRKEÄÄ TIETOA: Lue nämä ohjeet huolellisesti ja varmista, että olet ymmärtänyt ne, ennen kuin alat käyttää tätä laitetta ja säilytä myöhempää tarvetta varten.

N BRUKERHÅNDBOK
VIKTIG INFORMASJON: Les disse anvisningene nøye og forsikre deg om at du forstår dem for du bruker enheten og oppbevar dem for senere bruk.

P MANUAL DO OPERADOR
INFORMAÇÕES IMPORTANTES: Queira ler cuidadosamente estas instruções e tenha certeza de entendê-las antes de usar a serra e guarde para consulta futura.

GR ΕΓΧΕΙΡΙΔΙΟ ΧΕΙΡΙΣΜΟΥ
ΣΗΜΑΝΤΙΚΕΣ ΠΛΗΡΟΦΟΡΙΕΣ: Διαβάστε προσεκτικά αυτές τις οδηγίες και φροντίστε να τις κατανοήσετε αντί το μηχάνημα και φυλάξτε το για να το συμβουλευέστε στο μέλλον.

HU HASZNÁLATI ÚTMUTATÓ
Jótállást vállalni csak rendeltetésszerűen használatba vett gépekre tudunk. Kérj ú hogy a gép használatba vétele előtt gondosan olvassa el a kezelési utasításokat.

Electrolux Outdoor Products
 Via Como 72
 23868 Valmadrera (Lecco)
ITALIA
 Phone +39 0341 203111 - Fax +39 0341 581671

Our policy of continuous improvement means that the specification of products may be altered from time to time without prior notice. Electrolux Outdoor Products manufacture products for a number of well known brands under various registered patents, designs and trademarks in several countries.
 © Electrolux Outdoor Products Italy

The Electrolux Group. The world's No.1 choice.

The Electrolux Group is the world's largest producer of powered appliances for kitchen, cleaning and outdoor use. More than 55 million Electrolux Group products (such as refrigerators, cookers, washing machines, vacuum cleaners, chain saws and lawn mowers) are sold each year to a value of approx. USD 14 billion in more than 150 countries around the world.



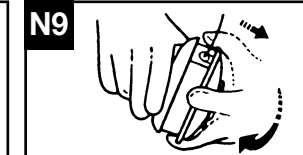
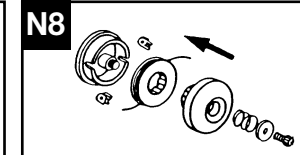
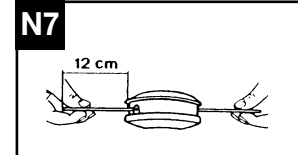
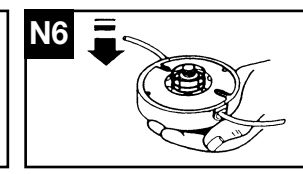
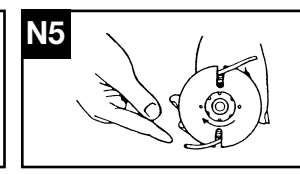
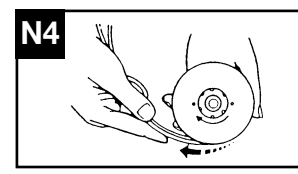
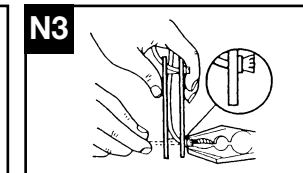
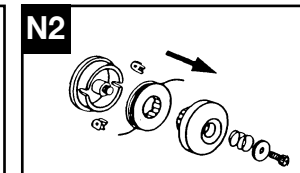
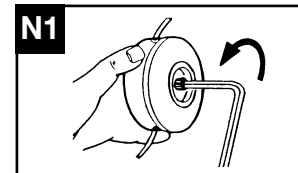
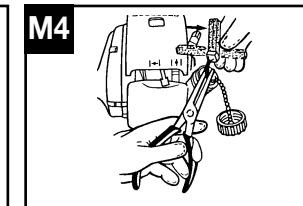
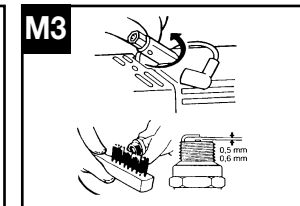
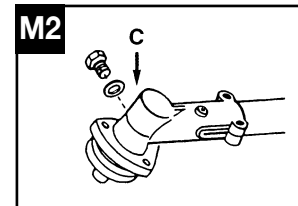
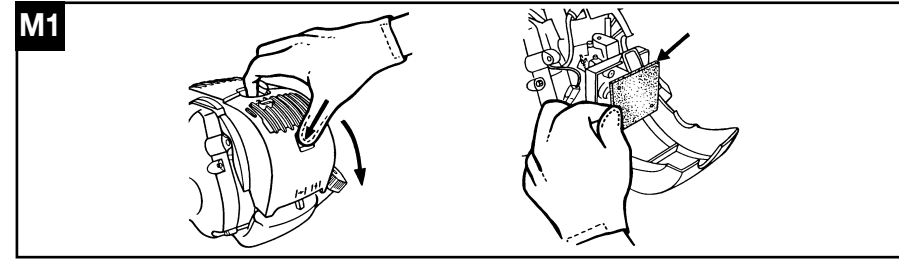
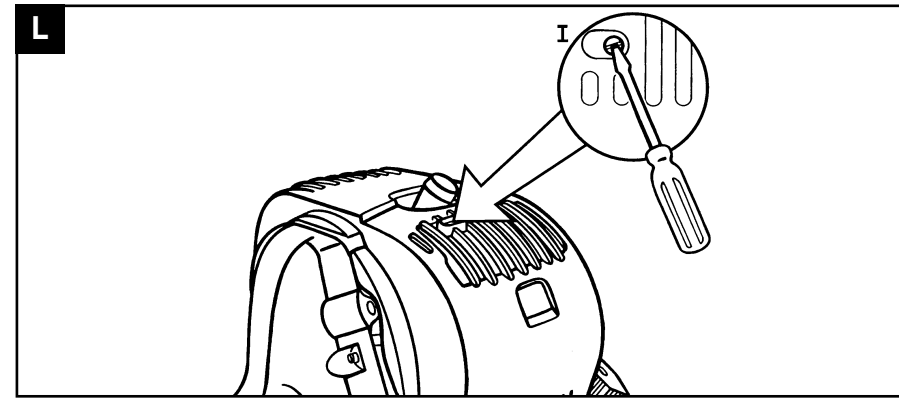
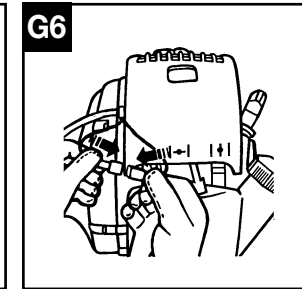
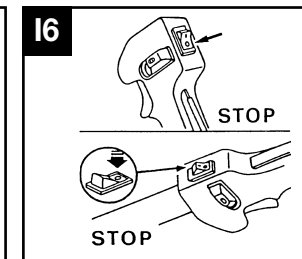
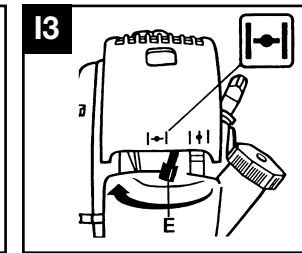
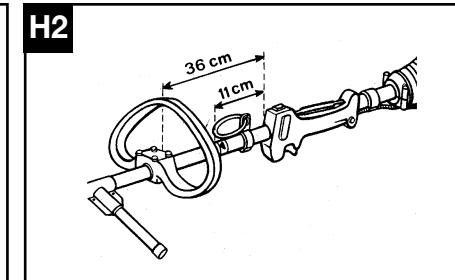
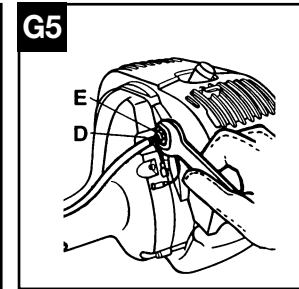
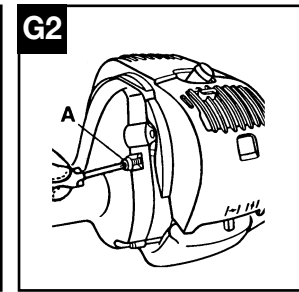
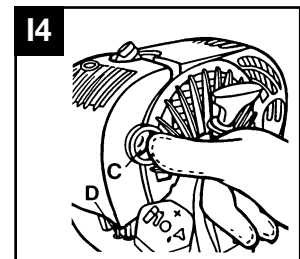
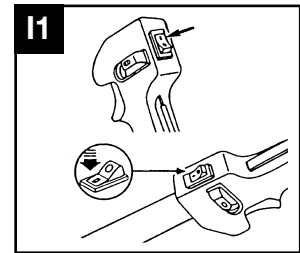
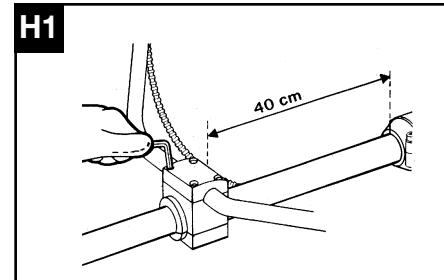
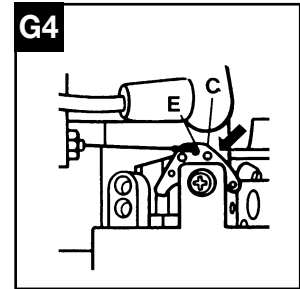
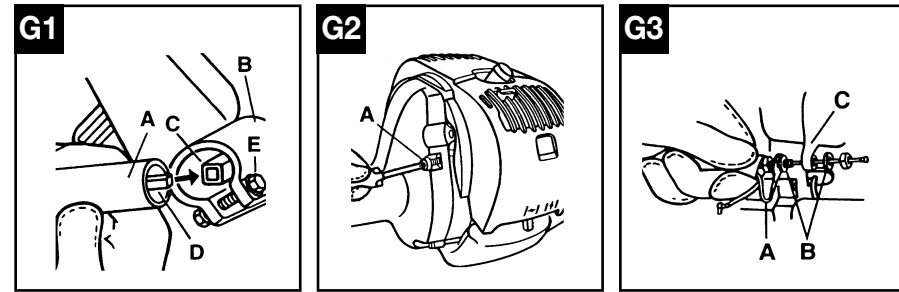

 25/29 cc	
0,095" 2.4mm	197" 5000mm
	538249174
	242043
4T	9" 230 mm
	226134B
	242043
4T	10" 255 mm
	226135B
	242043
8T	9" 230mm
	236711B
	242043
8T	10" 255mm
	236713B
	242043

GB SUMMARY CHART TO IDENTIFY THE CORRECT GUARD NEEDED, WITH DIFFERENT CUTTING ATTACHMENTS

I TABELLA RIASSUNTIVA PER IL CORRETTO ABBINAMENTO TESTA TAGLIANTE / DIFESA DI SICUREZZA

F TABLEAU RECAPITULATIF POUR LE CORRECT ACCOUPLEMENT LAME OU TETE FIL NYLON / DEFENSE DE SECURITE

D ÜBERSICHTSTABELLE ZUR AUSWAHL DES RICHTIGEN SCHUTZBLECHES FÜR DIE EINZELNEN SCHNEIDWERKZEUGE

E TABLA PARA EL CORRECTO ACOPLAMIENTO DE LA CABEZA CORTANTE Y PROTECTOR DE SEGURIDAD

NL OVERZICHTSTABEL OM TE BEPALEN WELKE BESCHERMKAP GEBRUIKT MOET WORDEN BIJ DE DIVERSE MAAI-ONDERDELEN

S SAMMANFATTANDE TABELL ÖVER KORREKT KOMBINATION AV SKÄRHUVUD/SÄKERHETSSKYDD

DK OVERSIGTSTABEL VEDRØRENDE DEN KORREKTE SAMMENSÆTNING AF KNIV OG BESKYTTELSESSKÆRM

FIN TAULOKKO LEIKKAAVAN PÄÄN/TURVASUOJUKSEN OIKEASTA YHDISTELMÄSTÄ

N TABELL FOR KORREKT MONTERING AV TRÅDSPOLE/SAGBLAD OG SPRUTSKJÆRM/SIKKERHETSVÆRN

P TABELA DE RESUMO PARA A CORRETA APLICAÇÃO DA CABEÇA CORTANTE E DEFESA DE SEGURANÇA

GR ΠΕΡΙΛΗΠΤΙΚΟΣ ΠΙΝΑΚΑΣ ΓΙΑ ΤΗΝ ΕΠΙΣΗΜΑΝΣΗ ΤΟΥ ΚΑΤΑΛΛΗΛΟΥ ΠΡΟΦΥΛΑΚΤΗΡΑ, ΜΕ ΔΙΑΦΟΡΑ ΚΟΠΤΙΚΑ ΕΞΑΡΤΗΜΑΤΑ

H ÖSSZEFOGLALÓ TÁBLAZAT: A NYÍRÓFEJ ÖSSZEÁLLÍTÁSA / BALESETVÉDELEM

GB EC Declaration of Conformity

The undersigned, authorised by E.O.P.I., declares that the following products: **CABRIO 25/29 cc**, manufactured by E.O.P.I., Valmadrera, Italia, are in accordance with the European Directives **98/37/EEC** (Machinery Directive), **93/68/CEE** (CE Marking Directive) & **89/336/CEE** (Directive on electromagnetic compatibility), directive **2000/14/CEE** (Annex V).

I Dichiarazione di Conformità CE

Il sottoscritto, autorizzato dalla E.O.P.I., dichiara che i seguenti prodotti: **CABRIO 25/29 cc**, costruito da E.O.P.I., Valmadrera, Italia, sono conformi alle Direttive Europee: **98/37/EEC** (Direttiva Macchine), **93/68/CEE** (Direttiva Marcatura CEE) & **89/336/CEE** (Direttiva Compatibilità Elettromagnetica), direttiva **2000/14/CEE** (Allegato V).

F Déclaration de conformité Européenne

Le soussigné, dûment mandaté par E.O.P.I., déclare que les produits suivants: **CABRIO 25/29 cc**, construits par E.O.P.I., Valmadrera, Italia, sont conformes aux Directives Européennes **98/37/EEC** (Directive Sécurité Machine), **93/68/CEE** (Directive Marquage CE) & **89/336/CEE** (Directive EMC), directive **2000/14/CEE** (Annexe V).

D CE Konformitätserklärung

Der Unterzeichnete, bevollmächtigt durch E.O.P.I., erklärt, daß folgende Geräte: **CABRIO 25/29 cc**, hergestellt durch E.O.P.I., Valmadrera, Italia, den Europäischen Richtlinien **98/37/EEC** (Maschinenrichtlinie), **93/68/CEE** (CE Kennzeichnungsrichtlinie) & **89/336/CEE** (EMV Richtlinie) entsprechen, richtlinie **2000/14/CEE** (Anhang V).

E Declaracion de cumplimiento de la directriz de la UE

El abajo firmante, autorizado por E.O.P.I., afirma que los siguientes productos: **CABRIO 25/29 cc**, fabricados por E.O.P.I., Valmadrera, Italia, cumplen con las directivas Europeas **98/37/EEC** (Directiva sobre Maquinaria), **93/68/CEE** (Directiva sobre Marcas de la CE) & **89/336/CEE** (Directiva sobre Compatibilidad Electro Magnética), directiva **2000/14/CEE** (Anexo V).

NL EG Conformiteitsverklaring

Ondergetekende, gemachtigd door E.O.P.I., verklaart dat de volgende producten: **CABRIO 25/29 cc**, geproduceerd door E.O.P.I., Valmadrera, Italia voldoen aan de Europese Richtlijnen **98/37/EEC** (Machinery Richtlijn), **93/68/CEE** (EG Markering Richtlijn) & **89/336/CEE** (Richtlijn aangaande elektromagnetische compatibiliteit), richtlijn **2000/14/CEE** (Annex V).

S EG-försäkran om överensstämmelse

Undertecknad, auktoriserad av E.O.P.I., försäkrar att följande produkter: **CABRIO 25/29 cc**, tillverkade av E.O.P.I., Valmadrera, Italia, är i överensstämmelse med följande europeiska direktiv **98/37/EEC** (Maskindirektiv), **93/68/CEE** (CE-märknings-direktiv) & **89/336/CEE** (Elektromagnetisk kompatibilitet), direktiv **2000/14/CEE** (Annex V).

DK EU Overensstemmelseerklæring

Undertegnede, bemyndiget af E.O.P.I., erklærer herved, at følgende produkter: **CABRIO 25/29 cc**, E.O.P.I., Valmadrera, Italia, er i overensstemmelse med de europæiske direktiver **98/37/EEC** (Maskineri direktiv), **93/68/CEE** (CE mærkningsdirektiv) & **89/336/CEE** (EMC-direktiv), direktiv **2000/14/CEE** (Annex V).

FIN EY Julistus Vastaavuudesta

Allekirjoittanut, E.O.P.I. in valtuuttamana, vakuuttaa että seuraavat tuotteet: **CABRIO 25/29 cc**, ja jotka on valmistanut E.O.P.I., Valmadrera, Italia, ovat Euroopan direktiivien **98/37/EEC** (Koneisto-direktiivi), **93/68/CEE** (CE Merkintä-direktiivi) & **89/336/CEE** (Elektromagneettinen Yhteensopivuus-direktiivi) mukainen, direktiivi **2000/14/CEE** (Liite V).

N EF Erklæring om Overensstemmelse

Undertegnede, autorisert av E.O.P.I., erklærer at følgende produkt **CABRIO 25/29 cc**, konstruert av E.O.P.I. 23868 Valmadrera (Lecco) Via Como, 72 Italia, er i overensstemmelse med følgende europeiske direktiver: **98/37/CEE** (Maskineridirektiv), **93/68/CEE** (CE-merkningsdirektiv) & **89/336/CEE** (Direktiv om elektromagnetisk kompatibilitet), direktiv **2000/14/CEE** (Annex V).

P Declaração de Conformidade

O abaixo assinado, autorizado por E.O.P.I., declara que os seguintes produtos: **CABRIO 25/29 cc**, fabricada por E.O.P.I., Valmadrera, Italia, estão de acordo com as Directivas Europeias **98/37/EEC** (Directiva de Maquinaria), **93/68/CEE** (Directiva de Marcação CE) e **89/336/CEE** (Directiva de Compatibilidade Electromagnética), directiva **2000/14/CEE** (Apêndice V).

GR Δήλωση Συμμόρφωσης προς τις Εντολές της ΕΕ

Ο υπογεγραμμένος, με εξουσιοδότηση της E.O.P.I., δηλώνει ότι τα εξής προϊόντα: **CABRIO 25/29 cc**, κατασκευασθέντα από την E.O.P.I., Valmadrera, Italia, ΗΠΑ ανταποκρίνονται προς τις Ευρωπαϊκές Εντολές **98/37/CEE** (η περί Μηχανήματος Εντολή), **93/68/CEE** (η περί του Σήματος CE Εντολή) & **89/336/CEE** (η περί Ηλεκτρομαγνητικής Συμβατότητας Εντολή), Ανεκρίθη **2000/14/CEE** (Πρήρο επιτη V).

H Technikai leírások

Alulírott, rendelkező a E.O.P.I. engedélyével, kijelenti, hogy a jelenteműk **CABRIO 25/29 cc**, melyet a E.O.P.I. 23868 Valmadrera (Lecco) Via Como, 72 Italia, gyártott, megfelel az európai szabványoknak: **98/37/CEE** (gépreke vonatkozó), **93/68/CEE** (márkázásnak) és **89/336/CEE** (elektromágneses összességzetetehetőségnek) megfelelnek, direktiva **2000/14/CEE** (Melléklet V).

Todero Carlo
Valmadrera, 15.12.01
Pino Todero (Direttore Tecnico)
E.O.P.I.

GB TECHNICAL DATA

DISPLACEMENT (cm ³)	25	29
BORE AND STROKE (mm)	35x26	38x26
ENGINE OUTPUT (Kw)	0,7	0,8
ENGINE SPEED AT MAX POWER (min ⁻¹)	7.500	7.500
MAXIMUM SPEED, NO LOAD (min ⁻¹)	9.500	9.500
MINIMUM SPEED (min ⁻¹)	2.800	2.800
BLADE SHAFT SPEED (min ⁻¹)	7.300	7.300
BLADE LOCKING NUT TIGHTENING TORQUE (Nm)	17	17
DRY WEIGHT (kg)	5,8	5,8
FUEL TANK CAPACITY (cm ³)	620	620
SOUND PRESSURE LEVEL (AT THE OPERATOR'S EAR) LpAav (dBA) (ISO7917)	99	99
GUARANTEED SOUND POWER LEVEL LwAav (dBA) (ISO 10884)	113	113
MEASURED SOUND POWER LEVEL LwAav (dBA) (ISO 10884)	112,57	112,57
VIBRATIONS LEVEL STRING HEAD (ISO 7916) (m/s ²) MAX-MIN	8,85-3,94	8,85-3,94
VIBRATIONS LEVEL BLADE (ISO 7916) (m/s ²) MAX-MIN	12,4-3,94	12,4-3,94

I DATI TECNICI

CILINDRATA (cm ³)	25	29
ALESAGGIO x CORSA (mm)	35x26	38x26
POTENZA (Kw)	0,7	0,8
REGIME DI MASSIMA POTENZA (min ⁻¹)	7.500	7.500
VELOCITÀ MAX A VUOTO (min ⁻¹)	9.500	9.500
VELOCITÀ DI MINIMO (min ⁻¹)	2.800	2.800
VELOCITÀ ALBERO PORTALAMA (min ⁻¹)	7.300	7.300
COPPIA SERRAGGIO DADO BLOCCALAMA (Nm)	17	17
PESO A SECCO (Kg)	5,8	5,8
CAPACITÀ SERBATOIO MISCELA (cm ³)	620	620
PRESSIONE SONORA (ALL'ORECCHIO DELL'OPERATORE) LpAav (dBA) (ISO 7917)	99	99
LIVELLO POTENZA SONORA GARANTITA LwAav (dBA) (ISO 10884)	113	113
LIVELLO POTENZA SONORA MISURATA LwAav (dBA) (ISO 10884)	112,57	112,57
LIVELLO VIBRAZIONI MAX TESTA A FILI (ISO 7916) (m/s ²) MAX-MIN	8,85-3,94	8,85-3,94
LIVELLO VIBRAZIONI MAX LAMA (ISO 7916) (m/s ²) MAX-MIN	12,4-3,94	12,4-3,94

F CARACTERISTIQUE TECHNIQUES

CYLINDREE (cm ³)	25	29
ALESAGE/COURSE (mm)	35x26	38x26
PUISSANCE (kW)	0,7	0,8
REGIME MAXIMUM DE PUISSANCE (min ⁻¹)	7.500	7.500
REGIME MAXIMUM A VIDE (min ⁻¹)	9.500	9.500
REGIME DE RALENTI (min ⁻¹)	2.800	2.800
REGIME ARBRE DE TRANSMISSION/LAME (min ⁻¹)	7.300	7.300
COUPLE DE SERRAGE VIS BLOCAGE DE LAME (Nm)	17	17
POIDS A VIDE (Kg)	5,8	5,8
CAPACITE DU RESERVOIR (cm ³)	620	620
PRESSION SONORE (A L'OREILLE DE L'OPERATEUR) LpAav (dBA) (ISO 7917)	99	99
NIVEAU DE PUISSANCE SONORE GARANTI LwAav (dBA) (ISO 10884)	113	113
NIVEAU DE PUISSANCE SONORE MESURE LwAav (dBA) (ISO 10884)	112,57	112,57
VIBRATIONS TETE FIL NYLON (ISO 7916) (m/s ²) MAX-MIN	8,85-3,94	8,85-3,94
VIBRATIONS LAME (ISO 7916) (m/s ²) MAX-MIN	12,4-3,94	12,4-3,94

D TECHNISCHE DATEN

HUBRAUM (cm ³)	25	29
BOHRUNG X HUB (mm)	35x26	38x26
LEISTUNG (Kw)	0,7	0,8
HÖCHSTDREHZAHN (min ⁻¹)	7.500	7.500
OBERE LEERLAUFDREHZAHN (min ⁻¹)	9.500	9.500
LEERLAUFDREHZAHN (min ⁻¹)	2.800	2.800
DREHZAHN SCHLAGBLATTWELLE (min ⁻¹)	7.300	7.300
ANZUGSMOMENT SICHERUNGSMUTTER (Nm)	17	17
TROCKENGEWICHT (Kg)	5,8	5,8
TANKINHALT (cm ³)	620	620
SCHALLDRUCK (AM OHR DES BENUTZERS) LpAav (dBA) (ISO 7917)	99	99
SCHALLLEISTUNGS - STUFE GEWÄHRLEISTET LwAav (dBA) (ISO 10884)	113	113
SCHALLLEISTUNGSSTUFE GEMESSEN LwAav (dBA) (ISO 10884)	112,57	112,57
FADENKOPFVIBRATIONEN (ISO 7916) (m/s ²) MAX-MIN	8,85-3,94	8,85-3,94
SCHLAGBLATTVIBRATIONEN (ISO 7916) (m/s ²) MAX-MIN	12,4-3,94	12,4-3,94

E DATOS TECNICOS

CILINDRADA (cm ³)	25	29
DIAMETRO Y CARRERA (mm)	35x26	38x26
POTENCIA DEL MOTOR (Kw)	0,7	0,8
REGIMEN DE MAXIMA POTENCIA (min ⁻¹)	7.500	7.500
VELOCIDAD MAXIMA EN VACIO (min ⁻¹)	9.500	9.500
VELOCIDAD AL MINIMO (min ⁻¹)	2.800	2.800
VELOCIDAD EJE/CUCHILLA (min ⁻¹)	7.300	7.300
LLAVE DE TORNILLO TORNILLO DE FIJACION DE LA CUCHILLA (Nm)	17	17
PESO EN VACIO (Kg)	5,8	5,8
CAPACIDAD DEL DEPOSITO DE COMBUSTIBLE (cm ³)	620	620
PRESION SONORA (AL OIDO DEL USUARIO) LpAav (dBA) (ISO 7917)	99	99
NIVEL DE POTENCIA SONORA GARANTIZADA LwAav (dBA) (ISO 10884)	113	113
NIVEL DE POTENCIA SONORA MEDIDA LwAav (dBA) (ISO 10884)	112,57	112,57
VIBRACIONES CABEZA DE HILO (ISO 7916) (m/s ²) MAX-MIN	8,85-3,94	8,85-3,94
VIBRACIONES CUCHILLA (ISO 7916) (m/s ²) MAX-MIN	12,4-3,94	12,4-3,94

NL TECHNISCHE GEGEVENS

INHOUD MOTOR (cm ³)	25	29
BORING EN SLAG (mm)	35x26	38x26
MOTOR VERMOGEN (Kw)	0,7	0,8
TOERENTAL BIJ MAXIMAAL VERMOGEN (min ⁻¹)	7.500	7.500
MAXIMUM SNELHEID, ZONDER BELASTING (min ⁻¹)	9.500	9.500
MINIMUM SNELHEID (min ⁻¹)	2.800	2.800
SNELHEID BOOM-BLAD (min ⁻¹)	7.300	7.300
BLADBEVESTIGINGSBOUT (Nm)	17	17
LEDIG GEWICHT (Kg)	5,8	5,8
INHOUD BRANDSTOFTANK (cm ³)	620	620
DUTCHI GELUIDSDAUK (AAN HET DOR VAN DE GEBRUIKER) LpAav (dBA) (ISO 7917)	99	99
GEWAARBORGD GELUIDSVERMOGENSNIVEAU LwAav (dBA) (ISO 10884)	113	113
GEMETEN GELUIDSVERMOGENSNIVEAU LwAav (dBA) (ISO 10884)	112,57	112,57
VIBRATIE NYLON DRAADKOP (ISO 7916) (m/s ²) MAX-MIN	8,85-3,94	8,85-3,94
VIBRATIE MAAIBLAD (ISO 7916) (m/s ²) MAX-MIN	12,4-3,94	12,4-3,94

S TEKNISKA DATA

CYLINDERVOLYM(cm ³)	25	29
BORRINGxSLAG (mm) 35x30	35x26	38x26
EFFEKT (kW)	0,7	0,8
VARVTAL VID MAX. EFFEKT (min ⁻¹)8.000	7.500	7.500
HÖGSTA HASTIGHET VID TOMGÅNG (min ⁻¹)	9.500	9.500
LAGSTA HASTIGHET (min ⁻¹)	2.800	2.800
HÖGSTA HASTIGHET KLINGA (min ⁻¹)	7.300	7.300
SPÄNNINGSMUTTRAR FÖR BLOCKERING AV KLINGAN (Nm)	17	17
TORRVIKT (Kg)	5,8	5,8
BRÄNSLETÄNKENS KAPACITET (cm ³)	620	620
LJUDNIVÅ (vid örat) LpAav (dBA) (ISO 7917)	99	99
NIVÅ EFFEKT LJUD-GARANTERAD LwAav (dBA) (ISO 10884)	113	113
UPPMÄTT LJUDEFFEKTIVÅ LwAav (dBA) (ISO 10884)	112,57	112,57
VIBRATIONER NYLONTRÄDSHUVUD (ISO 7916) (m/s ²) MAX-MIN	8,85-3,94	8,85-3,94
VIBRATIONER KLINGA (ISO 7916) (m/s ²) MAX-MIN	12,4-3,94	12,4-3,94

DK TEKNISKE DATA

CYLINDER (cm ³)	25	29
UDBORING/STEMPEFLAG (mm)	35x26	38x26
EFFEKT (Kw)	0,7	0,8
MOTOREFFEKT V. MAX.HASTIGHED (min ⁻¹)	7.500	7.500
MAXIMUM HASTIGHED INGEN BALASTNING (min ⁻¹)	9.500	9.500
MINIMUM HASTIGHED (min ⁻¹)	2.800	2.800
MAXIMUM KLINGEOMDREJNINGER (min ⁻¹)	7.300	7.300
SPÆNDING AF KNIVMØTRIK(Nm)	17	17
NETTO VÆGT (Kg)	5,8	5,8
BENZINTÄNKENS KAPACITET (cm ³)	620	620
LYDNIVEAU (VED BRUGERENS ØRE) LpAav (dBA) (ISO 7917)	99	99
KONSTATERET LYDEFFEKTIVÅ LwAav (dBA) (ISO 10884)	113	113
MÅLT LYDSTYRKENIVÅ LwAav (dBA) (ISO 10884)	112,57	112,57
VIBRATIONER NYLONSNØREHOVED (ISO 7916) (m/s ²) MAX-MIN	8,85-3,94	8,85-3,94
VIBRATIONER KNIV (ISO 7916) (m/s ²) MAX-MIN	12,4-3,94	12,4-3,94

FIN TEKNISET TIEDOT

SYLINTERIN TILAVUUS (cm ³)	25	29
HALKAIJSIJÄXIKUNNIPITUUS (mm)	35x26	38x26
TEHO (kW)	0,7	0,8
MOOTTORIN KIERRÄ TÄYDELLÄ TEHOLLA (min ⁻¹)	7.500	7.500
MAKSIMINOPEUS TYHJÄNÄ (min ⁻¹)	9.500	9.500
MINIMINOPEUS (min ⁻¹)	2.800	2.800
TERÄNKANNATTIN AKSELIN NOPEUS (min ⁻¹)	7.300	7.300
TERÄNLUKITSLIAMUTTERIN KIINNITYSPÄRI (Nm)	17	17
MOOTTORIN PAINO (kg)	5,8	5,8
POLTTOAINESÄILÖN tilavuus (cm ³)	620	620
KÄYTTÄJÄN KORVALLE TULEVAÄÄNENPÄINE LpAav (dBA) (ISO 7917)	99	99
ÄNENVOIMAKKUUSTASO TAATTU LwAav (dBA) (ISO 10884)	113	113
ÄNENVOIMAKKUUSTASO MITATTU LwAav (dBA) (ISO 10884)	112,57	112,57
VÄRÄHTELYT NAILONLANKAPÄÄ (ISO 7916) (m/s ²) MAX-MIN	8,85 - 3,94	8,85 - 3,94
VÄRÄHTELYT TERÄ (ISO 7916) (m/s ²) MAX-MIN	12,4 - 3,94	12,4 - 3,94

N TEKNISKE DATA

SYLINDERVOLUM (cm ³)	25	29
SYLINDERMIAMETER OG SLÄGlengde (mm)	35x26	38x26
MOTOREFFEKT (kW)	0,7	0,8
HÖYESTE HASTIGHET (min ⁻¹)	7.500	7.500
MAKSIMUMSHASTIGHETEN VED TOMGANG (min ⁻¹)	9.500	9.500
MINIMUMSHASTIGHET (min ⁻¹)	2.800	2.800
HASTIGHETEN AV BLADHOLDERENS DRIVAKSEL (min ⁻¹)	7.300	7.300
Mutter FOR BLOKKERING AV BLAD (Nm)	17	17
NETTO VEKT (Kg)	5,8	5,8
DRIVSTOFFKAPASITET cm ³	620	620
Lydtrykk LpAav (dBA) (ISO 7917)	99	99
GARANTERT LYDSTYRKENIVÅ LwAav (dBA) (ISO 10884)	113	113
MÅLT LYDSTYRKENIVÅ LwAav (dBA) (ISO 10884)	112,57	112,57
VIBRASJONER NYLONTRÅD KLIPPPEHODE (ISO 7916) (m/s ²) MAX-MIN	8,85 - 3,94	8,85 - 3,94
VIBRASJONER BLAD (ISO 7916) (m/s ²) MAX-MIN	12,4 - 3,94	12,4 - 3,94

P CARACTERÍSTICAS TÉCNICAS

CILINDRADA (cm ³)	25	29
DIAMETRO/CURSO (mm)	35x26	38x26
POTENCIA (Kw)	0,7	0,8
POTENCIA MAXIMA DESENVOLVIDA (min ⁻¹)	7.500	7.500
VELOCIDADE MAXIMA EN VAZIO (min ⁻¹)	9.500	9.500
VELOCIDADE MINIMA (min ⁻¹)	2.800	2.800
VELOCIDADE EIXO/LAMINA (min ⁻¹)	7.300	7.300
PAR APERTO PORCA PARA LAMINA (Nm)	17	17
PESO EM VAZIO (Kg)	5,8	5,8
CAPACIDADE DO DEPOSITO (cm ³)	620	620
PRESSAO SONORA AO OLVIDO DO OPERADORI LpAav (dBA) (ISO 7917)	99	99
NIVEL POTENCIA SONORA GARANTIDA LwAav (dBA) (ISO 10884)	113	113
NIVEL POTENCIA SONORA MEDIDA LwAav (dBA) (ISO 10884)	112,57	112,57
NIVEL VIBRAÇÕES CABEÇA DE FIO (ISO 7916) (m/s ²) MAX-MIN	8,85 - 3,94	8,85 - 3,94
NIVEL VIBRAÇÕES LAMINA (ISO 7916) (m/s ²) MAX-MIN	12,4 - 3,94	12,4 - 3,94

GR ΤΕΧΝΙΚΑ ΣΤΟΙΧΕΙΑ

ΕΚΤΟΠΙΣΜΑ (εκμ. ³)	25	29
ΔΙΑΜΕΤΡΗΜΑ ΚΑΙ ΔΙΑΔΡΟΜΗ (χλστ.)	35x26	38x26
ΕΞΟΔΟΣ ΜΗΧΑΝΗΣ (kw)	0,7	0,8
ΤΑΧΥΤΗΤΑ ΜΗΧΑΝΗΣ ΣΕ ΜΕΓΙΣΤΗ ΙΣΧΥ (min ⁻¹)	7.500	7.500
ΜΕΓΙΣΤΗ ΤΑΧΥΤΗΤΑ ΧΩΡΙΣ ΦΟΡΤΙΟ (min ⁻¹)	9.500	9.500
ΕΛΑΧΙΣΤΗ ΤΑΧΥΤΗΤΑ (min ⁻¹)	2.800	2.800
ΤΑΧΥΤΗΤΑ ΑΞΟΝΑ ΛΕΠΙΔΑΣ (min ⁻¹)	7.300	7.300
ΡΟΠΗ ΣΤΡΕΨΕΩΣ ΑΣΦΑΛΙΣΤΙΚΟΥ ΠΑΞΙΜΑΔΙΟΥ ΛΕΠΙΔΑΣ (Nm)	17	17
ΞΗΡΟ ΒΑΡΟΣ (γγ.)	5,8	5,8
ΧΩΡΗΤΙΚΟΤΗΤΑ ΝΤΕΠΟΖΙΤΟΥ ΒΕΖΙΝΗΣ (εκμ. ³)	620	620
ΕΠΙΠΕΔΟ ΠΙΕΣΗΣ ΗΧΟΥ (ΣΤΟ ΑΥΤΙ ΤΟΥ ΧΕΙΡΙΣΤΗ) LpAav (dBA) (ISO 7917)	99	99
ΜΕΤΡΗΣΕΙΣ Α ΣΤΑΘΜΗ ΑΚΟΥΣΤΙΚΗΣ ΨΕΥΔΟΣ LwAav (dBA) (ISO 10884)	113	113
ΕΓΓΥΜΕΝΗ ΣΤΑΘΜΗ ΑΚΟΥΣΤΙΚΗΣ ΨΕΥΔΟΣ LwAav (dBA) (ISO 10884)	112,57	112,57
ΕΠΙΠΕΔΟ ΚΡΑΔΑΣΜΩΝ ΚΕΦΑΛΗΣ ΚΟΡΑΛΟΝΙΟΥ (ISO 7916) (m/s ²) MAX-MIN	8,85 - 3,94	8,85 - 3,94
ΕΠΙΠΕΔΟ ΚΡΑΔΑΣΜΩΝ ΛΕΠΙΔΑΣ (ISO 7916) (m/s ²) MAX-MIN	12,4 - 3,94	12,4 - 3,94

H TECHNIKAI ADATOK

HENGER ÜRTARTALOM (cm ³)	25	29
BELSO ÁTMÉRO JÁRAT	35x26	38x26
TELJESÍTMÉNY (Kw)	0,7	0,8
LEGNAGYOBB TELJESÍTMÉNYŰ ÜZEMELTETÉS (min-1)	7.500	7.500
LEGMAGASABB SEBESSÉG ÜRESJÁRATBAN (min-1)	9.500	9.500
MINIMUM SEBESSÉG (min-1)	2.800	2.800
PENGETENGYEL SEBESSÉG (min-1)	7.300	7.300
PENGEZÁRO CSAVAROK (Nm)	17	17
ÜRESSÜLY (Kg)	5,8	5,8
ÜZEMANYAG TARTALY BEFOGADÓ KÉPESSÉG (cm ³)	620	620
HANGERŐSSÉG (KEZELŐ FÜLÉRE HATÓ) LpAav (dBA) (ISO 7917)	99	99
GARANTÁLT HANGTELJESÍTMÉNYSZINT LwAav (dBA) (ISO 10884)	113	113
MÉRT HANGTELJESÍTMÉNYSZINT LwAav (dBA) (ISO 10884)	112,57	112,57
NYIROFÉJ REMEGÉSI SZINTJE (ISO 7916) (m/s ²) MAX-MIN	8,85 - 3,94	8,85 - 3,94
PENGE REMEGÉS SZINTJE (ISO 7916) (m/s ²) MAX-MIN	12,4 - 3,94	12,4 - 3,94

GB	Read operator's manual carefully	Wear safety clothing: 1 Approved safety glasses or face shield / 2 Approved safety helmet / 3 Approved ear defender / 4 Approved gloves / 5 Approved safety footwear					Do not smoke while re-fuelling or while operating the trimmer
I	Leggere attentamente questo manuale	Abbigliamento di sicurezza: 1 Occhiali di protezione o visiera protettiva approvati / 2 Casco protettivo omologato / 3 Paraorecchi di protezione / 4 Guanti approvati / 5 Stivali di sicurezza approvati					Non fumate durante il rifornimento e l'utilizzo
F	Lire attentivement ce manuel	Porter des vêtements de protection: 1 Lunettes ou visière de sécurité approuvés / 2 Casque de sécurité homologué / 3 Protecteur de ouïe approuvé / 4 Gants approuvés / 5 Chaussures de sécurité					Ne pas fumer pendant le remplissage et pendant l'utilisation
D	Lesen Sie das Handbuch aufmerksam durch	Schutzkleidung: 1 Zugelassene Schutzbrille oder Gesichtsschutz / 2 Zugelassener Schutzhelm / 3 Zugelassener Gehörschutz / 4 Zugelassene Arbeitshandschuhe / 5 Zugelassene Sicherheitsschuhe					Rauchen Sie weder beim Auftanken noch bei der Arbeit
E	Lea cuidadosamente el manual de instrucciones	Llevar ropa de seguridad: 1 Gafas de protección o visera de protección aprobadas / 2 Casco de seguridad homologado / 3 Protectores de oídos homologados / 4 Guantes aprobados / 5 Botas de seguridad homologadas					No fume mientras reposta combustible o mientras que utiliza el desbrozador
NL	Gebruiksaanwijzing zorgvuldig lezen	Veiligheidskleding: 1 Goedgekeurde veiligheidsbril of gezichtsbeschermer / 2 Gekeurde veiligheidshelm / 3 Gekeurde oor beschermers / 4 Gekeurde handschoenen / 5 Geleude veiligheidschoenen					Bij het werken met de machine en het vullen van de tank niet roken
S	Läs bruksanvisningen noggrant	Använd skyddskläder: 1 Skyddsglasögon eller godkänd skyddsvisar / 2 Godkänd skyddshjälm / 3 Godkända öronskydd / 4 Godkända handskar / 5 Godkända skyddsstövlar					Räkning förbjuden under påfyllning och under användning
DK	Læs brugsanvisningen omhyggeligt	Ifør dem sikkerhedsbeklædning: 1 Godkendte sikkerhedsbriller eller visir / 2 Godkendt sikkerhedshjelm / 3 Godkendte hørevern / 4 Godkendte handsker / 5 Godkendt sikkerhedsstøvler					Ryg ikke under påfyldning af benzin eller når maskinen betjenes
FIN	Lue tämä ohjekirjanen huolellisesti	Puo päällesi turvavaatteet 1 hyväksytyt suojalasit tai kasvosuojus / 2 hyväksytyt turvakypärät / 3 hyväksytyt kuulonsuojain / 4 hyväksytyt käsineet / 5 hyväksytyt turvakangot					Älä tupakoi laittaessasi polttoainetta tai koneen käytön aikana
N	Les nøyed denne manual	Bruk beskyttelsesklær: 1 Bruk godkjente beskyttelsesbriller eller ansiktsskjerm / 2 Godkjent beskytteshjelm / 3 Godkjent hørselsvern / 4 Godkjente handsker / 5 Godkjente beskyttelsesstøvler					Røking forbudt ved fylling av benzin og under bruk.
P	Ler atentamente este manual	Vestuario de segurança: 1 Oculos de proteção ou viseira protetora aprovados / 2 Capacete protetor homologado / 3 Pára-orelhas de proteção aprovadas / 4 Luvas aprovadas / 5 Botas de segurança aprovadas					Não fumar durante o abastecimento e durante a utilização
GR	Διαβάστε τις οδηγίες προσεκτικά	Φοράτε προστατευτικά ρούχα: 1 Εγκριμένα προστατευτικά γυαλιά ή ασπίδα προσώπου / 2 Εγκριμένο προστατευτικό κράνος / 3 Εγκριμένες αυτοακουστικές / 4 Εγκριμένα γάντια / 5 Εγκριμένη προστατευτική υποδήση					Μην καπνίζετε όταν βάζετε καύσιμο ή όταν χρησιμοποιείτε το εργαλείο
H	A használati utasítást kérjük figyelmen elolvani	Balesetvédelmi felszerelés: 1) védőszemüveg, vagy előírt védőmaszk 2) előírt védősisak 3) fülvédő 4) előírt kesztyű 5) előírt védőcsizma					Tilos tankolás közben dohányozni

GB	Do not use metal blades	Maximum blade speed	Warning Caution	Blade thrust	Beware of projected objects	Maximum safety distance	Choke fully opened (hot start / run)	Choke closed (cold start)
I	Non usare lame metalliche	Velocità massima della lama	Avvertimento Attenzione	Attenzione reazione della lama	Attenzione al materiale proiettato	Distanza di sicurezza	Farfalla aria aperta (Avviamento a caldo)	Farfalla aria chiusa (Avviamento a freddo)
F	Ne pas utiliser de lames métalliques	Plein régime de la lame	Attention	Attention aux réactions de la lame	Attention aux projections	Distance minimum de sécurité	Lever starter ouvert, marche (démarrage à chaud)	Lever starter fermé (démarrage à froid)
D	Keine Metallschlagblätter verwenden	Zulässige Drehzahl des Schalblattes	Achtung Vorsicht	Auf den Rückstoß des Schlagblattes achten	Auf hochgeschleuderte Gegenstände achten	Sicherheitsabstand	Luftklappe offen (Starten bei warmem Motor)	Luftklappe geschlossen (Starten bei kaltem Motor)
E	No utilize cuchillas metálicas	Velocidad máxima de la cuchilla	Advertencia Precaución	Cuidado con la reacción de la cuchilla	Tenga cuidado con los objetos proyectados	Distancia mínima de seguridad	Estrangulador totalmente abierto (Arranque en caliente)	Estrangulador cerrado (Arranque en frío)
NL	Gebruik geen metalen maabladen	Maximum toerental maablad	Waarschuwing Lep op	Pas op voor terugslag van het maablad	Pas op voor uitstekende voorwerpen	Minimale veiligheidsafstand	Chokeklep geopend (Het starten van een warme motor)	Chokeklep gesloten (Het starten van een koude motor)
S	Använd inte metallkliga	Klingans högsta hastighet	Upplysning Varning	Uppmärksamma klingans reaktion	Se upp för ivägslungade föremål	Säkert avstånd	Choken helt öppen (start med varm motor)	Choken stängd (start med kall motor)
DK	Ålå käytä metalliteriä	Terän maksiminopeus	Varoitus Huomio	Varo terän reaktiota	Varo sinkoavia materiaaleja	Turvetaäisyyt	Imaläppä täysin auki (Lämpimän moottorin käynnisty)	Imaläppä kiinni (Kylmän moottorin käynnisty)
FIN	Brug ikke metal knive	Max. kniv hastighed	Advarsel	Kniv reaktion	Pas på tilbagekastede genstande	Minimum sikkerheds afstand	Choker helt åben (Start af varm motor)	Choker lukket (Start af kald motor)
N	Ikke bruk metallblad	Maksimumshastigheten av bladet	Advarsel "Vær Forsiktig"	Pass opp for reaksjonen av bladet	Pass opp for sprutende materiale	Sikkerhetsavstand	Choken er åpen (Start av varm motor)	Choken er helt stengt (Start av kald motor)
P	Não utilize lâminas metálicas	Velocidade máxima da lâmina	Atenção	Atenção as reacções da lâmina	Atenção ao material projetado	Distancia de segurança	Alavanca do starter aberto (Arranque a quente)	Alavanca do starter fechada (Arranque a frio)
GR	Μη χρησιμοποιείτε μεταλλικές λεπίδες	Μέγιστη ταχύτητα λεπίδας	Προειδοποίηση Κίνδυνος	Προσοχή ισχύος λεπίδας	Προσεξτε από προεξέχοντα αντικείμενα	Μέγιστη απόσταση ασφαλείας	Τροκ πλήρως ανοικτό (θερμό εκκίνηση/λειτουργία)	Τροκ κλειστό (ψυχρή εκκίνηση)
H	Fémpengék használata tilos	Pengék maximális sebessége	Figyelmeztetés figyeljen	Figyelem a pengék reakciójára	Figyelem az idegen anyagok kilövelésére	Biztonsági távolság	Nyitott folytószelep (meleg motor esetén)	Zárt folytószelep (hideg motor esetén)

- GB** Due to a constant product improvement programme, the factory reserves the right to modify technical details mentioned in this manual without prior notice.
- I** La casa produttrice si riserva la possibilità di variare caratteristiche e dati del presente manuale in qualunque momento e senza preavviso.
- F** La Maison se réserve la possibilité de changer des caractéristiques et des données de ce manuel à n'importe quel moment et sans préavis.
- D** Im Sinne des Fortschritts behält sich der Hersteller das Recht vor, technische Änderungen ohne vorherigen Hinweis durchzuführen.
- E** La firma productora se reserva la posibilidad de cambiar las características y datos del presente manual en cualquier momento y sin previo aviso.
- NL** Door konstante produkt ontwikkeling behoud de fabrikant zich het recht voor om technische specificaties zoals vermeld in deze handleiding te veranderen zonder hiervan vooraf bericht te geven.
- S** Tilverkaren reserverar sig rätten att ändra fakta och uppgifter ur handboken utan förvarning.
- DK** Producenten forbeholder sig ret til ændringer, hvad angår karakteristika og data i nærværende instruktion, når som helst og uden varsel.
- FIN** Jatkuvan tuotteen parannusohjelman tähden valmistaja pidättää oikeuden vaihtaa ilman ennakkovaroitusta tässä ohjekirjasessa mainittuja teknisiä yksityiskohtia.
- N** Produsenten forbeholder seg all rett og mulighet til å forandre tekniske detaljer i denne manualen uten forhåndsvarsel.
- P** A casa productora se reserva a possibilidade de variar características e dados do presente manual em qualquer momento e sem aviso prévio.
- GR** Λόγω προγράμματος συνεχούς βελτίωσης προϊόντων, το εργοστάσιο επιφυλάσσεται του δικαιώματος να τροποποιεί τις τεχνικές λεπτομέρειες που αναφέρονται στο εγχειρίδιο αυτό χωρίς προηγούμενη ειδοποίηση.
- H** A gyártó cég fenntartja a jogot arra, hogy a használati utasításban megadott adatokon és technikai tulajdonságokon bármikor és előzetes bejelentés nélkül változtasson.

A. GENERAL DESCRIPTION

- | | |
|-------------------------|------------------------------|
| 1) ENGINE | 12) SPARK PLUG |
| 2) SHAFT | 13) AIR FILTER COVER |
| 3) THROTTLE TRIGGER | 14) FUEL TANK CAP |
| 4) THROTTLE ADVANCE | 15) MUFFLER SHIELD |
| 5) RIGHT CONTROL HANDLE | 16) ENGINE SHAFT JOINT |
| 6) BLADE | 17) FRONT HANDLE |
| 7) NYLON STRING HEAD | 18) REAR CONTROL GRIP |
| 8) STOP SWITCH | 19) SAFETY GUARD |
| 9) CHOKE LEVER | 20) STRING HEAD SAFETY GUARD |
| 10) STARTER HANDLE | 21) LINE CUTTER BLADE |
| 11) HARNESS RING | |

B. SAFETY RULES

- 1) Make sure all operators study this manual carefully before using the trimmer; only use this machine for usage specifically mentioned in this manual.
Never allow children to use the trimmer.
- 2) When working with the trimmer wear suitable clothes: a) Close fitting protective clothes (do not wear short trousers or loose clothes). b) Safety shoes (do not wear sandals and do not work barefoot). c) Heavy-duty gloves. d) Safety face shield or goggles. Ensure you peel off the protective films, if existing, from the see - through plastic. e) Ear protection. f) Head protection when using circular saw blades. Make sure you know how to stop the engine in an emergency (see the section STARTING AND STOPPING ENGINE). Never use the trimmer when tired, physically indisposed or under the effect of alcohol, certain medicines or other drugs. Be careful of the rotating cutting attachment and hot surfaces on the unit.
- 3) Prolonged use of this product or other machines exposing the operator to vibration may produce Whitefinger's disease (Raynaud's Phenomenon). This may reduce the hands' ability to feel and regulate temperature and may produce general numbness. Continual or regular users should therefore monitor closely the condition of their hands or fingers. If any of the symptoms appear, seek immediate medical advice. Always hold the trimmer firmly with both hands. When working maintain a firm foothold. The trimmer must be used exclusively as recommended (see section SAFETY USAGE).
- 4) Do not carry the trimmer while the engine is running even for short distances; switch off the engine and carry the unit with the cutting head behind you. When carrying the trimmer in a vehicle, secure it to avoid fuel leakage. Always empty the fuel tank before transporting the unit.
ATTENTION: For your safety the blade must be kept at all times in its proper case during transport and storage. Start the trimmer on a flat surface. When starting the unit, ensure you have a firm footing. Make sure the blade or the nylon string head does not touch the ground or any obstacle.
- 5) **PRECAUTIONS AGAINST FIRE:** do not operate the trimmer near fire or spilled petrol. Do not run the engine in closed or poorly ventilated areas. **EXHAUST GASES ARE POISONOUS WHEN INHALED, THEY CAN CAUSE SUFFOCATION AND DEATH.**
After refuelling always wipe off any spilled fuel. Do not smoke during this operation. Start the engine far away from the refuelling area and from fuel containers (minimum distance 3 meters). Do not refuel while the engine is still running.
- 6) Keep people and animals away from working area (minimum distance 15 meters). If somebody should approach you, turn the engine off and stop the blade or the rotating head (see chapter STARTING AND STOPPING THE ENGINE) as during operation the blade or the nylon string head might project grass, grit, or other debris. The blade is sharp, be careful even if handling it when the engine is off.
Wear heavy-duty gloves. Turn the engine off and wait for rotating parts to stop completely before working on the machine or before touching the blade or the string head above all to remove possible entangled material.
DO NOT USE THE TRIMMER AT ALL IF THE SPECIFIED SAFETY GUARD IS NOT FIRMLY ATTACHED (see sections SAFETY USAGE and BLADES AND NYLON STRING HEAD ASSEMBLY).
Pay careful attention to safety recommendations as you might put your life or somebody else's in danger as a result of: a) possible contact with cutting or rotating parts. b) possibility of projection of various objects.
WARNING: do not start engine if it is not attached to the shaft as the clutch might disintegrate. For units equipped with a clutch, be sure the cutting attachment stops turning when the engine idles.

This product must be held to the right of the operator's body.

This will ensure exhaust fumes are directed away from the operator and will not be obstructed by the operator's clothing. If you have not used a trimmer before, spend some time in becoming familiar with the controls and method of usage before operation.

Check the machine carefully before using it. Make sure that there are no loosened screws, damaged parts or fuel leakages.

Replace damaged or excessively worn accessories (blades, string heads, guards).

Ensure all maintenance or repair work is carried out by an authorised service center.

N.B. In order to maintain performance and safety, be sure to use original spare parts and accessories.

Avoid using the trimmer over excessively long periods of time.

Excessive amounts of vibration can be harmful.

1) Remove from the working area grit, debris, ropes, metal parts or any other object which might get entangled around the rotating parts or be dangerously projected.

Use only the correct accessory recommended for the type of vegetation to be cut. Do not let the rotating blade contact any foreign object such as stones, rocks, cans etc.

Secure hair to keep it above shoulder height. Before starting to work fit the harness. Adjust harness with the buckle so that the trimmer is well balanced on your right side and the blade or string head is parallel to the ground. Always maintain a firm foothold and a good balance while using the machine. Do not move backwards while you work as obstacles may not be visible.

The fitting of the safety pole barrier is obligatory on units equipped with a delta shaped handle when used with a metal blade.

The purpose of this safety pole barrier is to maintain a safe distance between the metal blade and the user under all normal or exceptional circumstances.

2) Harness ring (B) must never be moved from its original position to avoid unbalancing the unit.

Front handles can be separately adjusted to make usage easier on units fitted with "U" shaped handles.

3) The following accessories can be assembled to your trimmer: a) blade, b) nylon string head.

Do not attach any blade to a unit without proper installation of all required parts. Failure to use the proper parts can cause the blade to fly off and seriously injure the operator and/or bystanders.

a) WHEN USING A BLADE ENSURE THE CORRECT GUARD IS FITTED.

b) WHEN USING A NYLON STRING HEAD ENSURE THE CORRECT GUARD IS FITTED.

When using the unit always hold the front part of the machine (blade or nylon string head) below your waist.

NYLON STRING HEAD:

Always make sure it has been correctly assembled and fitted.

The nylon head is suitable to cut grass and weeds wherever there might be obstacles like trees, fences or walls.

The nylon string head also reduces the likelihood of damaging small plants and trees bark.

Only use flexible, nonfilament nylon line in the nylon line head as specified by the manufacturer. Never use metallic line which could break off and become a dangerous projectile.

BLADE:

Always make sure it has been correctly fitted.

When fitting or changing a cutting device, ensure you follow the instructions in the section "Blade or nylon string head assembly" with extreme precision. Fit these cutting devices using all and only the parts as described, and in the correct order.

4) **BLADES:** you can cut any type of grass, brushwood or shrub.

Operate the machine like a sickle always cutting at full throttle.

WARNING: always use a well sharpened blade.

A blade with worn teeth besides providing poor performance might also generate a sudden thrust. This can result in a violent sideways kick caused when the blade touches against wood or solid bodies, such thrust might then cause the operator to loose control of the machine itself. Never attempt to work with a damaged blade but replace it with a new one.

THRUST: can occur when using any type of circular blade within the risk area: therefore it is advisable to cut using the remaining area of the blade.

ALWAYS USE GENUINE ACCESSORIES AND SPARE PARTS AVAILABLE FROM AUTHORISED SERVICING DEALERS. THE USE OF NON-ORIGINAL ACCESSORIES AND SPARE PARTS INCREASES THE RISK OF ACCIDENTS AND IN SUCH A CASE THE COMPANY IS NOT LIABLE FOR DAMAGE TO PEOPLE AND/OR THINGS.

D. FUEL MIX

Use only fuel recommended by this manual.

This product is fitted with a 2-stroke engine and therefore requires a 2-stroke petrol and oil mix. Use leaded (4 Star) or unleaded petrol with a minimum octane rating of 90.

Only use oil from sealed containers. In order to obtain a good fuel mix, put the oil into the container before the petrol.

The use of sub-standard petrol or oil may reduce performance or reduce the life of certain components.

Leaded Petrol

If using leaded petrol, the correct fuel mix is achieved by either using 5% (20:1) of a well known brand of 2-stroke engine oil, or else 2.5% (40:1) of special engine oil.

Unleaded Petrol

If using unleaded petrol, you must use a **totally synthetic** 2-stroke engine oil or branded 2-stroke engine oil. In either case use 2.5% (40:1) of oil.

IMPORTANT

Always shake the fuel mix container thoroughly before pouring any fuel mix.

Fuel mix properties may deteriorate with time and should be used up within 2 months.

We recommend that you prepare fuel mix according to your immediate requirements only. Never use fuel mix more than 2 months old so as to avoid possible engine damage.

WARNING

Do not smoke when re-fuelling.

Always open the fuel cap slowly, to release any pressure build up in the tank.

Re-fuel in open spaces only, keeping away from naked flames or sparks.

Safe Storage of Fuel

Petrol fuel mix is highly inflammable. Put out all cigarettes, pipes and cigars before working with fuel. Avoid spilling fuel.

Store fuel in a cool, well ventilated place, in an approved container specifically designed for the purpose. Never store engine with fuel in the tank in enclosed, poorly ventilated areas, where fuel fumes may reach an open flame, spark or pilot light such as in a furnace, water heater, clothes dryer etc.

Petrol fumes can cause an explosion or a fire.

Never store large amounts of fuel.

To prevent possible restarting problems avoid running the fuel tank dry. This also helps to extend engine life.

E. SAFETY GUARD ASSEMBLY

1,2) In the interest of safety, it is imperative that the unit is used with the correct guard (P/N 242043) when using any blade or a nylon string head.

Line cutter blade (L): assemble as illustrated.

A double shoulder harness must also be worn.

Only use blades or nylon string heads clearly marked with a maximum speed of at least 10,500 min⁻¹.

Follow the fitting instructions carefully.

F. BLADE AND NYLON STRING HEAD ASSEMBLY

Assemble the correct guard to suit the kind of blade or nylon string head to be used (See section: SAFETY GUARD ASSEMBLY).

1) Assemble blade as illustrated:

- a) Flange guard - b) Upper cap with blade centering - c) Blade with text and directional arrow facing upwards - d) Lower washer - e) Fixed mower gauge - f) Blade locking screw.

2) Make sure that the blade bore opening fits perfectly around the centering collar on the upper cap.

Tighten counterclockwise.

While tightening, the blade assembly can be held fast by inserting the wrench or the screwdriver supplied into the cap and

gearcase holes.

To do this, rotate the cap until the two holes coincide.

3) Assemble nylon string head as illustrated:

- a) Flange guard - b) Upper cap - c) Guard d) Nylon string head

Tighten counterclockwise.

4) While tightening, the head assembly can be held fast by inserting the wrench or the screwdriver supplied into the holes as already shown for blade assembly.

WARNING: Please do not use the accessory nylon string head guard (item C Fig. 3 F) together with metal blades.

G. ENGINE/SHAFT ASSEMBLY

GB

DANGER. Do not run engine without shaft attached as clutch could fly off.

- 1) Insert the shaft (A) into the engine joint (B) making the female squared end (C) inside the joint mates with the male squared end (D) of the shaft.
Rotate the shaft from right to left to obtain a precise fit. Now tighten the locking bolt (E) clockwise to ensure the shaft is held firmly in the joint.
- 2) If the joint is not tightened onto the engine housing, first make sure the shaft is fully and correctly engaged up to the shank, then tighten the 4 screws (A) in a criss-cross sequence.

- 3) Assemble the eyelet (A) of the ground wire onto the end of the throttle cable and install the washer (B).
Insert the throttle cable into the cable mount (C), install the second washer (B) and insert the hexagonal nut.
- 4) Fit the end of the trigger cable connector (B) into the slot on swivel (C).
- 5) Adjust the nut (D) of the trigger cable connector so that the cable can easily slide in the opening with a play of 1 mm before operating the swivel (C).
Tighten now the hexagonal nut (E).
- 6) Stop switch (STOP) cable: fit the connection.

H. HANDLE ASSEMBLY



- 1) **DOUBLE HANDLE**
Adjust and secure double handle clamp 40 cm from engine/shaft joint by tightening the screws (C).
- 2) **DELTA FRONT HANDLE**
Secure the handle in front of the label placed on the shaft 11 cm from the rear grip when assembling nylon string head and 36 cm

when assembling metallic blades. This position ensures optimum balance and safety. The handle must be perpendicular to the shaft as illustrated (Fig.2). The handle bar must be mounted using all the items supplied and in the exact configuration shown in figures 1 or 2.

I. STARTING AND STOPPING THE ENGINE

WARNING. First read sections: SAFETY RULES, SAFETY USAGE and SYMBOLS.

COLD ENGINE STARTING

- 1) Move stop switch to the "ON" position.
- 2) Depress the safety lever (S), squeeze the accelerator trigger (A) and push the throttle advance forwards (B). Now release the accelerator trigger (A) and then the throttle advance (B).
WARNING: when the throttle advance is engaged, the head or blade rotates.
- 3) Move choke lever (E) to the closed position .
- 4) Press the primer bulb (C) several times until you see fuel going back to carburetor through pipe (D). Pull starter rope until engine fires once.
- 5) Move choke lever (E) to the open position  then pull starter rope until engine fires. Let engine run for a few seconds holding the trimmer. Now disengage throttle advance by pulling trigger completely. Engine will now keep on running at idle speed.

HOT ENGINE STARTING

STOP switch on START position I. Trigger on idle position (released).

Choke towards (open position ). Press the primer bulb (C) several times until you see fuel going back to carburetor through pipe (D). Pull starter rope.

WARNING: when the throttle (B) advance is engaged, the head or blade rotates.

6) ENGINE STOPPING

Press the stop switch moving it to STOP position 0.

WARNING: when the engine is switched off rotating parts, blade or nylon string head, will keep on rotating for a few seconds. Hold the machine until all parts come to a standstill.

N.B. In an emergency the above mentioned delay in stopping may be shortened by touching blade parallel on the ground.

L. CARBURETTOR ADJUSTMENT

Your machine may be fitted with a highly sensitive low emission carburettor. We now therefore recommend that carburettor adjustments are only made by an authorised servicing dealer, equipped with instruments that will ensure best performance with lowest emission levels.

To adjust the idle speed, however, proceed as follows:

With engine running and warm, slowly turn screw 'I' or 'T' clockwise until the engine runs smoothly with a consistent noise level but without making the chain or cutting head rotate.

If the cutting attachment does move or the engine runs too fast, slowly turn screw 'I' or 'T' in an

anticlockwise direction until the correct speed is obtained.

Precise numerical engine speed settings are mentioned in the technical detail chart in the front of the owner's manual.

NOTE:

A) Direct drive trimmers: The cutting head will always rotate when engine is running.

B) All the above mentioned adjustments must be made with the relevant cutting attachment correctly fitted.

Warranty may be invalidated from incorrect carburettor adjustment made by persons other than an authorised dealer.

M. REGULAR MAINTENANCE

From time to time ensure all screws are tight. Replace damaged, worn, cracked or warped blades. Always make sure nylon string head or blade have been assembled correctly (see sections NYLON STRING HEAD and BLADE ASSEMBLY) and blade fastener is tightened.

1) AIR FILTER CLEANING

(at least every 25 working hours).

A dust clogged air filter may cause carburetor problems.

This may prevent the engine from reaching its maximum speed and cause high fuel consumption and/or difficult starting.

Remove filter cover as shown in figure 1. Carefully clean the inside of filter box. The filter can also be cleaned with compressed air.

2) Every 50 working hours inject the gearcase with gear grease under high pressure through hole (C).

3) SPARK PLUG

From time to time (at least every 50 hours) remove and clean the spark plug and check

the electrode gap (0,5/0,6 mm.). Replace spark plug about every 100 working hours or whenever it is extremely encrusted. Heavily encrusted electrodes can result from an incorrect carburetor setting or from wrong fuel mixture (too much oil in the petrol) or a poor quality of oil in the fuel mix. Check and correct.

4) FUEL FILTER

To change fuel filter remove the tank cap and pull out the filter with a piece of bent wire or long forceps. Contact your Service Station for general servicing and cleaning of internal parts at least once a year. This will reduce the possibility of unexpected problems and will ensure maximum product life and efficiency.

REGULARLY: it is important, in order to avoid engine overheating, to remove dust and dirt from slots, gaps and from in between cylinder fins using a wooden scraper.

LONG STORAGE: empty fuel tank and run engine until dry.

Store trimmer in a dry place.

N. REPLACING NYLON LINE

1) Unscrew the blocking screws at the bottom of the string head by turning them counter-clockwise.

2) Remove the base cover assembly.

Remove the empty spool from the housing and discard any remaining line.

REWINDING NEW LINE

3) Prepare 2 lengths (8ft each) of 2.4 mm nylon line. Thread 1 end of each line into the two holes on opposite sides of the spool. Pinch the exposed ends flat with a pair of pliers to prevent them slipping through the hole.

4) Wind the two lines in the same direction around the spool.

REASSEMBLY

5) Slide the end of the two lines into the grooves to hold the line temporarily.

6) Position the spool back into the housing and pull the line through the eyelets.

7) Pull about 12cm (5ins) of line out on either side.

8) Reassemble the string head as shown, tighten the screws clockwise.

9) N.B: In order to extend the nylon line as it wears down, pull the mower gauge downwards and turn it in a clockwise direction to feed out the desired length of line.

FAULT FINDING TABLE

	Engine will not start	Engine runs badly or loses power when cutting	The machine runs but does not cut well
Check STOP switch is in the position I.	●		
Control fuel level min. 25% tank capacity.	●	●	
Check air filter is clean.	●	●	
Remove spark plug, dry it, clean it and adjust it, and replace it, if necessary.	●	●	
Control and adjust the carburetor screws if necessary.		●	
Change fuel filter. Contact your dealer.		●	
Carefully follow the cutting accessory assembly instructions.			●
Check metal cutting accessory is sharp. Otherwise, contact your dealer.			●

Engine still gives trouble: contact your dealer.