

HP TouchSmart User Guide

© Copyright 2010 Hewlett-Packard
Development Company, L.P.

Microsoft and Windows are U.S. registered trademarks of Microsoft Corporation. Bluetooth is a trademark owned by its proprietor and used by Hewlett-Packard Company under license. SD Logo is a trademark of its proprietor.

The information contained herein is subject to change without notice. The only warranties for HP products and services are set forth in the express warranty statements accompanying such products and services. Nothing herein should be construed as constituting an additional warranty. HP shall not be liable for technical or editorial errors or omissions contained herein.

First Edition: January 2010

Document Part Number: 582064-001

Product notice

This user guide describes features that are common to most models. Some features may not be available on your computer.

Safety warning notice

-
- ⚠ **WARNING!** To reduce the possibility of heat-related injuries or of overheating the computer, do not place the computer directly on your lap or obstruct the computer air vents. Use the computer only on a hard, flat surface. Do not allow another hard surface, such as an adjoining optional printer, or a soft surface, such as pillows or rugs or clothing, to block airflow. Also, do not allow the AC adapter to contact the skin or a soft surface, such as pillows or rugs or clothing, during operation. The computer and the AC adapter comply with the user-accessible surface temperature limits defined by the International Standard for Safety of Information Technology Equipment (IEC 60950).
-

Table of contents

1 Features

Identifying the installed hardware and software	2
Identifying hardware	2
Identifying software	2
Components	3
Top components	3
TouchPad	3
Lights	4
Keys	5
Front components	5
Right-side components	6
Left-side components	7
Display components	8
Rear components	9
Bottom components	10

2 Networking

Choosing an ISP	12
Using Internet Services & Offers	12
Using ISP-provided icons	12
Using the Windows Connect to the Internet Wizard	13
Creating a wireless connection	14
Identifying wireless icons and controls	14
Identifying wireless and network status icons	14
Using the wireless key and button	15
Using Wireless Assistant software	15
Using operating system controls	16
Connecting to a WLAN	16
Connecting to an existing wireless network	17
Setting up a wireless network	17
Step 1: Purchase high-speed Internet service	18
Step 2: Purchase and install a wireless router	18
Step 3: Configure the computer to connect to the wireless network	18

Protecting your WLAN	19
Roaming to another network	19
Using HP Mobile Broadband (select models only)	20
Inserting a SIM	20
Removing a SIM	21
Using Bluetooth wireless devices	22
Bluetooth and Internet Connection Sharing (ICS)	22
Connecting to a wired network	23

3 Pointing devices, touch screen, and keyboard

Using pointing devices	25
Setting pointing device preferences	25
Using the TouchPad	25
Turning the TouchPad on and off	25
Using TouchPad gestures	26
Scrolling	26
Pinching/Zooming	27
Rotating	27
Using the digitizer pen	29
Identifying the pen components	29
Holding the pen	29
Storing the pen	29
Using the touch screen	30
Rotating the display	30
Using the rotate button	31
Using touch screen gestures	31
Tapping (or clicking)	31
Flicking	32
Dragging	32
Scrolling	32
Rotating	33
Pinching	33
Setting touch screen preferences	34
Using the action keys	35
Using the hotkeys	37

4 Multimedia

Multimedia features	39
Using the media activity keys	40
Multimedia software	41
Using HP TouchSmart software or HP MediaSmart software	41
Using multimedia software	41
Installing multimedia software from a disc	42

Audio	43
Adjusting the volume	43
Connecting external audio devices	43
Webcam	45
Adjusting webcam properties	46
Video	47
Using the external monitor port	47
Connecting an HDMI device	47
Configuring audio for HDMI	48

5 Power management

Shutting down the computer	50
Setting power devices	51
Using power-saving states	51
Initiating and exiting Sleep	51
Initiating and exiting Hibernation	51
Conserving power	52
Using the battery meter	52
Using power plans	53
Viewing the current power plan	53
Selecting a different power plan	53
Customizing power plans	53
Setting password protection on wakeup	53
Using battery power	54
Finding battery information in Help and Support	54
Using Battery Check	54
Displaying the remaining battery charge	55
Removing or inserting the battery	55
Charging a battery	56
Maximizing battery discharge time	57
Managing low battery levels	57
Identifying low battery levels	57
Resolving a low battery level	58
Resolving a low battery level when external power is available	58
Resolving a low battery level when a charged battery is available	58
Resolving a low battery level when no power source is available	58
Resolving a low battery level when the computer cannot exit Hibernation	58
Calibrating a battery	58
Storing a battery	58
Disposing of a used battery	59
Replacing the battery	59

Switching between graphics modes (select models only)	60
Using external AC power	61
Connecting AC power	61
Testing an AC adapter	62

6 External devices

Using Digital Media Slot cards	64
Inserting a digital card	64
Removing a digital card	65
Using a USB device	66
Connecting a USB device	66
Removing a USB device	66

7 Drives

Handling drives	69
Improving hard drive performance	70
Using Disk Defragmenter	70
Using Disk Cleanup	70
Using HP ProtectSmart Hard Drive Protection	71
Identifying HP ProtectSmart Hard Drive Protection status	71
Managing power with a parked hard drive	71
Using HP ProtectSmart Hard Drive Protection software	72
Replacing a hard drive	73
Using external drives	77
Connecting optional external drives	77
Using an external optical drive (select models only)	77
Removing an optical disc when the disc tray will not open	77
Sharing an optical drive	79

8 Memory modules

Adding or replacing memory modules	81
--	----

9 Security

Protecting the computer	85
Using passwords	86
Setting passwords in Windows	86
Setting passwords in Setup Utility	86
Administrator password	87
Managing an administrator password	87
Entering an administrator password	88
Power-on password	88
Managing a power-on password	88
Entering a power-on password	88

Using antivirus software	89
Using firewall software	90
Installing critical security updates	91
Installing an optional security cable	92
Using the fingerprint reader (select models only)	93
Registering fingerprints	93
Using your registered fingerprint to log on to Windows	94

10 Backup and recovery

Creating recovery discs	96
Backing up your information	97
Using Windows Backup and Restore	97
Using system restore points	98
When to create restore points	98
Create a system restore point	98
Restore to a previous date and time	98
Performing a recovery	99
Recovering from the recovery discs	99
Recovering from the dedicated recovery partition (select models only)	99

11 Setup Utility (BIOS)

Starting Setup Utility	101
Using Setup Utility	102
Changing the language of Setup Utility	102
Navigating and selecting in Setup Utility	102
Displaying system information	103
Restoring default settings in Setup Utility	103
Exiting Setup Utility	103
Setup Utility menus	105
Main menu	105
Security menu	105
System Configuration menu	105
Diagnostics menu	106
Updating the BIOS	107
Determining the BIOS version	107
Downloading a BIOS update	107

Appendix A Product information

Input power	110
Operating environment	111
Traveling with the computer	112
Routine care	113
Cleaning the display	113

Cleaning the TouchPad and keyboard	113
Labels	114
Index	115

1 Features

Identifying the installed hardware and software

Identifying hardware

To see a list of hardware installed in the computer:

- ▲ Select **Start > Control Panel > System and Security**. Then in the **System** area, click **Device Manager**.

You can also add hardware or modify device configurations using Device Manager.

 **NOTE:** Windows® includes the User Account Control feature to improve the security of your computer. You may be prompted for your permission or password for tasks such as installing applications, running utilities, or changing Windows settings. Refer to Help and Support for more information.

Identifying software

To see a list of the software installed on the computer:

- ▲ Select **Start > All Programs**.

Components

Top components

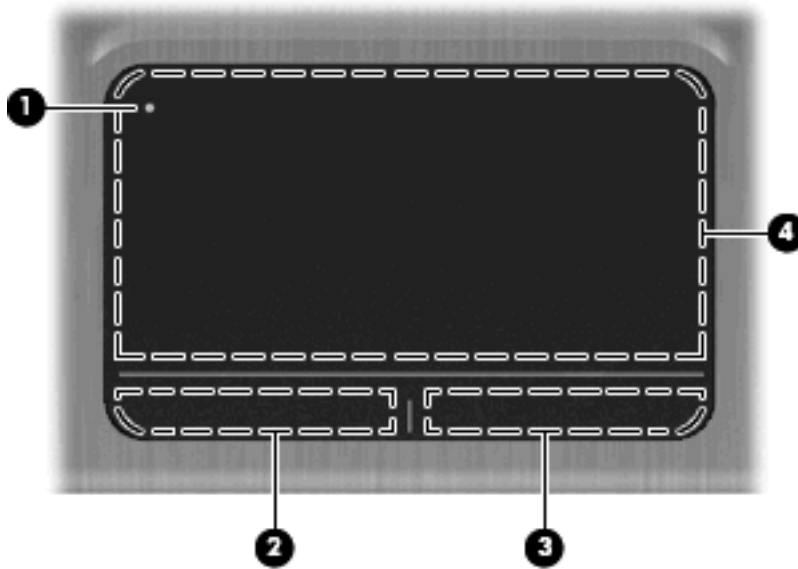

TouchPad



Component	Description
(1)  TouchPad off indicator	To turn the TouchPad zone on and off, quickly double-tap the TouchPad off indicator. NOTE: When the TouchPad zone is active, the light is off.
(2) Left TouchPad button	Functions like the left button on an external mouse.
(3) Right TouchPad button	Functions like the right button on an external mouse.
(4) TouchPad zone	Moves the pointer and selects or activates items on the screen.





Lights

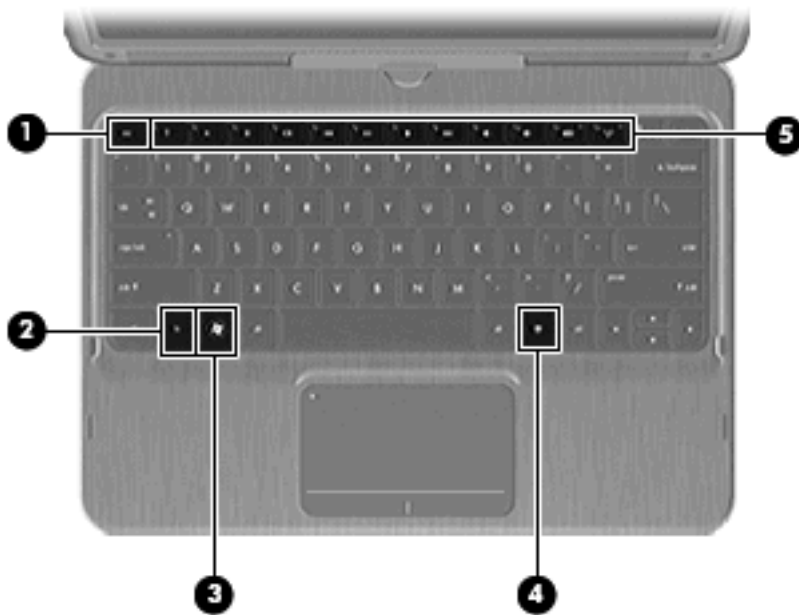

Component	Description
(1) Caps lock light	White: Caps lock is on.
(2)  Mute light	Amber: Computer sound is off.
(3)  Wireless light	<ul style="list-style-type: none">White: An integrated wireless device, such as a wireless local area network (WLAN) device and/or a Bluetooth® device, is on. <p>NOTE: Wireless devices are enabled at the factory.</p> <ul style="list-style-type: none">Amber: All wireless devices are off.
(4)  TouchPad off indicator	<ul style="list-style-type: none">Amber: The TouchPad is off.Off: The TouchPad is on.

Keys



Component	Description
(1)  esc key	Displays system information when pressed in combination with the fn key.
(2)  fn key	Executes frequently used system functions when pressed in combination with an arrow key or the esc key.
(3)  Windows logo key	Displays the Windows Start menu.
(4)  Windows applications key	Displays a shortcut menu for items beneath the cursor.
(5)  Action keys	Execute frequently used system functions.



Front components



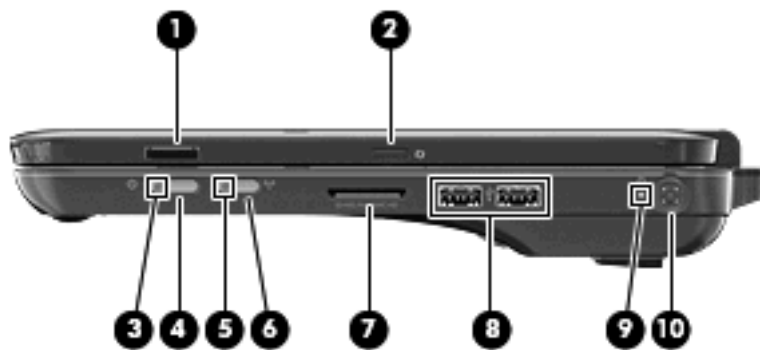

Component	Description
(1) Vent	<p>Enables airflow to cool internal components.</p> <p>NOTE: The computer fan starts up automatically to cool internal components and prevent overheating. It is normal for the internal fan to cycle on and off during routine operation.</p>
(2) External WWAN antenna	<p>Sends and receives wireless signals to communicate with wireless wide area networks (WWAN).</p> <p>NOTE: For optimal transmission, keep the areas immediately around the antenna free from obstruction. To see wireless regulatory notices, refer to the section of the <i>Regulatory, Safety and Environmental Notices</i> that applies to your country or region. These notices are located in Help and Support.</p>

Right-side components





Component	Description
(1) Fingerprint reader (select models only)	<p>Allows a fingerprint logon to Windows instead of a password logon.</p>
(2)  Rotate button	<p>Rotates the screen image counterclockwise to 4 orientations: landscape primary, portrait primary, landscape secondary, and portrait secondary.</p> <p>NOTE: Computers with WWAN capabilities only support landscape primary and portrait secondary orientations.</p>
(3)  Power light	<ul style="list-style-type: none"> • White: The computer is on. • Blinking white: The computer is in the Sleep state. • Off: The computer is off or in Hibernation.
(4) Power switch	<ul style="list-style-type: none"> • When the computer is off, slide the power switch to turn on the computer. • When the computer is on, briefly slide the power switch to exit Sleep. • When the computer is in the Sleep state, briefly slide the power switch to exit Sleep. • When the computer is in Hibernation, briefly slide the power switch to exit Hibernation.

Component	Description
(5)  Wireless light	<p>If the computer has stopped responding and Windows® shutdown procedures are ineffective, slide and hold the power switch for at least 5 seconds to turn off the computer.</p> <p>To learn more about your power settings, select Start > Control Panel > System and Security > Power Options.</p>
(6) Wireless button	<p>Turns the wireless feature on or off, but does not establish a wireless connection.</p> <p>NOTE: A wireless network must be set up in order to establish a wireless connection.</p>
(7) Digital Media Slot	<p>Supports the following digital card formats:</p> <ul style="list-style-type: none"> • Memory Stick • Memory Stick Pro • MultiMediaCard • Secure Digital Memory Card • xD-Picture Card
(8)  USB ports (2)	Connect optional USB devices.
(9)  Battery light	<ul style="list-style-type: none"> • Off: The computer is running on battery power. • Blinking amber: The battery has reached a low battery level, a critical battery level, or there is a battery error. • Amber: A battery is charging. • White: The computer is connected to external power and the battery is fully charged.
(10) Power connector	Connects an AC adapter.

Left-side components



Component	Description
(1) Vent	Enables airflow to cool internal components. NOTE: The computer fan starts up automatically to cool internal components and prevent overheating. It is normal for the internal fan to cycle on and off during routine operation.
(2) HDMI port	Connects an optional video or audio device, such as a high-definition television, or any compatible digital or audio component.
(3)  USB port	Connects an optional USB device.
(4)  Audio-out (headphone) jack/Audio-in (microphone) jack	Produces sound when connected to optional powered stereo speakers, headphones, earbuds, a headset, or television audio. Also connects an optional headset microphone. NOTE: When a device is connected to the jack, the device speakers are disabled.
(5)  Drive light	<ul style="list-style-type: none"> Blinking white: The hard drive is being accessed. Amber: HP ProtectSmart Hard Drive Protection has temporarily parked the hard drive.
(6) Pen tether hole	Connects the pen tether.
(7) Pen holder	Holds the digitizer pen.

Display components

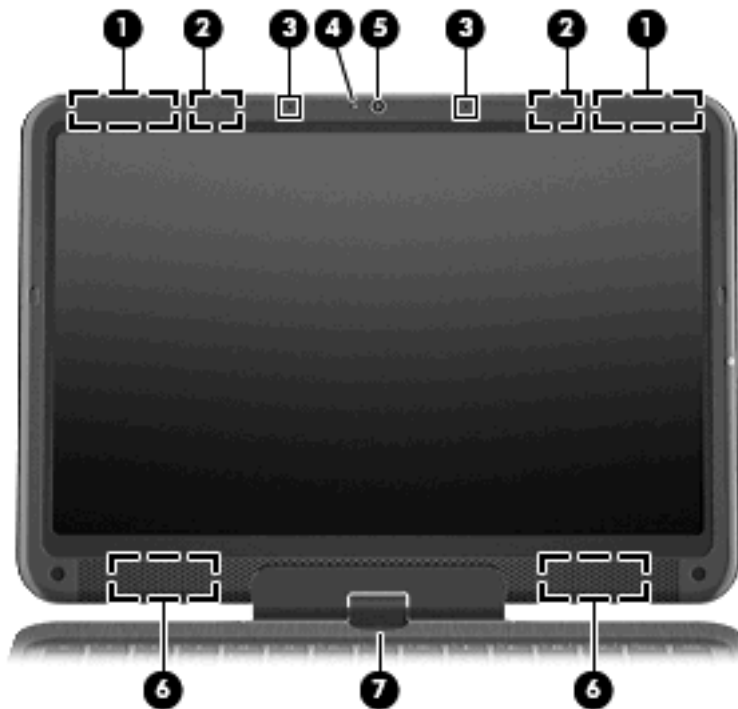



Component	Description
(1) WWAN antennas (2)* (select models only)	Send and receive wireless signals to communicate with wireless wide-area networks (WWAN).
(2) WLAN antennas (2)*	Send and receive wireless signals to communicate with wireless local area networks (WLAN).
(3) Internal microphones (2)	Record sound.
(4) Webcam light	On: The webcam is in use.
(5) Webcam	Records video and captures still photographs.
(6) Speakers (2)	Produce sound.
(7) Convertible hinge	Swivels the display and converts the computer from traditional notebook mode to slate mode or from slate mode to notebook mode. In slate mode, the display is rotated and folded flat, so that you can view content while carrying the computer.

*The antennas are not visible from the outside of the computer. For optimal transmission, keep the areas immediately around the antennas free from obstructions. To see wireless regulatory notices, refer to the section of the *Regulatory, Safety and Environmental Notices* that applies to your country or region. These notices are located in Help and Support.



Rear components

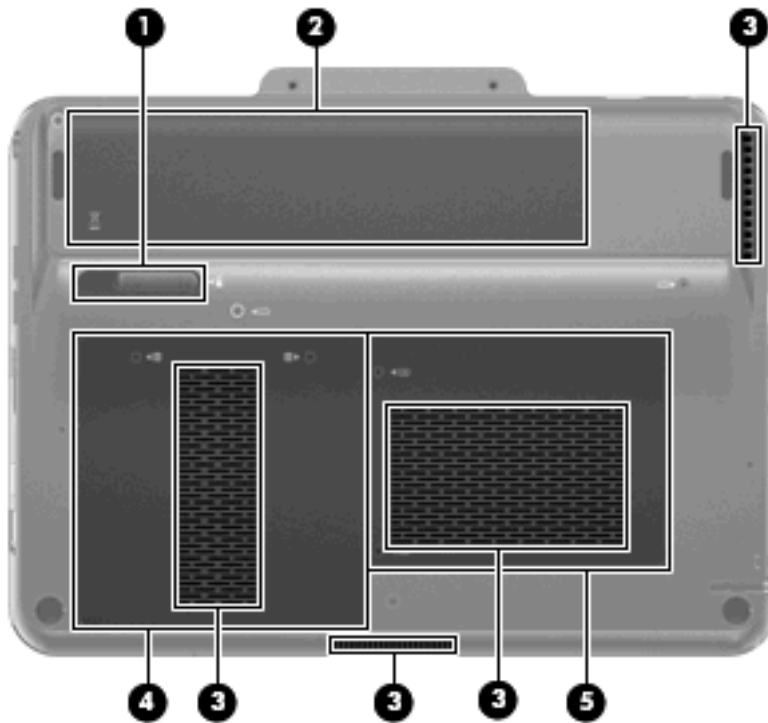

Component	Description
(1)  Security cable slot	Attaches an optional security cable to the computer. NOTE: The security cable is designed to act as a deterrent, but it may not prevent the computer from being mishandled or stolen.
(2)  External monitor port	Connects an external VGA monitor or projector.
(3)  RJ-45 (network) jack	Connects a network cable.

Bottom components



Component	Description
(1)  Battery release latch	Releases the battery from the battery bay.
(2) Battery bay	Holds the battery. NOTE: The battery is preinstalled in the battery bay at the factory.
(3) Vents (4)	Enable airflow to cool internal components. NOTE: The computer fan starts up automatically to cool internal components and prevent overheating. It is normal for the internal fan to cycle on and off during routine operation.
(4)  Hard drive bay	Holds the hard drive.
(5)  Memory module compartment	Contains the memory module slots.

2 Networking

The computer supports 2 types of Internet access:

- Wireless—For mobile Internet access, you can use a wireless connection. To learn about adding the computer to an existing network or setting up a wireless network, refer to [Creating a wireless connection on page 14](#).
- Wired—You can access the Internet by connecting to a broadband network using the RJ-45 (network) jack. To learn about connecting using the RJ-45 jack, refer to [Connecting to a wired network on page 23](#).

Choosing an ISP

You must set up Internet service before you can connect to the Internet. The computer includes the following software features to help you set up a new Internet account or configure the computer to use an existing account:

- Internet Services & Offers (available in some locations)
- ISP-provided icons (available in some locations)
- Windows Connect to the Internet Wizard (available in all locations)

Using Internet Services & Offers

If the Internet Service & Offers utility is supported in the country or region in which you purchased the computer, you can access the utility by using the following method:

- ▲ Select **Start > All Programs > Online Services > Get Online**.

The Internet Services & Offers utility assists with these tasks:

- Signing up for a new Internet account
- Configuring the computer to use an existing account

Using ISP-provided icons

If ISP-provided icons are supported in the country or region in which you purchased the computer, the icons may be displayed either individually on the Windows desktop or grouped in a desktop folder named Online Services.

- ▲ To set up a new Internet account or configure the computer to use an existing account, double-click an icon, and then follow the instructions on the screen.

Using the Windows Connect to the Internet Wizard

You can use the Windows Connect to the Internet Wizard to connect to the Internet in any of these situations:

- If you already have an account with an ISP.
- If you have a disc from an ISP.
- If you do not have an Internet account and would like to select an ISP from the list provided within the wizard. (The list of ISP providers is not available in all regions.)
- If you have selected an unlisted ISP and the ISP has provided you with such information as a specific IP address and POP3 and SMTP settings.

To access the Windows Connect To The Internet Wizard and instructions for using the wizard, select **Start > Help and Support**.

 **NOTE:** If you are prompted within the wizard to choose between enabling or disabling Windows Firewall, choose to enable the firewall.

Creating a wireless connection







Wireless technology transfers data across radio waves instead of wires. Your computer may be equipped with one or more of the following wireless devices:

- **Wireless local area network (WLAN) device**—Connects the computer to wireless local area networks (commonly referred to as Wi-Fi networks, wireless LANs, or WLANs) in corporate offices, your home, and public places such as airports, restaurants, coffee shops, hotels, and universities. In a WLAN, each mobile wireless device communicates with a wireless router or a wireless access point.
- **HP Mobile Broadband Module**—A wireless wide area network (WWAN) device that provides access to information wherever mobile network operator service is available. In a WWAN, each mobile device communicates to a mobile network operator's base station. Mobile network operators install networks of base stations (similar to cell phone towers) throughout large geographic areas, effectively providing coverage across entire states, regions, or even countries.
- **Bluetooth® device**—Creates a personal area network (PAN) to connect to other Bluetooth-enabled devices such as computers, phones, printers, headsets, speakers, and cameras. In a PAN, each device communicates directly with other devices, and devices must be relatively close together—typically within 10 meters (approximately 33 feet) of each other.

For more information on wireless technology, refer to the information and Web site links provided in Help and Support.

Identifying wireless icons and controls

Identifying wireless and network status icons

Icon	Name	Description
	Wireless (connected)	Identifies the location of the wireless light and the wireless key and button on the computer. Also identifies the Wireless Assistant software on the computer and indicates that one or more of the wireless devices are on.
	Wireless (disconnected)	Identifies the Wireless Assistant software on the computer and indicates that all of the wireless devices are off.
	HP Connection Manager	Opens HP Connection Manager, which enables you to create a connection with an HP Mobile Broadband device (select models only).
	Network status	Indicates the status of network connections, both wired and wireless.
		When you move the mouse pointer over the icons, more detailed information is displayed.
		



Using the wireless key and button

The computer has a **wireless** key (1), a wireless button (2), two wireless lights (3), and one or more wireless devices. All of the wireless devices on your computer are enabled at the factory.

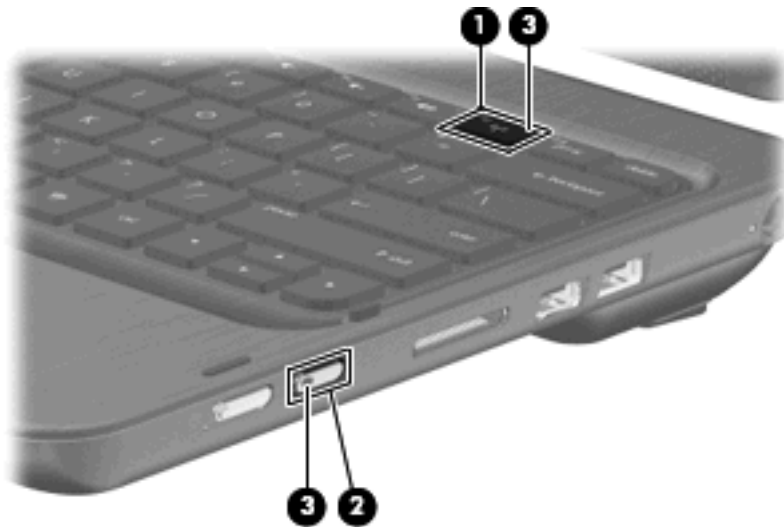

If the wireless lights are amber, all wireless devices are off. If the wireless lights are white, an integrated wireless device, such as a wireless local area network (WLAN) device and/or a Bluetooth® device, is on.

The wireless lights indicate the overall power state of your wireless devices, not the status of individual devices. Press the **wireless** key or wireless button to turn the wireless devices off or on.

Because the wireless devices are enabled at the factory, you can use the **wireless** key or wireless button to turn on or turn off the wireless devices simultaneously. Individual wireless devices can be controlled through Wireless Assistant software.

Using Wireless Assistant software

A wireless device can be turned on or off using the Wireless Assistant software. If a wireless device is disabled in Setup Utility, it must be reenabled in Setup Utility before it can be turned on or off using Wireless Assistant.

 **NOTE:** Enabling or turning on a wireless device does not automatically connect the computer to a network or a Bluetooth-enabled device.

To view the state of the wireless devices, click the **Show hidden icons** icon, the arrow at the left of the notification area, and position the mouse pointer over the wireless icon.

If the wireless icon is not displayed in the notification area, complete the following steps to change Wireless Assistant properties:

1. Select **Start > Control Panel > Hardware and Sound > Windows Mobility Center**.
2. Click the wireless icon in the Wireless Assistant tile, which is located in the bottom row of Windows® Mobility Center.
3. Click **Properties**.
4. Select the check box next to **HP Wireless Assistant icon in notification area**.
5. Click **Apply**.
6. Click **Close**.

For more information, refer to the Wireless Assistant software Help:

1. Open Wireless Assistant by clicking the wireless icon in Windows Mobility Center.
2. Click the **Help** button.

Using operating system controls

Some operating systems also offer a way to manage integrated wireless devices and the wireless connection. For example, Windows provides the Network and Sharing Center that allows you to set up a connection or network, connect to a network, manage wireless networks, and diagnose and repair network problems.

To access the Network and Sharing Center, select **Start > Control Panel > Network and Internet > Network and Sharing Center**.

For more information, select **Start > Help and Support**.

Connecting to a WLAN

With a WLAN device, you can access a wireless local area network (WLAN), which is composed of other computers and accessories that are linked by a wireless router or a wireless access point.

 **NOTE:** The terms *wireless router* and *wireless access point* are often used interchangeably.

- A large-scale WLAN, such as a corporate or public WLAN, typically uses wireless access points that can accommodate a large number of computers and accessories and can separate critical network functions.
- A home or small office WLAN typically uses a wireless router, which allows several wireless and wired computers to share an Internet connection, a printer, and files without requiring additional pieces of hardware or software.

To use the WLAN device in your computer, you must connect to a WLAN infrastructure (provided through a service provider or a public or corporate network).

Connecting to an existing wireless network

To connect the computer to an existing wireless network, follow these steps:

1. Be sure that the wireless device is on (wireless light is white). If the wireless light is amber, press the [wireless](#) key or wireless button.
2. Click the network icon in the notification area, at the far right of the taskbar.
3. Select a network to connect to.
4. Click **Connect**.
5. If the network is a security-enabled WLAN, you are prompted to enter a network security key, which is a security code. Type the code, and then click **OK** to complete the connection.

Setting up a wireless network

To set up a WLAN and connect to the Internet, you need the following equipment:

- A broadband modem (either DSL or cable) **(1)** and high-speed Internet service purchased from an Internet service provider (ISP)
- A wireless router (purchased separately) **(2)**
- The wireless computer **(3)**

The illustration below shows an example of a wireless network installation that is connected to the Internet.



 **NOTE:** When setting up a wireless connection, be sure that your computer and wireless router are synchronized. To synchronize your computer and wireless router, turn your computer and wireless router off and then back on.

As your network grows, additional wireless and wired computers can be connected to the network to access the Internet.

For additional help in setting up your WLAN, refer to the information provided by your router manufacturer or your ISP.

Step 1: Purchase high-speed Internet service

If you already have high-speed Internet service (DSL, cable, or satellite), begin with [Step 2: Purchase and install a wireless router on page 18](#). If you do not have high-speed Internet service, follow these steps:

1. Contact a local ISP to purchase high-speed Internet service and a DSL or cable modem. The ISP will help set up the modem, install a network cable to connect your wireless computer to the modem, and test the Internet service.
2. Your ISP will give you a user ID and password to access the Internet. Record this information and store it in a safe place.

Step 2: Purchase and install a wireless router

Read this section carefully before you install the wireless router using the router manufacturer's instructions and your wireless computer. If you need technical assistance during the router installation, contact the router manufacturer.

 **NOTE:** It is recommended that you temporarily connect your new wireless computer to the router by using the network cable provided with the router. This will ensure that the computer can access the Internet.

1. Be sure that the wireless light on the computer is white. If the wireless light is amber, press the [wireless](#) key or wireless button.
2. During the router installation, the router manufacturer's software allows you to change the network name (SSID) and enable security to protect the privacy of your wireless network. Many routers are shipped with a default network name and with security disabled. If you change the default network name or enable security during the router setup, record the information and store it in a safe place. You will need this information when you configure the computer and any other existing computers to access the router.

 **NOTE:** If you do not enable security, an unauthorized wireless user can access the data on the computer and use your Internet connection without your knowledge. For more information on securing your wireless network, refer to the [Wireless guide in Help and Support](#).

The Windows operating system also provides tools to help you set up your wireless network for the first time. To use the Windows tools to set up your network:

- ▲ Select **Start > Network and Internet > Network and Sharing Center > Set up a new connection or network > Set up a new network**. Then follow the on-screen instructions.

Step 3: Configure the computer to connect to the wireless network

1. Be sure that the wireless device is on (wireless light is white). If the wireless light is amber, press the [wireless](#) key or wireless button.
2. Click the network icon in the notification area, at the far right of the taskbar.
3. Select a network to connect to.
4. Click **Connect**.
5. If the network is a security-enabled WLAN, you are prompted to enter a network security key, which is a security code. Type the code, and then click **OK** to complete the connection.
6. Test the wireless network by opening your Web browser and accessing a Web site.

Protecting your WLAN

Because the WLAN standard was designed with only limited security capabilities—basically to foil casual eavesdropping rather than more powerful forms of attack—it is essential to understand that WLANs are vulnerable to well-known and well-documented security weaknesses.

WLANs in public areas, or “hotspots,” like coffee shops and airports may not provide any security. New technologies are being developed by wireless manufacturers and hotspot service providers that make the public environment more secure and anonymous. If you are concerned about the security of your computer in a hotspot, limit your network activities to noncritical e-mail and basic Internet surfing.

When you set up a WLAN or access an existing WLAN, always enable security features to protect your network from unauthorized access. The common security levels are Wi-Fi Protected Access (WPA)-Personal and Wired Equivalent Privacy (WEP). Because wireless radio signals travel outside the network, other WLAN devices can pick up unprotected signals and either connect to your network (uninvited) or capture information being sent across it. However, you can take precautions to protect your WLAN:

- **Use a wireless transmitter with built-in security**

Many wireless base stations, gateways, or routers provide built-in security features such as wireless security protocols and firewalls. With the correct wireless transmitter, you can protect your network from the most common wireless security risks.

- **Work behind a firewall**

A firewall is a barrier that checks both data and requests for data that are sent to your network, and discards any suspicious items. Firewalls are available in many varieties, both software and hardware. Some networks use a combination of both types.

- **Use wireless encryption**

A variety of sophisticated encryption protocols is available for your WLAN. Find the solution that works best for your network security:

- **Wired Equivalent Privacy (WEP)** is a wireless security protocol that encodes or encrypts all network data before it is transmitted using a WEP key. Usually, you can allow the network to assign the WEP key. Alternatively, you can set up your own key, generate a different key, or choose other advanced options. Without the correct key, others will not be able to use the WLAN.
- **WPA (Wi-Fi Protected Access)**, like WEP, uses security settings to encrypt and decrypt data that is transmitted over the network. However, instead of using one static security key for encryptions as WEP does, WPA uses “temporal key integrity protocol” (TKIP) to dynamically generate a new key for every packet. It also generates different sets of keys for each computer on the network.

Roaming to another network

When you move your computer within range of another WLAN, Windows attempts to connect to that network. If the attempt is successful, your computer is automatically connected to the new network. If Windows does not recognize the new network, follow the same procedure you used initially to connect to your WLAN.

Using HP Mobile Broadband (select models only)

HP Mobile Broadband enables your computer to use wireless wide area networks (WWANs) to access the Internet from more places and over larger areas than it can by using WLANs. Using HP Mobile Broadband requires a network service provider (called a *mobile network operator*), which in most cases is a mobile phone network operator. Coverage for HP Mobile Broadband is similar to mobile phone voice coverage.

When used with mobile network operator service, HP Mobile Broadband gives you the freedom to stay connected to the Internet, send e-mail, or connect to your corporate network whether you are on the road or outside the range of Wi-Fi hotspots.

 **NOTE:** Computers with WWAN capabilities only support landscape primary and portrait secondary orientations.

HP Mobile Broadband supports the following technologies:

- HSPA (High Speed Packet Access), which provides access to networks based on the Global System for Mobile Communications (GSM) telecommunications standard.
- EV-DO (Evolution Data Optimized), which provides access to networks based on the code division multiple access (CDMA) telecommunications standard.

You may need the HP Mobile Broadband Module serial number to activate mobile broadband service. The serial number is printed on a label inside the battery bay of your computer.

Some mobile network operators require the use of a subscriber identity module (SIM). A SIM contains basic information about you, such as a personal identification number (PIN), as well as network information. Some computers include a SIM that is preinstalled in the battery bay. If the SIM is not preinstalled, it may be provided in the HP Mobile Broadband information provided with your computer, or the mobile network operator may provide it separately from the computer.

For information on inserting and removing the SIM, refer to [Inserting a SIM on page 20](#) and [Removing a SIM on page 21](#).

For information on HP Mobile Broadband and how to activate service with a preferred mobile network operator, refer to the HP Mobile Broadband information included with your computer. For additional information, see the HP Web site at <http://www.hp.com/go/mobilebroadband> (US only).

Inserting a SIM

 **CAUTION:** To prevent damage to the connectors, use minimal force when inserting a SIM.

To insert a SIM:

1. Shut down the computer. If you are not sure whether the computer is off or in Hibernation, turn the computer on by sliding the power switch. Then shut down the computer through the operating system.
2. Close the display.
3. Disconnect all external devices connected to the computer.
4. Unplug the power cord from the AC outlet.
5. Turn the computer upside down on a flat surface, with the battery bay toward you.
6. Remove the battery.

7. Insert the SIM into the SIM slot, and gently push the SIM into the slot until it is firmly seated.

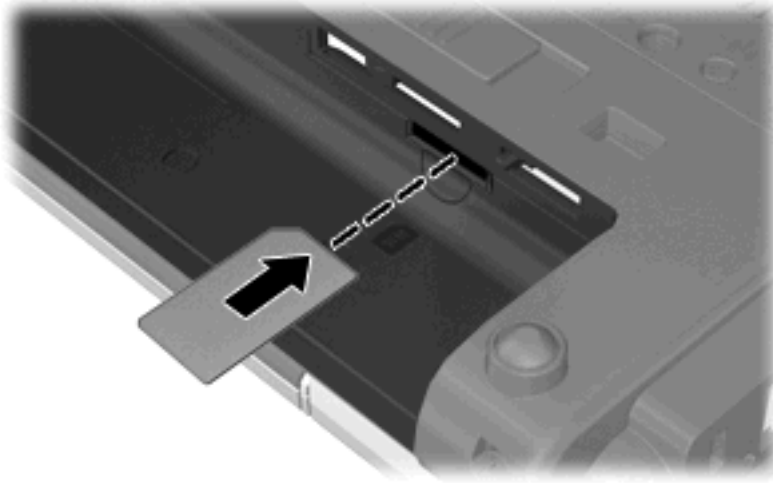

8. Replace the battery.

 **NOTE:** HP Mobile Broadband will be disabled if the battery is not replaced.

9. Turn the computer right-side up, and then reconnect external power and external devices.
10. Turn on the computer.

Removing a SIM

To remove a SIM:

1. Shut down the computer. If you are not sure whether the computer is off or in Hibernation, turn the computer on by sliding the power switch. Then shut down the computer through the operating system.
2. Close the display.
3. Disconnect all external devices connected to the computer.
4. Unplug the power cord from the AC outlet.
5. Turn the computer upside down on a flat surface, with the battery bay toward you.
6. Remove the battery.

7. Press in on the SIM (1), and then remove it from the slot (2).

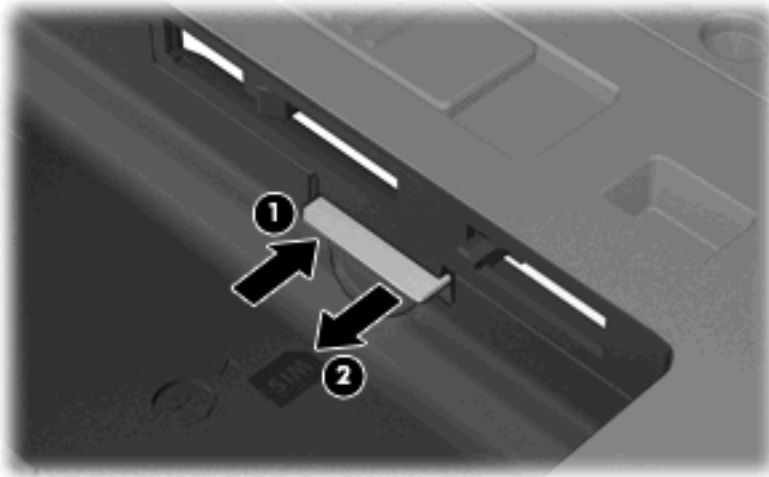

8. Replace the battery.
9. Turn the computer right-side up, and then reconnect external power and external devices.
10. Turn on the computer.

Using Bluetooth wireless devices

A Bluetooth device provides short-range wireless communications that replace the physical cable connections that traditionally link electronic devices such as the following:

- Computers (desktop, notebook, PDA)
- Phones (cellular, cordless, smart phone)
- Imaging devices (printer, camera)
- Audio devices (headset, speakers)

Bluetooth devices provide peer-to-peer capability that allows you to set up a personal area network (PAN) of Bluetooth devices. For information on configuring and using Bluetooth devices, refer to the Bluetooth software Help.

Bluetooth and Internet Connection Sharing (ICS)

HP does **not** recommend setting up one computer with Bluetooth as a host and using it as a gateway through which other computers may connect to the Internet. When two or more computers are connected using Bluetooth, and Internet Connection Sharing (ICS) is enabled on one of the computers, the other computers may not be able to connect to the Internet using the Bluetooth network.

The strength of Bluetooth is in synchronizing information transfers between your computer and wireless devices including cellular phones, printers, cameras, and PDAs. The inability to consistently connect two or more computers to share the Internet through Bluetooth is a limitation of Bluetooth and the Windows operating system.

Connecting to a wired network

Connecting to a local area network (LAN) requires an 8-pin, RJ-45 network cable (purchased separately). If the network cable contains noise suppression circuitry (1), which prevents interference from TV and radio reception, orient the circuitry end of the cable (2) toward the computer.



To connect to a LAN:

1. Plug the network cable into the network jack (1) on the computer.
2. Plug the other end of the network cable into a network wall jack (2).

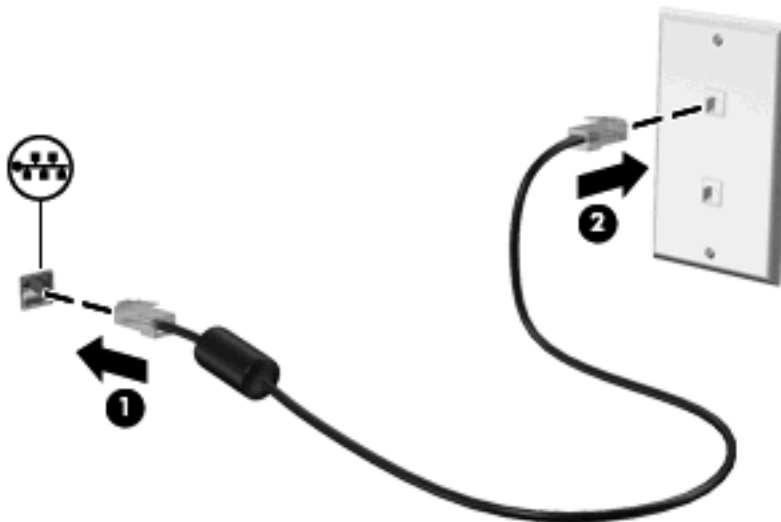

⚠ WARNING! To reduce the risk of electric shock, fire, or damage to the equipment, do not plug a modem cable or telephone cable into an RJ-45 (network) jack.

3 Pointing devices, touch screen, and keyboard

Using pointing devices

 **NOTE:** In addition to the TouchPad, you can also connect an external USB mouse to one of the USB ports on the computer.

Setting pointing device preferences

Use Mouse Properties in Windows® to customize settings for pointing devices, such as button configuration, click speed, and pointer options.

To access Mouse Properties, select **Start > Devices and Printers**. Then, right-click the device representing your computer, and select **Mouse settings**.

Using the TouchPad

To move the pointer, touch and slide one finger across the TouchPad surface in the direction you want the pointer to go. Use the left and right TouchPad buttons like the corresponding buttons on an external mouse.

 **NOTE:** For information on identifying the TouchPad components, refer to [TouchPad on page 3](#).

Turning the TouchPad on and off

The TouchPad is turned on at the factory. When the TouchPad zone is active, the light is off.

To turn the TouchPad on and off, quickly double-tap the TouchPad off indicator.

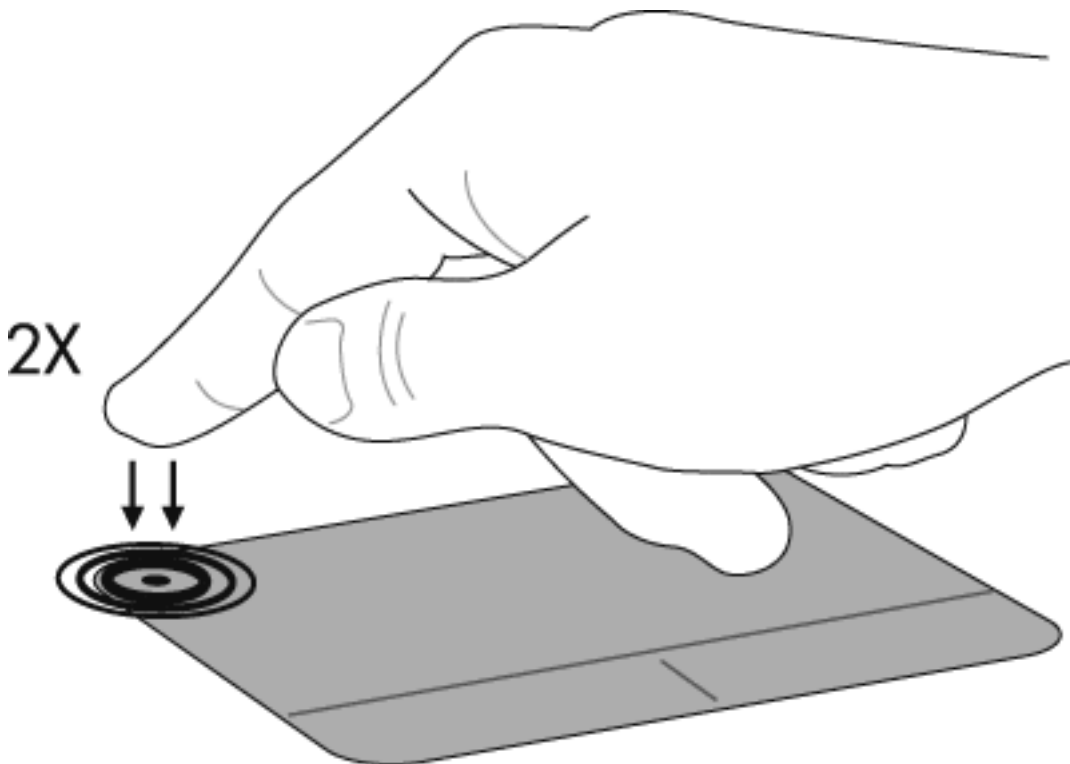

Using TouchPad gestures

The TouchPad supports a variety of TouchPad gestures. To activate the TouchPad gestures, place two fingers on the TouchPad at the same time as described in the following sections.

 **NOTE:** You can scroll and pinch anywhere on the TouchPad surface. The rotate gesture must be done within the TouchPad zone.

The TouchPad gestures described in this section are enabled at the factory. To disable or reenable these gestures:

1. Double-click on the **Synaptics** icon in the notification area, at the far right of the taskbar, and then click the **Device Settings** tab.
2. Select the device, and then click **Settings**.
3. Select the gesture that you want to disable or reenable.
4. Click **Apply**, and then click **OK**.

 **NOTE:** Your computer also supports additional TouchPad features that are disabled at the factory. To view and enable these features, click the **Synaptics** icon in the notification area, at the far right of the taskbar, and then click the **Device Settings** tab. Select the device, and then click **Settings**.

Scrolling

Scrolling is useful for moving up or down on a page or image. To scroll, place two fingers slightly apart on the TouchPad and drag them across the TouchPad in an up, down, left, or right motion.

 **NOTE:** Scrolling speed is controlled by finger speed.

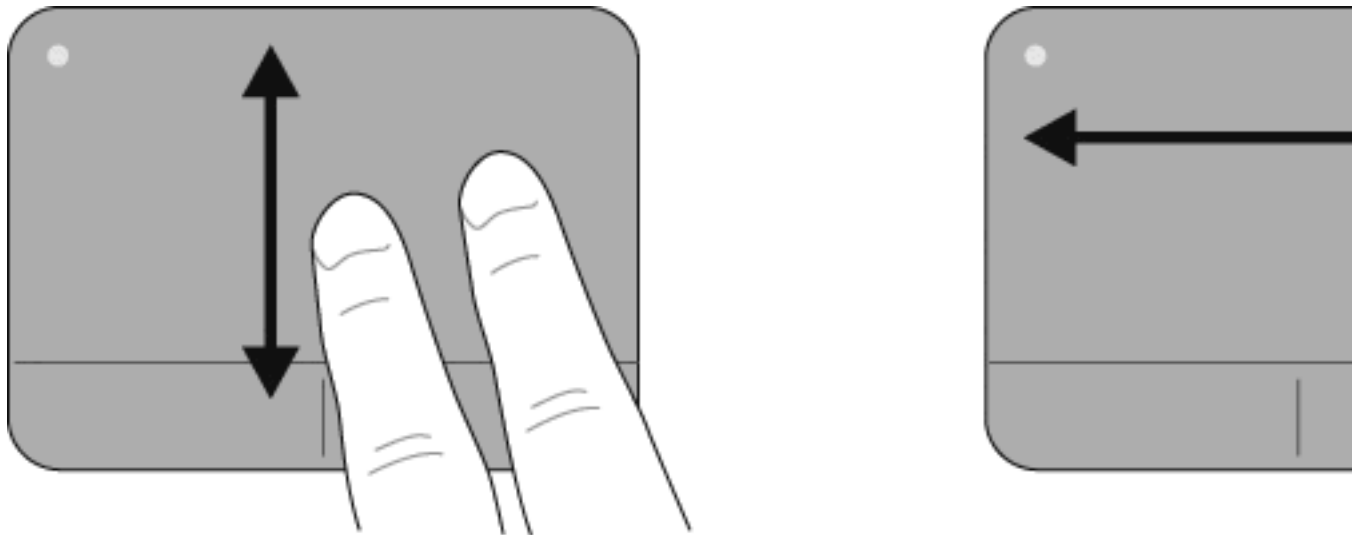

Pinching/Zooming

Pinching/zooming allows you to zoom in or out on items such as PDFs, images, and photos.

- Zoom in by placing two fingers together on the TouchPad, and then moving them apart to gradually increase the object's size.
- Zoom out by placing two fingers apart on the TouchPad, and then moving them together to gradually decrease the object's size.

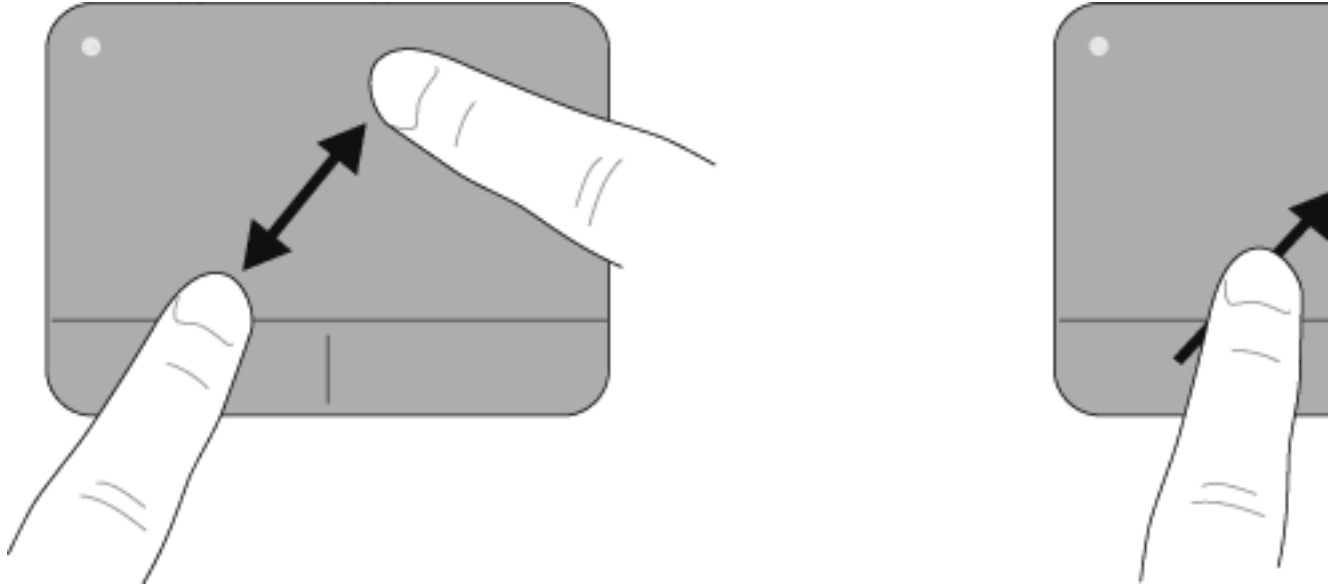

Rotating

Rotating allows you to rotate items such as photos and pages. To rotate, anchor your left forefinger in the TouchPad zone. Move the right forefinger around the anchored finger in a sweeping motion, moving from twelve o'clock to three o'clock. To reverse the rotation, move your right forefinger from three o'clock to twelve o'clock.

 **NOTE:** Rotating must be done within the TouchPad zone.

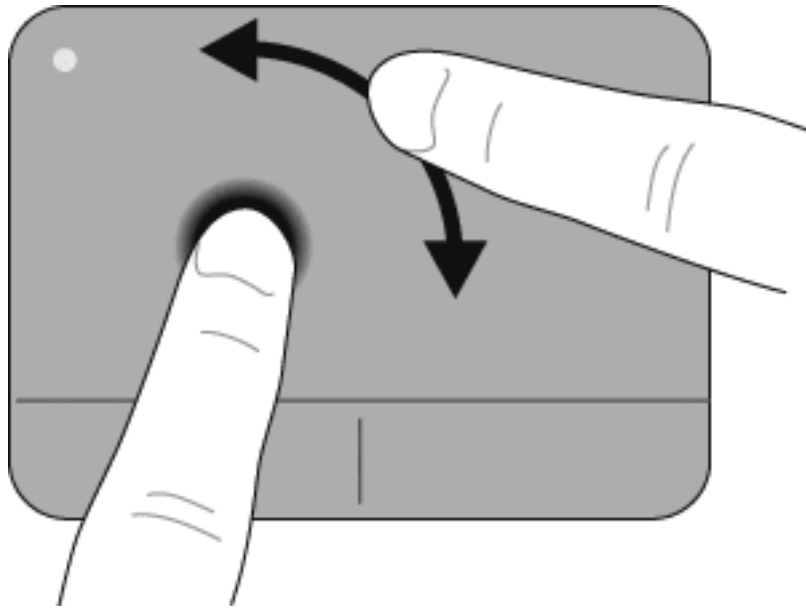

Using the digitizer pen

You can write with the pen in pen-specific programs such as Tablet PC Input Panel, in all Microsoft® Office programs, and in most other Windows programs and utilities. The information you write on the screen with the pen can be filed, searched, and shared among most Windows programs.

Identifying the pen components

The pen interacts with the computer whenever the tip **(1)** of the pen is pressed against the screen.

The pen tether eyelet **(2)** allows you to connect a tether from the pen to the pen tether hole on the computer.



Holding the pen

Hold the pen as if you were writing with a standard pen or pencil.

Storing the pen

To store the pen when you are not using it, insert the pen, tip first, into the pen holder on the computer.



Using the touch screen

Rotating the display

To rotate the display and use the computer in slate mode:

1. Open the display.
2. Rotate the display 180 degrees either clockwise or counterclockwise.



3. Lower the display over the keyboard.



 **NOTE:** To reduce the risk of damage to your computer, do not force the display past 180 degrees, and do not transport the computer while it is in slate mode.

Using the rotate button

When the computer is in slate mode, press the rotate button (on the right side of the computer) to change the screen image to 4 different orientations. When you change the screen orientation, the top of the screen rotates 90 degrees clockwise into the following orientations: landscape secondary (1), portrait primary (2), landscape primary (3), and portrait secondary (4).

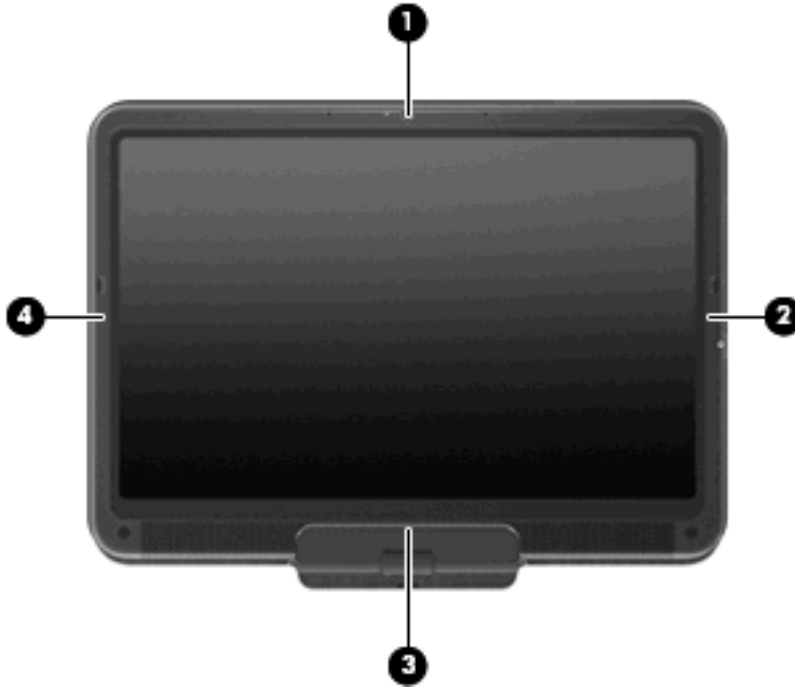

 **NOTE:** Computers with WWAN capabilities only support landscape primary (3) and portrait secondary (4) orientations.

Using touch screen gestures

The computer allows you to use your fingers or the digitizer pen to perform certain actions on the touch screen.

 **NOTE:** The instructions in this section are based on the preferences set at the factory. To modify settings for recognized clicks and flicks, select **Start > Control Panel > Hardware and Sound > Pen and Touch**.

NOTE: Some gestures are not supported in all programs.

Tapping (or clicking)

Tap or double-tap an item on the screen as you would click or double-click with the TouchPad or an external mouse. Tap and hold an item to see the context menu as you would with the right TouchPad button.

 **NOTE:** You must tap and hold your finger until the operating system draws a circle around the area you are touching, and then the context menu appears.

Flicking

Touch the screen in a light, quick flicking motion up, down, left, or right to navigate through screens or quickly scroll through documents.

 **NOTE:** For the flick movement to work, a scrollbar must be present and in the active window.

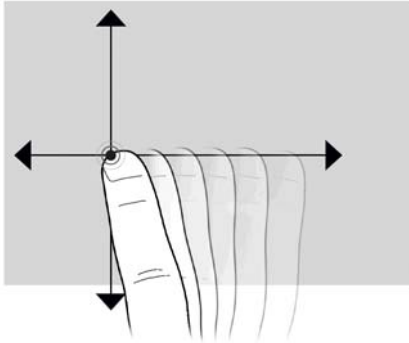

Dragging

Press your finger on an item on the screen, and then move your finger to drag the item to a new location. You can also use this motion to slowly scroll through documents.

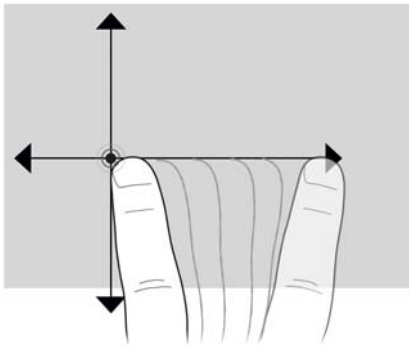

Scrolling

Scrolling is useful for moving up or down on a page or image. To scroll, place two fingers slightly apart on the screen, and then drag them across the screen in an up, down, left, or right motion.

 **NOTE:** Scrolling speed is controlled by finger speed.

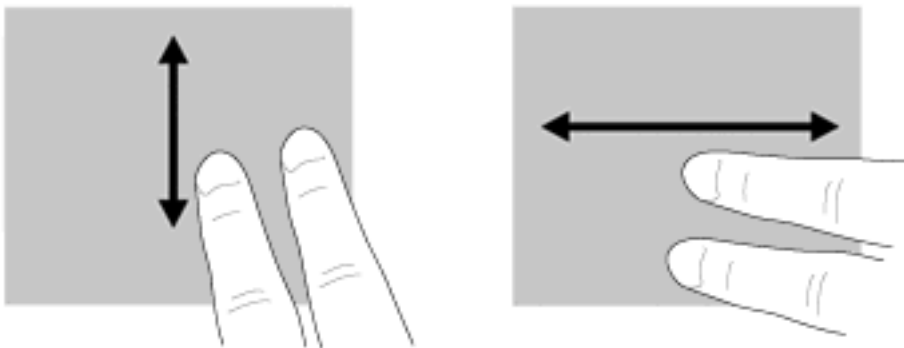

Rotating

Rotating allows you rotate items such as photos and pages. To rotate, anchor your thumb on the screen, and then move your forefinger in a semicircular motion around your thumb.

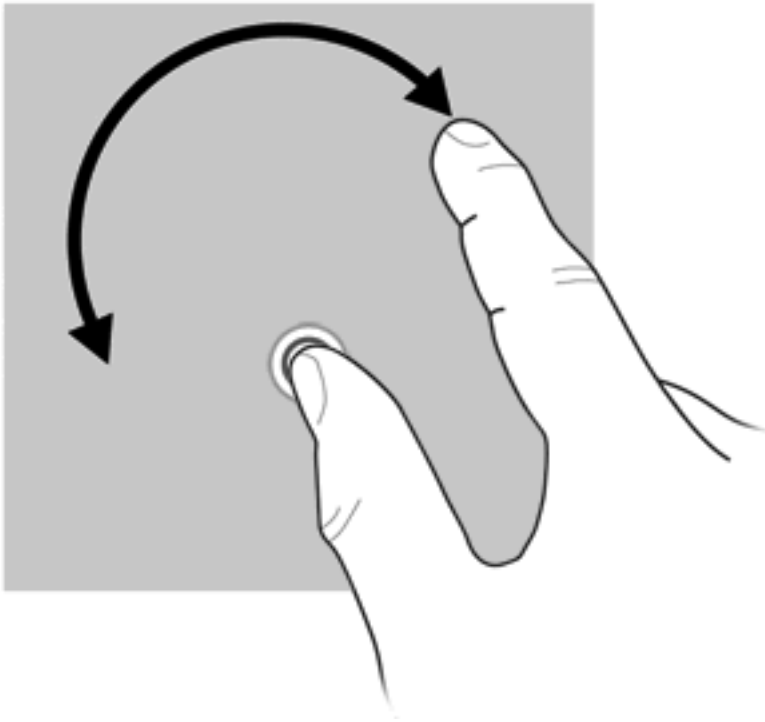

Pinching

Pinching allows you to zoom in or out on items such as PDFs, images, and photos.

To pinch:

- Zoom out by holding two fingers apart on the screen, and then pull the fingers together to decrease an object's size.
- Zoom in by holding two fingers together on the screen, and then pull the fingers apart to increase an object's size.

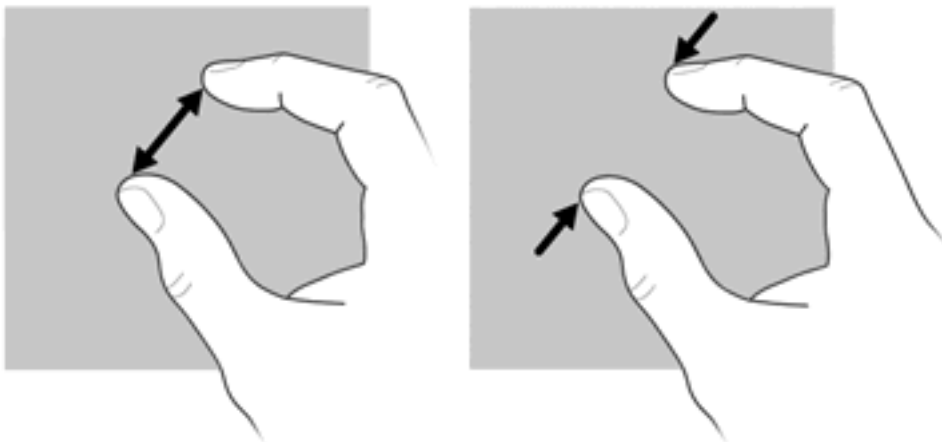

Setting touch screen preferences

- ▲ To set preferences for visual feedback, select **Start > Control Panel > Hardware and Sound > Pen and Touch**. These preferences are specific to the touch screen and the computer.
- ▲ To set preferences for left-handed or right-handed users, select **Start > Control Panel > Hardware and Sound > Tablet PC Settings > Other** tab. These preferences are specific to the touch screen and the computer.
- ▲ To set pointing device preferences such as pointer speed, click speed, and mouse trails, select **Start > Devices and Printers**. Then, right-click the device representing your computer, and select **Mouse settings**. These preferences apply to any pointing device in the system.

To change or test click settings:

1. Select **Start > Control Panel > Hardware and Sound > Pen and Touch > Pen Options** tab.
2. Under **Pen Actions**, select the action, and then click **Settings**.
3. After making any changes or testing the settings, click **OK**.

To change or create flick assignments:

1. Select **Start > Control Panel > Hardware and Sound > Pen and Touch > Flicks** tab.
2. Click **Navigational flicks and editing flicks**, and then click **Customize**.
3. Follow the on-screen instructions to change or create a flick assignment.
4. Click **OK**.

Using the action keys









Action keys are customized actions that are assigned to specific keys at the top of the keyboard.





To use an action key, press and hold this key to activate the assigned action.

 **NOTE:** Depending on the application you are using, pressing **fn** and one of the action keys will open a specific shortcut menu within that application.

NOTE: The action key feature is enabled at the factory. You can disable this feature in Setup Utility (BIOS) and revert back to pressing the **fn** key and one of the action keys to activate the assigned action. Refer to [Setup Utility \(BIOS\) on page 100](#) for additional information.



Icon	Action	Description
	Help and Support	Opens Help and Support, which provides information about your Windows operating system and computer, answers to questions and tutorials, and updates to your computer. Help and Support also provides automated troubleshooting and links to support specialists.
	Screen brightness down	Decreases the screen brightness level incrementally when you hold down this key.
	Screen brightness up	Increases the screen brightness level incrementally when you hold down this key.
	Switch screen image	Switches the screen image among display devices connected to the system. For example, if a monitor is connected to the computer, pressing this key alternates the screen image from computer display to monitor display to simultaneous display on both the computer and the monitor. Most external monitors receive video information from the computer using the external VGA video standard. The switch screen image key can also alternate images among other devices that are receiving video information from the computer.
	Previous track	Plays the previous track of an audio CD or the previous section of a DVD or a BD.
	Play/Pause	Plays, pauses, or resumes an audio CD, a DVD, or a BD. <ul style="list-style-type: none">• If an audio CD, a DVD, or a BD is not playing, press this key to begin or resume the play.• If an audio CD, a DVD, or a BD is playing, press this key to pause the play.
	Stop	Stops audio or video playback of a CD, a DVD, or a BD.
	Next track	Plays the next track of an audio CD or the next section of a DVD or a BD.

Icon	Action	Description
	Volume down	Decreases speaker sound incrementally when you hold down this key.
	Volume up	Increases speaker sound incrementally when you hold down this key.
	Mute	Mutes or restores speaker sound.
	Wireless	Turns the wireless feature on or off. NOTE: This key does not establish a wireless connection. To establish a wireless connection, a wireless network must be set up.
prt sc	Print screen	Takes a snapshot or picture of your computer screen and copies it to the clipboard.

Using the hotkeys

Hotkeys are combinations of the **fn** key (1) and either the **esc** key (2) or one of the arrow keys (3).

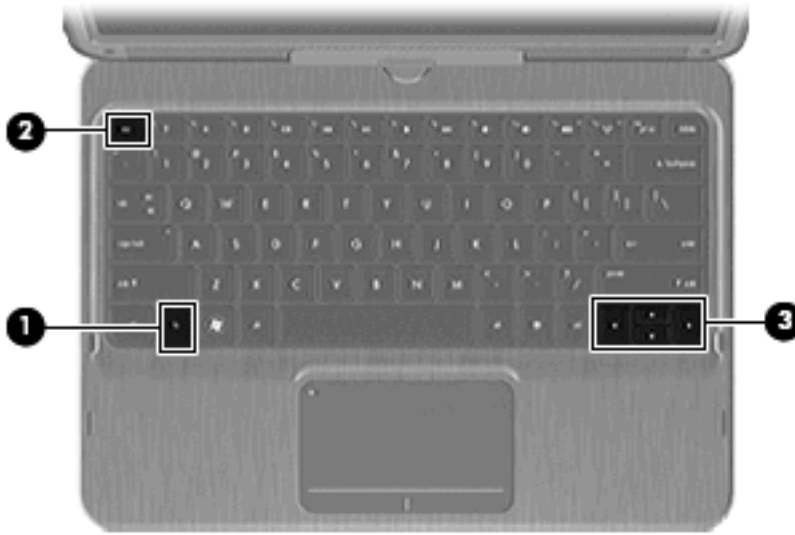

	Hotkey	Description
Display system information.	fn+esc	Displays information about system hardware components and the system BIOS version number.
▲ Scroll up.	fn+up arrow	Scrolls the page up.
▼ Scroll down.	fn+down arrow	Scrolls the page down.
◀ Go home.	fn+left arrow	Returns the cursor to the beginning of the line where the cursor is located or returns to the beginning of the document.
▶ Go to the end.	fn+right arrow	Places the cursor at the end of the line or scrolls to the end of the document.

To use a hotkey command, follow either of these steps:

- Briefly press the **fn** key, and then briefly press the second key of the hotkey command.
– or –
- Press and hold down the **fn** key, briefly press the second key of the hotkey command, and then release both keys at the same time.

4 Multimedia

Multimedia features

Your computer includes multimedia features that allow you to listen to music, watch movies, and view pictures. Your computer may include the following multimedia components:

- Integrated speakers for listening to music
- Integrated microphones for recording your own audio
- Integrated webcam that allows you to capture and share video
- Preinstalled multimedia software that allows you to play and manage your music, movies, and pictures
- Multimedia keys that provide fast access to multimedia tasks

The following sections explain how to use the multimedia components included with your computer.

Using the media activity keys

The media activity keys control the play of an audio CD or a DVD or BD that is inserted into an external optical drive (purchased separately).

- When an audio CD or a DVD is not playing, press the [play/pause](#) key **(2)** to play the disc.
- When an audio CD or a DVD is playing, use the following keys:
 - To play the previous track of an audio CD or the previous chapter of a DVD, press the [previous track](#) key **(1)**.
 - To pause or resume playing the disc, press the [play/pause](#) key **(2)**.
 - To stop the disc, press the [stop](#) key **(3)**.
 - To play the next track of an audio CD or the next chapter of a DVD, press the [next track](#) key **(4)**.

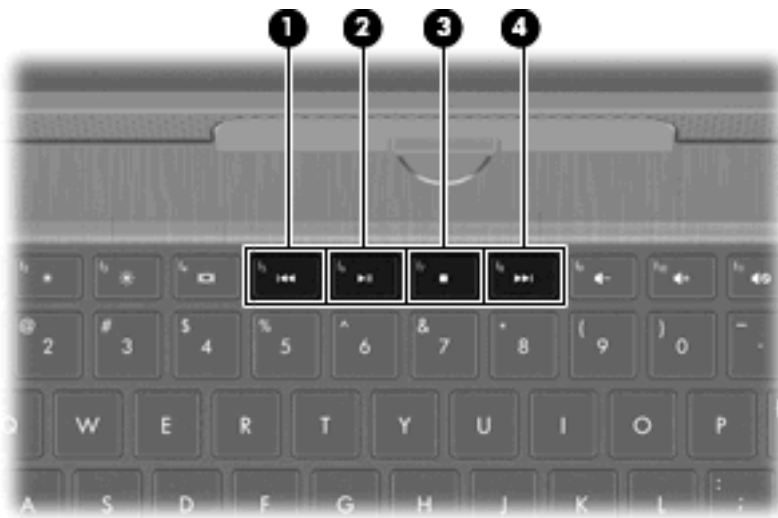

Multimedia software

The computer includes preinstalled multimedia software.

If you have an external optical drive (purchased separately), you can also perform the following multimedia tasks:

- Playing digital media, including audio and video CDs, audio and video DVDs
- Creating or copying data CDs
- Creating, editing, and burning audio CDs
- Creating, editing, and burning a video or movie to a DVD or video CD

Using HP TouchSmart software or HP MediaSmart software

Depending on your computer model, your computer has preinstalled HP TouchSmart or HP MediaSmart software. TouchSmart and MediaSmart turn your computer into a mobile entertainment center. You can enjoy music and DVD and BD movies. You can also manage and edit your photo collections.

TouchSmart and MediaSmart include the following features:

- With an Internet connection, play classic oldies, choose from a range of TV shows and channels, and watch the HP-TV channel streamed in full-screen.
- Photo and video upload support:
 - Upload your photos to an Internet photo service, such as Snapfish.
 - Upload your home videos directly to YouTube.
 - Upload videos you created with the webcam to the Internet.
- Pandora Internet radio (North America only)—Listen to music selected just for you, streamed from the Internet.

To start TouchSmart or MediaSmart:

- ▲ Double-tap the **TouchSmart** icon or the **MediaSmart** icon on the taskbar.

Using multimedia software

- ▲ Select **Start > All Programs**, and then open the multimedia program you want to use. For example, if you want to use Windows Media Player to play an audio CD, click **Windows Media Player**.

– or –

1. Insert a disc into an external optical drive (purchased separately).
An AutoPlay dialog box opens.
2. Click a multimedia task from the list, and then choose the software you want to use for that task.

Installing multimedia software from a disc

Although your computer does not have an integrated optical drive, you can easily access software, install applications, and access data in either of the following ways:

- Connect an external optical drive (select models only or purchased separately) to one of the USB ports on your computer.



NOTE: For additional information on external optical drives, refer to [Using external drives on page 77](#).

- Share the optical drive that is connected to another computer on your network.



NOTE: You must have a network set up in order to share an optical drive. For additional information on sharing optical drives, refer to [Sharing an optical drive on page 79](#).

NOTE: Some discs, such as DVD movies and game discs, may be copy-protected and therefore unusable through DVD or CD sharing.

Audio

Your computer enables you to use a variety of audio features:

- Play music using your computer speakers and/or connected external speakers
- Record sound using the internal microphone or connect an external microphone
- Download music from the Internet
- Create multimedia presentations using audio and images
- Transmit sound and images with instant messaging programs
- Stream radio programs
- Create (burn) audio CDs with an optional optical drive

Adjusting the volume

You can adjust the volume using the computer volume keys.

- To decrease volume, press the **volume down** key (1).
- To increase volume, press the **volume up** key (2).
- To mute or restore speaker sound, press the **mute** key (3).

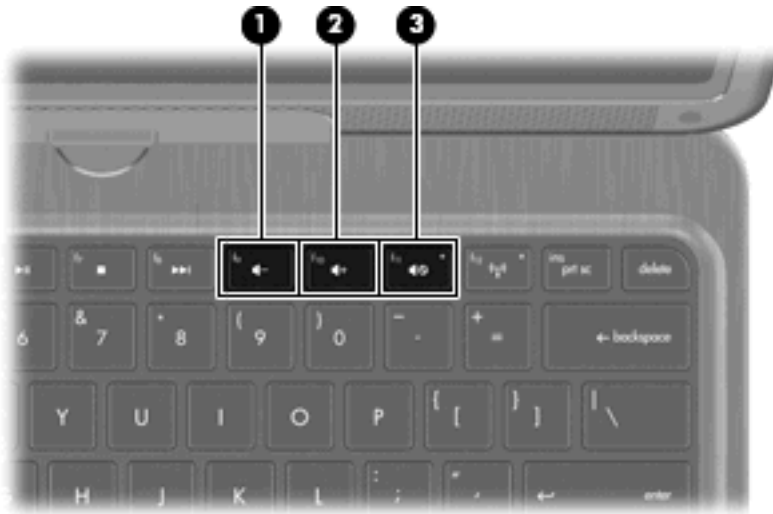

 **NOTE:** Volume can also be controlled through the Windows operating system and some programs.

Connecting external audio devices

 **WARNING!** To reduce the risk of personal injury, adjust the volume before putting on headphones, earbuds, or a headset. For additional safety information, refer to the *Regulatory, Safety and Environmental Notices*.

To connect external devices such as external speakers, headphones, earbuds, a headset, television audio, or a headset microphone, refer to the information provided with the device. For best results, remember the following tips:

- Be sure that the device cable has a 4-conductor connector that supports both audio-out (headphone) and audio-in (microphone).
- Be sure that the device cable is securely connected to the correct jack on your computer.
- Be sure to install any drivers required by the external device.



NOTE: A driver is a required program that acts like a translator between the device and the programs that use the device.

Webcam

Your computer includes an integrated webcam, located at the top of the display. The webcam allows you to capture and share video.

To use the webcam:

- ▲ Double-tap the **HP TouchSmart** icon or the **MediaSmart** icon on the taskbar, and then do one of the following:

- Tap the video icon **(1)** on the screen.

A window opens that displays a Webcam button.

- Tap the **Webcam** button.

 **NOTE:** In the video module, you can start the webcam, create a video, and upload your video to YouTube.

– or –

- ▲ Tap the small **Webcam** icon **(2)** at the bottom of the screen.



For optimum performance, observe the following guidelines while using the webcam:

- If you are having trouble viewing or sending multimedia files to someone on another LAN or outside your network firewall, temporarily disable the firewall, perform the task you want to perform, and then reenable the firewall. To permanently resolve the problem, reconfigure the firewall as necessary, and adjust the policies and settings of other intrusion detection systems.
- Whenever possible, place bright light sources behind the camera and out of the picture area.

Adjusting webcam properties

You can adjust webcam properties using the Properties dialog box, which is accessible from various programs that use the integrated camera, usually from a configuration, settings, or properties menu:

- **Brightness**—Controls the amount of light that is incorporated into the image. A higher brightness setting creates a brighter image; a lower brightness setting creates a darker image.
- **Contrast**—Controls the difference between lighter and darker areas on the image. A higher contrast setting intensifies the image; a lower contrast setting maintains more of the original information's dynamic range but leads to a flatter image.
- **Hue**—Controls the aspect of color that distinguishes it from another color (what makes a color red, green, or blue). Hue is distinct from saturation, which measures the intensity of the hue.
- **Saturation**—Controls the strength of color in the final image. A higher saturation setting creates a bolder image; a lower saturation setting creates a more subtle image.
- **Sharpness**—Controls the definition of edges in an image. A higher sharpness setting creates a more defined image; a lower sharpness setting creates a softer image.
- **Gamma**—Controls the contrast affecting the mid-level grays or midtones of an image. Adjusting the gamma of an image allows you to change the brightness values of the middle range of gray tones without dramatically altering the shadows and highlights. A lower gamma setting makes grays look black, and makes dark colors even darker.
- **Backlight Comp**—Compensates in cases where a subject with a large amount of background light would otherwise be obscured by blooming or silhouetting.

For more information about using the webcam, select **Start > Help and Support**.

Video

Your computer enables you to use a variety of video features:

- Watch movies
- Play games over the Internet
- Edit pictures and video and create presentations
- Connect external video devices
- Watch TV over the Internet

Using the external monitor port

The external monitor port connects an external display device, such as an external monitor or a projector, to the computer.

- ▲ To connect a display device, connect the device cable to the external monitor port.

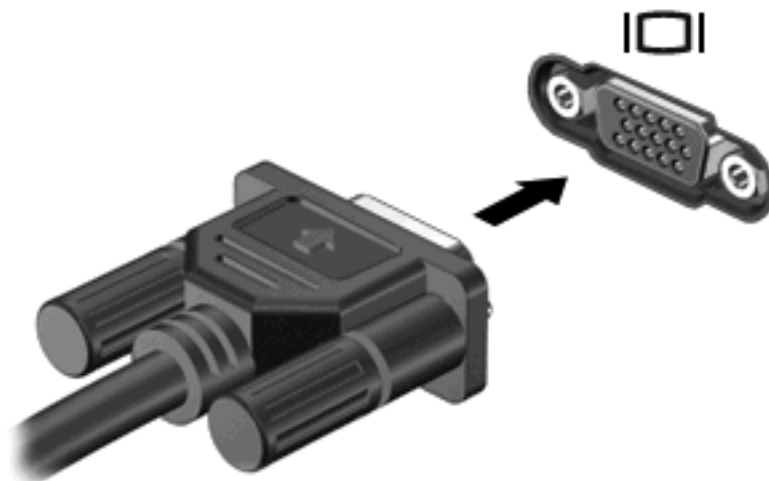

 **NOTE:** If a properly connected external display device does not display an image, press the [switch screen image](#) key to transfer the image to the device. Repeatedly pressing this key alternates the screen image between the computer display and the device.

Connecting an HDMI device

The computer includes an HDMI (High Definition Multimedia Interface) port. The HDMI port connects the computer to an optional video or audio device, such as a high-definition television, or any compatible digital or audio component.

 **NOTE:** To transmit video signals through the HDMI port, you need an HDMI cable (purchased separately).

The computer can support one HDMI device connected to the HDMI port, while simultaneously supporting an image on the computer display or any other supported external display.

To connect a video or audio device to the HDMI port:

1. Connect one end of the HDMI cable to the HDMI port on the computer.

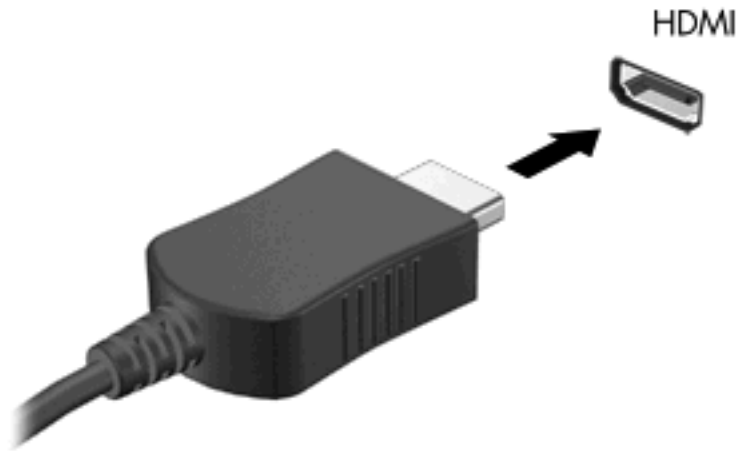

2. Connect the other end of the cable to the video device, according to the device manufacturer's instructions.
3. Press the [switch screen image](#) key on the computer to switch the image between the display devices connected to the computer.

Configuring audio for HDMI

To configure HDMI audio, first connect an audio or video device, such as a high-definition TV, to the HDMI port on your computer. Then configure the default audio playback device as follows:

1. Right-click the **Speakers** icon in the notification area, at the far right of the taskbar, and then click **Playback devices**.
2. On the **Playback** tab, click either **Digital Output** or **Digital Output Device (HDMI)**.
3. Click **Set Default**, and then click **OK**.

To return audio to the computer speakers, follow these steps:

1. Right-click the **Speakers** icon in the notification area, at the far right of the taskbar, and then click **Playback devices**.
2. On the **Playback** tab, click **Speakers**.
3. Click **Set Default**, and then click **OK**.

5 Power management

Shutting down the computer

△ **CAUTION:** Unsaved information will be lost when the computer is shut down.

The Shut down command closes all open programs, including the operating system, and then turns off the display and computer.

Shut down the computer under any of the following conditions:

- When you need to replace the battery or access components inside the computer
- When you are connecting an external hardware device that does not connect to a USB port
- When the computer will be unused and disconnected from external power for an extended period

Although you can shut down the computer with the power switch, the recommended procedure is to use the Windows Shut down command.

To shut down the computer:

📝 **NOTE:** If the computer is in the Sleep state or in Hibernation, you must first exit Sleep or Hibernation before shutdown is possible.

1. Save your work and close all open programs.
2. Click **Start**.
3. Click **Shut down**.

If the computer is unresponsive and you are unable to use the preceding shutdown procedures, try the following emergency procedures in the sequence provided:

- Press **ctrl+alt+delete**, and then click the **Power** button.
- Slide and hold the power switch for at least 5 seconds.
- Disconnect the computer from external power and remove the battery.

Setting power devices

Using power-saving states

The computer has two power-saving states enabled at the factory: Sleep and Hibernation.

When Sleep is initiated, the power light blinks and the screen clears. Your work is saved to memory, letting you exit Sleep faster than exiting Hibernation. If the computer is in the Sleep state for an extended period or if the battery reaches a critical battery level while in the Sleep state, the computer initiates Hibernation.

When Hibernation is initiated, your work is saved to a hibernation file on the hard drive and the computer turns off.

 **CAUTION:** To prevent possible audio and video degradation, loss of audio or video playback functionality, or loss of information, do not initiate Sleep or Hibernation while reading from or writing to a disc or an external media card.

 **NOTE:** You cannot initiate any type of networking connection or perform any computer functions while the computer is in the Sleep state or in Hibernation.

Initiating and exiting Sleep

The system is set at the factory to initiate Sleep after 15 minutes of inactivity when running on battery power and 30 minutes of inactivity when running on external power.

Power settings and timeouts can be changed using Power Options in Windows® Control Panel.

With the computer on, you can initiate Sleep in any of the following ways:

- Briefly slide the power switch.
- Close the display.
- Click **Start**, click the arrow next to the Shut down button, and then click **Sleep**.

You can exit Sleep in any of the following ways:

- Briefly slide the power switch.
- If the display is closed, open the display.
- Press a key on the keyboard.
- Activate the TouchPad.

When the computer exits Sleep, the power light turns on and your work returns to the screen where you stopped working.

 **NOTE:** If you have set a password to be required on wakeup, you must enter your Windows password before your work will return to the screen.

Initiating and exiting Hibernation

The system is set at the factory to initiate Hibernation after 1,080 minutes (18 hours) of inactivity when running on battery power, 1,080 minutes (18 hours) of inactivity when running on external power, or when the battery reaches a critical battery level.

Power settings and timeouts can be changed using Power Options in Windows Control Panel.

To initiate Hibernation:

- ▲ Click **Start**, click the arrow next to the Shut down button, and then click **Hibernate**.

To exit Hibernation:

- ▲ Briefly slide the power switch.

The power light turns on and your work returns to the screen where you stopped working.

 **NOTE:** If you have set a password to be required on wakeup, you must enter your Windows password before your work will return to the screen.

Conserving power

- Select the Power saver power plan through Power Options under **System and Security** in Windows Control Panel.
- Turn off wireless and local area network (LAN) connections and exit modem applications when you are not using them.
- Disconnect external devices that are not plugged into an external power source, when you are not using them.
- Stop, disable, or remove any external media cards that you are not using.
- Use the screen brightness keys to adjust screen brightness as needed.
- If you leave your work, initiate Sleep or Hibernation, or shut down the computer.

Using the battery meter

The battery meter is located in the notification area, at the far right of the taskbar. The battery meter allows you to quickly access power settings, view remaining battery charge, and select a different power plan.

- To display the percentage of remaining battery charge and the current power plan, move the pointer over the battery meter icon.
- To access Power Options, or to change the power plan, click the battery meter icon and select an item from the list.

Different battery meter icons indicate whether the computer is running on battery or external power. The icon also displays a message if the battery has reached a low battery level, critical battery level, or reserve battery level.

To hide or display the battery meter icon:

1. Right-click the **Show hidden icons** icon (the arrow at the left side of the notification area).
2. Click **Customize notification icons**.
3. Under **Behaviors**, select **Show icon and notifications** for the Power icon.
4. Click **OK**.

Using power plans

A power plan is a collection of system settings that manages how the computer uses power. Power plans can help you conserve power or maximize performance.

You can change power plan settings or create your own power plan.

Viewing the current power plan

▲ Click the battery meter icon in the notification area, at the far right of the taskbar.

– or –

Select **Start > Control Panel > System and Security > Power Options**.

Selecting a different power plan

▲ Click the battery meter icon in the notification area, and then select a power plan from the list.

– or –

Select **Start > Control Panel > System and Security > Power Options**, and then select a power plan from the list.

Customizing power plans

1. Click the battery meter icon in the notification area, and then click **More power options**.

– or –

Select **Start > Control Panel > System and Security > Power Options**.

2. Select a power plan, and then click **Change plan settings**.

3. Change the settings as needed.

4. To change additional settings, click **Change advanced power settings** and make your changes.

Setting password protection on wakeup

To set the computer to prompt for a password when the computer exits Sleep or Hibernation, follow these steps:

1. Select **Start > Control Panel > System and Security > Power Options**.

2. In the left pane, click **Require a password on wakeup**.

3. Click **Change Settings that are currently unavailable**.

4. Click **Require a password (recommended)**.

 **NOTE:** If you need to create a user account password or change your current user account password, click **Create or change your user account password**, and then follow the on-screen instructions. If you do not need to create or change a user account password, go to step 5.

5. Click **Save changes**.

Using battery power

When a charged battery is in the computer and the computer is not plugged into external power, the computer runs on battery power. When the computer is plugged into external AC power, the computer runs on AC power.

If the computer contains a charged battery and is running on external AC power supplied through the AC adapter, the computer switches to battery power if the AC adapter is disconnected from the computer.

 **NOTE:** The display brightness is decreased to save battery life when you disconnect AC power. To increase display brightness, press the [screen brightness up](#) key or reconnect the AC adapter.

You can keep a battery in the computer or in storage, depending on how you work. Keeping the battery in the computer whenever the computer is plugged into AC power charges the battery and also protects your work in case of a power outage. However, a battery in the computer slowly discharges when the computer is off and unplugged from external power.

 **WARNING!** To reduce potential safety issues, use only the battery provided with the computer, a replacement battery provided by HP, or a compatible battery purchased from HP.

Computer battery life varies, depending on power management settings, programs running on the computer, display brightness, external devices connected to the computer, and other factors.

Finding battery information in Help and Support

Help and Support provides the following tools and information about the battery:

- Battery Check tool to test battery performance
- Information on calibration, power management, and proper care and storage to maximize battery life
- Information on battery types, specifications, life cycles, and capacity

To access battery information:

- ▲ Select **Start > Help and Support > Learn > Power Plans: Frequently Asked Questions**.

Using Battery Check

Help and Support provides information on the status of the battery installed in the computer.

To run Battery Check:

1. Connect the AC adapter to the computer.

 **NOTE:** The computer must be connected to external power for Battery Check to function properly.

2. Select **Start > Help and Support > Troubleshoot > Power, Thermal and Mechanical**.
3. Click the **Power** tab, and then click **Battery Check**.

Battery Check examines the battery and its cells to see if they are functioning properly, and then reports the results of the examination.

Displaying the remaining battery charge

- ▲ Move the pointer over the battery meter icon in the notification area, at the far right of the taskbar.

Removing or inserting the battery

- △ **CAUTION:** Removing a battery that is the sole power source can cause loss of information. To prevent loss of information, initiate Hibernation or shut down the computer through Windows before removing the battery.

To remove the battery:

1. Close the display and turn the computer upside down on a flat surface.
2. Slide the battery release latch (1) to release the battery.

 **NOTE:** The battery release latch automatically returns to its original position.

3. Pivot the battery (2) upward and remove it from the computer (3).

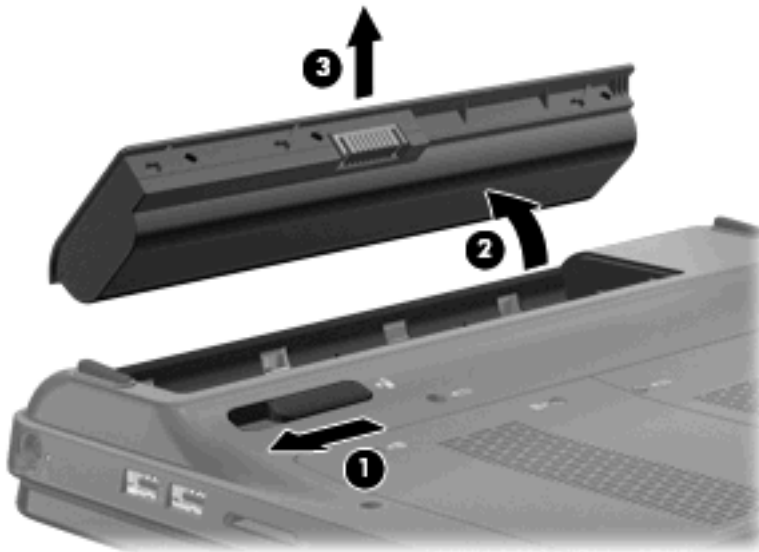

To insert the battery:

1. Close the display and turn the computer upside down on a flat surface.

2. Align the tabs on the battery with the notches on the outer edge of the battery bay (1), and rotate the battery into the battery bay until it is seated (2).

The battery release latch (3) automatically locks the battery into place.

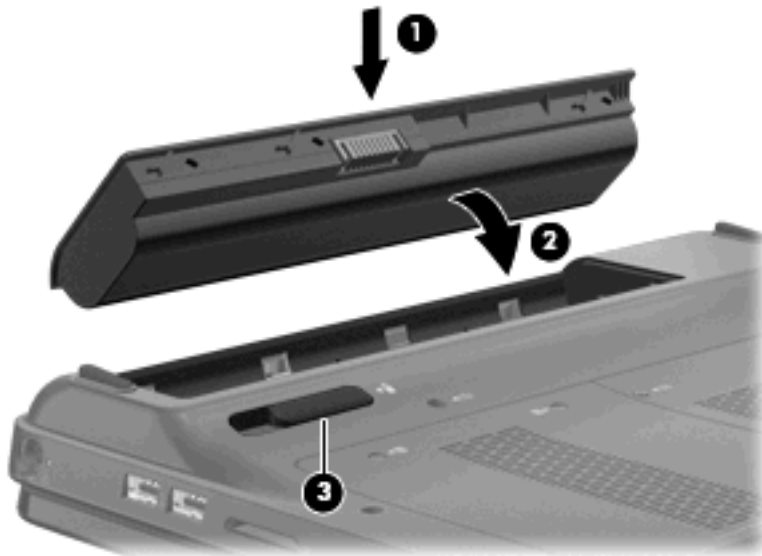

Charging a battery

⚠ WARNING! Do not charge the computer battery while you are onboard aircraft.

The battery charges whenever the computer is plugged into external power through an AC adapter or an optional power adapter.

The battery charges whether the computer is off or in use, but it charges faster when the computer is off.

Charging may take longer if a battery is new, has been unused for 2 weeks or more, or is much warmer or cooler than room temperature.

To prolong battery life and optimize the accuracy of battery charge displays, follow these recommendations:

- If you are charging a new battery, charge it fully before turning on the computer.
- Charge the battery until the battery light turns white.

📄 NOTE: If the computer is on while the battery is charging, the battery meter in the notification area may show 100 percent charge before the battery is fully charged.

- Allow the battery to discharge below 5 percent of a full charge through normal use before charging it.
- If the battery has been unused for one month or more, calibrate the battery instead of simply charging it.

The battery light on the computer displays the following charge status:

- Off: The computer is running on battery power.
- Blinking amber: The battery has reached a low battery level, a critical battery level, or there is a battery error.
- Amber: The battery is charging.
- White: The computer is connected to external power and the battery is fully charged.

Maximizing battery discharge time

Battery discharge time varies depending on the features you use while on battery power. Maximum discharge time gradually shortens, as the battery storage capacity naturally degrades.

Tips for maximizing battery discharge time:

- Lower the brightness on the display.
- Check the **Power saver** setting in Power Options.
- Remove the battery from the computer when it is not being used or charged.
- Store the battery in a cool, dry location.

Managing low battery levels

The information in this section describes the alerts and system responses set at the factory. Some low-battery alerts and system responses can be changed using Power Options in Windows Control Panel. Preferences set using Power Options do not affect lights.

Identifying low battery levels

When a battery that is the sole power source for the computer reaches a low or critical battery level, the battery meter icon in the notification area shows a low or critical battery notification.

When the battery reaches a critical battery level, a notification appears above the battery meter icon that shows how much battery charge remains.

 **NOTE:** For additional information on the battery meter, refer to [Using the battery meter on page 52](#).

The computer takes the following actions for a critical battery level:

- If Hibernation is enabled and the computer is on or in the Sleep state, the computer initiates Hibernation.
- If Hibernation is disabled and the computer is on or in the Sleep state, the computer remains briefly in the Sleep state, and then shuts down and loses any unsaved information.

Resolving a low battery level

△ **CAUTION:** To reduce the risk of losing information when the computer reaches a critical battery level and has initiated Hibernation, do not restore power until the power light turns off.

Resolving a low battery level when external power is available

- ▲ Connect one of the following devices:
 - AC adapter
 - Optional power adapter purchased as an accessory from HP

Resolving a low battery level when a charged battery is available

1. Turn off the computer or initiate Hibernation.
2. Remove the discharged battery, and then insert a charged battery.
3. Turn on the computer.

Resolving a low battery level when no power source is available

- ▲ Initiate Hibernation.
 - or –
 - Save your work and shut down the computer.

Resolving a low battery level when the computer cannot exit Hibernation

When the computer lacks sufficient power to exit Hibernation, follow these steps:

1. Insert a charged battery or plug the computer into external power.
2. Exit Hibernation by sliding the power switch.

Calibrating a battery

To maximize battery performance, you should calibrate a battery under the following conditions:

- When battery charge displays seem inaccurate
- When you observe a significant change in battery run time

Even if a battery is heavily used, it should not need to be calibrated more than once a month. It is also not necessary to calibrate a new battery.

- ▲ To calibrate a battery and for additional information, select **Start > Help and Support**.

Storing a battery

△ **CAUTION:** To prevent damage to a battery, do not expose it to high temperatures for extended periods of time.

If a computer will be unused and unplugged from external power for more than 2 weeks, remove the battery and store it separately.

To prolong the charge of a stored battery, place it in a cool, dry place.

Calibrate a battery before using it if it has been stored for one month or more.

 **NOTE:** A stored battery should be checked every 6 months. If the capacity is less than 50 percent, recharge the battery before returning it to storage.

Disposing of a used battery

 **WARNING!** To reduce the risk of fire or burns, do not disassemble, crush, or puncture; do not short external contacts; do not dispose of in fire or water.

Refer to the *Regulatory, Safety and Environmental Notices* for proper battery disposal.

Replacing the battery

Computer battery life varies, depending on power management settings, programs running on the computer, display brightness, external devices connected to the computer, and other factors.

Battery Check notifies you to replace the battery when an internal cell is not charging properly, or when the battery storage capacity has reached a “weak” condition. A message refers you to the HP Web site for more information about ordering a replacement battery. If the battery is possibly covered by an HP warranty, instructions include a warranty ID.

 **NOTE:** To ensure that you always have battery power when you need it, HP recommends purchasing a new battery when the storage capacity indicator turns green-yellow.

Switching between graphics modes (select models only)

Your computer is equipped with switchable graphics and has two modes for processing graphics. When you switch from AC power to battery power, the computer can switch from using the High-performance mode to using the Power-saving mode to conserve battery life. Similarly, when you switch from battery power to AC power, the computer can switch back to the High-performance mode.

 **NOTE:** In some instances, in order to optimize performance of the computer, the system will not allow you to switch modes, or it may prompt you to switch. It may also be necessary to close all programs before switching.

NOTE: HDMI only works in the High-performance mode. If you use the Power-saving mode, you will not be able to use HDMI.

When you switch between AC and battery power, you are notified that the computer is about to switch graphics modes. If you prefer, you can choose to continue using the same graphics mode. While the computer switches modes, the screen goes blank for a few seconds. When the switch is complete, a notification appears in the notification area, and the screen image reappears.

 **NOTE:** When select computer models are in slate mode, the screen orientations are reset when you switch between graphics modes.

To determine which graphics mode you are using:

- ▲ Right-click on the Windows desktop, and then click **Configure Switchable Graphics**.

Using external AC power

External AC power is supplied through an approved AC adapter.

-
- ⚠ **WARNING!** To reduce potential safety issues, use only the AC adapter provided with the computer, a replacement AC adapter provided by HP, or a compatible AC adapter purchased from HP.
-

Connect the computer to external AC power under any of the following conditions:

- When you are charging or calibrating a battery

⚠ **WARNING!** Do not charge the computer battery while you are onboard aircraft.

- When you are installing or modifying system software
- When you are writing information to an optional external CD or DVD

When you connect the computer to external AC power, the following events occur:

- The battery begins to charge.
- If the computer is turned on, the battery meter icon in the notification area changes appearance.

When you disconnect external AC power, the following events occur:

- The computer switches to battery power.
- The display brightness is automatically decreased to save battery life. To increase display brightness, press the [screen brightness up](#) key or reconnect the AC adapter.

Connecting AC power

-
- ⚠ **WARNING!** To reduce the risk of electric shock or damage to the equipment:
-

Plug the power cord into an AC outlet that is easily accessible at all times.

Disconnect power from the computer by unplugging the power cord from the AC outlet (not by unplugging the power cord from the computer).

If provided with a 3-pin attachment plug on the power cord, plug the cord into a grounded (earthed) 3-pin outlet. Do not disable the power cord grounding pin, for example, by attaching a 2-pin adapter. The grounding pin is an important safety feature.

To connect the computer to external AC power:

1. Plug the adapter into the power connector **(1)** on the computer.
2. Plug the power cord into the adapter **(2)**.

3. Plug the other end of the power cord into an AC outlet (3).

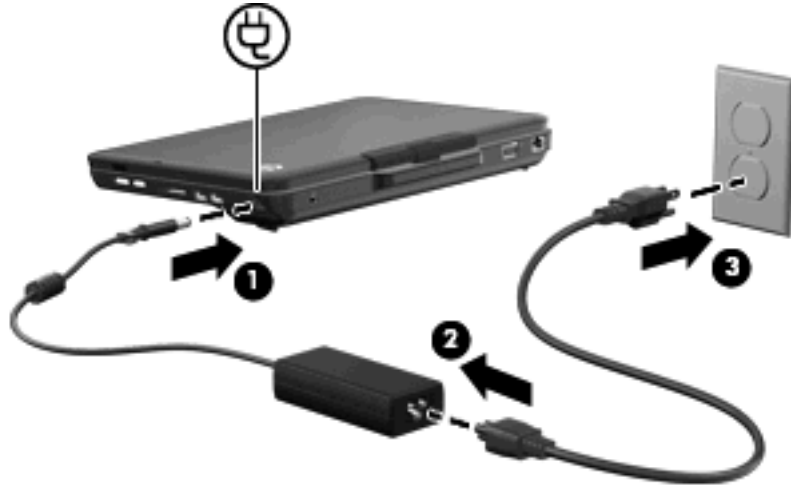

Testing an AC adapter

Test the AC adapter if the computer exhibits any of the following symptoms when it is connected to AC power:

- The computer will not turn on.
- The display does not turn on.
- The power light is off.

To test the AC adapter:

1. Remove the battery from the computer.
2. Connect the AC adapter to the computer, and then plug it into an AC outlet.
3. Turn on the computer.
 - If the power light turns **on**, the AC adapter is working properly.
 - If the power light remains **off**, the AC adapter is not functioning and should be replaced.

Contact technical support for information on obtaining a replacement AC power adapter. Select **Start > Help and Support > Get assistance**.

6 External devices

Using Digital Media Slot cards

Optional digital cards provide secure data storage and convenient data sharing. These cards are often used with digital media–equipped cameras and PDAs as well as with other computers.

The Digital Media Slot supports the following digital card formats:

- Memory Stick
- Memory Stick Pro
- MultiMediaCard
- Secure Digital Memory Card
- xD-Picture Card

Inserting a digital card

△ **CAUTION:** To prevent damage to the digital card connectors, use minimal force to insert a digital card.

1. Hold the digital card label-side up, with the connectors toward the computer.
2. Insert the card into the Digital Media Slot, and then push in on the card until it is firmly seated.

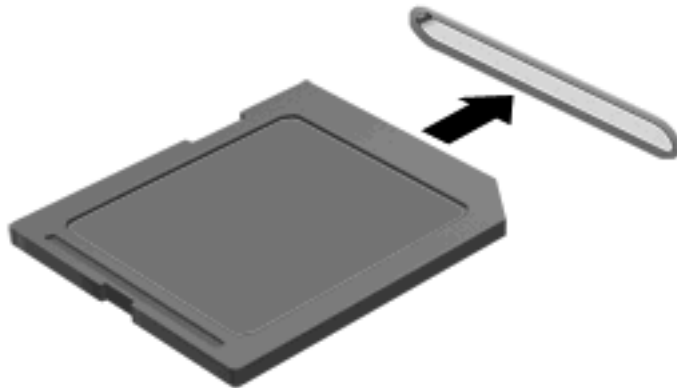

You will hear a sound when the device has been detected, and a menu of options may be displayed.

Removing a digital card

△ **CAUTION:** To prevent loss of data or an unresponsive system, use the following procedure to safely remove the digital card.

1. Save your information and close all programs associated with the digital card.

 **NOTE:** To stop a data transfer, click **Cancel** in the operating system Copying window.

2. To remove a digital card:

- a. Click the **Safely Remove Hardware and Eject Media** icon in the notification area, at the far right of the taskbar.

 **NOTE:** To display the Safely Remove Hardware and Eject Media icon, click the **Show hidden icons** icon (the arrow at the left of the notification area).

- b. Click the name of the digital card in the list.

 **NOTE:** You are prompted that it is safe to remove the hardware device.

3. Pull the digital card from the slot.

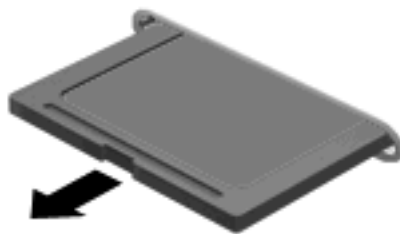

Using a USB device

A USB port connects an optional external device, such as a USB keyboard, mouse, drive, printer, scanner, or hub, to the computer.

Some USB devices may require additional support software, which is usually included with the device. For more information about device-specific software, refer to the manufacturer's instructions.

The computer has 3 USB ports, which support USB 1.0, USB 1.1, and USB 2.0 devices. To add more USB ports, connect an optional hub.

Connecting a USB device

△ **CAUTION:** To prevent damage to a USB connector, use minimal force to connect a USB device.

▲ To connect a USB device to the computer, connect the USB cable for the device to the USB port.



You will hear a sound when the device has been detected.

📝 **NOTE:** The first time you connect a USB device, the "Installing device driver software" message is displayed in the notification area, at the far right of the taskbar.

Removing a USB device

△ **CAUTION:** To prevent loss of information or an unresponsive system, use the following procedure to safely remove the USB device.

CAUTION: To prevent damage to a USB connector, do not pull on the cable to remove the USB device.

To remove a USB device:

1. Click the **Safely Remove Hardware and Eject Media** icon in the notification area, at the far right of the taskbar.

 **NOTE:** To display the Safely Remove Hardware and Eject Media icon, click the **Show hidden icons** icon (the arrow at the left of the notification area).

2. Click the name of the device in the list.

 **NOTE:** You are prompted that it is safe to remove the hardware device.

3. Remove the device.

7 Drives

Handling drives

Drives are fragile computer components that must be handled with care. Refer to the following cautions before handling drives. Additional cautions are included with the procedures to which they apply.

△ **CAUTION:** To reduce the risk of damage to the computer, damage to a drive, or loss of information, observe these precautions:

Before you move a computer that is connected to an external hard drive, initiate Sleep and allow the screen to clear, or properly disconnect the external hard drive.

Before handling a drive, discharge static electricity by touching the unpainted metal surface of the drive.

Do not touch the connector pins on a removable drive or on the computer.

Handle a drive carefully; do not drop a drive or place items on it.

Before removing or inserting a drive, shut down the computer. If you are unsure whether the computer is off, in the Sleep state, or in Hibernation, turn the computer on, and then shut it down through the operating system.

Do not use excessive force when inserting a drive into a drive bay.

Do not type on the keyboard or move the computer while the optical drive is writing to a disc. The write process is sensitive to vibration.

When the battery is the only source of power, be sure that the battery is sufficiently charged before writing to media.

Avoid exposing a drive to temperature or humidity extremes.

Avoid exposing a drive to liquids. Do not spray the drive with cleaning products.

Remove media from a drive before removing the drive from the drive bay, or traveling with, shipping, or storing a drive.

If a drive must be mailed, place the drive in a bubble-pack mailer or other suitable protective packaging and label the package "FRAGILE."

Avoid exposing a drive to magnetic fields. Security devices with magnetic fields include airport walk-through devices and security wands. The airport security devices that check carry-on luggage, such as conveyor belts, use X-rays instead of magnetism and will not damage a drive.

Improving hard drive performance

Using Disk Defragmenter

As you use the computer, files on the hard drive become fragmented. Disk Defragmenter consolidates the fragmented files and folders on the hard drive so that the system can run more efficiently.

 **NOTE:** It is not necessary to run Disk Defragmenter on solid-state drives.

To run Disk Defragmenter:

1. Select **Start > All Programs > Accessories > System Tools > Disk Defragmenter**.
2. Click **Defragment disk**.

 **NOTE:** Windows® includes the User Account Control feature to improve the security of your computer. You may be prompted for your permission or password for tasks such as installing applications, running utilities, or changing Windows settings. Refer to Help and Support for more information.

For additional information, access the Disk Defragmenter software Help.

Using Disk Cleanup

Disk Cleanup searches the hard drive for unnecessary files that you can safely delete to free up disk space and help the computer to run more efficiently.

To run Disk Cleanup:

1. Select **Start > All Programs > Accessories > System Tools > Disk Cleanup**.
2. Follow the on-screen instructions.

Using HP ProtectSmart Hard Drive Protection

HP ProtectSmart Hard Drive Protection protects a hard drive by parking the drive and halting data requests under either of the following conditions:

- You drop the computer.
- You move the computer with the display closed while the computer is running on battery power.

A short time after the end of one of these events, HP ProtectSmart Hard Drive Protection returns the hard drive to normal operation.

 **NOTE:** Because solid-state drives (SSD) lack moving parts, HP ProtectSmart Hard Drive Protection is unnecessary.

NOTE: Hard drives connected to USB ports are not covered by HP ProtectSmart Hard Drive Protection.

For more information, refer to the HP ProtectSmart Hard Drive Protection software Help.

Identifying HP ProtectSmart Hard Drive Protection status

The drive light on the computer turns amber to show that the drive is parked. To determine whether drives are currently protected or whether a drive is parked, select **Start > Control Panel > Hardware and Sound > Windows Mobility Center**:

- If the software is enabled, a green check mark is superimposed over the hard drive icon.
- If the software is disabled, a red X is superimposed over the hard drive icon.
- If the drives are parked, a yellow moon is superimposed over the hard drive icon.

The icon in the Mobility Center may not show the most up-to-date status for the drive. For immediate updates after a change in status, you need to enable the notification area icon.

To enable the notification area icon:

1. Select **Start > Control Panel > Hardware and Sound > HP ProtectSmart Hard Drive Protection**.

 **NOTE:** If prompted by User Account Control, click **Yes**.

2. On the **Icon in System Tray** row, click **Show**.
3. Click **OK**.

Managing power with a parked hard drive

If HP ProtectSmart Hard Drive Protection has parked the drive, the computer will behave in the following ways:

- The computer will not shut down.
- The computer will not initiate Sleep or Hibernation, except as described in the following Note.

 **NOTE:** If the computer is running on battery power and reaches a critical battery level, HP ProtectSmart Hard Drive Protection allows the computer to initiate Hibernation.

Before you move the computer, HP recommends that you either shut it down or initiate Sleep or Hibernation.

Using HP ProtectSmart Hard Drive Protection software

The HP ProtectSmart Hard Drive Protection software enables you to perform the following tasks:

- Enable and disable HP ProtectSmart Hard Drive Protection.

 **NOTE:** Depending on your user privileges, you may not be able to enable or disable HP ProtectSmart Hard Drive Protection. Additionally, members of an Administrator group can change the privileges for non-Administrator users.

- Determine whether a drive in the system is supported.

To open the software and change settings, follow these steps:

1. In Mobility Center, click the hard drive icon to open the HP ProtectSmart Hard Drive Protection window.

– or –

Select **Start > Control Panel > Hardware and Sound > HP ProtectSmart Hard Drive Protection**.

 **NOTE:** If prompted by User Account Control, click **Yes**.

2. Click the appropriate button to change settings.
3. Click **OK**.

Replacing a hard drive

△ **CAUTION:** To prevent information loss or an unresponsive system:

Shut down the computer before removing the hard drive from the hard drive bay. Do not remove the hard drive while the computer is on, in the Sleep state, or in Hibernation.

If you are not sure whether the computer is off or in Hibernation, turn the computer on by sliding the power switch. Then shut down the computer through the operating system.

To remove the hard drive:

1. Save your work.
2. Shut down the computer and close the display.
3. Disconnect all external devices connected to the computer.
4. Unplug the power cord from the AC outlet.
5. Turn the computer upside down on a flat surface.
6. Remove the battery from the computer.
7. Remove the memory module compartment cover:
 - a. Loosen the 2 memory module compartment cover screws **(1)**.
 - b. Remove the memory module compartment cover **(2)**.

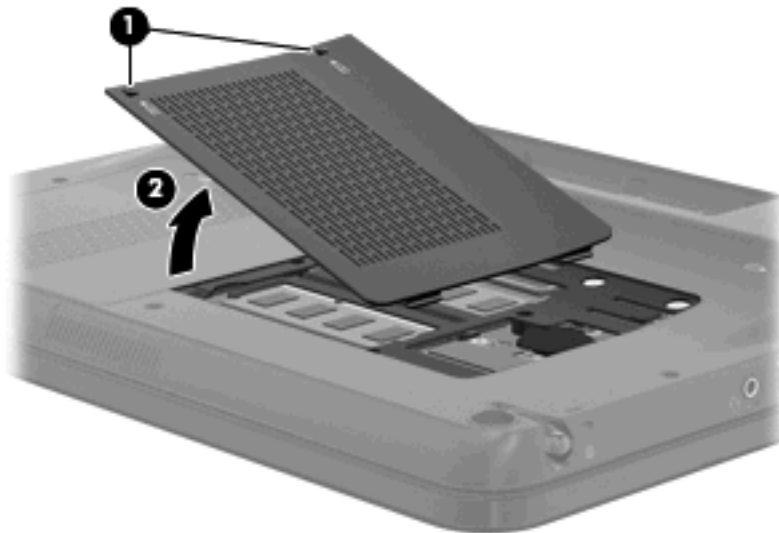

8. Remove the hard drive cover:
 - a. Loosen the 2 hard drive cover screws **(1)**.

- b. Remove the hard drive cover (2).

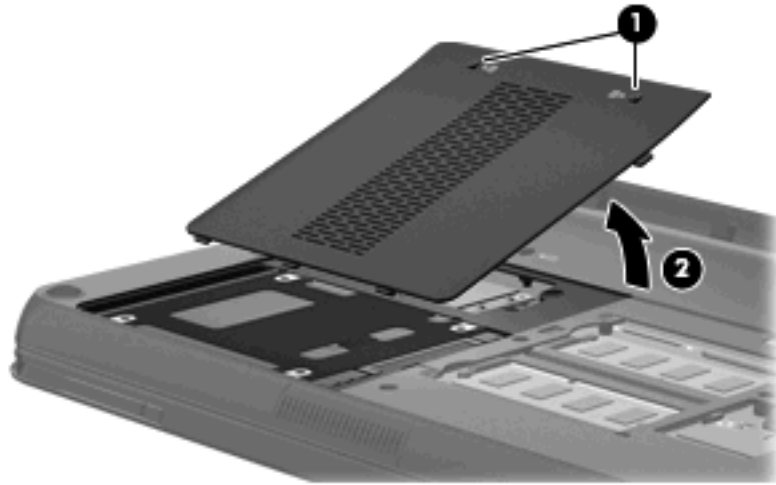

9. Pull the hard drive tab to the left (1) to disconnect the hard drive.
10. Lift the hard drive (2) out of the hard drive bay.

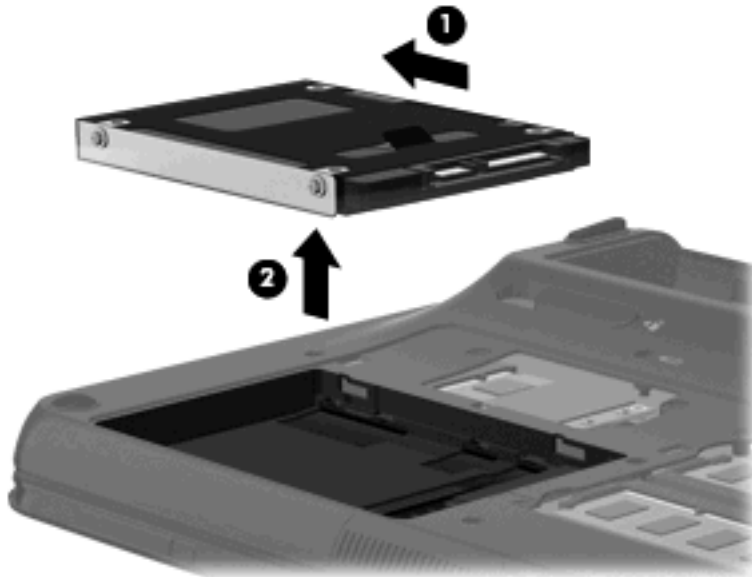

To install a hard drive:

1. Insert the hard drive into the hard drive bay (1).

2. Pull the hard drive tab (2) to the right until the hard drive snaps into place.

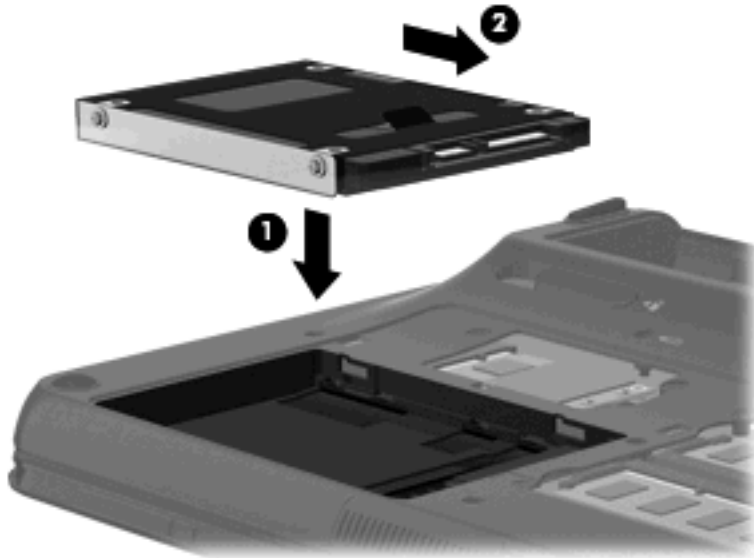

3. Replace the hard drive cover:
 - a. Align the tabs (1) on the hard drive cover with the notches on the computer.
 - b. Close the cover (2).
 - c. Tighten the hard drive cover screws (3).

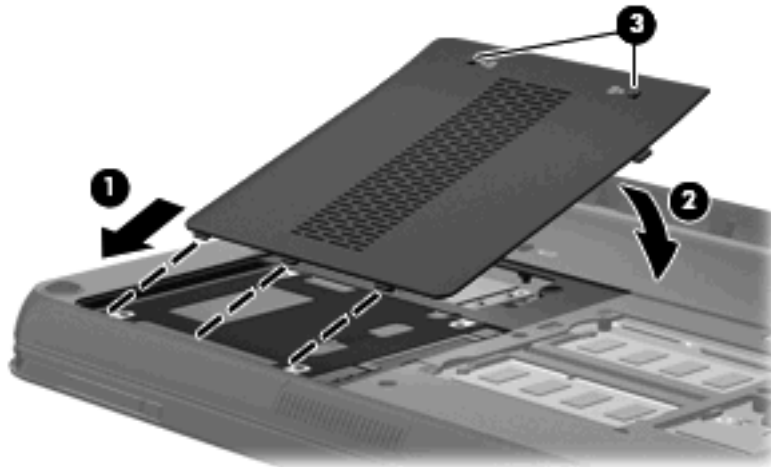

4. Replace the memory module compartment cover:
 - a. Align the tabs (1) on the memory module compartment cover with the notches on the computer.
 - b. Close the cover (2).

- c. Tighten the 2 memory module compartment cover screws (3).

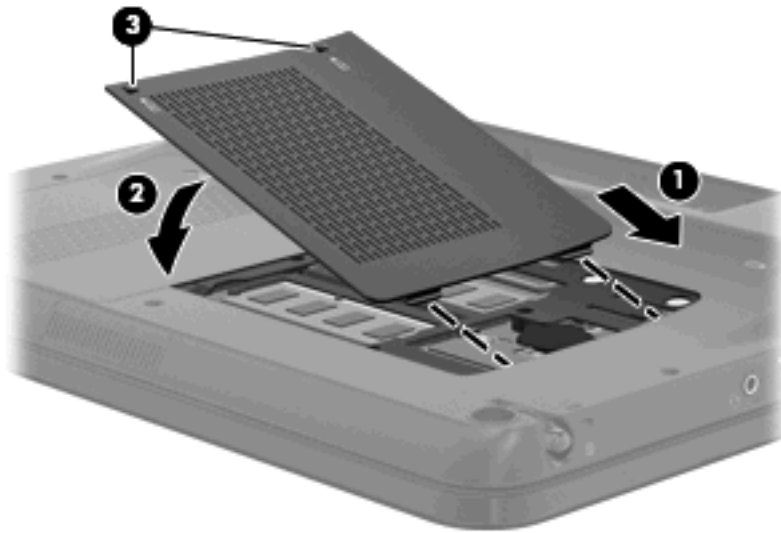

5. Replace the battery.
6. Turn the computer right-side up, and then reconnect external power and external devices.
7. Turn on the computer.

Using external drives

Removable external drives expand your options for storing and accessing information.

USB drives include the following types:

- 1.44-megabyte diskette drive
- Hard drive module (a hard drive with an adapter attached)
- DVD-ROM Drive
- DVD±RW SuperMulti Double-Layer (DL) Drive
- Blu-ray ROM DVD±R/RW SuperMulti Double-Layer (DL) Drive

Connecting optional external drives

 **NOTE:** For more information about required software and drivers, or to learn which computer port to use, refer to the manufacturer's instructions.

To connect an external drive to the computer:

 **CAUTION:** To reduce the risk of damage to the equipment when connecting a powered drive, be sure that the drive is turned off and the AC power cord is unplugged.

1. Connect the drive to the computer.
2. If you are connecting a powered drive, plug the device power cord into a grounded AC outlet.
3. Turn on the drive.

To disconnect an unpowered external drive, turn off the drive, and then disconnect it from the computer. To disconnect a powered external drive, turn off the drive, disconnect it from the computer, and then unplug the AC power cord.

Using an external optical drive (select models only)

Select computer models ship with an external optical drive. An external optical drive connects to a USB port on the computer and enables you to read data discs, play music, and watch movies. If your external optical drive is a Blu-ray Disc (BD) drive, you can also watch high-definition video from discs.

 **NOTE:** The external optical drive must be connected to the USB port *on the computer*, not to a USB port on another external device, such as a hub or docking station.

You may have one of the following types of drives:

- DVD±RW SuperMulti Double-Layer (DL) Drive
- Blu-ray ROM DVD±R/RW SuperMulti Double-Layer (DL) Drive

Removing an optical disc when the disc tray will not open

If the disc tray does not open, follow these steps:

1. Insert the end of a paper clip **(1)** into the release access in the front bezel of the drive.
2. Press in gently on the paper clip until the tray is released, and then pull out the tray **(2)** until it stops.

3. Remove the disc **(3)** from the tray by gently pressing down on the spindle while lifting the outer edges of the disc. Hold the disc by the edges and avoid touching the flat surfaces.

 **NOTE:** If the tray is not fully accessible, tilt the disc carefully as you remove it.

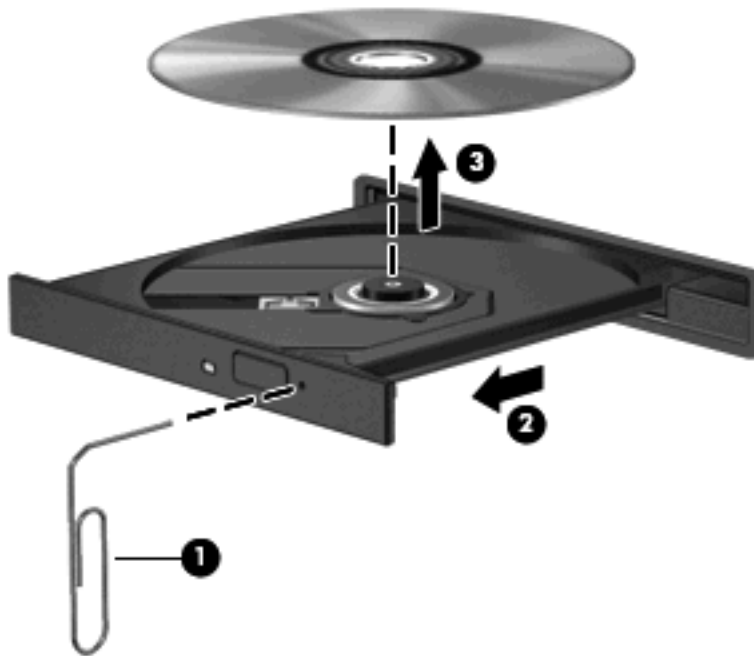

4. Close the disc tray and place the disc in a protective case.

Sharing an optical drive

Although your computer does not have an integrated optical drive, you can easily access software, install applications, and access data by sharing an optical drive connected to another computer in your network. Sharing drives is a feature of the Windows operating system that allows a drive on one computer to be accessible to other computers on the same network.

 **NOTE:** You must have a network set up in order to share an optical drive; refer to [Networking on page 11](#) for additional information on setting up a network.

NOTE: Some discs, such as DVD movies and game discs, may be copy-protected and therefore unusable through DVD or CD sharing.

To share an optical drive:

1. From the computer with the optical drive you are sharing, select **Start > Computer**.
2. Right-click the optical drive you want to share, and click **Properties**.
3. Select the **Sharing** tab > **Advanced Sharing**.
4. Select the **Share this folder** check box.
5. Type a name for the optical drive in the **Share name** text box.
6. Click **Apply**, and then click **OK**.
7. To view the shared optical drive on your computer, select **Start > Control Panel > Network and Internet > Network and Sharing Center**.

8 Memory modules

Adding or replacing memory modules

The computer has two memory module compartments, which are located on the bottom of the computer. The memory capacity of the computer can be upgraded by adding a memory module to the vacant expansion memory module slot or by upgrading the existing memory module in the primary memory module slot.

- ⚠ **WARNING!** To reduce the risk of electric shock and damage to the equipment, unplug the power cord and remove all batteries before installing a memory module.
- ⚠ **CAUTION:** Electrostatic discharge (ESD) can damage electronic components. Before beginning any procedure, ensure that you are discharged of static electricity by touching a grounded metal object.
- 📝 **NOTE:** To use a dual-channel configuration when adding a second memory module, be sure that both memory modules are the same size.

To add or replace a memory module:

1. Save your work.
2. Shut down the computer and close the display.

If you are not sure whether the computer is off or in Hibernation, turn the computer on by sliding the power switch. Then shut down the computer through the operating system.
3. Disconnect all external devices connected to the computer.
4. Unplug the power cord from the AC outlet.
5. Turn the computer upside down on a flat surface.
6. Remove the battery from the computer.
7. Loosen the 2 memory module compartment cover screws **(1)**.
8. Remove the memory module compartment cover **(2)**.

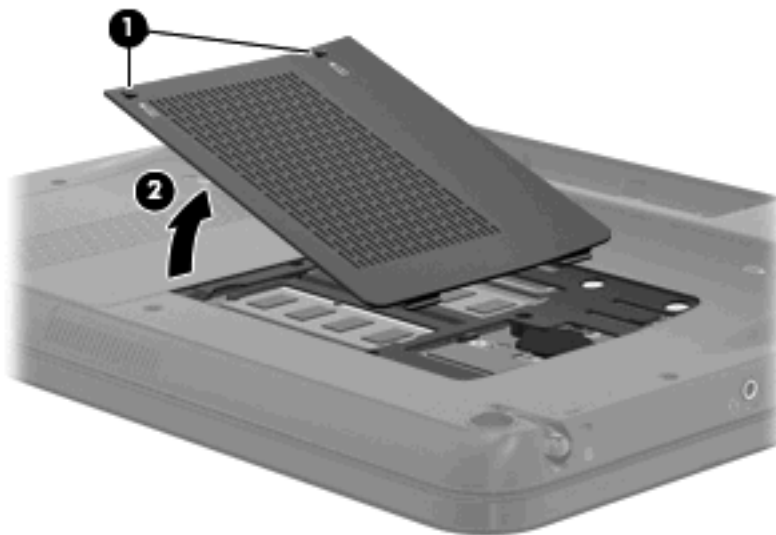

9. If you are replacing a memory module, remove the existing memory module:

- a. Pull away the retention clips (1) on each side of the memory module.

The memory module tilts up.

- b. Grasp the edge of the memory module (2), and gently pull the module out of the memory module slot.

△ **CAUTION:** To prevent damage to the memory module, hold the memory module by the edges only. Do not touch the components on the memory module.

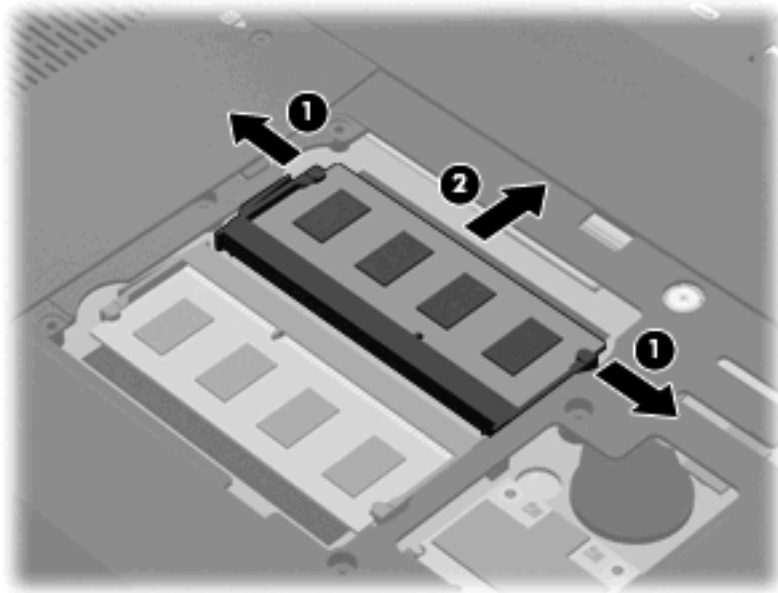

To protect a memory module after removal, place it in an electrostatic-safe container.

10. Insert a new memory module:

△ **CAUTION:** To prevent damage to the memory module, hold the memory module by the edges only. Do not touch the components on the memory module, and do not bend the memory module.

- a. Align the notched edge (1) of the memory module with the tab in the memory module slot.

- b. With the memory module at a 45-degree angle from the surface of the memory module compartment, press the module (2) into the memory module slot until it is seated.

- c. Gently press the memory module (3) down, applying pressure to both the left and right edges of the memory module, until the retention clips snap into place.

△ **CAUTION:** To prevent damage to the memory module, be sure that you do not bend the memory module.

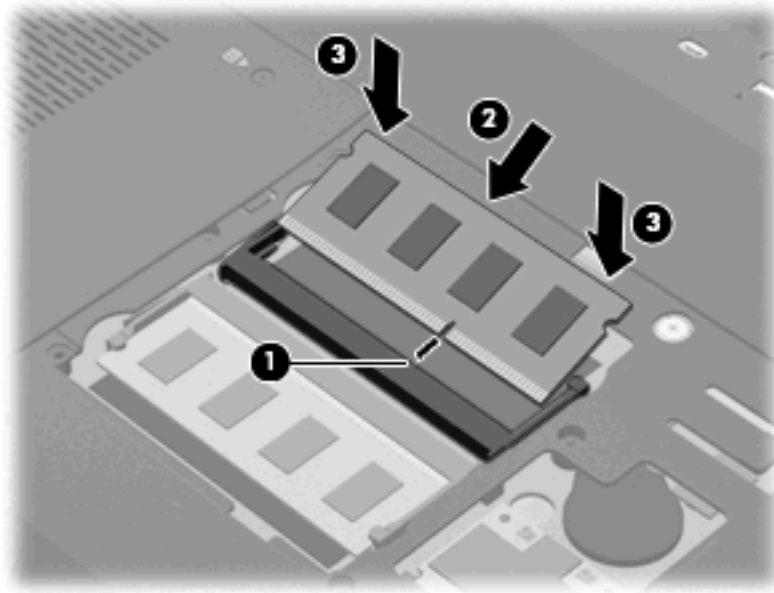

- 11. Align the tabs (1) on the memory module compartment cover with the notches on the computer.
- 12. Close the cover (2).
- 13. Tighten the 2 memory module compartment cover screws (3).

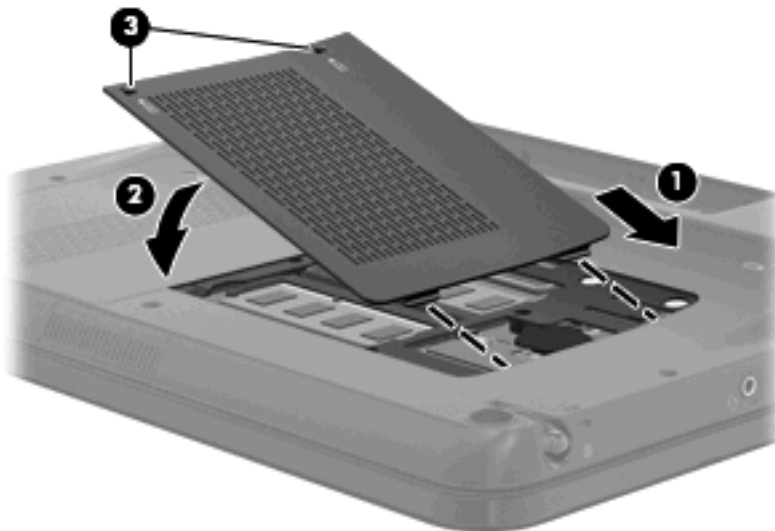

- 14. Replace the battery.
- 15. Turn the computer right-side up, and then reconnect external power and external devices.
- 16. Turn on the computer.

9 Security

Protecting the computer

Standard security features provided by the Windows® operating system and the non-Windows Setup Utility can protect your personal settings and data from a variety of risks.

Follow the procedures in this guide to use the following features:

- Passwords
- Antivirus software
- Firewall software
- Critical security updates
- Optional security cable
- Fingerprint reader (select models only)

 **NOTE:** Security solutions are designed to act as deterrents, but they may not deter software attacks or prevent the computer from being mishandled or stolen.

NOTE: Before you send your computer for service, remove all password and fingerprint settings.

Computer risk	Security feature
Unauthorized use of the computer	Power-on password or fingerprint reader
Computer viruses	Norton Internet Security software
Unauthorized access to data	<ul style="list-style-type: none">• Firewall software• Windows updates
Unauthorized access to Setup Utility, BIOS settings, and other system identification information	Administrator password
Ongoing or future threats to the computer	Critical security updates from Microsoft
Unauthorized access to a Windows user account	User password
Unauthorized removal of the computer	Security cable slot (used with an optional security cable)

Using passwords

A password is a group of characters that you choose to secure your computer information. Several types of passwords can be set, depending on how you want to control access to your information. Passwords can be set in Windows or in the non-Windows Setup Utility preinstalled on the computer.

- △ **CAUTION:** To prevent being locked out of the computer, record each password you set. Because most passwords are not displayed as they are set, changed, or deleted, it is essential to record each password immediately and store it in a secure place.

You can use the same password for a Setup Utility feature and for a Windows security feature. You can also use the same password for more than one Setup Utility feature.

Use the following guidelines when setting a password in Setup Utility:

- A password can be any combination of up to 8 letters and numbers and is case sensitive.
- A password set in Setup Utility must be entered at a Setup Utility prompt. A password set in Windows must be entered at a Windows prompt.

Use the following tips for creating and saving passwords:

- When creating passwords, follow requirements set by the program.
- Write down your passwords and store them in a secure place away from the computer.
- Do not store passwords in a file on the computer.
- Do not use your name or other personal information that could be easily discovered by an outsider.

The following sections list Windows and Setup Utility passwords and describe their functions. For additional information about Windows passwords, such as screen-saver passwords, select **Start > Help and Support**.

Setting passwords in Windows

Password

Administrator password

Protects administrator-level access to computer contents.

NOTE: This password cannot be used to access Setup Utility contents.

User password

Protects access to a Windows user account. It also protects access to the computer contents and must be entered when you exit Sleep or Hibernation.

Setting passwords in Setup Utility

Password

Administrator password*

- Protects access to Setup Utility.
- After this password is set, it must be entered each time you access Setup Utility.

CAUTION: If you forget your administrator password, you cannot access Setup Utility.

Password

Power-on password*

- Protects access to the computer contents.
- After this password is set, it must be entered each time you turn on or restart the computer, or exit Hibernation.

CAUTION: If you forget your power-on password, you cannot turn on or restart the computer, or exit Hibernation.

NOTE: The administrator password can be used in place of the power-on password.

*For details about each of these passwords, refer to the following topics.

Administrator password

Your administrator password protects the configuration settings and system identification information in Setup Utility. After this password is set, you must enter it each time you access Setup Utility.

Your administrator password is not interchangeable with an administrator password set in Windows, nor is it displayed as it is set, entered, changed, or deleted. Be sure that you record your password and store it in a safe place.

If you enter the administrator password at the first password check before the “Press the ESC key for Startup Menu” message is displayed, you do not have to enter it again to access Setup Utility.

If you enter the power-on password at the first password check before the “Press the ESC key for Startup Menu” message is displayed, you must enter the administrator password to access Setup Utility.

Managing an administrator password

To set, change, or delete this password, follow these steps:

1. Open Setup Utility by turning on or restarting the computer. While the “Press the ESC key for Startup Menu” message is displayed in the lower-left corner of the screen, press **f10**.

– or –

Open Setup Utility by turning on or restarting the computer. While the “Press the ESC key for Startup Menu” message is displayed in the lower-left corner of the screen, press **esc**. When the Startup Menu is displayed, press **f10**.

2. Use the arrow keys to select **Security > Set Administrator Password**, and then press **enter**.
 - To set an administrator password, type your password in the **Enter New Password** and **Confirm New Password** fields, and then press **enter**.
 - To change an administrator password, type your current password in the **Enter Current Password** field, type a new password in the **Enter New Password** and **Confirm New Password** fields, and then press **enter**.
 - To delete an administrator password, type your current password in the **Enter Password** field, and then press **enter** 4 times.
3. To save your changes and exit Setup Utility, use the arrow keys to select **Exit > Exit Saving Changes**.

Your changes go into effect when the computer restarts.

Entering an administrator password

At the **Enter Password** prompt, type your administrator password, and then press [enter](#). After 3 unsuccessful attempts to enter the administrator password, you must restart the computer and try again.

Power-on password

Your power-on password prevents unauthorized use of the computer. After this password is set, it must be entered each time you turn on or restart the computer, or exit Hibernation. A power-on password is not displayed as it is set, entered, changed, or deleted.

Managing a power-on password

To set, change, or delete this password, follow these steps:

1. Open Setup Utility by turning on or restarting the computer. While the “Press the ESC key for Startup Menu” message is displayed in the lower-left corner of the screen, press [f10](#).

– or –

Open Setup Utility by turning on or restarting the computer. While the “Press the ESC key for Startup Menu” message is displayed in the lower-left corner of the screen, press [esc](#). When the Startup Menu is displayed, press [f10](#).

2. Use the arrow keys to select **Security > Set Power-On Password**, and then press [enter](#).
 - To set a power-on password, type your password in the **Enter New Password** and **Confirm New Password** fields, and then press [enter](#).
 - To change a power-on password, type your current password in the **Enter Current Password** field, type a new password in the **Enter New Password** and **Confirm New Password** fields, and then press [enter](#).
 - To delete a power-on password, type your current password in the **Enter Current Password** field, and then press [enter](#) 4 times.
3. To save your changes and exit Setup Utility, use the arrow keys to select **Exit > Exit Saving Changes**.

Your changes go into effect when the computer restarts.

Entering a power-on password

At the **Enter Password** prompt, type your password, and then press [enter](#). After 3 unsuccessful attempts to enter the password, you must restart the computer and try again.

Using antivirus software

When you use the computer to access e-mail, a network, or the Internet, you expose it to computer viruses. Computer viruses can disable the operating system, programs, or utilities, or cause them to abnormally.

Antivirus software can detect most viruses, destroy them, and in most cases, repair any damage they have caused. To provide ongoing protection against newly discovered viruses, antivirus software must be kept up to date.

Norton Internet Security, an antivirus program, is preinstalled on the computer. The software includes 60 days of free updates. It is strongly recommended that you protect the computer against new viruses beyond 60 days by purchasing extended update service. Instructions for using and updating Norton Internet Security software and for purchasing extended update service are provided within the program. To view and access Norton Internet Security, select **Start > All Programs > Norton Internet Security**.

For more information about computer viruses, type `viruses` in the Search box in Help and Support.

Using firewall software

When you use the computer for e-mail, network, or Internet access, unauthorized persons may be able to gain access to the computer, your personal files, and information about you. Use the firewall software preinstalled on the computer to protect your privacy.

Firewall features include logging and reporting of network activity, and automatic monitoring of all incoming and outgoing traffic. Refer to the firewall user guide or contact your firewall manufacturer for more information.

 **NOTE:** Under some circumstances a firewall can block access to Internet games, interfere with printer or file sharing on a network, or block authorized e-mail attachments. To temporarily resolve the problem, disable the firewall, perform the task that you want to perform, and then reenable the firewall. To permanently resolve the problem, reconfigure the firewall.

Installing critical security updates

△ **CAUTION:** Microsoft sends alerts regarding critical updates. To protect the computer from security breaches and computer viruses, install all critical updates from Microsoft as soon as you receive an alert.

Updates to the operating system and other software may have become available after the computer was shipped. To be sure that all available updates are installed on the computer, observe these guidelines:

- Run Windows Update as soon as possible after you set up your computer. Use the update link at **Start > All Programs > Windows Update**.
- Run Windows Update monthly thereafter.
- Obtain updates to Windows and other Microsoft® programs, as they are released, from the Microsoft Web site and through the updates link in Help and Support.

Installing an optional security cable

 **NOTE:** A security cable is designed to act as a deterrent, but it may not prevent the computer from being mishandled or stolen.

1. Loop the security cable around a secured object.
2. Insert the key (1) into the cable lock (2).
3. Insert the cable lock into the security cable slot on the computer (3), and then lock the cable lock with the key.

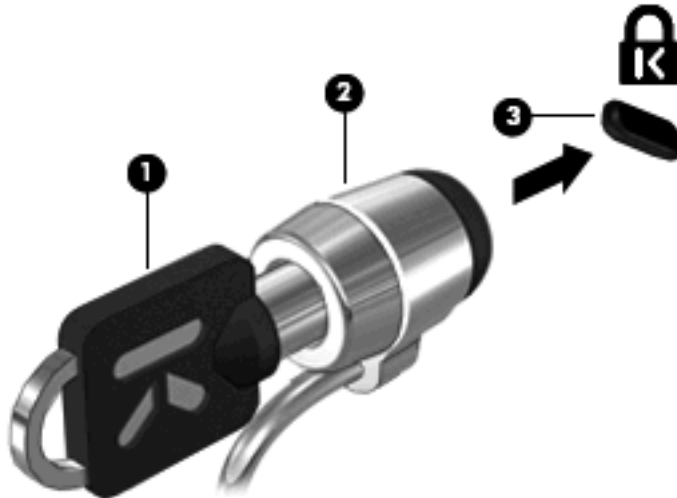

4. Remove the key and keep it in a safe place.

Using the fingerprint reader (select models only)

The fingerprint reader is a small metallic sensor that is located on the right side of the display.

Registering fingerprints

A fingerprint reader allows you to log on to Windows using a fingerprint that you have registered using DigitalPersona Personal software, instead of using a Windows password.

To register one or more fingerprints, follow these steps:

1. In Windows, click the **DigitalPersona Personal** icon in the notification area, at the far right of the taskbar.

2. Read the welcome text, and then click **Next**.

The “Verify Your Identity” page opens.

3. Type your Windows password, if one has been established, and then click **Next**.

 **NOTE:** If you do not have a Windows password, the “Protect Your Windows Account” page opens. You can create a Windows password at this time, or you can skip this step by clicking **Next**. However, setting a Windows password optimizes the security of your computer.

The “Fingerprint Registration Training” page opens.

4. View the demonstration, and then click **Next**.

The “Register a Fingerprint” page opens.

5. Click the finger on the screen that corresponds to the finger you want to register.

The next page opens, outlining that finger in green.

6. Slowly swipe your chosen finger over the fingerprint sensor.

 **NOTE:** If the swipe is not completed correctly, a message explains why the swipe was unsuccessful.

NOTE: For best results, swipe the same finger in the same direction each time you use the fingerprint reader.

7. Continue swiping the same finger over the fingerprint sensor until you have completed 4 successful swipes.

When the fingerprint is registered successfully, the “Register a Fingerprint” page opens again, allowing you to register more fingerprints. Repeat steps 5 through 7 to register additional fingerprints.

8. When you are finished registering fingerprints, click **Next**.

If you register only one fingerprint, a message recommends that you register additional fingerprints. Click **Yes** to register more fingerprints, and then repeat steps 1 through 8 for each fingerprint registered.

– or –

Click **No** if you do not want to register additional fingerprints. The “Registration Complete” page opens.

9. Click **Finish**.

 **NOTE:** Each user who wants fingerprint access to the computer must repeat steps 1 through 9.

Using your registered fingerprint to log on to Windows

To log on to Windows using your fingerprint, follow these steps:

1. Immediately after you have registered your fingerprints, restart Windows.
2. Swipe any of your registered fingers to log on to Windows.

10 Backup and recovery

Recovery after a system failure is as complete as your most current backup. HP recommends that you create recovery discs immediately after software setup. As you add new software and data files, you should continue to back up your system on a regular basis to maintain a reasonably current backup.

Tools provided by the operating system and HP Recovery Manager software are designed to help you with the following tasks for safeguarding your information and restoring it in case of a system failure:

- Creating a set of recovery discs (Recovery Manager software feature). Recovery discs are used to start up (boot) your computer and restore the operating system and software programs to factory settings in case of system failure or instability.
- Backing up your information regularly to protect your important system files.
- Creating system restore points (operating system feature). System restore points allow you to reverse undesirable changes to your computer by restoring the computer to an earlier state.
- Recovering a program or driver (Recovery Manager software feature). This feature helps you reinstall a program or driver without performing a full system recovery.
- Performing a full system recovery (Recovery Manager software feature). With Recovery Manager, you can recover your full factory image if you experience system failure or instability. Recovery Manager works from a dedicated recovery partition (select models only) on the hard drive or from recovery discs you create.

 **NOTE:** Computers with a solid-state drive (SSD) may not have a recovery partition. Recovery discs have been included for computers that do not have a partition. Use these discs to recover your operating system and software. To check for the presence of a recovery partition, click **Start**, right-click **Computer**, click **Manage**, and then click **Disk Management**. If the partition is present, an HP Recovery drive is listed in the window.

Creating recovery discs

HP recommends that you create recovery discs to be sure that you can restore your system to its original factory state if you experience serious system failure or instability. Create these discs after setting up the computer for the first time.

Handle these discs carefully and keep them in a safe place. The software allows the creation of only one set of recovery discs.

 **NOTE:** If your computer does not include an integrated optical drive, you can use an optional external optical drive (purchased separately) to create recovery discs, or you can purchase recovery discs for your computer from the HP Web site.

Note the following guidelines before creating recovery discs:

- You will need high-quality DVD-R, DVD+R, BD-R (writable Blu-ray), or CD-R discs. All these discs are purchased separately. DVDs and BDs have a much higher capacity than CDs. If you use CDs, up to 20 discs may be required, whereas only a few DVDs or BDs are required.

 **NOTE:** Read-write discs, such as CD-RW, DVD±RW, double-layer DVD±RW, and BD-RE (rewritable Blu-ray) discs, are not compatible with the Recovery Manager software.

- The computer must be connected to AC power during this process.
- Only one set of recovery discs can be created per computer.
- Number each disc before inserting it into the optical drive.
- If necessary, you can exit the program before you have finished creating the recovery discs. The next time you open Recovery Manager, you will be prompted to continue the disc creation process.

To create a set of recovery discs:

1. Select **Start > All Programs > Recovery Manager > Recovery Disc Creation**.
2. Follow the on-screen instructions.

Backing up your information

As you add new software and data files, you should back up your system on a regular basis to maintain a reasonably current backup. Back up your system at the following times:

- At regularly scheduled times

 **NOTE:** Set reminders to back up your information periodically.

- Before the computer is repaired or restored
- Before you add or modify hardware or software

Note the following when backing up:

- Create system restore points using the Windows® System Restore feature, and periodically copy them to disc.
- Store personal files in the Documents library and back up this folder periodically.
- Back up templates stored in their associated programs.
- Save customized settings in a window, toolbar, or menu bar by taking a screen shot of your settings. The screen shot can be a time-saver if you have to reset your preferences.

To copy the screen and paste it into a word-processing document, follow these steps:

1. Display the screen.
 2. Copy the screen:
 - To copy only the active window, press **alt+prt sc**.
 - To copy the entire screen, press **prt sc**.
 3. Open a word-processing document, and then select **Edit > Paste**.
 4. Save the document.
- You can back up your information to an optional external hard drive, a network drive, or discs.
 - When backing up to discs, use any of the following types of discs (purchased separately): CD-R, CD-RW, DVD+R, DVD-R, or DVD±RW. The discs you use will depend on the type of optical drive installed in your computer.
-
-  **NOTE:** DVDs store more information than CDs, so using them for backup reduces the number of recovery discs required.
-
- When backing up to discs, number each disc before inserting it into the optical drive of the computer.

Using Windows Backup and Restore

To create a backup using Windows Backup and Restore, follow these steps:

 **NOTE:** Be sure that the computer is connected to AC power before you start the backup process.

NOTE: The backup process may take over an hour, depending on file size and the speed of the computer.

1. Select **Start > All Programs > Maintenance > Backup and Restore**.
2. Follow the on-screen instructions to set up and create a backup.

 **NOTE:** Windows® includes the User Account Control feature to improve the security of your computer. You may be prompted for your permission or password for tasks such as installing software, running utilities, or changing Windows settings. Refer to Help and Support for more information.

Using system restore points

When you back up your system, you are creating a system restore point. A system restore point allows you to save and name a snapshot of your hard drive at a specific point in time. You can then recover back to that point if you want to reverse subsequent changes made to your system.

 **NOTE:** Recovering to an earlier restore point does not affect data files saved or e-mails created since the last restore point.

You also can create additional restore points to provide increased protection for your system files and settings.

When to create restore points

- Before you add or extensively modify software or hardware
- Periodically, whenever the system is performing optimally

 **NOTE:** If you revert to a restore point and then change your mind, you can reverse the restoration.

Create a system restore point

1. Select **Start > Control Panel > System and Security > System**.
2. In the left pane, click **System Protection**.
3. Click the **System Protection** tab.
4. Under **Protection Settings**, select the disk for which you want to create a restore point.
5. Click **Create**.
6. Follow the on-screen instructions.

Restore to a previous date and time

To revert to a restore point (created at a previous date and time), when the computer was functioning optimally, follow these steps:

1. Select **Start > Control Panel > System and Security > System**.
2. In the left pane, click **System protection**.
3. Click the **System Protection** tab.
4. Click **System Restore**.
5. Follow the on-screen instructions.

Performing a recovery

 **NOTE:** You can recover only files that you have previously backed up. HP recommends that you use HP Recovery Manager to create a set of recovery discs (entire drive backup) as soon as you set up your computer.

Recovery Manager software allows you to repair or restore the system if you experience system failure or instability. Recovery Manager works from recovery discs or from a dedicated recovery partition (select models only) on the hard drive. However, if your computer includes a solid-state drive (SSD), you may not have a recovery partition. If that is the case, recovery discs have been included with your computer. Use these discs to recover your operating system and software.

 **NOTE:** Windows has its own built-in repair features, such as System Restore. If you have not already tried these features, try them before using Recovery Manager.

NOTE: Recovery Manager recovers only software that was preinstalled at the factory. Software not provided with this computer must be downloaded from the manufacturer's Web site or reinstalled from the disc provided by the manufacturer.

Recovering from the recovery discs

To restore the system from the recovery discs:

1. Back up all personal files.
2. Insert the first recovery disc into an optional external optical drive and restart the computer.
3. Follow the on-screen instructions.

Recovering from the dedicated recovery partition (select models only)

 **NOTE:** Computers with an SSD may not have a recovery partition. If the computer does not have a recovery partition, you will not be able to recover using this procedure. Recovery discs have been included for computers that do not have a partition. Use these discs to recover your operating system and software.

On some models, you can perform a recovery from the partition on the hard drive, accessed by pressing either the **Start** button or **f11**. This restores the computer to its factory condition.

To restore the system from the partition, follow these steps:

1. Access Recovery Manager in either of the following ways:
 - Select **Start > All Programs > Recovery Manager > Recovery Manager**.
 - or –
 - Turn on or restart the computer, and then press **esc** while the “Press the ESC key for Startup Menu” message is displayed at the bottom of the screen. Then, press **f11** while the “Press <F11> for recovery” message is displayed on the screen.
2. Click **System Recovery** in the Recovery Manager window.
3. Follow the on-screen instructions.

11 Setup Utility (BIOS)

Starting Setup Utility

Setup Utility is a ROM-based information and customization utility that can be used even when your Windows® operating system is not working.

The utility reports information about the computer and provides settings for startup, security, and other preferences.

To start Setup Utility:

- ▲ Open Setup Utility by turning on or restarting the computer. While the “Press the ESC key for Startup Menu” message is displayed in the lower-left corner of the screen, press **f10**.

– or –

1. Open Setup Utility by turning on or restarting the computer. While the “Press the ESC key for Startup Menu” message is displayed in the lower-left corner of the screen, press **esc**.
2. When the Startup Menu is displayed, press **f10**.

Using Setup Utility

Changing the language of Setup Utility

The following procedure explains how to change the language of Setup Utility. If Setup Utility is not already running, begin at step 1. If Setup Utility is already running, begin at step 2.

1. Open Setup Utility by turning on or restarting the computer. While the “Press the ESC key for Startup Menu” message is displayed in the lower-left corner of the screen, press **f10**.

– or –

Open Setup Utility by turning on or restarting the computer. While the “Press the ESC key for Startup Menu” message is displayed in the lower-left corner of the screen, press **esc**. When the Startup Menu is displayed, press **f10**.

2. Use the arrow keys to select **System Configuration > Language**, and then press **enter**.
3. Use the arrow keys to select a language, and then press **enter**.
4. When a confirmation prompt with your language selected is displayed, press **enter**.
5. To save your change and exit Setup Utility, use the arrow keys to select **Exit > Exit Saving Changes**, and then press **enter**.

Your change goes into effect immediately.

Navigating and selecting in Setup Utility

Because Setup Utility is not Windows based, it does not support the TouchPad. Navigation and selection are by keystroke.

- To choose a menu or a menu item, use the arrow keys.
- To choose an item in a list or to toggle a field, for example an Enable/Disable field, use either the arrow keys or **f5** or **f6**.
- To select an item, press **enter**.
- To close a text box or return to the menu display, press **esc**.
- To display additional navigation and selection information while Setup Utility is open, press **f1**.

Displaying system information

The following procedure explains how to display system information in Setup Utility. If Setup Utility is not open, begin at step 1. If Setup Utility is open, begin at step 2.

1. Open Setup Utility by turning on or restarting the computer. While the “Press the ESC key for Startup Menu” message is displayed in the lower-left corner of the screen, press **f10**.

– or –

Open Setup Utility by turning on or restarting the computer. While the “Press the ESC key for Startup Menu” message is displayed in the lower-left corner of the screen, press **esc**. When the Startup Menu is displayed, press **f10**.
2. Select the **Main** menu. System information such as the system time and date, and identification information about the computer is displayed.
3. To exit Setup Utility without changing any settings, use the arrow keys to select **Exit > Exit Discarding Changes**, and then press **enter**.

Restoring default settings in Setup Utility

The following procedure explains how to restore the Setup Utility default settings. If Setup Utility is not already running, begin at step 1. If Setup Utility is already running, begin at step 2.

1. Open Setup Utility by turning on or restarting the computer. While the “Press the ESC key for Startup Menu” message is displayed in the lower-left corner of the screen, press **f10**.

– or –

Open Setup Utility by turning on or restarting the computer. While the “Press the ESC key for Startup Menu” message is displayed in the lower-left corner of the screen, press **esc**. When the Startup Menu is displayed, press **f10**.
2. Use the arrow keys to select **Exit > Load Setup Defaults**, and then press **enter**.
3. When the Setup Confirmation is displayed, press **enter**.
4. To save your change and exit Setup Utility, use the arrow keys to select **Exit > Exit Saving Changes**, and then press **enter**.

The Setup Utility default settings go into effect when the computer restarts.

 **NOTE:** Your password, security, and language settings are not changed when you restore the factory default settings.

Exiting Setup Utility

You can exit Setup Utility with or without saving changes.

- To exit Setup Utility and save your changes from the current session:

If the Setup Utility menus are not visible, press **esc** to return to the menu display. Then use the arrow keys to select **Exit > Exit Saving Changes**, and then press **enter**.
- To exit Setup Utility without saving your changes from the current session:

If the Setup Utility menus are not visible, press **esc** to return to the menu display. Then use the arrow keys to select **Exit > Exit Discarding Changes**, and then press **enter**.

After either choice, the computer restarts in Windows.

Setup Utility menus

The menu tables in this section provide an overview of Setup Utility options.

 **NOTE:** Some of the Setup Utility menu items listed in this chapter may not be supported by your computer.

Main menu

Select	To do this
System information	<ul style="list-style-type: none">• View and change the system time and date.• View identification information about the computer.• View specification information, such as processor information, memory size, and system BIOS.

Security menu

Select	To do this
Administrator password	Enter, change, or delete an administrator password.
Power-On Password	Enter, change, or delete a power-on password.

System Configuration menu

Select	To do this
Language	Change the Setup Utility language.
Virtualization Technology (select models only)	Enable/disable the processor Virtualization Technology.
LAN Power Saving	Enable/disable the LAN power saving. Reduces the power consumption of the LAN controller
Fan Always On	Enabled/disable Fan Always On. When enabled, the computer fan will always be on.
Action Keys Mode	Enable/disable the Action Keys.
Boot Options	Set the following boot options: <ul style="list-style-type: none">• POST Hot Key Delay (sec.)—Set the delay for the user to press hotkeys in intervals of 5 seconds each (0, 5, 10, 15, 20).• Floppy Boot—Enable/disable boot from diskette.• Internal Network Adapter Boot—Enable/disable boot from external Network Adapter.• Boot Order—Set the boot order for:<ul style="list-style-type: none">◦ Notebook Hard Drive◦ USB Diskette on Key/USB Hard Disk◦ USB CD/DVD ROM Drive

Select	To do this
	<ul style="list-style-type: none">◦ USB Floppy◦ Network Adapter

Diagnostics menu

Select	To do this
Primary Hard Disk Self Test	Run a comprehensive self-test on the hard drive.
Memory Test	Run a diagnostic test on the system memory.

Updating the BIOS

Updated versions of the BIOS may be available on the HP Web site.

Most BIOS updates on the HP Web site are packaged in compressed files called *SoftPaqs*.

Some download packages contain a file named *Readme.txt*, which contains information regarding installing and troubleshooting the file.

Determining the BIOS version

To determine whether available BIOS updates contain later BIOS versions than those currently installed on the computer, you need to know the version of the system BIOS currently installed.

BIOS version information (also known as *ROM date* and *System BIOS*) can be displayed by pressing **fn+esc** (if you are already in Windows) or by opening Setup Utility.

To use Setup Utility for displaying BIOS information:

1. Open Setup Utility by turning on or restarting the computer. While the “Press the ESC key for Startup Menu” message is displayed in the lower-left corner of the screen, press **f10**.
2. If Setup Utility does not open with the system information displayed, use the arrow keys to select the **Main** menu.

When the Main menu is selected, BIOS and other system information is displayed.

3. To exit Setup Utility, use the arrow keys to select **Exit > Exit Discarding Changes**, and then press **enter**.

Downloading a BIOS update

- △ **CAUTION:** To prevent damage to the computer or an unsuccessful installation, download and install a BIOS update only when the computer is connected to reliable external power using the AC adapter. Do not download or install a BIOS update while the computer is running on battery power, docked in an optional docking device, or connected to an optional power source. During the download and installation, follow these instructions:

Do not disconnect power from the computer by unplugging the power cord from the AC outlet.

Do not shut down the computer or initiate Sleep or Hibernation.

Do not insert, remove, connect, or disconnect any device, cable, or cord.

To download a BIOS update:

1. Access the page on the HP Web site that provides software for your computer:
Select **Start > Help and Support > Maintain**.
2. Follow the instructions on the screen to identify your computer and access the BIOS update you want to download.
3. At the download area, follow these steps:
 - a. Identify the BIOS update that is later than the BIOS version currently installed on your computer. Make a note of the date, name, or other identifier. You may need this information to locate the update later, after it has been downloaded to your hard drive.
 - b. Follow the instructions on the screen to download your selection to the hard drive.

Make a note of the path to the location on your hard drive where the BIOS update will be downloaded. You will need to access this path when you are ready to install the update.



NOTE: If you connect your computer to a network, consult the network administrator before installing any software updates, especially system BIOS updates.

BIOS installation procedures vary. Follow any instructions that are displayed on the screen after the download is complete. If no instructions are displayed, follow these steps:

1. Open Windows Explorer by selecting **Start > Computer**.
2. Double-click your hard drive designation. The hard drive designation is typically Local Disk (C:).
3. Using the hard drive path you recorded earlier, open the folder on your hard drive that contains the update.
4. Double-click the file that has an .exe extension (for example, *filename.exe*).

The BIOS installation begins.
5. Complete the installation by following the instructions on the screen.



NOTE: After a message on the screen reports a successful installation, you can delete the downloaded file from your hard drive.

A Product information

Input power

The power information in this section may be helpful if you plan to travel internationally with the computer.

The computer operates on DC power, which can be supplied by an AC or a DC power source. Although the computer can be powered from a standalone DC power source, it should be powered only with an AC adapter or a DC power source supplied and approved by HP for use with this computer.

The computer can operate on DC power within the following specifications.

Input power	Rating
Operating voltage	18.5 V dc @ 3.5 A - 65W
Operating current	3.5 A

 **NOTE:** This product is designed for IT power systems in Norway with phase-to-phase voltage not exceeding 240 V rms.

NOTE: The computer operating voltage and current can be found on the system regulatory label on the bottom of the computer.

Operating environment

Factor	Metric	U.S.
Temperature		
Operating (writing to optical disc)	5°C to 35°C	41°F to 95°F
Nonoperating	-20°C to 60°C	-4°F to 140°F
Relative humidity (noncondensing)		
Operating	10% to 90%	10% to 90%
Nonoperating	5% to 95%	5% to 95%
Maximum altitude (unpressurized)		
Operating	-15 m to 3,048 m	-50 ft to 10,000 ft
Nonoperating	-15 m to 12,192 m	-50 ft to 40,000 ft

Traveling with the computer

For best results, follow these traveling and shipping tips:

- Prepare the computer for traveling or shipping:
 - Back up your information.
 - Remove all discs and all external media cards, such as digital cards.
 - △ **CAUTION:** To reduce the risk of damage to the computer, damage to a drive, or loss of information, remove the media from a drive before removing the drive from a drive bay, and before shipping, storing, or traveling with a drive.
 - Turn off and then disconnect all external devices.
 - Shut down the computer.
- Take along a backup of your information. Keep the backup separate from the computer.
- When traveling by air, carry the computer as hand luggage, and do not check it in with the rest of your bags.
- △ **CAUTION:** Avoid exposing a drive to magnetic fields. Security devices with magnetic fields include airport walk-through devices and security wands. The airport security devices that check carry-on luggage, such as conveyor belts, use X-rays instead of magnetism and will not damage a drive.
- In-flight computer use is at the discretion of the airline. If you plan to use the computer during a flight, check with the airline in advance.
- If the computer will be unused and disconnected from external power for more than 2 weeks, remove the battery and store it separately.
- If you are shipping the computer or a drive, use suitable protective packaging and label the package "FRAGILE."
- If the computer has a wireless device or a cell phone device installed, such as an 802.11b/g device, a Global System for Mobile Communications (GSM) device, or a General Packet Radio Service (GPRS) device, the use of these devices may be restricted in some environments. Such restrictions may apply onboard aircraft, in hospitals, near explosives, and in hazardous locations. If you are uncertain of the policy that applies to the use of a particular device, ask for authorization to use it before you turn it on.
- If you are traveling internationally, follow these suggestions:
 - Check the computer-related customs regulations for each country or region on your itinerary.
 - Check the power cord and adapter requirements for each location in which you plan to use the computer. Voltage, frequency, and plug configurations vary.
- △ **WARNING!** To reduce the risk of electric shock, fire, or damage to the equipment, do not attempt to power the computer with a voltage converter kit sold for appliances.

Routine care

Cleaning the display

-
- △ **CAUTION:** To prevent permanent damage to the computer, never spray water, cleaning fluids, or chemicals on the display.
-

To remove smudges and lint, frequently clean the display with a soft, damp, lint-free cloth. If the screen requires additional cleaning, use premoistened antistatic wipes or an antistatic screen cleaner.

Cleaning the TouchPad and keyboard

Dirt and grease on the TouchPad can cause the pointer to jump around on the screen. To avoid this, clean the TouchPad with a damp cloth, and wash your hands frequently when using the computer.

-
- △ **WARNING!** To reduce the risk of electric shock or damage to internal components, do not use a vacuum cleaner attachment to clean the keyboard. A vacuum cleaner can deposit household debris on the keyboard surface.
-

Clean the keyboard regularly to prevent keys from sticking and to remove dust, lint, and particles that can become trapped beneath the keys. A can of compressed air with a straw extension can be used to blow air around and under the keys to loosen and remove debris.

Labels

The labels affixed to the computer provide information you may need when you troubleshoot system problems or travel internationally with the computer:

- Service tag—Provides important information, including the following:



- Product name **(1)**. This is the product name affixed to the front of the computer.
- Serial number (s/n) **(2)**. This is an alphanumeric identifier that is unique to each product.
- Part number/Product number (p/n) **(3)**. This number provides specific information about the product's hardware components. The part number helps a service technician to determine what components and parts are needed.
- Model description **(4)**. This is an alphanumeric identifier used to locate documents, drivers, and support for the computer.
- Warranty period **(5)**. This number describes the duration of the warranty period for the computer.

Have this information available when you contact technical support. The service tag label is located inside the battery bay.

- Microsoft® Certificate of Authenticity—Contains the Windows Product Key. You may need the Product Key to update or troubleshoot the operating system. The Microsoft Certificate of Authenticity is affixed to the bottom of the computer.
- Regulatory label—Provides regulatory information about the computer. The regulatory label is located on the bottom of the computer.
- Wireless certification label(s)—Provide information about optional wireless devices and the approval markings of some of the countries or regions in which the devices have been approved for use. An optional device may be a wireless local area network (WLAN) device or an optional Bluetooth® device. If your computer model includes one or more wireless devices, one or more certification labels are included with your computer. You may need this information when traveling internationally. Wireless certification labels are affixed to the bottom of the computer.
- SIM label (select models only)—Provides the ICCID (Integrated Circuit Card Identifier) of your SIM. This label is located inside the battery bay.
- HP Mobile Broadband Module serial number label (select models only)—Provides the serial number of your HP Mobile Broadband Module. This label is located inside the battery bay.

Index

A

- AC adapter, testing 62
- AC power, connecting 61
- action key mode 105
- action keys
 - adjusting volume 36
 - audio CD, DVD, or BD controls 35
 - decrease screen brightness 35
 - Help and Support 35
 - identifying 5
 - increase screen brightness 35
 - muting speaker sound 36
 - switching screen image 35
 - using 35
 - volume 43
 - wireless 15, 36
- administrator password
 - creating 87
 - entering 88
 - managing 87
- airport security devices 69
- antivirus software, using 89
- audio devices, connecting
 - external 43
- audio-in (microphone) jack, identifying 8
- audio-out (headphone) jack, identifying 8

B

- backing up
 - customized window, toolbar, and menu bar settings 97
 - personal files 97
 - templates 97
- battery
 - calibrating 58
 - charging 56

- conserving power 52
- discharging 57
- disposing 59
- inserting 55
- low battery levels 57
- removing 55
- replacing 59
- storing 58
- battery bay, identifying 10
- Battery Check 54
- battery light 7, 56
- battery power 54
- battery release latch 10, 55
- battery temperature 58
- BD drive 77
- Bluetooth device 14
- Bluetooth label 114
- Bluetooth wireless devices 22
- boot options 105
- boot order 105
- buttons
 - left TouchPad 3
 - right TouchPad 3
 - rotate 6
 - wireless 7, 15

C

- cables
 - USB 66
- calibrating battery 58
- caps lock light, identifying 4
- CD drive 77
- Certificate of Authenticity label 114
- charging batteries 56
- cleaning, TouchPad and keyboard 113
- clicks
 - changing settings 34
 - testing 34

components

- bottom 10
- display 8
- front 5
- left-side 7
- rear 9
- right-side 6
- top 3
- computer, traveling 112
- configuring HDMI 48
- Connect to the Internet Wizard 12, 13
- connection, external power 61
- connector, power 7
- conservation, power 52
- convertible hinge, identifying 9
- critical battery level 51, 57
- critical security updates, installing 91

D

- default settings, restoring 103
- Diagnostics menu 106
- digital card
 - inserting 64
 - removing 65
 - supported formats 64
- Digital Media Slot, identifying 7
- Disk Cleanup software 70
- Disk Defragmenter software 70
- diskette drive 77
- display
 - rotating 30
- display image, switching 35
- display, cleaning 113
- dragging touch screen
 - gesture 32
- drive light 8, 71
- drive media 51

- drives
 - boot order 105
 - connecting external 77
 - diskette 77
 - external 77
 - handling 69
 - hard 73, 74, 77
 - optical 77
- DVD drive 77
- E**
 - encryption 19
 - End hotkey 37
 - entering a power-on password 88
 - entering an administrator password 88
 - esc key, identifying 5
 - external audio devices, connecting 43
 - external drive 77
 - external monitor port 9, 47
 - external optical drive 42
 - external WWAN antenna, identifying 6
- F**
 - f11 99
 - fan always on 105
 - fingerprint reader
 - identifying 6
 - using 93
 - fingerprints, registering 93
 - firewall software 19, 90
 - flicking touch screen gesture 32
 - flicks
 - changing assignments 34
 - creating assignments 34
 - fn key, identifying 5, 37
 - full system recovery 95
- G**
 - graphic modes, switching 60
- H**
 - hard drive
 - external 77
 - HP ProtectSmart Hard Drive Protection 71
 - installing 74
 - removing 73
 - hard drive bay, identifying 10
 - HDMI
 - configuring 48
 - connecting 47
 - HDMI port, identifying 8, 47
 - headphone (audio-out) jack 8
 - Help and Support key 35
 - Hibernation
 - exiting 51
 - initiated during critical battery level 57
 - initiating 51
 - high-definition devices, connecting 47
 - hinge, identifying 9
 - Home hotkey 37
 - hotkeys
 - description 37
 - display system information 37
 - End 37
 - Home 37
 - page down 37
 - page up 37
 - using 37
 - HP Mobile Broadband Module 20
 - HP ProtectSmart Hard Drive Protection 71
 - HP USB Ethernet Adapter
 - connecting 23
 - hubs 66
- I**
 - icons
 - network 14
 - wireless 14
 - input power 110
 - integrated webcam light, identifying 9
 - internal microphones, identifying 9
 - Internet
 - choosing an ISP 12
 - Internet connection setup 17
 - Internet Service & Offers 12
 - Internet Service Provider (ISP) 12
- J**
 - jacks
 - audio-in (microphone) 8
 - audio-out (headphone) 8
 - RJ-45 (network) 9
- K**
 - keyboard hotkeys, identifying 37
 - keyboard, cleaning 113
 - keys
 - action 5
 - esc 5
 - fn 5
 - mute 43
 - Windows applications 5
 - Windows logo 5
- L**
 - labels
 - Bluetooth 114
 - Microsoft Certificate of Authenticity 114
 - regulatory 114
 - service tag 114
 - wireless certification 114
 - WLAN 114
 - LAN power saving 105
 - language 105
 - latch, battery release 10
 - lights
 - battery 7
 - caps lock 4
 - drive 8, 71
 - mute 4
 - power 6
 - webcam 9
 - wireless 4, 7
 - local area network (LAN)
 - cable required 23
 - connecting cable 23
 - low battery level 57
- M**
 - Main menu 105
 - maintenance
 - Disk Cleanup 70
 - Disk Defragmenter 70
 - managing a power-on password 88
 - managing an administrator password 87
 - media activity keys 40
 - media controls, keys 35
 - MediaSmart software 41

- memory module
 - inserting 82
 - removing 82
- memory module compartment cover
 - removing 81
 - replacing 83
- memory module compartment, identifying 10
- memory test 106
- microphone (audio-in) jack, identifying 8
- Microsoft Certificate of Authenticity label 114
- monitor, connecting 47
- mouse, external
 - setting preferences 25
- multimedia software
 - installing 42
 - using 41
- mute key
 - identifying 36
 - using 43
- mute light, identifying 4

N

- network cable, connecting 23
- network icon 14

O

- operating environment 111
- operating system
 - Microsoft Certificate of Authenticity label 114
 - Product Key 114
- optical drive
 - external 42, 77
 - sharing 42, 79

P

- page down hotkey 37
- page up hotkey 37
- passwords
 - administrator 87
 - power-on 88
 - set in Setup Utility 86
 - set in Windows 86
- pen
 - identifying 29
 - storing 29
 - using 29

- pen holder 8, 29
- pen tether eyelet 29
- pen tether hole, identifying 8
- pinching touch screen gesture 33
- pinching TouchPad gesture 27
- pointing devices
 - setting preferences 25
- ports
 - external monitor 9, 47
 - HDMI 8, 47
 - USB 7, 8, 66
- power
 - connecting 61
 - conserving 52
- power connector, identifying 7
- power light, identifying 6
- power switch, identifying 6
- power-on password
 - creating 88
 - entering 88
 - managing 88
- primary hard disk self test 106
- Product Key 114
- product name and number, computer 114
- programs, using 41
- projector, connecting 47

R

- readable media 51
- recovering a program or driver 95
- recovering from the dedicated recovery partition 99
- recovering from the recovery discs 99
- recovery discs 95, 96
- Recovery Manager 95, 99
- recovery partition 95
- recovery, system 99
- regulatory information
 - regulatory label 114
 - wireless certification labels 114
- restore points 98
- RJ-45 (network) jack, identifying 9
- rotate button, identifying 6
- rotate button, using 31
- rotating touch screen gesture 33
- rotating TouchPad gesture 27

- routine care 113

S

- screen brightness keys 35
- screen image, switching 35
- screen orientations, identifying 31
- scrolling touch screen gesture 32
- scrolling TouchPad gesture 26
- security cable slot, identifying 9
- security cable, installing 92
- Security menu 105
- security, wireless 19
- serial number, computer 114
- service tag 114
- setup of WLAN 17
- Setup Utility
 - changing the language 102
 - displaying system information 103
 - exiting 103
 - menus 105
 - navigating 102
 - passwords set in 86
 - restoring default settings 103
 - selecting 102
 - starting 101
- shared drives 79
- shutdown 50
- SIM
 - inserting 20
 - removing 21
- Sleep
 - exiting 51
 - initiating 51
- slots
 - Digital Media 7
 - memory 80
 - security cable 9
- software
 - Disk Cleanup 70
 - Disk Defragmenter 70
 - MediaSmart 41
 - TouchSmart 41
 - using 41
 - Wireless Assistant 15
- solid-state drive (SSD) 95, 99
- speakers, identifying 9
- storing battery 58
- supported discs 96

- switch, power 6
- switchable graphics 60
- System Configuration menu 105
- system failure or instability 95
- system information hotkey 37
- system information,
 - displaying 103, 105
- system recovery 99
- system restore points 95, 98

T

- tapping touch screen gesture 31
- temperature 58
- touch screen
 - performing screen actions 31
 - preferences 34
 - using 30
- touch screen gestures
 - dragging 32
 - flicking 32
 - pinching 33
 - rotating 33
 - scrolling 32
 - tapping 31
 - zooming 33
- TouchPad
 - buttons 3
 - cleaning 113
 - gestures 25
 - using 25
- TouchPad gestures
 - pinching 27
 - rotating 27
 - scrolling 26
 - zooming 27
- TouchPad off indicator 3
- TouchPad off indicator,
 - identifying 4
- TouchPad zone
 - identifying 3
- TouchSmart
 - starting 41
 - using 41
- TouchSmart software 41
- traveling with the computer 58, 112, 114
- turning off the computer 50

U

- unresponsive system 50

- USB cable, connecting 66
- USB devices
 - connecting 66
 - description 66
 - removing 66
- USB hubs 66
- USB port, identifying 8
- USB ports, identifying 7, 66
- using system restore 98

V

- vents, identifying 6, 8, 10
- Virtualization Technology 105
- volume
 - adjust 43
 - keys 43
 - mute 43
- volume keys, identifying 36

W

- webcam
 - adjusting properties 46
 - identifying 9
- webcam light, identifying 9
- Windows applications key,
 - identifying 5
- Windows Connect to the Internet Wizard 13
- Windows logo key, identifying 5
- Windows, passwords set in 86
- wireless
 - protecting 19
 - set up 17
- wireless antennas, identifying 9
- Wireless Assistant software 14, 15
- wireless button
 - using 15
- wireless button, identifying 7
- wireless certification label 114
- wireless controls
 - key 14
 - operating system 14
 - Wireless Assistant software 14
- wireless icon 14
- wireless key
 - identifying 36
 - using 14, 15
- wireless light 4, 7, 14

- wireless network (WLAN)
 - equipment needed 17
 - security 19
- WLAN antennas, identifying 9
- WLAN device 114
- WLAN label 114
- writable media 51
- WWAN antennas, identifying 9
- WWAN device 20

Z

- zooming screen gesture 33
- zooming TouchPad gesture 27

