

Guardian[®] RT

Continuous Glucose Monitoring System

REF MMT-7900

User Guide

© 2005, Medtronic MiniMed. All rights reserved.

Guardian[®], MiniMed[®] and Sen-serter[®] are registered trademarks of Medtronic MiniMed.
Com-Station[™], Shower-Pak[™], Solutions[™] Software are trademarks of Medtronic MiniMed.

BD Logic[™] is a trademark of Becton, Dickinson and Company

Detachol[®] is a registered trademark of Ferndale Laboratories, Inc.

Polyskin[®] is a registered trademark of the Kendall Healthcare Products Company.

CaviCide[®] is a registered trademark of the Metrex Research Corporation.

IV3000[®] is a registered trademark of Smith & Nephew, Inc.

YSI 2300 STAT Plus[™] is a trademark of YSI Incorporated.

The Guardian RT System is covered by the following Patent Nos: 5,390,671; 5,391,250; 5,568,806; 5,586,533; 5,586,553; 5,777,060; 5,779,665; 5,786,439; 5,851,197; 5,882,494; 5,954,643; 6,093,172; 6,248,067; 6,293,925; 6,368,141; 6,418,332; 6,424,847; 6,462,162; 6,520,326; 6,607,509; DES 433,755.

The Guardian RT System is covered by other/pending patents.



MINIMED

Medtronic MiniMed

Northridge, CA 91325

USA

800-646-4633 (800-MiniMed)

818-576-5555

E.U. Representative

Medtronic B.V.

Earl Bakkenstraat 10

6422 PJ Heerlen

The Netherlands

31 (0) 45 566 8000

www.minimed.com



R_x Only

Table of Contents

Chapter 1: Introduction	1
System Function.....	2
System Components	2
Glucose Sensor.....	2
Transmitter	2
Monitor.....	3
Monitor Buttons	3
Monitor Button Functions	4
Monitor User Guide Terms	4
Test Plug.....	5
Sensor	5
Availability.....	5
Help	6
Record Keeping.....	6
Warranty	6
User Safety.....	7
Indications for Use	7
Contraindications	7
Warnings.....	8
Precautions.....	9
Adverse Reactions.....	11
Symptoms of Hypoglycemia	11
Symptoms of Hyperglycemia	12
Blood Glucose Meter	12

Chapter 2: Getting Started	13
Quick-Reference Guide	13
Start-Up Process	17
Installing the Batteries	17
Turning On the Monitor.....	19
Turning Off the Monitor	19
Home Screen	19
The Main Screens	20
Programming the Monitor	21
Setting the Language	22
Setting the Time Display Format	23
Setting the Time and Date.....	24
Clearing the Glucose History	26
Setting the Glucose Unit	29
Setting the Low Glucose Alert.....	30
Setting the High Glucose Alert	33
Setting the Alert Type	36
Entering the Transmitter ID	37
Inserting the Sensor	39
Sensor Storage and Handling	44
Sen-serter Maintenance	44
Affixing the Transmitter.....	45
Searching for the Transmitter.....	46
Connecting the Sensor to the Transmitter	47
Sensor Initialization.....	48
Sensor Calibration.....	48
Calibration Pending	50
No Sync	50
Replacing the Glucose Sensor	51
Removing the Sensor.....	51

Chapter 3: Routine Operation.....	53
Glucose History.....	53
Entering Meter BG for Calibration.....	55
BG Due.....	56
Enter BG.....	57
Calibration Pending.....	57
No Sync.....	58
Replacing the Glucose Sensor.....	58
Events.....	59
Units of Insulin Taken.....	60
Carbohydrate Amount.....	61
Duration of Exercise.....	61
Other Events.....	62
Glucose Alarm History.....	63
Search.....	65
Signals.....	65
The Snooze Option.....	66
Chapter 4: Troubleshooting and Alarms.....	67
List of Alarms.....	68
No ID.....	68
High.....	69
Low.....	70
Check Sensor.....	71
Low Batt.....	72
Off/No Power.....	73
Service C60/61.....	74
Re Init.....	74
No Sync.....	75
Cal Err.....	76
Key Held.....	77
Enter BG.....	77
Set Time.....	78
Replace Sensor.....	79
System Alarms.....	80
Test Plug Procedure.....	81

Chapter 5: Performance Characteristics	83
Performance Results	84
Accuracy of Guardian RT Readings	85
Precision of Guardian RT Readings	89
Low and High Alerts.....	89
The Low Glucose Alert	90
The High Glucose Alert.....	91
Guardian RT Sensor Performance and Calibration.....	92
Affects of Calibration Frequency	94
Time-Elapsed Plots.....	95
Chapter 6: System Maintenance	99
Belt Clip	99
Installation	99
Removal.....	100
Leather Case	100
Protection from Water	100
Protection from Impact	101
Protection from High and Low Temperatures	101
Cleaning the Monitor.....	102
Cleaning the Transmitter	102
Cleaning the Sen-serter	104
Interference from Electrical Equipment	105
Ordering Supplies.....	106
Product Specifications.....	107
FCC Notice for the Monitor	110
FCC Notice for the Transmitter	110
Icon Table	111
Fixed Elements Table.....	113
Appendix	115
Electromagnetic Compatibility Compliance Information	115
Glossary	121

Introduction

Congratulations on buying one of the most exciting devices in the field of diabetes care! The Medtronic MiniMed Guardian[®] RT (Real Time) System (MMT-7900) continuously monitors glucose levels, provides real-time glucose values, and gives high and low glucose alerts. The Guardian RT uses three separate components—Sensor, Transmitter, and Monitor—to measure and display glucose levels in persons with diabetes. The Sensor is inserted in the abdomen in fluid under the skin (Interstitial Fluid) and is attached to the Transmitter. The Transmitter takes information from the Sensor and sends it to the Monitor. The Monitor is a device that can store this information for real-time review, or can download it to a personal computer using a Medtronic MiniMed Com-Station™ (MMT-7301) and the Guardian Solutions™ Software (MMT-7315). This information is used by you and your doctor to identify glucose patterns and to improve your diabetes management.

We know you are ready to start, but before you do, please read the following user guide to learn all about the Guardian RT. Chapter 1 gives a general overview of the system. Chapter 2 offers step-by-step instructions to get you started. Chapter 3 explains the routine operation of the Guardian RT. Chapter 4 walks you through the system alarms and troubleshooting approach. Chapter 5 goes over performance characteristics, and Chapter 6 covers system maintenance and other important information.

Figure 1.1

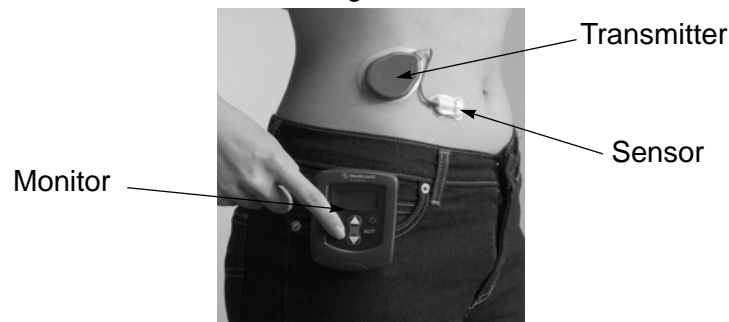

System Function

The Guardian RT measures glucose levels in interstitial fluid: the fluid found between the body's cells. It is from this fluid that cells get oxygen and nutrients, including glucose. Glucose levels in interstitial fluid typically match glucose levels in the blood. The system gives real-time interstitial fluid glucose values on demand (updated every five minutes). The system also features low glucose and high glucose alerts that are triggered once limits you have preset are reached. Data from the Sensor (which is placed under the skin into the interstitial fluid) triggers the low blood glucose alert if your Sensor glucose value is less than or equal to the preset limit. The high blood glucose alert is triggered if your Sensor glucose value is greater than or equal to the preset limit. Glucose values are calculated and displayed based on the blood glucose reference values entered periodically into the Monitor for calibration.

NOTE - Before taking action based on glucose values or High and Low glucose alerts, check your blood glucose using a home glucose meter available from your doctor or pharmacy.

System Components

Glucose Sensor

Figure 1.2



The Sensor (MMT-7002) is inserted through the skin into interstitial fluid. The Sensor gives off a signal that is related to the amount of glucose in the interstitial fluid at the insertion site. (See Figure 1.2.)

Transmitter

Figure 1.3

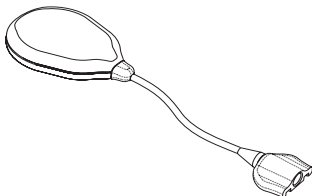

The Transmitter (MMT-7700) connects to the Sensor and is fixed to the skin with medical tape. The Transmitter receives and processes signals from the Sensor, and it sends the signals by radio frequency to the Monitor. (See Figure 1.3.)

Monitor

The Transmitter sends Sensor data in the form of radio signals to the Monitor (MMT-7901) about every 5 minutes. The Monitor stores this information and uses it to provide real-time glucose values and to trigger low or high glucose alerts. This information can also be downloaded for analysis to a personal computer by means of a Medtronic MiniMed Com-Station™ (MMT-7301) and the Guardian Solutions™ Software (MMT-7315).

The system is calibrated by entering into the Monitor blood glucose values from a home glucose meter. Six hours before a meter BG entry for the purpose of calibration is due, the word **CAL** will appear on the Monitor screen. This icon will remain on the display until you enter a meter value. If you do not enter a meter value within 12 hours of the last entry, an ENTER BG alarm is triggered. This alarm is also triggered if a calibration has not been done in the last 8 hours since the first calibration. For best performance, enter a meter value every 6 hours. A minimum of one meter value must be entered at least every 12 hours into the Guardian RT for the real-time glucose display and the low and high glucose alerts to work.



Monitor Buttons

The Monitor is controlled by 5 buttons. (See Figure 1.4.) Always press the Monitor buttons slowly and firmly.

Figure 1.4



Monitor Button Functions

	This button turns the Monitor On or Off.
SEL	The SEL (Select) button scrolls through the menu screens. It is used with the ACT button to clear alarms/alerts.
ACT	The ACT (Activate) button lets you make changes to programming, save information to memory or clear alarms/alerts. You will hear a beep when you press ACT to confirm the selection.
Up and Down Arrows	The Up and Down arrows are used to change values or settings. Press either arrow once to pick the next highest or lowest value. Hold down either arrow to scroll through the list of values. Hold down either arrow for more than 5 seconds to speed up scrolling. When you reach the wanted value press ACT to set. If you do not press ACT within 10-20 seconds, the display will go back to the default screen.
	Located on the Down arrow and used from the HOME screen, the Backlight button turns On or Off the screen light, letting you see the display at night or in dim lighting. The light will stay on for about 15 seconds after the last button press.

Monitor User Guide Terms

The following terms and icons are used to describe the Monitor in this User Guide:

- Press means to push and release the button.
- Hold means to push and keep pressure on the button.
- Flashing words or numbers (but not icons) on the screen mean that you can change this information in the Monitor.
- Information that cannot be changed appears on the screen in characters that do not flash.
- Button names are always UPPERCASE and **bold**, e.g., **ACT** and **SEL**.
- Screen names are always UPPERCASE, e.g., HOME and HIGH.

Test Plug

Figure 1.5

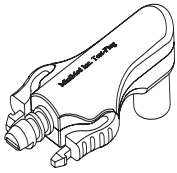

The Test Plug (MMT-7400) is a device used to troubleshoot the Guardian RT system. (See Figure 1.5.) If there is a problem with the Guardian, it can give information that will tell if the Sensor, Transmitter, or Monitor are working correctly. See *Chapter 4: Troubleshooting and Alarms* for more details.

Sen-serter

Figure 1.6



The Sen-serter[®] (MMT-7500) is a spring-loaded reusable device that inserts the Sensor (MMT-7002) at an angle under the skin and into the interstitial fluid. (See Figure 1.6.)

Availability

The Guardian RT and supporting products are available from Medtronic MiniMed and authorized distributors.

Help

Medtronic MiniMed provides a 24-Hour Product Help Line in the United States and Canada. The help line is staffed with personnel trained in the set-up and use of the Guardian RT system, and they are able to answer your questions. When calling, please have the Guardian RT system and this User Guide with you.

Department	Telephone Number
24-Hour Product Help Line	U.S. and Canada 800-MINIMED (800-646-4633) or 818-576-5555 International Contact your local sales office
Medtronic MiniMed Website	
www.minimed.com	

Record Keeping

A serial number is found on the back of the Monitor and on the top of the Transmitter. Please enter the serial numbers and purchase date in the table below.

Serial Number	Purchase Date
Monitor:	
Transmitter:	

Warranty

Please read the enclosed warranty card carefully as it lists the terms of coverage.

User Safety

Indications for Use

The Guardian RT is indicated for continuous or periodic monitoring of glucose levels in the fluid under the skin, in adults (ages 18 and older) with diabetes mellitus, for the purpose of improving diabetes management. It alerts if a glucose level falls below, or rises above, preset values. Values are not intended to be used directly for making therapy adjustments, but rather to provide an indication of when a finger stick may be required. All therapy adjustments should be based on measurements obtained using a home glucose monitor and not on Guardian RT values.

The Guardian RT provides real-time glucose values that allow users to track patterns in glucose concentrations and to possibly identify episodes of low and high blood glucose. It also stores the data so that it can be analyzed to track patterns. Glucose data can be further downloaded to PC software for analysis of historical glucose values.

Contraindications

Use of the Guardian RT is not recommended for persons whose impaired vision or hearing does not allow full recognition of the Guardian RT signals and alarms/alerts.

The Sen-serter is not indicated for use with product other than the Glucose Sensor. Medtronic MiniMed cannot guarantee this product's safety and/or efficacy if other sets are used.

Warnings

Monitor

The Monitor and Transmitter need to be kept within 6 feet (approximately 2.0 meters) of each other to ensure that communication is not interrupted.

Transmitter

The Transmitter should be removed if irritation or reaction to the Transmitter tape develops.

The Transmitter should be disconnected from the Sensor while traveling on an aircraft, or if it interferes with another transmitting device.

Sensor/Sen-serter

The Sensor may create special needs regarding your medical conditions or medications. Please discuss these conditions and medications with your doctor before using the Sensor. Bleeding, swelling, irritation and/or infection at the insertion site are possible risks associated with inserting the Sensor and may result from improper insertion and maintenance of insertion site.

After insertion, wait 2-3 minutes before attaching the Transmitter to watch for bleeding at the insertion site. If bleeding occurs, apply steady pressure using a sterile gauze or clean cloth for up to 3 minutes.

If bleeding stops:

1. Attach the Sensor to the system connector.

If bleeding does not stop:

CAUTION: Do NOT attach the Sensor to the system connector.

1. Remove the Sensor and discard.
2. Check the site for redness, bleeding, irritation, pain, tenderness, or inflammation and treat accordingly.
3. Insert a new Sensor in a different location.

The Sensor should be removed if redness, pain, tenderness, or swelling develop at the insertion site, or if you experience unexplained fevers. Check site often for these conditions and to make sure Sensor is still in place, especially before going to bed and upon waking.

Confirm symptoms of low blood glucose and high blood glucose, as well as displayed glucose values and alerts, with a home blood glucose meter available from your doctor or pharmacy.

The Sensor is sterile and non-pyrogenic unless the package has been opened or damaged. Do not use any Sensor if its sterile package has been previously opened or damaged. Always inspect packaging for damage prior to use. Do not use a Sensor that exceeds the expiration date printed on the package.

Remove plastic needle cover before inserting Sensor.

If Sensor is not securely placed in Sen-serter prior to insertion, pain or minor injury may occur.

Never point loaded Sen-serter toward any body part where insertion is not desired.

Precautions

Monitor

You should be trained by your healthcare professional on how to program and operate the Monitor and respond to alarm/alert conditions before using the system.

Do not expose the Monitor to water. The Monitor should be set aside or placed in a Shower-Pak™ (MMT-117) before doing activities in which the Monitor would be expected to get wet.

Contact sports or other activities may damage the Monitor and should be avoided. Prior to exercising, make sure the Sensor is firmly attached.

If the Monitor shows a NO POWER alarm on the display, there will be an immediate shut-off as soon as the alarm is acknowledged, and data collection will automatically stop. Batteries must be replaced immediately to avoid the need for Sensor replacement and potential loss of data stored in memory. Upon battery replacement, a SEARCH must be performed. (Refer to *Searching for the Transmitter* section in *Chapter 2: Getting Started*.)

Although the Monitor is tested and complies with the applicable standards, the use of the Monitor in close proximity to strong electromagnetic sources, such as MRI equipment, television transmitters, high-voltage power lines, or high-power radio transmitters is not recommended.

Keep the Monitor in its leather case to protect against electrostatic discharges that are common in cold and dry climates.

Transmitter

Establish a rotation schedule for choosing each new Transmitter site. Avoid sites that are constrained by clothing, scar tissue, accessories or subjected to rigorous movement during exercise.

Sensor

Always wash hands with soap and water before opening the Sensor package and handling Sensor. After opening the package, avoid touching any Sensor surfaces that will come in contact with the body. These surfaces include: the Sensor, needle, connector adhesive surfaces and tape.

Prior to inserting the Sensor, select insertion site, and use antiseptic to cleanse site. Allow area to dry.

If you also wear an insulin pump, make sure that the Sensor insertion site is at least three (3) inches (7.62 cm) away from the insulin infusion site. If you inject insulin, you should give injections at least three (3) inches (7.62 cm) away from the Sensor insertion site. When replacing Sensor, select new insertion site at least two (2) inches (5.08 cm) from previous site.

Do not insert Sensor through tape, and do not use sticky preps before insertion.

After inserting the Sensor and attaching the Transmitter, cover the Sensor site with sterile/occlusive dressing, such as IV3000[®] (MMT-174).

Be aware that excessive perspiration can loosen dressing. Check dressing after any activity in which excessive perspiration has resulted.

Establish a rotation schedule for choosing each new Sensor site. Avoid sites that are constrained by clothing, scar tissue, accessories or subjected to rigorous movement during exercise.

Dispose of used Sensors and introducer needles in a sharps container after single use. Do not clean or resterilize, and do not recap needle with Sensor needle cover.

Adverse Reactions

Operation of the Medtronic MiniMed Guardian RT requires the insertion of a Glucose Sensor into the skin. Bleeding, swelling, bruising, or infection at the Sensor insertion site are possible risks of Sensor use. The Sensor should be removed if redness, pain, tenderness, or swelling develop at the insertion site. The Transmitter should be removed if irritation or a reaction to the Transmitter tape develops. In the event of any adverse reaction associated with this system, U.S. and Canadian customers please contact your doctor and the Product Help Line at 800-MINIMED (800-646-4633) or 818-576-5555. All other international customers please contact your local sales office.

Symptoms of Hypoglycemia

Hypoglycemia (low blood glucose) may occur in persons with diabetes who take insulin or certain oral medications. There are symptoms linked to low blood glucose that should not be ignored no matter how mild they are, even if the Guardian RT does not display a low glucose value or give a low glucose alert. If you have any of the following symptoms, take a meter blood glucose reading, and check with your doctor before you treat:

- ➡ sweating
- ➡ dizziness
- ➡ palpitations
- ➡ trembling
- ➡ confusion
- ➡ headache
- ➡ speech impairment
- ➡ drowsiness
- ➡ hunger
- ➡ blurred vision

Symptoms of Hyperglycemia

Hyperglycemia (high blood glucose) may develop if you do not have enough insulin. There are symptoms linked to high blood glucose that should not be ignored no matter how mild they are, even if the Guardian RT does not display a high glucose value or give a high glucose alert. If you have any of the following symptoms, take a meter blood glucose reading, and check with your doctor before you treat:

- ➡ fatigue
- ➡ blurred vision
- ➡ excessive thirst
- ➡ hunger
- ➡ frequent urination

Blood Glucose Meter

Be sure to periodically maintain your home blood glucose meter periodically, and check its accuracy when using it for calibration of your Guardian RT system. Check with your BG meter's user guide for information on meter coding, calibration, and testing against solutions and other laboratory instruments. Ask your doctor about verifying the relative accuracy of your meter, or to find a BG meter that is right for you.

Now that you are ready to use the Medtronic MiniMed Guardian RT, there is a Start-Up process that you must follow to ensure a rewarding glucose sensing experience. Read the Quick-Reference section below, as it outlines the steps needed to successfully operate the Guardian RT. Use this section as a general reference guide. But please read the rest of this chapter carefully for the detailed steps needed to Program the Monitor and Set up the Sensor.

NOTE - If the ACT button has not yet been pressed, mistakes in programming often can be fixed by simply waiting 10-20 seconds without pressing any buttons.

Quick-Reference Guide

PROGRAM MONITOR

- ➡ Set Language
- ➡ Select Time Display Format
- ➡ Set Date and Time
- ➡ Clear Glucose History
- ➡ Set Glucose Units
- ➡ Set Low Alert
- ➡ Set High Alert
- ➡ Set Alert Type
- ➡ Enter Transmitter ID

SENSOR START

- ☐ Clean Site
- ☐ Insert Sensor
- ☐ Affix Transmitter to Skin
- ☐ Perform Search
- ☐ Connect Sensor to Transmitter
- ☐ Verify Initialization
- ☐ Place Tape Over Sensor and Connector
- ☐ Enter BG for Calibration at End of Initialization

ROUTINE OPERATION

- Review Glucose Sensor Values
- Check Sensor Signals Periodically
- Check BG Due Status
- Enter BG Values for Calibration
- Enter Events: Insulin, Meals, Exercise, Others
- Set High Alarm Snooze as Needed
- Modify Alarm Limits for Overnight and Daytime
- Address Alarms and Follow Up Actions
- Enter BG Values for Calibration in Response to High and Low Alarms
- Check Sensor Site Periodically
- Replace Tape and Secure Transmitter As Needed
- Replace Sensor at 72 Hours
- Code BG Meter When Changing Test Strip Lots, and Run Controls

LIST OF ALARMS

See Chapter 4, *Troubleshooting and Alarms*, for More Information.

- ❑ No ID (C52): Missing Transmitter ID in Setup
- ❑ Sensor Glucose HIGH: Sensor Glucose Above High Setting
- ❑ Sensor Glucose LOW: Sensor Glucose Below Low Setting
- ❑ Check Glucose Sensor (C54): Sensor Current Outside Range
- ❑ Low BATT: Monitor Batteries are Running Low
- ❑ Off/No Power: Monitor Batteries are Used Up
- ❑ Service C60/C61: Transmitter Battery is Low or Used Up
- ❑ Re Init C62: Setup Information Not Received by Monitor
- ❑ No Sync (C76): Monitor Lost Communication with Transmitter
- ❑ Cal Err (Calibration Error): Last BG Entry Differed from Expected Reading
- ❑ Key Held (C77): Button Pressed for Too Long/Button Stuck
- ❑ Enter BG (C78): Enter New BG Value for Calibration
- ❑ Set Time (C79): Time Reset to Default
- ❑ Replace Sensor (C80): No More Glucose Readings/End of Sensor Life
- ❑ System Alarms (F###): System Diagnostic Problem
- ❑ Test Plug Procedure

Start-Up Process

Installing the Batteries

The Monitor uses two (2) AAA alkaline batteries. When changing out used-up batteries, make sure to use new batteries. The Monitor will alert you when a battery change is needed. Batteries should be installed right after unpacking the Guardian RT.

NOTE - *Use only disposable AAA alkaline batteries in the Monitor. Do not use rechargeable batteries or other battery types. These batteries can damage the Monitor or affect Monitor operation.*

If batteries are not changed within 10 minutes of taking out a used-up set, an alarm will be triggered, and the Sensor will have to be replaced. (See Chapter 4: Troubleshooting and Alarms.) Be sure to have a new set of batteries ready when replacing the old set.

In order to properly save and keep stored Monitor information, always turn the Monitor off before changing batteries.

4. Find the battery compartment on the back side of the Monitor.
5. With the screwdriver provided, loosen the screw while holding the Monitor's battery compartment lid. Do not try to fully remove the screw; it is meant to stay attached to the lid.
6. Take off the battery compartment lid.
7. If you are changing batteries, first pull on the ribbon to loosen. Next, take out the old batteries with your fingers.

<p>CAUTION: If the batteries are put in with the positive and negative terminals switched, they will become very warm, and the Monitor will not work. Carefully, place the batteries in the Monitor correctly.</p>

8. Place the battery strap around the new batteries. Refer to the diagram on the inside of the battery compartment lid.

9. Put in the new batteries, following the diagram on the bottom of the compartment. (See Figure 2.1)

Figure 2.7



10. Place the battery compartment lid back into place, aligning it correctly against compartment seal.
11. With the screwdriver, tighten the screw to close the battery compartment and hold the lid in place. Do not overtighten lid.

NOTE - After changing the batteries, all programmed settings should be checked, and changed if needed.

CAUTION: Batteries must be recycled or disposed of properly. Do not dispose of batteries by putting them in fire.

NOTE - If Monitor display is blank, or not responding to button presses, U.S. and Canadian customers please contact the Product Help Line at 800-MINIMED (800-646-4633) or 818-576-5555. All other international customers please contact your local sales office.

Turning On the Monitor

NOTE - *The Monitor will turn on and automatically run a self-test when batteries are put in correctly.*

NOTE - *If the Monitor does not turn On, and before that you got a LOW BATT alarm, change out the batteries.*

1. Press the On/Off () button.
2. The Monitor will beep and vibrate, display the software version used, and display the HOME screen.

NOTE - *Every time the Monitor is turned on, a test is run. If a problem is found, it will trigger an audible (or vibrating) alarm and an error message. See Chapter 4: Troubleshooting and Alarms.*

Turning Off the Monitor

Information, including the Sensor values gathered before the Monitor was turned off, will be saved in the Monitor. No new information will be collected.

1. Press the On/Off button.
2. The Monitor will beep or vibrate, and CONFIRM will blink on the screen.
3. Press ACT to confirm. If you don't, the Monitor will stay on and return to the HOME screen.
4. The screen will go blank when successfully turned off.

Home Screen

The HOME (Time of Day) screen for the Monitor shows the time in the upper left-hand corner. Once the Search procedure has been successfully done, the antenna icon () will show that the Monitor is getting information from the Transmitter, i.e., telemetry has been achieved. The antenna icon will stay on the screen as long as there is telemetry. This screen, as shown to the right, is displayed if no buttons have been pressed or no alarms/alerts have been triggered. From any screen, if no buttons are pressed, the Monitor will “time out” and return to the HOME screen.

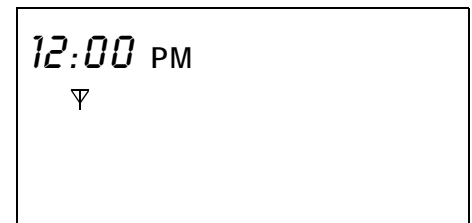

The Main Screens

There are eight main screens in the Guardian RT Monitor: HOME (TIME AND ALARM), GLUCOSE HISTORY, METER BLOOD GLUCOSE (BG), EVENTS, GLUCOSE ALARMS HISTORY, SEARCH, SIGNALS and SETUP. You can enter any of these screens from the one before by pressing SEL and then ACT. Figure 2.2 describes the screen flow. These screens will be explained in detail in *Chapter 3: Routine Operation*.

Figure 2.8

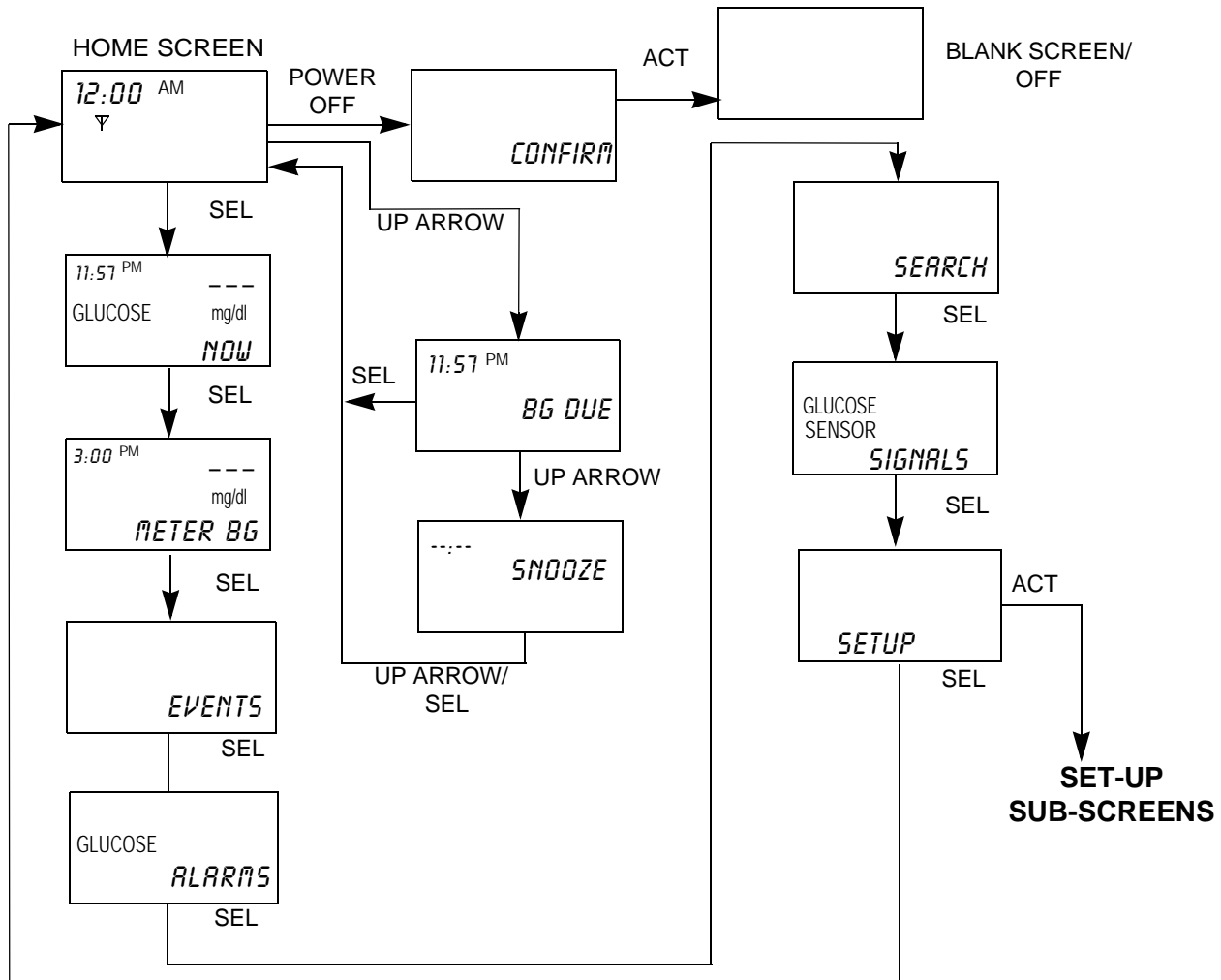

Programming the Monitor

There are ten Setup subscreens in the Guardian RT Monitor: LOW, HIGH, ALERT, SET TIME, DISPLAY, UNIT, TRANS ID, CLEAR, LANGUAGE, and EXIT. To get to these subscreens: From the HOME Screen (See Figure 2.2) press the SEL button 7 times to reach the SETUP Screen, and press the ACT button to enter. Then press SEL to scroll through the subscreens and ACT to enter any given one. The subscreens have to be programmed before starting on the Guardian RT. This process will be explained in the following pages. Figure 2.3 describes the subscreen flow.

SET-UP SUB-SCREENS

Figure 2.9

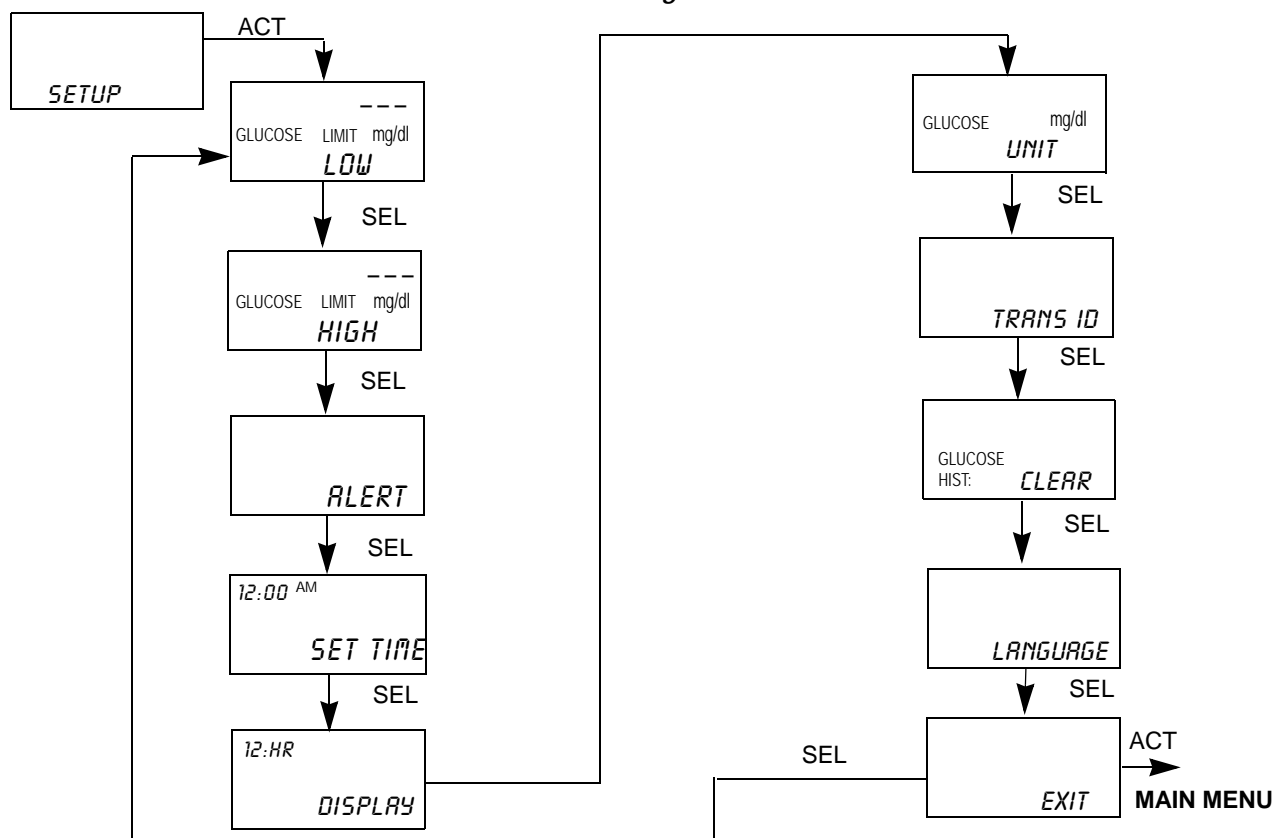

NOTE - Always set time and date before using the Monitor for the first time.

Setting the Language

The Guardian RT offers the choice of displaying Monitor information in seven different languages: English, French, Spanish, Italian, Swedish, German and Dutch.

From the HOME screen:

1. Press **SEL** 7 times to get to the SETUP screen.
2. Press **ACT** once.
3. Press **SEL** 8 times to get to the LANGUAGE screen.



4. Press **ACT**. The screen will display the word ENGLISH blinking.
5. Use Up or Down arrow button to scroll through the different languages. Each language will appear blinking until selected when the **ACT** button is pressed.
 - a. With each press of the **Up arrow button**, this is the language order as it appears on the screen:
English → French → Spanish → Italian → Swedish → German → Dutch
 - b. With each press of the **Down arrow button**, this is the language order as it appears on the screen:
English → Dutch → German → Swedish → Italian → Spanish → French
6. Press **ACT** to choose the desired language.
7. The display will change to the EXIT screen. The screen information will now be shown in the chosen language.

NOTE - *If when on a language screen SEL is pressed instead of ACT, the display will go to the EXIT screen, and the language change will not be made.*

8. Press **ACT** to return to the HOME screen.

Setting the Time Display Format

The Monitor gives you a choice of using either 12 or 24-hour time format.

From the HOME screen:

1. Press the **SEL** button 7 times until the SETUP screen appears.
2. Press the **ACT** button once to get to the SETUP sub-screens.
3. Press the **SEL** button 4 times until the DISPLAY sub-screen appears.

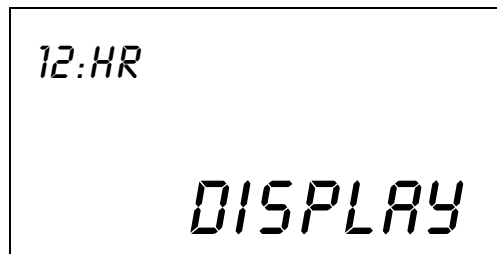

4. Press the **ACT** button once and the upper left-hand corner of the screen will be blinking. The word SET will appear under the blinking number. Use the Up or Down arrow button to choose either "12" (AM/PM) or "24" (International) which is the time format to be used.



or

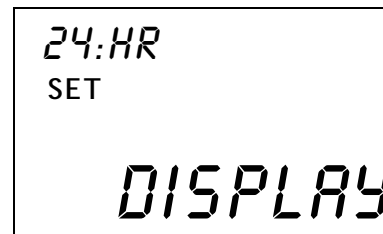

5. Press the **ACT** button to set the time format.
6. Press the **SEL** button and the Monitor will go to the UNIT sub-screen. Press **SEL** 4 times to go to EXIT. Press **ACT** to go back to the HOME screen.

Setting the Time and Date

NOTE - All steps to set up the Time and Date must be done, or the time and date will not be saved.

NOTE - If the SEL button is pressed while in a Time/Date subscreen, the display will automatically change to the Time Display option.

From the HOME screen:

1. Press the SEL button 7 times until the SETUP screen appears.
2. Press the ACT button once to get to the SETUP sub-screens.
3. Press the SEL button 3 times until the SET TIME sub-screen appears.

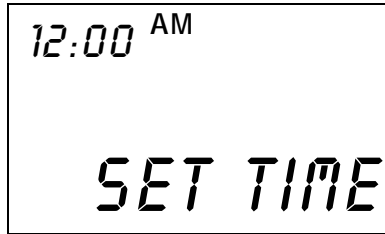

or

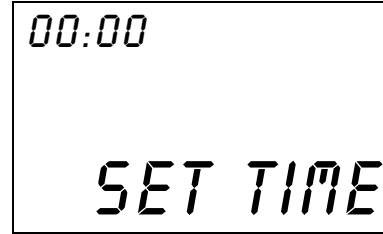

Setting the Current Hour

1. Press the ACT button once, and the word HOURS will appear. The first two digits will be blinking, and the word SET will appear.

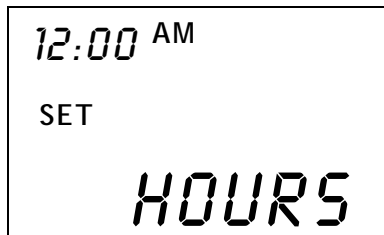

or

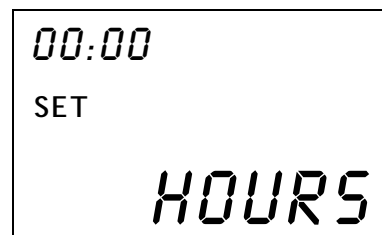

2. Use the Up or Down arrow button to choose the correct hour. If using the 12-hour format, make sure the screen shows the correct AM or PM text. For example: AM is displayed and you need PM; press the Up or Down arrow to scroll through the times until the correct time with PM appears.
3. If using the 24-hour time format, choose hours between "0" and "23."
4. Press the ACT button once, and the word MINUTES will appear.

Setting the Current Minutes

1. The word MINUTES will now appear with the last two digits of the time blinking.

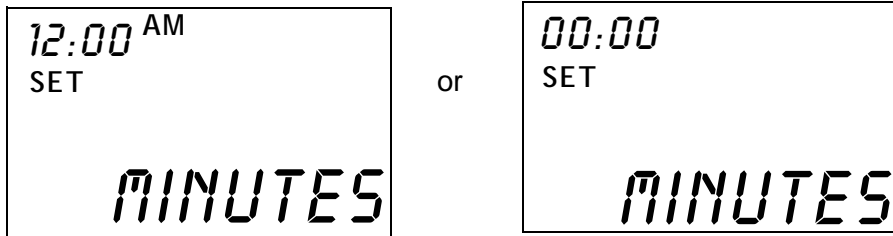

2. Use the Up or Down arrow button to choose the current minute from "00" to "59."
3. Press the ACT button once, and the word YEAR will appear.

Setting the Current Year

1. The YEAR will now appear with the number "00" blinking in the upper right-hand corner of the screen. The starting year is 2000.
2. Use the Up or Down arrow button to choose the last two digits of the current year. For example: "00" is entered for the year 2000, and "04" is entered for the year 2004, etc.
3. Press the ACT button once, and the word MONTH will appear.

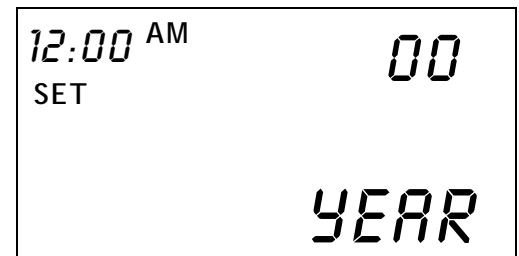

Setting the Current Month

1. The word MONTH will now appear with the number "01" blinking in the upper right-hand corner of the screen. Use the Up or Down arrow button to choose the digits for the current month. For example: "01" is entered for the month of January, "02" is entered for the month of February, "03" is entered for the month of March, etc.
2. Press the ACT button once, and the word DAY will appear.

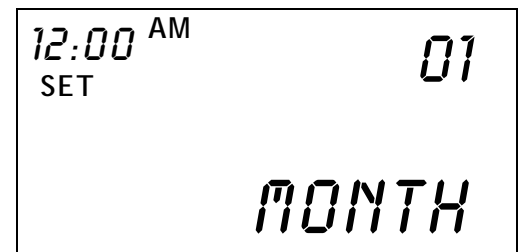

Setting the Current Day

1. The word DAY will now appear with the number "01" blinking in the upper right-hand corner of the screen.
2. Use the Up or Down arrow button to choose the digits for the current day of the month, from 1 to 31.
3. Press the **ACT** button once to save date and time values chosen.
4. The current time and date will appear briefly, and the Monitor will go to the DISPLAY sub-screen. Press **SEL** 5 times to go to EXIT. Press **ACT** once to return to the HOME screen.

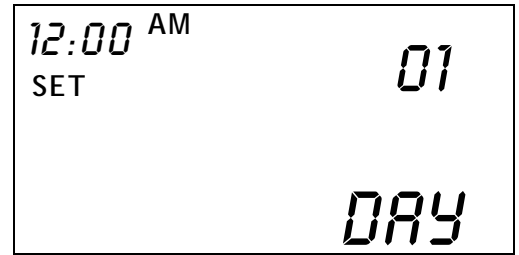

Clearing the Glucose History

NOTE - If there is data in the Monitor that you want to save, download the data using the Com-Station and Guardian Solutions Software before clearing the history.

NOTE - You only need to clear the Monitor glucose history prior to first-time use, between different users, or at the end of any training or demo sessions prior to first-time use. Glucose history data in the Monitor overwrites itself automatically, so you do not need to clear the history on a regular basis.

The Monitor glucose history should be cleared before first-time use. This is to make sure that the memory is free of unwanted information.

From the HOME screen:

1. Press the **SEL** button 7 times until the SETUP screen appears.
2. Press the **ACT** button once to get to the SETUP sub-screens.

3. Press the SEL button 7 times until the CLEAR sub-screen appears.



4. Press the ACT button once. The Monitor will beep, and the word NO will appear on the screen blinking.

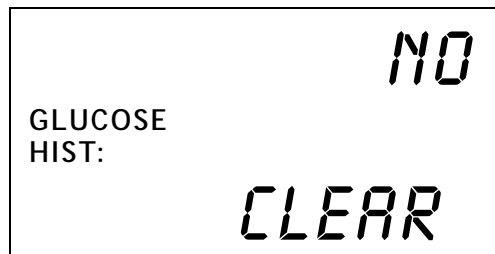

5. Use the Up or Down arrow button to choose between YES and NO. Select YES to clear the Monitor memory.
6. With YES displayed on the screen, press the ACT button once. The Monitor will display YES with CONFIRM blinking.

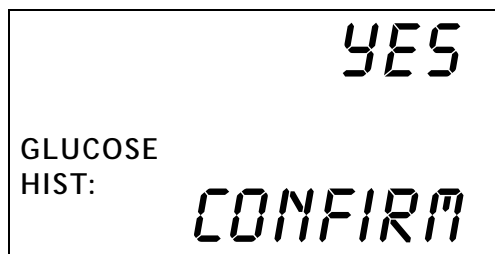

7. Press the **ACT** button again. The Monitor will beep or vibrate and the word **CLEARING** will appear for a few seconds.

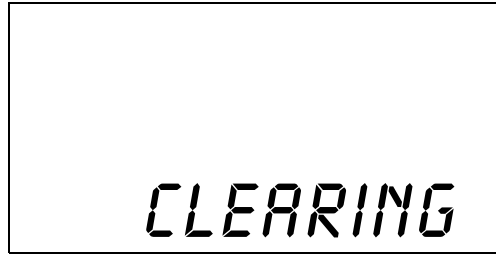

8. The Monitor will then go to the LANGUAGE screen. The memory will now be cleared. Press **SEL** to go to the EXIT screen, followed by **ACT** to go back to the HOME screen.
9. If **NO** is selected, the Monitor memory will **NOT** be cleared, and the Monitor will go to the LANGUAGE screen. Press **SEL** to go to the EXIT screen, followed by **ACT** to go back to the HOME screen.

Setting the Glucose Unit

The Monitor gives you a choice of entering meter BG values and setting the low blood glucose and high blood glucose limits in either mg/dl or mmol/l.

From the HOME screen:

1. Press the **SEL** button 7 times until the SETUP screen appears.
2. Press the **ACT** button once to go to the SETUP sub-screens.
3. Press the **SEL** button 5 times until the UNIT sub-screen appears.

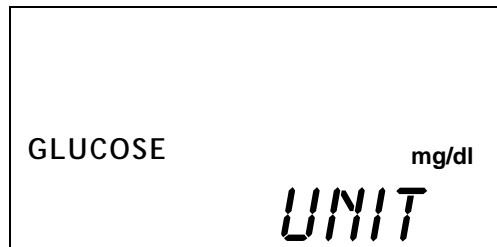

4. Press the **ACT** button once, and use the Up or Down arrow button to choose either mg/dl or mmol/l.

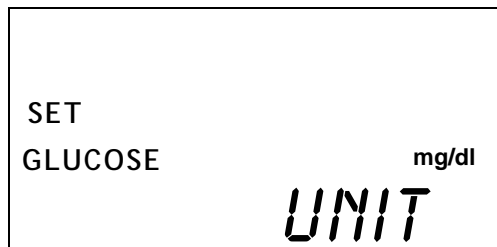

5. Press the **ACT** button again to save the chosen units, and the Monitor will go to the ID sub-screen. Press **SEL** 3 times to go to EXIT, and press **ACT** one to go back to the HOME screen.

Setting the Low Glucose Alert

The Monitor is designed to alert the user when the system finds glucose values at or above the set high glucose limit, or at or below the set low glucose limit. These alerts may be turned off if not needed or wanted. If an alert is triggered, you should confirm the glucose value with a home glucose meter before taking any action. Also, you should use a home blood glucose meter to confirm the symptoms of high and low blood glucose. (See *Chapter 1: Introduction* for a list of symptoms.)

The low glucose alert can be set from 40-100 mg/dl (2.2-5.5 mmol/l). Enter a glucose value within this range to set a low glucose alert. Typically, the number entered is above the value that causes you to have symptoms of low blood glucose. **Confirm the alert limit with your doctor.**

For this feature to work, you must select ON, a value, and CONFIRM to save the value in memory. **Always treat low blood glucose per the advice of your doctor and the readings of your blood glucose meter.**

From the HOME screen:

1. Press the SEL button 7 times until the SETUP screen appears.
2. Press the ACT button once to go to the SETUP sub-screens.

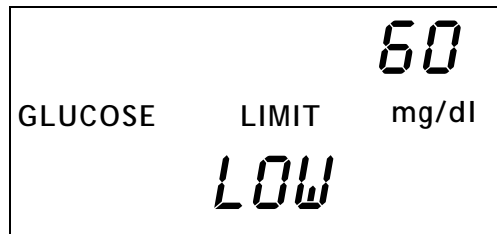

3. The LOW Limit sub-screen will automatically appear with the previously set low-glucose limit (or the default value of 60 mg/dl (3.3 mmol/l)) showing in the upper right hand of the display.
4. Press the ACT button and the following screen appears with ON (default setting) blinking:

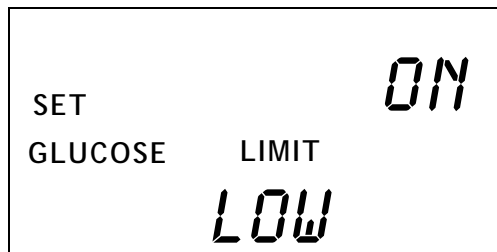

5. Press the Up or Down arrow button to choose either ON or OFF or rEP (Repeat Function - See Next Page). If you do not want to use this feature, choose OFF and the low glucose alert feature will be turned off.
6. Press the **ACT** button.
7. If ON is entered, the current value will begin blinking.

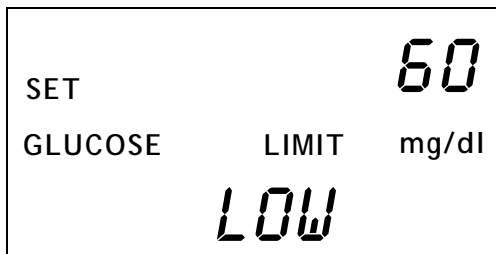

8. Use the Up or Down arrow button to choose the value you want to set a low glucose alert. Press the **ACT** button to save the chosen value. The value 65 mg/dl (3.6 mmol/l) has been entered in this example.



NOTE - *Since it takes time for the Guardian RT to collect and measure glucose values, there is a delay in triggering the alert. Ask your doctor which low glucose limit is right for you.*

9. Press the **ACT** button to confirm the chosen value. The screen will go to the HIGH sub-screen. If you would like, program the HIGH Limit as well. If not, press **SEL** 8 times to go to EXIT. Press **ACT** once to go back to the HOME screen.
10. If you do not want to use this feature, repeat steps 1-4, and then use the Up or Down arrow button to select OFF and press the **ACT** button. A CONFIRM screen will be displayed. Press the **ACT** button once more to set, and the low glucose alert feature will be turned off.

11. To customize the time delay for a specific time period between recurrences of the LOW glucose alert, repeat steps 1-4. Next, use the Up or Down arrow button to select rEP (blinking), and press the ACT button.

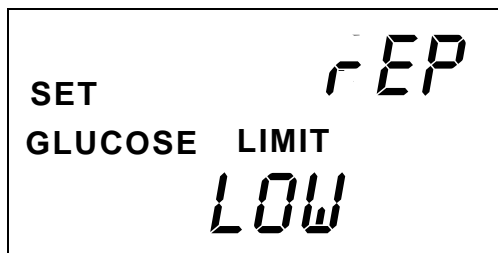

12. The previously set time interval (or 20 minutes default) will be blinking. Use the Up or Down arrow button to select the desired interval, in 10-minute increments, from 20 minutes to 60 minutes (1 hour). Press the ACT button. The CONFIRM screen will be displayed. Press the ACT button to set.

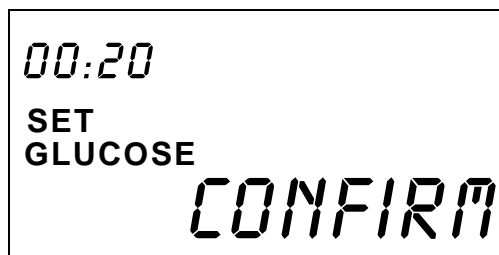

NOTE - *Ask your doctor to which Repeat time interval is right for you.*

NOTE - *If after setting a REPEAT interval you change either the REPEAT setting and/or the Low Alert limit setting, the system will reset, and the Low Glucose Alert will be activated once more.*

Setting the High Glucose Alert

The high glucose alert range is 105-400 mg/dl (5.8-22.2 mmol/l). Enter a glucose value within this range to set a high glucose alert. Typically, the number entered is below the value that causes you to have symptoms of high blood glucose. **Confirm the alert limit with your doctor.**

For this feature to work, you must select ON, a value, and CONFIRM to save the value in memory. **Always treat high blood glucose per the advice of your doctor.**

From the HOME Screen:

1. Press the **SEL** button 7 times until the SETUP screen appears.
2. Press the **ACT** button once to go to the SETUP sub-screens.
3. Press the **SEL** button once until the HIGH Limit sub-screen appears. The previously set high-glucose limit (or the default value of 200 mg/dl (11.1 mmol/l)) will appear in the upper right hand of the display.



4. Press the **ACT** button and the following screen appears with ON (default setting) blinking:



5. Press the Up or Down arrow to choose either ON or OFF or rEP (Repeat). If you do not want to use this feature, choose OFF and the high glucose alert feature will be turned off.

- If ON is activated, the default value will be blinking.

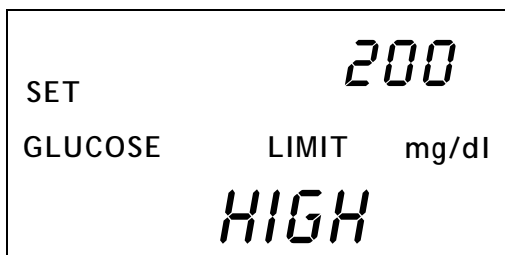

- Use the Up or Down arrow button to choose the value you want to set a high glucose alert.
- Press the **ACT** button to save the chosen value. The following screen will appear with CONFIRM blinking. The value 240 mg/dl (13.3 mmol/l) has been entered in this example.

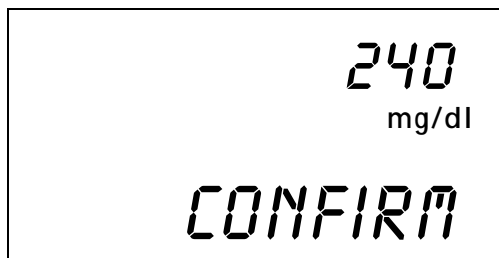

NOTE - Since it takes time for the Guardian RT to collect and measure glucose values, there is a delay in triggering the alert. Ask your doctor which glucose limit is right for you.

- Press the **ACT** button to confirm the chosen value. The screen will go to the ALERT sub-screen. Press SEL 7 times to go to EXIT. Press **ACT** once to go back to the HOME screen.
- If you do not want to use this feature, repeat steps 1-4, and then use the Up or Down arrow button to select OFF and press the **ACT** button. A CONFIRM screen will be displayed. Press the **ACT** button once more to set, and the high glucose alert feature will be turned off.

11. To customize the time delay for a specific time period between recurrences of the HIGH glucose alert, repeat steps 1-4. Next, use the Up or Down arrow button to select rEP (blinking), and press the ACT button.

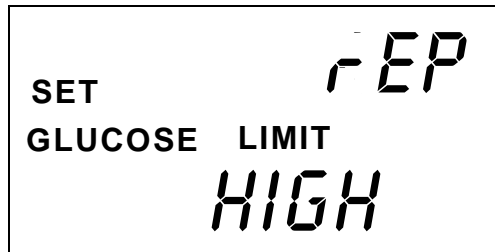

12. The previously set time interval (or 1 hour default) will be blinking. Use the Up or Down arrow to select the desired interval, in 30-minute increments, from 60 minutes to 180 minutes (3 hours). Press the ACT button. The CONFIRM screen will be displayed. Press the ACT button to set.



NOTE - *Ask your doctor which Repeat time interval is right for you.*

NOTE - *If after setting a REPEAT interval you change either the REPEAT setting and/or the High Alert limit setting, the system will reset and the High Glucose Alert will be activated once more.*

Setting the Alert Type

The Set Alert feature gives the choice of BEEP, VIBRATE, or BOTH whenever an alert is triggered. The default setting for the Monitor is the audible BEEP. Choose the Alert type as follow:

From the HOME screen:

1. Press the SEL button 7 times until the SETUP screen appears.
2. Press the ACT button once to get to the SETUP sub-screens.
3. Press the SEL button 2 times until the ALERT sub-screen appears.



4. Press the ACT button once, and the word BEEP (default setting) will appear blinking. Use the Up or Down arrow button to choose BEEP, VIBRATE, or BOTH.
5. Press the ACT button again to save your choice in the Monitor memory. If the VIBRATE alert has been chosen, the Monitor will vibrate briefly and go to the SET TIME and DATE screen.



- If you choose the BEEP or BOTH alert, a number 2 (default) will appear blinking above the words BEEP VOL. You can choose between three different beep volumes: 1 = Low, 2 = Medium, and 3 = High. Use the Up or Down arrow button to choose 1, 2, or 3. (While scrolling, corresponding beep tones will sound.)



- Press the ACT button to save your choice. The Set Time and Date screen will appear. Press SEL 6 times to go to EXIT. Press ACT to go back to the HOME screen.

Entering the Transmitter ID

Each Transmitter is given a unique 7-digit identification number in the factory, from 0000001 to 9999999, which is the serial number shown on the Transmitter device label. This number (including leading zeros) must be entered into the Monitor before glucose data sent from the Transmitter can be received and stored in the Monitor. This will limit the Monitor to only receive data from the Transmitter with that ID number. If a different Transmitter is used, the new Transmitter ID must be entered.

From the HOME screen:

- Press the SEL button 7 times until the SETUP screen appears.
- Press the ACT button once to go to the SETUP sub-screens.
- Press the SEL button 6 times until the ID sub-screen appears.

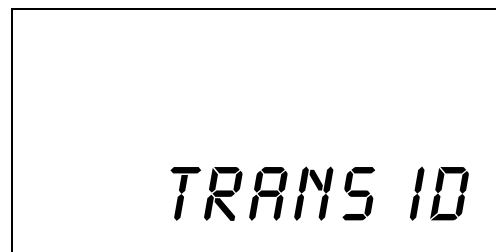

- Press the ACT button, and a 0000000 number will appear with the first digit blinking. Use the Up or Down arrow button to choose the first digit in your Transmitter ID number.

5. Press the **ACT** button again to go to the second digit.
6. The second digit will now be blinking. Use the Up or Down arrow button to choose the second digit in your Transmitter ID number.
7. Press the **ACT** button once again to go to the third digit.
8. Keep using the Up or Down arrow to choose numbers for each of the digits left. Then press the **ACT** button to go to the next digit. The example below uses 7596.

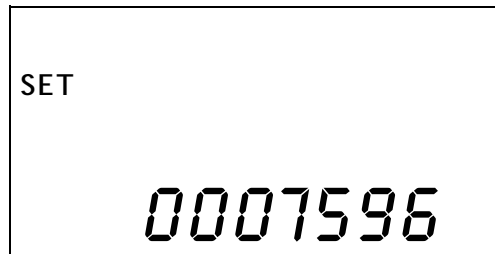

NOTE - *If the ID number is less than 7 digits, make sure leading zeros are entered.*

9. Press the **ACT** button after the 7th digit has been entered to save the ID in the Monitor. Press **SEL** 2 times to go to the EXIT screen, followed by **ACT** to go back to the HOME screen.

Inserting the Sensor

Before handling the Sensor, wash hands thoroughly. Choose a site with enough subcutaneous fat for Sensor insertion. The abdominal area and upper buttocks are the best and most common-used sites for insertion of the Glucose Sensor. See Figure 2.4 for all body areas where the Glucose Sensor can be inserted.

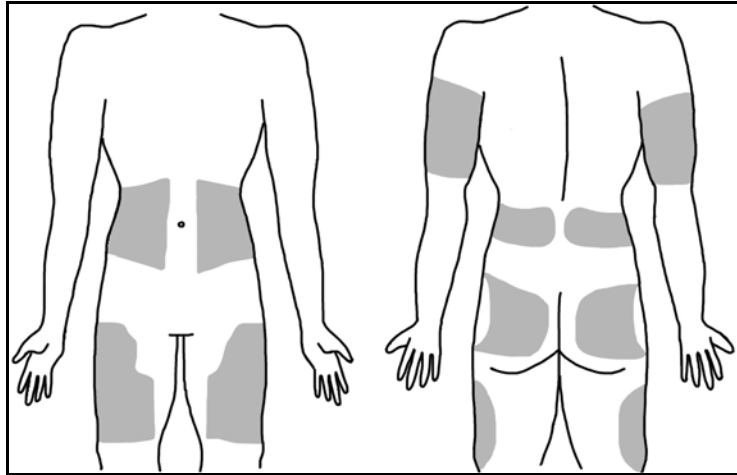

Figure 2.10

As a rule, AVOID the following areas:

- Frequently used injection or pump sites. (Never insert Sensor closer than 3 inches (7.62 cm) from pump infusion site or manual injection site.)
- Belt or waistline
- Within 2-inch (5.08 cm) area around navel or less than 3 inches (7.62 cm) from pump infusion site or manual injection site.)
- Site where clothing will rub or press against the Sensor
- Scarred or atrophied tissue
- Areas experiencing a lot of movement

NOTE - *Clean site with alcohol, making sure site is dry before inserting Sensor. Do NOT use skin-prep solutions prior to insertion. However, I.V. Prep may be used after insertion and before applying a sterile dressing. Lift back of tape slightly to apply I.V. Prep.*

CAUTION: Do not connect Sensor to Transmitter at this time.

1. Carefully open sterile Sensor pouch, and take out Sensor from package by holding base or tape. Do not hold Sensor by introducer needle handle. Place the Sensor in the Sen-serter until it fits snugly.

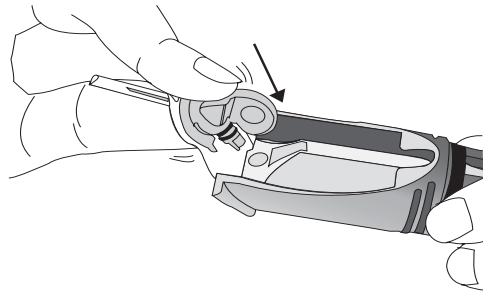

2. Hold Sen-serter as shown:

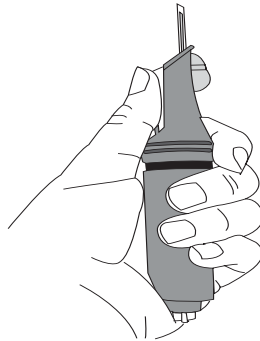

3. Secure white tape of Sensor, and take off clear tape using counterclockwise motion.

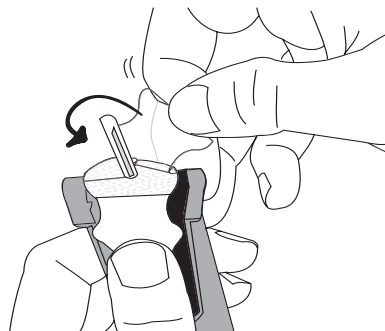

4. Place fingers on back of white tape, and push carrier down until it clicks in place.

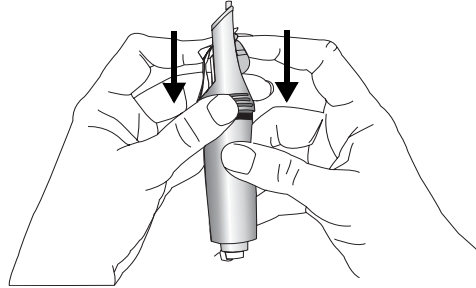

5. As a safety measure, when the Sen-serter is in the loaded position you can set the lock at the top of the device until you are ready to insert.
 - a. To Lock: Rotate the white knobs 90° away from the arrows on the side of the Sen-serter.

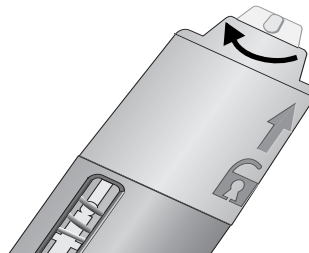

- b. To Unlock: Rotate the white knobs 90° so that they align with the arrows on the side of the Sen-serter.

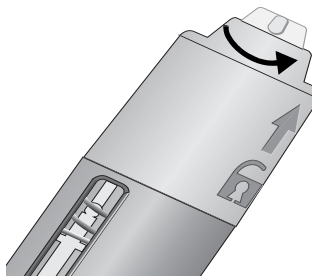

6. Take off needle guard from introducer needle.

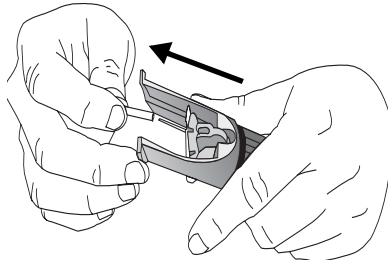

NOTE - *While the use of gloves at this point is required for clinicians, it is optional for patients.*

7. Rest Sen-serter legs against skin at 45-degree angle, placing two fingers of opposite hand on Sen-serter legs to keep this angle.

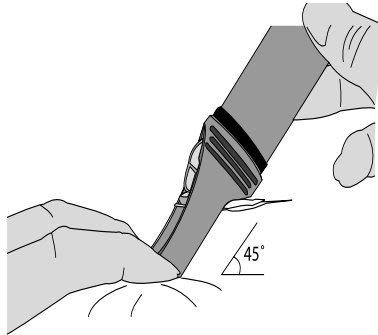

NOTE - *Sensor may not penetrate skin if insertion angle is less than 45 degrees.*

8. Press white button to insert Sensor, checking to see that Sensor is inserted and flush with skin

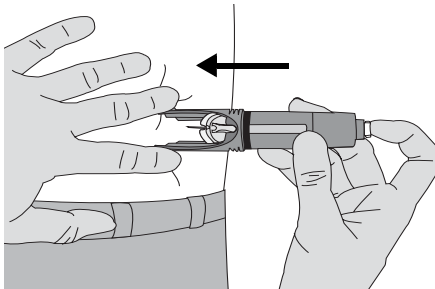

9. While holding Sensor in place, gently slide Sen-serter away from Sensor. Do not twist, bend or lift Sen-serter while taking it off Sensor.

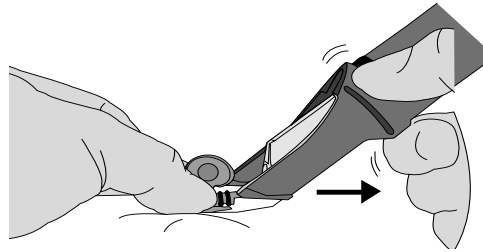

10. Holding Sensor base, take off white paper from adhesive pad. Press adhesive against skin.

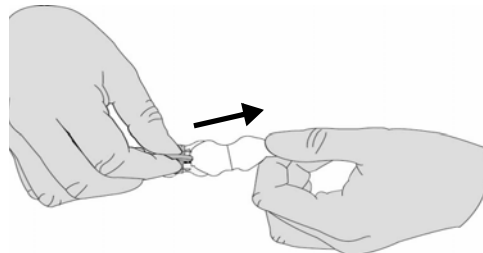

11. Hold Sensor with two fingers on base, and gently take out introducer needle at 45-degree angle.
- Do NOT rotate introducer needle when taking it out
 - Throw away needle in sharps container
 - Check site for redness, bleeding, irritation, pain, tenderness or swelling

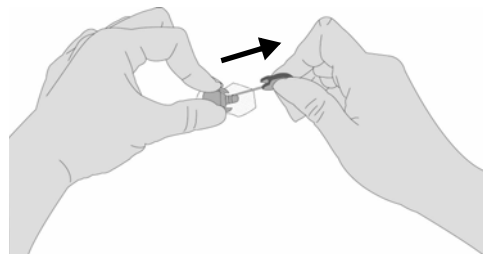

NOTE - *The expected life of the Sensor is at least 24 hours and is good for up to 72 hours of use. Replace Sensor at 72 hours, or earlier in the event of a REPLACE SENSOR (C80) alarm. If these alarms are triggered, follow instructions in Chapter 4: Troubleshooting and Alarms.*

Sensor Storage and Handling

- Store Sensors in refrigerator at +36° to +50°F (+2° to 10°C). Do not freeze.
- Before opening, allow individual Sensor package to reach room temperature and 5% to 95% relative humidity to avoid condensation.
- Sensors taken out of refrigeration must be kept at or below room temperature, +50° to +75°F (+10° to 24°C), and used within 1 week to ensure Sensor sensitivity.
- Throw away Sensor after “Use Before” expiration date on label, or if the package is damaged or the seal broken.
- Do not use Sensor if High temperature-limit indicator is black (not clear).

Sen-serter Maintenance

- Occasionally clean Sen-serter with soapy water, using liquid detergent or other household soaps. Allow to dry.
- Disinfect Sen-serter by wiping with 10% bleach solution or 70% isopropyl alcohol as needed.
- Always store Sen-serter in the released position to ensure peak product performance and life.

Affixing the Transmitter

1. Find a comfortable, protected area on the abdomen (away from the belt-line) that is within Cable reach of the Sensor. Clean the area with isopropyl alcohol and allow to dry.
2. Use the disposable Transmitter adhesive pad (MMT-7006) to affix the Transmitter to your body.
3. Take off the paper backing from the Transmitter side of the adhesive pad (side labeled "1").
4. Stick the adhesive pad to the smooth, flat, unlabeled side of the Transmitter.
5. Take off the paper from the skin side of the adhesive pad (side labeled "2"). Press firmly to prepped skin.
6. Transmitter should now be affixed to skin with serial number facing outward.

CAUTION: Do not connect Sensor to Transmitter at this time. Do a **SEARCH** for the Transmitter first.

NOTE - An adhesive remover, such as Detachol[®], can be used to take off the adhesive pad, or any adhesive residue left on the skin after taking off the pad. Use a product tested for use on skin, and follow the product's instructions.

Searching for the Transmitter

The Search procedure starts communication so that the Monitor can receive and recognize the data signals from the Transmitter.

NOTE - *Before starting a SEARCH, make sure the Transmitter ID has been entered into the Monitor.*

Caution: Do not press any button on the Monitor while doing a Search. This interferes with the Search action.

From the HOME screen:

1. Press the SEL button 5 times until the SEARCH screen appears.



2. Press the ACT button and the Monitor will beep or vibrate, and CONFIRM will be blinking on the screen.
3. Press the ACT button again to begin a SEARCH. The screen will display WAITING and a countdown clock starting at 8 minutes and 00 seconds. The countdown will be in 10-second intervals. **Connect Sensor to Transmitter at start of countdown.** It may take up to 8 minutes to finish the SEARCH.

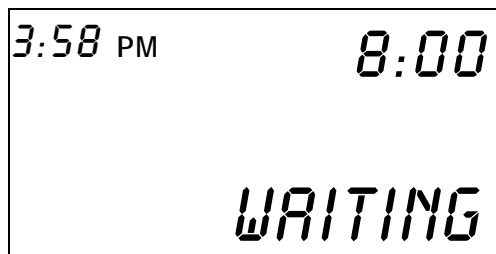

4. If you want to cancel the SEARCH, press SEL. The Monitor will beep or vibrate, and CONFIRM will be blinking on the screen. Press ACT to confirm.

Connecting the Sensor to the Transmitter

NOTE - *To extend Transmitter battery life, do not leave Sensor or Test Plug connected to the Transmitter when system is not in use.*

1. With the Monitor in SEARCH mode, hold the base of the Sensor between the thumb and forefinger so that it doesn't move. Hold the Transmitter connector in the other hand. Place the Sensor connector so that the two connectors are closely aligned. Push together to connect the Transmitter to the Sensor. You should hear a click when fully connected. (See Figure 2.5.)



Figure 2.11

2. The Monitor will search for signals sent by the Transmitter. If the Transmitter is not identified by the Monitor, an alarm code will appear. See *Chapter 4: Troubleshooting and Alarms* for detailed information on Alarm codes.
3. When the Transmitter is identified by the Monitor, the screen will briefly display SUCCESS. The INIT screen will then appear.

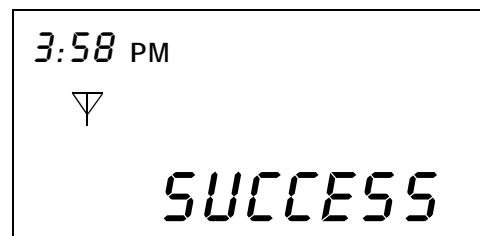

4. Cover the Sensor site with a sterile/snug dressing, such as IV3000®. (See Figure 2.6.)

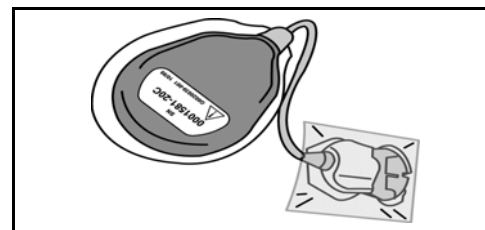
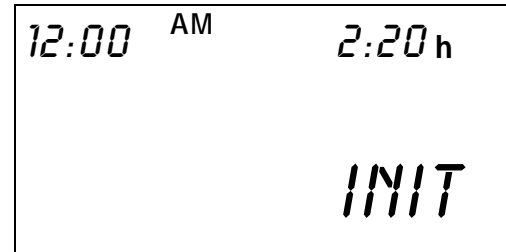

Figure 2.12

NOTE - *If the Transmitter is unplugged from the Sensor, wait 20 seconds before reconnecting in order to ensure normal operation*

Sensor Initialization

After the Transmitter Search is done, the SUCCESS screen will be briefly displayed. The INIT screen will then appear. The system automatically initializes the Sensor before starting to record glucose data. Initialization takes about 120 minutes (2 hours). The Monitor, however, will count down from 140 minutes (2 hours and 20 minutes) toward 0 hours and 0 minutes, or until finished (whichever comes first), in one-minute intervals.



Sensor Calibration

When initialization is done, the system will alarm and the Enter BG screen to the right will be displayed. This screen shows that calibration is needed. A fingerstick glucose value must be entered into the Monitor to calibrate the Sensor. The Guardian RT will not record or display any glucose values, and the High and Low glucose alerts will not work until calibration is done. Calibration is needed to make sure the Guardian RT can turn the electronic signals from the Sensor into glucose values. Make sure to enter a BG value right after taking a fingerstick glucose reading. Calibration will happen within 10 to 15 minutes of the Meter BG entry.



NOTE - Use the same blood glucose meter for all calibrations to ensure the accuracy of the calibrations.

NOTE - If an incorrect blood glucose value is entered, this value can be overwritten within 10-15 minutes of input.

1. Press the SEL button followed by ACT to clear the alarm.
2. Press the SEL button 2 times. When the METER BG screen appears, the last glucose value (mg/dl or mmol/l) entered will be displayed. (Dashes will appear the first time since no entry has been made.)



3. Press the **ACT** button, and the glucose value (dashes) will blink. Use the Up or Down arrow buttons to scroll through the values until the right one is displayed in increments of 1 mg/dl or 0.1 mmol/l. Holding down either button will scroll faster through the list of values. The METER BG feature lets you enter values from 20 to 600 mg/dl (1.1 to 33.1 mmol/l). However, only values between 40-400 mg/dl (2.2-22.2 mmol/l) are used for calibration.

*NOTE - The METER BG screen will display the last value programmed. But when **ACT** is pressed, the scrolling will start at "---" and the screen will read ENTER BG. If the Up or Down arrow is pressed, the next value scrolled to is 100 mg/dl (5.5 mmol/l). If **ACT** is pressed when "---" is displayed, no value is entered.*

4. Press the **ACT** button to save the right value. The Monitor will run a calibration and sensitivity check using the Meter BG value entered and the Sensor value that corresponds in time. Calibration occurs 10 to 15 minutes from the time of entering the fingerstick glucose reading.
5. The HOME screen will appear.

NOTE - The Monitor will not use values between 20-39 mg/dl (1.1-2.2 mmol/l) and 401-600 mg/dl (22.2-33.3 mmol/l) for calibration. These values will be displayed and saved for informational purposes only. BE SURE TO TREAT LOW AND HIGH CONDITIONS PER THE ADVICE OF YOUR DOCTOR. Also, when a value in the 40-400 mg/dl (2.2-22.2 mmol/l) range is displayed, ENTER BG will appear below it. When a value in the 20-39 mg/dl (1.1-2.2 mmol/l) or 401-600 mg/dl (22.2-33.3 mmol/l) ranges is displayed, NO CAL will appear below it.

NOTE - Every time you change your Sensor, a fingerstick glucose reading must be entered into the METER BG screen. A fingerstick glucose reading should be entered every 6 hours, however, a minimum of one meter reading must be entered every 12 hours. More frequent daily readings will optimize the accuracy of the Sensor glucose readings. If you have not entered a reading into the METER BG screen in 12 hours, a C78 (ENTER BG) alarm will be triggered. This alarm is also triggered if a calibration has not been done in the last 8 hours since the first calibration.

Calibration Pending

If a BG value has been recently entered, but the Up arrow is pressed from the HOME screen within 15 minutes of the entry, not giving the Sensor enough time to calibrate, the screen below will be displayed. The example 90 mg/dl (5.0 mmol/l) is the recently entered Meter BG value.



No Sync

If the Sensor is not in INIT, (Initialize mode) and still working, and the Guardian RT is not synchronized, then the screen below will be displayed. This means that the Monitor is not getting Sensor data from the Transmitter at this point in time.

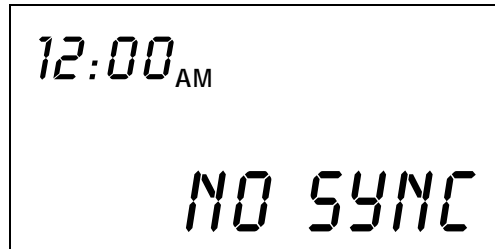

Replacing the Glucose Sensor

If the word REPLACE is displayed on the screen along with a time that is **not the current time** (i.e., the time displayed is a future time), the Sensor must be changed before the next calibration is due. The time displayed is the end of Sensor life. If REPLACE and the **current time** are displayed on the screen, then the Sensor is not working and the system is no longer sending Sensor glucose values. Change out the Sensor immediately to continue using the Guardian RT system.



Removing the Sensor

- ➡ Remove dressing
- ➡ Pinch snap arms on sides of Glucose Sensor, and gently disconnect Transmitter Sensor Connector from Glucose Sensor
- ➡ Slowly remove Glucose Sensor by pulling it parallel to the skin
- ➡ Throw away Sensor in Sharps or other biohazard container

NOTE - *To extend Transmitter battery life, do not leave Glucose Sensor connected to the Transmitter when system is not in use.*

This chapter explains how to use the Main Screens of the Guardian RT. From the HOME screen, press the SEL button to go to each of these operating screens. Press ACT to enter these screens.

NOTE - Pressing the **SEL** button from the **SETUP** screen will take you back to the **HOME** screen.

Glucose History

The glucose history will display the last 8 hours of glucose values. The oldest value will be displayed if the Up arrow button is pressed, or the newest (most recent) if the Down arrow button is pressed, for a total of 96 available entries. The history can be viewed in 5- or 30-minute increments. From the HOME Screen:

1. Press the **SEL** button once until the **GLUCOSE HISTORY** screen appears. In the example below, the most current glucose value is 108 mg/dl (6.0 mmol/l).

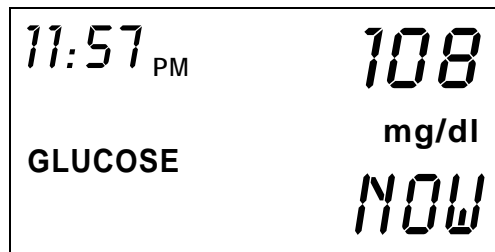

NOTE - The word **NOW** on the screen above refers to the current Sensor glucose value.

2. Scroll through the history by using the Up arrow button to go from oldest to newest glucose value in 5-minute increments. Press the Down arrow button to go from newest to oldest glucose value in 5-minute increments. In the example below, the glucose value was 112 mg/dl (6.22 mmol/l), 5 hours and 25 minutes ago.

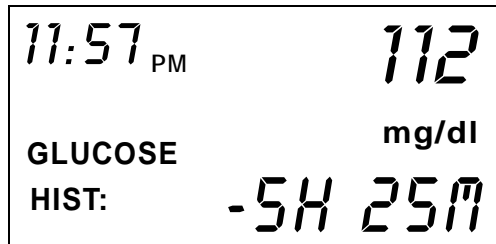

3. If the ACT button is pressed, the scrolling display will switch from 5- to 30-minute increments, and an asterisk (*) will be displayed next to the time increment. If you now press the Up arrow button, the history will go from oldest to newest glucose value in 30-minute increments. If you press the Down arrow button, the history will go from newest to oldest glucose value in 30-minute increments. In the example below, the glucose value was 96 mg/dl (5.33 mmol/l) 4 hours and 35 minutes ago. Press the ACT button to go back to scrolling in 5-minute increments. The asterisk will no longer be displayed.

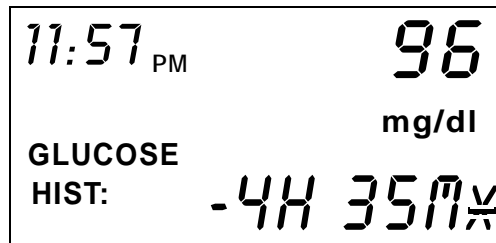

4. If the glucose value is lower or higher than operational range of 40-400 mg/dl (2.2 -22.2 mmol/l), the screen will display LO or HI where the glucose value is normally found. See example below.

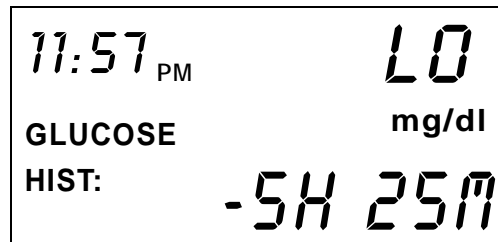

NOTE - When there is no calibration for the Sensor value, **NO CAL*** will be displayed on the bottom of the screen in place of **NOW**. In these cases, "----" will be displayed for the glucose value. When the Sensor value is unstable, **NOISE*** will be displayed on the screen. And when the Sensor value is unavailable due to bad or no telemetry, **MISSED*** will be displayed on the screen.

Entering Meter BG for Calibration

In order for the electronic signals from the Sensor to be converted into glucose values, Meter BG (Blood Glucose) readings must be entered into the Guardian RT for the purpose of calibration. *See Chapter 2: Getting Started, Sensor Calibration.*

From the HOME screen:

1. Press the SEL button 2 times and the METER BG screen will appear. In the example below, the last entered meter blood glucose value was 95 mg/dl (5.3 mmol/l). This value will thus appear on the display. (If no BG reading was entered before, dashes (" - - -") will appear on the screen.)



2. Press the ACT button, and the number display will go to dashes. Enter the desired meter blood glucose value, in increments of 1 mg/dl (0.1 mmol/l), by using the UP or Down arrow button. Remember, the number value will start at 100 mg/dl. *See Chapter 2: Getting Started, Sensor Calibration.*



NOTE - *If you scroll below 40 mg/dl (2.22 mmol/l) or above 400 mg/dl (22.2 mmol/l) the screen will display "NO CAL." The value entered will be stored but not used for calibration.*

3. Press the ACT button to set the value, and the display will return to the HOME screen.

BG Due

One useful feature of the Guardian RT is the BG DUE screen. This screen lets you know when to enter the next needed blood glucose (BG) value into the Guardian RT to go on with calibration.

From the HOME screen:

1. Press the Up arrow button once. If an initial Sensor calibration has already been performed, the screen will display when the next BG entry is due. Pressing SEL or ACT once, or the Up arrow 2 times, will return you to the HOME screen. In the example below, the last calibration was done at 12:45 A.M. Therefore, the next BG value is due before 12:45 P.M. because the last BG entered was 12 hours before.

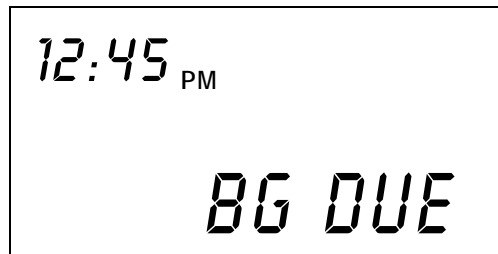

Depending on the condition and calibration status of the Sensor, there are four other screens that may be displayed, instead of BG DUE, by pressing the Up arrow once from the HOME screen. These screens are: ENTER BG, PENDING, NO SYNC, and REPLACE.

NOTE - *If calibration is pending, do not turn off the Monitor. Otherwise, you will have to enter a new Meter BG value.*

Enter BG

If no calibration has been done, and no calibration is pending, the screen below will be displayed if the Up arrow is pressed from the HOME screen.

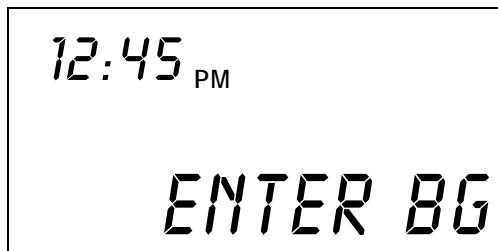

Calibration Pending

If a BG value has been recently entered, but the Up arrow is pressed within 15 minutes of the entry, not giving the Sensor enough time to calibrate, the screen below will be displayed. The example 90 mg/dl (5.0 mmol/l) is the recently entered Meter BG value.

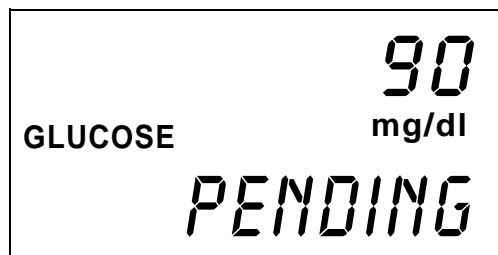

No Sync

If the Sensor is not in INIT (Initialize mode), and still working, and the Guardian RT is not synchronized, then the screen below will be displayed. This means that the Monitor is not getting Sensor data from the Transmitter at this point in time.

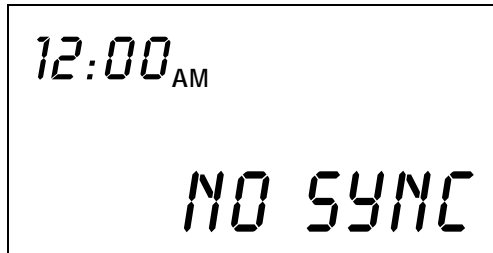

Replacing the Glucose Sensor

If the word REPLACE is displayed on the screen along with a time that is **not the current time** (i.e., the time displayed is a future time), the Sensor must be changed before the next calibration is due. The time displayed is the end of Sensor life. If REPLACE and the **current time** are displayed on the screen, then the Sensor is not working and the system is no longer sending Sensor glucose values. Change out the Sensor immediately to continue using the Guardian RT system.



Events

The EVENT screens are used to record information that might affect glucose values. Events are stored but they cannot be reviewed on the Monitor display (except previously entered values). Event markers and related values can be downloaded, along with the glucose Sensor history, to the Guardian Solutions Software using the Com-Station cradle. Event information is helpful in evaluating glucose trends and patterns displayed in the software reports. There are four types of events that can be recorded into the Monitor:

- ‡ Insulin
- ‡ Carb Amount
- ‡ Exercise
- ‡ Other

From the HOME screen:

1. Press the SEL button 3 times, and the EVENTS screen will appear.



2. From the EVENTS screen, press the ACT button. The screen will display INSULIN, and it will be blinking. Use the Up arrow to move between the following Event options:

- ‡ Insulin
- ‡ Carb Amount
- ‡ Exercise
- ‡ Other

Units of Insulin Taken

From the HOME screen:

1. Press the SEL button 3 times, and the EVENTS screen will appear.
2. Press the ACT button once, and the screen will display SET and INSULIN will be blinking. (Dashes will be displayed if no insulin amount was entered before.)

NOTE - If you are an insulin pump user, the dose refers to your bolus, not basal insulin. If your bolus amounts are in the hundredth of a unit (2 places after the decimal point), round to the nearest tenth of a unit (one place after the decimal point) or whole number of units.

3. Press the ACT button.
4. Press the Up or Down arrow button to enter units of insulin taken, from 0.1 to 99 units.

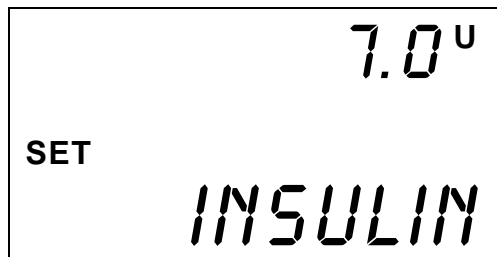

5. Press the ACT button to confirm, and a blinking CARB AMT screen will appear.

Carbohydrate Amount

After an Insulin dose has been entered and the **ACT** button pressed, the screen will display **SET**, and **CARB AMT** will be blinking. (Dashes will be displayed if no carb amount was entered before.) If you do not want to enter a carbohydrate amount, press **SEL** until the **HOME** screen appears. Otherwise, follow these steps.

1. Press the **ACT** button.
2. Press the Up or Down arrow button to enter the amount of carbohydrate eaten. (Example: One baked (6 ounce) potato is 30 grams of carbohydrate.) The unit range is from 1 to 300. Enter the Carb Amount in units, grams, or exchanges. If you do not know how to figure out amount of carbohydrate eaten, ask your doctor to learn how.



3. Press the **ACT** button again to save the carbohydrate amount in the Monitor memory. Return to the **HOME** screen.

Duration of Exercise

From the **HOME** screen:

1. Press the **SEL** button 3 times, and the **EVENTS** screen will appear.
2. Press the **ACT** button once. The screen will display **SET**, and **INSULIN** will be blinking.
3. Use the Up or Down arrow button to choose the exercise Event option. The screen will display **SET**, and **EXERCISE** will be blinking. (Dashes will be displayed if no exercise amount was entered before.)

4. Press the **ACT** button. Use the Up or Down arrow buttons to enter how long you have exercised. You can enter Exercise in 10-minute increments up to 4 hours.

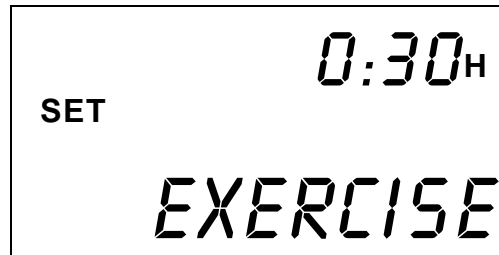

5. Press the **ACT** button to save the exercise length and go back to the HOME screen.

Other Events

Any other important events, such as illness, menstrual cycle, etc., can be entered using the OTHER screen.

From the HOME screen:

1. Press the **SEL** button 3 times, and the EVENTS screen will appear.
2. Press the **ACT** button once. The screen will display SET with "INSULIN" blinking.
3. Press the Down arrow, and the screen will display SET, and "OTHER" will be blinking.
4. Press the **ACT** button again to enter the OTHER event and go back to the HOME screen.

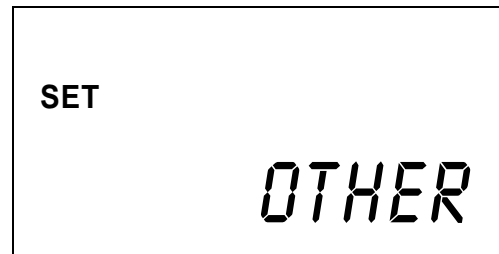

NOTE - No values are associated with OTHER events. Track the type of event manually in your logbook.

Glucose Alarm History

The glucose alarm history will display the last 20 high and low glucose alarms received.

From the HOME Screen:

1. Press the SEL button 4 times until the GLUCOSE ALARMS screen appears.

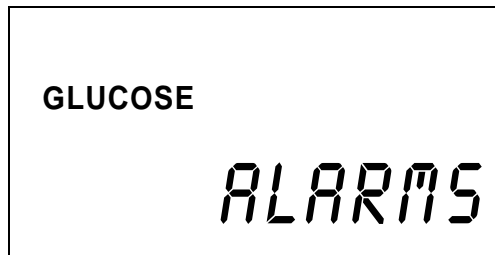

2. Press the ACT button to view the saved alarms.
3. If there are no alarms in the history, the following screen will appear:



4. If there are alarms in the history, the newest one will be displayed first. The alarm will be displayed with the time and date they were triggered and the corresponding value.
5. In the example below, an alarm was triggered at 13:04 (1:04 PM) on August 3, 2002 when the glucose value reached 140 mg/dl (7.77 mmol/l). This value is at or above the High glucose limit setting.

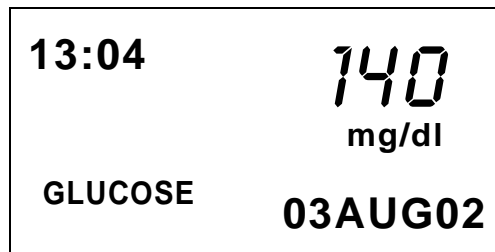

6. If the glucose value was outside the “operational range” of 40-400 mg/dl (2.2 -22.2 mmol/l), then the Guardian RT will display either of these two screens:

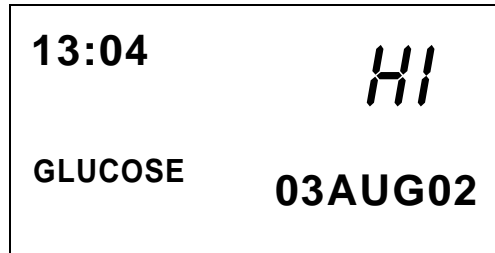
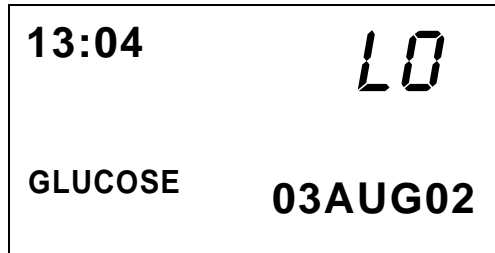

7. Use the Up or Down arrow button to go through the rest of the Glucose Alarm History. Pressing the DOWN arrow will display the previous (next-most recent) alarm. Pressing the UP arrow will display the oldest alarm. Press SEL to return to the HOME screen.

Search

The Search procedure start synchronized communication between the Monitor and the Transmitter. The Search procedure is explained in detail in *Chapter 2: Getting Started, Searching for the Transmitter*. Please refer to that section for more information.

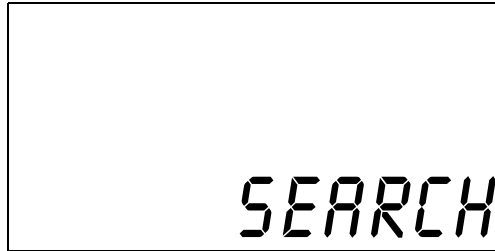

Signals

The SIGNALS screen is useful to make sure the ISIG (Input Signal, i.e., Sensor signal) readings are in the correct range. Reviewing the Signal readings is valuable for reporting Signals within an acceptable range and when doing the Test Plug Procedure (*See Chapter 4: Troubleshooting and Alarms*). This procedure lets you know if the Monitor, Transmitter or Sensor are working properly.



From the TIME AND ALARM Screen:

1. Press the **SEL** button 6 times until the SIGNALS screen appears. Press the **ACT** button to view the ISIG. Press the **ACT** button once more and the SETUP screen will be displayed.
2. If the Up or Down arrow button is pressed from the ISIG screen, the VCTR (Sensor voltage) screen is displayed. This screen is for diagnostic purposes only and not for everyday use.

NOTE - *When in the INIT (Initialization) mode, do not go to the signals screen until the Monitor has counted down to between 133 and 130.*

NOTE - *While unlikely, moisture may enter the Guardian RT Transmitter connector during normal use. This may lead to erratic ISIG values above 200 nA. Stop Sensor use if problems with moisture are suspected. Remove the Transmitter from the skin surface and allow to air dry for 3-4 hours. (More or less drying time may be needed, depending on the air temperature and humidity.) Once dry, perform the Test Plug Procedure. If the ISIG values are in the range of 24-29 nA, then the Transmitter is working correctly.*

The Snooze Option

The Guardian RT has a Snooze option that works with the HIGH alert feature. This option can be turned on during a specific period of time when you are expecting your glucose level to rise above the set HIGH limit (e.g., after eating a heavy meal). It can also be set if you do not want the HIGH alert to interrupt you during a given time interval (e.g., during a business meeting). The Snooze option will thus deactivate the HIGH alert for a specified period, from 1 to 12 hours.

In order to get to, and set, this feature, the Glucose HIGH limit setting must be ON. At the end of the set SNOOZE time period, the high glucose alarm feature will be turned on once more. You can view the SNOOZE screen to see how much of the set SNOOZE time is remaining. To turn the SNOOZE feature OFF at any time, access the SNOOZE screen, select --:-- and press the ACT button.

From the HOME screen:

1. Press the Up arrow 2 times to reach the SNOOZE screen.
2. Press the ACT button to display the time interval (blinking dashes).

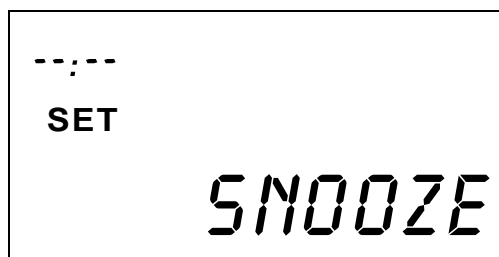

3. Use the Up or Down arrows to choose the desired interval. Press the ACT button to set and go back to the HOME screen.
4. The HOME screen will now display "S" in the upper right corner.

NOTE - *Ask your doctor if the Snooze option is right for you, and if so, what your personal Snooze setting should be.*

Chapter 4

Troubleshooting and Alarms

This chapter lists the Monitor alarms and how to troubleshoot and respond to them to keep the system working smoothly. If an alarm is triggered, the Monitor will beep, vibrate, or do both, depending on the Alert setting. All alarms are cleared by pressing the SEL button, followed by the ACT button. If an alarm is not cleared within 10 minutes, a continuous tone will sound.

Alarms with the letter "F" on the display are system errors. Before clearing these types of alarms, U.S. and Canadian customers, please contact the Product Help Line at 800-MINIMED (800-646-4633) or 818-576-5555. All other international customers please contact your local sales office.

If more than one alarm has been triggered, the alarms will be shown in order on the display, starting with the oldest. The alarm type and when it was triggered is stored in the Monitor memory for later download to the Guardian Solutions Software.

NOTE - Always take care of alarms right away. The first button press after an alarm is triggered turns on the display backlight. The backlight will stay on for about 10 to 20 seconds after the last button press.

NOTE - A calibration must be done after taking care of certain alarms by entering a new METER BG value. No Monitor glucose values will be reported after these alarms are triggered until a successful calibration is done.

CAUTION:	An audible alarm may not awaken you if you are a heavy sleeper, or if the sleeping environment has a significant amount of background noise. If there is a chance of not being awakened by the BEEP alert mode, then you should either use the VIBRATE or the BOTH mode. You should confirm that the alarm volume will be adequate to awaken you if an alarm is triggered during sleep.
-----------------	---

NOTE - If a key is pressed and held down at the same time that an alarm is triggered, the alarm will not be displayed until the key is released.

List of Alarms

No ID

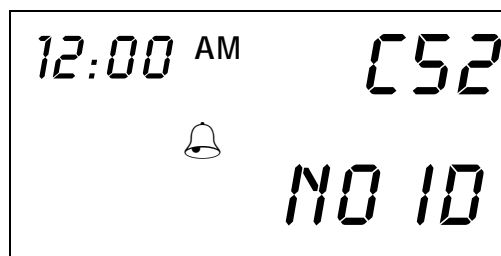

Error Message: C52/NO ID (Missing Transmitter ID)

Cause: A Transmitter ID has not been entered in the Monitor.

Action: Press the SEL button and then the ACT button to clear the alarm. Enter the Transmitter ID (serial number) into the Monitor's TRANS ID setup screen. See *Chapter 2: Getting Started*.

High

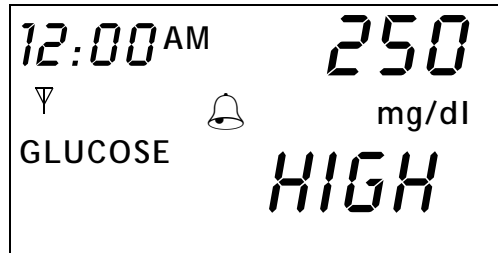

NOTE - If the alert pattern is set on beep, a series of ascending tones will be heard. This tone is unique to the HIGH alert. If the alert type is set on vibrate, vibrations do not vary for different alarms.

NOTE - In the screen above, 250 mg/dl is being used as an example.

Error Message: HIGH (High Glucose Alarm)

Cause: Glucose value is higher than or equal to the high glucose limit.

Action:

5. Press the **SEL** button and then the **ACT** button to clear the alarm. The alarm will turn off and the HOME screen will reappear. The alarm will repeat about every hour (or longer if the Repeat interval has been customized) until the condition has been corrected.
6. Take a blood glucose meter reading. If the value indicates a high blood glucose level, treat per your doctor's instructions and enter the value into the Monitor for calibration.
7. Even if the blood glucose value does not confirm the alarm, enter the value into the Monitor for calibration.

Low

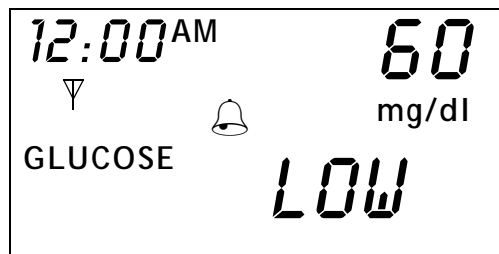

NOTE - If the alert pattern is set on beep, a series of descending tones will be heard. This tone is unique to the LOW alert. If the alert type is set on vibrate, there is no differentiation between the vibrations for the different alarms.

NOTE - In the screen above, 60 mg/dl is being used as an example.

Error Message: LOW (Low Glucose Alarm)

Cause: Glucose value is lower than or equal to the low glucose limit set.

Action:

1. Press the **SEL** button and then the **ACT** button to clear the alarm. The alarm will turn off and the HOME screen will reappear. The alarm will repeat about every 20 minutes (or longer if the Repeat interval has been customized) until the condition has been corrected.
2. Take a blood glucose meter reading. If the value indicates low blood glucose level, treat per your doctor's instructions and enter the value into the Monitor for calibration.
3. Even if the blood glucose reading does not confirm the alarm, enter the value into the Monitor for calibration.

Check Sensor

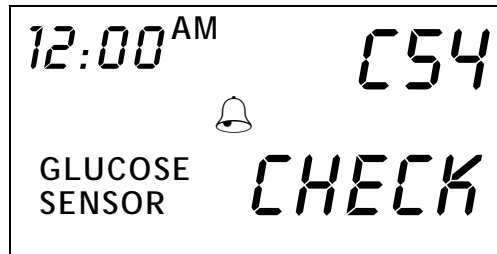

Error Message: C54/CHECK

Cause: The Monitor picked up a Sensor current that is outside the operating range or is unstable.

Action:

1. Press the **SEL** button and then the **ACT** button to clear the alarm. The alarm will turn off, and the HOME screen will reappear. The alarm will repeat periodically until the condition is corrected.
2. Make sure the insertion site appears normal and the Sensor is still connected. **DO NOT REMOVE CONNECTOR.**
3. If the alarm is triggered two or more times, take out the Sensor. Before putting in a new Sensor, do the Test Plug procedure at the end of this chapter to check system function.
4. If the Transmitter is not working correctly, a new Transmitter must be used. If it is working correctly, put in a new Sensor. Run initialization and calibration. See *Chapter 2: Getting Started*.

Low Batt

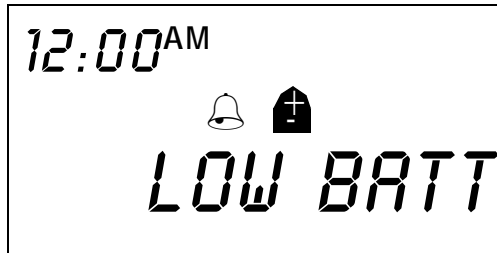

Error Message: LOW BATT (Low Batteries)

Cause: The voltage of the AAA batteries in the Monitor is low.

Action: Press the **SEL** button and then the **ACT** button to take care of the alarm. When this alarm is first triggered, the batteries have about eight hours of normal operating life left. The time of the first alarm is recorded into the Monitor memory. The Battery icon will be displayed on the HOME screen.

1. Turn Off the Monitor.
2. Change the batteries. See *Chapter 2: Getting Started*.

NOTE - *Make sure to put in new batteries within 10 minutes of taking out the old ones to avoid automatic resetting of date and time. This will also avoid the triggering of a Replace Sensor alarm.*

3. Do a manual Search procedure:
 - a. From the HOME Screen, press the **SEL** button 5 times until the SEARCH screen appears.
 - b. Press the **ACT** button and the Monitor will beep or vibrate. CONFIRM will be blinking on the screen.
 - c. Press the **ACT** button again to begin a SEARCH. The screen will display SEARCH and the number 8 (minutes). A countdown will begin. It may take up to 8 minutes to finish the SEARCH.

NOTE - *Frequent use of the backlight and having the alert type on "vibrate" will use up batteries quicker.*

Off/No Power

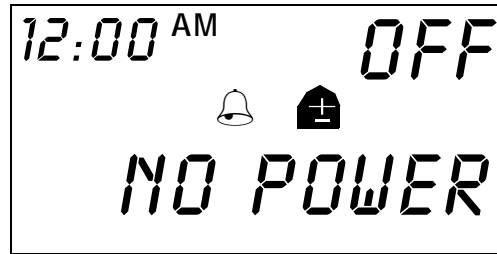

Error Message: OFF/NO POWER (Replace Batteries)

Cause: There is less than one (1) hour of battery life left. The Monitor will turn off.

Action:

1. Press the **SEL** button and then the **ACT** button to CLEAR the alarm.
2. **CHANGE THE BATTERIES RIGHT AWAY TO AVOID LOSS OF DATA STORED IN MEMORY!** Follow steps in *Chapter 2: Getting Started*.
3. Perform the manual Search procedure:
 - a. From the HOME Screen, press the **SEL** button 5 times until the SEARCH screen appears.
 - b. Press the **ACT** button and the Monitor will beep or vibrate. CONFIRM will be blinking on the screen.
 - c. Press the **ACT** button again to begin a SEARCH. The screen will display SEARCH and the number 8 (minutes). A countdown will begin. It may take up to 8 minutes to finish the SEARCH.

Service C60/61

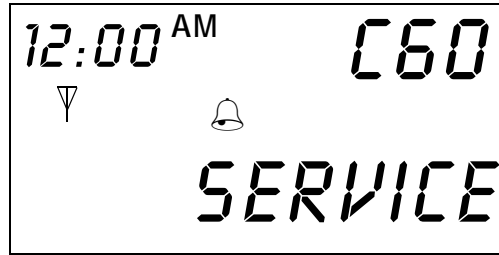

Error Message: C60/SERVICE (Transmitter Battery Low/End of Battery Life)

Cause: The Transmitter battery is low when C60 appears. The C60 service alarm will repeat each day around 12:00 noon. Service C61 means that the Transmitter battery is used up.

Action: Press the SEL button and then the ACT button to clear the alarm. The battery cannot be changed in the Transmitter. The battery life is about one year. Change out the Transmitter as soon as possible. Take off the Sensor, and insert a new Sensor to connect to the new Transmitter. After the Transmitter is changed, the Monitor must be reprogrammed with the new Transmitter ID number. See *Chapter 2: Getting Started*.

Re Init

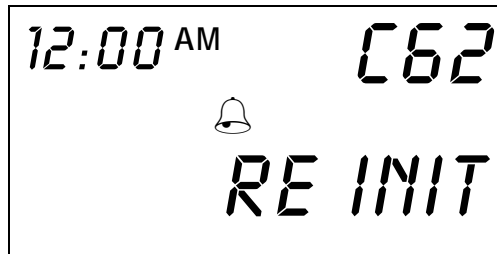

Error Message: C62/RE INIT (Re-Initialize Sensor)

Cause: The Monitor did not get the needed setup information from the Transmitter.

Action: Press the SEL button and then the ACT button to clear the alarm. Disconnect the Sensor from the Transmitter. Perform Search, reconnect Sensor, and following Initialization, enter blood glucose calibration. See *Chapter 2: Getting Started*.

NOTE - *If this alarm is triggered repeatedly, change out Sensor and do Initialization process once more.*

No Sync

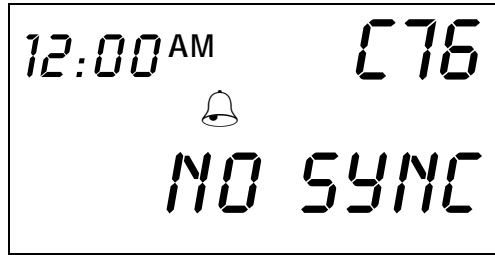

Error Message: C76/NO SYNC (Loss of Communication)

Cause: The Monitor and Transmitter are out of synchronization. As a result, the Monitor is unable to get data from Transmitter. The search for the Transmitter has failed, or communication has been lost.

Action:

1. Press the SEL button and then the ACT button to clear alarm. If Transmitter Search is not done, the alarm will repeat every 20 minutes.
2. Make sure that the Transmitter ID entered correctly (including leading zeros). If it is, do a manual SEARCH procedure:
 - a. From the HOME Screen, press the SEL button 5 times until the SEARCH screen appears.
 - b. Press the ACT button and the Monitor will beep or vibrate. CONFIRM will be blinking on the screen.
 - c. Press the ACT button again to start a SEARCH. The screen will display SEARCH and the number 8. A countdown will begin. It may take up to 8 minutes to finish the SEARCH.
3. If not correct, reenter the Transmitter ID number and do the Sensor Initialization procedure. See *Chapter 2: Getting Started*.
4. Reposition the Monitor and Transmitter within 5-10 inches (12.7-25.4 cm) of each other and retry the SEARCH procedure.
5. Is a cell phone or another RF transmitter working nearby? If so, move further away, and retry the manual SEARCH procedure.
6. Wireless transmission between the Monitor and the Transmitter within the six-foot operating range may be interrupted due to Transmitter Cable orientation. Move the Monitor closer to the Transmitter or to another position and retry the SEARCH procedure.

7. If alarm continues, U.S. and Canadian customers please contact the Product Help Line at 800-MINIMED (800-646-4633) or 818-576-5555. All other international customers please contact your local sales office.

Cal Err

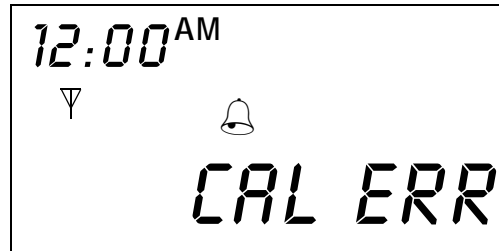

Error Message: CAL ERR (Calibration Error)

Cause: Calibration cannot be done successfully due to Monitor and Transmitter not communicating, Meter BG outside expected range from Sensor reading, or Monitor was turned off for more than 2 hours.

Action:

1. Press the **SEL** button and then the **ACT** button to clear the alarm. The alarm will turn off, and the HOME screen will appear. An alarm to recalibrate will repeat until a new calibration is done.
2. Check to make sure that the antenna icon is displayed. If it is not displayed, the communication link between the Transmitter and the Monitor has not been set. Restore communication between the Transmitter and the Monitor. Make sure the Monitor and Transmitter are within 6 feet (2 meters) of each other.
3. Take fingerstick reading and enter meter BG value, between 40-400 mg/dl (2.2-22.2 mmol/l), for calibration.

Key Held



Error Message: C77/KEY HELD

Cause: A Monitor key has been pressed and held for more than 3 minutes.

Action: Press the SEL button and then the ACT button to clear the alarm.

Enter BG



Error Message: C78/ENTER BG (Enter Calibration Value)

Cause: Calibration is needed. No new glucose values will be recorded until calibration is done. Calibration value must be between 40-400 mg/dl (2.22-22.2 mmol/l). This alarm is triggered if calibration has not been done in the last 12 hours or following a CAL ERR alarm, or if a calibration has not been done in the last 8 hours since the first calibration.

Action: Press the SEL button and then the ACT button to clear the alarm. Take a fingerstick reading using a meter. Press the SEL button until the METER BG screen appears. Press the ACT button, and the dashes "--" will blink. Press the Up or Down arrow button to scroll through the values until meter value is displayed. Press the ACT button to confirm. Until calibration is done, this alarm will repeat hourly.

Set Time

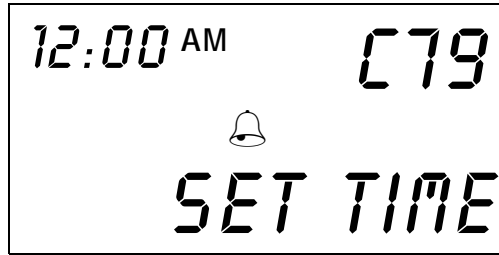

Error Message: C79/SET TIME (Reset Date and Time in Monitor)

Cause: The internal clock has cleared. Most likely the batteries were taken out and not placed back for more than 10 minutes, and the clock does not have the right time.

Action: Press the **SEL** button and then the **ACT** button to take care of the alarm. Reprogram your Monitor, and change Sensor, if prompted, following the instructions in *Chapter 2: Getting Started*.

Replace Sensor



Error Message: C80/REPLACE (Change Sensor/End of Sensor Life)

Cause: The maximum expected life of the Sensor has been reached. In other words, either the Monitor has seen a problem with the Sensor, triggering two calibration alarms, one after the other, or 72 hours have passed since the Sensor was first put in and initialized. This alarm will repeat every 20 minutes until the Sensor is changed and initialized.

Action:

1. Press the **SEL** and then the **ACT** button to turn off the alarm.
2. Turn the Monitor Off.
3. Turn the Monitor On.
4. Remove the Sensor, and insert a new Sensor. Follow the *Inserting the Sensor* section in *Chapter 2: Getting Started*. Initialize the Sensor by following the *Sensor Initialization* section also in *Chapter 2*.

NOTE - *If after changing the Sensor, but before doing the initialization, the alarm repeats, turn off the alarm and go on with initialization.*

System Alarms

These alarms are triggered when a diagnostic test finds an error in the Monitor. If an alarm code has an "F" followed by two numbers (example shown below), do the following procedure:

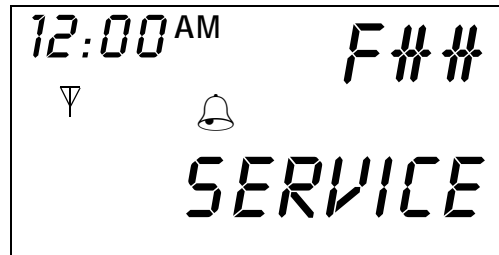

1. Write down the alarm code.
2. Download data into a personal computer right away (using the Com-Station and Guardian Solutions Software) to help with troubleshooting the device.
3. To report the alarm, U.S. and Canadian customers please contact the Product Help Line at 800-MINIMED (800-646-4633) or 818-576-5555. All other international customers please contact your local sales office.
4. Clear the alarm by pressing the SEL button and the ACT button. The Monitor programming will change to factory settings, except for glucose history data. All other information needs to be reprogrammed after speaking with the Product Help Line.

Test Plug Procedure

If you come across an operating problem, the Test Plug gives information that can let you know if a Sensor, Monitor or Transmitter is working correctly. The Test Plug sends a constant electronic signal to the Monitor. This data can be read on the Monitor Signals screen. The normal signal range is about 24-29 nA (nanoamperes).

1. Disconnect the Sensor from the Transmitter's Sensor connector.
2. Press the SEL button until the SEARCH screen appears, and start the search for the Transmitter. See *Chapter 2: Getting Started*.
3. Connect the Sensor Connector end of the Transmitter to the Transmitter Connector end of the Test plug (see Figure 4.1). Press the parts together until the snap arms on the Cable Connector come together with a click.

Figure 4.1

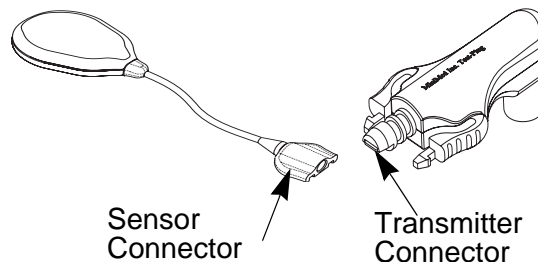

4. If the Monitor recognizes the Transmitter, the Monitor will enter the Initialization mode. The Monitor will display INIT and 2:20 h.
5. The Monitor will count the minutes down from 2:20 h. Data is first sent in the 2:13 to 2:10 h. To check the correct ISIG values (ISIG stands for Input Signal, which is the Sensor current) you must wait for data to be first sent. Let the Monitor reach this range in time; it will take between seven to ten minutes. This wait period ensures that the reading from the Transmitter is stable.

6. When the Monitor displays between 2:13 and 2:10 h, go to the SIGNALS screen (From the HOME screen, press SEL 6 times and then press ACT) to view the ISIG.

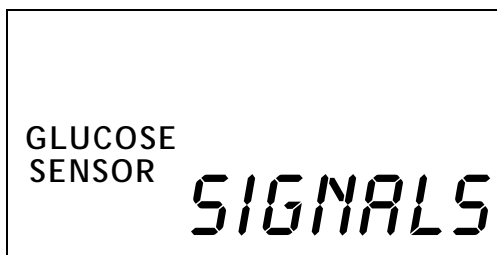

NOTE - *Do not go to the signals screen until the Monitor has counted down to between 2:13 and 2:10 h.*

7. If the ISIG value is between 24 and 29 nA, and the Initialization screen shows 2:00 h or less, the Transmitter and Monitor are working properly. Change the Sensor. Initialize and calibrate the new Sensor. Refer to *Chapter 2: Getting Started*.

NOTE - *If you miss the first transmission of data and the second transmission has been sent, the ISIG reading will typically be above 29 to 34 nA and can go very high. This value should be ignored. All following transmissions will return to the 24-to-29 nA range.*

8. If the ISIG value is outside the range of 24 to 29 nA, the Transmitter, Monitor, or both, may have a problem. U.S. and Canadian customers, please contact the Product Help Line at 800-MINIMED (800-646-4633) or 818-576-5555. All other international customers please contact your local sales office.

NOTE - *To extend the operational life of the Transmitter battery, do not leave the Test Plug connected to the Transmitter when not in use.*

Chapter 5

Performance Characteristics

NOTE - Users should have the information in this chapter reviewed by their healthcare provider.

The Medtronic MiniMed Guardian RT uses a glucose Sensor to continuously monitor your glucose levels. The Guardian RT Sensor is “calibrated” using your home blood glucose meter. Once calibrated, the Guardian RT reports glucose values every 5 minutes. These values were compared to reference laboratory blood glucose measurements to check the Guardian RT’s performance characteristics in a clinical study¹.

Although presentations to characterize performance of the Guardian RT are given below, there is no commonly accepted statistical approach for capturing the performance of continuous glucose monitors such as the Guardian RT. Performance may be best characterized by viewing graphs called time-elapsd plots. In these plots, the values from Guardian RT for one subject over time are overlaid with values at the same time from the glucose reference method. Three representative time-elapsd plots of Sensors that exhibited excellent performance, average performance and poor performance are shown on pp. 95-97 (Figures 5.3-5.5).

¹*Medtronic MiniMed, A Frequent Sample Accuracy Evaluation of the Medtronic MiniMed Telemetered Glucose Monitoring System II (TGMS II) in Subjects with Type 1 Diabetes Mellitus, August 2004.*

Performance Results

The performance of the Guardian RT was evaluated in a clinical study. Guardian RT results were compared to plasma glucose values from a reference method, the YSI 2300 STAT Plus™ glucose analyzer (referred to as YSI). Sixteen subjects with Type I diabetes participated in a single-site in-clinic study. Subjects ranged in age from 18 to 65 years old. Each subject wore 2 Guardian RT systems simultaneously. One Guardian system was calibrated an average of 3.5 times per day, and the other was calibrated approximately 5 times per day using the BD Logic™ meter. YSI measurements were taken every thirty minutes.

Users and their healthcare providers should consider that performance in this study may be idealized, and that performance may be worse when the Guardian RT is used in a less-controlled home setting. For example:

- ‡ The mean Hemoglobin A1c among the 16 participants was 8.2%. As hemoglobin A1c levels rise, conditions often occur which are most challenging to test systems measuring glucose in interstitial fluid, i.e., higher glucose levels, more rapid changes in glucose concentrations, and often more hypoglycemic episodes.
- ‡ Subjects saw, on average, between 4 and 5 fingerstick values per day. This enables subjects to better manage their diabetes when compared to those who perform less fingersticks per day. Agreement between Guardian RT and YSI values is shown to be closer at mid-range glucose levels, as compared to agreement at low or high glucose concentrations.
- ‡ Subjects were more limited in their activities than what may exist in home use, and they were provided with all their meals. Sensors were also inserted by clinic staff rather than the subjects themselves. Subjects who are more active, or with poor eating habits, may create more challenging conditions for the Guardian RT.
- ‡ Performance of the Guardian RT may vary depending on the glucose meter used and how well the meter is maintained. It is important to carry out quality-control checks on the meter and code the meter according to the manufacturer's instructions to optimize performance of the Guardian RT.

Accuracy of Guardian RT Readings

In this study, YSI measurements (taken every half hour) were paired with the corresponding Guardian RT reading (taken every 5 minutes). Pairing was done by selecting the Guardian RT value closest in time to the YSI test result. Agreement was analyzed by comparing paired glucose measurements.

Agreement between the matched pair was estimated by evaluating the difference between the Guardian RT reading and the YSI measurement. The difference between them was calculated as a percentage of the YSI (Mean Absolute Percent Difference). The bias was also calculated, and it is defined as the overall difference between the Guardian RT glucose values and the YSI values. The paired glucose measurements are summarized in Table 5.1.

Table 5.1

Number of Paired Glucose Measurements	3941
Mean Absolute Percent Difference (\pm SD)	19.7 \pm 18.4%
Bias	-15.0 mg/dl (-0.8 mmol/l)

The accuracy of the Guardian RT was also evaluated by calculating the percentage of Guardian RT readings within 20% and within 30% of the YSI reading (or within 20 mg/dl (1.1 mmol/l) in the low glucose range). Results are shown in Table 5.2

Table 5.2

Plasma Glucose Range (mg/dl)	Plasma Glucose Range (mmol/l)	Number of Paired Readings	Percent Within 20%	Percent Within 30%
Overall		3941	62%	79%
40-80*	2.2-4.4	356	68%	68%
>80-120	>4.4-6.7	769	60%	77%
>120-240	>6.7-13.3	2362	62%	81%
>240	>13.3	454	61%	82%

*For the Low glucose range, 40-80 mg/dl (2.2-4.4 mmol/l), the value shown is the percent within 20 mg/dl (1.1 mmol/l).

The Clarke Error Grid was used to assess the clinical relevance of the differences between the Guardian RT readings and the comparative YSI measurements. The Clarke Error Grid divides a correlation plot into 5 zones. See Table 5.3.

Results in zones A and B are considered clinically acceptable, while results in zones C, D, and E are potentially dangerous and, therefore, clinically significant errors. The Clarke Error Grid zones are labeled on the correlation plot.

Table 5.3

Zone	Description
A	Clinically accurate, would lead to correct treatment decisions
B	Would lead to benign decisions or no treatment
C	Would lead to overcorrection of normal glucose levels
D	Would lead to failure to detect and treat high or low glucose levels
E	Would lead to erroneous treatment decisions

Figure 5.1 is a correlation plot of Guardian RT readings versus readings from the reference method, the YSI 2300 Glucose Analyzer. It is overlaid with the Clarke Error Grid. The total number of paired data points is 3941.

Figure 5.1

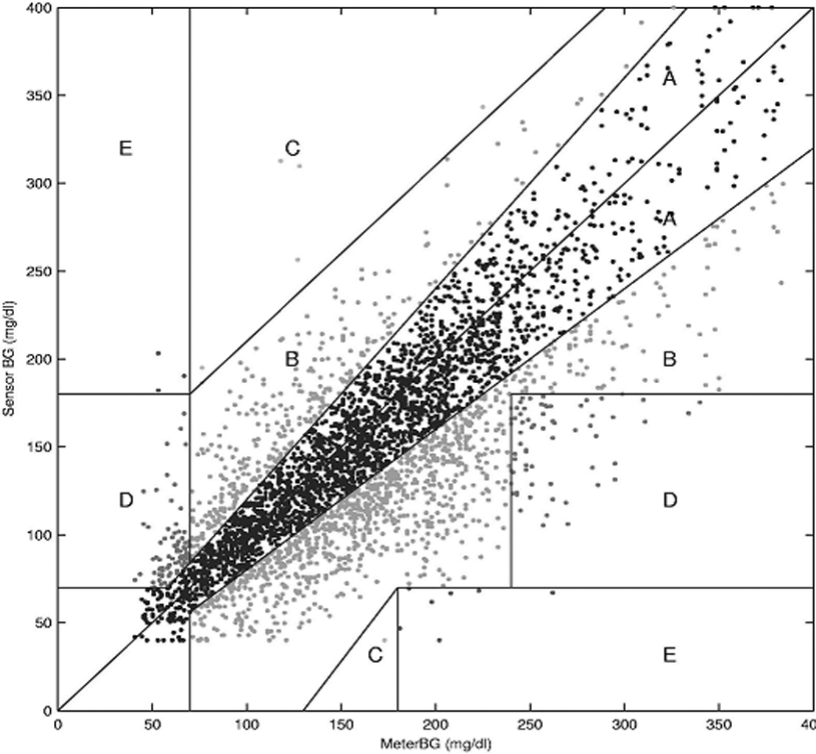

The percent of Guardian RT readings in the above graph are presented in Table 5.4 below according to the percentage of points falling within each zone (A-E). Results are further broken down (stratified) according to the range of glucose concentrations.

Table 5.4: Stratified Clarke Error Grid Analysis

Glucose Range (mg/dl)	Number and (%) of Data Points Evaluated	A+B	A	B	C	D	E
40-80	356 (9)	271 (76.1)	214 (60.1)	57 (16.0)	2 (0.6)	80 (22.5)	3 (0.8)
81-120	769 (20)	768 (99.9)	463 (60.2)	305 (39.7)	1 (0.1)	N/A*	N/A
121-240	2362 (60)	2352 (99.6)	1476 (62.5)	876 (37.1)	4 (0.2)	N/A	6 (0.2)
>240	454 (11)	394 (86.8)	277 (61.0)	117 (25.8)	N/A	59 (13.0)	1 (0.2)
Overall	3941 (100)	3785 (96.0)	2430 (61.7)	1355 (34.4)	7 (0.2)	139 (3.5)	10 (0.2)

*N/A means that the Clarke Error Grid does not consider the possibility of these zones in that concentration range.

Precision of Guardian RT Readings

This study was also designed to look at the reproducibility of two Sensors worn simultaneously at different locations on the body. Precision was estimated by comparing the glucose readings from the two Guardian RT systems. In this study 11,475 paired Sensor Guardian RT values were obtained. On average, they were different by 17.2%. Figure 5.2 is an example of how data was paired in this study. In the graph there are two tracings of Guardian RT values. Each tracing comes from a different Guardian RT unit worn by one subject during a one-day period.

Figure 5.2

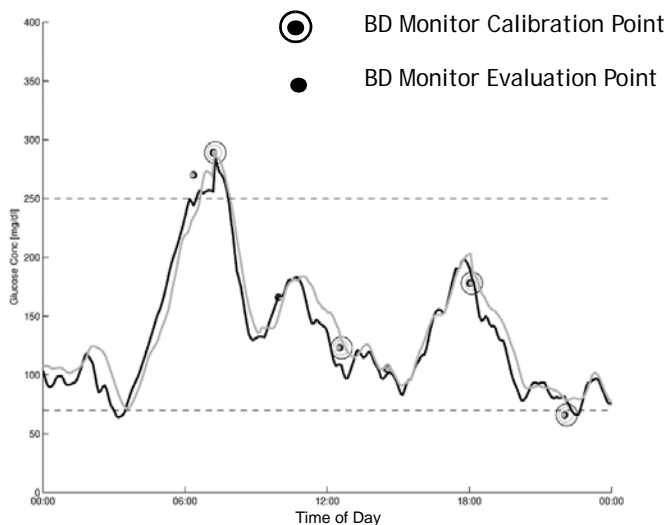

In Figure 5.2, Guardian RT device #1 is represented by a solid line, and the Guardian RT device #2 by a light-gray line.

Low and High Alerts

The ability of the Guardian RT to detect high and low glucose levels was measured in the same clinical study. Since it is important to set the alert levels in a conservative fashion, the Low Glucose Alert should be set at a value slightly higher than the value of blood glucose you want to detect, and the High Glucose Alert should be set at a value slightly lower than the value of blood glucose you want to detect.

NOTE - Please ask your doctor which low and high alert setting is best for you.

The Low Glucose Alert

The Low Glucose Alert was evaluated for its ability to detect glucose levels at 70 mg/dl (3.9 mmol/l), or below, using the YSI 2300 STAT Plus glucose analyzer. As a reference, with the Low Glucose Alert set at 70 mg/dl (3.8 mmol/l), 49% (100/205) of low glucose events were detected by the Guardian RT. Better detection of low blood glucose can be obtained by setting the Low Glucose Alert level higher. For example, setting the Low Glucose Alert at 90 mg/dl (5.0 mmol/l), instead of 70 mg/dl (3.9 mmol/l), increases the ability to detect low blood glucose levels from 49% to 82% (Table 5.5).

Sometimes the Guardian RT will alert when the blood glucose levels are not low. When the Guardian RT Low Alert was set at 70 mg/dl (3.9 mmol/l) in this study, 43% of the results were considered false alerts (actual blood glucose values are greater than 85 mg/dl (4.7 mmol/l)). This percentage may be exaggerated because blood glucose may be dropping when the Guardian RT alerts. Table 5.5 shows the percent of Low Glucose readings correctly identified by the Guardian RT for specific settings.

Table 5.5

Guardian RT Low Alert Setting (mg/dl)	Guardian RT Low Alert Setting (mmol/l)	True Alert Rate*	False Alert Rate**
70	3.9	49%	60%
80	4.4	68%	64%
90	5.0	82%	75%
100	5.6	90%	79%

* True Alert Rates are the % of times when the glucose level was at or below the alert setting and the alert sounded.

** False Alerts Rates are the % of times when the Guardian RT Sensor alarmed but the blood glucose level was greater than the alert setting.

Increasing the Low Alert settings will improve the ability to detect low blood glucose events, but it will also increase the frequency of Guardian RT false alerts for blood glucose levels not below the target value. You should consider this trade-off between the improved ability to detect true low blood glucose versus the increased number of false alerts when setting the low alert threshold.

The High Glucose Alert

The High Glucose Alert was evaluated for its ability to detect glucose levels at 250 mg/dl (13.8 mmol/l), or above, using the YSI analyzer. As a reference, with the High Glucose Alert set at 250 mg/dl 13.8 mmol/l), 53% (195/365) of high glucose events were detected by the Guardian RT. Better detection of high blood glucose can be obtained by setting the High Glucose Alert level lower. For example, setting the High Glucose Alert at 190 mg/dl (10.6 mmol/l), instead of 250 mg/dl (13.8 mmol/l), increases the ability to detect high blood glucose levels from 53% to 85% (see Table 5.6).

Sometimes the Guardian RT will alert when the blood glucose levels are not high. When the Guardian RT High Alert was set at 250 mg/dl (13.8 mmol/l) in this study, 7.2% of the results were considered false alerts (actual blood glucose values are less than 225 mg/dl (12.5 mmol/l)). This percentage may be exaggerated because blood glucose may be rising when the Guardian RT alerts. Table 5.6 shows the percent of High Glucose readings correctly identified by the Guardian RT for specific settings.

Table 5.6

Guardian RT High Alert Setting (mg/dl)	Guardian RT High Alert Setting (mmol/l)	True Alert Rate*	False Alert Rate**
190	10.6	85%	64%
200	11.1	81%	58%
225	12.5	67%	40%
250	13.8	53%	25%

* True Alert Rates are the % of times when the glucose level was at or above the alert setting and the alert sounded.

** False Alerts Rates are the % of times when the Guardian RT Sensor alarmed but the blood glucose level was lower than the alert setting.

Decreasing the High Alert settings will improve the ability to detect high blood glucose events, but it will also increase the frequency of Guardian RT false alerts for blood glucose levels not above the target value. You should consider this trade-off between the improved ability to detect true high blood glucose versus the increased number of false alerts when setting the high alert threshold.

Guardian RT Sensor Performance and Calibration Stability As a Function of Time

The Guardian RT Sensor may be worn for up to 3 days (72 hours) and must be calibrated at least twice a day. Two sets of data, approximately equal in number, were collected during the clinical trial. One data set was generated when the frequency of calibrations averaged 3.5 per day (Data Set A), and the other averaged 5 times a day (Data Set B). During the study, a total of 38 Sensors were evaluated in 16 individuals.

As per the stratified Clarke Error Grid analysis above (Table 5.4), agreement between Guardian RT values and YSI values tends to be poorer at low and high glucose concentrations when compared to other concentration ranges.

Guardian RT performance in the hypoglycemic range, as a function of Sensor insertion time, is characterized below. Results from the two different data sets are presented. The two populations were separated according to the number of calibrations per day. Table 5.7 represents the percentage of Data Points in the 40-80 mg/dl range that fell within 20 mg/dl. Data is presented in 12-hour increments.

Table 5.7

Data Set	0-12 hrs	12-24 hrs	24-36 hrs	36-48 hrs	48-60 hrs	60-72 hrs
A	78%	81%	73%	65%	56%	41%
B	67%	70%	93%	60%	75%	38%

An analysis of the mean percentage of Absolute Relative Error (ARE %) and standard deviations, across 12-hour increments of wear periods, appears in Table 5.8 below. Both data sets are pooled together in this data.

Table 5.8: Performance As a Function of Sensor-Insertion Time

Hours From Insertion	Mean ARE (%)	Std. Dev.
0-12 hrs	24.84	20.04
12-24 hrs	19.66	16.17
24-36 hrs	16.43	15.62
36-48 hrs	18.23	19.27
48-60 hrs	16.59	14.25
>60 hrs	22.95	23.51

The median Sensor life from Data Sets A and B were 57.5 hours and 72.9 hours, respectively. Twenty-one of the Sensors operated for 72 hours, while the others were removed for a variety of reasons, most often because of calibration errors.

The percentage of Guardian RT readings within 20 mg/dl and 30 mg/dl of YSI readings from 40-80 mg/dl (Table 5.9), and the percentage of readings within 20% and 30% of YSI readings from 81-120 mg/dl (Table 5.10), was analyzed according to time after Sensor insertion and according to the glucose-concentration range (as determined by the YSI analyzer).

Table 5.9

Glucose Range (mg/dl)	Percentage of Guardian RT values within 20 mg/dl of YSI laboratory readings		Percentage of Guardian RT values within 30 mg/dl of YSI laboratory readings	
	During first 60 hours of Sensor wear	After 60 hours of Sensor wear	During first 60 hours of Sensor wear	After 60 hours of Sensor wear
40-80	62-82%	39%	78-91%	67%

Table 5.10

Glucose Range (mg/dl)	Percentage of Guardian RT values within 20% of YSI laboratory readings		Percentage of Guardian RT values within 30% of YSI laboratory readings	
	During first 60 hours of Sensor wear	After 60 hours of Sensor wear	During first 60 hours of Sensor wear	After 60 hours of Sensor wear
81-120	57-66%	48%	72-84%	66%

Performance of the Guardian RT was evaluated according to the length of time since calibration. This data is not conclusive because of the limited number of data points during the final 3 hours of the 12-hour calibration cycle, i.e., 10. In contrast, 3-hour time bins, earlier in the 12-hour cycle, contained hundreds of data points. This may suggest that calibrations are often required prior to the 12-hour calibration cycle.

Affects of Calibration Frequency

The average bias when Guardian RT was calibrated ~ 3.5 times a day was -20.5 ± 41 mg/dl (LL: -22.40 mg/dl and UL: -18.63 mg/dl). In those calibrated ~ 5 times a day, the bias was -10.2 mg/dl ± 36 mg/dl (LL: -11.74 mg/dl and UL: -8.66 mg/dl).

When comparing Guardian RT units that were calibrated less often to those calibrated more often, the following alarm performance was observed:

- ‡ Specificity increased 2-4% in the hypoglycemic range and decreased 0-2% in the hyperglycemic range
- ‡ Sensitivity increased between 5-9% across the hyperglycemic range, and decreased 7-16% when the alarm was set to 80 mg/dl or below, and decreased 3-7% when set between 85 and 100 mg/dl

Stratified error grid analysis also shows better performance in the hypoglycemic range when fewer calibrations are performed, i.e., 62% of data points are in Zone A when fewer calibrations were performed, whereas 58% were in Zone A when more calibrations were performed.

Time-Elapsed Plots

Figure 5.3 is a representative example of continuous Sensor tracing vs. reference blood glucose reading, where Sensor showed excellent performance. The open circles (o) on the graph represent the meter calibration readings. The closed circles (•) represent the reference blood glucose readings, and the solid line (—) represents the Sensor glucose value.

Figure 5.3

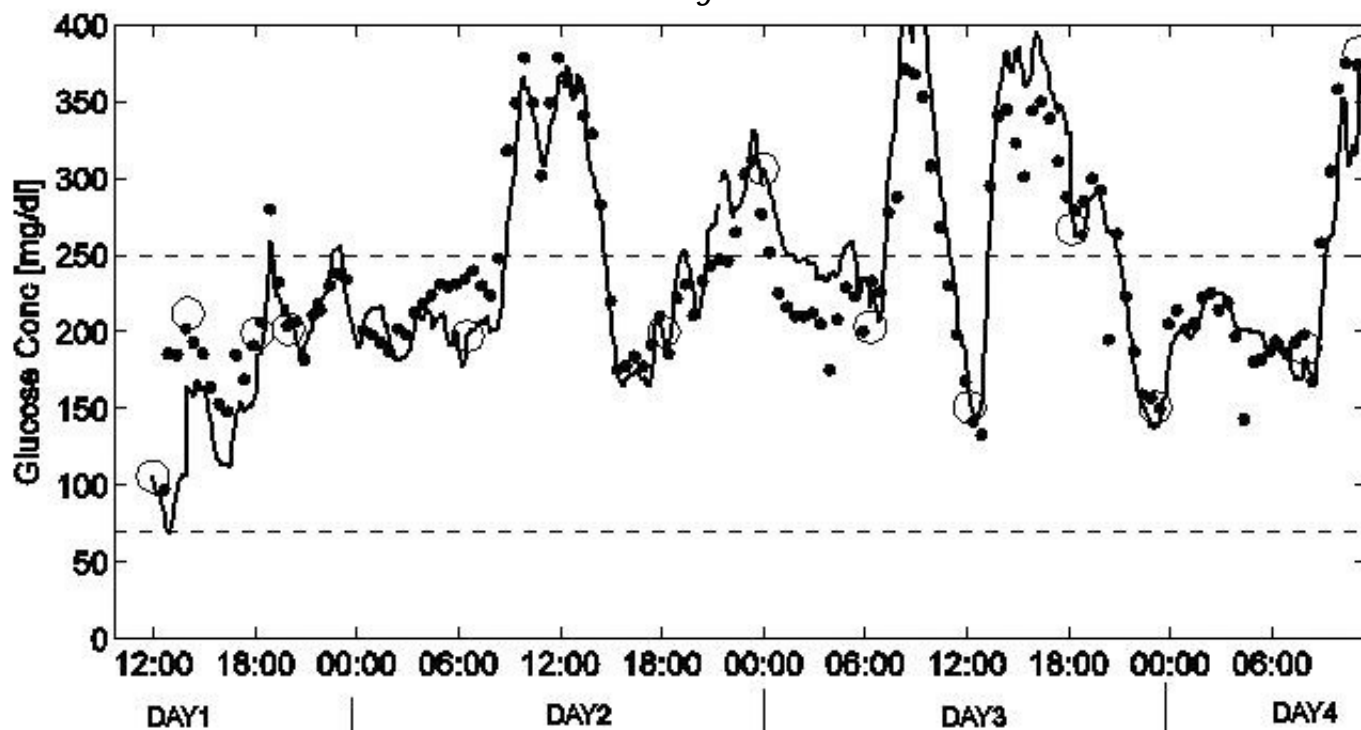

Figure 5.4 is a representative example of continuous Sensor tracing vs. reference blood glucose reading, where Sensor showed average (typical) performance. The open circles (o) on the graph represent the meter calibration readings. The closed circles (•) represent the reference blood glucose readings, and the solid line (—) represents the Sensor glucose value.

Figure 5.4

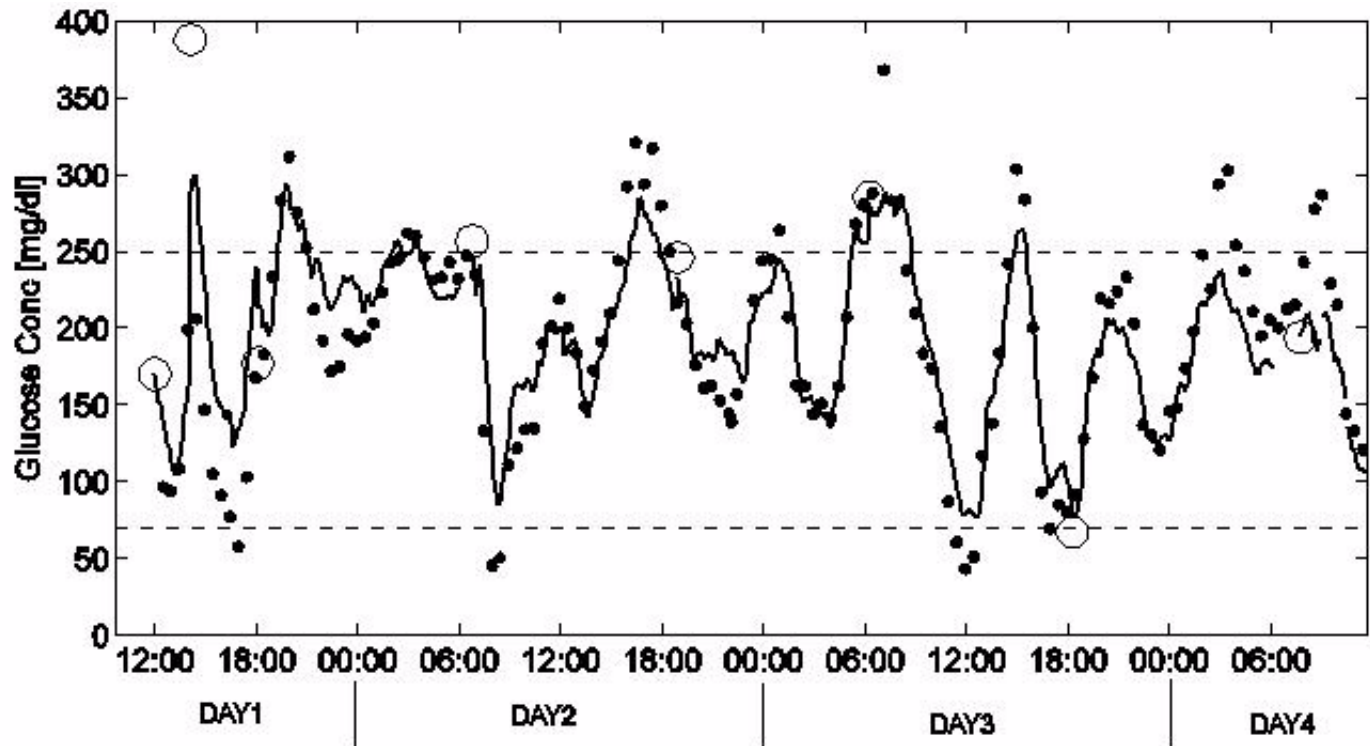
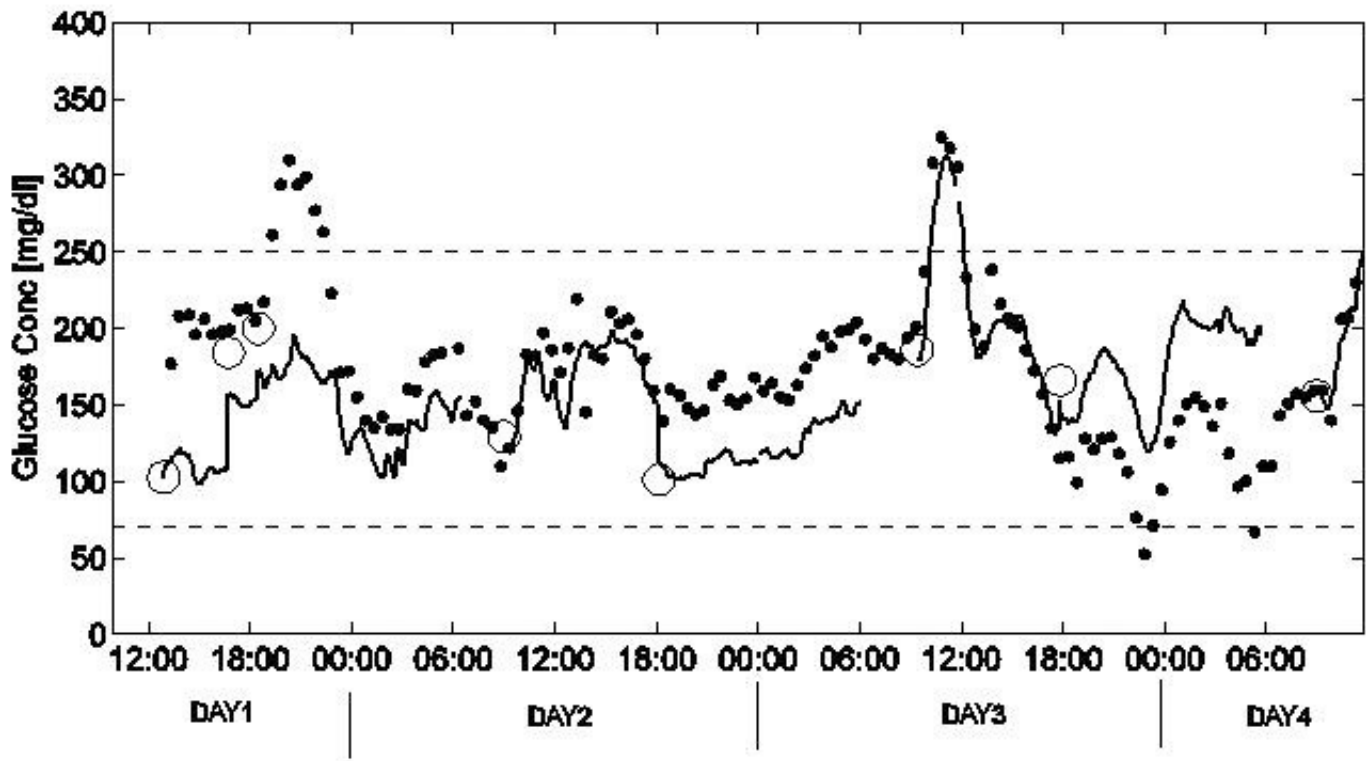

Figure 5.5 is a representative example of continuous Sensor tracing vs. reference blood glucose reading, where Sensor showed poor performance. The open circles (o) on the graph represent the meter calibration readings. The closed circles (•) represent the reference blood glucose readings, and the solid line (—) represents the Sensor glucose value.

Figure 5.5



Belt Clip

The Belt Clip is used to attach the Monitor to a belt or to clothing.

Installation

The Belt Clip is attached to the back of the Monitor by sliding the triangular-shaped ridge on the back of the clip into a groove on the back of the Monitor. Push the clip until it stops and clicks into place. (See Figure 6.1.)

Figure 6.1

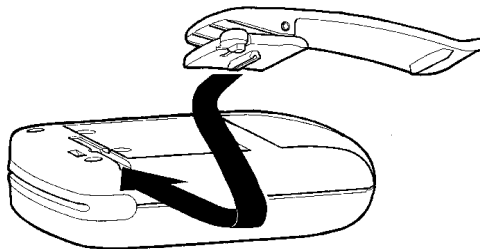

Removal

Using your finger, lift up on the oval shaped end of the Belt Clip. Gently slide the clip out of its groove. (See Figure 6.2.)

Figure 6.2

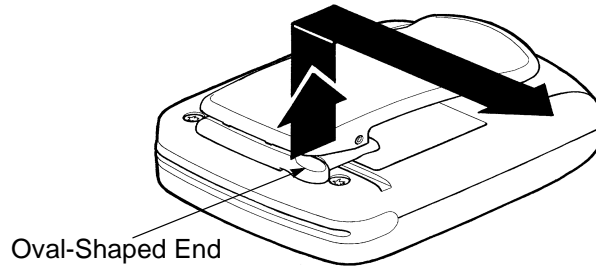

Leather Case

The Leather Case helps protect the Monitor against moisture, dirt, debris and electrostatic discharge.

Protection from Water

Although the Transmitter and Sensor are water resistant, repeated direct contact with water or other liquids should be avoided.

- The Monitor should never be placed under water.
- The Monitor should always be set in a dry place before showering, bathing or swimming.
- Any moisture that comes in contact with the Monitor should be dried with a soft towel.
- It is possible to shower, bathe and swim with the Sensor and Transmitter. However, please ensure that:
 - The occlusive dressing covering the Sensor and Transmitter connector is tightly attached to the skin.
 - You avoid submerging the Sensor in hot water, as this might significantly reduce its life.

Protection from Impact

The Monitor has been designed to be rugged and resistant to wear during everyday use. However, users should avoid rough sports or other activities that could damage the Monitor, the Transmitter, or the Sensor.

- ➡ The Monitor should be protected from mechanical damage, such as a fall or impact. If the Monitor is dropped, check for damage before using.
- ➡ The Monitor should be placed inside the leather case when it is worn. The case will absorb many of the bumps and scratches from sharp objects during everyday use.
- ➡ During exercise, if an alarm is triggered, you should stop exercising. Follow the directions in *Chapter 4: Troubleshooting and Alarms*.

Protection from High and Low Temperatures

The Monitor was designed to operate in a temperature range of 0 to +50 degrees Celsius (+32 to +122 degrees Fahrenheit).

- ➡ If outside during freezing weather, the Monitor should be kept underneath clothing to keep it warm.
- ➡ Avoid using or storing the Monitor in any environment where temperatures would be expected to rise above +50 degrees Celsius (+122 degrees Fahrenheit). This may include in a car on a hot summer day, or near a fire or other radiant heat source.
- ➡ Do not steam sterilize or autoclave the Monitor.

Cleaning the Monitor

1. Use only a damp cloth and mild detergent mixed with water to clean the outside of your Monitor.
2. Wipe excess soap from the Monitor with a clean, damp cloth.
3. Dry with a separate clean cloth.
4. Never use organic solvents, such as lighter fluid, nail polish remover, or paint thinner to clean your Monitor.
5. Keep the reservoir and battery compartments dry and away from moisture.
6. Do not use any lubricants with your Monitor.
7. Disinfect the Monitor by wiping the outside with an isopropyl alcohol wipe.

Cleaning the Transmitter

For single-patient use

1. Wash your hands thoroughly.
2. Dampen a clean cloth with mild liquid soap and warm water, and wipe the outside of the Transmitter, cable and connector. Do not wet the inside of the connector.

CAUTION: Do not place the Transmitter into the liquid soap solution.

3. Hold by the Transmitter end and rinse the Transmitter under warm tap water. Be careful not to get the inside of the connector wet.
4. Using an antibacterial hand sanitizer (readily available at your local drugstore) on a clean, dry cloth, wipe down the Transmitter, cable and connector. Make sure the inside of the connector does not get wet.
5. Place the Transmitter on a clean dry cloth and allow to air dry for 2-3 minutes.

For multiple-patient use

1. Wash your hands thoroughly.
2. Dampen a clean cloth with a mild liquid soap solution.

CAUTION: Do not place the Transmitter into the liquid soap solution.

3. Wipe the outside of the Transmitter, cable, and connector. Make sure the inside of the connector does not get wet.
4. Hold by the Transmitter end and rinse the Transmitter under warm tap water. Be careful not to get the inside of the connector wet.
5. Apply 3-4 drops of a quaternary ammonium compound disinfectant (e.g., CaviCide®) on a clean dry cloth. Wipe the Transmitter, cable, and connector, making sure the inside of the connector does not get wet.
6. Holding it by the Transmitter end, rinse the transmitter with 70% Isopropyl alcohol, being careful not to get the inside of the connector wet.
7. Place the Transmitter on a clean, dry, non-shedding cloth and allow to air dry.
8. Once the Transmitter is dry, place it in a sealed bag, labeled with the cleaning date. (See the example below.)
9. If there is any blood inside the connector, the Transmitter must be disposed of. Cut off the connector portion and discard in a Sharps or other medical waste container. Discard the Transmitter portion according to the local regulations for battery disposal (non-incineration).

CAUTION: It is important to NOT discard the Transmitter portion in a medical waste container or otherwise subject it to incineration. The Transmitter contains batteries which may explode upon incineration.

Example: Multiple-use cleaning label

Device
Date
Method of Decontamination
Wash
Disinfectant

Cleaning the Sen-serter

For single-patient use

1. Dampen a clean cloth with mild liquid soap and warm water and wipe the sen-serter.
2. Rinse with warm tap water.
3. Using an antibacterial hand-sanitizer (readily available at your local drugstore), wipe down the sen-serter.
4. Place the sen-serter on a clean dry cloth and allow to air dry.
5. Store sen-serter in the released position to maintain optimum product performance and life.

For multiple-patient use

1. Dampen a clean cloth with mild liquid soap and warm water, and wipe the Sen-serter.
2. Rinse with warm tap water.
3. Apply 3-4 drops of quaternary ammonium compound disinfectant (e.g., CaviCide®) on a clean, dry cloth. Wipe down the sen-serter.
4. Using 70 percent isopropyl alcohol, or isopropyl alcohol wipes, wipe down the sen-serter.
5. Place the sen-serter on a clean dry cloth and allow to air dry.
6. Once the sen-serter is dry, place it in a sealed bag, labeled with the cleaning date. (See example below.)

Example: Multiple-use cleaning label



Interference from Electrical Equipment

The Monitor is designed to meet all IEC standards for electromagnetic interference. The Monitor should withstand common electrostatic and electromagnetic interference. However, using the Monitor in close distance to strong electromagnetic sources, such as MRIs, X-rays, CT scans, television sets, cell phones, cordless phones, hand-held and mobile two-way radios, radio transmitters, high-voltage power lines, and store anti-theft security devices, is not recommended.

- ➡ Keep the Monitor in its leather case to protect against electrostatic discharges that are common in cold and dry climates.
- ➡ Do not place the Monitor in direct contact with X-rays or other medical or industrial imaging equipment. If a user is scheduled to have an X-ray, CT or MRI scan, take off Sensor, Transmitter and Monitor. Put in new Sensor after procedure.
- ➡ The Monitor is designed to withstand interference from airport X-rays or metal detectors and store anti-theft security devices. Nevertheless, always check the Monitor after it has passed through these devices to make sure the system is still synchronized and working properly.
- ➡ The Monitor listens for radio signals from the Transmitter via a 418 MHz (U.S. and Canada) or 433.92 MHz (International) radio receiver with a 400 KHz bandwidth. This receiver can be interfered with by other electrical/electronic equipment, even if that equipment complies with IEC or FCC standards. This interference may result in a C76/No Sync alarm.

Ordering Supplies

Medtronic MiniMed stocks a wide range of Guardian RT supplies, including Glucose Sensors, Transmitters, leather cases, belt clips, dressings, and other accessories. (See Tables 6.1 and 6.2.) U.S. and Canadian customers, place orders by calling 800-MINIMED (800-646-4633) or 818-576-5555. All other international customers please contact your local sales office. Orders can be placed online at www.minimed.com.

Table 6.1: Products

Product	Model Number
Glucose Sensor	MMT-7002
Monitor	MMT-7901
Transmitter	MMT-7700
Guardian Solutions Software	MMT-7315

Table 6.2: Accessories

Accessory	Model Number
Com-Station	MMT-7301
Sen-serter®	MMT-7500
Belt Clip	MMT-7402
Test Plug	MMT-7400
Leather Case	MMT-7401
I.V. Prep	MMT-173
IV3000®	MMT-174
Polyskin®	MMT-134
Detachol®	HMS-051304
Screwdriver	ACC-129
Transmitter Adhesive Pads	MMT-7006
Shower-Pak	MMT-117

Product Specifications

The following tables list Monitor, Test Plug and Transmitter performance specifications. (See Tables 6.3, 6.4 and 6.5.)

Table 6.3: Monitor

Component	Performance Specification
Glucose Measurement Range	40-400 mg/dl (2.2-22.2 mmol/l)
Typical Operating Range	6 feet (2 meters)
Display	Liquid crystal display (LCD)
Display Window	Length: 1.40 inches (3.56 centimeters) Height: 0.70 inches (1.78 centimeters)
Dimensions	Length: 3.56 inches (9.04 centimeters) Height: 2.77 inches (7.04 centimeters) Width: 0.86 inches (2.18 centimeters)
Weight	4 ounces (114 grams)
Limited Warranty	1 year
System Memory	Stores up to 21 days of data
Alarms	Audible (50 decibels @ 1 meter) Vibrate (similar to the vibrational power of a personal pager)
Backlight	Electroluminescent (EL) Panel
Power Supply	2 AAA alkaline batteries

Table 6.3: Monitor

Component	Performance Specification
Battery Life	Exceeds one month under anticipated normal use
Case Material	High impact ABS/polycarbonate composite
Safety Checks	Diagnostic signals verify proper Sensor and measurement system operation
Operating Conditions	Temperature: 0 to +50 degrees Celsius (+32 to +122 degrees Fahrenheit). Relative Humidity: 10% to 95% with no condensation
Storage Conditions	Temperature: -20 to +55 degrees Celsius (-4 to +131 degrees Fahrenheit) Relative Humidity: 10% to 100% with condensation
Approved Cleaners	A mild household liquid detergent diluted with water, a quaternary ammonia solution, or isopropyl alcohol on a wipe.
Approved Disinfectants	10% bleach solution, 3% hydrogen peroxide solution, or 70% isopropyl alcohol.

Table 6.4: Test Plug

Component	Performance Specifications
Operating Conditions	Temperature: 0 to +50 degrees Celsius (+32 to +122 degrees Fahrenheit) Relative Humidity: 15% to 95% with no condensation
Storage Conditions	Temperature: -20 to +55 degrees Celsius (-4 to +131 degrees Fahrenheit) Relative Humidity: 10% to 100% with condensation
Approved Cleaners	A mild household liquid detergent diluted with water, a quaternary ammonia solution, or isopropyl alcohol on a wipe. (DO NOT place liquids into either connector.)
Approved Disinfectants	Tap water, 10% bleach solution, 3% hydrogen peroxide solution, 70% isopropyl alcohol.

Table 6.5: Transmitter

Component	Performance Specifications
Biocompatibility	Complies with ISO 10993-1 for long-term body contact
Operating Conditions	Temperature: 0 to +50 degrees Celsius (+32 to +122 degrees Fahrenheit) Relative Humidity: 10% to 95% with no condensation
Transmitter Life	1 year under anticipated normal use conditions
Transmitter Frequency	418 MHz (U.S. and Canada) or 433.92 MHz (International), 1mWerp, 20k5A1D Modulation

Table 6.5: Transmitter

Storage Conditions	Temperature: -20 to +55 degrees Celsius (-4 to +131 degrees Fahrenheit) Relative Humidity: 10% to 100% with condensation
Approved Cleaners	A mild household liquid detergent diluted with water, a quaternary ammonia solution, or isopropyl alcohol on a wipe. (DO NOT place liquids into either connector.)
Approved Disinfectants	Tap water, 10% bleach solution, 3% hydrogen peroxide solution, 70% isopropyl alcohol.

FCC Notice for the Monitor

This device has been tested and found to comply with the limits for a Class B digital device, as outlined in Part 15 of the FCC Rules. These limits are designed to provide reasonable protection against harmful interference in a residential installation. This device generates, uses, and can radiate radio-frequency energy, and if not installed and used in accordance with the instructions, may cause harmful interference to radio communications. However, there is no guarantee that interference will not occur. If this device does cause harmful interference to radio or television reception, the user is encouraged to try one of the following measures:

- Reposition the Monitor and/or Transmitter.
- Increase the distance between the Transmitter and Monitor from the device that is receiving/sending interference.
- U.S. and Canadian customers, please contact the Product Help Line at 800-MINIMED (800-646-4633) or 818-576-5555. All other international customers please contact your local sales office.

Caution: Changes or modifications not expressly approved by the party responsible for compliance could void the user's authority to operate the equipment.

FCC Notice for the Transmitter

This device complies with Part 15 of the U.S. Federal Communications Commission (FCC) Rules. Operation is subject to the following two conditions:

1. This device may not cause harmful interference.

2. This device must accept any interference received, including interference that may cause undesired operation.

Icon Table

Table 6.6: Icons













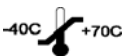



	Attention: See Instructions for Use
	Date of Manufacture (year - month)
Rx _{Only}	CAUTION: U.S. law restricts the Guardian RT and system components to sale by or on the order of a physician.
SN	Serial Number
	Storage Temperature Range
	Type BF Device (Protection from electrical shock)
	On/Off
	Backlight
	Batch Number
REF	Catalogue Number
	Fragile Product
	Protect Against Moisture
	Open Here
	Recycling Symbol
	Sterilized Using Irradiation
	Do Not Re-Use; Single use only

Table 6.6: Icons

	Radio Communication
	Manufacturer
	CE Mark By Notified Body As a Medical Device
	CE Mark With a Radio Transmitter Under The R&TTE1999/5/EC Directives
IPX1	Monitor: Protected Against the Effects of Vertically Falling Water Drops.
IPX8	Transmitter and Sensor: Protected Against the Effects of Continuous Immersion in Water.

Fixed Elements Table

Table 6.7: Fixed Elements

CAL	Displayed as a reminder or warning to the user to enter a BG value for glucose sensor calibration.
GLUCOSE	Displayed on screens related to glucose readings. Not used on Alarm History Screen but on the Alarm History Selection screen.
GLUCOSE HIST	Displayed on screens used for viewing or clearing glucose history values. Not used on the NOW screen.
GLUCOSE LIMIT	Displayed on screens showing hypoglycemia or hyperglycemia alarm limits.
GLUCOSE SENSOR	Displayed on screens showing raw glucose Sensor values or status.
SET	Displayed during parameter value selection.
SET GLUCOSE	Displayed when setting glucose measurement unit (mg/dl or mmol/l).
SET GLUCOSE LIMIT	Displayed when setting glucose limit values (hypoglycemia/hyperglycemia setting).

Electromagnetic Compatibility Compliance Information

In accordance with IEC 60601-1-2, the following information on electromagnetic compatibility compliance has been provided. Also refer to the section “Interference from Electrical Equipment” in *Chapter 6: System Maintenance*.

Table A1

Guidance and Manufacturer's Declaration - Electromagnetic Emissions		
The Guardian RT is intended for use in the electromagnetic environment specified below. The user of the Guardian RT should assure that it is used in such an environment.		
Emissions Test	Compliance	Electromagnetic Environment - Guidance
RF emissions CISPR 11	Group 1	The Guardian RT Monitor uses RF energy only for its internal function. Therefore, its RF emissions are very low and are not likely to cause any interference in nearby electronic equipment.
RF Emissions CISPR 11	Class B	The Guardian RT is suitable for use in all establishments, including domestic establishments, and those directly connected to the public, low-voltage, power-supply network that supplies buildings used for domestic purposes.
Harmonic Emissions IEC 61000-3-2	Not Applicable	Not Applicable
Voltage Fluctuations/Flicker Emissions IEC 61000-3-3	Not Applicable	Not Applicable

Table A2

Guidance and Manufacturer's Declaration - Electromagnetic Immunity			
The Guardian RT is intended for use in the electromagnetic environment specified below. The user of the Guardian RT should assure that it is used in such an environment.			
Immunity Test	IEC 60601 Test Level	Compliance Level	Electromagnetic Environment - Guidance
Electrostatic Discharge (ESD) IEC 61000-4-2	± 6 kV ± 8 kV air	$> \pm 8$ kV $> \pm 30$ kV air	Typical commercial, hospital, or home environment. Synthetic materials may be present. The relative humidity may be as low as 10%.
Electrical Fast Transient/Burst IEC 61000-4-4	Not Applicable	Not Applicable	Not Applicable
Surge IEC 61000-4-5	Not Applicable	Not Applicable	Not Applicable
Voltage Dips, Short Interruptions and Voltage Variations on Power Supply Input Lines IEC 61000-4-11	Not Applicable	Not Applicable	Not Applicable
Power Frequency (50-60 Hz) Magnetic Field IEC 61000-4-8	3 A/m	3 A/m	Power frequency magnetic fields should be at levels characteristic of a typical location in a typical commercial or hospital environment.

Table A2

Guidance and Manufacturer's Declaration - Electromagnetic Immunity			
The Guardian RT is intended for use in the electromagnetic environment specified below. The user of the Guardian RT should assure that it is used in such an environment.			
Immunity Test	IEC 60601 Test Level	Compliance Level	Electromagnetic Environment - Guidance
Conducted RF IEC 61000-4-6	Not Applicable	Not Applicable	<p>Portable and mobile RF communications equipment should be used no closer to any part of the Guardian RT than the recommended separation distance calculated from the equation applicable to the frequency of the transmitter.</p> <p>Recommended Separation Distance</p> <p>Not Applicable</p>
Radiated RF IEC 61000-4-3	3 V/m 80 MHz - 2.5 GHz	3 V/m	<p>$d = 1.2 \times \text{square root}[P]$ 80 - 800 MHz</p> <p>$d = 2.3 \times \text{square root}[P]$ 800 MHz - 2.5 GHz</p> <p>where P is the maximum output power rating of the transmitter in watts (W) according to the transmitter manufacturer, and d is the recommended separation distance in meters (m).</p> <p>Field strengths from fixed RF transmitters, as determined by an electromagnetic site survey^a, should be less than the compliance level in each frequency range.</p> <p>Interference may occur in the vicinity of equipment marked with the following symbol:</p> <p>L</p>

Guidance and Manufacturer's Declaration - Electromagnetic Immunity

Note 1: At 80 MHz and 800 MHz the higher frequency range applies.

Note 2: These guidelines may not apply in all situations. Electromagnetic propagation is affected by absorption and reflection from structures, objects and people.

^a Field strengths from fixed transmitters, such as base stations for radio (cellular/cordless) telephones and land mobile radios, amateur radio, AM and FM radio broadcast and TV broadcast cannot be predicted theoretically with accuracy. To assess the electromagnetic environment due to fixed RF transmitters, an electromagnetic site survey should be considered. If the measured field strength in the location in which the Guardian RT is used exceeds the applicable RF compliance level above, the Guardian RT should be observed to verify normal operation. If abnormal performance is observed, additional measures may be necessary, such as reorienting or relocating the Guardian.

Table A3

Recommended Separation Distances Between Portable and Mobile RF Communications Equipment and the Guardian RT		
<p>The Guardian RT is intended for use in an electromagnetic environment in which RF disturbances are controlled. The user of the Guardian RT can help prevent electromagnetic interference by maintaining a minimum distance between portable and mobile RF communications equipment (transmitters) and the Guardian RT as recommended below, according to the maximum output power of the communications equipment.</p>		
Rated Maximum Output Power of Transmitter (W)	Separation Distance According to Frequency of Transmitter (m)	
	80 MHz - 800 MHz	800 MHz - 2.5 GHz
	$d = 1.2 \times \text{square root } [P]$	$d = 2.3 \times \text{square root } [P]$
0.01	0.12	0.23
0.1	0.38	0.73
1	1.2	2.3
10	3.8	7.3
100	12	23
<p>For transmitters rated at a maximum output power not listed above, the recommended separation distance d in meters (m) can be estimated using the equation applicable to the frequency of the transmitter, where P is the maximum output power rating of the transmitter in watts (W) according to the transmitter manufacturer.</p> <p><i>Note 1: At 80 MHz and 800 MHz the separation distance for the higher frequency range applies.</i></p> <p><i>Note 2: These guidelines may not apply in all situations. Electromagnetic propagation is affected by absorption and reflection from structures, objects and people.</i></p>		

Glossary

- Alarm** - An audible tone or physical vibration that lets the user know of an important event.
- Calibration** - The process of adjusting how the Guardian RT turns electronic signals from the Sensor into glucose values. The Sensor is calibrated by entering fingerstick meter values into the Guardian RT memory.
- Com-Station** - A device that lets a personal computer (PC) communicate with the Guardian RT to download data.
- Diabetes Mellitus** - A medical condition in which the body cannot properly process glucose.
- Download** - The process of sending data from one electronic device to another. The Guardian RT can download glucose data to a PC (personal computer).
- False Alert** - When the Guardian RT alarms for low or high glucose, even though the alert is not confirmed by a blood glucose meter value beyond the limit.
- Fingerstick Glucose Meter Measurement** - Blood glucose measurement by which the tip of a finger is pricked, a drop of blood is placed on a test strip, and the strip is placed into a meter that reports blood glucose.
- Glucose** - A type of sugar found in the blood, and it is the chief energy source for living organisms.
- Glucose Sensor** - A device that can monitor glucose levels in the body by sending out electronic signals proportional to those levels.
- Guardian RT Monitor** - A medical device developed by Medtronic MiniMed that continuously monitors glucose levels and sends out high and low glucose alerts.
- Hyperglycemia** - Abnormally high levels of glucose in the blood.
- Hypoglycemia** - Abnormally low levels of glucose in the blood.
- Infection** - A possible side effect of medical-device usage where bacteria may cause symptoms of local pain, redness, tenderness and swelling.
- Initialization (INIT)** - The process of stabilizing the electronic signals sent out by the Sensor after insertion.
- Insulin** - A hormone that controls glucose levels in the body.
- Interstitial Fluid** - Fluid found just under the skin into which a Sensor is inserted to measure glucose levels.
- ISIG** - Electrical current that the Sensor sends to the Guardian, measured in nanoamperes (nA).
- Memory** - A component of the Guardian RT that stores Sensor data and programming information.
- Sen-serter** - Automatic device used to insert the glucose Sensor.
- Test Plug** - A device that can troubleshoot problems with the Monitor, Sensor or Transmitter.
- Transmitter** - A device that receives and processes signals from the Glucose Sensor and sends them to the Monitor.

