Computer

Model:8880CW

Medtronic

FCC Class B

This equipment has been tested and found to comply with the limits for a Class B digital device, pursuant to Part 15 of the FCC Rules.

These limits are designed to provide reasonable protection against harmful interference when the equipment is operated in a residential environment. This equipment generates, uses and can radiate radio frequency energy. If not installed and used in accordance with this user's manual, it may cause harmful interference to radio communications.

Note that even when this equipment is installed and used in accordance with this user's manual, there is still no guarantee that interference will not occur. If this equipment is believed to be causing harmful interference to radio or television reception, this can be determined by turning the equipment on and off. If interference is occurring, the user is encouraged to try to correct the interference by one or more of the following measures:

Reorient or relocate the receiving antenna

Increase the separation between the equipment and the receiver

Connect the equipment to a power outlet on a circuit different from that to which the receiver is connected

Consult the dealer or an experienced radio/TV technician for help

<i>Warning</i>	<i>Any changes or modifications made to the equipment which are not expressly approved by the relevant standards authority could void your authority to operate the equipment.</i>
----------------	--

<i>Caution</i>	<i>Danger of explosion if battery is incorrectly replaced. Replace only with the same or equivalent type recommended by the manufacturer. Dispose of used batteries according to the manufacturer's instructions.</i>
----------------	---

Packing List

Before installing your MICA, ensure that the following materials have been received:

- MICA-101 x1
- Stylus pen x1
- Power adapter x1
- Battery x1
- USB Type A to Mini B Cable x1
- Software CD x3 (Drivers and Utility, Recovery OS, Recovery Image)
- Warranty card x1



Figure 1.0 MICA and Accessories

<i>Warning</i>	<i>To prevent electric shock, Do not remove cover. No user serviceable parts inside, refer servicing to qualified personnel.</i>
----------------	--

Additional Information and Assistance

1. Visit the Advantech websites at www.advantech.com or www.advantech.com.tw where you can find the latest information about the product.
2. Contact your distributor, sales representative, or Advantech's customer service center for technical support if you need additional assistance. Please have the following information ready before you call:

Product name and serial number

Description of your peripheral attachments

Description of your software (operating system, version, application software, etc.)

A complete description of the problem

The exact wording of any error messages

This equipment is a source of electromagnetic waves. Before use please, make sure that there are not EMI sensitive devices in its surrounding which may malfunction therefore.

Warning	<ol style="list-style-type: none">1. <i>Input voltage rated 100-240 VAC, 47-63 Hz, 1.62-0.72A, Output Voltage rated 15VDC , max 4.2A</i>2. <i>Use a 3V @ 195 mA lithium battery (Model No. BR2032)</i>3. <i>Maintenance: to properly maintain and clean the surfaces, use only approved products or clean with a dry applicator</i>
----------------	---

Safety Instructions

1. Read these safety instructions carefully.
2. Keep this User's Manual for later reference.
3. Disconnect this equipment from any AC outlet before cleaning. Use a damp cloth. Do not use liquid or spray detergents for cleaning.
4. For plug-in equipment, the power outlet socket must be located near the equipment and must be easily accessible.
5. Keep this equipment away from humidity.
6. Put this equipment on a reliable surface during installation. Dropping it or letting it fall may cause damage.
7. The openings on the enclosure are for air convection. Protect the equipment from overheating. **DO NOT COVER THE OPENINGS.**
8. Make sure the voltage of the power source is correct before connecting the equipment to the power outlet.
9. Position the power cord so that people cannot step on it. Do not place anything over the power cord.
10. All cautions and warnings on the equipment should be noted.
11. If the equipment is not used for a long time, disconnect it from the power source to avoid damage by transient over voltage.
12. Never pour any liquid into an opening. This may cause fire or electrical shock.
13. Never open the equipment. For safety reasons, the equipment should be opened only by qualified service personnel.
14. If one of the following situations arises, get the equipment checked by service personnel:
 - a. The power cord or plug is damaged.
 - b. Liquid has penetrated into the equipment.
 - c. The equipment has been exposed to moisture.
 - d. The equipment does not work well, or you cannot get it to work according to the user's manual.
 - e. The equipment has been dropped and damaged.
 - f. The equipment has obvious signs of breakage.
15. **DO NOT LEAVE THIS EQUIPMENT IN AN UNCONTROLLED ENVIRONMENT WHERE THE STORAGE TEMPERATURE IS BELOW -20° C (-4° F) OR ABOVE 60° C (140° F). THIS MAY DAMAGE THE EQUIPMENT.**
16. If your computer is losing dramatic time or the BIOS configuration reset to default, the battery has no power.

Caution	<ol style="list-style-type: none">1. <i>Do not replace battery yourself. Please contact a qualified technician or your retail.</i>2. <i>The computer is provided with a battery-powered real-time clock circuit. There is a danger of explosion if battery is incorrectly replaced. Replace only with same or equivalent type recommended by the manufacture. Discard used batteries</i>
----------------	---

	according to the manufacturer's instructions
--	--

17. IMPROPER INSTALLATION OF VESA MOUNTING CAN RESULT IN SERIOUS PERSONAL INJURY! VESA mount installation should be operated by professional technician, please contact the service technician or your retail if you need this service.

18. CLASSIFICATION:

- Supply Class I adapter
- No applied part
- IP54
- Continuous Operation
- Not AP or APG category

19. Disconnect device: Appliance inlet.

20. Follow the national requirement to dispose unit.

21. Maintenance: to properly maintain and clean the surfaces, use only the approved products or clean with a dry applicator.

22. Contact information:

No.1, Alley 20, Lane 26, Reuiguang Road Neihu District, Taipei,
Taiwan 114, R.O.C.
TEL: +886 2-27927818

23.



Medical Equipment
With Respect to Electric Shock,
Fire, and Mechanical Hazards Only,
In Accordance with UL 60601-1,
CAN/CSA C22.2 No. 601.1, and
IEC 60601-1

24. This equipment shall not be used for life support system.

25. Accessory equipment connected to the analog and digital interfaces must be in compliance with the respective nationally harmonized IEC standards (i.e. IEC 60950 for data processing equipment, IEC 60065 for video equipment, IEC 61010-1 for laboratory equipment, and IEC 60601-1 for medical equipment.) Furthermore all configurations shall comply with the system standard IEC 60601-1-1. Everybody who connects additional equipment to the signal input part or signal output part configures a medical system, and is therefore, responsible that the system complies with the requirements of the system standard IEC 60601-1-1. The unit is for exclusive interconnection with IEC 60601-1 certified equipment in the patient environment and IEC 60XXX certified equipment outside of the patient environment. If in doubt, consult the technical services department or your local representative.

26. User not to contact SIP/SOPs and the patient at the same time.

27. The sound pressure level at the operator's position according to IEC 704-1:1982 is no more than 70dB (A).

DISCLAIMER	<i>This set of instructions is given according to IEC 704-1. Advantech disclaims all responsibility for the accuracy of any statements contained herein</i>
-------------------	---

Explanation Of Graphical Symbols:



This symbol warns user that uninsulated voltage within the unit may have sufficient magnitude to cause electric shock. Therefore, it is dangerous to make any kind of contact with any part inside this unit.



This symbol alerts the user that important literature concerning the operation and maintenance of this unit has been included. Therefore, it should be read carefully in order to avoid any problems.



Stand-by



Direct Current

Section 15.105 Information to the user.

This Equipment has been tested and found to comply with the limits for a Class B digital device, pursuant to Part 15 of the FCC rules. These limits are designed to provide reasonable protection against harmful interference in a residential installation. This equipment generates, uses and can radiate radio frequency energy and, if not installed and used in accordance with the instructions, may cause harmful interference to radio communications. However, there is no guarantee that interference will not occur in a particular installation. If this equipment does cause harmful interference to radio or television reception, which can be determined by turning the equipment off and on, the user is encouraged to try to correct the interference by one or more of the following measures:

- Reorient or relocate the receiving antenna.
- Increase the separation between the equipment and receiver.
- Connect the equipment into an outlet on a circuit different from that to which the receiver is connected.
- Consult the dealer or an experienced radio/TV technician for help.

FCC Part 15.21 information for user

You are cautioned that changes or modifications not expressly approved by the party responsible for compliance could void your authority to operate the equipment.

FCC RF Radiation Exposure Statement:

1. This Transmitter must not be co-located or operating in conjunction with any other antenna or transmitter.
2. This equipment complies with FCC RF radiation exposure limits set forth for an uncontrolled environment. This device was tested for typical lap held operations with the device contacted directly to the human body to the back side of the notebook computer. To maintain compliance with FCC RF exposure compliance requirements, avoid direct contact to the transmitting antenna during transmitting.

except above RF exposure statement, for devices used at 5.15-5.25GHz should add the following wording at their user manual.

According to FCC 15.407(e), the device is intended to operate in the frequency band of 5.15GHz to 5.25GHz under all conditions of normal operation. Normal operation of this device is restricted to indoor used only to reduce any potential for harmful interference to co-channel MSS operations.

Chapter 1 General Information

1.0 Introduction

MICA is a multimedia Atom Mobile processor-based computer that is designed to serve as a Mobile Clinical Assistant (MCA). It is a PC-based system with 10.4" color TFT LCD display and 18-bit stereo audio controller. MICA is a mobile for system integrators, this simple, complete and highly integrated multimedia system lets you easily build a Mobile Clinical Assistant Terminal into your applications.

Common industrial applications include factory automation systems, precision machinery, and production process control. It is also suitable for many non-industrial applications, including interactive kiosk systems, entertainment management, and car park automation. MICA is a reliable, cost-effective solution to your application's processing requirements.

1.1 Specifications

Item	Description
Dimension (W xDxH)	254.7mm x 254.7mm x 30mm
Weight	1.5Kg (Max)
CPU and Chipset	Intel® Atom Processor and Intel® Poulbso SCH - Z510/1.1GHz (FSB 400MHz) - Z530/1.6GHz (FSB 533MHz)
Memory	DDR2 667MHz SO-DIMM 2GB
Graphics	Intel® Integrated 3D Graphics
Audio	Realtek ALC888 Integrated speakerx1, Microphone x2
I/O Ports	USB 2.0x1 DC-in Cradle connector Card reader for smart card
Expansion	mini-PCIe x1
Display	10.4" XGA TFT LCD
Touch Panel	Dual mode –Digitizer & Resistive
Stylus Pen	Electronic stylus pen with side switch and eraser
Storage	1.8" PATA HDD 60GB
Communication	WiFi- 802.11AGN WLAN Bluetooth V2.0
Ingress Protection	IP54
Thermal Solution	Fanless Design
Operating System	Windows XP Professional Windows Vista Business Windows XP Embedded
Barcode Scanner	1D/2D and UDSI Barcode scanner
RFID	- 13.56MHz RFID with ISO15693 & ISO14443A/B

	- Active Tag function
Camera	2.0Mega pixel camera with LED light Auto-focus supported
Web camera	1.3M pixel VGA camera (Optional)
Control Button	Power button: On the left side of MICA
	Barcode scan button: On the right side of MICA.
Control Button	Composite button
	<ul style="list-style-type: none"> • Navigator button: One 5-way directional control button for navigation. • Camera snapshot button • RFID read trigger button • Screen lock button • 2 programmable buttons (Default setting): <ul style="list-style-type: none"> - Programmable button 1 for S3 mode - Programmable button 2 for WiFi on/off
Indicated LED	Power LED & Battery status LED
	<ul style="list-style-type: none"> • Full → Green • Charging → Green + Red • Low → Red
	RFID LED
	<ul style="list-style-type: none"> • Blue LED for RFID read trigger
Indicated LED	WiFi LED
	<ul style="list-style-type: none"> • Blue LED for enabling Wireless LAN
	Bluetooth
<ul style="list-style-type: none"> • Blue flickering LED for enabling Bluetooth 	
Power adapter	SINPRO MPU63 INPUT:100-240V ~ 1.5A 50/60Hz OUTPUT: 15V, 4.2A Max.60W
Battery	Lithium-ion battery (11.1V@3760mAh) 2.5Hr charging time
Backup battery	Lithium-ion battery 40mAh 24Hr charging time
Power management	Normal mode: general using Idle mode: turn-off the LCD backlight only. Suspend mode: S3 (STR) /S4 (STD) Power-off mode: only RTC alive
Certification	
Standards	ACPI 3.0 compliant
Regulatory	FCC part 15 class B CAN/CSA Optional: R&TTE, GSM, RFID
Safety	FCC/ANSI UL, CUL, CE, (IEC/EN60601-1)

	CB60601, CB60950 UL2054, UN38.3 for battery pack BSMI CCC
--	--

Table 1.1: MICA specification

1.2 Cradle Specifications

Item	Description
Form Factor	TBD
Weight	TBD
I/O Ports	USB x1
	LAN x1
	VGA x1
	Power-in Jack

Table 1.2: Cradle specification

1.3 LCD Panel Specifications

LCD model	Toshiba LTD104KA1S	
Display type	TFT color LCD	
Size (Diagonal)	10.4"	
Resolution	1024(W) x 768(H) pixels (XGA)	
Maximum colors	256K(R,G,B 6 bit color data)	
Pixel pitch (mm)	0.2055(W) x 0.2055(H)	
viewing angle	(Upper+Lower)	50 degree
	(Left+Right)	90 degree
Luminance (cd/m ²)	230 cd/m ²	
Contrast ratio	250:1	
Lamp lifetime	50,000 hours	

Table 1.2: Toshiba LCD Panel specification

1.4 Touchscreen Specifications

Type	Analog Resistive
Resolution	Continuous
Light Transmission	75%
Controller	USB interface
Power Consumption	+5V@100 mA
Software Driver	Supports Windows®XP Professional, Windows®Vista Business
Durability (touches in a lifetime)	30 million

Table 1.3: Touch screen specification

Note	MICA Terminal with the optionally installed touchscreen will share USB. Once the touch screen is installed, one USB cannot be used for other purposes.
------	--

Cleaning/Disinfecting

During normal use MICA may become soiled and should, therefore, be cleaned regularly.

Agents: Green tintured soap and Enzymatic detergents

Steps:

1. Wipe MICA with a clean cloth that has been moistened in the cleaning solution.
2. Prepare agent per manufacturer' s instructions or hospital protocol.
3. Wipe thoroughly with a clean cloth

<i>Cautions</i>	<i>Do not immerse or rinse MICA and its peripherals. If you accidentally spill liquid on the device, disconnect the unit from the power source. Contact your Biomed regarding the continued safety of the unit before placing it back in operation. Do not spray cleaning agent on the chassis. Do not use disinfectants that contain phenol. Do not autoclave or clean MICA or its peripherals with strong aromatic, chlorinated, ketone, ether, or Esther solvents, sharp tools or abrasives. Never immerse electrical connectors in water or other liquids.</i>
-----------------	--

1.5 Dimensions

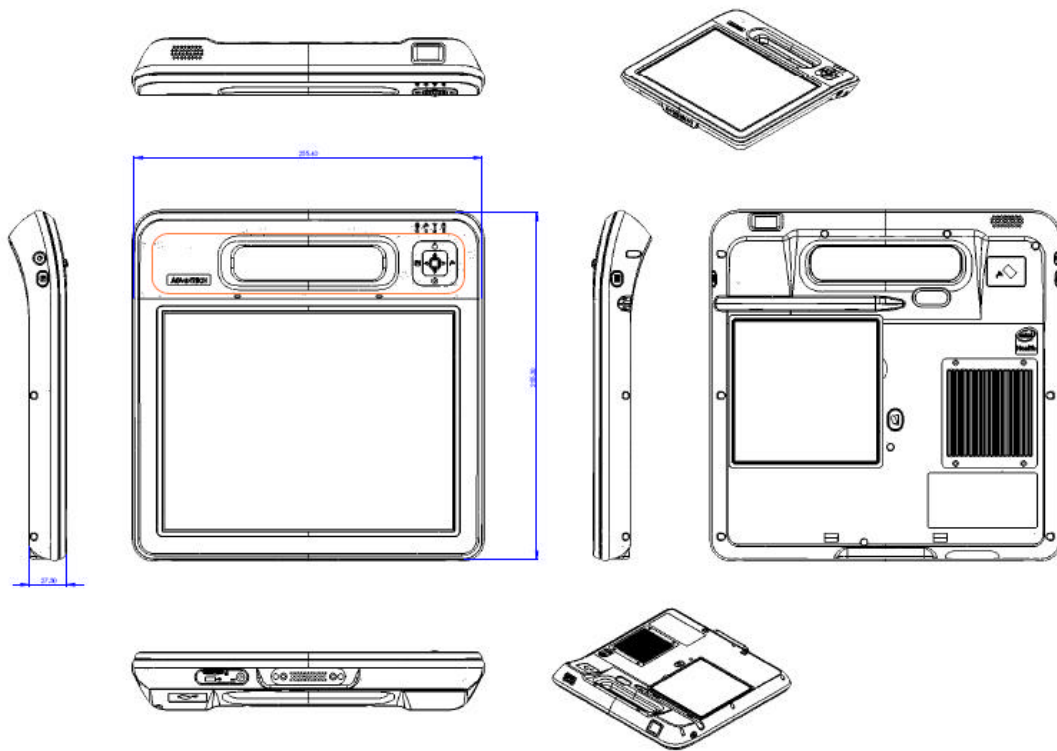
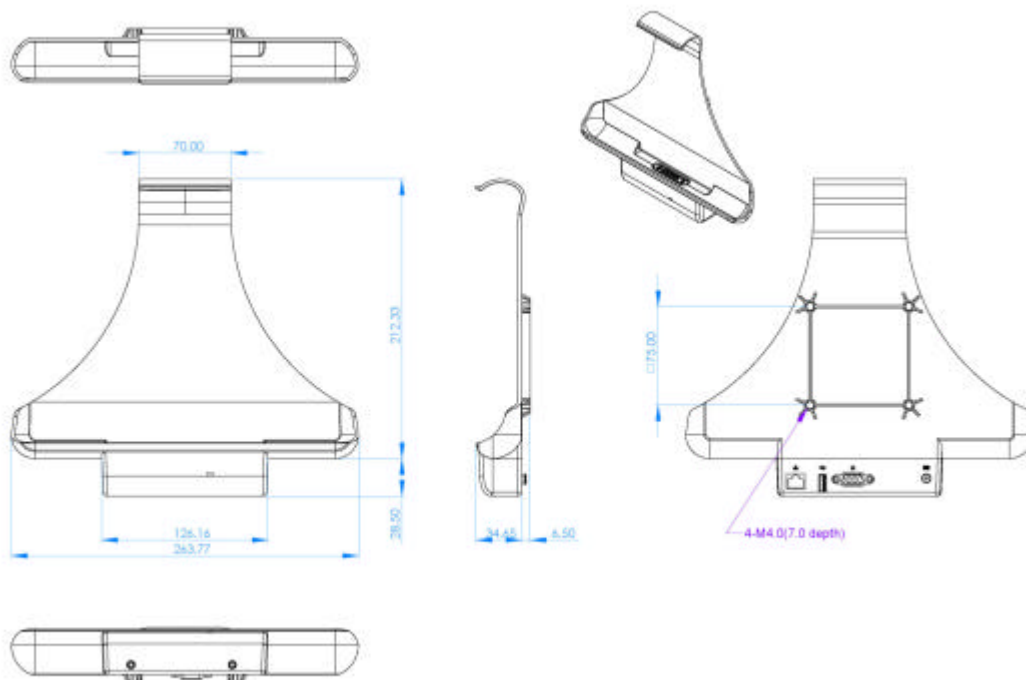

Figure 1-1: Dimensions of MICA



PDF created with FinePrint pdfFactory trial version <http://www.fineprint.com>

Figure 1-2: Dimensions of Cradle

Chapter 2 System Setup

2.1 A Quick Tour of MICA

Before you start to set up MICA, take a moment to become familiar with the locations and purposes of the controls, drives, connections and ports, which are illustrated in the figures below.

When you place MICA upright on the desktop, its front panel appears as shown in Figure 2-1.

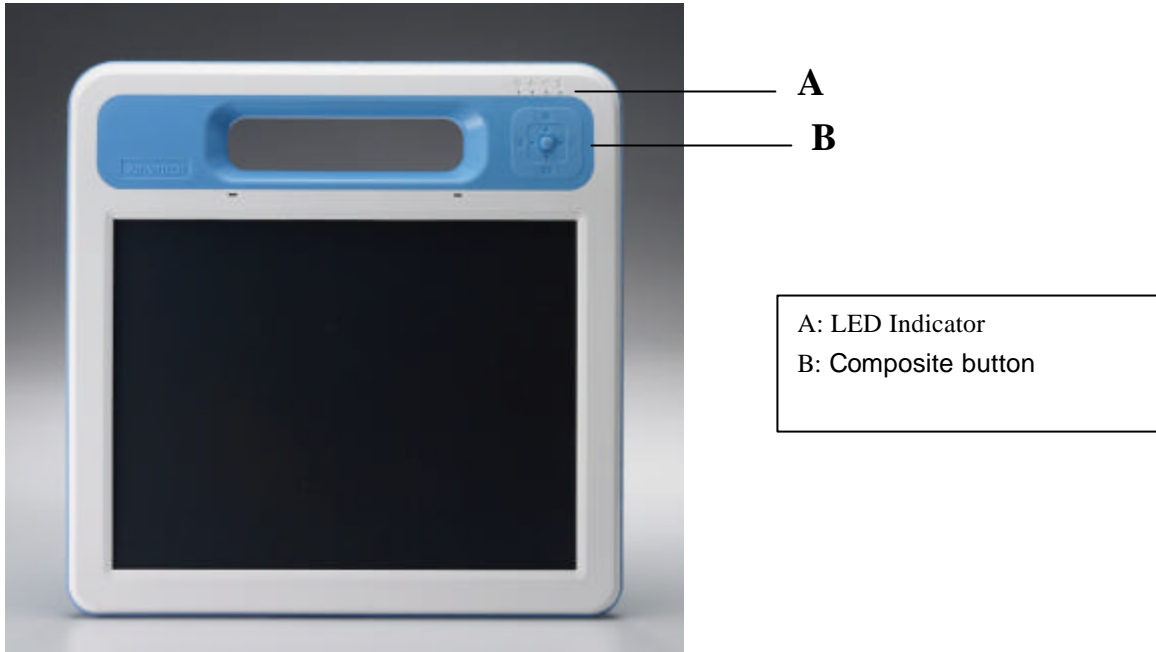

Figure 2-1: Front View of MICA

When you look at the left side of the panel PC, you will see the power button and P2 button on the top view. Figure 2-2.

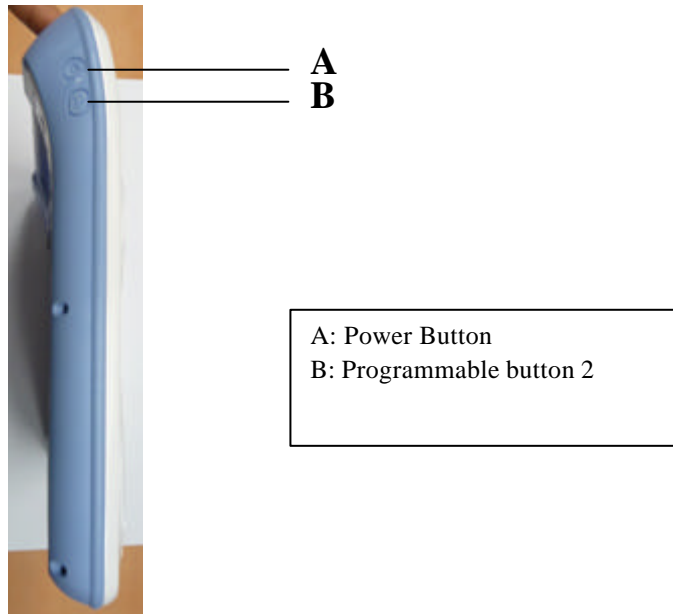
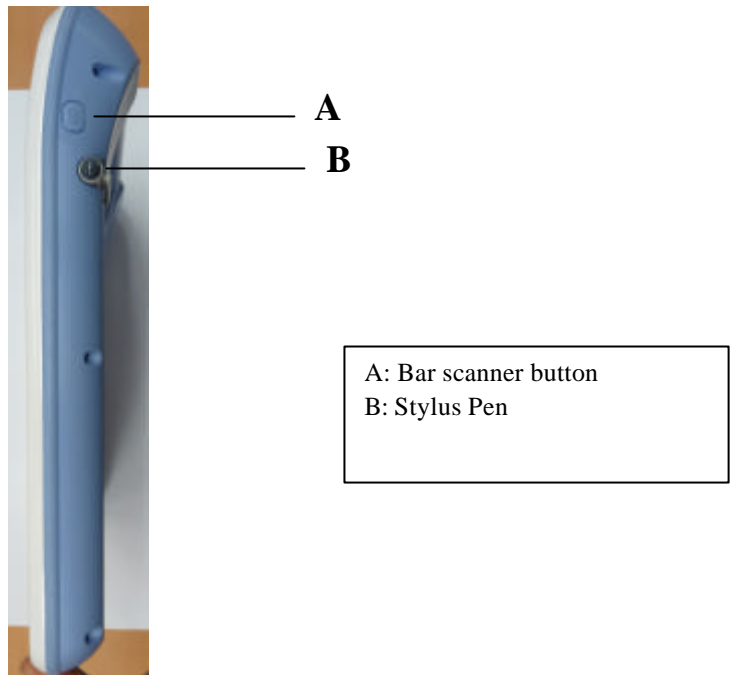

Figure 2-2: Left side view of MICA

When you look at the right side of the panel PC, you will see the Bar code scanner button and Stylus pen. Figure 2-3.



A: Bar scanner button
B: Stylus Pen

Figure 2-3: Left side view of MICA

When you turn MICA around and look at its rear cover. Figure 2-4.

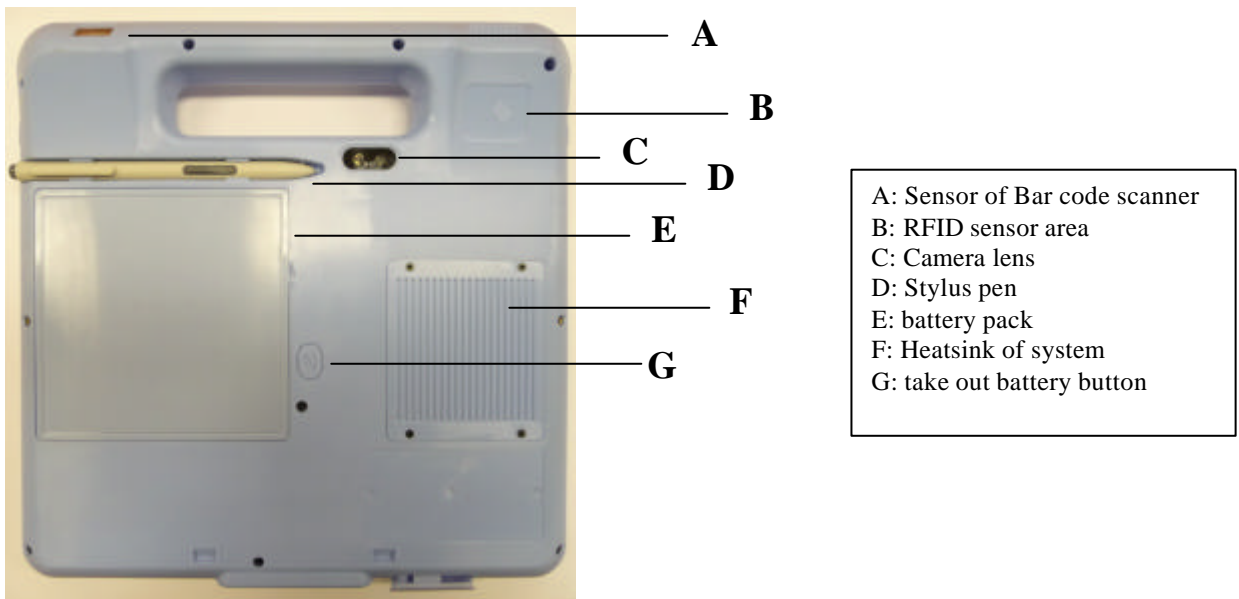

A: Sensor of Bar code scanner
B: RFID sensor area
C: Camera lens
D: Stylus pen
E: battery pack
F: Heatsink of system
G: take out battery button

Figure 2-4: Rear view of MICA

When you look at the bottom side of the panel PC, you will see the I/O ports (power jack/USB jack/smart card slot) and charging connector. Figure 2-5.



Figure 2-5: Bottom view of MICA

2.2 Installation Procedures

2.2.1 Powering MICA by Battery Power

MICA is supplied with a powerful rechargeable battery. To install and maintain the battery, or if it needs to be replaced, follow the instructions in this section.



Caution! Do not attempt to replace the battery with any others than the models recommended and manufactured specifically for this MICA.

Note! Before using MICA, please connect the adapter into MICA to charge the battery and backup battery at least 24Hrs.

2.2.1.1 Installing a Battery

The battery is designed specifically for installation with MICA. It fits exactly into the back of the PC and delivers precisely the exact voltage required to power the unit. Under normal conditions, a fully charged battery will power the PC for up to **5.0 hours**. Normally, it requires **2.5 hours** to fully charge a new battery.

- To install or replace the battery pack:
 1. Turn off MICA
 2. Disconnect any peripheral devices from MICA.
 3. Press the position as thumb in Figure2-6 then can remove the battery.

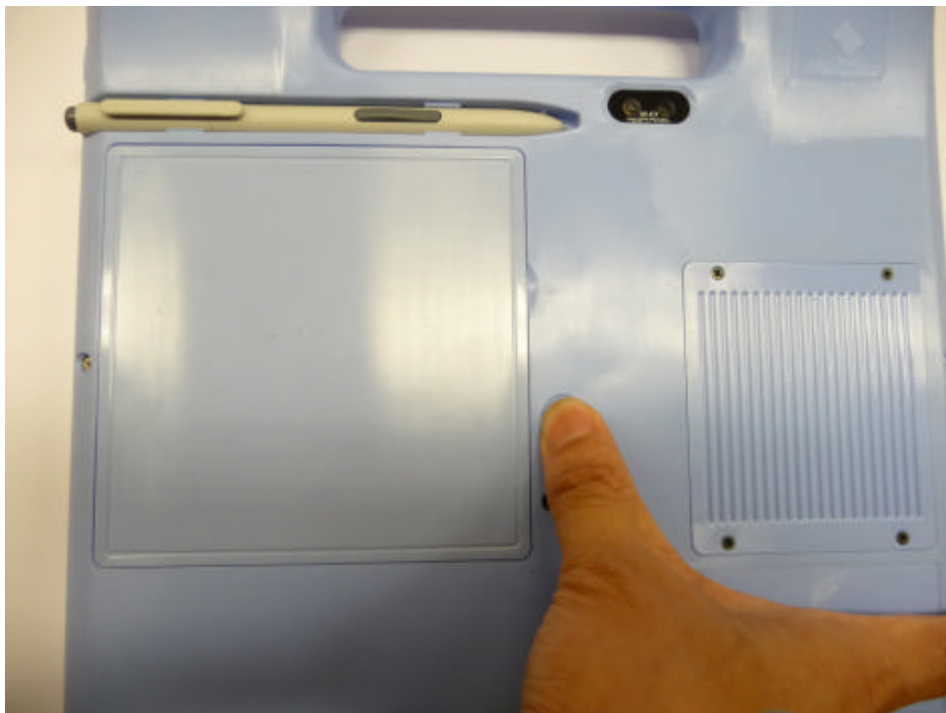

Figure 2-6: Press the position

4. Take out the battery from the system through below Figure2-7.

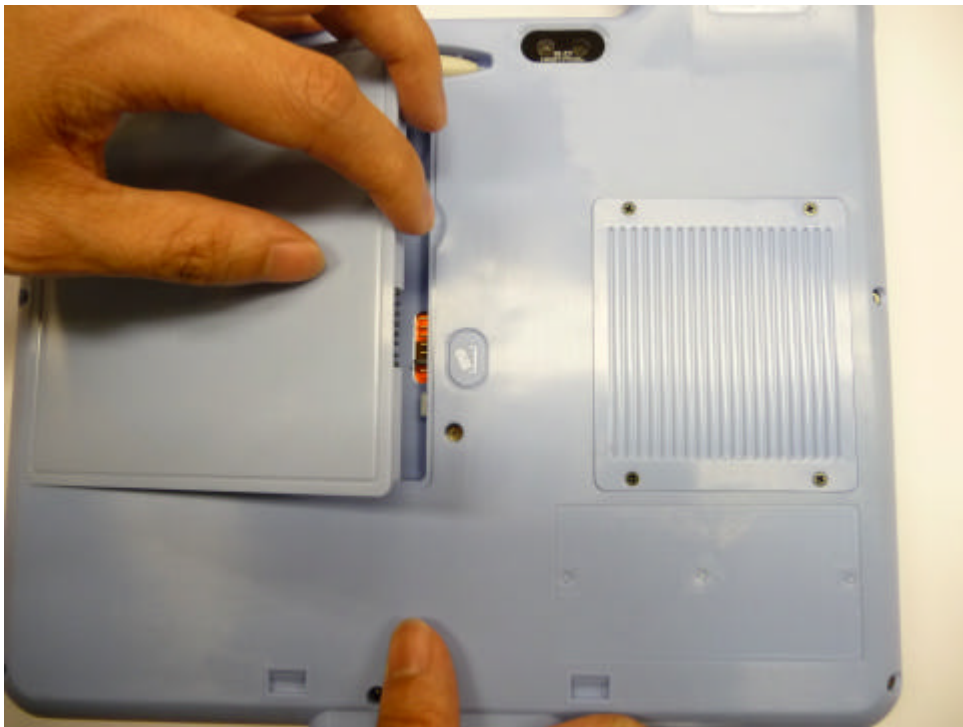

Figure 2-7: Take out the battery from the sytem

5. Push battery pack into the slot until click sound alarmed in Figure2-8.



Figure 2-8: Push battery back to slot

2.2.2 Connecting the adapter with MICA

Be sure to always handle the power cords by holding the plug ends only.

Follow these procedures in order:

1. Connect the end of the AC Adapter cord to the DC Power inlet of MICA. (See Figure 2-9.)
2. Connect the female end of the power cord to the AC inlet of the AC Adapter
3. Connect the 3-pin male plug of the power cord to an electrical outlet.



Figure 2-9: Connecting the AC Adapter power supplier with MICA

2.2.3 Connecting the power cord for CRADLE

Be sure to always handle the power cords by holding the plug ends only.

Follow these procedures in order:

1. Connect the end of the AC Adapter cord to the DC Power inlet of the CRADLE. (See Figure 2-10.)
2. Connect the female end of the power cord to the AC inlet of the AC Adapter
3. Connect the 3-pin male plug of the power cord to an electrical outlet.
4. Open the power switch on AC Adapter.

2.2.4 Connecting the keyboard and mouse

Connect the USB port to the USB mouse and keyboard port on the I/O section of MICA. (See Figure 2-10.)



Figure 2-10: Connecting the Keyboard or Mouse

2.2.6 Switching on the power

Switch on the power switch on the left side. Press the power switch button then can power on the system.



2.3 LED Signals

MICA is an equipment with a set of Light Emitting Diodes (LEDs) located along the right top of the front Bezel.



Figure 2-11: Front side view of MICA

2.3.1 Bluetooth ON/OFF LED

- **Blue flickering** : enable Bluetooth function
- **Dark** : disable Bluetooth function

2.3.2 RFID ON/OFF LED

- **Blue** : enable RFID function
- **Dark** : disable Bluetooth function

2.3.3 WiFi ON/OFF LED

- **Blue** : enable Wireless function
- **Dark** : disable Wireless function

2.3.4 Power/Battery Status LED

- **Green** : full charged
- **Red** : Low battery
- **Green+Red**: battery charging

2.4 Buttons

The hotkey button is on the right up side of front bezel.



Figure 2-12: Hotkey button of MICA

2.4.1 Barcode scanner button

The Barcode function button is up of the right side.



Figure 2-13: Right side of MICA

2.4.2 Power and P2 button

The Power button and P2 function buttons are up of the left side.



Figure 2-14: Left side button of MICA

2.4.3 Battery remove button

The battery remove button is in the center of the back side.



Figure 2-15: battery remove button of MICA

2.5 Running the BIOS Setup Program

Your MICA is likely to have been properly set up and configured by your dealer prior to delivery. You may still find it necessary to use the BIOS (Basic Input-Output System) setup program to change system configuration information, such as the current date and time or your type of hard drive. The setup program is stored in read-only memory. It can be accessed either when you turn on or reset the panel PC, by pressing the " Ctrl+Alt+Del " key on your keyboard immediately after powering on the computer.

The settings you specify with the setup program are recorded in a special area of memory called CMOS RAM. This memory is backed up by a battery so that it will not be erased when you turn off or reset the system. Whenever you turn on the power, the system reads the settings stored in CMOS RAM and compares them to the equipment check conducted during the power on self-test (POST). If an error occurs, an error message will be displayed on screen, and you will be prompted to run the setup program.

2.6 Installing System Software

Recent releases of operating systems from major vendors include setup programs which load automatically and guide you through hard disk preparation and operating system installation. The guidelines below will help you determine the steps necessary to install your operating system on the panel PC hard drive.

<i>Note</i>	<i>Some distributors and system integrators may have already pre-installed system software prior to shipment of your panel PC.</i>
-------------	--

If required, insert your operating system's installation or setup diskette into the optical drive until the release button pops out.

The BIOS supports system boot-up directly from the CD-ROM drive. You may also insert your system installation CD-ROM disk into the CD-ROM drive..

Power on or reset the system by pressing the "Ctrl"+"Alt"+"Del" keys simultaneously. MICA Terminal will automatically load the operating system from the diskette or CD-ROM.

If you are presented with the opening screen of a setup or installation program, follow the instructions on screen. The setup program will guide you through preparation of your hard drive, and installation of the operating system.

2.8 Installing the Drivers

After installing your system software, you will be able to set up the Ethernet, SVGA, audio and touch screen functions. All the drivers except the CD-ROM drive driver are stored in a CD-ROM disc entitled "Drivers and Utilities" which can be found in your accessory box.

The standard procedures for installing the Ethernet, SVGA, audio and touch screen drivers are described in Chapters 3, 4, 5, 6 and 7 respectively.

For your reference, the directory of drivers on the "Drivers and Utilities" CD-ROM is:

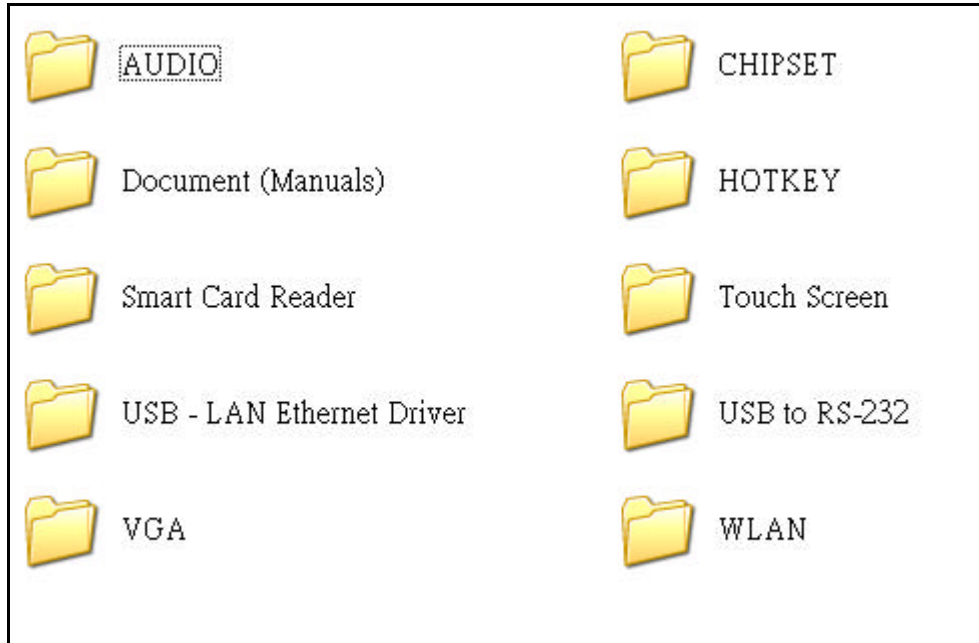

Figure 2-16: The file directory on "Drivers and Utilities" CD-ROM

Note	<i>The drivers and utilities used for MICA are subject to change without notice. If in doubt, check Advantech's website or contact our application engineers for the latest information regarding drivers and utilities.</i>
------	--

Chapter 3 Graphic chipset Setup

3.1 Introduction

The MICA uses Intel® Poulbso SCH chipset for its graphic controller. Poulbso is a single-chip system controller hub (SCH) that consists of an integrated graphics controller, memory controller, and I/O controller. The SCH contains functionality normally found in separate GMCH (front side bus interface, integrated graphics, memory controller) and ICH (platform I/O expansion) components.

3.2 Installation of Chipset Driver

Complete the following steps to install the chipset driver. Follow the procedures in the flow chart that apply to the operating system that you are using within your MICA.

Step 1 -1 double click the driver file and click next button



Step 1 -2 click yes button for license agreement

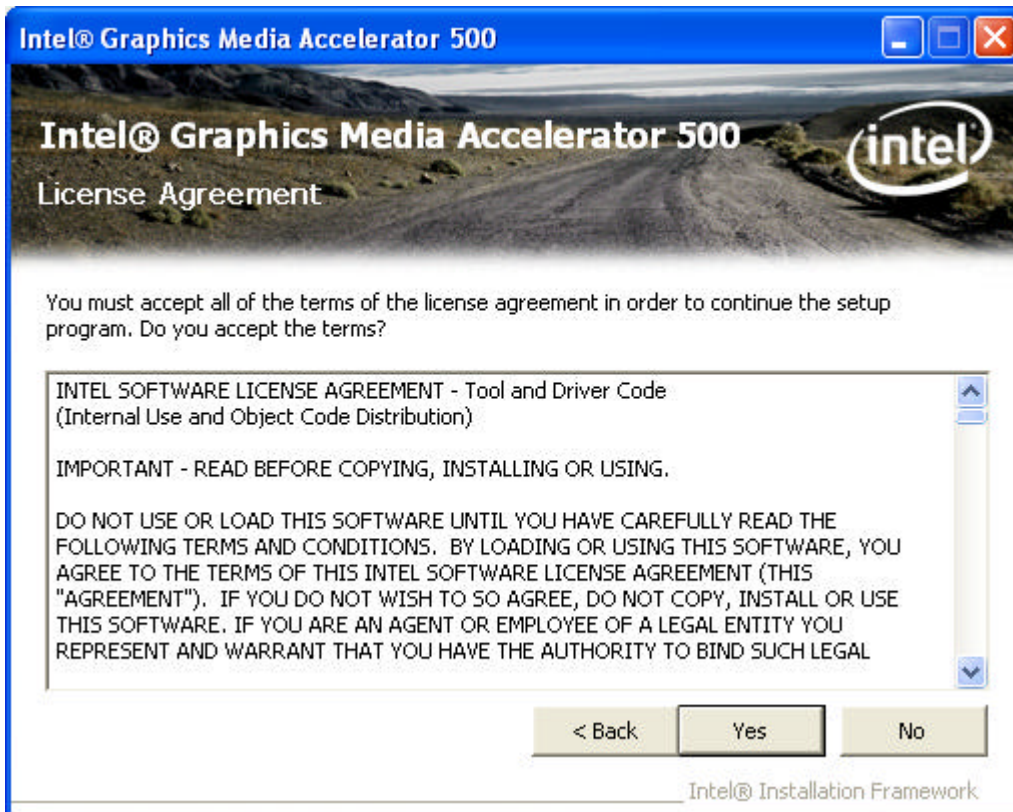

Step 1 -3 click next button for installation information

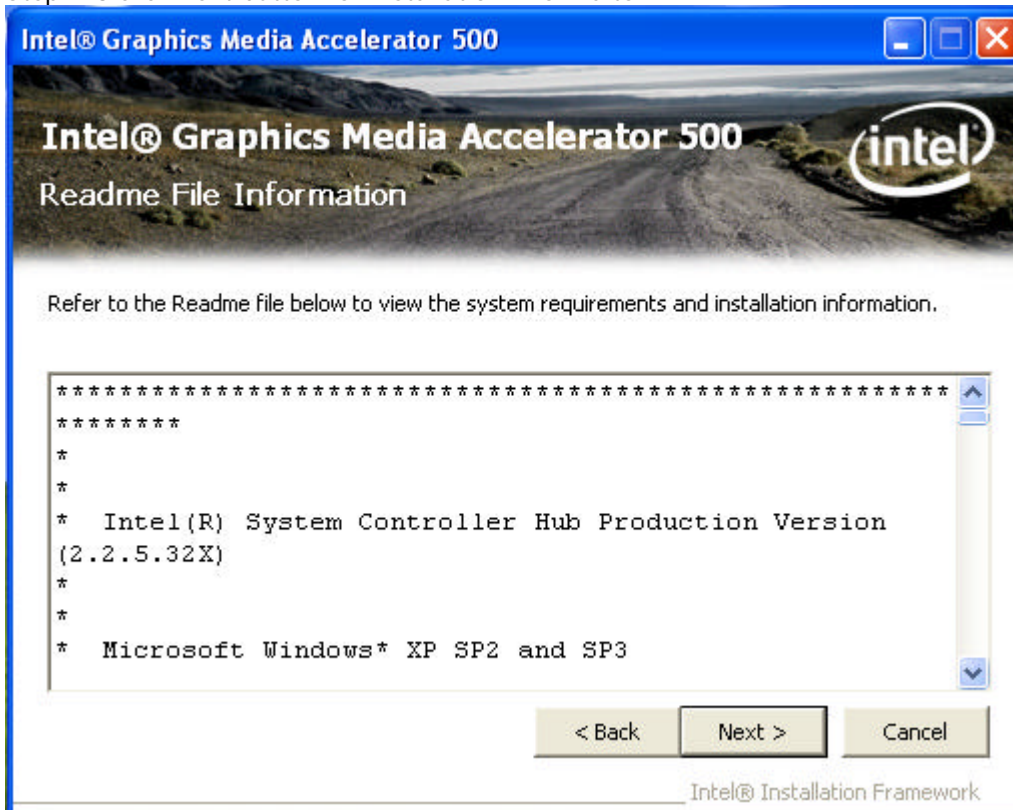

Step 1 -4 program has copy relevant file into system and click next to perform install

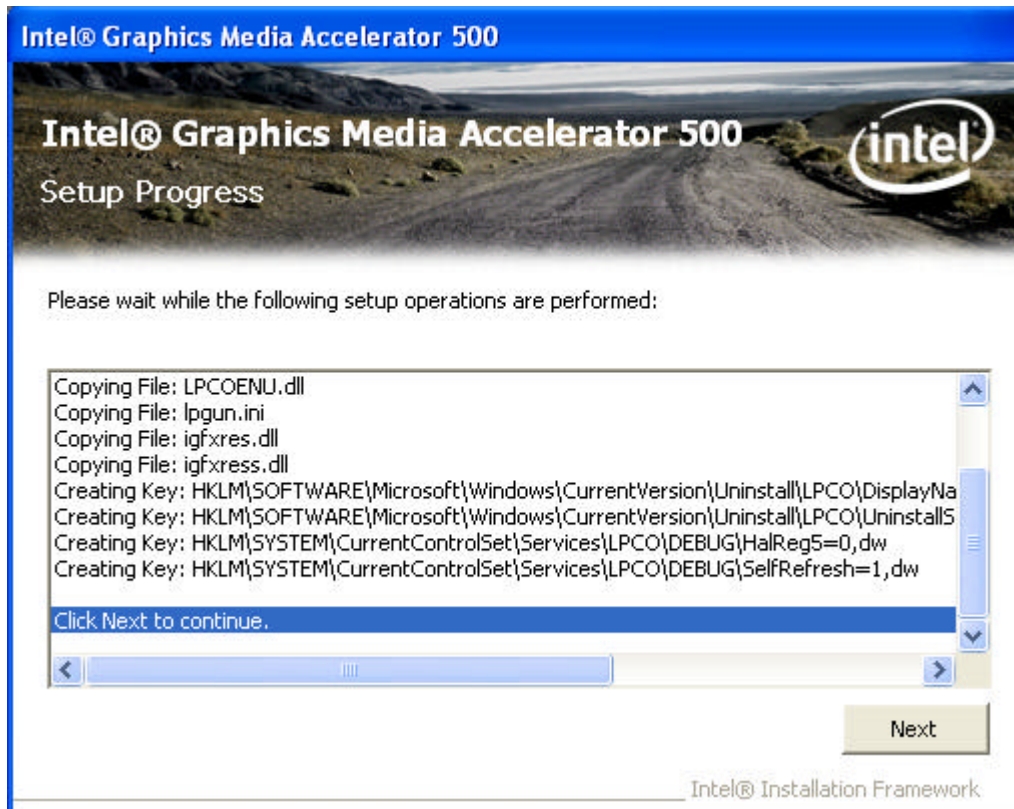

Step 1 -5 click finish button to restart system



Important	<i>The following windows illustrations are examples only. You must follow the flow chart instructions and pay attention to the instructions which appear on your screen.</i>
------------------	--

3.3 Further information

For further information about the CHIPSET, VGA installation in your MICA, included Driver updates, troubleshooting guides and FAQ lists please visit the following web resources.
Intel website: www.intel.com
Advantech websites: www.advantech.com

Chapter 4 Audio Setup

4.1 Introduction

Complete the following steps to install the Audio driver. Follow the procedures in the flow chart that apply to the operating system that you are using within your MICA.

4.2 Installation of Audio Driver

Step 1-1 double click driver file and click next button for continue installation.

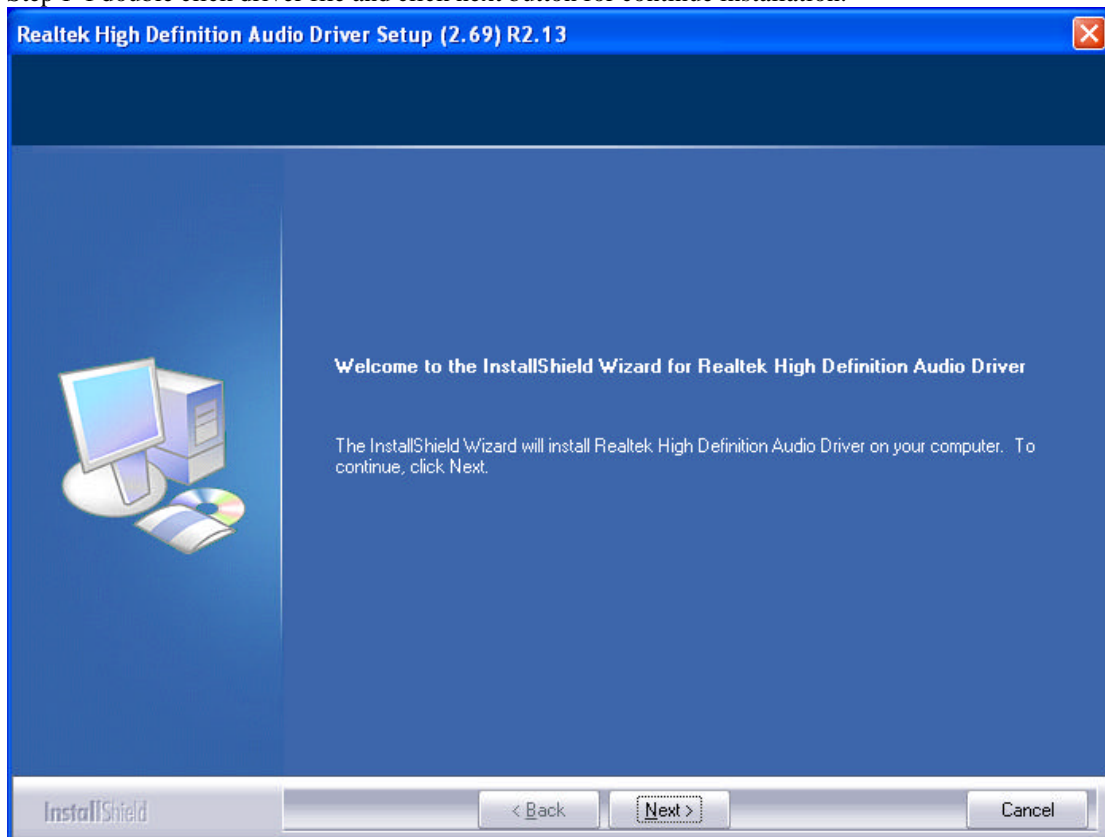

Step 1-2 Installation complete and press finish to restart the system.

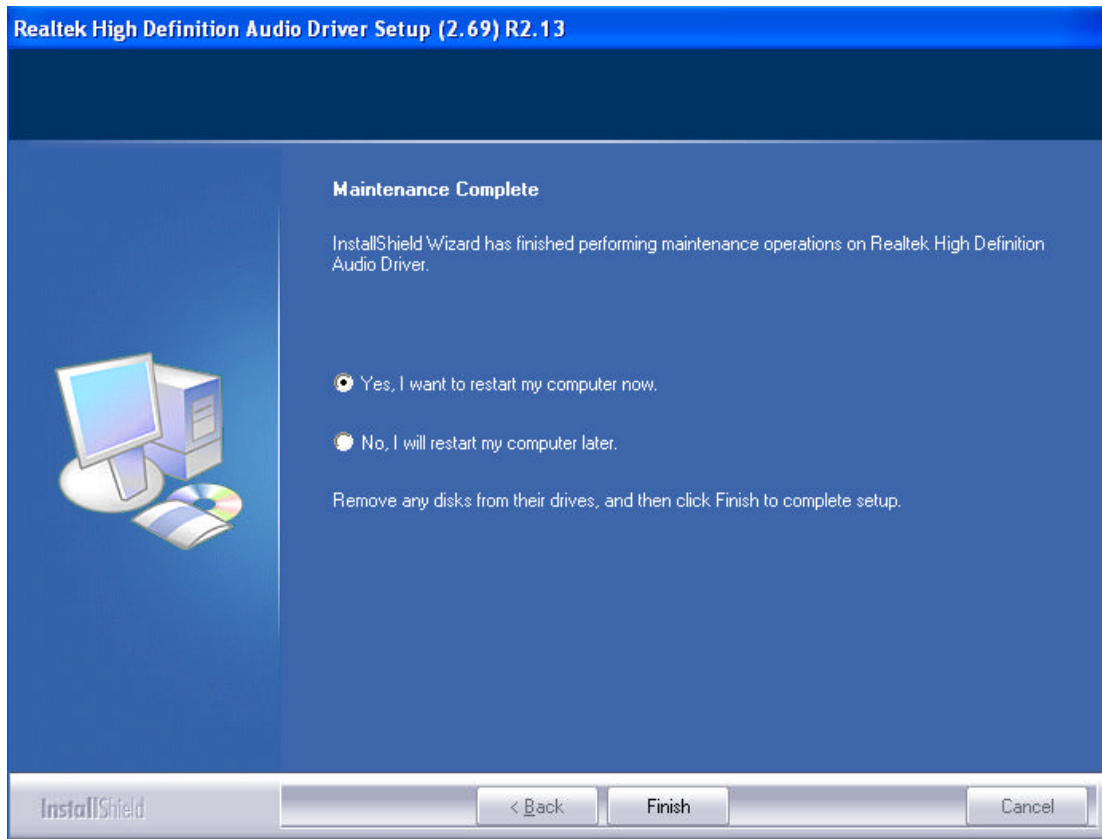

Important	<i>The following windows illustrations are examples only. You must follow the flow chart instructions and pay attention to the instructions which appear on your screen.</i>
------------------	--

4.3 Further information

For further information about the Audio installation in your MICA, included Driver updates, troubleshooting guides and FAQ lists please visit the following web resources.

Intel website: www.realtek.com

Advantech websites: www.advantech.com

Chapter 5 Touch screen Setup

5.1 Introduction

MICA support Dual-mode with pen and fingertip touch capabilities in a screen (touch input prioritization: pen first and then finger touch). Enables more intuitive, natural input (pen and touch) & enjoyable user experience

5.2 Installation of Touch screen Driver

Step 1-1 double click driver file and click accept button of license agreement to continue installation.



Step 1-2 the installation complete and restart the system.

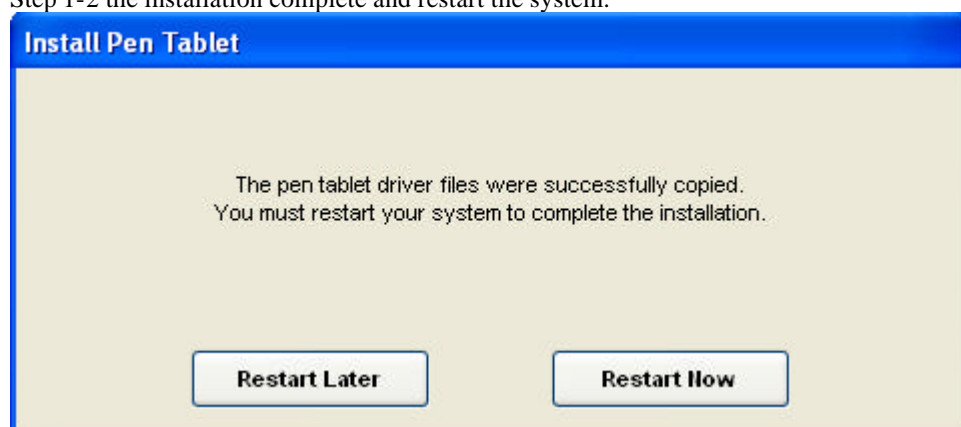

Important	<i>The following windows illustrations are examples only. You must follow the flow chart instructions and pay attention to the instructions which appear on your screen.</i>
------------------	--

5.3 Further information

For further information about the touch installation in your MICA, included Driver updates, troubleshooting guides and FAQ lists please visit the following web resources.

Intel website: www.wacom.com

Advantech websites: www.advantech.com

Chapter 6 Ethernet Driver Installation

6.1 Installation of ethernet driver

Step 1-1 double click driver file and click next button to continue installation.

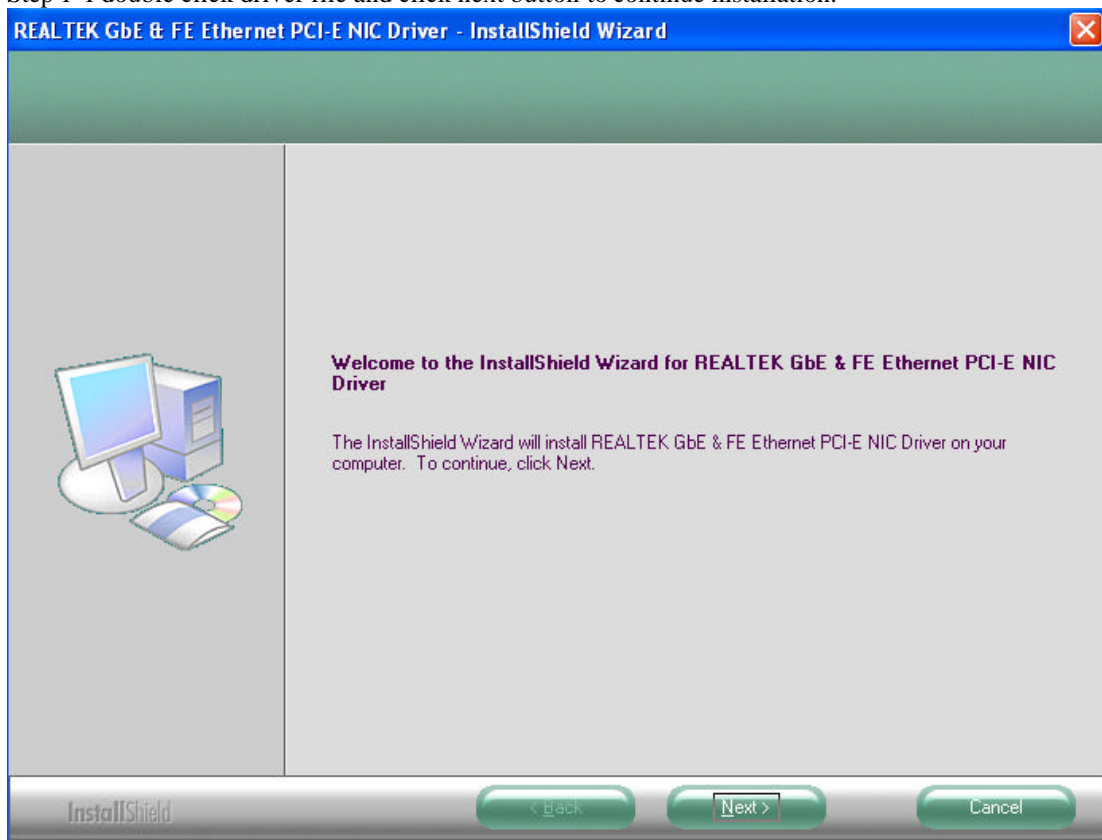

Step 1-2 click finish button to complete installation.

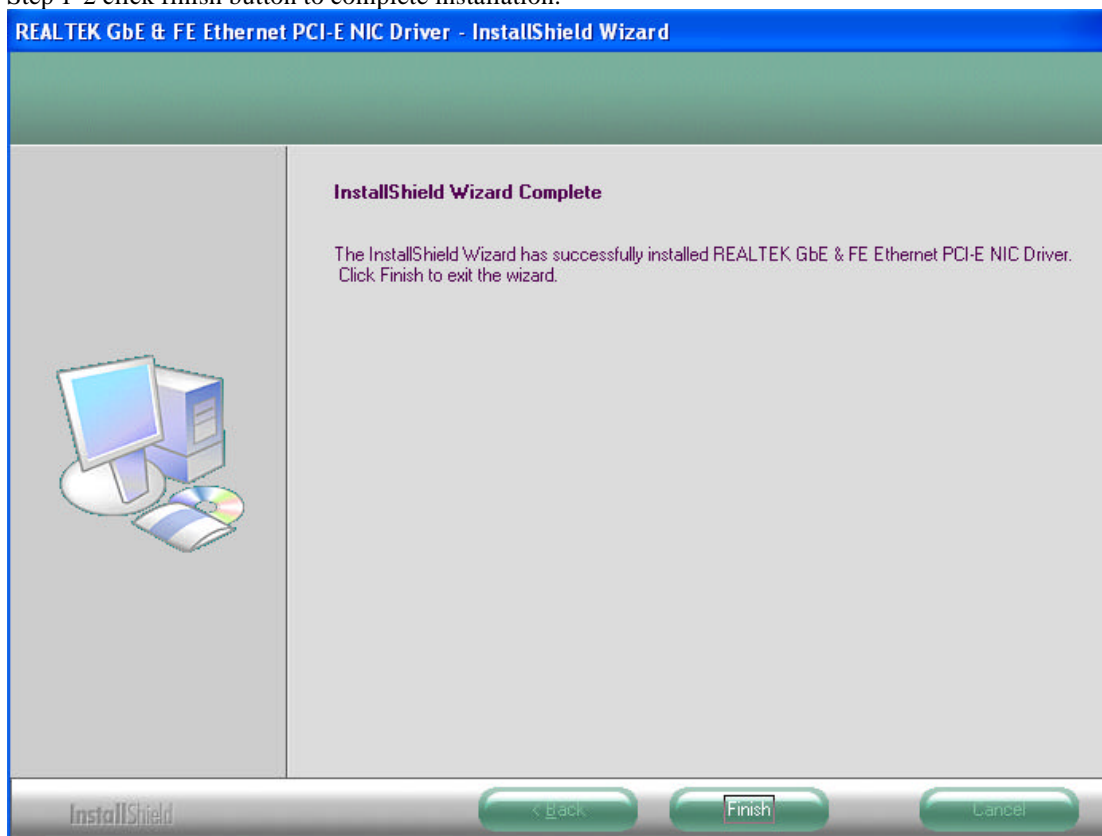

Important

The following windows illustrations are examples only. You must follow the flow chart instructions and pay attention to the instructions which appear on your screen.

5.3 Further information

For further information about the Audio installation in your MICA, included Driver updates, troubleshooting guides and FAQ lists please visit the following web resources.

Intel website: www.realtek.com

Advantech websites: www.advantech.com

Chapter 6 RFID driver installation

6.1 Introduction

MICA supports RFID reader function to help nurses identify patients and verify themselves as authorized caregivers, as well as reducing prescription errors. Besides, active tag allows the MICA to be tracked/managed as a medical asset at distances of one hundred feet or more, greatly improving the utility of the device.

6.2 Installation of RFID Driver

Step 1-1 double click driver file and click next button to continue installation.



Step 1-2 select a destination folder by browse button. The default is C:\Program Files\RFID\USB Driver. Click next button to continue installation.

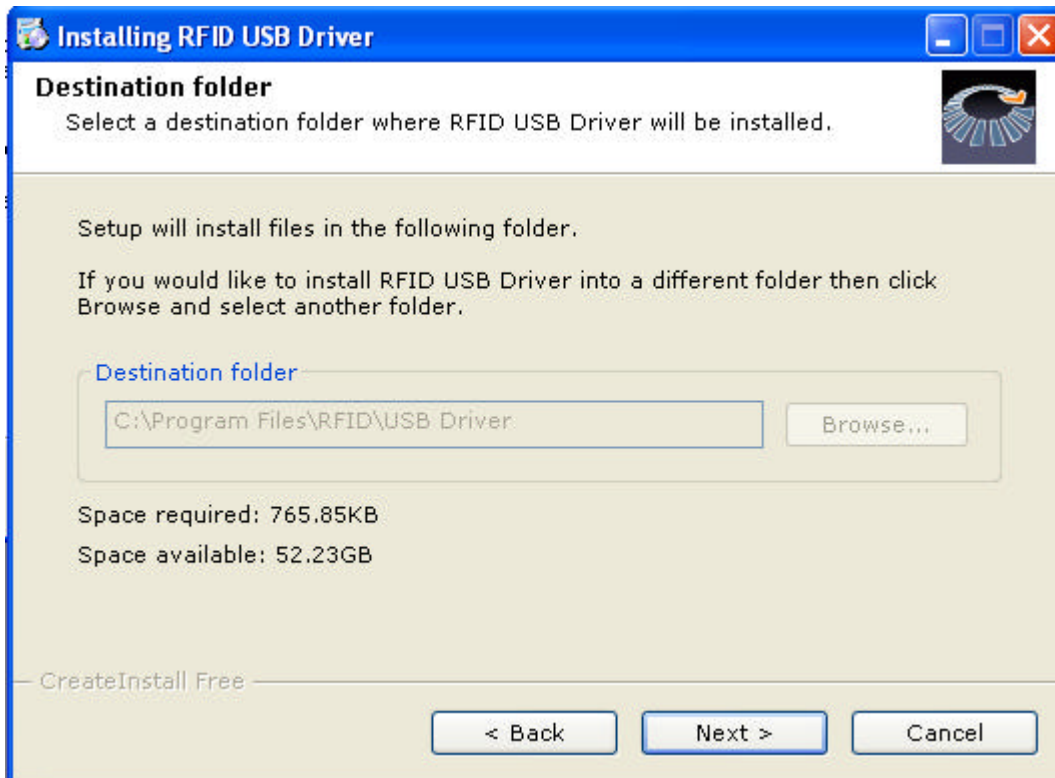

Step 1-3 click finish button to complete the installation.



Important	<i>The following windows illustrations are examples only. You must follow the flow chart instructions and pay attention to the instructions which appear on your screen.</i>
------------------	--

6.3 Further information

For further information about the Audio installation in your MICA, included Driver updates, troubleshooting guides and FAQ lists please visit the following web resources.

Intel website: www.mstar.com
Advantech websites: www.advantech.com

Chapter 7 WLAN Driver Installation

7.1 Introduction

MICA supports Mini PCI Express Wireless Module and complies with IEEE 802.11 a/b/g/n standard.

7.2 Installation of WLAN Driver

Step 1-1 double click driver file and click next button for continue installation.

<i>Important</i>	<i>The following windows illustrations are examples only. You must follow the flow chart instructions and pay attention to the instructions which appear on your screen.</i>
------------------	--

7.3 Further information

For further information about the Audio installation in your MICA, included Driver updates, troubleshooting guides and FAQ lists please visit the following web resources.

Intel website: www.sparklan.com

Advantech websites: www.advantech.com