

料号: **RP421B-快安指南 (MHT-L1081美恒通定制) -V1.1版本**

成品单页尺寸: 102x142mm

材质: 80g双胶纸 工艺: 正反面单黑印刷 5折页

注: 蓝色线框不印刷, 仅示意尺寸

V1.1升级原因: 增加FCC警示语

设计	王玉英
日期	2021.05.27
版本	V1.1版本

Connecting the Printer

■ Connect the power line

- Confirm that the power switch is in off (0) state.
- Connect the power adapter to the printer.
- Connect the power line to the power adapter.
- Connect the other end of the power line to a nearby socket.

Use the special power adapter for the printer.
The connection diagram is as follows:

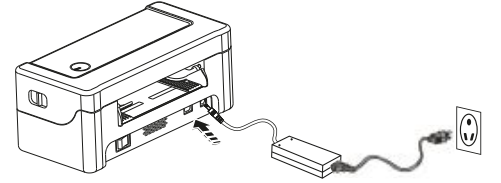

■ Connect the USB cable

- Connect the USB cable to the printer.
- Connect the USB cable to the PC host.
- Turn the power switch to on (I) state.

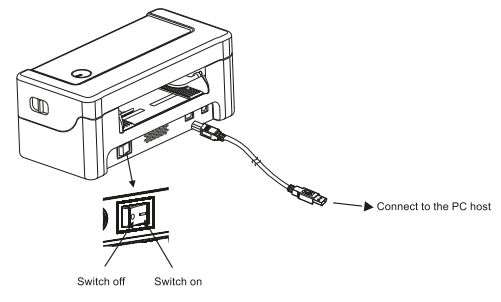

6

Print Self-Test Page

When the printer is initially installed or there are any problems with the printer, you can run self-test program to confirm the following status: firmware version, printer parameter setting status, print quality, and related setting information of external devices, etc. After confirming that there is no problem with the printer after the self-test, please check other devices or software. This function runs independently of other devices or software.

The self-test method is as follows:

- Confirm that the printer is connected to power supply and the paper roll is loaded correctly.
- Confirm that the printer is turned off and the top cover is closed in place.
- Press and hold the FEED button, then press the POWER button to turn on the printer, release the button after the printer is turned on.

Print with the Window Driver

- To install Windows driver, please refer to "Driver Installation Instruction".
- Set the "port" of the Windows driver as the appropriate interface to use. Print the test page with the "Print test page" function of Windows driver.

FCC Requirement

changes or modifications not expressly approved by the party responsible for compliance could void the user's authority to operate the equipment. This device complies with Part 15 of the FCC Rules. Operation is subject to the following two conditions:

- this device may not cause harmful interference, and
- this device must accept any interference received, including interference that may cause undesired operation.

Note: This equipment has been tested and found to comply with the limits for a Class B digital device, pursuant to Part 15 of the FCC Rules. These limits are designed to provide reasonable protection against harmful interference in a residential installation. This equipment generates, uses, and can radiate radio frequency energy, and if not installed and used in accordance with the instructions, may cause harmful interference to radio communications. However, there is no guarantee that interference will not occur in a particular installation. If this equipment does cause harmful interference to radio or television reception, which can be determined by turning the equipment off and on, the user is encouraged to try to correct the interference by one or more of the following measures:

- Reorient or relocate the receiving antenna.
- Increase the separation between the equipment and receiver.
- Connect the equipment into an outlet on a circuit different from that to which the receiver is connected.
- Consult the dealer or an experienced radio/TV technician for help.

7

Product Specification List

Printing method	Thermal line printer
Paper loading method	Easy paper loading/auto paper feeding
Printing speed	Actual speed detection: 127.38mm/s
Printing paper width	104mm
Effective resolution	203 dpi (300 dpi optional)
Paper type	Continuous paper, label paper, black label paper
Thickness of printing paper	0.06-0.18mm
Effective printing width	Min 38mm Max 112mm
Character size	ASCII Font A: 12x24 ASCII Font B: 9x17 Chinese character 24x24
Interface type	USB
Power adapter	DC 24V 2.5A
Working environment	Operating temperature: 0 ~ 45°C, Operating humidity: 20 ~ 90%
Storage environment	Storage temperature: -10 ~ 60°C, Storage humidity: 10 ~ 90%

8

Troubleshooting

The table below shows common problems and solutions for operators. If you have followed the simple troubleshooting methods but the printer is still not functioning properly, please contact the customer service department of your dealer for assistance.

Fault Phenomenon	Cause	Solution
POWER indicator is off	a. The AC plug and the power supply plug are not properly connected to the printer socket. b. The printer power switch is not on.	a. Check the power connection and confirm that the AC plug and the power supply plug are properly connected to the printer socket. b. Turn on the printer.
Unable to print	a. The communication cable is not properly connected to the printer and PC host. b. Communication interface setting error. c. Print status error.	a. Reconnect the communication cable.
Incomplete print content	a. The paper is not centered. b. Label size setting is incorrect.	a. Adjust the paper position. b. Set the correct label size.
Incorrect positioning	a. Label learning is performed. b. Seam label detection photocoupler is offset. c. Wrong mode selected.	a. Label learning is performed. b. Open the cover to confirm whether the seam label detection component is offset. For black label paper, move the seam label detection component according to the black label position so that the detection photocoupler can detect the black label. Label paper/continuous paper: The detection photocoupler must be in the paper range. c. Use the setting tool to open the printer information and confirm whether the paper type is the same as the paper loaded in the printer, which can be changed by using the setting tool.
Poor print result	a. Paper loading error. b. Print density/speed setting error. c. Print head/rubber roller has dust or adhesive accumulation. d. The print head is damaged.	a. Reload the paper. b. Readjust the print density/speed of printer by using the setting tool or the software. c. Printing density can be coarsely tuned with the setting tool and finely tuned with the driver. c. Clean the print head/rubber roller. (refer to 8.1 "Cleaning Print Head/8.2 "Cleaning Sensor/8.3 "Cleaning Printing Rubber Roller" of the Manual.) d. Use the setting tool to detect bad point of head piece. If the print head is damaged, please contact the customer service department of your dealer for repairs.

9

Thermal Express Printer

Quick Installation Guide

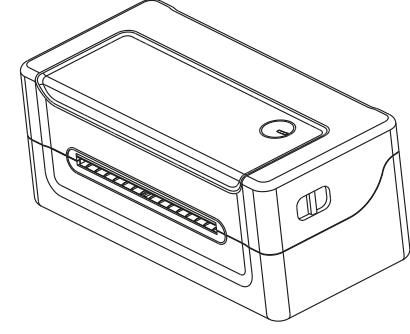

V1.1

102 mm

142 mm

正面

Safety Warnings

⚠ Warning: Do not touch the paper cutting knife or paper-tearing knife of the printer.

⚠ Warning: The print head is a heating component. Do not touch the print head and its surrounding components when the printer is still warm in temperature.

⚠ Warning: Do not touch the surface of the thermal print head and connectors, to avoid electrostatic damage to the print head.

⚠ Warning: This product is only suitable for the use in non-tropical climates.

Safety Instructions

- Please install the printer on a stable surface to avoid printer suffered from any vibration and shocks.
- Stop using keeping the product in any case of unusual circumstances such as the presence of high temperature, high humidity and serious pollution.
- Connect the printer's power adapter to an appropriate grounding socket. Avoid using the same socket with large motors or other equipment that may cause voltage fluctuation of power supply.
- Do not get the product wet. Do not insert foreign objects(e.g. metal) into the product, and once it occurs, immediately turn off the power supply.
- Never use the printer without paper, otherwise it will seriously damage the printing rubber roller and thermal head.
- Unplug the product from the power outlet if the printer is idle for a long time.
- Do not disassemble or modify the product personally.
- Use only the power adapter specified in this instruction.
- Do not plug/unplug the product with the product powered on.

In order to ensure the printing quality and prolong the service life of the product, it is recommended to use the recommended or equivalent thermal printing paper.

- When plugging and unplugging the printer power cord, please hold the arrow position of the printer power connector with your hand, not the cord of the printer power cord.
- Please keep this manual for the future use and reference.

1

Printer Unpacking

Before use, make sure the accessories are included in the package(the following picture is an example). If any thing is missing, contact the supplier or manufacturer.

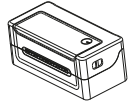

Main machine



Power adapter

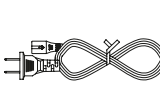

Power cord



USB cable



Quick Installation Guide

Label printer: 1 set	Power adapter: 1 pcs
Power cord: 1 pcs	USB cable: 1 pcs
Quick installation guide: 1 pcs	

⊙ The pictures are for reference only, please subject to practicality.

2

Appearance and Components

■ Front View

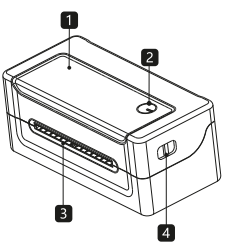

- Upper Cover
- FEED Button
- Paper Exit
- Cover Opening Key

■ Rear View

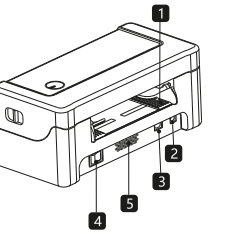

- Paper Guide
- Power Interface
- USB Interface
- Power Switch
- Heat Dissipation Port

■ Inside View

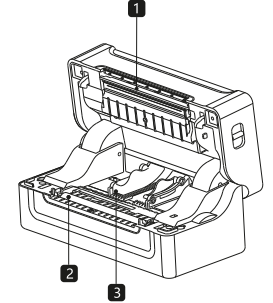

- Thermal Head Piece
- Rubber Roller
- Paper Guide

⊙ Note: The interface is optional or customized, and the specific interface is subject to the actual object.

3

Loading Paper

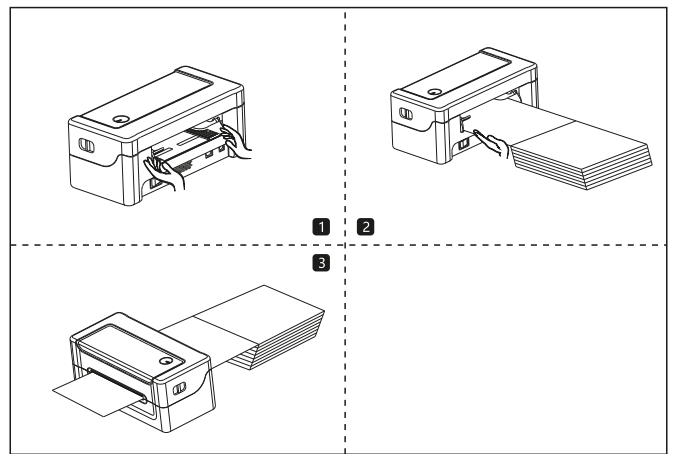

- Facing the back of the machine, hold the paper guide with both hands, and adjust the distance between the left and right guides according to the folded paper size.
- Insert the folded paper into the paper guide.
- Confirm that the printer has detected paper feeding, automatically feeds paper and delivers paper normally.

4

Keys and Indicators

■ Function description of buttons

Scenarios	Button operation	Corresponding functions
Power Off	Press and hold + turn on the printer	Print self-test page
Standby	Press and hold 3s	Enter label specification learning mode
Open the cover	Press and hold 10s	Restore factory settings
Standby	Press	Automatically feed one blank label sheet
Continuous printing process	Press	Pause printing
Pause printing	Press	Continue printing

■ Indicator description

Indicator status	Status description	
Indicator always lights up	Normal standby	
Indicator flashes	Buzzer alarm	
Buzzer alarm (common)	2 Sounds	Printer mechanism error
	3 Sounds	Paper shortage error
	5 Sounds	Overheating error
	6 Sounds	Cover opening error
	7 Sounds	Seam label error

5

102 mm

142 mm

反面



Thermal Label Printer

Quick Installation Guide

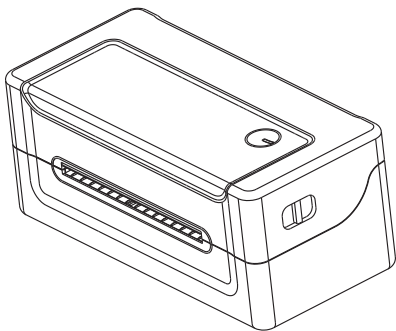

www.milestoneiot.com

Appearance and Components

■ Front View

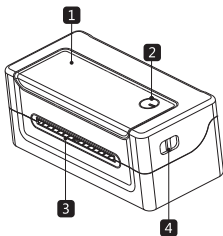

- 1.Upper Cover
- 2.FEED Button
- 3.Paper Exit
- 4.Cover Opening Key

■ Rear View

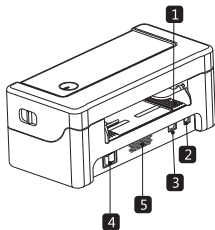

- 1.Paper Guide
- 2.Power Interface
- 3.USB Interface
- 4.Power Switch
- 5.Heat Dissipation Port

■ Inside View

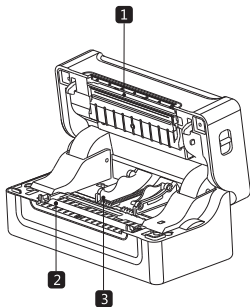

- 1.Thermal Head Piece
- 2.Rubber Roller
- 3.Paper Guide

☺ **Note:** The interface is optional or customized, and the specific interface is subject to the actual object.

Loading Paper

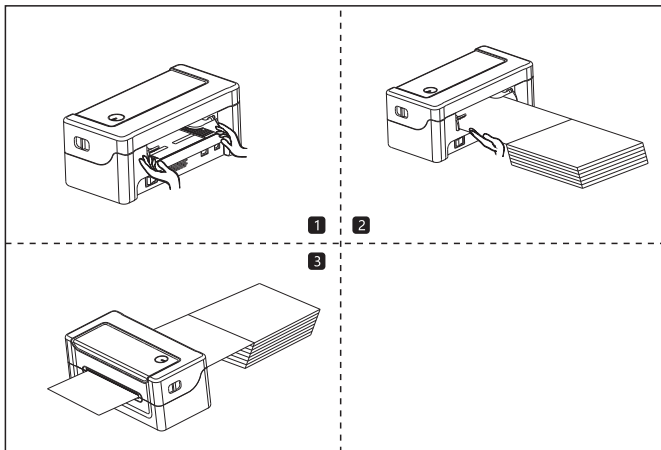

- (1) Facing the back of the machine, hold the paper guide with both hands, and adjust the distance between the left and right guides according to the folded paper size.
- (2) Insert the folded paper into the paper guide.
- (3) Confirm that the printer has detected paper feeding, automatically feeds paper and delivers paper normally.

Printer Unpacking

Before use, make sure the accessories are included in the package(the following picture is an example). If any thing is missing, contact the supplier or manufacturer.

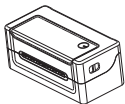

Main machine

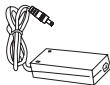

Power adapter



Power cord



USB cable



Quick Installation Guide

Label printer: 1 set	Power adapter: 1 pcs
Power cord: 1 pcs	USB cable: 1 pcs
Quick installation guide: 1 pcs	

☺ The pictures are for reference only, please subject to practicality.

Connecting the Printer

■ Connect the power line

- (1) Confirm that the power switch is in off (0) state.
- (2) Connect the power adapter to the printer.
- (3) Connect the power line to the power adapter.
- (4) Connect the other end of the power line to a nearby socket.

**Use the special power adapter for the printer.
The connection diagram is as follows:**

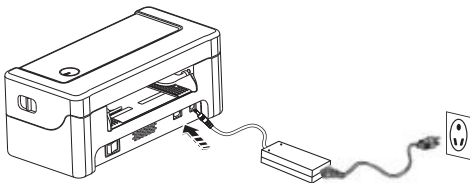

■ Connect the USB cable

- (1) Connect the USB cable to the printer.
- (2) Connect the USB cable to the PC host.
- (3) Turn the power switch to on (I) state.

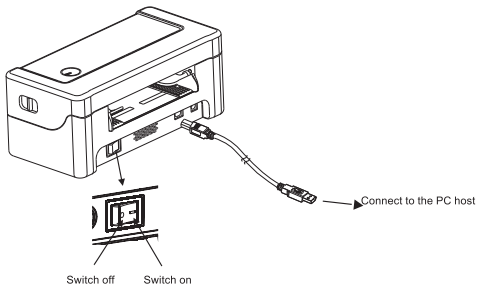

Windows Driver Installation

- 1 Connect the printer and the computer, and turn on the printer power.
- 2 Open the printer driver

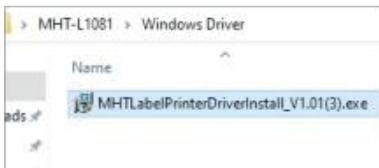

- 3 Open the printer driver

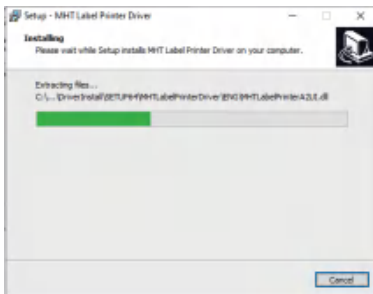
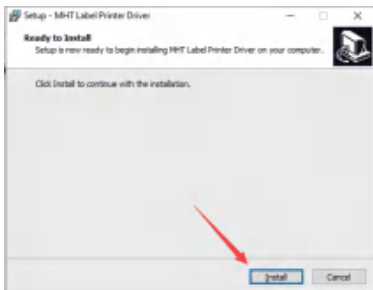

- 4 The driver has been successfully installed, please click Finish to close the page.



- 5 Open computer settings --> Devices --> Devices and printers.

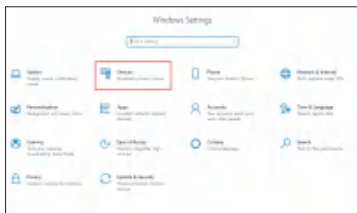

- ⑥ Find the MHT-L1081 printer and set it as the default printer. And change the properties of the printer, such as paper size. But we recommend using 4x6" or 100*150mm paper size for better printing results.

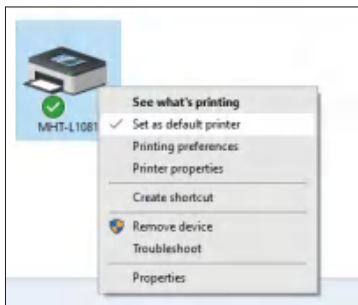

- ⑦ At this step, you have fully installed the printer, then please open the document and try to print a test. Please use 4x6 labels and open the test document "USPS Test1. pdf" attached to the USB flash drive. Please select 4x6" or 100*150mm for the print preview paper size. (Attention, if you encounter unable to print, please turn off the printer power and restart the printer).

Mac OS Driver Installation

- 1 Open The Pinter Driver.

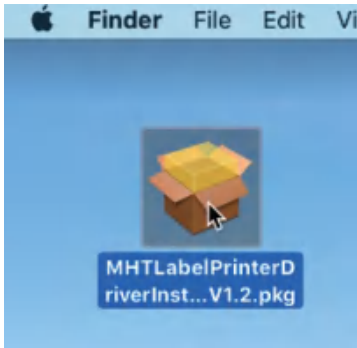

- 2 If the computer prompts that the document cannot be verified, please open "Security and Privacy", agree to open the driver document, and continue the installation.

①

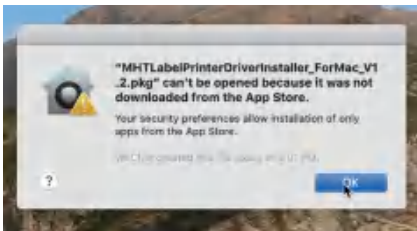

② Open System Preferences

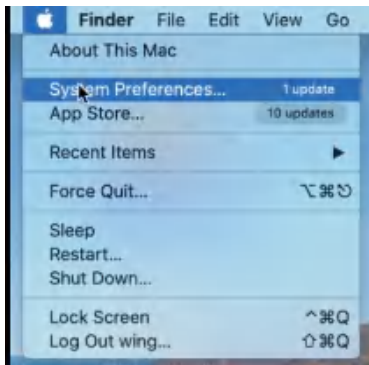

③ Click Security&Privacy



④ Click Open Anyway

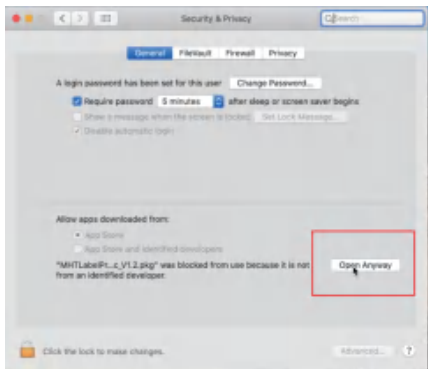

⑤ Click Open

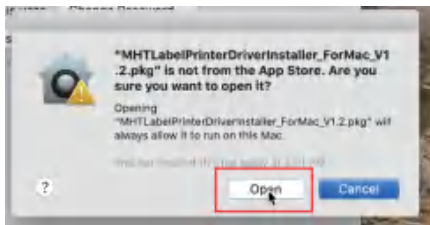

- ③ Back to the installation step, this step will verify the account security, enter the computer password or fingerprint to continue the installation.

① Click Continue

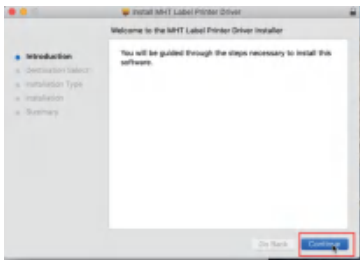

② Enter computer password

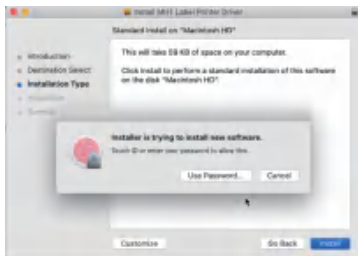

③

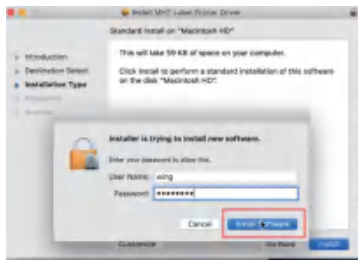

- ④ The driver has been installed successfully, please close the interface.

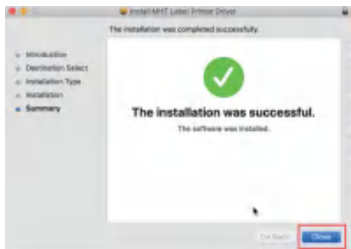

- ④ At this step, the driver has been installed correctly, then we add the printer to the computer. Open "printers & scanners", Add a Milestone MHT-1081 Thermal Label Printer.

- ① Click Printer & Scanners.



- ② Click "+" to add a Printer.



- ③ Select the Printer Model MHT-L1081.

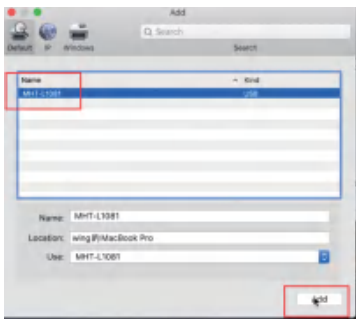

- ④ OK, the printer has been installed successfully.

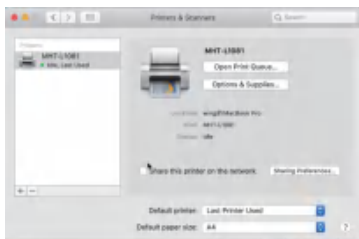

- ⑤ At this step, you have fully installed the printer, then please open the document and try to print a test. Please use 4x6 labels and open the test document "USPS Test1.pdf" attached to the USB flash drive. Please select 4x6" or 100*150mm for the print preview paper size. (Attention, if you encounter unable to print, please turn off the printer power and restart the printer)

Frequently Asked Questions

Q. How to install Windows & Mac Driver?

A. The package contains a USB-disk, which contains instructions and driver files.

Q. Why did I print blank labels or print labels incompletely?

A.

(1) The most common reason is that you inverted the label. Please ensure the printing side is up.

(2) Please check your labels which is thermal material labels.

(3) Change the paper size in the computer printer properties. For example, to print a 4x6 shipping label, please set the paper size to 4x6 inch or 100*150mm in the computer printer-printer preferences.

(4) When printing PDF file, preview it first and adjust the printing scale. If the printing content is in A4 paper size, you could use [Acrobat Reader DC] to edit.

a. open the file from [Acrobat Reader DC] software

b. click 'Edit' and 'Take a Snapshot'

c. select the printing content and print.

Q. How to download [Acrobat Reader DC] software?

A. You could find free software from the link <https://get.adobe.com/reader/>. Please download red logo software.

Q. How to identify the label paper size?

A. Place the thermal label paper correctly, press the Feed button (Green light) with 3 seconds to let the printer auto identify the label paper size.

Q. How to change the label size?

A. There are two ways.

(1) Find [Printer and Scanner] page, choose the label printer, click 'Print Preferences' to change the label size you need.

(2) Print page in [Acrobat Reader DC], click 'Page Setup' in the left of bottom to change the label size.

Q. Why can't print after installing the driver?

A. There are two reasons.

(1) The print port is occupied. Please go to the printer properties of the computer, change a different USB port. Operation: Devices and Printer - Printer properties - Port - Select other USB ports (USB001~USB005).

(2) You haven't installed the driver successfully. Please recheck the file 'how to install' or contact us to get help.

FCC Requirement

changes or modifications not expressly approved by the party responsible for compliance could void the user's authority to operate the equipment. This device complies with Part 15 of the FCC Rules. Operation is subject to the following two conditions:

(1) this device may not cause harmful interference, and

(2) this device must accept any interference received, including interference that may cause undesired operation.

Note: This equipment has been tested and found to comply with the limits for a Class B digital device, pursuant to Part 15 of the FCC Rules. These limits are designed to provide reasonable protection against harmful interference in a residential installation. This equipment generates, uses, and can radiate radio frequency energy, and if not installed and used in accordance with the instructions, may cause harmful interference to radio communications. However, there is no guarantee that interference will not occur in a particular installation. If this equipment does cause harmful interference to radio or television reception, which can be determined by turning the equipment off and on, the user is encouraged to try to correct the interference by one or more of the following measures:

- Reorient or relocate the receiving antenna.
- Increase the separation between the equipment and receiver.
- Connect the equipment into an outlet on a circuit different from that to which the receiver is connected.
- Consult the dealer or an experienced radio/TV technician for help.

Product Specification List

Printing method	Thermal line printer
Paper loading method	Easy paper loading/auto paper feeding
Printing speed	Actual speed detection : 150mm/s
Printing paper width	104mm
Effective resolution	203 dpi (300 dpi optional)
Paper type	Continuous paper, label paper, black label paper
Thickness of printing paper	0.06-0.18mm
Effective printing width	Min 38mm Max 112mm
Character size	ASCII Font A: 12x24 ASCII Font B: 9x17 Chinese character 24x24
Interface type	USB
Power adapter	DC 24V  2.5A
Working environment	Operating temperature: 0 ~ 45°C, Operating humidity: 20 ~ 90%
Storage environment	Storage temperature:-10 ~ 60°C, Storage humidity: 10 ~ 90%

Keys and Indicators

■ Function description of buttons

Scenarios	Button operation	Corresponding functions
Power Off	Press and hold + turn on the printer	Print self-test page
Standby	Press and hold 3s	Enter label specification learning mode
Open the cover	Press and hold 10s	Restore factory settings
Standby	Press	Automatically feed one blank label sheet
Continuous printing process	Press	Pause printing
Pause printing	Press	Continue printing

■ Indicator description

Indicator status	Status description	
Indicator always lights up	Normal standby	
Indicator flashes	Buzzer alarm	
Buzzer alarm (common)	2 Sounds	Printer mechanism error
	3 Sounds	Paper shortage error
	5 Sounds	Overheating error
	6 Sounds	Cover opening error
	7 Sounds	Seam label error

Print Self-Test Page

When the printer is initially installed or there are any problems with the printer, you can run self-test program to confirm the following status: firmware version, printer parameter setting status, print quality, and related setting information of external devices, etc. After confirming that there is no problem with the printer after the self-test, please check other devices or software. This function runs independently of other devices or software.

The self-test method is as follows:

- (1) Confirm that the printer is connected to power supply and the paper roll is loaded correctly.
- (2) Confirm that the printer is turned off and the top cover is closed in place.
- (3) Press and hold the FEED button, then press the POWER button to turn on the printer; release the button after the printer is turned on.

Print with the Window Driver

- (1) To install Windows driver, please refer to "Driver Installation Instruction".
- (2) Set the "port" of the Windows driver as the appropriate interface to use.
Print the test page with the "Print test page" function of Windows driver.





Troubleshooting

The table below shows common problems and solutions for operators.

If you have followed the simple troubleshooting methods but the printer is still not functioning properly, please contact the customer service department of your dealer for assistance.

Fault Phenomenon	Cause	Solution
POWER indicator is off	<ul style="list-style-type: none"> a. The AC plug and the power supply plug are not properly connected to the printer socket. b. The printer power switch is not on. 	<ul style="list-style-type: none"> a. Check the power connection and confirm that the AC plug and the power supply plug are properly connected to the printer socket. b. Turn on the printer.
Unable to print	<ul style="list-style-type: none"> a. The communication cable is not properly connected to the printer and PC host. b. Communication interface setting error. c. Print status error. 	<ul style="list-style-type: none"> a. Reconnect the communication cable.
Incomplete print content	<ul style="list-style-type: none"> a. The paper is not centered. b. Label size setting is incorrect. 	<ul style="list-style-type: none"> a. Adjust the paper position. b. Set the correct label size.
Incorrect positioning	<ul style="list-style-type: none"> a. Label learning is not performed. b. Seam label detection photocoupler is offset. c. Wrong mode selected. 	<ul style="list-style-type: none"> a. Label learning is performed. b. Open the cover to confirm whether the seam label detection component is offset. For black label paper, move the seam label detection component according to the black label position so that the detection photocoupler can detect the black label. Label paper/continuous paper: The detection photocoupler must be in the paper range. c. Use the setting tool to open the printer information and confirm whether the paper type is the same as the paper loaded in the printer, which can be changed by using the setting tool.
Poor print result	<ul style="list-style-type: none"> a. Paper loading error. b. Print density/speed setting error. c. Print head/rubber roller has dust or adhesive accumulation. d. The print head is damaged. 	<ul style="list-style-type: none"> a. Reload the paper. b. Readjust the print density/speed of printer by using the setting tool or the software. Printing density can be coarsely tuned with the setting tool and finely tuned with the driver. c. Clean the print head/rubber roller. (refer to 8.1 "Cleaning Print Head"/8.2 "Cleaning Sensor"/8.3 "Cleaning Printing Rubber Roller" of the Manual.) d. Use the setting tool to detect bad point of head piece. If the print head is damaged, please contact the customer service department of your dealer for repairs.

Safety Warnings

-  **Warning:** Do not touch the paper cutting knife or paper-tearing knife of the printer.
-  **Warning:** The print head is a heating component. Do not touch the print head and its surrounding components when the printer is still warm in temperature.
-  **Warning:** Do not touch the surface of the thermal print head and connectors, to avoid electrostatic damage to the print head.
-  **Warning:** This product is only suitable for the use in non-tropical climates.

Safety Instructions

- ① Please install the printer on a stable surface to avoid printer suffered from any vibration and shocks.
- ② Stop using keeping the product in any case of unusual circumstances such as the presence of high temperature, high humidity and serious pollution.
- ③ Connect the printer's power adapter to an appropriate grounding socket. Avoid using the same socket with large motors or other equipment that may cause voltage fluctuation of power supply.
- ④ Do not get the product wet. Do not insert foreign objects(e.g. metal) into the product, and once it occurs, immediately turn off the power supply.
- ⑤ Never use the printer without paper, otherwise it will seriously damage the printing rubber roller and thermal head.
Unplug the product from the power outlet if the printer is idle for a long time.
- ⑦ Do not disassemble or modify the product personally.
- ⑧ Use only the power adapter specified in this instruction.
- ⑨ Do not plug/unplug the product with the product powered on.
In order to ensure the printing quality and prolong the service life of the product, it is recommended to use the recommended or equivalent thermal printing paper.
- ⑩ When plugging and unplugging the printer power cord, please hold the arrow position of the printer power connector with your hand, not the cord of the printer power cord.
- ⑪ Please keep this manual for the future use and reference.



Dear Milestone customer, Thank you for ordering our product in our store. We hope that the product will meet your expectation and word as we promised. Now, we have Prepared a gift to our new customers. The number of gifts are limited. Please contact us in time.

What kind of Gift? Two types for choose.

Milestone 4x6 inch Thermal labels paper or 2in1 Rolls and stack label holders, which suitable and fits for your Devices. Which one you prefer?



How to get the Gift?

Contact us at Service@gzmht.com and tell us your Order ID and the gift you want. Our customer service will reply you in time and send you gift. About after-sales service of product, do not hesitate to contact us in mail.

Milestone Tel: +1 (205) 325-9790

Milestone Whatsapp: +1 (205) 325-9790

