

Memorex[®]

Is it live or is it Memorex?[™]

MX4107

User's Guide

Home Audio System with
CD Player and AM/FM
Stereo Radio

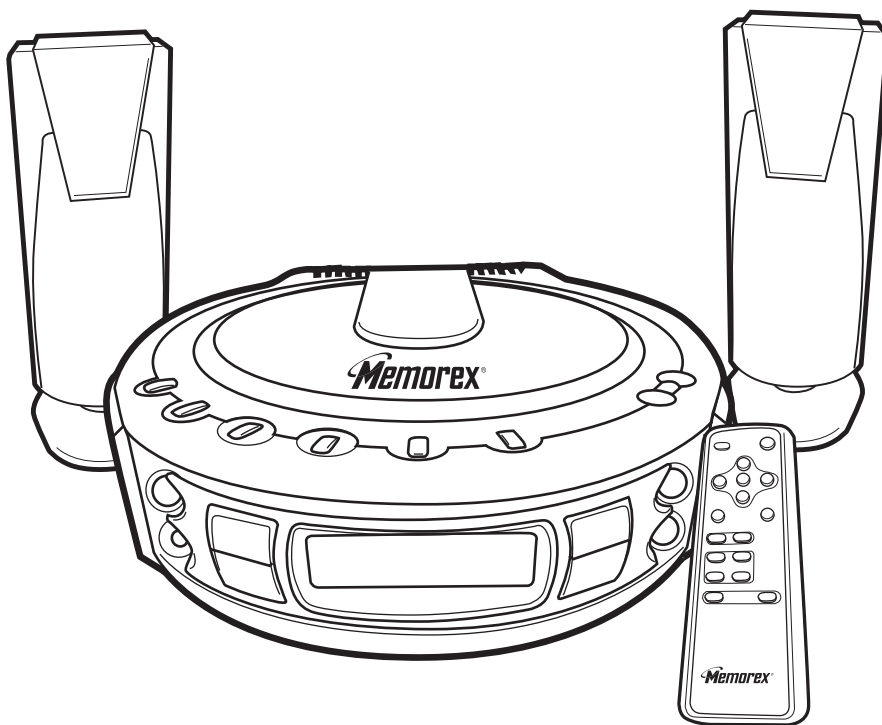

**Before operating this product,
please read these instructions completely.**

Dear Customer,

Please read this manual thoroughly before operating the unit to become more familiar with it and obtain the performance that will bring you continued enjoyment for many years. Keep these instructions handy for future reference.

PLEASE KEEP ALL PACKAGING MATERIAL FOR AT LEAST 90 DAYS IN CASE YOU NEED TO RETURN THIS PRODUCT TO YOUR PLACE OF PURCHASE OR MEMOREX.

For future reference, record the serial number of the unit printed on the rear of the cabinet.

Serial Number _____

	CAUTION RISK OF ELECTRIC SHOCK DO NOT OPEN	
CAUTION: TO REDUCE THE RISK OF ELECTRIC SHOCK, DO NOT REMOVE COVER (OR BACK). NO USER-SERVICEABLE PARTS INSIDE. REFER SERVICING TO QUALIFIED SERVICE PERSONNEL.		



DANGEROUS VOLTAGE

The lightning flash with arrowhead symbol, within an equilateral triangle is intended to alert the user to the presence of uninsulated dangerous voltage within the product's enclosure that may be of sufficient magnitude to constitute a risk of electric shock to persons.



ATTENTION

The exclamation point within an equilateral triangle is intended to alert the user to the presence of important operating and maintenance (servicing) instructions in the literature accompanying the appliance.

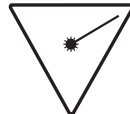

DANGER:

Invisible and hazardous laser radiation when open and interlock failed or defeated. Avoid direct exposure to beam.

FCC WARNING:

This equipment may generate or use radio frequency energy. Changes or modifications to this equipment may cause harmful interference unless the modifications are expressly approved in the instruction manual. The user could lose the authority to operate this equipment if an unauthorized change or modification is made.

LASER SAFETY: This unit employs a laser. Only qualified service personnel should attempt to service this device due to possible eye injury.

CAUTION: USE OF CONTROLS, ADJUSTMENTS OR PERFORMANCE PROCEDURE HEREIN MAY RESULT IN HAZARDOUS RADIATION EXPOSURE.

INFORMATION

This equipment has been tested and found to comply with the limits for a Class B digital device, pursuant to Part 15 of the FCC Rules. These limits are designed to provide reasonable protection against harmful interference in a residential installation. This equipment generates, uses, and can radiate radio frequency energy and, if not installed and used in accordance with the instructions, may cause harmful interference to radio communications. However, there is no guarantee that interference will not occur in a particular installation. If this equipment does cause harmful interference to radio or television reception, which can be determined by turning the equipment off and on, the user is encouraged to try to correct the interference by one or more of the following measures:

- Reorient or relocate the receiving antenna.
- Increase the separation between the equipment and receiver.
- Connect the equipment into an outlet on a circuit different from that to which the receiver is connected.
- Consult the dealer or an experienced radio/TV technician for help.

WARNING: TO PREVENT FIRE OR SHOCK HAZARD, DO NOT EXPOSE THIS UNIT TO RAIN OR MOISTURE.

SURGE PROTECTORS:

It is recommended to use a surge protector for AC connection. Lightning and power surges ARE NOT covered under warranty for this product.

IMPORTANT SERVICE SAFETY INSTRUCTIONS

Before using the unit, be sure to read all operating instructions carefully. Please note that these are general precautions and may not pertain to your unit. For example, this unit may not have the capability to be connected to an outdoor antenna.

1. READ INSTRUCTIONS

All the safety and operating instructions should be read before the product is operated.

2. RETAIN INSTRUCTIONS

The safety and operating instructions should be retained for future reference.

3. HEED WARNINGS

All warnings on the product and in the operating instructions should be adhered to.

4. FOLLOW INSTRUCTIONS

All operating and use instructions should be followed.

5. CLEANING

Unplug this product from the wall outlet before cleaning. Do not use liquid cleaners or aerosol cleaners. Use a dry cloth for cleaning.

6. ATTACHMENTS

Do not use attachments not recommended by the product's manufacturer as they may cause hazards.

7. WATER AND MOISTURE

Do not use this product near water- for example, near a bathtub, washbowl, kitchen sink, or laundry tub, in a wet basement, or near a swimming pool.

8. ACCESSORIES

Do not place this product on an unstable cart, stand, tripod, bracket, or table. The product may fall, causing serious injury and serious damage to the product. Use only with a cart, stand, tripod, bracket, or table recommended by the manufacturer or sold with the product. Any mounting of the product should follow the manufacturer's instructions, and should use a mounting accessory recommended by the manufacturer.

PORTABLE CART WARNING
(symbol provided by RETAC)



8A. An appliance and cart combination should be moved with care. Quick stops, excessive force, and uneven surfaces may cause the appliance and cart combination to overturn.

9. VENTILATION

Slots and openings in the cabinet and in the back or bottom are provided for ventilation and to ensure reliable operation of the product and to protect it from overheating. These openings must not be blocked or covered. The openings should never be blocked by placing the product on a bed, sofa, rug, or other similar surface. This product should never be placed near or over a radiator or heat source. This product should not be placed in a built-in installation such as a bookcase or rack unless proper ventilation is provided or the manufacturer's instructions have been adhered to.

10. POWER SOURCES

This product should be operated only from the type of power source indicated on the marking label. If you are not sure of the type of power supply to your home, consult your appliance dealer or local power company. For products intended to operate from battery power, or other sources, refer to the operating instructions.

11. GROUNDING OR POLARIZATION

This product is equipped with a polarized alternating-current line plug (a plug having one blade wider than the other). This plug will fit into the power outlet only one way. This is a safety feature. If you are unable to insert the plug fully into the outlet, try reversing the plug. If the plug should still fail to fit, contact your electrician to replace your obsolete outlet. Do not defeat the safety purpose of the polarized plug.

12. POWER-CORD PROTECTION

Power-supply cords should be routed so that they are not likely to be walked on or pinched by items placed upon or against them, paying particular attention to cords at plugs, convenience receptacles, and the point where they exit from the appliance.

13. LIGHTNING

To protect your product from a lightning storm, or when it is left unattended and unused for long periods of time, unplug it from the wall outlet and disconnect the antenna or cable system. This will prevent damage to the product due to lightning and power-line surges.

14. POWER LINES

An outside antenna system should not be located in the vicinity of overhead power lines or other electric light or power circuits, or where it can fall into such power lines or circuits. When installing an outside antenna system, extreme care should be taken to keep from touching such power lines or circuits as contact with them might be fatal.

15. OVERLOADING

Do not overload wall outlets and extension cords as this can result in a risk of fire or electric shock.

16. OBJECT AND LIQUID ENTRY

Never push objects of any kind into this product through openings as they may touch dangerous voltage points or short out parts that could result in fire or electric shock. Never spill or spray any type of liquid on the product.

17. OUTDOOR ANTENNA GROUNDING

If an outside antenna is connected to the product, be sure the antenna system is grounded so as to provide some protection against voltage surges and built-up static charges. Section 810 of the National Electric Code, ANSI/NFPA 70, provides information with respect to proper grounding of the mast and supporting structure, grounding of the lead-in wire to an antenna discharge product, size of grounding conductors, location of antenna discharge product, connection to grounding electrodes, and requirements for grounding electrode.

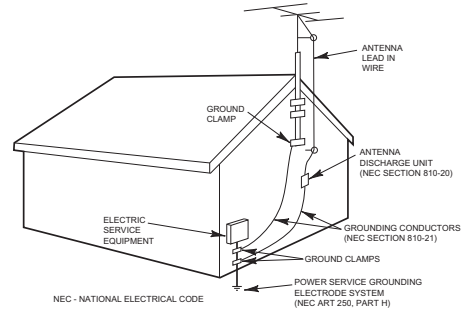

S2898A

EXAMPLE OF ANTENNA GROUNDING AS PER NATIONAL ELECTRICAL CODE

18. SERVICING

Do not attempt to service this product yourself as opening or removing covers may expose you to dangerous voltage or other hazards. Refer all servicing to qualified service personnel.

19. REPLACEMENT PARTS

When replacement parts are required, be sure the service technician uses replacement parts specified by the manufacturer or those that have the same characteristics as the original part. Unauthorized substitutions may result in fire, electric shock or other hazards.

20. SAFETY CHECK

Upon completion of any service or repairs to this product, ask the service technician to perform safety checks to determine that the product is in proper operating condition.

21. WALL OR CEILING MOUNTING

The product should be mounted to a wall or ceiling only as recommended by the manufacturer.

22. DAMAGE REQUIRING SERVICE

Unplug the product from the wall outlet and refer servicing to qualified service personnel under the following conditions:

- When the power-supply cord or plug is damaged.
- If liquid has been spilled, or objects have fallen into the product.
- If the product has been exposed to rain or water.
- If the product does not operate normally by following the operating instructions. Adjust only those controls that are covered by the operating instructions, as an adjustment of other controls may result in damage and will often require extensive work by a qualified technician to restore the product to its normal operation.
- If the product has been dropped or the cabinet has been damaged.
- When the product exhibits a distinct change in performance - this indicates a need for service.

23. HEAT

The product should be situated away from heat sources such as radiators, heat registers, stoves, or other products (including amplifiers) that produce heat.

24. NOTE TO CATV SYSTEM INSTALLER

This reminder is provided to call the CATV system installer's attention to Article 820-40 of the NEC that provides guidelines for proper grounding and, in particular, specifies that the cable ground shall be connected to the grounding system of the building, as close to the point of cable entry as practical.

PREPARATION FOR USE

SPEAKER CONNECTION

1. Place the speakers in convenient locations on either side of the unit. Usually a distance of five to eight feet between speakers provides the best stereo effect, but this may vary depending on the size and acoustics of the room.
2. Locate the Speaker Jacks on the rear of the unit and connect the dashed black wires to the red (+) terminals and connect the solid black wires to the black (-) terminals.
3. To connect the speakers, press the terminal down, insert the speaker wire and press the terminal back to the lock position.
4. Pull lightly on the connection to make sure it is secure.

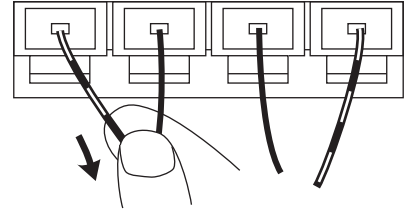

CAUTION: Only connect the speakers which are supplied with the unit. The use of any other or additional speakers may cause damage to the unit. Never operate the unit without the speakers connected.

BATTERY OPERATION

The battery compartment is located on the rear of the remote control.

- Remove the battery compartment door by pressing down and sliding the door in the direction of the arrow.
- Insert two (2) AA size batteries into the battery compartment as shown to the right. Be sure to observe the polarity markings which are engraved inside the battery compartment. If the batteries are inserted incorrectly, the remote control will not operate.
- Replace the battery compartment door.

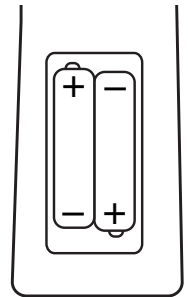

BATTERY PRECAUTIONS

Follow these precautions when using batteries in this device:

1. Use only the size and type of batteries specified (alkaline are recommended).
2. Be sure to follow the correct polarity when installing the batteries as indicated in the battery compartment. Reversed batteries may cause damage to the device.
3. Do not mix different types of batteries together (e.g. Alkaline, Carbon-zinc or rechargeable) or old batteries with fresh ones.
4. If the device is not to be used for a long period of time, remove the batteries to prevent damage or injury from possible battery leakage.
5. Do not try to recharge batteries not intended to be recharged; they can overheat and rupture. (Follow battery manufacturer's directions.)

AC CONNECTION

Unwind the AC cord and extend it to its full length. Insert the end of the AC cord into any convenient 120V 60Hz household outlet.

Please note that this unit is equipped with a polarized AC plug which has one blade wider than the other. This is a safety feature to reduce the likelihood of electric shock. This polarized AC plug will only fit in a polarized AC outlet. If you find that you cannot insert this plug into your outlet, you may have an obsolete non-polarized outlet. Please do not try to defeat this safety feature by using a non-polarized adapter or by filing the wider blade to make it fit into your outlet. If this plug does not fit into your outlet, you should contact a qualified licensed electrician to replace your obsolete outlet.

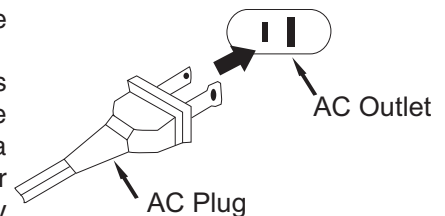

REMOTE SENSOR

To operate the unit with the remote control, point the remote at the remote sensor on the front of the main unit and press the appropriate button. The remote control has an effective operating range of approximately 15 feet and an angle of no more than 30°.

NOTE: Bright sunlight may interfere with the operation of the remote control.

LOCATION OF CONTROLS

FRONT

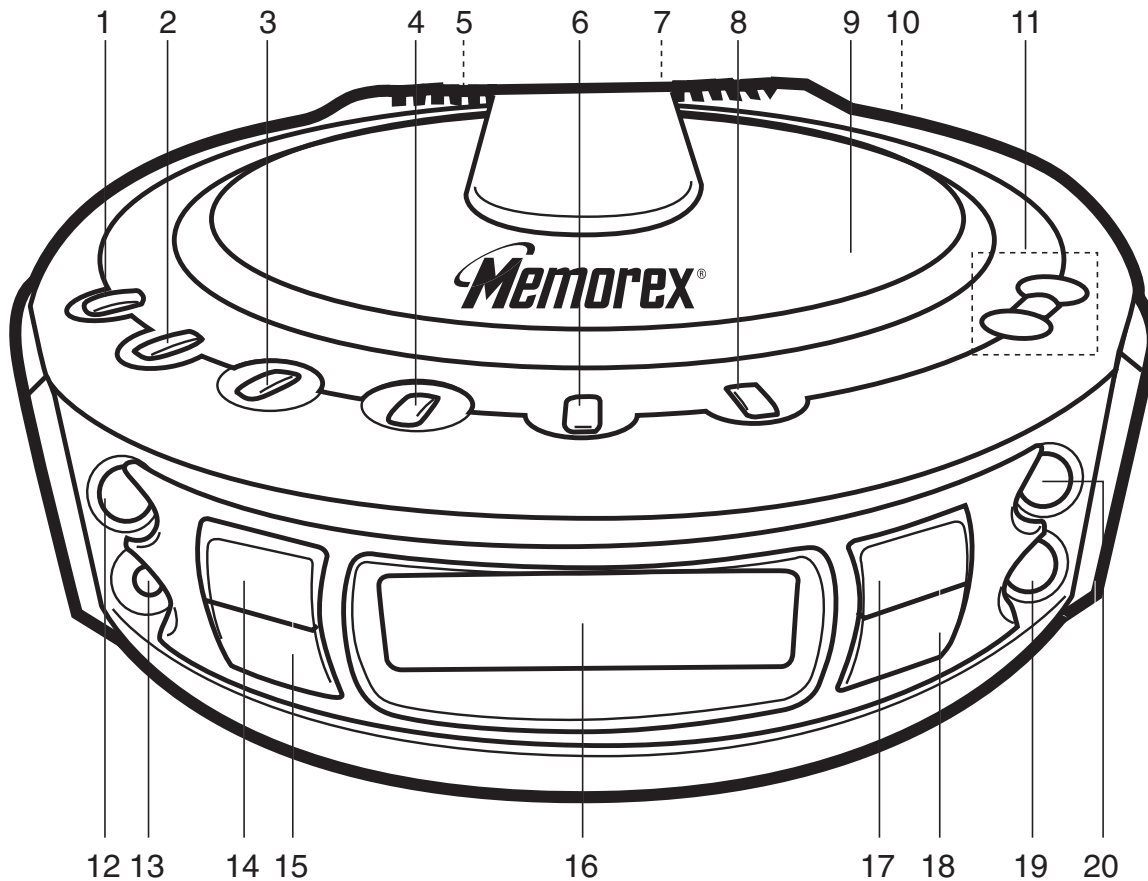

- | | |
|------------------------------------|--------------------------------|
| 1. PRESET EQ Button | 11. VOLUME Buttons |
| 2. SLEEP Button | 12. POWER Button |
| 3. MEM/CLOCK SET Button | 13. Headphones Jack |
| 4. REPEAT/MEM-UP Button | 14. Tune/Skip/Search ►► Button |
| 5. AC Cord (Rear of Unit) | 15. Tune/Skip/Search ◄◄ Button |
| 6. TUNER Function Button | 16. Display |
| 7. Speaker Jacks (Rear of Unit) | 17. PLAY/PAUSE (►) Button |
| 8. CD Function Button | 18. STOP/BAND (■) Button |
| 9. CD Compartment | 19. Remote Sensor |
| 10. FM Wire Antenna (Rear of Unit) | 20. OPEN/Close Button |

LOCATION OF CONTROLS (CONTINUED)

REMOTE

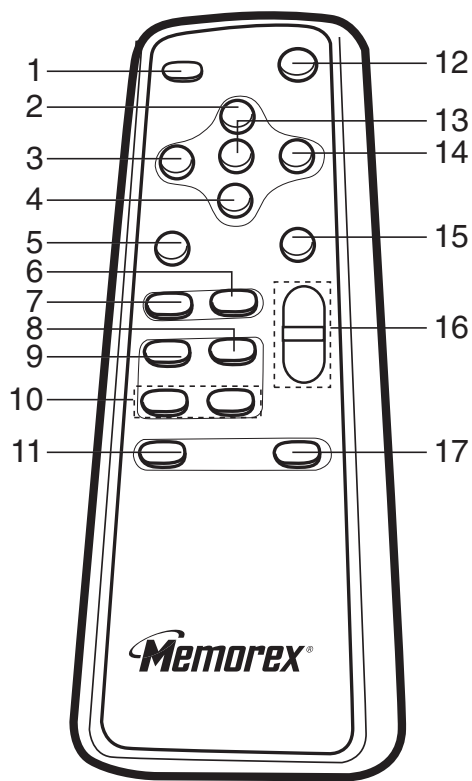

1. OPEN/CLOSE Button
2. REPEAT/MEM-UP Button
3. SLEEP Button
4. MEMORY/CLOCK SET Button
5. BAND Button
6. CD Function Button
7. TUNER Function Button
8. PLAY/PAUSE (▶||) Button
9. STOP (■) Button
10. Tune/Skip/Search ▶▶/◀◀ Buttons
11. DISPLAY Button
12. POWER Button
13. RANDOM Button
14. TIMER Button
15. Mute Button
16. VOLUME Buttons
17. PRESET EQ Button

OPERATING INSTRUCTIONS

SETTING THE CLOCK

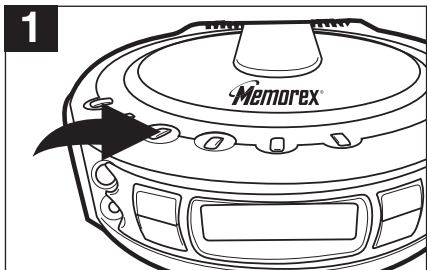

With the power off, press the MEM/CLOCK SET button; the time will blink in the display.

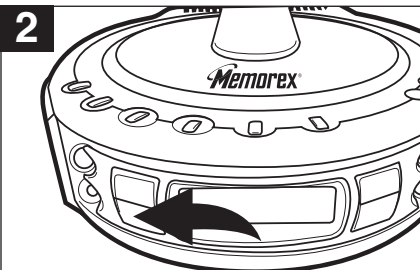

Press the Tune/Skip/Search button to set the current hour.

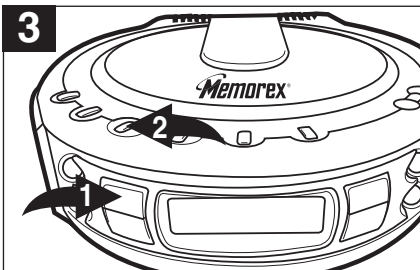

Press the Tune/Skip/Search button to set the current minute, then press the MEM/CLOCK SET button again and the time will be set.

PRESET EQ

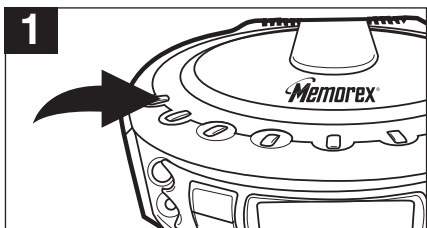

With the power on, press the PRESET EQ button to cycle through the preset EQ settings or to turn the EQ off. Each press of the PRESET EQ button will cycle as follows: CLASSIC, ROCK, POP, JAZZ, Off.

MUTE

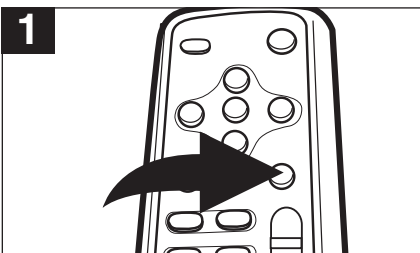

To temporarily mute the sound, press the Mute button on the remote control; "MUTE" will appear in the display and the sound will be muted. Press the MUTE button again to restore the sound and "MUTE" will disappear from the display.

HEADPHONE JACK

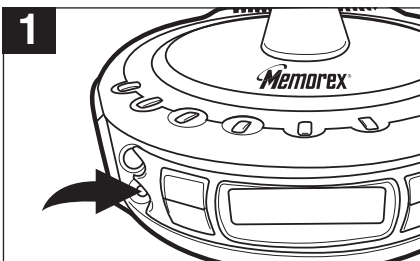

To listen to the unit through headphones, simply insert the headphones (not included) into the Headphones jack. The speakers will be disconnected when the Headphones are plugged in.

DISPLAY BUTTON

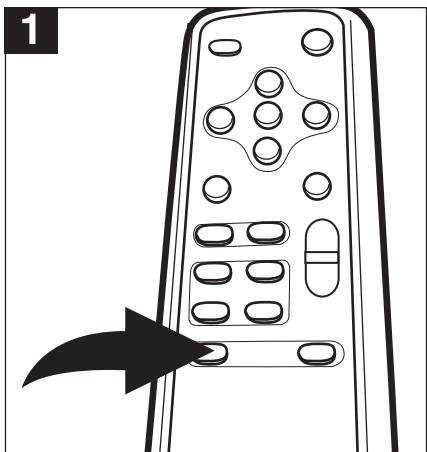

WHILE IN THE RADIO OR CD STOP MODE:

Press the DISPLAY button on the remote once to show the clock on the display. Press a second time to show the timer on time. Press a third time to show the timer off time. Press again or wait five seconds and the display will show the radio frequency or total tracks/time of the CD.

WHILE PLAYING A CD:

Press the DISPLAY button on the remote once to show the remaining time of the CD on the display. Press a second time to show the clock. Press a third time to show the timer on time. Press a fourth time to show the timer off time. Press again or wait five seconds and the display will show the elapsed time of the CD.

OPERATING INSTRUCTIONS (CONTINUED)

LISTENING TO THE RADIO

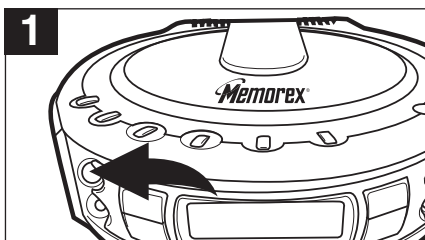

1 Press the POWER button to turn the unit on.

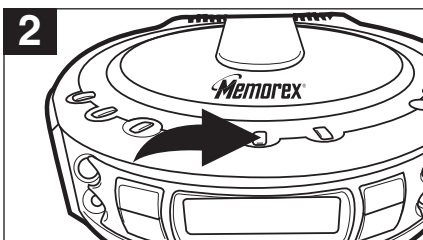

2 Press the TUNER Function button to select the radio.

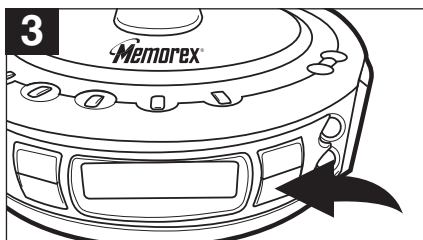

3 Press the STOP/BAND (■) button on the main unit to select AM or FM.

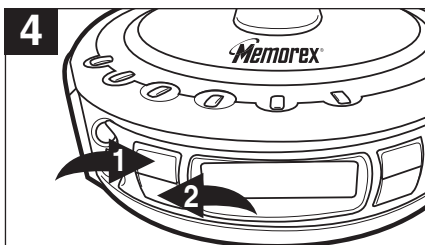

4 **MANUAL TUNING:** Repeatedly press the Tune/Skip/Search ►► ① or ◀◀ ② button to manually advance the frequency in the display up or down until the desired frequency appears.

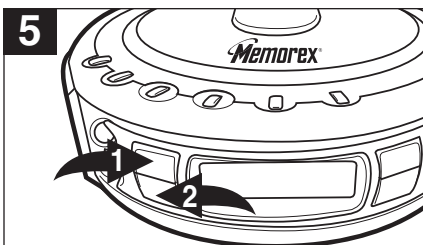

5 **AUTOMATIC TUNING:** Press and hold the Tune/Skip/Search ►► ① or ◀◀ ② button until the frequency in the display starts to scan, and then release the button; the tuner will search and then stop on the next strong station it finds. Repeat this step until the desired frequency appears in the display.

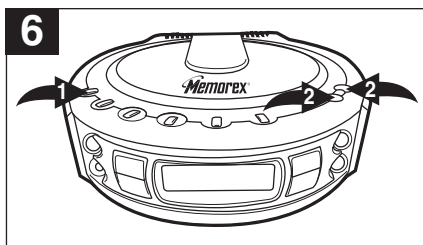

6 Adjust the PRESET EQ button ① and VOLUME buttons ② as desired.

NOTE: If the FM STEREO band is selected and you have tuned to an FM Stereo station, STEREO will light in the display.

Hints for Better Reception

AM - The AM ferrite bar antenna is located inside the unit. It may be necessary to turn the unit slightly so that the internal antenna is pointing in the direction of the AM transmitter. You may have to experiment to find the position that provides the strongest reception for each of your favorite AM stations.

FM - Extend the FM wire antenna for best FM reception.

OPERATING INSTRUCTIONS (CONTINUED)

SETTING RADIO PRESETS

This unit can preset 20 AM and 20 FM radio stations for convenient recall.

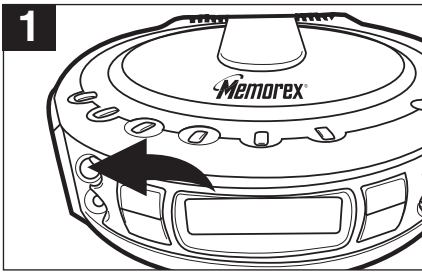

1 Press the POWER button to turn the unit on.

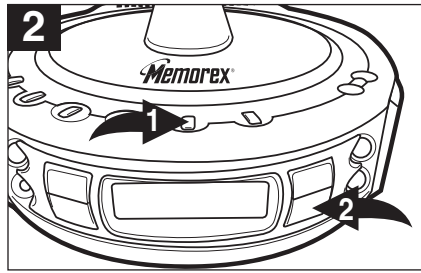

2 Press the TUNER Function button ① to select the radio. Press the STOP/BAND (■) button ② on the main unit to select AM or FM.

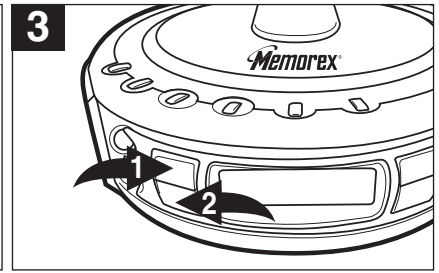

3 Press the Tune/Skip/Search ►► ① or ◀◀ ② button to select a station.

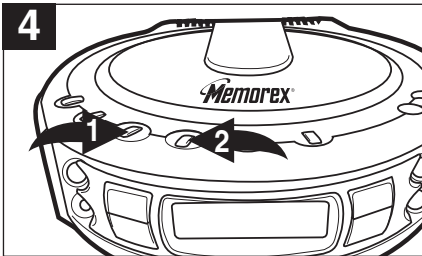

4 Press the MEM/CLOCK SET button ①; the preset number will blink in the display. Press the REPEAT/MEM-UP button ② until the desired memory number appears on the display.

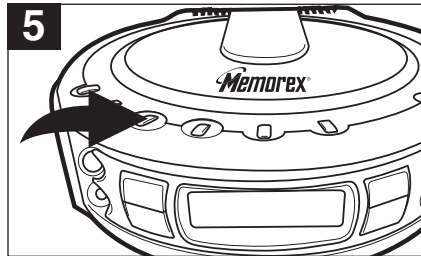

5 Press the MEM/CLOCK SET button again to set the station in the selected memory.

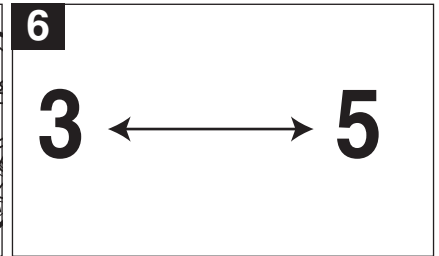

6 Repeat steps 3 through 5 to program up to 20 stations in each band, if desired.

In case the main power supply is interrupted, the memory presets will be erased.

RECALLING RADIO PRESETS (20 EACH BAND)



1 Follow steps 1 and 2 above.

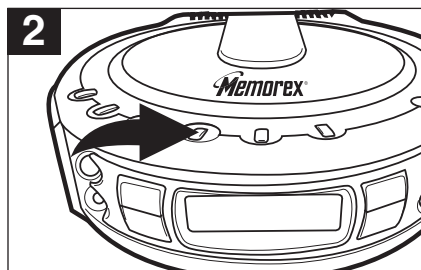

2 Press the REPEAT/MEM-UP button to select a preset; the station will automatically be tuned in.

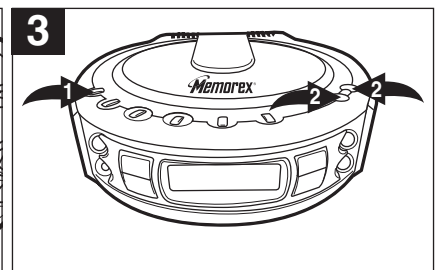

3 Adjust the PRESET EQ button ① and VOLUME buttons ② as desired.

OPERATING INSTRUCTIONS (CONTINUED)

PLAYING COMPACT DISCS NORMAL PLAYBACK

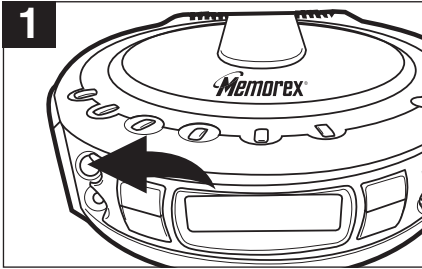

1 Press the POWER button to turn the unit on.

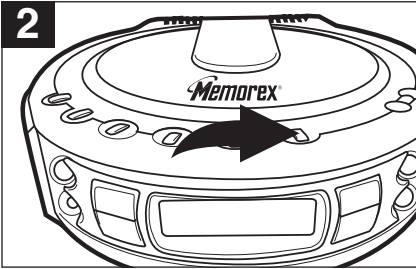

2 Press the CD Function button; "CD" appears in the display.

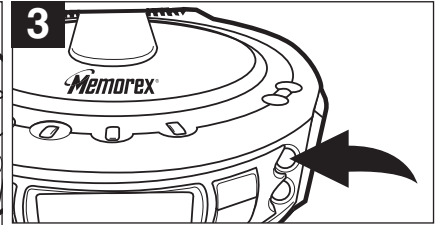

3 Press the OPEN/Close button and gently press a CD onto the center spindle with the label side facing up. Press the OPEN/Close button again to close the CD compartment. The CD will automatically start playing.

NOTE: 3 inch single or standard CDs can be used with this unit.

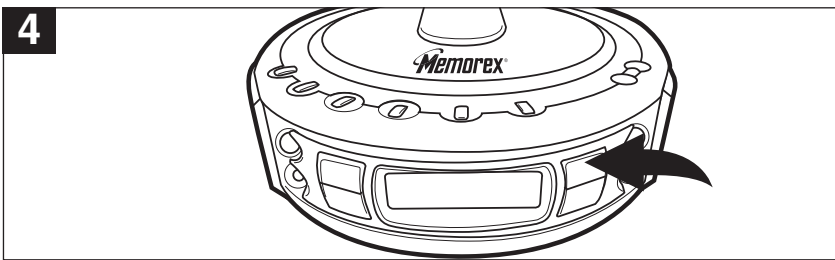

4 If in the Stop mode, press the PLAY/PAUSE (▶||) button to begin playback on Track 1.

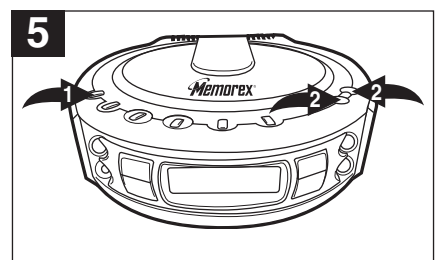

5 Press the PRESET EQ button ① and the VOLUME buttons ② as desired. Playback will continue until all the tracks on the disc have been played

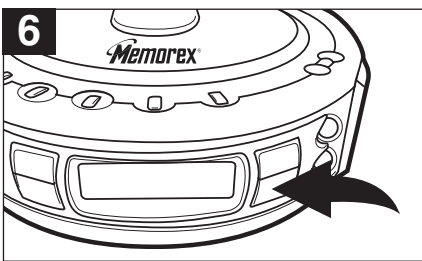

6 To stop playback before the disc ends, press the STOP/BAND (■) button. The disc will stop and the display will show the total number of tracks and playing time on the disc.

CD PAUSE CONTROL

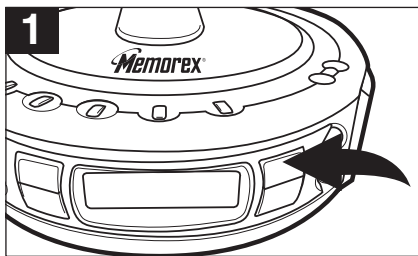

1 During CD playback, if you wish to pause the disc momentarily, press the PLAY/PAUSE (▶||) button. Playback stops but the disc continues to spin and the time display will blink.

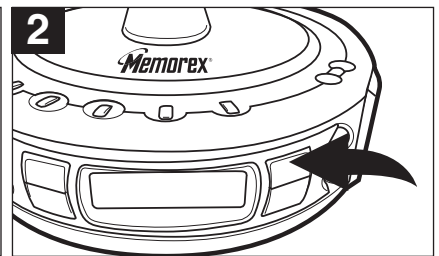

2 Press the PLAY/PAUSE (▶||) button again to release pause and resume normal CD playback.

OPERATING INSTRUCTIONS (CONTINUED)

TO BEGIN PLAYBACK FROM A SPECIFIC TRACK

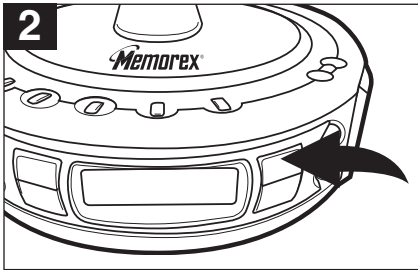
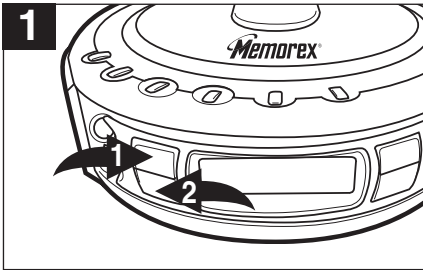

After you insert a disc into the CD player, press either the Tune/Skip/Search $\blacktriangleright\blacktriangleright$ ① or $\blacktriangleleft\blacktriangleleft$ ② button to select a specific track for playback.

If in the Stop mode, press the PLAY/PAUSE ($\blacktriangleright\parallel$) button. Playback will begin on the track you selected.

FORWARD/REVERSE SKIP TRACK AND HIGH-SPEED MUSIC SEARCH ($\blacktriangleright\blacktriangleright\blacktriangleright$ / $\blacktriangleleft\blacktriangleleft\blacktriangleleft$)

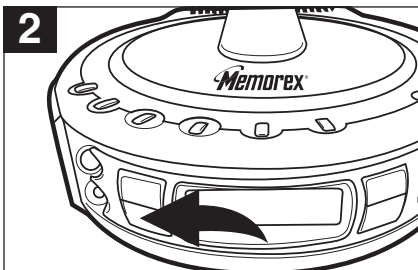
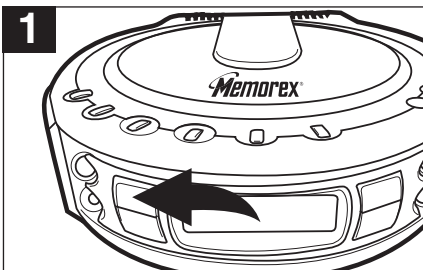

3 During playback, depress and hold either the Tune/Skip/Search $\blacktriangleright\blacktriangleright$ or $\blacktriangleleft\blacktriangleleft$ button to move the player forward or backward within a track to locate a specific musical passage. The player will move forward or backward at high speed as long as the button is depressed. When you release the Tune/Skip/Search $\blacktriangleright\blacktriangleright$ or $\blacktriangleleft\blacktriangleleft$ button, normal playback will resume.

During playback, press the Tune/Skip/Search $\blacktriangleright\blacktriangleright$ button once to advance the player to the beginning of the next track. Press the Tune/Skip/Search $\blacktriangleright\blacktriangleright$ button repeatedly to advance the player to higher numbered tracks.

During playback, press the Tune/Skip/Search $\blacktriangleleft\blacktriangleleft$ button once to move the player back to the beginning of the current track. Press the Tune/Skip/Search $\blacktriangleleft\blacktriangleleft$ button repeatedly to move the player back to lower numbered tracks.

RANDOM PLAYBACK

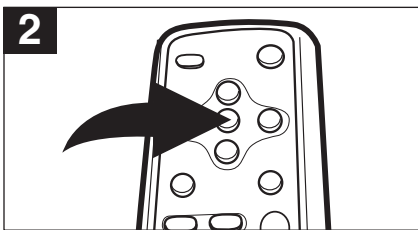
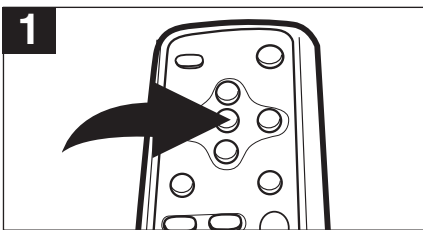

To play the tracks on the CD in a random order, while in the Stop mode, press the RANDOM button on the remote. "RANDOM" will appear in the display and the tracks will play in a random order.

To cancel random playback, press the RANDOM button until "RANDOM" disappears from the display.

OPERATING INSTRUCTIONS (CONTINUED)

REPEAT PLAYBACK

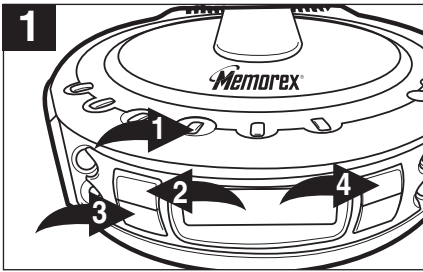

1 To repeat a single track, press the REPEAT/MEM-UP button ❶ once; “REP” will blink in the display. Press the Tune/Skip/Search ❷ or ❸ button to select the specific track that you wish to repeat. When the desired track number appears in the display, press the PLAY/PAUSE (▶||) button ❹ to begin playback. The specific track you selected will be repeated continuously.

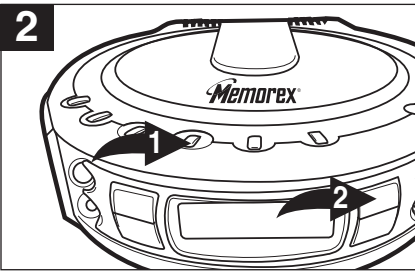

2 To repeat all of the tracks on a disc continuously, press the REPEAT/MEM-UP button ❶ twice; “REP” will light solid in the display. Press the PLAY/PAUSE (▶||) button ❷ to begin all tracks repeating.

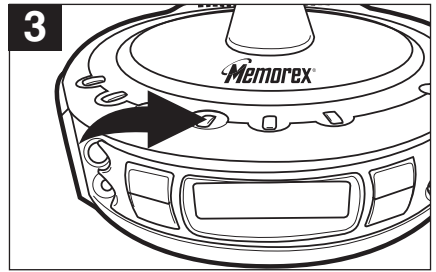

3 To cancel Repeat Playback, press the REPEAT/MEM-UP button until “REPEAT” disappears from the display.

PROGRAMMED PLAYBACK

The CD player in this unit has a 32 track programmable memory that allows you to program up to 32 tracks on any disc for playback in any desired order. You may program 32 different tracks or you may also program certain tracks to play more than once.

To perform programmed playback, proceed as follows:

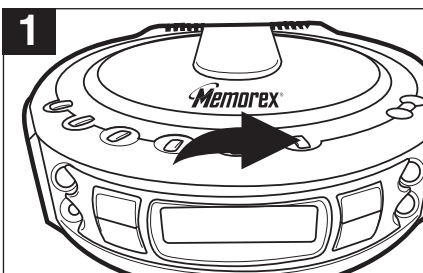

1 Press the CD Function button.

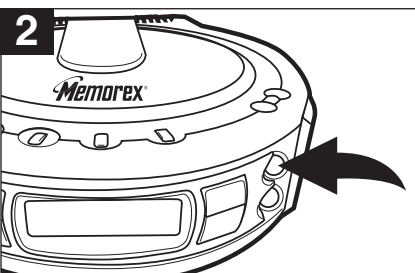

2 Press the OPEN/Close button and gently press a CD onto the center spindle with the label side facing up. Then, press the OPEN/Close button again to close the CD compartment.

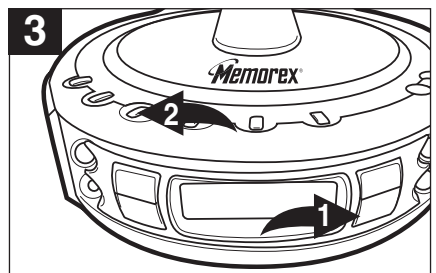

3 Press the STOP/BAND (■) button ❶ to stop automatic playback. Press the MEM/CLOCK SET button ❷; “P-01” (program number) and “MEMORY” will appear and “00” (track number) will blink in the display.

PROGRAMMED PLAYBACK SECTION CONTINUED ON NEXT PAGE.

OPERATING INSTRUCTIONS (CONTINUED)

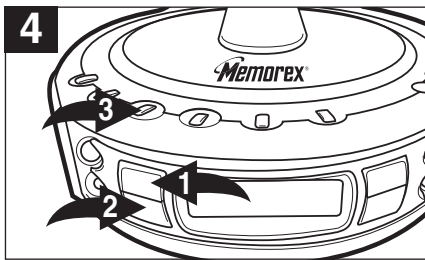

4 Press the Tune/Skip/Search **▶▶** **1** or **◀◀** **2** button to select the first track that you wish to program. When the desired track number appears in the display, press the MEM/CLOCK SET button **Ⓢ** again.

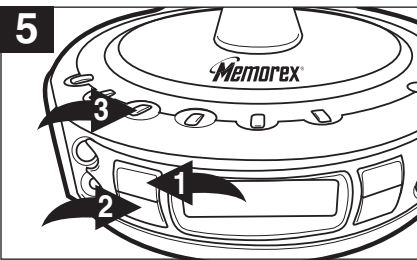

5 Press either the Tune/Skip/Search **▶▶** **1** or **◀◀** **2** button to select the next track you wish to program. When the desired track number appears in the display, press the MEM/CLOCK SET button **Ⓢ** again.

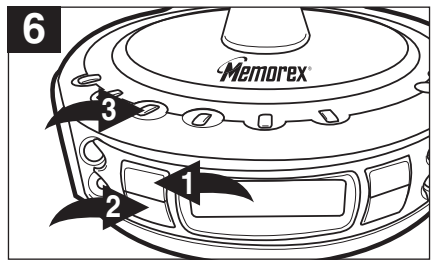

6 Repeat step 5 until you have programmed up to 32 track numbers into the CD Program Memory. When the memory is full, "FULL" will appear in the display for one second.

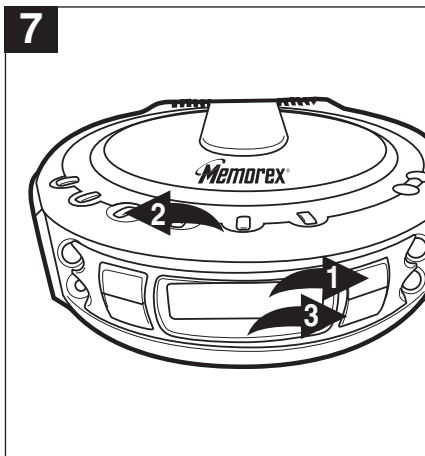

7 After programming up to 32 tracks in the CD Program Memory, press the PLAY/PAUSE (**▶||**) button **1** to begin programmed playback. "MEMORY" will appear in the display and playback will begin on the first track that you programmed. The player will continue to play all of the tracks that you programmed in the order in which you programmed them. When the last programmed track has been played, the player will stop and the display will again show the total number of tracks/playing time on the disc. If you press the MEM/CLOCK SET button **2** and then press the PLAY/PAUSE (**▶||**) button **1** again, playback will start on the first track you programmed and will continue until all the programmed tracks have been played. To cancel the Programmed Playback mode, while in the Stop mode, press the MEM/CLOCK SET button **2** to enter the program mode, and then press the STOP/BAND (**■**) button **3**.

NOTE: To check the programmed tracks, while in the Stop mode, press the MEM/CLOCK SET button repeatedly to view the programmed tracks.

PROGRAMMED REPEAT

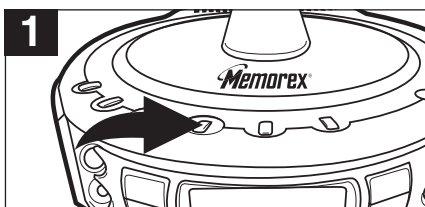

1 It is also possible to use the Program and Repeat functions together to repeat a specific program indefinitely. First, press the REPEAT/MEM-UP button twice to enter the Repeat-All mode and then program the tracks you wish to hear in the order you wish to hear them, as described above. Both the MEMORY and REPEAT indicators will appear in the display.

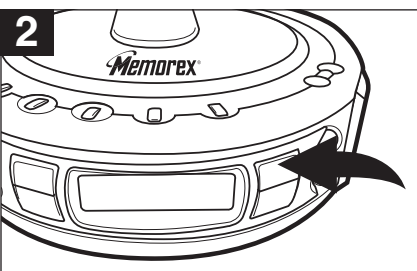

2 Press the PLAY/PAUSE (**▶||**) button to begin programmed repeat playback. The player will play the tracks you selected in the order in which you programmed them. When the last track in the program has been played, the entire program will begin again.

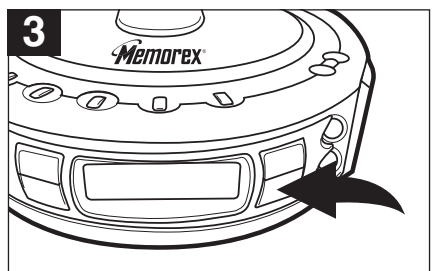

3 Programmed Repeat operation will continue indefinitely until you press the STOP/BAND (**■**) button.

OPERATING INSTRUCTIONS (CONTINUED)

SETTING THE TIMER

Set the timer to turn the unit on and off to the Tuner or CD mode at a preset time as follows :

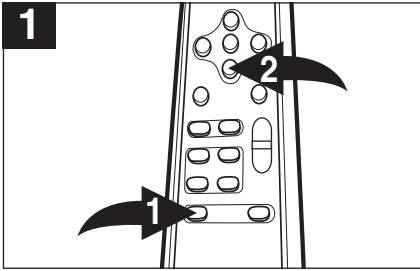

With the power off, press the DISPLAY button ❶ on the remote, and then press the MEM/CLOCK SET button ❷ to enter the Timer ON setting mode; "TIMER ON" will appear and the time will blink on the display.

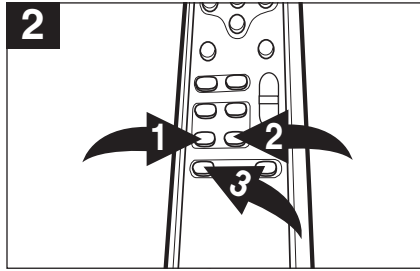

Press the Tune/Skip/Search ⏪ button ❶ to set the timer on hour and the Tune/Skip/Search ⏩ button ❷ to set the timer off minute. Press the DISPLAY button ❸ again; "TIMER OFF" will appear and the time will blink on the display.

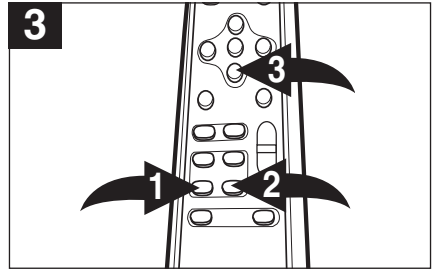

Press the Tune/Skip/Search ⏪ button ❶ to set the timer off hour and the Tune/Skip/Search ⏩ button ❷ to set the timer off minute. When the timer times have been set, press the MEM/CLOCK SET button ❸ to confirm. After five seconds, the display will show the clock again.

TO ACTIVATE THE TIMER ON/OFF MODE, press the TIMER button on the remote once, "TIMER" will appear in the display.

To cancel, press the TIMER button on the remote until "TIMER" disappears from the display.

ACTIVATING THE SLEEP FUNCTION

Set the sleep timer as follows:

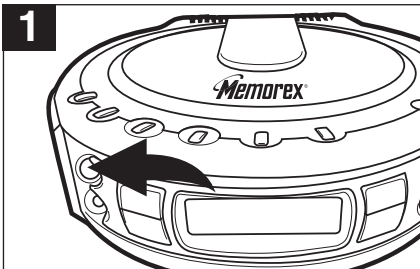

Press the POWER button to turn the unit on and tune the desired radio station or insert a CD as previously instructed.

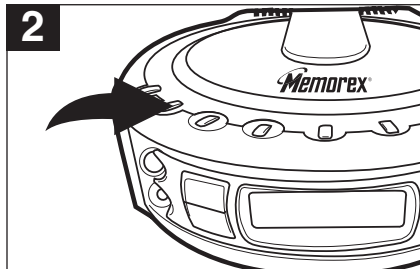

Press the SLEEP button and "90" and "SLEEP" will appear in the display.

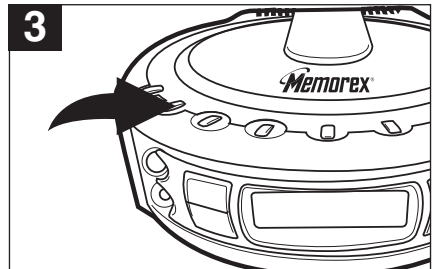

Press the SLEEP button a second time to set the unit to turn off after 80 minutes. Each additional press with decrease the sleep time by 10 minutes. Press the SLEEP button repeatedly until "SLEEP" disappears from the display to deactivate the Sleep feature.

CARE AND MAINTENANCE

Caring for Compact Discs

- Treat the compact disc carefully. Handle the compact disc only by its edges. Never allow your fingers to come in contact with the shiny, unprinted side of the compact disc.
- Do not attach adhesive tape, stickers, etc. to the compact disc label.
- Clean the compact disc periodically with a soft, lint-free, dry cloth. Never use detergents or abrasive cleaners to clean the compact disc. If necessary, use a CD cleaning kit.
- If a compact disc skips or gets stuck on a section of the compact disc, it is probably dirty or damaged (scratched).
- When cleaning the compact disc, wipe in straight lines from the center of the compact disc to the outer edge of the compact disc. Never wipe in circular motions.

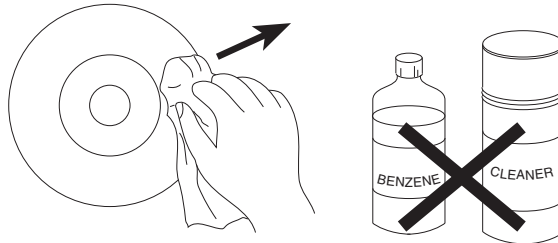
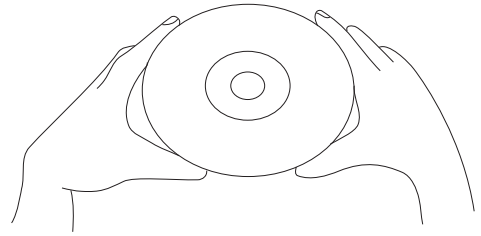

- This unit is designed to play only compact discs bearing the identification logo as shown here. Other compact discs may not conform to the CD standard and may not play properly.
- Compact discs should be stored in their cases after each use to avoid damage.
- Do not expose compact discs to direct sunlight, high humidity, high temperatures or dust, etc. Prolonged exposure or extreme temperatures can warp the compact disc.
- Do not stick or write anything on either side of the compact disc. Sharp writing instruments, or the ink may damage the surface.



TROUBLESHOOTING GUIDE

Should this unit exhibit a problem, check the following before seeking service:

Symptom	Possible Cause	Solution
Radio		
Noise or sound distorted on radio broadcasts.	Station not tuned properly for AM or FM.	Retune the AM or FM broadcast station.
	AM: Unit is not positioned correctly.	Rotate unit for best reception.
	FM: Wire antenna is not extended.	Extend FM wire antenna.
FM ST indicator does not light.	Poor FM signal being received.	Retune station or try another station that broadcasts in stereo.
	Station is not broadcasting in stereo.	Change stations.
AM or FM, no sound.	TUNER is not selected.	Press the TUNER Function button to select Tuner.
	Volume at minimum.	Increase volume.
Compact Disc Player		
CD Player will not play.	CD is not selected.	Press the CD Function button to select CD.
	CD is not installed or is installed incorrectly.	Insert CD with label facing up.
CD skips while playing.	Disc is dirty or scratched.	Wipe disc with cloth or use another disc.
General		
No power.	AC power cord is not connected.	Connect AC power cord.
Remote not working.	Batteries not inserted, or inserted incorrectly.	Insert batteries correctly.

**FOR ADDITIONAL SET-UP OR OPERATING ASSISTANCE, PLEASE VISIT OUR WEBSITE AT
WWW.MEMOREXELECTRONICS.COM
OR CONTACT CUSTOMER SERVICE AT 1-800-919-3647.**

PLEASE KEEP ALL PACKAGING MATERIAL FOR AT LEAST 90 DAYS IN CASE YOU NEED TO RETURN THIS PRODUCT TO YOUR PLACE OF PURCHASE OR MEMOREX.

FOR PARTS AND ACCESSORIES, CONTACT FOX INTERNATIONAL AT 1-800-321-6993.

Memcorp, Inc.
Weston, FL
Printed in Hong Kong

Visit our website at www.memorexelectronics.com