



Operator's Manual
CLS-Class



Mercedes-Benz



Order No. 6515 1422 13 Part No. 219 584 92 81 USA Edition B 2007

CLS-Class

CLS 550

CLS 63 AMG

Our company and staff congratulate you on the purchase of your new Mercedes-Benz.

Your selection of our product is a demonstration of your trust in our company name. Furthermore, it exemplifies your desire to own an automobile that will be as easy as possible to operate and provide years of service.

Your Mercedes-Benz represents the efforts of many skilled engineers and craftsmen. To help assure your driving pleasure, and also the safety of you and your passengers, we ask you to make a small investment of time:

- Please read this manual carefully, then return it to your vehicle where it will be handy for your reference.
- Please follow the recommendations contained in this manual. They are designed to acquaint you with the operation of your Mercedes-Benz.
- Please pay attention to the warnings and cautions contained in this manual. They are designed to help improve the safety of the vehicle operator and occupants.

We extend our best wishes for many miles of safe, pleasurable driving.

Mercedes-Benz USA, LLC
A DaimlerChrysler Company

Introduction	9	At a glance	21	Getting started	35
Product information	9	Exterior view	22	Unlocking	36
Operator's Manual	10	Cockpit	24	Unlocking with the SmartKey	36
Service and warranty information ..	10	Instrument cluster	26	Unlocking with KEYLESS-GO*	37
Important notice for California		Multifunction steering wheel	28	Starter switch positions	38
retail buyers and lessees of		Center console	29	Adjusting	41
Mercedes-Benz automobiles	11	Upper part	29	Seats	41
Maintenance	12	Lower part	30	Steering wheel	44
Roadside Assistance	12	Overhead control panel	31	Mirrors	46
Change of address or ownership....	12	Storage compartments	32	Driving	48
Operating your vehicle outside		Door control panel	34	Fastening the seat belts	48
the USA or Canada	13			Starting the engine	51
Where to find it	14			Parking brake	53
Symbols	15			Driving off	53
Operating safety	16			Switching on headlamps	55
Proper use of the vehicle	16			Turn signals	55
Problems with your vehicle	17			Windshield wipers	56
Reporting safety defects	18			Problems while driving	58
Reporting safety defects	18			Parking and locking	59
Vehicle data recording	19			Parking brake	59
Information regarding electronic				Switching off headlamps	60
recording devices	19			Turning off engine	60
				Releasing seat belts	61
				Locking	61

Contents

Safety and Security	63	Anti-theft systems	99	Seats	120
Occupant safety	64	Immobilizer	99	Front seat active head restraints .	120
Air bags	66	Anti-theft alarm system.....	99	Rear seat head restraints.....	120
Occupant Classification System				Lumbar support	121
(USA only)	71	Controls in detail	101	Multicontour seat*	122
BabySmart™ air bag deactivation		Locking and unlocking.....	102	Seat heating*	123
system (Canada only).....	76	SmartKey	102	Seat ventilation*	124
Seat belts	78	SmartKey with KEYLESS-GO*	105	Memory function	125
Preventive occupant safety		Checking batteries in the		Storing positions into memory.....	126
(PRE-SAFE®)	82	SmartKey or SmartKey with		Recalling positions from memory.	126
Active head restraints	83	KEYLESS-GO*	110	Storing exterior rear view mirror	
Children in the vehicle.....	84	Loss of the SmartKey or		parking position	127
Blocking of		SmartKey with KEYLESS-GO*	110	Lighting	128
rear door window operation	89	Opening the doors		Exterior lamp switch	128
Panic alarm	90	from the inside	111	Combination switch	132
Activating	90	Opening the trunk	112	Corner-illuminating	
Deactivating	90	Closing the trunk.....	113	front fog lamps* (CLS 550 with	
Driving safety systems.....	91	Trunk emergency release	116	Bi-Xenon* headlamps only).....	132
ABS	91	Valet locking	117	Hazard warning flasher	134
BAS	92	Automatic central locking	118	Interior lighting in the front	135
Adaptive Brake	93	Locking and unlocking		Interior lighting in the rear	136
EBP	93	from the inside	118	Door entry lamps	137
ESP®	94			Trunk lamp	137

Instrument cluster	138	Automatic transmission.....	171	4-zone automatic climate control.....	190
Adjusting instrument cluster illumination	138	Gear selector lever.....	171	Deactivating the climate control system.....	195
Coolant temperature indicator.....	139	Shifting procedure	172	Operating the climate control system in automatic mode	196
Resetting trip odometer	139	Gear selector lever positions	173	Setting the temperature	197
Tachometer.....	139	Driving tips.....	175	Adjusting air distribution	197
Outside temperature indicator.....	140	Gear ranges	176	Adjusting air volume	198
Control system	141	Automatic shift program	177	Front defroster	199
Multifunction display.....	141	Gear selector lever one-touch gearshifting.....	178	Maximum cooling MAX COOL (USA only).....	200
Multifunction steering wheel.....	142	Steering wheel gearshift control one-touch gearshifting*	179	Air recirculation mode	200
Menus	144	Manual shift program		Air conditioning	203
Standard display menu	147	CLS 63 AMG	181	Residual heat and ventilation (Canada only).....	203
AMG menu	147	Emergency operation		Rear climate control	204
AUDIO menu	150	(Limp-Home Mode)	184	Front center console storage compartment ventilation..	206
NAV* menu.....	152	Good visibility.....	185	Power windows	207
Distronic* menu.....	153	Headlamp cleaning system*	185	Opening and closing the windows	207
Vehicle status message memory menu.....	153	Rear view mirrors.....	185	Synchronizing power windows.....	209
Settings menu.....	154	Sun visors	187	Summer opening feature	210
Trip computer menu.....	167	Rear window sunshade*	188	Convenience closing feature.....	210
TEL* menu	168	Rear window defroster.....	189		

Contents

Power tilt/sliding sunroof	212	Useful features	244	Operation	269
Opening and closing		Storage compartments	244	The first 1000 miles (1 500 km)	270
the power tilt/sliding sunroof	212	Cup holders	247	Driving instructions	271
Synchronizing		Ashtrays	249	Drive sensibly – save fuel	271
the power tilt/sliding sunroof	214	Cigarette lighter	250	Drinking and driving	271
Driving systems	215	Power outlets	251	Pedals	271
Cruise control	215	Heated steering wheel		Power assistance	272
DISTRONIC*	218	(Canada only)	252	Brakes	272
Airmatic DC (Dual Control)	231	Floor mats	253	Driving off	274
Parktronic system		Telephone*	254	Parking	275
(Parking assist)*	235	Tele Aid	257	Tires	275
Loading	239	Garage door opener	263	Hydroplaning	276
Roof rack*	239			Tire traction	276
Loading instructions	239			Tire speed rating	277
Ski bag* (Canada only)	240			Winter driving instructions	278
Cargo tie-down rings	243			Standing water	279
Retaining hooks	243			Passenger compartment	280
				Driving abroad	280
				Control and operation of	
				radio transmitter	280
				Catalytic converter	281
				Emission control	281
				Coolant temperature	282

At the gas station	283	DOT, Tire Identification Number (TIN)	318	Practical hints	341
Refueling	283	Maximum tire load	319	What to do if	342
Check regularly and before a long trip	285	Maximum tire inflation pressure ...	320	Lamps in instrument cluster	342
Engine compartment	286	Uniform Tire Quality Grading Standards (U.S. vehicles).	320	Lamp in center console	353
Hood	286	Tire ply material	322	Vehicle status messages in the multifunction display	356
Engine oil	287	Tire and loading terminology	323	Where will I find...?	391
Transmission fluid level	289	Rotating tires	326	First aid kit	391
Coolant level	290	Winter driving	327	Spare wheel	391
Battery	291	Winter tires	327	Vehicle tool kit	393
Windshield washer system and headlamp cleaning system*	292	Block heater* (Canada only)	328	Luggage box	395
Tires and wheels	293	Snow chains	328	Unlocking/locking in an emergency ..	396
Important guidelines	293	Maintenance	329	Unlocking the vehicle	396
Tire care and maintenance	294	Maintenance service indicator message	329	Locking the vehicle	397
Direction of rotation	295	Calling up the maintenance service indicator	331	Fuel filler flap emergency release .	398
Loading the vehicle	296	Resetting the maintenance service indicator	331	Manually unlocking the gear selector lever	398
Recommended tire inflation pressure	301	Vehicle care	332	Opening/closing in an emergency	400
Checking tire inflation pressure ...	302	Cleaning and care of vehicle	332	Power tilt/sliding sunroof	400
MOExtended system*	313			Resetting activated head restraints....	401
Tire labeling	313			Replacing SmartKey batteries	402
Load identification	317			SmartKey/SmartKey with KEYLESS-GO*	402

▼ Product information

Please observe the following in your own best interest:

We recommend using Genuine Mercedes-Benz Parts as well as conversion parts and accessories explicitly approved by us for your vehicle model.

We have tested these parts to determine their reliability, safety and special suitability for Mercedes-Benz vehicles.

We are unable to make an assessment for other products and therefore cannot be held responsible for them, even if in individual cases an official approval or authorization by governmental or other agencies should exist. Use of such parts and accessories could adversely affect the safety, performance or reliability of your vehicle. Please do not use them.

Genuine Mercedes-Benz Parts as well as conversion parts and accessories approved by us are available at your authorized Mercedes-Benz Center where you will receive comprehensive information, also on permissible technical modifications, and where proper installation will be performed.

This Operator's Manual contains a great deal of useful information. We urge you to read it carefully and familiarize yourself with the vehicle before driving.

For your own safety and longer service life of the vehicle, we urge you to follow the instructions and warnings contained in this manual. Ignoring them could result in damage to the vehicle or personal injury to you or others. Vehicle damage caused by failure to follow instructions is not covered by the Mercedes-Benz Limited Warranty.

Your vehicle may have some or all of the equipment described in this manual. Therefore, you may find explanations for optional equipment not installed in your vehicle. If you have any questions about the operation of any equipment, your authorized Mercedes-Benz Center will be glad to demonstrate the proper procedures.

We continuously strive to improve our product, and ask for your understanding that we reserve the right to make changes in design and equipment. Therefore, information, illustrations and descriptions in this Operator's Manual might differ from your vehicle.

Optional equipment is also described in this manual, including operating instructions wherever necessary. Since they are special-order items, the descriptions and illustrations herein may vary slightly from the actual equipment of your vehicle.

If there are any equipment details that are not shown or described in this Operator's Manual, your authorized Mercedes-Benz Center will be glad to inform you of correct care and operating procedures. The Operator's Manual and Maintenance Booklet are important documents and should be kept with the vehicle.

Service and warranty information

The Service and Warranty Information Booklet contains detailed information about the warranties covering your Mercedes-Benz, including:

- New Car Limited Warranty
- Emission System Warranty
- Emission Performance Warranty
- California, Maine, Massachusetts, and Vermont Emission Control System Warranty (California, Maine, Massachusetts, and Vermont only)
- State Warranty Enforcement Laws (Lemon Laws)

Important notice for California retail buyers and lessees of Mercedes-Benz automobiles

Under California law you may be entitled to a replacement of your vehicle or a refund of the purchase price or lease price, if Mercedes-Benz USA, LLC and/or its authorized repair or service facilities fail to fix one or more substantial defects or malfunctions in the vehicle that are covered by its express warranty after a reasonable number of repair attempts. During the period of 18 months from original delivery of the vehicle or the accumulation of 18000 miles (approximately 29000 km) on the odometer of the vehicle, whichever occurs first, a reasonable number of repair attempts is presumed for a retail buyer or lessee if one or more of the following occurs:

- (1) the same substantial defect or malfunction results in a condition that is likely to cause death or serious bodily injury if the vehicle is driven, that defect or malfunction has been subject to repair two or more times, and you have directly notified Mercedes-Benz USA, LLC in writing of the need for its repair,
- (2) the same substantial defect or malfunction of a less serious nature than category (1) has been subject to repair four or more times and you have directly notified us in writing of the need for its repair, or
- (3) the vehicle is out of service by reason of repair of the same or different substantial defects or malfunctions for a cumulative total of more than 30 calendar days.

Written notification should not be sent to a dealer, it should be addressed to Mercedes-Benz USA, LLC Customer Assistance Center One Mercedes Drive Montvale, NJ07645-0350

Maintenance

The Maintenance Booklet describes all the necessary maintenance work which should be performed at regular intervals.

Always have the Maintenance Booklet with you when you take the vehicle to your authorized Mercedes-Benz Center for service. The service advisor will record each service in the booklet for you.

Roadside Assistance

The Mercedes-Benz Roadside Assistance Program provides factory trained technical help in the event of a breakdown. Calls to the toll-free Roadside Assistance number

1-800-FOR-MERCEdes (in the USA)
1-800-387-0100 (in Canada)

will be answered by Mercedes-Benz Customer Assistance Representatives 24 hours a day, 365 days a year.

For additional information refer to the Mercedes-Benz Roadside Assistance Program brochure in your vehicle literature portfolio.

Change of address or ownership

If you change your address, be sure to send in the "Change of Address Notice" found in the Service and Warranty Information Booklet, or simply call the Mercedes-Benz Customer Assistance Center (in the USA) at 1-800-FOR-MERCEdes, or Customer Service (in Canada) at 1-800-387-0100. It is in your own interest that we can contact you should the need arise.

If you sell your Mercedes, please leave all literature with the vehicle to make it available to the next operator.

If you bought this vehicle used, be sure to send in the "Notice of Purchase of Used Car" found in the Service and Warranty Information Booklet, or call the Mercedes-Benz Customer Assistance Center (in the USA) at 1-800-FOR-MERCEdes, or Customer Service (in Canada) at 1-800-387-0100.

Operating your vehicle outside the USA or Canada

If you plan to operate your vehicle in foreign countries, please be aware that:

- service facilities or replacement parts may not be readily available,
- unleaded gasoline for vehicles with catalytic converters may not be available; the use of leaded fuels will damage the catalyts,
- gasoline may have a considerably lower octane rating, and improper fuel can cause engine damage.

Certain Mercedes-Benz models are available for delivery in Europe under our European Delivery Program. For details, consult your authorized Mercedes-Benz Center or write to:

In the USA:

Mercedes-Benz USA, LLC
European Delivery Department
One Mercedes Drive
Montvale, NJ 07645-0350

In Canada:

Mercedes-Benz Canada, Inc.
European Delivery Department
98 Vanderhoof Avenue
Toronto, Ontario M4G 4C9

Where to find it

This Operator's Manual is designed to provide comprehensive support information for you, the vehicle operator. Each section has its own reference color.

At a glance

Here you will find an overview of all the controls that can be operated from the driver's seat.

Getting started

Here you will find all the information you need for your first drive. You should read this section first if this is your first Mercedes-Benz vehicle or if you are renting or borrowing this vehicle.

Safety and Security

Here you will find descriptions of the safety and security features of your vehicle.

Controls in detail

Here you will find detailed information about the equipment installed in your vehicle. This section expands on the "Getting started" section and also describes technical innovations. If you are already familiar with the basic functions of your vehicle, this section will be of particular interest to you.

Operation

Here you will find all the information you need for the proper operation of your vehicle.

Practical hints

This section provides fast assistance for dealing with problems you may encounter.

Technical data

All important technical data for your vehicle can be found in this section.

Indexes

The table of contents and the index are designed to help you find information quickly and easily.

The following publications are part of your vehicle documentation:

- this Operator's Manual
- the Maintenance Booklet

Separate operating instructions will be provided as required depending on the equipment options installed in your vehicle.

▼ Symbols

Trademarks:

- ESP® and PRE-SAFE® are registered trademarks of DaimlerChrysler.
- HomeLink® is a registered trademark of Prince, a Johnson Controls Company.
- BabySmart™ is a registered trademark of Siemens Automotive Group.

The following symbols are found in this Operator's Manual:

- * Optional equipment is identified with an asterisk. Since standard equipment varies between models, the descriptions and illustrations in this manual may differ slightly from the actual equipment of your vehicle.

Warning!



Warning notices draw your attention to hazards that may endanger your health or life, or the health or life of others.

 *Highlights hazards that may result in damage to your vehicle.*

 *Helpful hints or further information you may find useful.*

- ▶ This symbol points to instructions for you to follow.
- ▶ A number of these symbols appearing in succession indicates a multiple-step procedure.
- ▷ page This symbol tells you where to look for further information on a topic.
- ▷▷ This continuation symbol marks a warning which is continued on the next page.
- ▷▷ This continuation symbol marks a procedure which is continued on the next page.
- > This symbol is used to indicate cross-references to term definitions.
- Display Words appearing in the multi-function display are printed in the type shown here.

Warning!



Work improperly carried out on electronic components and associated software could cause them to cease functioning. Because the vehicle's electronic components are interconnected, any modifications made may produce an undesired effect on other systems. Electronic malfunctions could seriously impair the operating safety of your vehicle.

See your authorized Mercedes-Benz Center for repairs or modifications to electronic components.

Other improper work or modifications on the vehicle could also have a negative impact on the operating safety of the vehicle.

Some safety systems only function while the engine is running. You should therefore never turn off the engine while driving.

Warning!



Heavy blows against the vehicle underbody or tires/wheels, for example when running over an obstacle, road debris or a pothole, may cause serious damage to and impair the operating safety of your vehicle. If you feel a sudden strong vibration or ride disturbance, or you suspect that damage to your vehicle has occurred, you should turn on your hazard warning flashers, carefully slow down, and drive with caution to an area which is a safe distance from the road.

Inspect the vehicle underbody and tires/wheels for possible damage. If the vehicle appears unsafe, have it towed to the nearest authorized Mercedes-Benz Center or other qualified maintenance or repair facility for further inspection or repairs.

Proper use of the vehicle

Proper use of the vehicle requires that you are familiar with the following information and rules:

- the safety precautions in this manual
- the “Technical data” section in this manual
- traffic rules and regulations
- motor vehicle laws and safety standards

Warning!



Various warning labels are attached to your vehicle. These warning labels are intended to make you and others aware of various risks. You should not remove any of these warning labels unless explicitly instructed to do so by information on the label itself. Removal of any of these labels may cause you and others to be unaware of certain risks which may result in an accident and/or personal injury.

▼ Problems with your vehicle

If you should experience a problem with your vehicle, particularly one that you believe may affect its safe operation, we urge you to immediately contact an authorized Mercedes-Benz Center to have the problem diagnosed and corrected if required. If the matter is not handled to your satisfaction, please discuss the problem with the Mercedes-Benz Center management, or if necessary contact us at one of the following addresses:

In the USA:

Customer Assistance Center
Mercedes-Benz USA, LLC
One Mercedes Drive
Montvale, NJ 07645-0350

In Canada:

Customer Relations Department
Mercedes-Benz Canada, Inc.
98 Vanderhoof Avenue
Toronto, Ontario M4G 4C9

Reporting safety defects

For the USA only:

The following text is published as required of manufacturers under Title 49, Code of U.S. Federal Regulations, Part 575 pursuant to the “National Traffic and Motor Vehicle Safety Act of 1966”.

Reporting safety defects

If you believe that your vehicle has a defect which could cause a crash or could cause injury or death, you should immediately inform the National Highway Traffic Safety Administration (NHTSA) in addition to notifying Mercedes-Benz USA, LLC.

If NHTSA receives similar complaints, it may open an investigation, and if it finds that a safety defect exists in a group of vehicles, it may order a recall and remedy campaign. However, NHTSA cannot become involved in individual problems between you, your dealer, or Mercedes-Benz USA, LLC.

To contact NHTSA, you may either call the Auto Safety Hotline toll-free at 1-888-327-4236 (TTY: 1-800-424-9153); go to <http://www.safercar.gov>; or write to: Administrator, NHTSA, 400 Seventh Street, SW., Washington, D.C. 20590. You can also obtain other information about motor vehicle safety from <http://www.safercar.gov>.

▼ Vehicle data recording

Information regarding electronic recording devices

(Including notice pursuant to California Code § 9951)

Please note that your vehicle is equipped with devices that can record vehicle systems data and, if equipped with the Tele Aid system, may transmit some data in certain accidents.

This information helps, for example, to diagnose vehicle systems after a collision and to continuously improve vehicle safety. DaimlerChrysler may access the information and share it with others

- for safety research or vehicle diagnosis purposes
- with the consent of the vehicle owner or lessee
- in response to an official request by law enforcement or other government agency
- for use in dispute resolution involving DaimlerChrysler, its affiliates or sales/service organization and/or
- as otherwise required or permitted by law.

Please check the Tele Aid subscription service agreement for details regarding the information that may be recorded or transmitted via that system.

Exterior view

Cockpit

Instrument cluster

Multifunction steering wheel

Center console

Overhead control panel

Storage compartments

Door control panel



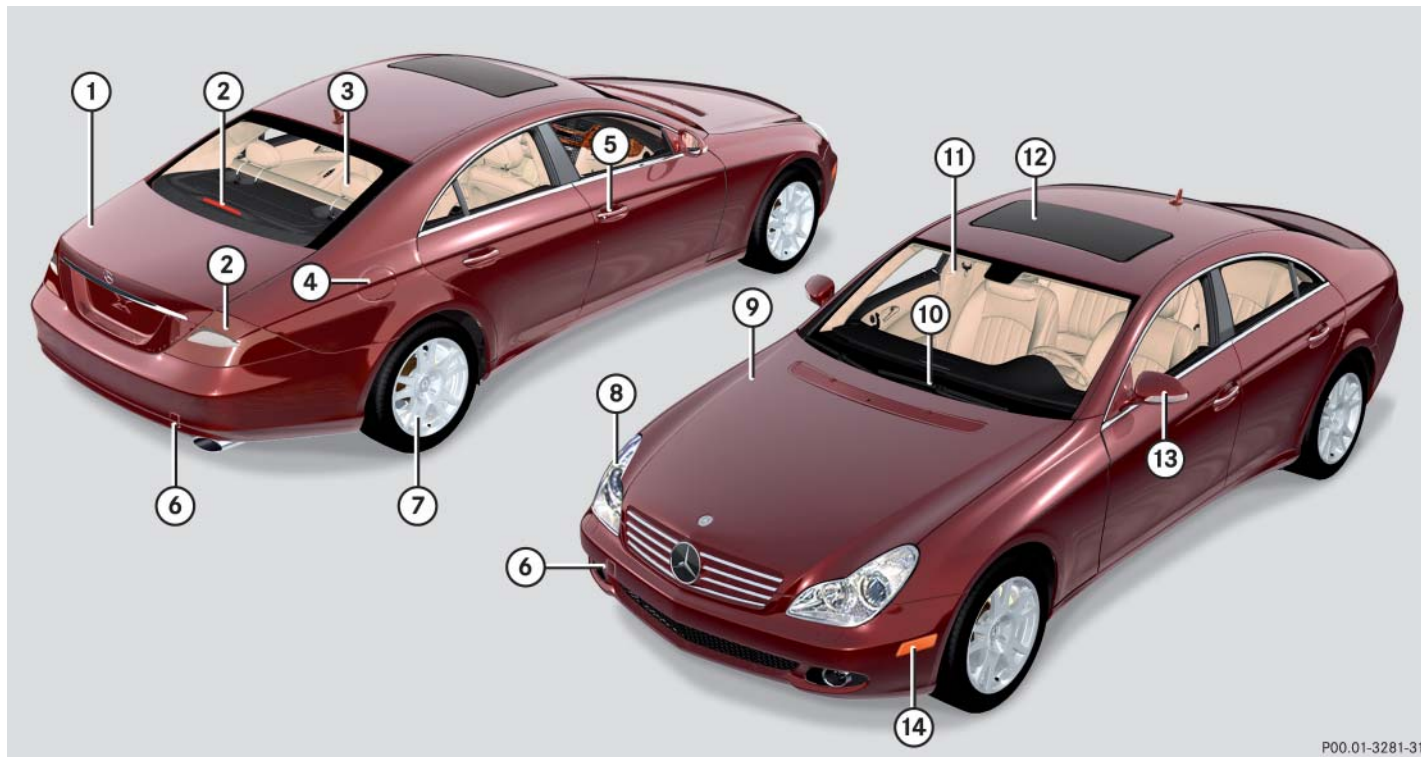

P00.01-3281-31

Item	Page
① Trunk	
• Unlocking	102
• Opening and closing	112
• Spare wheel	391
• Vehicle tool kit	393
② Rear lamps	404
③ Rear window, defrosting	193
④ Fuel filler flap	283
• Fuel requirements	452
⑤ Doors	
• Locking and unlocking	102
• Opening and closing	111

Item	Page
⑥ Towing eye bolt	393
• Installing towing eye bolt	425
⑦ Rims and tires	
• Checking tire inflation pressure	302
• Flat tire	412
⑧ Front lamps	404
⑨ Hood, opening	286
• Engine oil	287
• Coolant	290
⑩ Windshield wipers	56
• Wiper blades, replacing	410
• Wiper blades, cleaning	337

Item	Page
⑪ Window, cleaning	337
⑫ Power tilt/sliding sunroof	212
⑬ Exterior rear view mirrors	
• Adjusting	47
• Auto-dimming	185
• Parking position	187
⑭ Side marker lamps	404

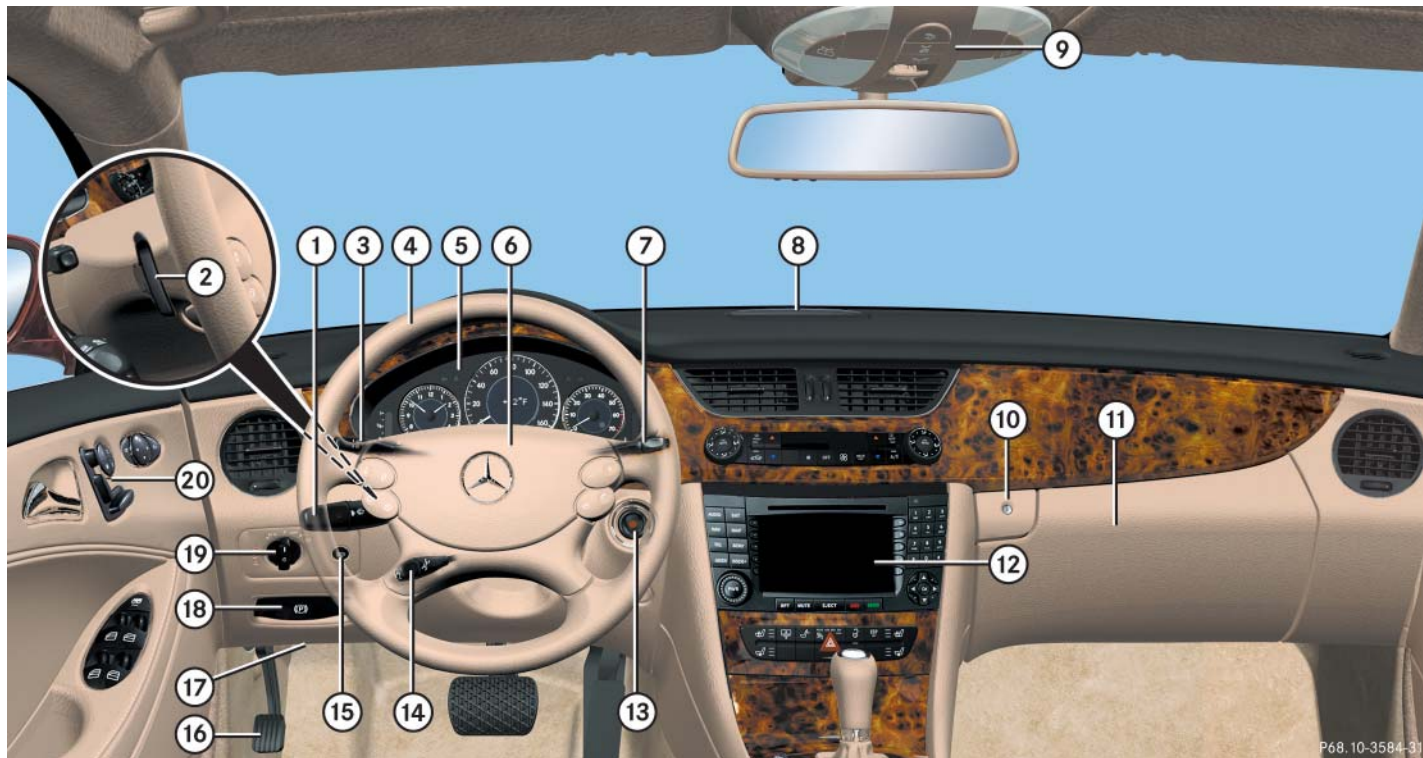

P68. 10-3584-31

Item	Page
① Combination switch	
• Turn signals	55
• Windshield wipers	56
• High beam	55
② Steering wheel gearshift control*	179
③ Cruise control lever	
• Cruise control	215
• Distronic*	218
④ Multifunction steering wheel	28, 142
⑤ Instrument cluster	26, 138
⑥ Horn	





Item	Page
⑦ Lever for Voice Control System*, see separate operating instructions	
⑧ Front Parktronic* warning indicator	235
⑨ Overhead control panel	31
⑩ Glove box lid release, glove box lock	244
⑪ Glove box	244
⑫ Center console	29
⑬ Starter switch	38
⑭ Steering wheel adjustment stalk	44
Heated steering wheel (Canada only)	252

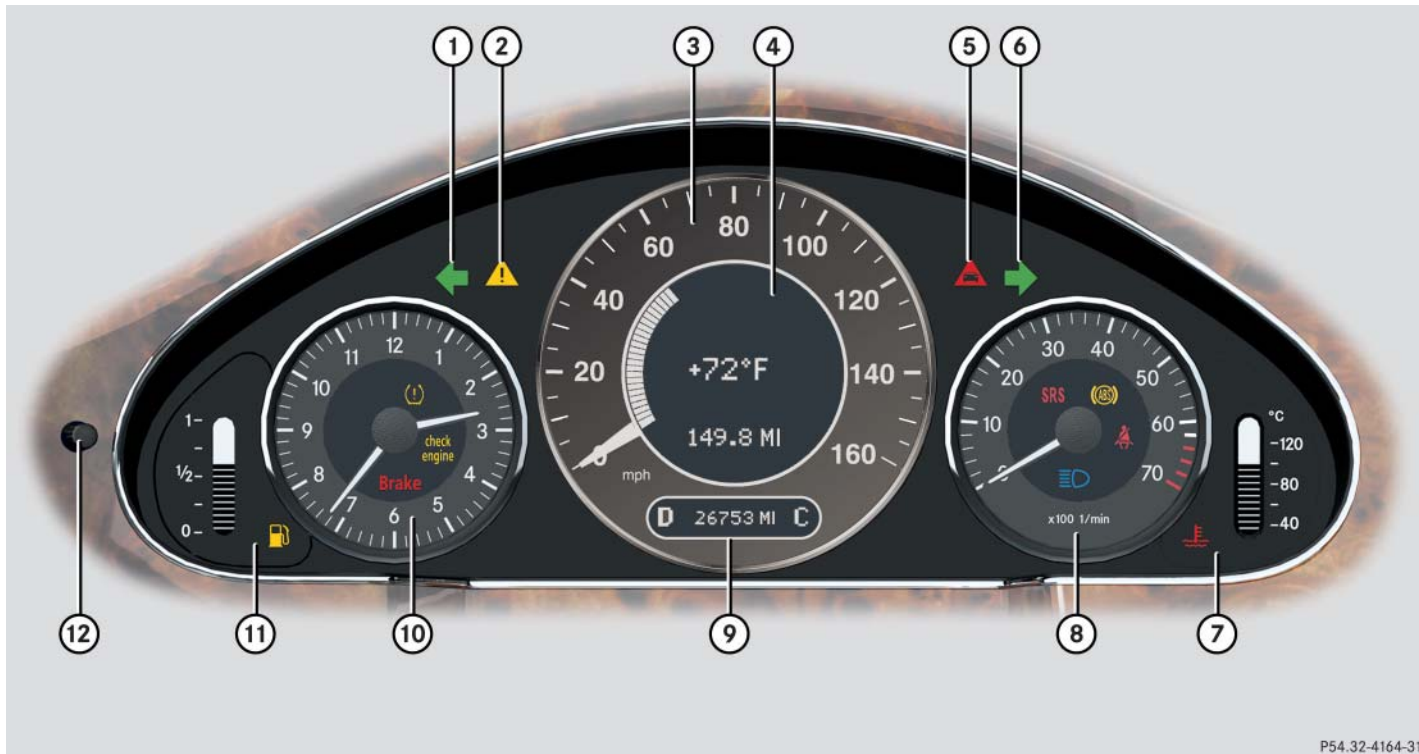





Item	Page
⑮ Headlamp cleaning button*	185
⑯ Parking brake pedal	53, 59
⑰ Hood lock release	286
⑱ Parking brake release	53
⑲ Exterior lamp switch	55, 128
⑳ Door control panel	34





Instrument cluster



P54.32-4164-31

	Item	Page
①	 Left turn signal indicator lamp	
②	 ESP® warning lamp	343
③	Speedometer	
④	Multifunction display	141
⑤	 Distance warning lamp	348
	Vehicles without DISTRONIC*: Warning lamp without function. It illuminates with the ignition on. It should go out when the engine is running.	
⑥	 Right turn signal indicator lamp	
⑦	Coolant temperature indicator with:	
	 Coolant temperature warning lamp	347





	Item	Page
⑧	Tachometer with:	
	 Supplemental Restraint System (SRS) indicator lamp	350
	 Antilock Brake System (ABS) indicator lamp	342
	 Seat belt telltale	348
	 High beam headlamp indicator lamp	132
⑨	Main odometer with:	
	• Selector lever position	51
	• Program mode	177
⑩	Clock with:	159
	 Brake warning lamp, USA only	344
	 Brake warning lamp, Canada only	344

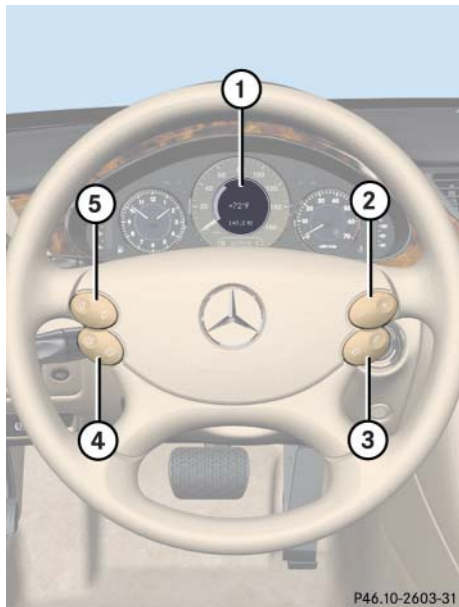



	Item	Page
	 Engine malfunction indicator lamp, USA only	345
	 Engine malfunction indicator lamp, Canada only	345
	 Combination low tire pressure/TPMS malfunction telltale, USA only	351
	Low tire pressure telltale, Canada only	351
⑪	Fuel display with:	
	 Fuel tank reserve warning lamp	348
⑫	Reset button for:	
	• Resetting trip odometer	139
	• Adjusting instrument cluster illumination	138
	• Confirming new time settings	159

Multifunction steering wheel



P46.10-2603-31

Item	Page
① Multifunction display in speedometer	141
Operating control system	142
② Selecting the submenu or setting the volume: Press button	
 up/to increase	
 down/to decrease	
③ Telephone*: Press button	
 to take a call	
to dial	
to redial	
 to end a call	
to reject an incoming call	

Item	Page
④ Menu systems: Press button	
 for next menu	
 for previous menu	
⑤ Moving within a menu: Press button	
 for next display	
 for previous display	

▼ Center console

Upper part



Item	Page
① 4-zone automatic climate control	190
② COMAND system, see separate operating instructions	
③ Seat heating*, front passenger side	123
Seat ventilation*, front passenger side	124
④ Electronic Stability Program (ESP®) control switch	95
⑤ Central locking switch	119

Item	Page
⑥ Opening/closing button for CD changer, see separate COMAND operating instructions	
⑦ Rear seat head restraints switch, folding down	121
⑧ Rear window sunshade* switch	188
⑨ Seat heating*, driver's side	123
Seat ventilation*, driver's side	124
⑩ Hazard warning flasher switch	134
⑪ Front passenger front air bag off indicator lamp	76

Center console

Lower part



	Item	Page
①	Ashtray	249
②	KEYLESS-GO* start/stop button	39
③	Selector lever for automatic transmission	51, 173
④	Parking assist (Parktronic system)* deactivation switch	235
⑤	Adaptive damping system (ADS) switch	231

	Item	Page
⑥	Vehicle level control button	232
⑦	Thumbwheel for setting distance in DISTRONIC*	227
⑧	Distance warning function* on/off switch	227
⑨	Program mode selector switch for automatic transmission	177

▼ Overhead control panel



Item	Page
① Rear interior lighting on/off	135
② Automatic interior lighting	135
③ Front interior lighting on/off	135
④ Right front reading lamp on/off	135
⑤ Tilt/sliding sunroof	212
⑥ Tele Aid (emergency call system) button	257
⑦ Rear view mirror	185
⑧ Front reading lamps	135

Item	Page
⑨ Garage door opener	263
⑩ Hands-free microphones for Tele Aid (emergency call system), telephone*, and Voice Control System* (see separate operating instructions)	
⑪ Ambient lighting	163
⑫ Interior lighting	135
⑬ Left front reading lamp on/off	135

Storage compartments

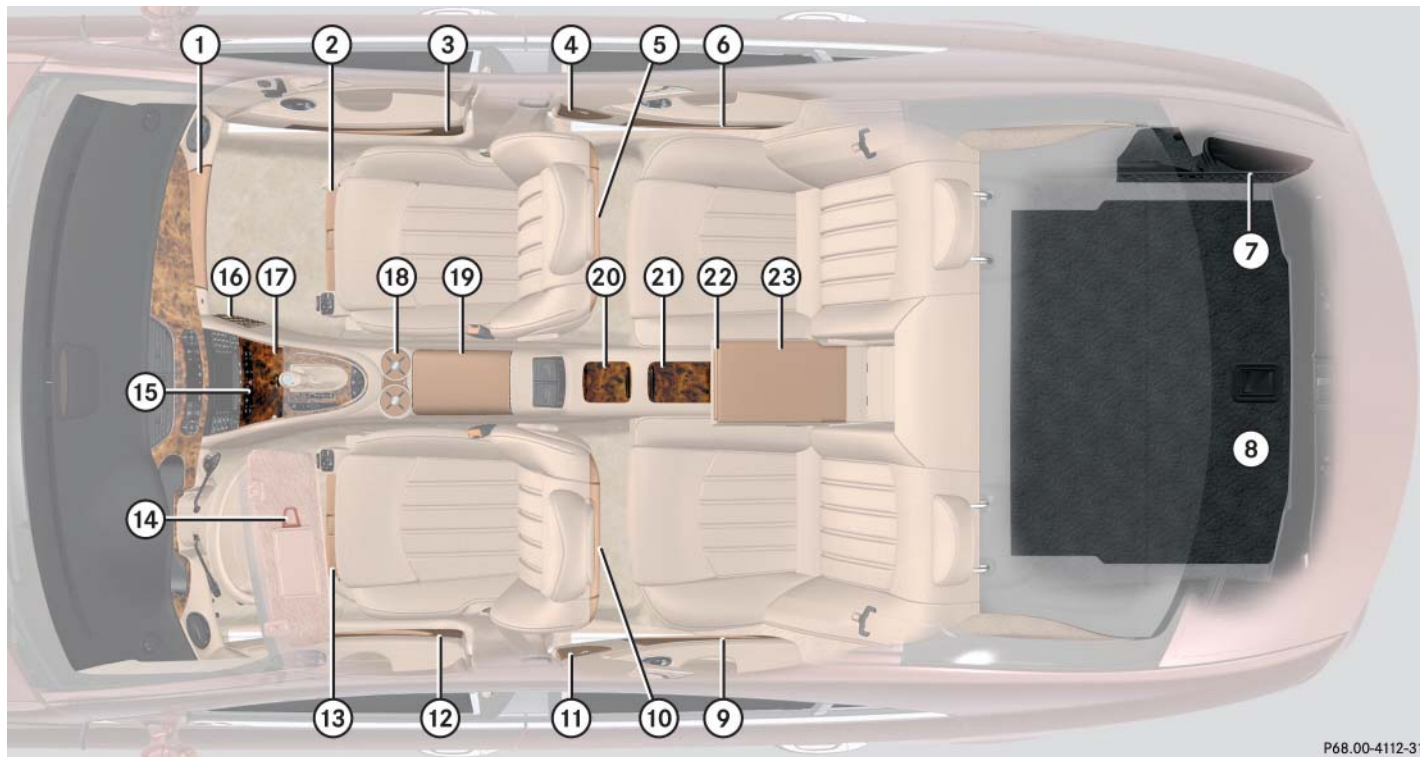

P68.00-4112-31

Item	Page
① Glove box	244
② Front passenger seat storage compartment with first aid kit	391
③ Door pocket	
④ Ashtray	250
⑤ Ruffled storage bag	246
⑥ Door pocket	
⑦ Side storage pocket in trunk	
⑧ Luggage box under the trunk floor	395
⑨ Door pocket	
⑩ Ruffled storage bag	246
⑪ Ashtray	250
⑫ Door pocket	
⑬ Driver's seat storage compartment	245

Item	Page
⑭ Sun visor card clip	187
⑮ CD changer, see separate COMAND operating instructions	
⑯ Parcel net in front passenger footwell	246
⑰ Ashtray with cigarette lighter	249
⑱ Cup holders	247
⑲ Storage compartment/telephone* compartment under the center armrest	244
⑳ Cup holder in the rear center console	248
㉑ Rear storage compartment in the rear center console	245
㉒ Cup holder in the rear armrest	249
㉓ Storage compartment in the rear armrest	245

Door control panel



	Item	Page
①	Inside door handle	111
②	Seat adjustment	42
③	Memory function (for storing seat, exterior mirror and steering wheel settings)	125
④	Exterior rear view mirror adjustment	47
⑤	Switches for opening/closing front and rear side windows, rear window override switch	207
⑥	Remote trunk release switch, trunk opening/closing system*	113

Unlocking

Adjusting

Driving

Parking and locking



Unlocking





The “Getting started” section provides an overview of the vehicle’s most basic functions. First-time Mercedes-Benz owners should pay special attention to the information given here.

If you are already familiar with the basic functions described here, the “Controls in detail” section will provide you with further information. The corresponding page references are located at the end of each segment.

Unlocking with the SmartKey



SmartKey with remote control

- ①  Lock button
- ②  Opening button for trunk
- ③  Unlock button
- ④  Panic button

Warning!



When leaving the vehicle, always remove the SmartKey from the starter switch, take it with you, and lock the vehicle. Do not leave children unattended in the vehicle, or with access to an unlocked vehicle. A child’s unsupervised access to a vehicle could result in an accident and/or serious personal injury.

- ▶ Press unlock button  on the SmartKey.
 - All turn signal lamps flash once.
 - An acoustic signal sounds once.
 - The locking knobs in the doors move up.
 - The anti-theft alarm system is disarmed.
- ▶ Get in the vehicle and insert the SmartKey in the starter switch.

i Opening a door causes the window on that door to open slightly. They will return to the up position when the door is closed.

! The side windows will not open or close if the battery is discharged or the windows are covered with ice. As a result, you may no longer be able to properly close the door. Do not attempt to force the door shut. Doing so may damage the door or the side window. Correct the condition that prevents the windows from operating before attempting to close the door.

For more information, see “Locking and unlocking” (▷ page 102).

Unlocking with KEYLESS-GO*

With the KEYLESS-GO function, you can lock and unlock the vehicle without using the remote control buttons on the SmartKey and start the engine without inserting the SmartKey in the starter switch.

Warning!



When leaving the vehicle, always take the SmartKey with KEYLESS-GO with you, and lock the vehicle. Do not leave children unattended in the vehicle, or with access to an unlocked vehicle. A child’s unsupervised access to a vehicle could result in an accident and/or serious personal injury.

i To unlock the vehicle, the SmartKey with KEYLESS-GO must be outside the vehicle, no further than approximately 3 feet (1 meter) away from the door.

▶ Pull an outside door handle.

- All turn signal lamps flash once.
- An acoustic signal sounds once.
- The locking knobs in the doors move up.
- The anti-theft alarm system is disarmed.

▶ Get in the vehicle.

i Opening a door causes the window on that door to open slightly. They will return to the up position when the door is closed.

! The side windows will not open or close if the battery is discharged or the windows are covered with ice. As a result, you may no longer be able to properly close the door. Do not attempt to force the door shut. Doing so may damage the door or the side window. Correct the condition that prevents the windows from operating before attempting to close the door.

For more information, see “SmartKey with KEYLESS-GO*” (▷ page 105).

Unlocking

Starter switch positions

Warning!



When leaving the vehicle, always remove the SmartKey or SmartKey with KEYLESS-GO* from the starter switch, take it with you, and lock the vehicle. Do not leave children unattended in the vehicle, or with access to an unlocked vehicle. A child's unsupervised access to a vehicle could result in an accident and/or serious personal injury.

SmartKey



Starter switch

- 0 For removing the SmartKey
- 1 Power supply for some electrical consumers, such as seat adjustment

- 2 Ignition (power supply for all electrical consumers) and driving position. All lamps (except high beam headlamp indicator lamp and turn signal indicator lamps unless activated) in the instrument cluster come on. If a lamp in the instrument cluster fails to come on when the ignition is switched on, have it checked and replaced if necessary. If a lamp in the instrument cluster remains on after starting the engine or comes on while driving, see “Lamps in instrument cluster” (▷ page 342).
- 3 Starting position

i When you switch on the ignition, the indicator and warning lamps (except high beam headlamp indicator lamp and turn signal indicator lamps unless activated) in the instrument cluster come on. The indicator and warning lamps (except high beam headlamp indicator lamp and turn signal indicator lamps if activated) should go out when the engine is running. This indicates that the respective systems are operational.

i The SmartKey can only be removed from the starter switch with the gear selector lever in position **P**.

i If the SmartKey is left in starter switch position **0** for an extended period of time, it can no longer be turned in the switch. In this case, the steering is locked. To unlock, remove SmartKey from the starter switch and reinsert.

! If the SmartKey cannot be turned in the starter switch, the battery may not be sufficiently charged.

- Check the battery and charge it if necessary (▷ page 420).
- Get a jump start (▷ page 423).

To prevent accelerated vehicle battery discharge or a completely discharged vehicle battery, always remove the SmartKey from the starter switch when the engine is not in operation.

For information on starting the engine with the SmartKey, see “SmartKey” (▷ page 102).

SmartKey with KEYLESS-GO*

If the SmartKey with KEYLESS-GO is inside the vehicle, pressing the KEYLESS-GO start/stop button on the gear selector lever corresponds to turning the SmartKey to the various starter switch positions.

If you firmly depress the brake pedal during pressing the KEYLESS-GO start/stop button, the engine starts automatically.

i The function of the SmartKey overrides the KEYLESS-GO function.



KEYLESS-GO start/stop button

- ① USA only
- ② Canada only

The SmartKey with KEYLESS-GO must be located in the vehicle.

- ▶ Make sure the gear selector lever is set to **P**.
- ▶ Do not depress the brake pedal.

Unlocking

Position 0

Before you press the KEYLESS-GO start/stop button, the vehicle's on-board electronics have status **0** (as with SmartKey removed).

Position 1

- ▶ Press KEYLESS-GO start/stop button once.

This supplies power for some electrical consumers, such as seat adjustment.

i If you now press the KEYLESS-GO start/stop button

- once again, the ignition (position **2**) is switched on
- twice, the power supply is again switched off

Ignition (or position 2)

- ▶ Press KEYLESS-GO start/stop button twice.

This supplies power for all electrical consumers. All lamps (except high beam headlamp indicator lamp and turn signal indicator lamps unless activated) in the instrument cluster come on. If a lamp in the instrument cluster fails to come on when the ignition is switched on, have it checked and replaced if necessary. If a lamp in the instrument cluster remains on after driving, see “Lamps in instrument cluster” (▷ page 342).

i If you now press the KEYLESS-GO start/stop button once, the power supply is again switched off.

i When you switch on the ignition, the indicator and warning lamps (except high beam headlamp indicator lamp and turn signal indicator lamps unless activated) in the instrument cluster come on. The indicator and warning lamps (except high beam headlamp indicator lamp and turn signal indicator lamps if activated) should go out when the engine is running. This indicates that the respective systems are operational.

For information on starting the engine using the KEYLESS-GO start/stop button (▷ page 39).

▼ Adjusting

Warning!



All seat, head restraint, steering wheel, and rear view mirror adjustments, as well as fastening of seat belts, must be done before the vehicle is put into motion.

Seats

Warning!



Do not adjust the driver's seat while driving. Adjusting the seat while driving could cause the driver to lose control of the vehicle.

Never ride in a moving vehicle with the seat backrest in an excessively reclined position as this can be dangerous. You could slide under the seat belt in a collision. If you slide under it, the belt would apply force at the abdomen or neck. That could cause serious or fatal injuries. The seat back and seat belts provide the best restraint when the wearer is in a nearly upright position and belts are properly positioned on the body.

Warning!



Your seat must be adjusted so that you can correctly fasten your seat belt (▷ page 48).

Observe the following points:

- Adjust the backrest until your arms are slightly angled when holding the steering wheel.
- Adjust the seat to a comfortable seating position that still allows you to reach the accelerator/brake pedal safely. The position should be as far to the rear as possible, consistent with ability to properly operate controls.
- Adjust the head restraint so that it is as close to the head as possible and the center of the head restraint supports the back of the head at eye level.
- Never place hands under the seat or near any moving parts while a seat is being adjusted.

Failure to do so could result in an accident and/or serious personal injury.

Warning!



When leaving the vehicle, always remove the SmartKey or the SmartKey with KEYLESS-GO* from the starter switch, take it with you, and lock the vehicle.

Even with the SmartKey or the SmartKey with KEYLESS-GO* removed from the starter switch or the SmartKey with KEYLESS-GO* removed from the vehicle, the power seats can be operated when the respective door is open. Therefore, do not leave children unattended in the vehicle, or with access to an unlocked vehicle. A child's unsupervised access to a vehicle could result in an accident and/or serious personal injury.

Warning!



According to accident statistics, children are safer when properly restrained in the rear seating positions than in the front seating position. Thus, we strongly recommend that children be placed in the rear seats whenever possible. Regardless of seating position, children 12 years old and under must be seated and properly secured in an appropriate infant or toddler restraint, or booster seat recommended for the size and weight of the child. For additional information, see “Children in the vehicle” (▷ page 84).

A child’s risk of serious or fatal injuries is significantly increased if the child restraints are not properly secured in the vehicle and the child is not properly secured in the child restraint.

Seat adjustment

The seat adjustment switches are located on the front doors.



- ① Seat fore and aft adjustment
- ② Backrest tilt
- ③ Head restraint height
- ④ Seat height
- ⑤ Seat cushion tilt

▶ Switch on the ignition (▷ page 38).

or

▶ Open the respective door.

i The memory function (▷ page 125) lets you store the settings for the seat position together with the settings for the steering wheel and the exterior rear view mirrors.

! When moving the seat, make sure there are no items in the footwell or behind the seats. Otherwise you could damage the seats.

Seat fore and aft adjustment

▶ Press the switch forward or backward in the direction of arrow ①.

i Depending on the set height of the head restraint, the seat fore and aft position is automatically pre-set.

Backrest tilt

- ▶ Press the switch forward or backward in the direction of arrow ②.

Head restraint height

- ▶ Press the switch up or down in the direction of arrow ③.

Warning!

For your protection, drive only with properly positioned head restraints.

Adjust the head restraint so that it is as close to the head as possible and the center of the head restraint supports the back of the head at eye level. This will reduce the potential for injury to the head and neck in the event of an accident or similar situation.

Do not drive the vehicle without the seat head restraints. Head restraints are intended to help reduce injuries during an accident.

Seat height

- ▶ Press the switch up or down in the direction of arrow ④.

Seat cushion tilt

- ▶ Press the switch up or down in the direction of arrow ⑤ until your upper legs are lightly supported.

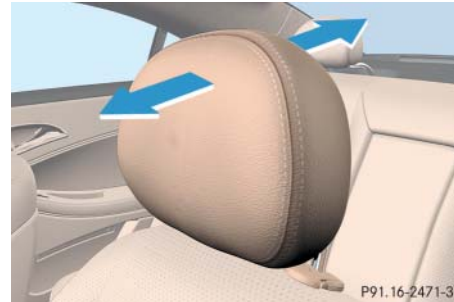
Head restraint adjusting

Manually adjust the head restraint.

- ▶ Push or pull on the upper edge of the head restraint cushion.

- ▶ **i** Adjust the head restraint in such a way that it is as close to the head as possible.

Comfort head restraint* adjusting

- ① Head restraint side adjustment
- ② Head restraint fore and aft adjustment

Warning!

When folding back the side cushions, never reach between the side cushion and the mounting post. You could otherwise be trapped.

Adjusting

You can individually adjust side cushions ① of the comfort head restraints.

Adjusting side cushions

- ▶ Pull or push sides ① into desired position.

Adjusting forward or backward

- ▶ Pull or push head restraint in direction of arrow ②.

i Adjust the head restraint in such a way that it is as close to the head as possible.

For more information on seats, see “Seats” (▷ page 120).

Steering wheel

Warning!



Do not adjust the steering wheel while driving. Adjusting the steering wheel while driving could cause the driver to lose control of the vehicle.

When leaving the vehicle, always remove the SmartKey or the SmartKey with KEYLESS-GO* from the starter switch, take it with you, and lock your vehicle.

Even with the SmartKey removed from the starter switch or the SmartKey with KEYLESS-GO* removed from the vehicle, the steering wheel adjustment feature can be operated when the driver's door is open. Therefore, do not leave children unattended in the vehicle, or with access to an unlocked vehicle. A child's unsupervised access to a vehicle could result in an accident and/or serious personal injury.

Steering wheel adjustment

The stalk for steering wheel adjustment is located on the steering column (lower left).

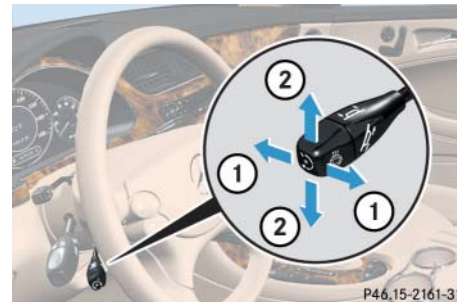

- ① Adjusting steering column, in or out
- ② Adjusting steering column, up or down

- ▶ Switch on the ignition (▷ page 38).

or

- ▶ Open the driver's door.

Adjusting steering column in or out

- ▶ Move stalk in direction of arrows ① until a comfortable steering wheel position is reached with your arms slightly bent at the elbow.

Adjusting steering column up or down

- ▶ Move stalk in direction of arrows ②.

Make sure your legs can move freely and that all the displays (incl. malfunction and indicator lamps) on the instrument cluster are clearly visible.

i *The memory function (▷ page 125) lets you store the setting for the seat position together with the setting for the steering wheel and the exterior rear view mirrors.*

Easy-entry/exit feature

This feature allows for easier entry into and exit from the vehicle. When entering and exiting the vehicle, the steering wheel is in its uppermost position.

The easy-entry/exit feature can be activated or deactivated in the Convenience sub-menu of the control system (▷ page 166).

Warning!



You must make sure no one can become trapped or injured by the moving steering wheel when the easy-entry/exit feature is activated.

To stop steering wheel movement, do one of the following:

- Move steering wheel adjustment stalk (▷ page 44).
- Press one of the memory position buttons or the memory button **M** (▷ page 126).

Do not leave children unattended in the vehicle, or with access to an unlocked vehicle. Children could open the driver's door and unintentionally activate the easy-entry/exit feature, which could result in an accident and/or serious personal injury.

With the easy-entry/exit feature activated, the steering wheel will return to its last set position when you

- close the driver's door with the ignition switched on

or

- insert the SmartKey into the starter switch or press the KEYLESS-GO* start/stop button (▷ page 39) once with the driver's door closed

i *The last set steering wheel position is stored when*

- *the ignition is switched off*
- *the position is stored in memory (▷ page 125)*

Adjusting

With the easy-entry/exit feature activated, the steering wheel tilts upwards when you

- remove the SmartKey from the starter switch

or

- open the driver's door with the SmartKey in starter switch position **0** or **1** or the KEYLESS-GO* start/stop button (> page 39) in position **1**

i *If the current position for the steering wheel is in the uppermost tilt position, the steering wheel will no longer be able to move upward when the easy-entry/exit feature is activated.*

The adjustment procedure is briefly interrupted when the engine is started.

Warning!



Let the system complete the adjustment procedure before setting the vehicle in motion. All steering wheel adjustment must be completed before setting the vehicle in motion. Driving off with the steering wheel still adjusting could cause the driver to lose control of the vehicle.

Mirrors

Adjust the interior and exterior rear view mirrors before driving so that you have a good view of the road and traffic conditions.

Warning!



In case of an accident, liquid electrolyte may escape the mirror housing if the mirror glass breaks.

Electrolyte has an irritating effect. Do not allow the liquid to come into contact with eyes, skin, clothing, or respiratory system. In case it does, immediately flush affected area with water, and seek medical help if necessary.

! *Electrolyte drops coming into contact with the vehicle paint finish can only be completely removed while in their liquid state and by applying plenty of water.*

Interior rear view mirror

- ▶ Manually adjust the interior rear view mirror.

For more information, see “Rear view mirrors” (▷ page 185).

Exterior rear view mirrors

Warning!



Exercise care when using the passenger-side exterior rear view mirror. The mirror surface is convex (outwardly curved surface for a wider field of view). Objects in mirror are closer than they appear. Check your interior rear view mirror or glance over your shoulder before changing lanes.

The buttons are located on the driver's door.

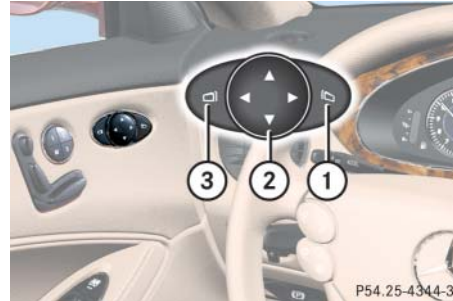

- ① Passenger-side exterior rear view mirror button
 - ② Adjustment button
 - ③ Driver's side exterior rear view mirror button
- ▶ Switch on the ignition (▷ page 38).
 - ▶ Press button ③ for the driver's side exterior rear view mirror or button ① for the passenger-side exterior rear view mirror.
 - ▶ Push adjustment button ② up, down, left or right according to the desired setting.

! If an exterior rear view mirror was forcibly pushed forward (hit from the rear) or forcibly pushed rearward (hit from the front), reposition it by applying firm pressure until it snaps into place. The mirror housing is now properly positioned and you can adjust the mirror normally.

i The memory function (▷ page 125) lets you store the setting for the seat position together with the setting for the steering wheel and the exterior rear view mirrors.

At low ambient temperatures, the exterior rear view mirrors will be heated automatically.

For more information, see “Activating exterior rear view mirror parking position” (▷ page 187).

For more information, see “Rear view mirrors” (▷ page 185).

Driving

Warning!



Make sure that absolutely no objects are obstructing the pedals range of movement. Keep the driver's footwell clear of all obstacles. If there are any floor mats or carpets in the footwell, make sure that the pedals still have sufficient clearance.

During sudden driving or braking maneuvers the objects could get caught between the pedals. You could then no longer brake or accelerate. This could lead to accidents and injury.

Fastening the seat belts

Warning!



Always fasten your seat belt before driving off. Always make sure all of your passengers are properly restrained, even those sitting in the rear.

Failure to wear and properly fasten and position your seat belt greatly increases your risk of injuries and their likely severity in an accident. You and your passengers should always wear seat belts.

If you are ever in an accident, your injuries can be considerably more severe without your seat belt properly buckled. Without your seat belt buckled, you are much more likely to hit the interior of the vehicle or be ejected from it. You can be seriously injured or killed.

In the same crash, the possibility of injury or death is lessened if you are wearing your seat belt. The air bags can only provide the protection they were designed to afford if the occupants are using their seat belts (▷ page 78).

Warning!



According to accident statistics, children are safer when properly restrained in the rear seating positions than in the front

seating position. Thus, we strongly recommend that children be placed in the rear seats. Regardless of seating position, children 12 years old and under must be seated and properly secured in an appropriate infant or toddler restraint, or booster seat recommended for the size and weight of the child. For additional information, see "Children in the vehicle" (▷ page 84).

A child's risk of serious or fatal injuries is significantly increased if the child restraints are not properly secured in the vehicle and the child is not properly secured in the child restraint.

Warning!



Never let more people ride in the vehicle than there are seat belts available. Be sure everyone riding in the vehicle is correctly restrained with a separate seat belt. Never use a seat belt for more than one person at a time.

Warning!

Never ride in a moving vehicle with the seat backrest in an excessively reclined position as this can be dangerous. You could slide under the seat belt in a collision. If you slide under it, the belt would apply force at the abdomen or neck. That could cause serious or even fatal injuries. The seat backrest and seat belt provide the best restraint when the wearer is in a nearly upright position and the belt is properly positioned on the body.

Warning!

Read and observe the additional warning notices printed in the “Safety and security” section (▷ page 78).

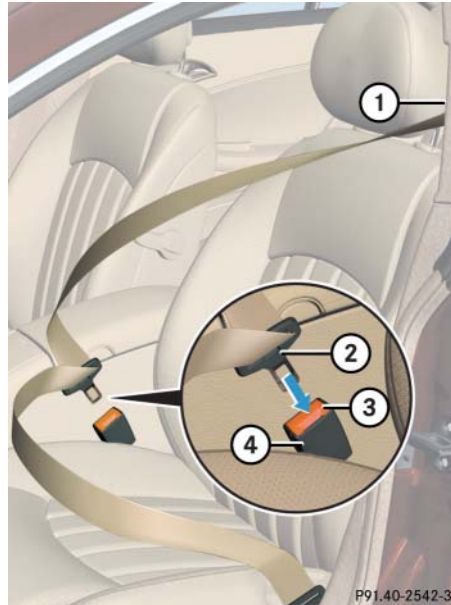

- ① Belt outlet
- ② Latch plate
- ③ Release button
- ④ Buckle

- ▶ With a smooth motion, pull the belt from belt outlet ①.
- ▶ Place the shoulder portion of the belt across the top of your shoulder and the lap portion across your hips.
- ▶ Push latch plate ② into buckle ④ until it clicks.
- ▶ If necessary, tighten the lap portion to a snug fit by pulling shoulder portion up.

Belt outlet height adjustment

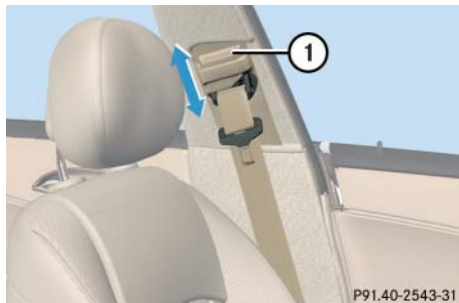

① Release button

- ▶ Press release button ① and move the seat belt height adjuster upward or downward.

Proper use of seat belts

- Do not twist the belt when fastening.
- Adjust seat belt so that the shoulder portion is located as close as possible to the middle of the shoulder (it should not touch the neck). Never pass the shoulder portion of the belt under your arm.

- Position the lap belt as low as possible on your hips (over hip joint) and not across the abdomen.
- Place the seat backrest in a nearly upright position.
- Never use a seat belt for more than one person at a time.
- Do not fasten a seat belt around a person and another object at the same time. When using a seat belt to secure infant or toddler restraints or children in booster seats, always follow the child seat manufacturer's instructions.
- Check your seat belt periodically during travel to make sure that it is properly positioned.
- Make sure that the seat belt is always fitted snugly. Take special care of this when wearing loose clothing.

Warning!



Do not pass belts over sharp edges. They could tear.

Do not allow the belt to get caught in the door or in the seat adjustment mechanism. This could damage the belt.

Never attempt to make modifications to seat belts. This could impair the effectiveness of the belts.

Do not bleach or dye seat belts as this may severely weaken them. In a crash they may not be able to provide adequate protection.

Damaged seat belts or belts that were highly stressed in an accident must be replaced. Contact an authorized Mercedes-Benz Center.

Starting the engine

Warning!



Inhalation of exhaust gas is hazardous to your health. All exhaust gas contains carbon monoxide (CO), and inhaling it can cause unconsciousness and possible death.

Do not run the engine in confined areas (such as a garage) which are not properly ventilated. If you think that exhaust gas fumes are entering the vehicle while driving, have the cause determined and corrected immediately. If you must drive under these conditions, drive only with at least one window fully open.

Automatic transmission



Gearshift pattern for automatic transmission

- P** Park position with gear selector lever lock
- R** Reverse gear
- N** Neutral
- D** Drive position

For more information, see the “Controls in detail” section (▷ page 176).

Starting with the SmartKey

For information on turning off the engine with the SmartKey, see “Turning off engine” (▷ page 60).

- ▶ Make sure the gear selector lever is set to **P**.
- ▶ Do not depress the accelerator.
- ▶ Turn the SmartKey in the starter switch to position **3** and hold until the engine starts (▷ page 38).

i You can also use the “touch-start” function. Turn the SmartKey to position **3** and release it again immediately. The engine then starts automatically.

Starting with KEYLESS-GO*

Warning!



As long as the SmartKey with KEYLESS-GO is in your vehicle, the vehicle can be started. Therefore, never leave children unattended in the vehicle, as they could otherwise accidentally start the engine.

When leaving the vehicle, always take the SmartKey with KEYLESS-GO with you and lock the vehicle. Do not leave children unattended in the vehicle, or with access to an unlocked vehicle.

You can start your vehicle without the SmartKey in the starter switch using the KEYLESS-GO start/stop button on the gear selector lever.

For information on turning off the engine with KEYLESS-GO, see “Locking with KEYLESS-GO*” (▷ page 62).

The SmartKey with KEYLESS-GO must be located in the vehicle.



KEYLESS-GO start/stop button

- ① USA only
- ② Canada only

- ▶ Make sure the gear selector lever is set to **P**.
- ▶ Depress the brake pedal during the starting procedure. Do not depress accelerator.
The selector lever lock is released.
- ▶ Press KEYLESS-GO start/stop button ① once.

The engine starts if the SmartKey with KEYLESS-GO is in the vehicle.

Starting difficulties

If the engine does not start as described, carry out the following steps:

- ▶ If you are starting the engine with the SmartKey, turn SmartKey in starter switch to position **0** and repeat starting procedure.
- ▶ If you are starting the engine with KEYLESS-GO: Close any doors that may be open to allow for better detection of the SmartKey with KEYLESS-GO.
Or:
Start the engine with the SmartKey as radio signals from another source may be interfering with the SmartKey with KEYLESS-GO.
- ▶ Repeat the starting procedure (▷ page 51). Remember that extended starting attempts can drain the battery.
- ▶ Get a jump start (▷ page 423).

If the engine does not start after several starting attempts, there could be a malfunction in the engine electronics or in the fuel supply system.

- ▶ Notify an authorized Mercedes-Benz Center.

Parking brake



- ① Release handle
- ② Parking brake pedal

Warning!



When leaving the vehicle, always remove the SmartKey or the SmartKey with KEYLESS-GO* from the starter switch, take it with you and lock the vehicle. Do not leave children unattended in the vehicle, or with access to an unlocked vehicle. Children could release the parking brake, which could result in an accident and/or serious personal injury.

- ▶ Release the parking brake pedal by pulling on handle ①.

The warning lamp **BRAKE** (USA only) or **ⓘ** (Canada only) in the instrument cluster goes out.

Driving off

- ▶ Depress the brake pedal.
- ▶ Move selector lever to position **D** or **R**.

i Wait for the gear selection process to complete before setting the vehicle in motion.

- ▶ Release the brake pedal.
- ▶ Carefully depress the accelerator pedal.

Once the vehicle is in motion, the automatic central locking system engages and the locking knobs drop down.

! If you hear a warning signal and the message *Release parking brake* appears in the multifunction display when driving off, you have forgotten to release the parking brake.

Release the parking brake (▷ page 53).



Driving

- ▷▷ **i** Once the vehicle is in motion, the automatic central locking system engages and the locking knobs drop down.

The automatic door lock feature can be deactivated (▷ page 165).

You can open a locked door from the inside. Open door only when conditions are safe to do so.

After a cold start, the automatic transmission engages at a higher revolution. This allows the catalytic converter to reach its operating temperature earlier.

Warning!



On slippery road surfaces, never downshift in order to obtain braking action. This could result in drive wheel slip and reduced vehicle control. Your vehicle's ABS will not prevent this type of loss of control.

Warning!



It is dangerous to shift the gear selector lever out of **P** or **N** if the engine speed is higher than idle speed. If your foot is not firmly on the brake pedal, the vehicle could accelerate quickly forward or in reverse. You could lose control of the vehicle and hit someone or something. Only shift into gear when the engine is idling normally and when your right foot is firmly on the brake pedal.

! Simultaneously depressing the accelerator pedal and applying the brakes reduces engine performance and causes premature brake and drivetrain wear.

! Do not run cold engine at high engine speeds. Running a cold engine at high engine speeds may shorten the service life of the engine.

CLS 63 AMG:

At engine temperatures below 68°F (20°C), the engine's maximum speed is restricted in order to protect it from damage. Avoid driving your vehicle at full speed when the engine is cold to prevent premature engine wear and/or diminished comfort.

For more information on driving, see “Driving instructions” (▷ page 271).

Switching on headlamps

Low beam headlamps

The exterior lamp switch is located on the dashboard to the left of the steering wheel.



Exterior lamp switch

- 1 Off
- 2 Low beam headlamps on

- ▶ Turn the exterior lamp switch to position .

The low beam headlamps and the green indicator lamp  in the exterior lamp switch comes on.

High beam

The combination switch is located on the left of the steering column.



Combination switch

- ① High beam
- ② High beam flasher

- ▶ Push the combination switch in direction of arrow ①.

The high beam headlamps and the high beam headlamp indicator lamp  in the instrument cluster comes on (▷ page 26).

For more information on headlamps, see “Lighting” (▷ page 128).

Turn signals

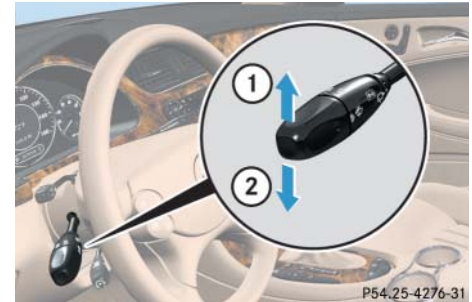

The combination switch is located on the left of the steering column.



Combination switch

- ① Turn signals, right
- ② Turn signals, left

- ▶ Press combination switch in direction of arrow ① or ②.

The corresponding turn signal indicator lamp  or  in the instrument cluster flashes (▷ page 26).

▷▷

▷▷ The combination switch resets automatically after major steering wheel movements.

i To signal minor directional changes such as changing lanes, press combination switch only to point of resistance and release. The corresponding turn signals will flash three times.

Windshield wipers

The combination switch is located on the left of the steering column.

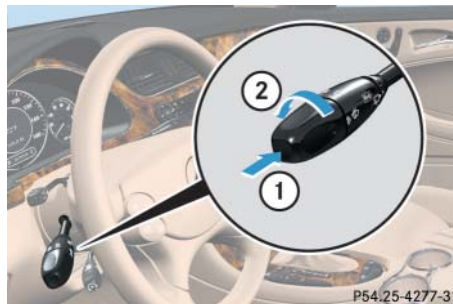

Combination switch

- ① Single wipe
Wiping with windshield washer fluid
 - ② Switching on windshield wipers
- ▶ Switch on the ignition (▷ page 38).

! Do not operate the wipers when the windshield is dry. Dust that accumulates on a windshield might scratch the glass and/or damage the wiper blades when wiping occurs on a dry windshield. If it is necessary to operate the wipers in dry weather conditions, always operate the wipers with windshield washer fluid (▷ page 58).

! If anything blocks the windshield wipers (leaves, snow, etc.), switch them off immediately.

- For safety reasons, stop the vehicle in a safe location
 - turn off the engine by turning the SmartKey to position **0** and withdraw SmartKey from starter switch
- or
- turn off the engine by pressing the KEYLESS-GO* start/stop button and open the driver's door (with the driver's door open, starter switch is in position **0**, same as with SmartKey removed from starter switch)
- before attempting to remove any blockage.
- Remove blockage.
 - Turn the windshield wipers on again.

! If windshield wipers fail to function at all in combination switch position **...** or **....**,

- set the combination switch to the next highest wiper speed
- have the windshield wipers checked at the nearest authorized Mercedes-Benz Center

Switching on windshield wipers

- ▶ Turn the combination switch to the desired position depending on the intensity of the rain.

- 0** Windshield wipers off
- ...** Slow intermittent wiping
Rain sensor operation with low sensitivity.
-** Fast intermittent wiping
Rain sensor operation with high sensitivity.
- Slow continuous wiping
- ==** Fast continuous wiping

Intermittent wiping

Only switch on intermittent wiping under wet weather conditions or in the presence of precipitation.

! Do not leave windshield wipers in intermittent setting when the vehicle is taken to an automatic car wash or during windshield cleaning. Windshield wipers will operate in the presence of water sprayed on the windshield, and windshield wipers may be damaged as a result.

! If you have set intermittent wiping, dirt on the surface of the rain sensor or optical effects may cause the windshield wipers to wipe in an undesired fashion. This could then damage the windshield wiper blades or scratch the windows. You should therefore switch off the windshield wipers when weather conditions are dry.

Intermittent wiping interval is dependent on wetness of windshield.

- ▶ Turn the combination switch to position **...** or **....**.

After the initial wipe, pauses between wipes are automatically controlled by the rain sensor.

i Intermittent wiping is interrupted when the vehicle is at a standstill and a front door is opened. This protects persons getting into or out of the vehicle from being sprayed.

Intermittent wiping will be continued when

- all doors are closed
- and
- the gear selector lever is in position **D** or **R**
- or
- the wiper setting is changed using the combination switch

Driving

Single wipe

- ▶ Press the combination switch briefly in direction of arrow ① (▷ page 56) to the resistance point.

The windshield wipers wipe one time without washer fluid.

Wiping with windshield washer fluid

- ▶ Push the combination switch in direction of arrow ① (▷ page 56) past the resistance point.

The windshield wipers operate with washer fluid.

i *To prevent smears on the windshield or noisy/chattering wiper blades, wipe with windshield washer fluid every now and then even when it is raining.*

For information on filling up the washer reservoir, see “Windshield washer system and headlamp cleaning system*” (▷ page 292).

Problems while driving

The engine runs erratically and misfires

- An ignition cable may be damaged.
 - The engine electronics may not be operating properly.
 - Unburned gasoline may have entered the catalytic converter and damaged it.
- ▶ Give very little gas.
 - ▶ Have the problem repaired by an authorized Mercedes-Benz Center as soon as possible.

The coolant temperature is above 248°F (120°C)

The coolant is too hot and is no longer cooling the engine.

- ▶ Stop the vehicle in a safe location as soon as possible and turn off the engine. Allow engine and coolant to cool off.

- ▶ Check the coolant level and add coolant if necessary (▷ page 290).

In case of accident

If the vehicle is leaking fuel:

- ▶ Do not start the engine under any circumstances.
- ▶ Notify local fire and/or police authorities.

If the extent of the damage cannot be determined:

- ▶ Notify an authorized Mercedes-Benz Center.

If no damage can be determined on the

- major assemblies
 - fuel system
 - engine mount:
- ▶ Start the engine in the usual manner.

▼ Parking and locking

You have now completed your first drive. You have properly stopped and parked your vehicle. End your drive as follows.

Warning!



With the engine not running, there is no power assistance for the brake and steering systems. In this case, it is important to keep in mind that a considerably higher degree of effort is necessary to brake and steer the vehicle.

Warning!



If you have selected the Comfort suspension tuning (▷ page 231), the vehicle lowers slightly when it is locked. You should therefore make sure that no one is standing near the wheel arches or lying underneath the vehicle when it is being locked. Otherwise, personal injury could result.

Warning!



Do not park this vehicle in areas where combustible materials such as grass, hay or leaves can come into contact with the hot exhaust system, as these materials could be ignited and cause a vehicle fire.

To reduce the risk of personal injury, or damage to the vehicle drivetrain, as a result of vehicle movement, before turning off the engine and leaving the vehicle always:

- Keep right foot on brake pedal.
- Firmly depress parking brake pedal.
- Move the gear selector lever to position **P**.
- Slowly release brake pedal.
- When parked on an incline, turn front wheel towards the road curb.
- Turn the SmartKey in the starter switch to position **0** and remove the SmartKey from the starter switch, or press KEYLESS-GO* start/stop button.

- Take the SmartKey or the SmartKey with KEYLESS-GO* with you and lock vehicle when leaving.

! *If you have selected the Comfort suspension tuning (▷ page 231), the vehicle lowers slightly when you lock it within approximately 60 seconds after switching off the engine. When parking, make sure that your vehicle cannot come into contact with other objects, such as a curb, while lowering. Your vehicle could otherwise be damaged.*

Parking brake

Warning!



Engaging the parking brake while the vehicle is in motion can cause the rear wheels to lock up. You could lose control of the vehicle and cause an accident. In addition, the vehicle's brake lights do not light up when the parking brake is engaged.

Parking and locking



- ① Release handle
- ② Parking brake pedal
- ▶ Step firmly on parking brake pedal ②.

When the engine is running, the warning lamp **BRAKE** (USA only) or **(1)** (Canada only) in the instrument cluster will be illuminated.

Warning!



When leaving the vehicle, always remove the SmartKey or SmartKey with KEYLESS-GO* from the starter switch, take it with you and lock the vehicle. Do not leave children unattended in the vehicle, or with access to an unlocked vehicle. Children could release the parking brake and/or move the gear selector lever from position **P**, either of which could result in an accident and/or serious personal injury.

Warning!



Getting out of your vehicle with the gear selector lever not fully engaged in position **P** is dangerous. Also, when parked on an incline, position **P** alone may not prevent your vehicle from moving, possibly hitting people or objects.

Always set the parking brake in addition to shifting to position **P**.

When parked on an incline, turn front wheels towards the road curb.

Switching off headlamps

- ▶ Turn the exterior lamp switch to **0** (▷ page 55).

For more information, see “Lighting” (▷ page 128).

Turning off engine

- ▶ Shift the automatic transmission to position **P** (▷ page 173).
- ▶ Apply the parking brake (▷ page 59).

i Always set the parking brake in addition to shifting to position **P** (▷ page 173).

On slopes, turn the front wheels towards the road curb.

Turning off with the SmartKey

- ▶ Turn the SmartKey in the starter switch (▷ page 38) to position **0**.
- ▶ Remove the SmartKey from the starter switch.
The immobilizer is activated.

Turning off with KEYLESS-GO*

- ▶ Press the KEYLESS-GO start/stop button (▷ page 39) to turn off the engine.

With the driver's door closed, the starter switch is now in position **1**. With the driver's door opened, the starter switch is set to position **0**, same as SmartKey removed from starter switch (▷ page 38).

i If you hear a warning signal you have tried to turn off the engine while the gear selector lever was not in **P**.

In addition, the message Gear selector lever in Park position appears in the multi-function display.

Place the gear selector lever in position **P**.

Releasing seat belts

- ▶ Press the seat belt release button (▷ page 49).

Allow the retractor to completely rewind the seat belt by guiding the latch plate.

! Make sure the seat belt retracts fully so that the seat belt and/or latch plate cannot get caught or pinched in the door or in the seat mechanism. This can damage the seat belt and impair the effectiveness of the seat belt, and/or cause damage to the door and/or door trim panel. Such damage is not covered by the Mercedes-Benz Limited Warranty.

Damaged seat belts must be replaced. Contact an authorized Mercedes-Benz Center.

Locking

Warning!



To prevent possible personal injury, always keep hands and fingers away from the door openings when closing the doors. Be especially careful when small children are around.

Before closing doors, make sure that there is no possibility of someone getting caught in a door during closing.

Warning!



When leaving the vehicle, always remove the SmartKey or SmartKey with KEYLESS-GO* from the starter switch, take it with you, and lock the vehicle. Do not leave children unattended in the vehicle, or with access to an unlocked vehicle. A child's unsupervised access to a vehicle could result in an accident and/or serious personal injury.

Parking and locking

- ▶ Exit the vehicle and close all doors and the trunk.

i If you hear a warning signal you have forgotten to switch off the headlamps before opening the driver's door.

In addition the message *Switch off lights* appears in the multifunction display.

Switch off the headlamps.

Locking with the SmartKey

- ▶ After exiting the vehicle, press lock button  on the SmartKey (▷ page 36).

With the trunk and all doors closed:

- All turn signal lamps flash three times.
- An acoustic signal sounds three times.
For more information, see “Factory setting” (▷ page 108).
- The locking knobs in the doors move down.

- The anti-theft alarm system is armed.

For more information, see “Locking and unlocking” (▷ page 102).

Locking with KEYLESS-GO*

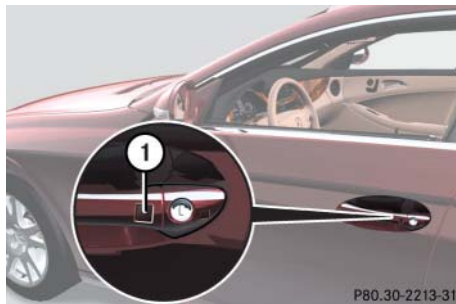

① Lock button

- ▶ After exiting the vehicle, press lock button ① at the outside door handle or on the trunk lid.

With the trunk and all doors closed:

- All turn signal lamps flash three times.
- An acoustic signal sounds three times.
For more information, see “Factory setting” (▷ page 108).
- The locking knobs in the doors move down.
- The anti-theft alarm system is armed.

For more information, see “Locking and unlocking” (▷ page 102).

Occupant safety

Panic alarm

Driving safety systems

Anti-theft systems



Occupant safety

In this section you will learn the most important facts about the restraint systems of the vehicle.

The restraint systems are

- Seat belts (▷ page 78)
- Child restraints (▷ page 84)
- Lower Anchors and Tethers for CHildren (LATCH) (▷ page 88)

Additional protection is provided by

- Supplemental Restraint System (SRS) with
 - Air bags (▷ page 66)
 - Air bag control unit (with crash sensors)
 - Emergency Tensioning Device (ETD) for seat belts (▷ page 81)
- Active head restraints (▷ page 83)
- Preventive occupant safety (PRE-SAFE®) (▷ page 82)

Air bag system components with

- Front passenger front air bag off indicator lamp (▷ page 76)
- USA only:
Front passenger seat with Occupant Classification System (OCS) (▷ page 71)
- Canada only:
Front passenger seat with BabySmart™ air bag deactivation system (▷ page 76)

Although independent systems, their protective functions work in conjunction with each other.

i For information on infants and children traveling with you in the vehicle and restraint systems for infants and children, see “Children in the vehicle” (▷ page 84).

The SRS system conducts a self-test when the ignition is switched on and in regular intervals while the engine is running. This facilitates early detection of malfunctions. The **SRS** indicator lamp in the instrument cluster lights up when the ignition is switched on and goes out no later than a few seconds after the engine has been started.

The SRS components are in operational readiness if the **SRS** indicator lamp is not lit when the engine is running.

A malfunction in the system has been detected if the **SRS** indicator lamp:

- fails to go out after approximately 4 seconds after the engine was started
- does not come on at all
- comes on after the engine was started or while driving

Warning!

Modifications to or work improperly conducted on restraint systems (such as seat belts and anchors, Emergency Tensioning Devices, seat belt force limiters or air bags) or their wiring, as well as tampering with interconnected electronic systems, can lead to the restraint systems no longer functioning as intended.

Air bags or Emergency Tensioning Devices, for example, could deploy inadvertently or fail to deploy in accidents although the deceleration threshold for air bag deployment is exceeded. Therefore, never modify the restraint systems. Do not tamper with electronic components or their software.

Warning!

In the event that the **SRS** indicator lamp comes on during driving or does not come on at all, the SRS self-check has detected a malfunction. For your safety, we strongly recommend that you visit an authorized Mercedes-Benz Center immediately to have the system checked; otherwise the SRS may not be activated when needed in an accident, which could result in serious or fatal injury, or it might deploy unexpectedly and unnecessarily which could also result in injury.

In addition, improper repair work on the SRS creates a risk of rendering the SRS inoperative or causing unintended air bag deployment. Work on the SRS must therefore only be performed by qualified technicians. Contact an authorized Mercedes-Benz Center.

If it is necessary to modify an air bag system to accommodate a person with disabilities, contact your local authorized Mercedes-Benz Center or call our Customer Assistance Center at 1-800-FOR-MERCEdes (1-800-367-6372) for details.

Occupant safety

Air bags

Warning!



Air bags are designed to reduce the potential of injury and fatality in certain frontal impacts (front air bags, driver-side knee bag), side impacts (side impact air bags and window curtain air bags) or rollovers (window curtain air bags). However, no system available today can totally eliminate injuries and fatalities.

The activation of the air bags temporarily releases a small amount of dust from the air bags. This dust, however, is neither injurious to your health, nor does it indicate a fire in the vehicle. The dust might cause some temporary breathing difficulty for people with asthma or other breathing trouble. To avoid this, you may wish to get out of the vehicle as soon as it is safe to do so. If you have any breathing difficulty but cannot get out of the vehicle after the air bag inflates, then get fresh air by opening a window or door.

Warning!



To reduce the risk of injury when the front air bags inflate, it is very important for the driver and front passenger to always be in a properly seated position and to wear their respective seat belts.

For maximum protection in the event of a collision always be in normal seated position with your back against the backrest. Fasten your seat belt and make sure that it is properly positioned on your body.

Since the air bag inflates with considerable speed and force, a proper seating and hands on steering wheel position will help to keep you at a safe distance from the air bag. Occupants who are unbelted, out of position or too close to the air bag can be seriously injured or killed by an air bag as it inflates with great force in the blink of an eye:

- Sit properly belted in an upright position with your back against the seat backrest.

- Adjust the driver seat as far as possible rearward, still permitting proper operation of vehicle controls. The distance from the center of the driver's breastbone to the center of the air bag cover on the steering wheel must be at least 10 in (25 cm) or more. You should be able to accomplish this by a combination of adjustments to the seat and steering wheel. If you have any problems, please contact your authorized Mercedes-Benz Center.
- Do not lean with your head or chest close to the steering wheel or dashboard.
- Keep hands on the outside of steering wheel rim. Placing hands and arms inside the rim can increase the risk and potential severity of hand/arm injury when driver front air bag inflates.
- Adjust the front passenger seat as far as possible rearward from the dashboard when the seat is occupied.

- Occupants, especially children, should never place their bodies or lean their heads in the area of the door where the side impact air bag inflates. This could result in serious injuries or death should the air bag be triggered. Always sit nearly upright, properly use the seat belts and use an appropriately sized infant restraint, toddler restraint, or booster seat recommended for the size and weight of the child.
- Canada only: Children 12 years old and under must never ride in the front seat, except in a Mercedes-Benz authorized BabySmart™ compatible child seat, which operates with the BabySmart™ system installed in the vehicle to deactivate the front passenger front air bag when it is properly installed. Otherwise they will be struck by the air bag when it inflates in a crash. If this happens, serious or fatal injury will result.

Failure to follow these instructions can result in severe injuries to you or other occupants.

If you sell your vehicle, it is important that you make the buyer aware of this safety information. Be sure to give the buyer this Operator's Manual.

Warning!



Accident research shows that the safest place for children in an automobile is in the rear seat.

It should be noted that with respect to both front and rear side impact air bags there is a possibility for a side impact air bag related injury if occupants, especially children, are not properly seated or restrained when next to a side impact air bag which needs to deploy rapidly in a side impact in order to do its job.

To help avoid the possibility of injury, please follow these guidelines:

- (1) Occupants, especially children, should never place their bodies or lean their heads in the area of the door where the side impact air bag inflates. This could result in serious injuries or death should the side impact air bag be deployed.
- (2) Always sit as upright as possible, properly use the seat belts, and for children 12 years old and under, use an appropriately sized infant restraint, toddler restraint, or booster seat recommended for the size and weight of the child.
- (3) Always wear seat belts properly.

If you believe that, even with the use of these guidelines, it would be safer for your rear seat occupants to have the rear mounted side impact air bags deactivated, then deactivation can be accomplished upon your written request to do so at your authorized Mercedes-Benz Center at an additional cost. Please contact your local authorized Mercedes-Benz Center or call our Customer Assistance Center at 1-800-FOR-MERCEdes (1-800-367-6372) for details.

Occupant safety

i Air bags are designed to activate only in certain frontal impacts (front air bags, driver-side knee bag), side impacts (side impact and window curtain air bags) which exceed preset thresholds and in certain rollovers (window curtain air bags). Only during these events will they provide their supplemental protection.

The driver and passenger should always wear their seat belts. Otherwise it is not possible for the air bags to provide their supplemental protection.

In case of other types of impacts and impacts below air bag deployment thresholds, air bags will not be deployed. The driver and passenger will then be protected to the extent possible by a properly fastened seat belt. A properly fastened seat belt is also needed to provide the best protection in a rollover.

We caution you not to rely on the presence of the air bags in order to avoid wearing your seat belt.

It is important to your safety and that of your passengers that you replace deployed air bags and repair any malfunctioning air bags to make sure that the vehicle will continue to provide supplemental crash protection for occupants.

Safety guidelines for the seat belt, Emergency Tensioning Device and air bag

Warning!



- Damaged seat belts or belts that were highly stressed in an accident must be replaced and their anchoring points must also be checked. Use only belts installed or supplied by an authorized Mercedes-Benz Center.
 - Air bags and Emergency Tensioning Devices (ETDs) are designed to function on a one-time-only basis. An air bag or ETD that was activated must be replaced.
 - No modifications of any kind may be made to any components or wiring of the SRS. This includes changing or removing any component or part of the SRS, the installation of additional trim material, badges etc. over the steering wheel hub, front passenger front air bag cover, outboard sides of the front seat backrests, door trim panels,
- or door frame trims, and installation of additional electrical/electronic equipment on or near SRS components and wiring. Keep area between air bags and occupants free from objects (e.g. packages, purses, umbrellas, etc.).
- Do not pass belts over sharp edges. They could tear.
 - Do not make any modification that could change the effectiveness of the belts.
 - Do not bleach or dye seat belts as this may severely weaken them. In a crash they may not be able to provide adequate protection.
 - Do not hang items such as coat hangers from the coat hooks or handles over the door. These items may turn into projectiles and cause head and other injuries when the window curtain air bag is deployed.
 - Never place your feet on the instrument panel, dashboard, or on the seat. Always keep both feet on the floor in front of the seat.

- Air bag system components will be hot after an air bag has inflated. Do not touch.
- In addition, improper repair work on the SRS creates a risk of rendering the SRS inoperative or causing unintended air bag deployment. Work on the SRS must therefore only be performed by qualified technicians. Contact an authorized Mercedes-Benz Center.
- For your protection and the protection of others, when scrapping the air bag unit or Emergency Tensioning Device, our safety instructions must be followed. These instructions are available from your authorized Mercedes-Benz Center.
- Given the considerable deployment speed, required inflation volume, and the textile structure of the air bags, there is the possibility of abrasions or other, potentially more serious injuries resulting from air bag deployment.

Warning!



Only use seat covers which have been tested and approved by Mercedes-Benz for your vehicle model. Using other seat covers may interfere with or prevent the deployment of the side impact air bags. Contact your authorized Mercedes-Benz Center for availability.

When you sell your vehicle we strongly urge you to give notice to the subsequent owner that it is equipped with an SRS by alerting them to the applicable section in the Operator's Manual.

Front air bags



- ① Driver's air bag
- ② Passenger air bag
- ③ Knee bag

Driver and passenger air bags are deployed:

- in the event of certain frontal impacts
- if impact exceeds a preset deployment threshold
- independently of the side impact air bags

Occupant safety

i The front air bags in this vehicle have been designed to inflate in two stages. This allows the air bag to have different rates of inflation that are based on the rate of vehicle deceleration as assessed by the air bag control unit.

USA only:

On the front passenger side, the front air bag deployment is additionally influenced by the passenger's weight category as identified by the Occupant Classification System (OCS) (▷ page 71).

USA only:

The lighter the front passenger side occupant, the higher the vehicle deceleration rate required for the second stage inflation of the air bag.

The air bags will not deploy in impacts which do not exceed the system's deployment thresholds. You will then be protected by the fastened seat belts.

The front passenger air bag will only be deployed if:

- the front passenger seat is occupied
- the **PASS AIR BAG OFF**  indicator lamp in the center console is not lit (▷ page 76)
- the impact exceeds a preset deployment threshold

! Canada only:

Do not place objects heavier than 20 lb (9 kg) on the front passenger seat. This could cause the front or side impact air bag on the front passenger side to deploy in a crash which exceeds the system's deployment threshold.

Knee bag

The knee bag is located on the driver-side lower instrument panel. It is designed to operate together with the driver air bag in certain frontal impacts exceeding a preset threshold. The knee bag operates best in conjunction with a properly positioned and fastened seat belt.

Side impact air bags, window curtain air bags

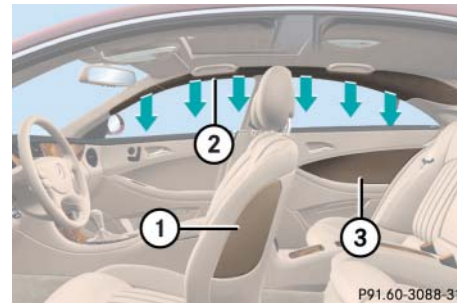

- ① Front side impact air bags
- ② Window curtain air bag
- ③ Rear side impact air bags

The side impact air bags and window curtain air bags are deployed:

- on the impacted side of the vehicle
- in impacts exceeding a preset deployment threshold
- independently of the front air bags

In addition, the window curtain air bags ② are deployed:

- in certain vehicle rollovers

The side impact air bags and window curtain air bags are not deployed in impacts which do not exceed the system's deployment threshold.

Occupant Classification System (USA only)

The Occupant Classification System (OCS) automatically turns the front passenger front air bag on or off based on the classified occupant weight category determined by weight sensor readings from the front passenger seat.

i *The system does not deactivate the front passenger side impact air bag, the window curtain air bag and the Emergency Tensioning Device.*

Occupants must sit properly belted in a position that is as upright as possible with their back against the seat backrest and feet on the floor to be correctly classified. If the occupant's weight is transferred to another object in the vehicle (e.g. by leaning on armrests), the OCS may not be able to properly approximate the occupant's weight category.

Furthermore, the occupant weight may appear to increase or decrease due to objects hanging on the seat, other passengers pushing on the seat, objects lodged underneath the seat or stuffed between seat and middle console or between seat and door or due to objects applying pressure on the back of the seat. Always make sure that the seat has clearance in all directions at all times.

i *If your seat, including your trim cover and cushion needs to be serviced in any way, take the vehicle to your authorized Mercedes-Benz Center.*

Only seat accessories approved by Mercedes-Benz may be used.

Both driver and the front passenger should always use the **PASS AIR BAG OFF**  indicator lamp as an indication of whether or not the front passenger is properly positioned.

Occupant safety

Warning!





If the **PASS AIR BAG OFF**  indicator lamp illuminates when an adult or someone larger than a small individual is in the front passenger seat, have the front passenger re-position himself or herself in the seat until the



PASS AIR BAG OFF  indicator lamp goes out, or check whether objects are caught under or around the seat.

More information about air bag display messages (▷ page 362).

In the event of a collision, the air bag control unit will not allow front passenger front air bag deployment when the OCS classified the front passenger seat occupant as being up to or less than the weight of a typical 12-month-old child in a standard child restraint or if the front passenger seat is sensed as being empty.

When the OCS senses that the front passenger seat occupant is classified as being up to or less than the weight of a typical 12-month-old child in a standard child restraint, the **PASS AIR BAG OFF**  indicator lamp will illuminate when the engine is started and remain illuminated, indicating that the front passenger front air bag is deactivated.

When the OCS senses that the front passenger seat is classified as being empty, the **PASS AIR BAG OFF**  indicator lamp will illuminate when the engine is started and remain illuminated, indicating that the front passenger front air bag is deactivated.

When the OCS senses that the front passenger seat occupant is classified as being heavier than the weight of a typical 12-month-old child seated in a standard child restraint or as being a small individual (such as a young teenager or a small adult), the **PASS AIR BAG OFF**  indicator lamp will illuminate for approximately 6 seconds when the engine is started and then, depending on occupant weight sensor readings from the seat, remain illuminated or go out. With the **PASS AIR BAG OFF**  indicator lamp illuminated, the front passenger front air bag is deactivated. With the **PASS AIR BAG OFF**  indicator lamp out, the front passenger front air bag is activated.

When the OCS senses that the front passenger seat occupant is classified as an adult or someone larger than a small individual, the **PASS AIR BAG OFF**  indicator lamp will illuminate for approximately 6 seconds when the engine is started and then go out, indicating that the front passenger front air bag is activated.

If the **PASS AIR BAG OFF**  indicator lamp is illuminated, the front passenger front air bag is deactivated and will not be deployed.

If the **PASS AIR BAG OFF**  indicator lamp is not illuminated, the front passenger front air bag is activated and will be deployed:

- in the event of certain frontal impacts
- if impact exceeds a preset deployment threshold
- independently of the side impact air bags

If the front passenger front air bag is deployed, the rate of inflation will be influenced by:

- the rate of relevant vehicle deceleration as assessed by the air bag control unit
- front passenger's weight category as identified by the Occupant Classification System (OCS)

Warning!



According to accident statistics, children are safer when properly restrained in the rear seating positions than in the front seating position. Thus, we strongly recommend that children be placed in the rear seats whenever possible. Regardless of seating position, children 12 years old and under must be seated and properly secured in an appropriate infant or child restraint recommended for the size and weight of the child.

The infant or child restraint must be properly secured with the vehicle's seat belt, the seat belt and top tether strap, or lower anchors and top tether strap, fully in accordance with the child seat manufacturer's instructions.

Always sit nearly upright, properly use the seat belts and for children 12 years old and under, use an appropriately sized infant restraint, toddler restraint, or booster seat recommended for the size and weight of the child.

Children can be killed or seriously injured by an inflating air bag. Note the following important information when circumstances require you to place a child in the front passenger seat:

- Your vehicle is equipped with air bag technology designed to turn off the front passenger front air bag in your vehicle when the system senses the weight of a typical 12-month-old child or less along with the weight of a standard appropriate child restraint on the front passenger seat.
- A child in a rear-facing child restraint on the front passenger seat will be seriously injured or even killed if the front passenger front air bag inflates in a collision which could occur under some circumstances, even with the air bag technology installed in your vehicle. The only means to completely eliminate this risk is to never place a child in a rear-facing child restraint in the front seat. We therefore strongly recommend that you always place a child in a rear-facing child restraint in the back seat.



Occupant safety



- If you must install a rear-facing child restraint on the front passenger seat because circumstances require you to do so, make sure that the

PASS AIR BAG OFF



indicator lamp is illuminated, indicating that the front passenger front air bag is deactivated. Should the indicator lamp not illuminate or go out while the restraint is installed, please check installation. Periodically check the indicator lamp while driving to make sure the lamp is illuminated. If the

PASS AIR BAG OFF



indicator lamp goes out or remains out, do not transport a child on the front passenger seat until the system has been repaired. A child in a rear-facing child restraint on the front passenger seat will be seriously injured or even killed if the front passenger front air bag inflates.

- If you have to place a child in a forward-facing child restraint on the front passenger seat, move the seat as far back as possible, use the proper child restraint recommended for the age, size and weight of the child, and secure child restraint with the vehicle's seat belt according to the child seat manufacturer's instructions. For children larger than the typical 12-month-old child, the front passenger front air bag may or may not be activated (▷ page 72).

i Deployment of the driver front air bag does not mean that the front passenger front air bag also should have deployed.

The Occupant Classification System (▷ page 71) may have determined:

- that the seat was empty or occupied by the weight up to or less than that of a typical 12-month-old child seated in a standard child restraint - both instances where the system suppresses deployment of the front passenger front air bag even though the impact met the criteria and was of sufficient severity to deploy the driver front air bag
- that the seat was occupied by a small individual (such as a young teenager or a small adult) or a child weighing more than the weight of a typical 12-month-old child in a standard child restraint - instances where the system may suppress deployment of the front passenger front air bag even though the impact met the criteria and was of sufficient severity to deploy the driver front air bag

The **PASS AIR BAG OFF**  indicator lamp is located in the center console.



① Indicator lamp

The **PASS AIR BAG OFF**  indicator lamp ① will be illuminated, except with the SmartKey removed or in starter switch position **0** (▷ page 38).

Warning!



If the **SRS** indicator lamp and the **PASS AIR BAG OFF**  indicator lamp are lit at the same time, there is a malfunction in the Occupant Classification System. The front passenger front air bag will be deactivated in this case.



In order to ensure proper operation of the air bag system and OCS:

- Have the system checked as soon as possible by qualified technicians. Contact an authorized Mercedes-Benz Center.
- Do not place more than 4.4 lb (2 kg) into the ruffled storage bag on the back of the front passenger seat. Otherwise, the OCS may not be able to properly approximate the occupant weight category.

- Do not place objects under and/or around the front passenger seat.
- Do not hang anything from or attach any items to the seats.
- Do not stuff objects such as books between the middle console and the front passenger seat.
- Do not move the front passenger seat backwards against stiff objects.
- Sit properly belted in a nearly upright position with your back against the seat backrest.
- Do not lean on the armrests or lift yourself from the seat by using the handle over the door as this may cause the OCS to be unable to correctly approximate the occupant weight category.
- Only have the seat repaired or replaced by an authorized Mercedes-Benz Center.
- Read and observe all warnings in this chapter.

Occupant safety

Self-test Occupant Classification System (USA only)

After turning the SmartKey in the starter switch to position **1** or **2** or pressing the KEYLESS-GO* start/stop button once or twice, the **PASS AIR BAG OFF**  indicator lamp located in the center console illuminates. If an adult occupant is properly sitting on the front passenger seat and the system senses the occupant as being an adult, the **PASS AIR BAG OFF**  indicator lamp will illuminate and go out after approximately 6 seconds.

If the seat is not occupied and the system senses the front passenger seat as being empty, the **PASS AIR BAG OFF**  indicator lamp will illuminate and not go out.

Warning!



If the **PASS AIR BAG OFF**  indicator lamp should not illuminate, the system is not functioning. You must see an authorized Mercedes-Benz Center before seating any child on the front passenger seat.

For more information, see the “Practical hints” section (▷ page 353).

Warning!



Never place anything between seat cushion and child seat (e.g. pillow), since it reduces the effectiveness of the Occupant Classification System. The bottom of the child seat must make full contact with the passenger seat cushion. An incorrectly mounted child seat could cause injuries to the child in case of an accident, instead of increasing protection for the child.

Follow the manufacturer's instructions for installation of child seats.

BabySmart™ air bag deactivation system (Canada only)



① **PASS AIR BAG OFF**  indicator lamp

Special BabySmart™ compatible child seats, designed for use with the Mercedes-Benz system and available at any authorized Mercedes-Benz Center, are required for use with the BabySmart™ air bag deactivation system. With the special child seat properly installed, the front passenger front air bag will not deploy.

The **PASS AIR BAG OFF**  indicator lamp located in the center console will be illuminated, except with the SmartKey removed or in starter switch position **0**.

i *The system does not deactivate the side impact air bag, the window curtain air bag and the Emergency Tensioning Device.*

Self-test BabySmart™ without special child seat installed (Canada only)

After turning the SmartKey in the starter switch to position **1** or **2** or pressing the KEYLESS-GO* start/stop button once or twice, the **PASS AIR BAG OFF**  indicator lamp located in the center console comes on for approximately 6 seconds and then goes out.

If the **PASS AIR BAG OFF**  indicator lamp should not come on or is continuously lit, the system is not functioning. You must see an authorized Mercedes-Benz Center before seating any child on the passenger seat.

More information can be found in the “Practical hints” section (▷ page 355).

Warning!



The BabySmart™ air bag deactivation system will **ONLY** work with a special child seat designed to operate with it. It will not work with child seats which are not BabySmart™ compatible.

Never place anything between seat cushion and child seat (e.g. pillow), since it reduces the effectiveness of the deactivation system. The bottom of the child seat must make full contact with the passenger seat cushion. An incorrectly mounted child seat could cause injuries to the child in case of an accident, instead of protecting the child.

Follow the manufacturer’s instructions for installation of special child seats.

Warning!



When using a BabySmart™ compatible child seat on the front passenger seat, the front passenger front air bag will not deploy only if the **PASS AIR BAG OFF**  indicator lamp remains illuminated.

Please be sure to check the indicator every time you use the special system child seat. Should the indicator lamp go out while the restraint is installed, please check installation. If the indicator lamp remains out, do not use the BabySmart™ restraint to transport children on the front passenger seat until the system has been repaired.

Occupant safety

Warning!



Do not place powered-on laptops, cell phones, electronic tags such as those used in ski passes and like electronic devices on the front passenger seat. Signals from such devices may interfere with the BabySmart™ system. Such signal interference may cause the  indicator lamp not to come on during self-test or be continuously lit, indicating that the system is not functioning.

Seat belts

The use of seat belts and infant and child restraint systems is required by law in all 50 states, the District of Columbia, the U.S. territories and all Canadian provinces.

Even where this is not the case, all vehicle occupants should have their seat belts fastened whenever the vehicle is in motion.

For more information, see “Fastening the seat belts” (▷ page 48).

 *For information on infants and children traveling with you in the vehicle and restraint systems for infants and children, see “Children in the vehicle” (▷ page 84).*

Warning!



Always fasten your seat belt before driving off. Always make sure all of your passengers are properly restrained, even those sitting in the rear.

Failure to wear and properly fasten and position your seat belt greatly increases your risk of injuries and their likely severity in an accident. You and your passengers should always wear seat belts.

If you are ever in an accident, your injuries can be considerably more severe without your seat belt properly buckled. Without your seat belt buckled, you are much more likely to hit the interior of the vehicle or be ejected from it. You can be seriously injured or killed.

In the same crash, the possibility of injury or death is lessened if you are properly wearing your seat belt. Air bags can only protect as they are designed if the occupants are properly wearing their seat belts.

Warning!

Never ride in a moving vehicle with the seat backrest in an excessively reclined position as this can be dangerous. You could slide under the seat belt in a collision. If you slide under it, the belt would apply force at the abdomen or neck. That could cause serious or even fatal injuries. The seat backrest and seat belt provide the best restraint when the wearer is in a nearly upright position and the belt is properly positioned on the body.

Warning!

Never let more people ride in the vehicle than there are seat belts available. Be sure everyone riding in the vehicle is correctly restrained with a separate seat belt. Never use a seat belt for more than one person at a time.

Warning!

Damaged seat belts or belts that were highly stressed in an accident must be replaced and their anchoring points must also be checked.

Only use seat belts which have been approved by Mercedes-Benz.

Do not make any modifications to the seat belts. This can lead to unintended activation or to failure.

Do not bleach or dye seat belts as this may severely weaken them. In a crash they may not be able to provide adequate protection.

Have all work carried out only by qualified technicians. Contact an authorized Mercedes-Benz Center.

Warning!**USE SEAT BELTS PROPERLY**

- Seat belts can only work when used properly. Never wear seat belts in any other way than as described in this section, as that could result in serious injuries in case of an accident.
- Each occupant should wear their seat belt at all times, because seat belts help reduce the likelihood of and potential severity of injuries in accidents, including rollovers. The integrated restraint system includes SRS (driver's front air bag, driver-side knee bag, front passenger front air bag, side impact air bags, window curtain air bags for side windows), ETB (seat belt Emergency Tensioning Device), and front seat knee bolsters.



Occupant safety



The system is designed to enhance the protection offered to properly belted occupants in certain frontal (front air bags, driver-side knee bag and ETD) and side (side impact and window curtain air bags and ETD) impacts which exceed preset deployment thresholds and in certain rollovers (window curtain air bags and ETD).

- Never wear the shoulder belt under your arm, against your neck or off your shoulder. In a frontal crash, your body would move too far forward. That would increase the chance of head and neck injuries. The seat belt would also apply too much force to the ribs or abdomen, which could severely injure internal organs such as your liver or spleen.



- Never wear seat belts over rigid or breakable objects in or on your clothing, such as eyeglasses, pens, SmartKeys etc., as these might cause injuries.
- Position the lap belt as low as possible on your hips and not across the abdomen. If the seat belt is positioned across your abdomen, it could cause serious injuries in a crash.
- Never use a seat belt for more than one person at a time. Do not fasten a seat belt around a person and another person or other objects.
- Seat belts should not be worn twisted. In a crash, you wouldn't have the full width of the seat belt to distribute impact forces. The twisted seat belt against your body could cause injuries.

- Pregnant women should also always use a lap-shoulder seat belt. The lap belt portion should be positioned as low as possible on the hips to avoid any possible pressure on the abdomen.
- Never place your feet on the instrument panel, dashboard, or on the seat. Always keep both feet on the floor in front of the seat.
- When using a seat belt to secure infant or toddler restraints or children in booster seats, always follow the child seat manufacturer's instructions.

When the engine is started, the seat belt telltale  will always illuminate for 6 seconds to remind you and your passengers to fasten your seat belts.

If the driver's seat belt is not fastened when the engine is started, an additional warning chime will also sound for a maximum of 6 seconds or until the driver's seat belt is fastened.

If after these 6 seconds the driver's or the front passenger's seat belt (with the front passenger seat occupied) is not fastened with front doors closed,

- the seat belt telltale  remains illuminated for as long as either the driver's or front passenger's seat belt is not fastened.
- and if the vehicle speed once exceeds 15 mph (25 km/h), the seat belt telltale  starts flashing and a warning chime sounds with increasing intensity for a maximum of 60 seconds or until the driver's and the front passenger's seat belt are fastened.

If the driver's or the front passenger's seat belt remains unfastened after 60 seconds, the warning chime stops sounding, the seat belt telltale  stops flashing but continues to be illuminated.

The seat belt telltale  will only go out if both the driver's and front passenger's seat belt (with the front passenger seat occupied) are fastened, or the vehicle is standing still and a front door is opened.

For more information, see “Practical hints” (▷ page 348).

Emergency Tensioning Device (ETD), seat belt force limiter

The seat belts for the front and rear outer seats are equipped with Emergency Tensioning Devices and belt force limiters.

The ETD is designed to activate in the following cases:

- in frontal or rear-end impacts exceeding the system deployment threshold
- in certain vehicle rollovers
- if the restraint systems are operational and functioning correctly, see  indicator lamp (▷ page 64)

 *The ETDs for the front seats will only activate if the front seat belts are fastened (latch plate properly inserted into buckle).*

The ETDs for the rear outer seats will activate with or without the respective seat belts fastened.

In an impact, Emergency Tensioning Devices remove slack from the seat belts. Seat belt force limiters reduce the peak force exerted by the seat belts on occupants during a crash.

Warning!



An Emergency Tensioning Device (ETD) that was activated must be replaced.

When disposing of the Emergency Tensioning Device, our safety instructions must be followed. These are available at your authorized Mercedes-Benz Center.

Occupant safety

Automatic comfort-fit feature seat belt

An automatic comfort-fit feature for front seats reduces the retracting force of the seat belts when they are in normal use.

Preventive occupant safety (PRE-SAFE®)

Warning!



The PRE-SAFE® system is intended to reduce the effects of a crash on properly seat-belted vehicle occupants. Despite having the PRE-SAFE® system in your vehicle, the possibility of injuries occurring as a result of an accident cannot be eliminated. Therefore, you should always drive carefully and adjust your driving to the prevailing road, weather, and traffic conditions.

Your vehicle automatically takes preventive measures to better protect the occupants in the following hazardous situations:

- You execute an emergency braking maneuver and the Brake Assist System (▷ page 92) is activated.
- The PRE-SAFE® system detects a critical driving dynamics situation.

In such cases, the following systems are automatically activated:

- The front seat belts are pre-tensioned electrically.
- If the vehicle is in a severe skid or is spinning, the door windows and the tilt/sliding sunroof close until a small gap remains.

i *If the closing procedure of the tilt/sliding sunroof or door window is blocked, the tilt/sliding sunroof or door window will stop and open slightly.*

Vehicles with front passenger seat memory function*:

- If the seat is in an unfavorable position, it will be adjusted to a better position.

i *The PRE-SAFE® system is activated in the previously described circumstances only at speeds exceeding 20 mph (30 km/h).*

When the critical driving dynamic situation has passed without an accident occurring, the pre-tensioning on the seat belts is deactivated.

You can then adjust the seat, the door windows and the tilt/sliding sunroof to their previous position.

If the seat belts do not release:

- ▶ Adjust the backrest or seat slightly to the rear until the seat belt tension is diminished.

The locking mechanism releases.

Active head restraints

The active head restraints offer the driver's and front passenger increased protection from whiplash type injuries. In the event of a rear-end collision, the active head restraints on the driver's and front passenger's seats are designed to move forward in the direction of travel, providing the head with increased support earlier on in the collision sequence. The active head restraints move forward whether the seat is occupied or not.

Warning!



Do not attach any objects (e.g. hangers) to the head restraint posts. Otherwise, the active head restraints may not be able to function properly or offer the intended degree of protection in the event of a collision.

For information on resetting the activated active head restraints, see "Resetting activated head restraints" (▷ page 401).

You cannot remove the active head restraint on the driver's and front passenger's seat.

For removal of the active head restraints we recommend that you contact an authorized Mercedes-Benz Center.

Warning!



Only use seat or head restraint covers which have been tested and approved by Mercedes-Benz for your vehicle model. Using other seat or head restraint covers may interfere with or prevent the activation of active head restraint. Contact your authorized Mercedes-Benz Center for availability.

Warning!



For your protection, drive only with properly positioned head restraints.

Adjust head restraints so that it is as close to the head as possible and the center of the head restraint supports the back of the head at eye level. This will reduce the potential for injury to the head and neck in the event of an accident or similar situation.

Do not drive the vehicle without the seat head restraints. Head restraints are intended to help reduce injuries during an accident.

For information on head restraint adjustment, see "Seats" (▷ page 41).

Occupant safety

Children in the vehicle

If an infant or child is traveling with you in the vehicle:

- ▶ Secure the child using an infant or child restraint appropriate to the age and size of the child.
- ▶ Make sure that the infant or child is properly secured at all times while the vehicle is in motion.

Infant and child restraint seats and information on choosing an appropriate restraint system can be obtained from any Mercedes-Benz Center.

Warning!



Do not leave children unattended in the vehicle, even if they are secured in a child restraint system. The children could

- injure themselves on parts of the vehicle
- be seriously or fatally injured through exposure to extreme heat or cold

Do not expose the child restraint system to direct sunlight. The child restraint system's metal parts, for example, could become very hot, and the child could be burned on these parts.

If children open a door, they could

- injure other persons
- get out of the car and injure themselves or be injured by following traffic

Do not carry heavy or hard objects in the passenger or cargo compartment unless they are firmly secured in place. For more information, see "Loading" (▷ page 239) and "Useful features" (▷ page 244).

Unsecured or improperly positioned cargo increases a child's risk of injury in the event of

- strong braking maneuvers
- sudden changes of direction
- an accident

Infant and child restraint systems

We recommend all infants and children be properly restrained at all times while the vehicle is in motion.

Canada only:

Use only a BabySmart™ compatible child restraint for the front passenger seat in this vehicle.

All lap-shoulder belts except the driver's seat belt have special seat belt retractors for secure fastening of child restraints.

To fasten a child restraint, follow child restraint instructions for mounting. Then pull the shoulder belt out completely and let it retract. During seat belt retraction, a ratcheting sound can be heard to indicate that the special seat belt retractor is activated. The seat belt is now locked. Push down on child restraint to take up any slack.

To deactivate, release seat belt buckle and let seat belt retract completely. The seat belt can again be used in the usual manner.

Warning!

Never release the seat belt buckle while the vehicle is in motion, since the special seat belt retractor will be deactivated.

i *Information on child seats with mounting fittings for tether anchorages (▷ page 87).*

For information on LATCH-type child seat mounts (▷ page 88).

The use of infant or child restraints is required by law in all 50 states, the District of Columbia, the U.S. territories and all Canadian provinces.

Infants and small children should be seated in an appropriate infant or child restraint system properly secured in accordance with the manufacturer's instructions for the child restraint, that complies with U.S. Federal Motor Vehicle Safety Standards 213 and 225 and Canadian Motor Vehicle Safety Standards 213 and 210.2.

A statement by the child restraint manufacturer of compliance with these standards can be found on the instruction label on the restraint and in the instruction manual provided with the restraint.

When using any infant or child restraint system, be sure to carefully read and follow all manufacturer's instructions for installation and use.

Please read and observe warning labels affixed to the inside of the vehicle and to infant or child restraints.

Warning!

Canada only: Children 12 years old and under must never ride in the front seat, except in a Mercedes-Benz authorized BabySmart™ compatible child seat, which operates with the BabySmart™ system installed in the vehicle to deactivate the front passenger front air bag when it is properly installed. Otherwise they will be struck by the air bag when it inflates in a crash. If this happens, serious or fatal injury will result.

According to accident statistics, children are safer when properly restrained in the rear seating positions than in the front seating position. Thus, we strongly recommend that children be placed in the rear seats whenever possible. Regardless of seating position, children 12 years old and under must be seated and properly secured in an appropriately sized infant restraint, toddler restraint, or booster seat recommended for the size and weight of the child.

The infant or child restraint must be properly secured with the vehicle's seat belt, the seat belt and top tether strap, or lower anchors and top tether strap, fully in accordance with the child seat manufacturer's instructions.

Always sit nearly upright, properly use the seat belts and use an appropriately sized infant restraint, toddler restraint, or booster seat recommended for the size and weight of the child.



Occupant safety







Children can be killed or seriously injured by an inflating air bag. Note the following important information when circumstances require you to place a child in the front passenger seat:

- USA only: Your vehicle is equipped with air bag technology designed to turn off the front passenger front air bag in your vehicle when the OCS senses the weight of a typical 12-month-old child or less along with the weight of a standard appropriate child restraint on the front passenger seat.

- A child in a rear-facing child restraint on the front passenger seat will be seriously injured or even killed if the front passenger front air bag inflates in a collision which could occur under some circumstances, even with the air bag technology installed in your vehicle.

The only means to completely eliminate this risk is to never place a child in a rear-facing child restraint in the front seat. We therefore strongly recommend that you always place a child in a rear-facing child restraint in the back seat.

- If you must install a rear-facing child restraint on the front passenger seat because circumstances require you to do so, make sure that the  **PASS AIR BAG OFF** indicator lamp is illuminated, indicating that the front passenger front air bag is deactivated. Should the  **PASS AIR BAG OFF** indicator lamp not illuminate or go out while the restraint is installed, please check installation. Periodically check the  **PASS AIR BAG OFF** indicator lamp while driving to make sure the lamp is illuminated.

If the  **PASS AIR BAG OFF** indicator lamp goes out or remains out, do not transport a child on the front passenger seat until the system has been repaired.

A child in a rear-facing child restraint on the front passenger seat will be seriously injured or even killed if the front passenger front air bag inflates.

- If you have to place a child in a forward-facing child restraint on the front passenger seat, move the seat as far back as possible, use the proper child restraint recommended for the age, size and weight of the child, and secure child restraint with the vehicle's seat belt according to the child seat manufacturer's instructions. For children larger than the typical 12-month-old child, the front passenger front air bag may or may not be activated (> page 72).

Warning!

Infants and small children should never share a seat belt with another occupant. During an accident, they could be crushed between the occupant and seat belt.

A child's risk of serious or fatal injuries is significantly increased if the child restraints are not properly secured in the vehicle and/or the child is not properly secured in the child restraint.

Children too big for a toddler restraint must ride in seats using regular seat belts. Position shoulder belt across chest and shoulder, not face or neck. A booster seat may be necessary to achieve proper belt positioning for children over 41 lb until they reach a height where a lap/shoulder belt fits properly without a booster.

When the child restraint is not in use, remove it from the vehicle or secure it with the seat belt to prevent the child restraint from becoming a projectile in the event of an accident.

Do not leave children unattended in the vehicle, even if the children are secured in a child restraint system. Unsupervised children in a child restraint system may use vehicle equipment and may cause an accident and/or serious personal injury.

Installation of infant and child restraint systems

This vehicle is equipped with tether anchorages for a top tether strap at each of the rear seating positions.



① Cover

- ▶ Remove cover ① from anchorage ring.
- ▶ Store cover ① in a convenient place (e.g. glove box).
- ▶ Guide tether strap between head restraint and top of the seat back.

Head restraint must be positioned such that the top tether strap can pass freely between the head restraint and the top of the seat back.

Make sure the tether strap is not twisted.



Occupant safety

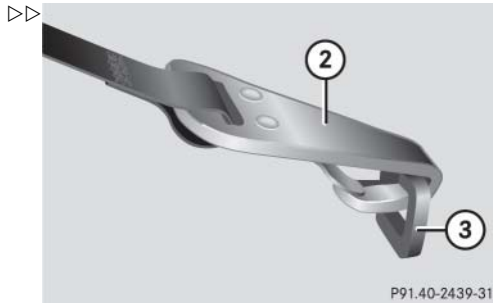

- ② Hook
- ③ Anchorage ring

- ▶ Securely fasten the hook ② to the anchorage ring ③.

i For safety, make sure the hook ② has attached to the ring ③ beyond the safety catch, as illustrated.

Once the top tether anchorage hook is attached, the child restraint itself can be secured. Tighten the top tether strap according to the child restraint manufacturer's instructions.

Child seat anchors – LATCH type

This vehicle is equipped with two LATCH (Lower Anchors and Tethers for Children) type anchors (at each of the rear seats) for the installation of a “LATCH” child seat with the matching mounting fittings.

The anchors are located behind an upholstery blend.

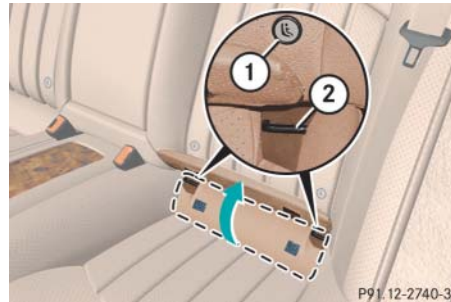

- ① Indicates the position of the anchors
- ② Anchors

- ▶ Lift upholstery blend up to access the anchors.
- ▶ Install child seat according to the manufacturer's instructions.

i Non-LATCH type child seats may also be used and can be installed using the vehicle's seat belt system. Install child seat according to the manufacturer's instructions.

Warning!



Children too big for a toddler restraint must ride in seats using regular seat belts. Position shoulder belt across chest and shoulder, not face or neck. A booster seat may be necessary to achieve proper seat belt positioning for children over 41 lb until they reach a height where a lap/shoulder belt fits properly without a booster.

Install child seat according to manufacturer's instructions.

The child seat must be firmly attached to the right and left side anchors ②.

An incorrectly mounted child seat may come loose during an accident which could result in serious personal injury or death to the child.

Damaged or impact damaged child seats or child seat mounting fittings must be replaced.

Do not leave children unattended in the vehicle, even if the children are secured in a child restraint system.

Blocking of rear door window operation

You can disable select functions in the rear passenger compartment for added safety (for instance when you have children riding in the rear passenger compartment).

You can disable the following functions in the rear passenger compartment:

- rear door windows operation
- 12-V power outlet in the rear center console



- ① Override switch
- ② Indicator lamp

► Press override switch ①.

Indicator lamp ② comes on. The functions in the rear are disabled.

i Operation of the rear door windows with the switches located on the door control panel of the driver's door is still possible.

Warning!



Activate the override switch when children are riding in the back seats of the vehicle. The children may otherwise injure themselves, e.g. by becoming trapped in the window opening.

When leaving the vehicle, always remove the SmartKey or SmartKey with KEYLESS-GO* from the starter switch, take it with you, and lock the vehicle. Do not leave children unattended in the vehicle, or with access to an unlocked vehicle. A child's unsupervised access to a vehicle could result in an accident and/or serious personal injury.

Panic alarm



① **PANIC** button

i USA only:

This device complies with Part 15 of the FCC Rules. Operation is subject to the following two conditions:

- (1) This device may not cause harmful interference, and*
- (2) this device must accept any interference received, including interference that may cause undesired operation.*

Any unauthorized modification to this device could void the user's authority to operate the equipment.

i Canada only:

This device complies with RSS-210 of Industry Canada. Operation is subject to the following two conditions:

- (1) This device may not cause interference, and*
- (2) this device must accept any interference received, including interference that may cause undesired operation of the device.*

Any unauthorized modification to this device could void the user's authority to operate the equipment.

Activating

- ▶ Press and hold **PANIC** button for at least 1 second.

An audible alarm and flashing exterior lamps will operate briefly.

Deactivating

- ▶ Press **PANIC** button again.

or

- ▶ Insert SmartKey or the SmartKey with KEYLESS-GO* in starter switch.

or

- ▶ Press the KEYLESS-GO* start/stop button (▷ page 39).

The SmartKey with KEYLESS-GO* must be inside the vehicle.

▼ Driving safety systems

In this section you will find information on the following driving safety systems:

- ABS (Antilock Brake System)
- Adaptive Brake
- BAS (Brake Assist System)
- EBP (Electronic Brake Proportioning)
- ESP® (Electronic Stability Program)

Warning!



The following factors increase the risk of accidents:

- Excessive speed, especially in turns
- Wet and slippery road surfaces
- Following another vehicle too closely

The ABS, BAS, ESP® and Adaptive Brake cannot reduce this risk.

Always adjust your driving style to the prevailing road and weather conditions.

i In winter operation, the maximum effectiveness of the ABS, BAS, ESP® and Adaptive Brake is only achieved with winter tires (> page 327) or snow chains as required.

ABS

Warning!



Do not pump the brake pedal. Use firm, steady brake pedal pressure instead. Pumping the brake pedal defeats the purpose of the ABS and significantly reduces braking effectiveness.

The Antilock Brake System (ABS) regulates the brake pressure so that the wheels do not lock during braking. This allows you to maintain the ability to steer your vehicle.

The ABS is functional above a speed of approximately 5 mph (8 km/h) independent of road surface conditions.

On slippery road surfaces, the ABS will respond even with light brake pressure.

The  indicator lamp in the instrument cluster comes on when you switch on the ignition. It goes out when the engine is running.

Braking

At the instant one of the wheels is about to lock up, a slight pulsation can be felt in the brake pedal, indicating that the ABS is in the regulating mode.

- ▶ Keep firm and steady pressure on the brake pedal while experiencing the pulsation.

Continuous, steady brake pedal pressure yields the advantages provided by the ABS, namely braking power and the ability to steer the vehicle.

The pulsating brake pedal can be an indication of hazardous road conditions and functions as a reminder to take extra care while driving.

Driving safety systems

Emergency brake maneuver

- ▶ Keep continuous full pressure on the brake pedal.

Warning!



When the ABS is malfunctioning, the BAS and the ESP® are also switched off.

When the ABS is malfunctioning, the wheels may lock during hard braking, reducing steering capability and extending the braking distance.

Warning!



The ABS cannot prevent the natural laws of physics from acting on the vehicle, nor can it increase braking or steering efficiency beyond that afforded by the condition of the vehicle brakes and tires or the traction afforded. The ABS cannot prevent accidents, including those resulting from excessive speed in turns, following another vehicle too

closely, or hydroplaning. Only a safe, attentive, and skillful driver can prevent accidents. The capabilities of an ABS equipped vehicle must never be exploited in a reckless or dangerous manner which could jeopardize the user's safety or the safety of others.

For more information, see the “Practical hints” section (▷ page 343).

BAS

The Brake Assist System (BAS) operates in emergency situations. If you apply the brakes very quickly, the BAS automatically provides full brake boost, thereby potentially reducing the braking distance.

- ▶ Apply continuous full braking pressure until the emergency braking situation is over.

The ABS will prevent the wheels from locking.

When you release the brake pedal, the brakes function again as normal. The BAS is then deactivated.

Warning!



If the BAS is malfunctioning, the brake system is still functioning normally, but without the additional brake boost available that BAS would normally provide in an emergency braking maneuver. Therefore, the braking distance may increase.

Warning!



The BAS cannot prevent the natural laws of physics from acting on the vehicle, nor can it increase braking efficiency beyond that afforded by the condition of the vehicle brakes and tires or the traction. The BAS cannot prevent accidents, including those resulting from excessive speed in turns, following another vehicle too closely, or hydroplaning. Only a safe, attentive, and

skillful driver can prevent accidents. The capabilities of a BAS equipped vehicle must never be exploited in a reckless or dangerous manner which could jeopardize the user's safety or the safety of others.

Adaptive Brake

Adaptive Brake provides a high level of braking safety as well as increased braking comfort.

Important notes on using the brake system

- Following extended periods of only minor loads to your brake system, you should occasionally apply the brakes when traveling at high speeds. This improves the grip of the brake pads.

Warning!



Make sure not to endanger any other road users when carrying out these braking maneuvers.

- After driving on wet or snow-covered roads, you should apply your brakes firmly before parking your vehicle. This produces heat which serves to dry the brake disks and help prevent corrosion.
- On long and steep grades, shift to a lower gear (gear range **1**, **2**, or **3**) to prevent the brakes from overheating and to reduce brake wear.
- After hard braking, it is advisable to drive on for some time so that the air stream will cool down the brakes faster.
- Only Mercedes-Benz approved components (e.g. brake pads) should be installed on your vehicle. Brake pads not approved by Mercedes-Benz may impair the safety of your vehicle.

EBP

The Electronic Brake Proportioning (EBP) enhances braking effectiveness by allowing the rear brakes to supply a greater proportion of the braking effort in straight line braking without a loss of vehicle stability.

Warning!



When the EBP is malfunctioning, the ABS, BAS, ESP[®] are also switched off.

If the EBP is malfunctioning, the brake system will still function with full brake boost. However, the rear wheels could lock up during emergency braking situations, for example. You could lose control of the vehicle and cause an accident. Adapt your driving style to the changed driving characteristics.

Driving safety systems

ESP®

The Electronic Stability Program (ESP®) is operational as soon as the engine is running and monitors the vehicle's traction (force of adhesive friction between the tires and the road surface) and handling.

The ESP® recognizes when a wheel is spinning or if the vehicle starts to skid. By applying the brakes to the appropriate wheel and by limiting engine output, the ESP® works to stabilize the vehicle. The ESP® is especially useful while driving off and on wet or slippery road surfaces. The ESP® also stabilizes the vehicle during braking and steering maneuvers.

The ESP® warning lamp  in the instrument cluster flashes when the ESP® is engaged.

The ESP® warning lamp  in the instrument cluster comes on when you switch on the ignition. It goes out when the engine is running.

Warning!



Never switch off the ESP® when you see the ESP® warning lamp  flashing in the instrument cluster. In this case proceed as follows:

- While driving off, apply as little throttle as possible.
- While driving, ease up on the accelerator.
- Adapt your speed and driving style to the prevailing road conditions.

Failure to observe these guidelines could cause the vehicle to skid.

The ESP® cannot prevent accidents resulting from excessive speed.

Warning!



The ESP® cannot prevent the natural laws of physics from acting on the vehicle, nor can it increase the traction afforded. The ESP® cannot prevent accidents, including those resulting from excessive speed in turns, or hydroplaning. Only a safe, attentive, and skillful driver can prevent accidents. The capabilities of an ESP® equipped vehicle must never be exploited in a reckless or dangerous manner which could jeopardize the user's safety or the safety of others.

! *The ESP® will only function properly if you use wheels of the recommended tire size (▷ page 438).*

! Because the ESP® operates automatically, the engine and the ignition must be shut off (SmartKey in starter switch position **0** or **1** or KEYLESS-GO start/stop button* in position **0** or **1**) when:

- the parking brake is being tested on a brake test dynamometer
- the vehicle is being towed with the front axle raised

Active braking action through the ESP® may otherwise seriously damage the brake system.

For more information, see the “Practical hints” section (▷ page 343) and (▷ page 361).

Electronic traction system

The electronic traction system is a component of ESP®.

The electronic traction system improves the vehicle’s ability to utilize available traction, especially under slippery road conditions by applying the brakes to a spinning wheel.

Except CLS 63 AMG:
When you switch off the ESP®, the electronic traction system is still enabled.

Warning!



If you are driving too fast, the electronic traction system cannot reduce the risk of an accident.

The electronic traction system cannot prevent the natural laws of physics from acting on the vehicle.

Switching off the ESP®

Switching off the ESP® (except CLS 63 AMG)

Warning!



The ESP® should not be switched off during normal driving other than in the circumstances described below. Disabling of the system will reduce vehicle stability in driving maneuvers.

Do not switch off the ESP® when a spare wheel is mounted.

To improve the vehicle’s traction, switch off the ESP® in driving situations where it would be advantageous to have drive wheels spin and thus cut into surfaces for better grip such as:

- when driving with snow chains
- in deep snow
- in sand or gravel

Driving safety systems

Warning!



Switch on the ESP® immediately if the aforementioned circumstances do not apply anymore. Otherwise the ESP® will not stabilize the vehicle when it is starting to skid or a wheel is spinning.

When you switch off the ESP®

- the ESP® does not stabilize the vehicle
- the engine output is not limited, which allows the drive wheels to spin and thus cut into surfaces for better grip
- the traction control will still apply the brakes to a spinning wheel
- the ESP® continues to operate when you are braking
- you cannot activate the cruise control or the Distronic*
- the cruise control or Distronic* switch off if currently activated

i When the ESP® is switched off and one or more drive wheels are spinning, the ESP® warning lamp  in the instrument cluster flashes. However, the ESP® will then not stabilize the vehicle.

The switch is located on the center console.



① ESP® switch

- ▶ With the engine running, press ESP® switch ① until the ESP® warning lamp  in the instrument cluster comes on.

The ESP® is switched off.

Warning!



When the ESP® warning lamp  is illuminated continuously, the ESP® is switched off or is not operational due to a malfunction. Vehicle stability in standard driving maneuvers is reduced.

Adapt your speed and driving to the prevailing road conditions and to the non-operating status of the ESP®.

! Avoid spinning of a drive wheel for an extended period with the ESP® switched off. This may cause serious damage to the drivetrain which is not covered by the Mercedes-Benz Limited Warranty.

Switching off the ESP® (CLS 63 AMG only)

Warning!



The ESP® should not be switched off during normal driving. Disabling of the system will result in the following:

- no restriction to engine torque
- loss of system supported traction control

“ESP® OFF” is designed for driving on closed tracks when the natural oversteer and understeer characteristics are desired and requires a highly skilled and experienced driver able to handle these critical driving situations.

You could lose control of your vehicle and cause an accident.

Please be aware of these limits when you switch off the ESP®.

Do not switch off the ESP® when a spare wheel is mounted.

When you switch off the ESP®

- the ESP® does not stabilize the vehicle
- the engine output is not limited, which allows the drive wheels to spin and thus cut into surfaces for better grip
- the traction control will still apply the brakes to a spinning wheel
- the ESP® operates while you are braking
- you cannot activate the cruise control or the DISTRONIC*
- the cruise control or DISTRONIC* switch off if currently activated

i When the ESP® is switched off and one or more drive wheels are spinning, the ESP® warning lamp  in the instrument cluster flashes. However, the ESP® will then not stabilize the vehicle.

The switch is located on the center console.



① ESP® switch

- ▶ With the engine running, press ESP® switch ① until the ESP® warning lamp  in the instrument cluster comes on.

The ESP® is switched off.

Driving safety systems

Warning!





When the ESP[®] warning lamp  is illuminated continuously, the ESP[®] is switched off or is not operational due to a malfunction. Vehicle stability in standard driving maneuvers reduces.

Adapt your speed and driving to the prevailing road conditions and to the non-operating status of the ESP[®].

! *Avoid spinning of a drive wheel for an extended period with the ESP[®] switched off. This may cause serious damage to the drivetrain which is not covered by the Mercedes-Benz Limited Warranty.*

Switching on the ESP[®]

- ▶ Press ESP[®] switch  until the ESP[®] warning lamp  in the instrument cluster goes out.

You are now again in normal driving mode with the ESP[®] switched on.

▼ Anti-theft systems

Immobilizer

The immobilizer prevents unauthorized persons from starting your vehicle.

Activating

With the SmartKey

- ▶ Remove the SmartKey from the starter switch.

The immobilizer is activated.

*With KEYLESS-GO**

- ▶ Press the KEYLESS-GO start/stop button once.

The engine is turned off.

- ▶ Open the driver's door.

Deactivating

With the SmartKey

- ▶ Turn the SmartKey in the starter switch to position **2** (▷ page 38).

*With KEYLESS-GO**

- ▶ Start the engine by means of the start/stop button on the gear selector lever.

i *In case the engine cannot be started (yet the vehicle's battery is charged), the system is not operational. Contact an authorized Mercedes-Benz Center or call 1-800-FOR-MERCedes (in the USA), or 1-800-387-0100 (in Canada).*

Anti-theft alarm system

Once the alarm system has been armed, a visual and audible alarm is triggered when someone opens

- a door
- the trunk
- the hood

The alarm will stay on, even if the activating element (a door, for example) is immediately closed.

The alarm system will also be triggered when

- someone attempts to raise the vehicle (only vehicles with tow-away alarm)
- the vehicle is opened with the mechanical key
- someone opens a door from the inside

Anti-theft systems

i If the alarm stays on for more than 30 seconds, a call to the Response Center is initiated automatically by the Tele Aid system (▷ page 257) provided Tele Aid service was subscribed to and properly activated, and that necessary cellular service and GPS coverage are available.

Arming the alarm system

The indicator lamp located in the central locking switch in the center console.



① Indicator lamp

- ▶ Lock the vehicle with the SmartKey or KEYLESS-GO*.

The turn signal lamps flash three times to indicate that the alarm system is armed. The indicator lamp ① begins to flash after approximately 30 seconds after arming the alarm system.

i If the turn signal lamps do not flash three times, one of the following elements may not be properly closed:

- a door
- the trunk

Close the respective element and lock the vehicle again.

Disarming the alarm system



- ▶ Unlock the vehicle with the SmartKey or KEYLESS-GO*.

The turn signal lamps flash once to indicate that the alarm system is disarmed.

i The alarm system will rearm automatically after approximately 40 seconds if neither a door nor the trunk was opened.

Canceling the alarm

With the SmartKey

- ▶ Insert the SmartKey in the starter switch.
- or
- ▶ Press button  or  on the SmartKey.

With KEYLESS-GO*

- ▶ Pull an outside door handle.

The SmartKey with KEYLESS-GO* must be within 3 ft (1 m) of the vehicle.

or

- ▶ Press the KEYLESS-GO* start/stop button (▷ page 39).

The SmartKey with KEYLESS-GO* must be inside the vehicle.

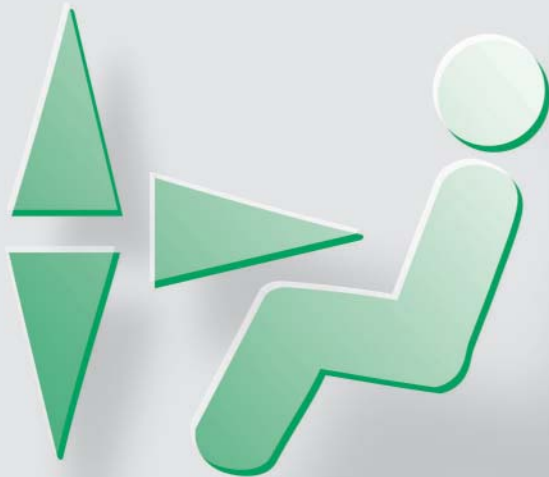

Locking and unlocking

Seats

Memory function

Lighting

Instrument cluster

Control system

Automatic transmission

Good visibility

4-zone automatic climate control

Power windows

Power tilt/sliding sunroof

Driving systems

Loading

Useful features

Locking and unlocking

In the “Controls in detail” section you will find detailed information on how to operate the equipment installed on your vehicle. If you are already familiar with the basic functions of your vehicle, this section will be of particular interest to you.

To quickly familiarize yourself with the basic functions of the vehicle, refer to the “Getting started” section of this manual. The corresponding page numbers are given at the beginning of each segment.

For more information on locking and unlocking, see “Getting started” (▷ page 36) and (▷ page 59).

SmartKey

Your vehicle comes supplied with two SmartKeys, each with remote control and a removable mechanical key.

The locking tabs for the mechanical key portion of the two SmartKeys are a different color to help distinguish each SmartKey unit.





The SmartKey provides an extended operating range. To prevent theft, however, it is advisable to only unlock the vehicle when you are in close proximity to it.

The SmartKey centrally locks and unlocks:

- the doors
- the trunk
- the fuel filler flap



SmartKey with remote control

- ①  Lock button
- ②  Opening button for trunk (▷ page 112)
- ③ Mechanical key locking tab
- ④  Unlock button
- ⑤ Battery check lamp
- ⑥  PANIC Panic button (▷ page 90)

! To prevent possible malfunction, avoid exposing the SmartKey to high levels of electromagnetic radiation.

Warning!

When leaving the vehicle, always remove the SmartKey from the starter switch, take it with you, and lock the vehicle. Do not leave children unattended in the vehicle, or with access to an unlocked vehicle. It is possible for children to open a locked door from the inside, which could result in an accident and/or serious personal injury.

i When you open a door, the side window on that side lowers slightly. Once you close the door, the window moves up again.

! The side windows will not open or close if the battery is discharged or the windows are covered with ice. As a result, you may no longer be able to properly close the door. Do not attempt to force the door shut. Doing so may damage the door or the side window. Correct the condition that prevents the windows from operating before attempting to close the door.

i USA only:

This device complies with Part 15 of the FCC Rules. Operation is subject to the following two conditions:

- (1) *This device may not cause harmful interference, and*
- (2) *this device must accept any interference received, including interference that may cause undesired operation.*

Any unauthorized modification to this device could void the user's authority to operate the equipment.

i Canada only:

This device complies with RSS-210 of Industry Canada. Operation is subject to the following two conditions:

- (1) *This device may not cause interference, and*
- (2) *this device must accept any interference received, including interference that may cause undesired operation of the device.*

Any unauthorized modification to this device could void the user's authority to operate the equipment.

i You can also open and close the windows and tilt/sliding sunroof or tilt/sliding panel* using the SmartKey (▷ page 210).

! If you can no longer lock or unlock the vehicle with the SmartKey, then the batteries in the SmartKey are discharged, the SmartKey is malfunctioning or the vehicle battery is drained.

- Check the batteries in the SmartKey (▷ page 105) and replace them if necessary (▷ page 402).
- Use the mechanical key to unlock the driver's door (▷ page 396) and the trunk (▷ page 397).
- Have the vehicle battery checked by an authorized Mercedes-Benz Center.

If the SmartKey is malfunctioning, contact an authorized Mercedes-Benz Center.

Factory setting

i When unlocking or locking the vehicle with the SmartKey an acoustic signal sounds. The acoustic signal is activated at the factory. If you wish to deactivate the feature, or adjust its signal volume, contact an authorized Mercedes-Benz Center.

Locking and unlocking

Global unlocking

- ▶ Press button .
 - All turn signal lamps flash once.
 - An acoustic signal sounds once.
 - The locking knobs in the doors move up.
 - The anti-theft alarm system is disarmed.

The vehicle will lock again automatically and rearm the anti-theft alarm system within approximately 40 seconds of unlocking if:

- neither door nor trunk is opened
- the SmartKey is not inserted in the starter switch
- the central locking switch is not activated

Global locking



- ▶ Press button .

With the trunk and all doors closed:

- All turn signal lamps flash three times.
- An acoustic signal sounds three times.
- The locking knobs in the doors move down.
- The anti-theft alarm system is armed.

Selective setting

If you frequently travel alone, you may wish to reprogram the SmartKey so that pressing button  only unlocks the driver's door, the storage compartment under the armrest, the glove box, and the fuel filler flap.

- ▶ Press and hold buttons  and  simultaneously for about 5 seconds until battery check lamp  flashes twice.

The SmartKey will then function as follows:

Unlocking driver's door and fuel filler flap

- ▶ Press button  once.
 - All turn signal lamps flash once.
 - An acoustic signal sounds once.
 - The locking knob on the driver's door move up.
 - The anti-theft alarm system is disarmed.

Global unlocking

- ▶ Press button  twice.
 - All turn signal lamps flash once.
 - An acoustic signal sounds once.
 - The locking knobs in the doors move up.
 - The anti-theft alarm system is disarmed.



Global locking

- ▶ Press button .

With the trunk and all doors closed:

- All turn signal lamps flash three times.
- An acoustic signal sounds three times.
- The locking knobs in the doors move down.
- The anti-theft alarm system is armed.

Restoring to factory setting

- ▶ Press and hold buttons  and  simultaneously for about 5 seconds until battery check lamp  flashes twice.

SmartKey with KEYLESS-GO*

Vehicles equipped with KEYLESS-GO come with two SmartKeys with KEYLESS-GO, each with remote control and a removable mechanical key.

The locking tabs for the mechanical key portion of the two SmartKeys with KEYLESS-GO are a different color to help distinguish each SmartKey with KEYLESS-GO unit.

The KEYLESS-GO function is integrated into the SmartKey. On these vehicles, the validity of the SmartKey with KEYLESS-GO is checked every time you pull an outside door handle.





If the SmartKey with KEYLESS-GO is valid, your vehicle unlocks

- the doors
- the trunk
- the fuel filler flap



P80.35-2285-31

SmartKey with KEYLESS-GO

- ①  Lock button
- ②  Opening button for trunk (▷ page 112)
- ③ Mechanical key locking tab
- ④  Unlock button
- ⑤ Battery check lamp
- ⑥  PANIC button (▷ page 90)

! To prevent possible malfunction, avoid exposing the SmartKey with KEYLESS-GO to high levels of electromagnetic radiation.

Locking and unlocking

Warning!



When leaving the vehicle, always take the SmartKey with KEYLESS-GO with you and lock the vehicle. Do not leave children unattended in the vehicle, or with access to an unlocked vehicle. It is possible for children to open a locked door from the inside, which could result in an accident and/or serious personal injury.

i When you open a door, the side window on that side lowers slightly. Once you close the door, the window moves up again.

! The side windows will not open or close if the battery is discharged or the windows are covered with ice. As a result, you may no longer be able to properly close the door. Do not attempt to force the door shut. Doing so may damage the door or the side window. Correct the condition that prevents the windows from operating before attempting to close the door.

i USA only:
This device complies with Part 15 of the FCC Rules. Operation is subject to the following two conditions:

- (1) This device may not cause harmful interference, and
- (2) this device must accept any interference received, including interference that may cause undesired operation.

Any unauthorized modification to this device could void the user's authority to operate the equipment.

i Canada only:
This device complies with RSS-210 of Industry Canada. Operation is subject to the following two conditions:

- (1) This device may not cause interference, and
- (2) this device must accept any interference received, including interference that may cause undesired operation of the device.

Any unauthorized modification to this device could void the user's authority to operate the equipment.

i You can also open and close the windows and tilt/sliding sunroof or tilt/sliding panel* using the SmartKey with KEYLESS-GO (▷ page 210).

! If you can no longer lock or unlock the vehicle with the SmartKey with KEYLESS-GO, then the batteries in the SmartKey are discharged, the SmartKey with KEYLESS-GO is malfunctioning or the vehicle battery is drained.

- Check the batteries in the SmartKey with KEYLESS-GO (▷ page 105) and replace them if necessary (▷ page 402).
- Use the mechanical key to unlock the driver's door (▷ page 396) and the trunk (▷ page 397).
- Have the vehicle battery checked by an authorized Mercedes-Benz Center.

If the SmartKey with KEYLESS-GO is malfunctioning, contact an authorized Mercedes-Benz Center.

Important notes on using KEYLESS-GO

- You can also use the SmartKey with KEYLESS-GO like a normal SmartKey (▷ page 102).
 - You can combine KEYLESS-GO functions with normal SmartKey functions (e.g. unlocking with KEYLESS-GO and locking with button ).
 - Always carry the SmartKey with KEYLESS-GO with you.
 - Never store the SmartKey with KEYLESS-GO together with:
 - Electronic items such as a cellular phone or another SmartKey with KEYLESS-GO
 - Metallic objects such as coins or metal foil
- Doing so could impair the function of the KEYLESS-GO system.
- To lock or unlock the vehicle, the SmartKey with KEYLESS-GO must be located outside the vehicle within approximately 3 ft (1 m) of a door or the trunk lid.
 - In order to start the engine with the SmartKey with KEYLESS-GO:
 - The SmartKey with KEYLESS-GO must be located in the vehicle.
 - The brake pedal must be firmly depressed. Do not depress the accelerator.
 - If the SmartKey with KEYLESS-GO is positioned farther away from the vehicle, the system may no longer recognize the SmartKey with KEYLESS-GO. The vehicle cannot be locked or the engine started via the KEYLESS-GO system.
 - If the SmartKey with KEYLESS-GO is removed from the vehicle (e.g. if passenger exits the vehicle with the SmartKey with KEYLESS-GO)

- when pressing the KEYLESS-GO start/stop button or trying to lock the vehicle with the outside door handle the message *Key not recognized* appears in the multifunction display
- with the engine running, the message *Key not recognized* appears in the multifunction display while driving off.

Find the SmartKey with KEYLESS-GO or change its present location immediately (e.g. place it on the front passenger seat or insert it in shirt pocket).

- If you have started the engine with the KEYLESS-GO start/stop button, you can turn it off again with:
 - the KEYLESS-GO start/stop button
 - the SmartKey with KEYLESS-GO inserted in the starter switch, when the automatic transmission is in position **P**

Locking and unlocking

- Remember that the engine can be started by anyone with a SmartKey with KEYLESS-GO that is left inside the vehicle.

Possibility 1: (One SmartKey with KEYLESS-GO in the vehicle, one SmartKey with KEYLESS-GO outside the vehicle):

If you leave the SmartKey with KEYLESS-GO behind when exiting and locking the vehicle, no message appears in the multifunction display.

Possibility 2: (One SmartKey with KEYLESS-GO in the vehicle, no SmartKey with KEYLESS-GO outside the vehicle):

When exiting and trying to lock the vehicle, the message *Key still in vehicle* appears in the multifunction display. The vehicle will not be locked.

Factory setting

i When unlocking or locking the vehicle with the SmartKey or with the KEYLESS-GO function an acoustic signal sounds. The acoustic signal is activated at the factory. If you wish to deactivate the feature, or adjust its signal volume, contact an authorized Mercedes-Benz Center.

Global unlocking

- ▶ Pull an outside door handle.
 - All turn signal lamps flash once.
 - An acoustic signal sounds once.
 - The locking knobs in the doors move up.
 - The anti-theft alarm system is disarmed.

The vehicle will lock again automatically and rearm the anti-theft alarm system within approximately 40 seconds if:

- neither a door nor the trunk is opened
- the central locking switch is not activated

Global locking



- ▶ Press lock button on an outside door handle (▷ page 62).

With the trunk and all doors closed:

- All turn signal lamps flash three times.
- An acoustic signal sounds three times.
- The locking knobs in the doors move down.
- The anti-theft alarm system is armed.

Selective setting

If you frequently travel alone, you may wish to reprogram the SmartKey with KEYLESS-GO so when you pull the driver's outside door handle, only the driver's door and the fuel filler flap unlocks.

- ▶ Press and hold buttons  and  simultaneously for about 5 seconds until battery check lamp ⑤ (▷ page 105) flashes twice.

The SmartKey with KEYLESS-GO will then function as follows:

Unlocking driver's door and fuel filler flap

- ▶ Pull the driver's outside door handle.
 - All turn signal lamps flash once.
 - An acoustic signal sounds once.
 - The locking knob in the driver's door moves up.
 - The anti-theft alarm system is disarmed.



Global unlocking

- ▶ Pull any outside door handle other than the driver's outside door handle.
 - All turn signal lamps flash once.
 - An acoustic signal sounds once.
 - The locking knobs in the doors move up.
 - The anti-theft alarm system is disarmed.

Global locking

- ▶ Press lock button on an outside door handle (▷ page 62).
With the trunk and all doors closed:
 - All turn signal lamps flash three times.
 - An acoustic signal sounds three times.
 - The locking knobs in the doors move down.
 - The anti-theft alarm system is armed.

Restoring to factory setting

- ▶ Press and hold buttons  and  simultaneously for about 5 seconds until battery check lamp ⑤ (▷ page 105) flashes twice.

Global locking using the KEYLESS-GO* lock button on the trunk lid*

Depending on production date, your vehicle may be equipped with the KEYLESS-GO lock button on trunk lid.



- ① Lock button on trunk lid

Locking and unlocking

- ▶ Press lock button  on the trunk lid.



With the trunk and all doors closed:

- All turn signal lamps flash three times.
- An acoustic signal sounds three times.
- The locking knobs in the doors move down.
- The anti-theft alarm system is armed.

 To prevent a possible inadvertent lockout, the trunk will open automatically if a SmartKey with KEYLESS-GO is recognized inside the vehicle or in the trunk.

 You can also lock the vehicle using the lock button on an outside door handle (▷ page 62) or, vehicles with trunk opening/closing system*, KEYLESS-GO locking/ closing switch (▷ page 116).

Checking batteries in the SmartKey or SmartKey with KEYLESS-GO*



- ▶ Press button  or .

The battery check lamp (▷ page 102) or (▷ page 105) comes on briefly to indicate that the SmartKey or SmartKey with KEYLESS-GO batteries are in order.

 If the battery check lamp does not come on briefly during check, the SmartKey or SmartKey with KEYLESS-GO batteries are discharged.

Replace the batteries (▷ page 402).

You can obtain the required batteries at any authorized Mercedes-Benz Center.

 If the batteries are checked within signal range of the vehicle, pressing button  or  will lock or unlock the vehicle accordingly.

Loss of the SmartKey or SmartKey with KEYLESS-GO*

If you lose your SmartKey, SmartKey with KEYLESS-GO or mechanical key, you should do the following:

- ▶ Have the SmartKey or SmartKey with KEYLESS-GO deactivated by an authorized Mercedes-Benz Center.
- ▶ Report the loss of the SmartKey, SmartKey with KEYLESS-GO or the mechanical key immediately to your car insurance company.
- ▶ Have the mechanical lock replaced if necessary.

Your authorized Mercedes-Benz Center will be glad to supply you with a replacement.

Opening the doors from the inside

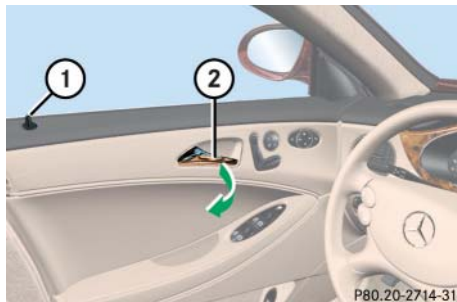

You can open a locked door from the inside. Open door only when conditions are safe to do so.



- ① Locking knob
- ② Inside door handle

i If the vehicle has previously been locked with the SmartKey or KEYLESS-GO*, opening a door from the inside will trigger the anti-theft alarm system.

To cancel the alarm, do one of the following:

- Press button  or  on the SmartKey or SmartKey with KEYLESS-GO*.
- Insert the SmartKey or SmartKey with KEYLESS-GO* in the starter switch.

In vehicles with KEYLESS-GO*

- Press the KEYLESS-GO* start/stop button ( page 39).

The SmartKey with KEYLESS-GO* must be inside the vehicle.

- Pull an outside door handle.

The SmartKey with KEYLESS-GO* must be within 3 ft (1 m) of the vehicle.

i When you open a door, the side window on that side lowers slightly. Once you close the door, the window moves up again.

Front doors

- ▶ Pull on door handle ② on the respective front door to open door.

If door was locked, locking knob ① will move up.

i If you hear a warning signal you have forgotten to switch off the headlamps before opening the driver's door.

In addition the message Switch off lights appears in the multifunction display.

Switch off the headlamps.

Rear doors

- ▶ Pull up locking knob ① on the respective rear door to unlock door.
- ▶ Pull on door handle ② on the respective rear door to open door.

Locking and unlocking

Opening the trunk

Warning!



Make sure the trunk is closed when the engine is running and while driving. Among other dangers, such as blocked visibility, exhaust fumes may enter the vehicle interior. These fumes are damaging to your health.

You can open the trunk if the vehicle is stationary.

A minimum height clearance of 5.90 ft (1.80 m) is required to open the trunk lid.

! *The trunk lid swings open upwards automatically. Always make sure there is sufficient overhead clearance.*

Opening the trunk from the outside

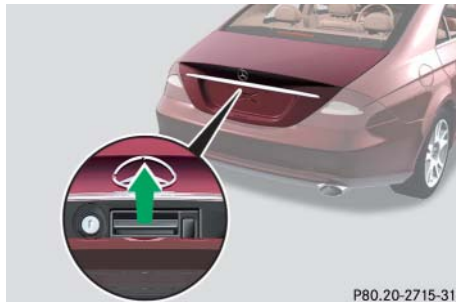

P80.20-2715-31

① Trunk lid handle

- ▶ Press and hold button  on the SmartKey or SmartKey with KEYLESS-GO* until trunk unlocks and begins to open.

or

- ▶ Pull on handle ①.

In vehicles without KEYLESS-GO*: The vehicle must be unlocked.

i *If the trunk does not open, it is still locked separately (▷ page 117).*

! *Vehicles with trunk opening/closing system*: To stop the opening procedure, press button  on the SmartKey or SmartKey with KEYLESS-GO*.*

Opening the trunk from the inside



P80.20-2863-31

Vehicles without trunk opening/closing system*

- ① Remote trunk opening switch



P80.20-2716-31

Vehicles with trunk opening/closing system*

- ① Remote trunk opening/closing* switch
- ▶ Pull switch ① until the trunk begins to open.

The trunk opens. The indicator lamp in the switch comes on and remains lit until the trunk is closed.

i If the trunk does not open, it is still locked separately (▶ page 117).

! Vehicles with trunk opening/closing system*: To stop the opening procedure, press or pull the remote trunk opening/closing* switch.

Closing the trunk

Warning!



Only drive with the trunk closed as, among other dangers such as blocked visibility, exhaust fumes may enter the vehicle interior.

i Do not place the SmartKey in the open trunk. You may lock yourself out.

i If the vehicle was previously centrally locked, the trunk will lock automatically after closing it. All turn signal lamps flash three times to confirm locking.

Vehicles with KEYLESS-GO: To prevent a possible inadvertent lockout, the trunk will open automatically if a SmartKey with KEYLESS-GO is recognized inside the vehicle or in the trunk.*

The vehicle is only locked when the turn signals flash three times. If you are carrying a second SmartKey with KEYLESS-GO with you, you can still lock the vehicle.

Closing trunk from the outside manually

Depending on production date your vehicle is equipped with two or three handles.



P68.70-2013-31

① Handles

- ▶ Lower trunk lid by pulling firmly on handles ①.
- ▶ Close trunk with hands placed flat on trunk lid.



Locking and unlocking



Warning!



To prevent possible personal injury, always keep hands and fingers away from the trunk opening when closing the trunk. Be especially careful when small children are around.

When leaving the vehicle, always remove the SmartKey or SmartKey with KEYLESS-GO* from the starter switch, take it with you, and lock the vehicle. Do not leave children unattended in the vehicle, or with access to an unlocked vehicle. A child's unsupervised access to a vehicle could result in an accident and/or serious personal injury.

Closing the trunk from the inside automatically*

Warning!



Maintain sight of trunk area while operating the door mounted switch. Monitor the closing procedure carefully to make sure that no one is in danger of being injured.

To interrupt the closing procedure, press or pull the door mounted remote trunk opening/closing* switch.

Even with the SmartKey or SmartKey with KEYLESS-GO* removed from the starter switch or the SmartKey with KEYLESS-GO* removed from the vehicle, the remote trunk opening/closing* switch can be operated. Therefore, do not leave children unattended in the vehicle, or with access to an unlocked vehicle. A child's unsupervised access to a vehicle could result in an accident and/or serious personal injury.

i If the trunk lid comes into contact with an object while closing (e.g. luggage that has been piled too high) in the upper motion sequence, the closing procedure is stopped and the trunk re-opens slightly.

In vehicles with trunk opening/closing system* you can close the trunk from the inside using the remote trunk opening/closing* switch.



① Remote trunk opening/closing* switch

- ▶ Press switch ① until the indicator lamp in the switch goes out and the trunk is closed.

To interrupt the closing procedure:

- ▶ Release switch ①.

Closing the trunk from the outside automatically*

Warning!



Monitor the closing procedure carefully to make sure no one is in danger of being injured. To prevent possible personal injury, always keep hands and fingers away from the trunk opening when closing the trunk. Be especially careful when small children are around. To stop the closing procedure, do one of the following:

- press button  on the SmartKey or SmartKey with KEYLESS-GO*
- press or pull the remote trunk opening/closing* switch (on the driver's door)
- press the trunk closing switch
- press the KEYLESS-GO locking/closing* switch
- pull the trunk lid handle

Even with the SmartKey or SmartKey with KEYLESS-GO* removed from the starter

switch or the SmartKey with KEYLESS-GO* removed from the vehicle, the remote trunk opening/closing* switch can be operated. Therefore, do not leave children unattended in the vehicle, or with access to an unlocked vehicle. A child's unsupervised access to a vehicle could result in an accident and/or serious personal injury.

In vehicles with trunk opening/closing system* you can close the trunk separately from the outside using the trunk closing switch.



Vehicles without KEYLESS-GO*

- ① Trunk closing switch



Vehicles with KEYLESS-GO*

- ① Trunk closing switch
- ▶ Press switch ① briefly.

The trunk closes.

i If the trunk lid comes into contact with an object while closing (e.g. luggage that has been piled too high) in the upper motion sequence, the closing procedure is stopped and the trunk re-opens slightly.

Locking and unlocking

Closing trunk and locking vehicle from outside (vehicles with KEYLESS-GO*)

In vehicles with trunk opening/closing system* and KEYLESS-GO, you can close the trunk and lock the vehicle simultaneously from the outside using the KEYLESS-GO locking/closing switch.



- ① KEYLESS-GO locking/closing switch
- ▶ Make sure you have the SmartKey with KEYLESS-GO with you.

- ▶ Press switch ① briefly.

With all doors closed:

- The locking knobs in the doors move down.
- The trunk starts to close automatically.
- All turn signal lamps flash three times to confirm locking once the trunk has closed completely.
- An acoustic signal sounds three times.
- The anti-theft alarm system is armed.

i If the trunk lid comes into contact with an object while closing (e.g. luggage that has been piled too high) in the upper motion sequence, the closing procedure is stopped and the trunk re-opens slightly.

Trunk emergency release

With the emergency release button, the trunk can be opened from inside the trunk.



- ① Emergency release button

- ▶ Briefly press emergency release button ①.

The trunk unlocks and the trunk opens.

i The emergency release button unlocks and opens the trunk while the vehicle is standing still or in motion.



Illumination of the emergency release button:

- The button will flash for 30 minutes after opening the trunk.
- The button will flash for 60 minutes after closing the trunk.

i The emergency release button does not open the trunk, if the vehicle battery is discharged or disconnected.

i If the vehicle has previously been locked using the SmartKey or KEYLESS-GO*, the exterior lamps will flash and the alarm will sound as the trunk opens.

To cancel the alarm, do one of the following:

- Insert the SmartKey in the starter switch.
- Press button  or  on the SmartKey.

In vehicles with KEYLESS-GO*

- Pull an outside door handle.

The SmartKey with KEYLESS-GO must be within 3 ft (1 m) of the vehicle.

- Press the KEYLESS-GO* start/stop button (▷ page 39).

The SmartKey with KEYLESS-GO must be inside the vehicle.

Valet locking

i To deny any unauthorized person access to the trunk, e.g. when you valet park the vehicle, lock it separately with the mechanical key. Leave only the SmartKey or SmartKey with KEYLESS-GO* less its mechanical key with the vehicle.

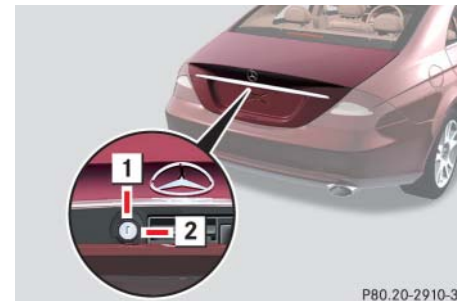

P80.20-2910-31

1 Neutral position

2 Locked

Locking and unlocking

- ▶ Close the trunk (▷ page 113).
- ▶ Remove the mechanical key from the SmartKey (▷ page 396).
- ▶ Insert the mechanical key in the trunk lid lock.
- ▶ Turn the mechanical key clockwise to position **2** to lock the trunk.

The trunk remains locked even when the vehicle is centrally unlocked.

i You can only cancel the separate trunk locking mode by means of the mechanical key.

- ▶ Insert the mechanical key in the trunk lid lock.
- ▶ Turn the mechanical key counterclockwise to neutral position **1** to unlock the trunk.

You can now open the trunk (▷ page 112).

Automatic central locking

The doors and the trunk automatically lock when the ignition is switched on and the wheels are turning at vehicle speeds of approximately 9 mph (15 km/h) or more. The locking knobs in the doors move down.

You can open a locked door from the inside. Open door only when conditions are safe to do so.

i The doors are designed to unlock automatically after an accident if the force of the impact exceeds a preset threshold. The vehicle locks automatically when the ignition is switched on and the wheels are turning at vehicle speeds of approximately 9 mph (15 km/h) or more. You could therefore lock yourself out when the vehicle

- is pushed or towed
- is on a test stand

You can deactivate the automatic locking mode using the control system (▷ page 165).

Locking and unlocking from the inside

Warning!



When leaving the vehicle, always remove the SmartKey or SmartKey with KEYLESS-GO* from the starter switch, take it with you, and lock the vehicle. Do not leave children unattended in the vehicle, or with access to an unlocked vehicle. A child's unsupervised access to a vehicle could result in an accident and/or serious personal injury.

You can lock or unlock the doors and the trunk from inside using the central locking switch. This can be useful, for example, if you want to lock the vehicle before starting to drive.

The fuel filler flap cannot be locked or unlocked with the central locking switch.



Central locking switch

- ① Unlocking
- ② Locking

i You can open a locked door from the inside. Open door only when conditions are safe to do so.

If the vehicle was previously centrally locked with the SmartKey or with KEYLESS-GO, it will not unlock using the central locking switch.*

If the vehicle was previously locked with the central locking switch:

- *and the SmartKey or SmartKey with KEYLESS-GO* is set to factory settings, the complete vehicle is unlocked when a door is opened from the inside*
- *and the SmartKey or SmartKey with KEYLESS-GO* is set to selective settings, only the door opened from the inside is unlocked*

Locking

- ▶ Press lower half ② of the central locking switch.

If all doors are closed, the vehicle locks.

Unlocking

- ▶ Press upper half ① of the central locking switch.

The vehicle unlocks.

Seats

For more information on seat adjustment, see “Adjusting” (▷ page 41).

For more information on folding the seats, see “Loading” (▷ page 239).

Front seat active head restraints

Warning!



For your protection, drive only with properly positioned head restraints.

Adjust the head restraint so that the center of the head restraint supports the back of the head at eye level. This will reduce the potential for injury to the head and neck in the event of an accident or similar situation.

Do not drive the vehicle without the seat head restraints. Head restraints are intended to help reduce injuries during an accident.

You cannot remove the active head restraint on the driver’s and front passenger’s seats.

For removal of the active head restraints we recommend that you contact an authorized Mercedes-Benz Center.

i *Adjust the head restraint in such a way that it is as close to the head as possible.*

For information on head restraint adjustment, see “Seat adjustment” (▷ page 42).

For information on active head restraints, see “Active head restraints” (▷ page 83).

Rear seat head restraints

Warning!



For safety reasons, always drive with the rear head restraints in the upright position when the rear seats are occupied.

Keep the area around head restraints clear of articles (e.g. clothing) to not obstruct the folding operation of the head restraints.

Warning!



For your protection, drive only with properly positioned head restraints.

Adjust head restraint so that the head restraint supports the back of the head at eye level. This will reduce the potential for injury to the head and neck in the event of an accident or similar situation.

Do not drive the vehicle without the seat head restraints. Head restraints are intended to help reduce injuries during an accident.

Do not interchange head restraints from front and rear seat.

i *The rear seat head restraints cannot be adjusted.*

Folding head restraints back

The rear seat head restraints can be folded backward for increased visibility.



- ① Head restraint release switch
- ▶ Switch on the ignition (▶ page 38).
- ▶ Press the symbol-side on rocker switch ① to release the head restraints.

The head restraints will fold backward.

Placing head restraints upright

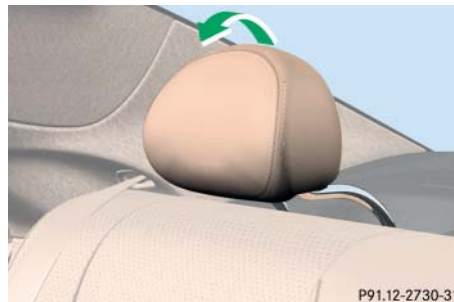

- ▶ Pull the head restraint forward until it locks into position.

! Make sure the head restraints engage when placing them upright. Otherwise their protective function cannot be assured.

Lumbar support

The curvature of the front seats can be adjusted to help enhance lower back support and seating comfort.



- ① Adjustment lever
- ▶ Move adjustment lever ① in direction of the arrows until you have reached a comfortable seating position.

Seats

Multicontour seat*

The multicontour seat has a movable seat cushion and inflatable air cushions built into the backrest to provide additional lumbar and side support.

The seat cushion movement, backrest cushion height and curvature can be continuously varied with switches right side of the seat on the driver side, or the left side of the seat on the passenger side.



- ① Seat cushion depth
- ② Backrest bottom
- ③ Backrest center
- ④ Backrest side bolsters

▶ Switch on the ignition (▷ page 38).

Seat cushion depth

- ▶ Adjust the seat cushion depth to the length of your upper leg using switch ①.

Backrest contour

- ▶ Adjust the contour of the backrest to the desired position using **+** or **-**.
- ▶ Move the backrest support cushion to the bottom by using button ② or to the center by using button ③.

Backrest side bolsters

- ▶ Adjust the side bolsters so that they provide good lateral support using switch ④.

i If, after a period of time, the seat no longer provides the desired contour, then repeat the adjustment procedure.

Seat heating*

The red indicator lamps on the switch show the heating level selected.

Level	
3	Three indicator lamps on (highest level). The seat heating automatically switches to level 2 after approximately 5 minutes.
2	Two indicator lamps on. The seat heating automatically switches to level 1 after approximately 10 minutes.
1	One indicator lamp on (lowest level). The seat heating automatically switches off after approximately 20 minutes.
off	No indicator lamp on.



① Front seat heating switch



① Rear seat heating switch (Canada only)

► Switch on the ignition (► page 38).

Switching seat heating on

- Press switch ①.
- Three red indicator lamps in the switch come on.
- Continue pressing switch ① until desired seat heating level is reached.

Switching seat heating off

- Press switch ① repeatedly until all indicator lamps go out.

i If one or more of the lamps on the seat heating switch are flashing, there is insufficient voltage available since too many electrical consumers are turned on. The seat heating switches off automatically.

The seat heating will switch back on again automatically as soon as sufficient voltage is available.

Seats

Seat ventilation*

The blue indicator lamps on the switch show the ventilation level selected.

Level	
3	Three indicator lamps on (highest level).
2	Two indicator lamps on.
1	One indicator lamp on (lowest level).
off	No indicator lamp on.

i The seat ventilation for the driver's seat can be activated using summer opening feature (▷ page 210).



- ① Seat ventilation switch
- ▶ Switch on the ignition (▷ page 38).

Switching seat ventilation on

- ▶ Press switch ① repeatedly until the desired ventilation level is set.

One or more blue indicator lamps on the switch show the selected ventilation level.

Switching seat ventilation off

- ▶ Press switch ① repeatedly until all indicator lamps go out.

i If one or more of the lamps on the seat ventilation switch are flashing, there is insufficient voltage available since too many electrical consumers are turned on. The seat ventilation switches off automatically.

The seat ventilation will switch back on again automatically as soon as sufficient voltage is available.

▼ Memory function

Prior to operating the vehicle, the driver should check and adjust the seat height, seat position fore and aft, and seat backrest angle if necessary, to ensure adequate control, reach and comfort. The head restraint should also be adjusted for proper height. See also the section on air bags (▷ page 66) for more information on proper seat positioning.

In addition, adjust the steering wheel to ensure adequate control, reach, operation and comfort. Both the interior and exterior rear view mirrors should be adjusted for adequate rear vision.

Fasten seat belts. Infants and small children should be seated in a properly secured restraint system that complies with U.S. Federal Motor Vehicle Safety Standards 213 and 225 and Canadian Motor Vehicle Safety Standards 213 and 210.2.

With the memory function you can store up to three different settings.

Each stored position on the driver's side includes the following settings:

- Seat position and lumbar support
- Multicontour seat*: previously saved setting
- Steering wheel position
- Exterior rear view mirror positions

Warning!



Do not activate the memory function while driving. Activating the memory function while driving could cause the driver to lose control of the vehicle.

Each stored position on the passenger side includes the following settings:

- Seat position and lumbar support
- Multicontour seat*: previously saved setting

Memory function



M Memory button
1, 2, 3 Stored position button

- ▶ Switch on the ignition (▷ page 38).
- or
- ▶ Open the respective door.

Storing positions into memory

- ▶ Adjust the seats, steering wheel and exterior rear view mirrors to the desired position (▷ page 41).
- ▶ Press memory button **M**.
- ▶ Release memory button **M** and press memory position button **1**, **2** or **3** within 3 seconds.

All the settings are stored to the selected position.

Recalling positions from memory

! Do not operate the power seats using the memory button if the seat backrest is in an excessively reclined position. Doing so could cause damage to front or rear seats.

First move seat backrest to an upright position.

- ▶ Press and hold memory position button **1**, **2** or **3** until the seat, steering wheel and exterior rear view mirrors have completely moved to the stored positions.

i Releasing the memory position button stops movement to the stored positions immediately.

The multicontour seat will continue to be adjusted.*

Storing exterior rear view mirror parking position

For easier parking, you can adjust the passenger-side exterior rear view mirror so that you can see the right rear wheel as soon as you engage reverse gear **R**.

For information on activating the parking position, see “Activating exterior rear view mirror parking position” (▷ page 187).



- ① Passenger-side exterior rear view mirror button
- ② Adjustment button
- ③ Memory button

- ▶ Stop the vehicle.
- ▶ Switch on the ignition (▷ page 38).
- ▶ Press button ①.
The passenger-side exterior rear view mirror is selected.
- ▶ Adjust the exterior rear view mirror with button ② so that you see the rear wheel and the road curb.

- ▶ Press memory button **M** ③.
- ▶ Within 3 seconds, press bottom of adjustment button ②.

The parking position is stored if the mirror does not move.

i If the mirror does move, repeat the above steps. After the setting is stored, you can move the mirror again.

Lighting

For information on how to switch on the headlamps and use the turn signals, see “Switching on headlamps” (▷ page 55) and see “Turn signals” (▷ page 55).

i If you drive in countries where vehicles drive on the other side of the road than the country where the vehicle is registered, you must have the headlamps modified for symmetrical low beams. Relevant information can be obtained at your authorized Mercedes-Benz Center.

i Vehicles equipped with active Bi-Xenon* headlamps: The active Bi-Xenon headlamps monitor your steering angle and driving speed, then automatically shift their beams to either side to better follow the curvature of the road ahead, increasing usable illumination over conventional headlamps.

Exterior lamp switch



Exterior lamp switch

- | | | |
|---|--|---|
| 1 | | Standing lamps, left (turn left two stops) |
| 2 | | Standing lamps, right (turn left one stop) |
| 3 | | Off
Daytime running lamp mode (▷ page 130) |
| 4 | | Automatic headlamp mode
Daytime running lamp mode (▷ page 130) |

- | | | |
|---|--|---|
| 5 | | Parking lamps (also side marker lamps, tail lamps, license plate lamps, instrument panel lamps) |
| 6 | | Low beam headlamps or high beam headlamps when the combination switch is pushed forward. The tail lamps, license plate lamps, side marker lamps, parking lamps and instrument panel lamps also come on. |
| 7 | | Front fog lamps |
| 8 | | Rear fog lamp |

i If you hear a warning signal you have forgotten to switch off the headlamps before opening the driver's door.

In addition the message Switch off lights appears in the multifunction display.

Switch off the headlamps.

Manual headlamp mode

The low beam headlamps and the parking lamps can be switched on and off with the exterior lamp switch.

- ▶ Turn the exterior lamp switch to position .

Automatic headlamp mode

The following lamps switch on and off automatically depending on the brightness of the ambient light:

- Low beam headlamps
- Tail and parking lamps
- License plate lamps
- Side marker lamps



Warning!



If the exterior lamp switch is set to **AUTO**,

- the headlamps may switch off unexpectedly when the system senses bright ambient light, for example light from oncoming traffic.
- the headlamps will not be automatically switched on under foggy conditions.

To minimize risk to you and to others, activate headlamps by turning exterior lamp switch to  when driving or when traffic and/or ambient lighting conditions require you to do so.

In low ambient lighting conditions, only switch from position **AUTO** to  with the vehicle at a standstill in a safe location. Switching from **AUTO** to  will briefly switch off the headlamps. Doing so while driving in low ambient lighting conditions may result in an accident.

The automatic headlamp feature is only an aid to the driver. The driver is responsible for the operation of the vehicle's lights at all times.

- ▶ Turn the exterior lamp switch to position **AUTO**.

With the SmartKey in starter switch position **1** or the KEYLESS-GO* start/stop button pressed once, only the parking lamps and the side marker lamps will switch on and off automatically.

When the engine is running, the low beam headlamps, the tail and parking lamps, the license plate lamps, and the side marker lamps will switch on and off automatically.



USA only:

With the automatic headlamp mode activated you can switch on the high beam headlamps in low ambient lighting conditions.

Lighting

Daytime running lamp mode

- ▶ Turn exterior lamp switch to position **0** or **AUTO**.

When the engine is running, the low beam headlamps are switched on.

In low ambient light conditions, the following lamps will switch on additionally:

- Tail and parking lamps
- License plate lamps
- Side marker lamps

i With the daytime running lamp mode activated and the engine running, the low beam headlamps cannot be switched off manually.

Canada only

The daytime running lamp mode is mandatory and therefore in a constant mode.



i With the exterior lamp switch in position **0** or **AUTO**, you cannot switch on the high beam headlamps.

The high beam flasher is available at all times.

For nighttime driving you should turn the exterior lamp switch to position  to permit activation of the high beam headlamps.

When the engine is running, and you shift from a driving position to position **N** or **P**, the low beam headlamps will switch off with a 3-minute delay.

When the engine is running, and you

- turn the exterior lamp switch to position , the parking lamps and the side marker lamps switch on additionally.
- turn the exterior lamp switch to position , the manual headlamp mode has priority over the daytime running lamp mode.

The corresponding exterior lamps switch on (▷ page 128).



USA only

By default, the daytime running lamp mode is deactivated. Activate the daytime running lamp mode using the control system, see “Setting daytime running lamp mode (USA only)” (▷ page 161).

i With the daytime running lamp mode activated and the exterior lamp switch in position **0**, you cannot switch on the high beam headlamps.

The high beam flasher is available at all times.

*For nighttime driving you should turn the exterior lamp switch to position  or **AUTO** to permit activation of the high beam headlamps.*

When the engine is running, and you turn the exterior lamp switch to position  or , the manual headlamp mode has priority over the daytime running lamp mode.

The corresponding exterior lamps switch on (▷ page 128).



Locator lighting and night security illumination

Locator lighting and night security illumination are described in the “Control system” section, see “Setting locator lighting” (▷ page 162) and “Setting night security illumination (Headlamps delayed shut-off)” (▷ page 163).

Fog lamps

Warning!





In low ambient lighting or foggy conditions, only switch from position **AUTO** to  with the vehicle at a standstill in a safe location. Switching from **AUTO** to  will briefly switch off the headlamps. Doing so while driving in low ambient lighting conditions may result in an accident.

i Fog lamps will operate with the parking lamps and/or the low beam headlamps on. Fog lamps should only be used in conjunction with low beam headlamps. Consult your State or Province Motor Vehicle Regulations regarding permissible lamp operation.

i Fog lamps cannot be switched on with the exterior lamp switch in position **AUTO**. To switch on the fog lamps, turn the exterior lamp switch to position  first.

Front fog lamps



- ▶ Switch on the low beam headlamps  (▷ page 55).
- ▶ Pull out exterior lamp switch to first stop.
The front fog lamps switch on.
The green indicator lamp  in the exterior lamp switch comes on (▷ page 128).

- ▶ Push in the exterior lamp switch.

The front fog lamps are switched off.

The green indicator lamp  in the exterior lamp switch goes out.

Rear fog lamp (driver's side only)

- ▶ Switch on the low beam headlamps  (▷ page 55).
- ▶ Pull out exterior lamp switch to second stop.
The front fog lamps and the rear fog lamp switch on.
The yellow indicator lamp  in the exterior lamp switch comes on (▷ page 128).
- ▶ Push in the exterior lamp switch to first stop.

The rear fog lamp is switched off.

The yellow indicator lamp  in the exterior lamp switch goes out.

The front fog lamps remain lit.

Lighting

Combination switch

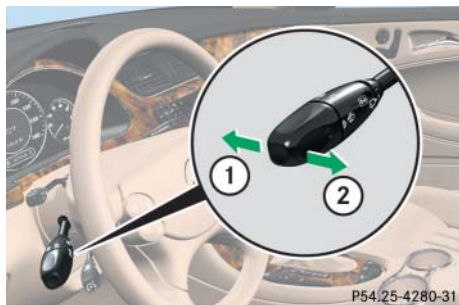

Combination switch

- ① High beam
- ② High beam flasher

High beam

- ▶ Turn the exterior lamp switch to position  (▷ page 128).
- ▶ Push the combination switch in direction of arrow ① to switch on the high beam.

The high beam headlamp indicator lamp  in the instrument cluster comes on (▷ page 26).

- ▶ Pull the combination switch in direction of arrow ② to its original position to switch off the high beam.

The high beam headlamp indicator lamp  in the instrument cluster goes out.

High beam flasher

- ▶ Pull the combination switch briefly in direction of arrow ②.

Corner-illuminating front fog lamps* (CLS 550 with Bi-Xenon* headlamps only)

The corner-illuminating front fog lamps improve illumination of the area in the direction into which you are turning.

Corner-illuminating front fog lamps will operate with the engine running and with

- the exterior lamp switch in position  (▷ page 128)
or
- the exterior lamp switch in position **AUTO** (▷ page 128)
or
- the daytime running lamp mode activated (▷ page 130)

i *With the automatic headlamp mode activated: The corner-illuminating front fog lamps will only come on in low ambient lighting conditions.*

i If you are driving faster than 25 mph (40 km/h) or have the front fog lamps switched on, the corner-illuminating function is not available.

Driving forward

Switching on corner-illuminating front fog lamps

- ▶ Switch on the left or right turn signal (> page 55), depending on whether you are turning left or right.

The respective front fog lamp comes on and illuminates the area in the direction into which you are turning.

or

- ▶ Turn steering wheel in desired direction.

The front fog lamp on the side of your steering direction comes on.

i If you have switched on the turn signal for one side but turn the steering wheel in the other direction, the corner-illuminating lamp lights up on the side of the turn signal.

The corner-illuminating front fog lamp remains lit for a maximum of three minutes. Afterward, it goes out even if the turn signal is still switched on.

i The corner-illuminating front fog lamps temporarily come on on both sides of the vehicle if you turn the steering wheel in one direction and then in the other direction shortly thereafter.

i The corner-illuminating front fog lamps will come on automatically depending on the steering angle, even if you did not switch on either turn signal. If the corner-illuminating front fog lamps came on automatically, they will also go out automatically depending on the steering angle.

Switching off corner-illuminating front fog lamps

The combination switch for the turn signal resets automatically after major steering wheel movements. This will switch off the corner-illuminating front fog lamps if they were activated by switching on the left or right turn signal.

If the turn signal should stay on after making the turn, the turn signal and corner-illuminating front fog lamps can be switched off by returning the combination switch to its original position.

i There may be a brief delay before the corner-illuminating front fog lamps switch off.

Lighting

Driving in reverse

Switching on corner-illuminating front fog lamps

- ▶ Place the gear selector lever in position **R**.

The front fog lamp opposite to your steering direction comes on.

Switching off corner-illuminating front fog lamps

- ▶ Place the gear selector lever out of position **R**.

The respective front fog lamp goes out.

Hazard warning flasher

The hazard warning flasher can be switched on at all times, even with the SmartKey removed from the starter switch or with the SmartKey with KEYLESS-GO* removed from the vehicle.

The hazard warning flasher switches on automatically when an air bag deploys.

The hazard warning flasher switch is located on the center console.



① Hazard warning flasher switch

Switching on hazard warning flasher

- ▶ Press the hazard warning flasher switch ①.

All turn signals are flashing.

i *With the hazard warning flasher activated and the combination switch set for either left or right turn, only the respective left or right turn signals will operate when the ignition is switched on.*

Switching off hazard warning flasher

- ▶ Press hazard warning flasher switch ① again.

i *If the hazard warning flasher has been activated automatically, press hazard warning flasher switch ① once to switch off.*

Interior lighting in the front

The controls are located in the overhead control panel.

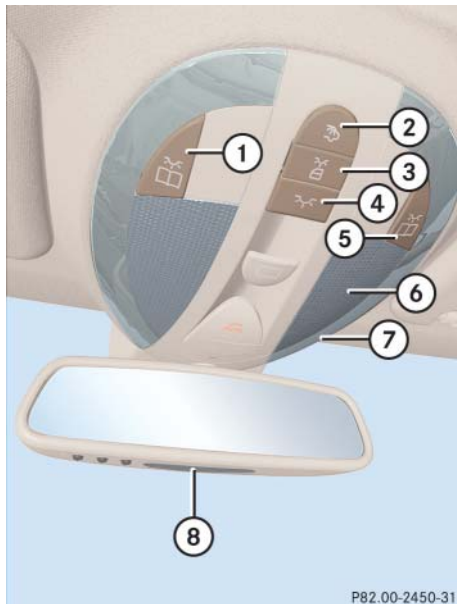

P82.00-2450-31

- ① Left front reading lamp on/off
- ② Rear interior lighting on/off
- ③ Automatic control on/off
- ④ Front interior lighting on/off
- ⑤ Right front reading lamp on/off
- ⑥ Interior lighting
- ⑦ Ambient lighting
- ⑧ Front reading lamps

! An interior lamp switched on manually does not go out automatically.

Leaving an interior lamp switch in the ON position for extended periods of time with the engine turned off could result in a discharged battery.

Deactivating automatic control

i The interior lighting is factory-set to automatic mode.

- ▶ Press switch ③.

The interior lighting remains switched off in darkness, even when you:

- unlock the vehicle
- remove the SmartKey from the starter switch

- open a door
- open the trunk

Activating automatic control

- ▶ Press switch ③.

The interior lighting switches on in darkness, when you:

- unlock the vehicle
- remove the SmartKey from the starter switch
- open a door
- open the trunk

The interior lighting switches off after a preset time (▶ page 164).

i If a door remains open, the interior lamps switch off automatically after approximately 5 minutes.

Lighting

Manual control

Switching front/rear interior lighting on and off

- ▶ Press front/rear interior lighting switch ④ or ② to switch on the desired interior light.
- ▶ Press front/rear interior lighting switch ④ or ② again to switch off the respective interior light.

Switching front reading lamps on and off

The front reading lamps are located in the interior rear view mirror.

- ▶ Press front reading lamp switch ① or ⑤ to switch on the desired front reading lamp.
- ▶ Press front reading lamp switch ① or ⑤ again to switch off the respective front reading lamp.

Ambient lighting

You can switch the ambient lighting ⑦ (▷ page 135) on and off, using the “Control system” (▷ page 163).

Interior lighting in the rear

The overhead control panel is located above the rear seat bench.

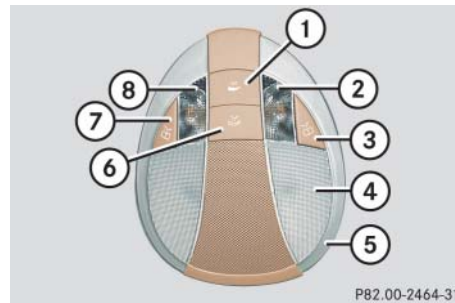

- ① Ambient lighting switch, to brighten
- ② Right reading lamp
- ③ Right reading lamp on/off
- ④ Rear interior lamp
- ⑤ Ambient lighting
- ⑥ Ambient lighting switch, to dim
- ⑦ Left reading lamp on/off
- ⑧ Left reading lamp

Rear reading lamps

- ▶ Press rear reading lamp switch ③ or ⑦ to switch on the respective rear reading lamp.
- ▶ Press rear reading lamp switch ③ or ⑦ again to switch off the respective rear reading lamp.

Ambient lighting

- ▶ Press ambient lighting switch ① or ⑥ repeatedly until ambient lighting ⑤ has reached the desired intensity.

You can switch the ambient lighting on and off, using the “Control system” (▷ page 163).

Door entry lamps

For better orientation in the dark, the corresponding door entry lamps will switch on in darkness when you open a door and the automatic control is activated.

The door entry lamps will switch off when the corresponding door is closed.

i *If you turn the SmartKey in the starter switch to position 0 and switch off the headlights, the door entry lamps will remain lit for approximately 5 minutes.*

Trunk lamp

The trunk lamp switches on if the trunk is opened.

If the trunk remains open, the trunk lighting switches off automatically after approximately 10 minutes.

Instrument cluster

For a full view illustration of the instrument cluster, see “At a glance” (▷ page 26).

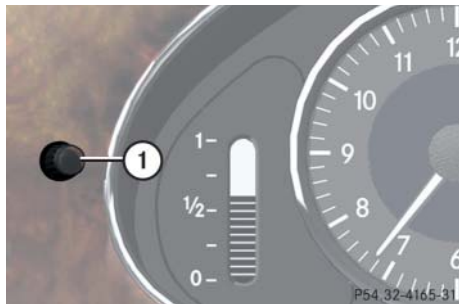

① Reset button

The instrument cluster is activated when you

- open a door
- switch on the ignition
- press the reset button ①
- switch on the exterior lamps

You can modify the instrument cluster settings in the instrument cluster submenu of the control system (▷ page 157).

Warning!



No messages will be displayed if either the instrument cluster or the multifunction display is inoperative.

As a result, you will not be able to see information about your driving conditions, such as speed or outside temperature, warning/indicator lamps, malfunction/warning messages or the failure of any systems. Driving characteristics may be impaired.

If you must continue to drive, please do so with added caution. Visit an authorized Mercedes-Benz Center as soon as possible.

Adjusting instrument cluster illumination

Use the reset button (▷ page 138) to adjust the illumination brightness for the instrument cluster.

i The instrument cluster illumination is dimmed or brightened automatically to suit ambient light conditions.

The instrument cluster illumination will also be adjusted automatically when you switch on the vehicle's exterior lamps.

To brighten illumination

- ▶ Turn the reset button (▷ page 138) clockwise.

The instrument cluster illumination will brighten.

To dim illumination

- ▶ Turn the reset button (▷ page 138) counterclockwise.

The instrument cluster illumination will dim.

Coolant temperature indicator

Warning!



- Driving when your engine is overheated can cause some fluids which may have leaked into the engine compartment to catch fire. You could be seriously burned.
- Steam from an overheated engine can cause serious burns and can occur just by opening the hood. Stay away from the engine if you see or hear steam coming from it.

Stop the vehicle in a safe location away from other traffic. Turn off the engine, get out of the vehicle and do not stand near the vehicle until the engine has cooled down.



! Excessive coolant temperature triggers the coolant temperature warning lamp (▷ page 347) and a warning in the multifunction display (▷ page 374).

The engine should not be operated with the coolant temperature above 248 °F (120 °C). Doing so may cause serious engine damage which is not covered by the Mercedes-Benz Limited Warranty.

i During severe operating conditions, e.g. stop-and-go traffic, the coolant temperature may rise close to 248 °F (120 °C).

Resetting trip odometer

Make sure you are viewing the trip odometer display (▷ page 141).

- ▶ If it is not displayed, press the  or  repeatedly until the trip odometer appears.
- ▶ Press and hold the reset button (▷ page 138) until the trip odometer is reset.

Tachometer

The red marking on the tachometer denotes excessive engine speed.

! Avoid driving at excessive engine speeds, as it may result in serious engine damage that is not covered by the Mercedes-Benz Limited Warranty.

To help protect the engine, the fuel supply is interrupted if the engine is operated within the red marking.

Outside temperature indicator

Warning!



The outside temperature indicator is not designed to serve as an ice-warning device and is therefore unsuitable for that purpose.

Indicated temperatures just above the freezing point do not guarantee that the road surface is free of ice. The road may still be icy, especially in wooded areas or on bridges.

The outside temperature is displayed in the instrument cluster (▷ page 26).

The temperature sensor is located in the front bumper area. Due to its location, the sensor can be affected by road or engine heat during idling or slow driving. This means that the accuracy of the displayed temperature can only be verified by comparison to a thermometer placed next to the sensor, not by comparison to external displays (e.g. bank signs etc.).

When moving the vehicle into colder ambient temperatures (e.g. when leaving your garage), you will notice a delay before the lower temperature is displayed.

A delay also occurs when ambient temperatures rise. This prevents inaccurate temperature indications caused by heat radiated from the engine during idling or slow driving.

▼ Control system

The control system is activated as soon as the SmartKey in the starter switch is turned to position **1** or as soon as the KEYLESS-GO start/stop button* is in position **1**. The control system enables you to:

- call up information about your vehicle
- change vehicle settings

For example, you can use the control system to find out when your vehicle is next due for service, to set the language for messages in the multifunction display, and much more.

i *The displays for the audio systems (radio, CD player) will appear in English, regardless of the language selected.*

Warning!



A driver's attention to the road and traffic conditions must always be his/her primary focus when driving.

For your safety and the safety of others, selecting features through the multifunction steering wheel should only be done by the driver when traffic and road conditions permit it to be done safely.

Bear in mind that at a speed of just 30 mph (approximately 50 km/h), your vehicle is covering a distance of 44 feet (approximately 14 m) every second.

The control system relays information to the multifunction display.

Multifunction display



- ① Outside temperature
- ② Trip odometer
- ③ Automatic transmission program mode
- ④ Main odometer
- ⑤ Current gear selector lever position

Above illustration shows the standard display.

For more information on menus displayed in the multifunction display, see “Menus” (▷ page 144).

Control system

Multifunction steering wheel

The displays in the multifunction display and the settings in the control system (▷ page 141) are controlled by the buttons on the multifunction steering wheel.

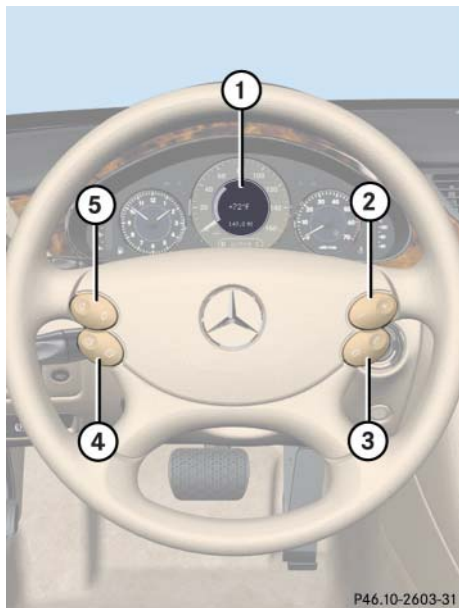

- ① Multifunction display in the speedometer

Operating the control system

- ② Selecting the submenu or setting the volume:

Press button

 up/to increase

 down/to decrease

- ③ Telephone*:

Press button

 to take a call
to dial
to redial

 to end a call
to reject an incoming call

- ④ Menu systems:

Press button

 for next menu

 for previous menu

- ⑤ Moving within a menu:
Press button

 for next display





 for previous display

Depending on the selected menu (▷ page 145), pressing the buttons on the multifunction steering wheel will alter what is shown in the multifunction display.

The information available in the multifunction display is arranged in menus, each containing a number of functions or sub-menus.

The individual functions are then found within the relevant menu (radio or CD operations under AUDIO, for example). These functions serve to call up relevant information or to customize the settings for your vehicle.

It is helpful to think of the menus, and the functions within each menu, as being arranged in a circular pattern.

- If you press button  or  repeatedly, you will pass through each menu one after the other.
- If you press button  or  repeatedly, you will pass through each function display, one after the other, in the current menu.

In the *Settings* menu, instead of functions you will find a number of submenus for calling up and changing settings. For instructions on using these submenus, see the “Settings menu” section (▷ page 154).

The number of menus available in the system depends on which optional equipment is installed in your vehicle.

The menus are described on the following pages.

Control system

Menus

This is what you will see when you scroll through the menus.

The table on the next page provides an overview of the individual menus.

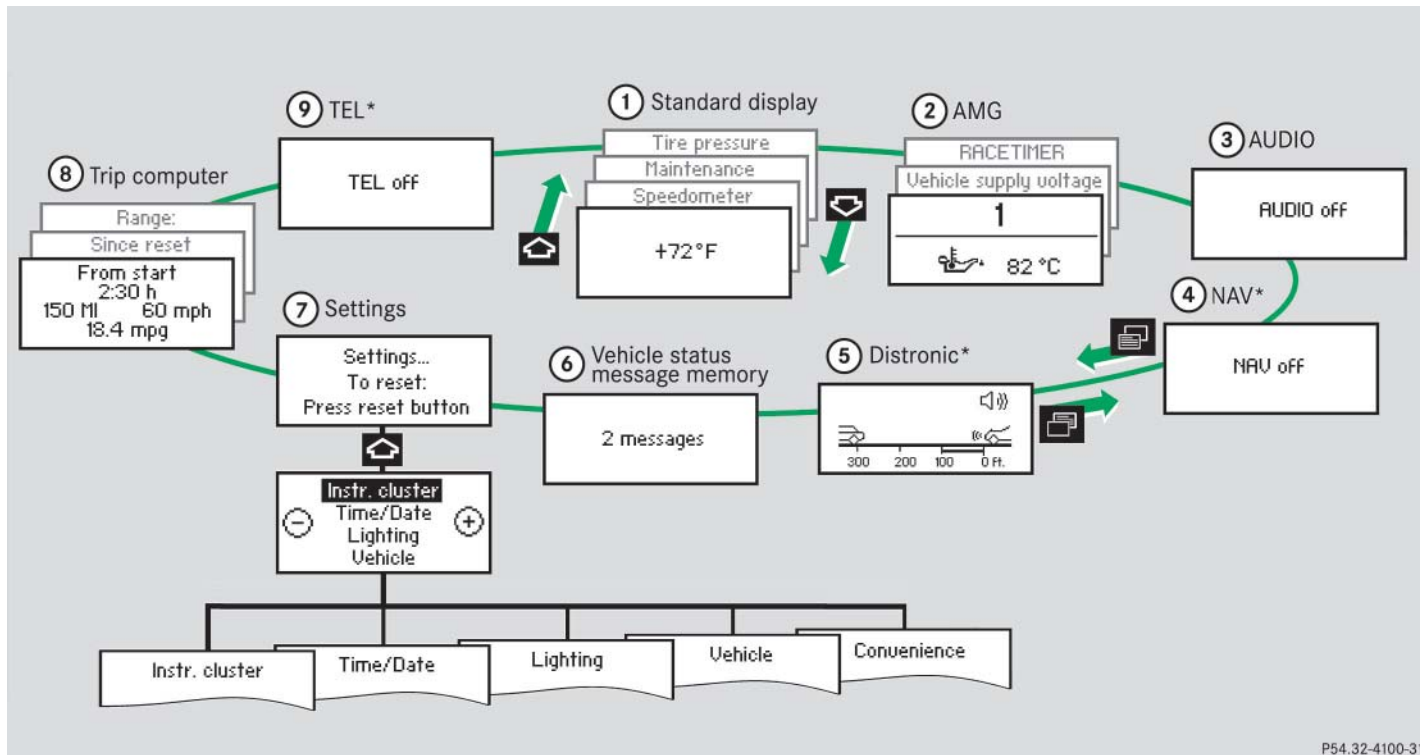

P54.32-4100-31

Menus, submenus and functions

	Menu ①	Menu ②	Menu ③	Menu ④	Menu ⑤
	Standard display (▷ page 147)	AMG¹ (▷ page 147)	AUDIO (▷ page 150)	NAV* (▷ page 152)	Distronic* (▷ page 153)
Commands/submenus	Digital speedometer Calling up maintenance system display Checking tire inflation pressure	Engine oil temperature Vehicle supply voltage RACETIMER Overall analysis Lap analysis	Selecting radio station Selecting satellite radio station* Operating CD player	Showing route guidance instructions, current direction traveled	Calling up settings

¹ AMG vehicles only.

Control system



	Menu ⑥ Vehicle status message memory ¹ (▷ page 153)	Menu ⑦ Settings (▷ page 154)	Menu ⑧ Trip computer (▷ page 167)	Menu ⑨ TEL* (▷ page 168)
Commands/submenus	Calling up vehicle malfunction, warning and system status messages stored in memory	Resetting to factory settings Instrument cluster submenu Time/Date submenu Lighting submenu Vehicle submenu Convenience submenu	Fuel consumption statistics since start Fuel consumption statistics since the last reset Resetting fuel consumption statistics Distance to empty	Loading phone book Searching for name in phone book

¹ The vehicle status message memory menu is only displayed if there is a message stored.

i *The headings used in the menus table are designed to facilitate navigation within the system and are not necessarily identical to those shown in the control system displays.*

The first function displayed in each menu will automatically show you which part of the system you are in.



Standard display menu

- ▶ Press button  or  repeatedly to select the functions in the standard display menu.

The following functions are available:

Function	Page
Calling up digital speedometer	147
Calling up maintenance display	329
Checking tire inflation pressure	302

Display digital speedometer

- ▶ Press button  or  repeatedly until the digital speedometer appears in the multifunction display.

AMG menu

i This function is only available in AMG vehicles.



The main screen of the AMG menu shows you the gear currently engaged as well as the engine oil temperature.

- ▶ Press button  or  repeatedly until the AMG menu appears.



- ① Gear indicator
- ② Engine oil temperature

i The engine oil temperature symbol flashes if the engine oil temperature has not yet reached 80°C. During this time, avoid driving at full engine speed.



Use buttons  or  to select the following functions in the AMG menu:

Function	Page
Vehicle supply voltage	148
RACETIMER	148
Overall analysis	150
Lap analysis	150

i If the engine reaches the overspeed range in the manual shift program, the menu will be shown in red. In addition, you will see **UP** next to gear indicator ① as a reminder to upshift.

Control system

Vehicle supply voltage

- ▶ Press button  or  repeatedly until the AMG menu appears.
- ▶ Press button  repeatedly until you see the vehicle supply voltage.

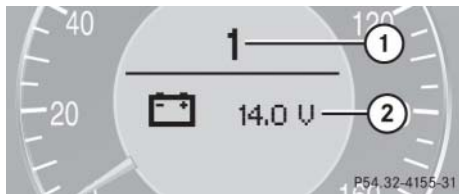

- ① Gear indicator
- ② Vehicle supply voltage



RACETIMER

Warning!



The RACETIMER feature is only for use on roads and in conditions where high speed driving is permitted. Racing on public roads is prohibited under all circumstances and the driver is and must always remain responsible for following posted speed limits.

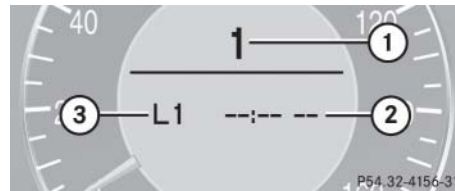

The RACETIMER allows you to time and save driving stretches in hours, minutes and seconds.

- ▶ Press button  or  repeatedly until you see the AMG menu.
- ▶ Press button  repeatedly until you see the RACETIMER.



- ① Gear indicator
- ② RACETIMER
- ③ Lap

i You can start the RACETIMER when the engine is running or the starter switch is in position 2 (> page 38).

i While the RACETIMER is being displayed, you cannot adjust the volume using buttons  or .

Starting the RACETIMER

- ▶ Press button .

The timer starts.

Displaying intermediate time

- ▶ Press button **−** while the timer is running.

The intermediate time is shown for 5 seconds.

Stopping the RACETIMER

- ▶ Press button **+**.

The timer stops.

i When you stop the vehicle and turn the Smartkey to position 1 (▷ page 38) or, in vehicles with KEYLESS-GO*, turn off the engine and do not open the driver's door, the RACETIMER stops timing. Timing is resumed when you switch the ignition back on (▷ page 38) or restart the engine (▷ page 51) and then press the **+** button.

Saving lap time and starting a new lap

i You can save up to nine laps.

- ▶ Press button **−** while the timer is running.

The intermediate time will be shown for 5 seconds.

- ▶ Press button **−** within the next 5 seconds.

The intermediate time shown will be saved as a lap time.

The RACETIMER begins timing the new lap. The new lap begins to be timed as soon as the intermediate time is called up.



- ① Gear indicator
- ② RACETIMER
- ③ Best lap time
- ④ Lap number

Resetting current lap

- ▶ Press button **+** while the timer is running.

The timer stops.

- ▶ Press button **−**.

The lap time is reset to “0”.

Deleting all laps

i It is not possible to delete a single saved lap.

- ▶ Press button **+** while the timer is running.

The timer stops.

- ▶ Press the reset button twice (▷ page 26).

- ▶ Press button **+**.



The timer starts. The saved laps are deleted.

i When you switch off the engine, the RACETIMER will be reset to “0” after 30 seconds. All laps are deleted.

Control system

Overall analysis

i These functions are only available if you have saved at least one lap and have stopped the RACETIMER.

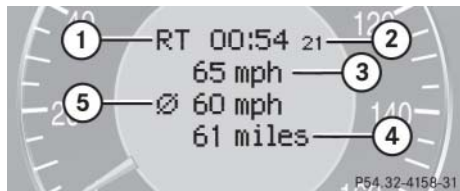

- ▶ Press button  or  repeatedly until you see the AMG menu.
- ▶ Press button  repeatedly until you see the overall analysis.



- ① Overall analysis of RACETIMER
- ② Overall driving time
- ③ Maximum speed
- ④ Overall distance driven
- ⑤ Average speed

Lap analysis

i These functions are only available if you have saved at least two laps and have stopped the RACETIMER.

- ▶ Press button  or  repeatedly until you see the AMG menu.
- ▶ Press button  repeatedly until you see the lap analysis.

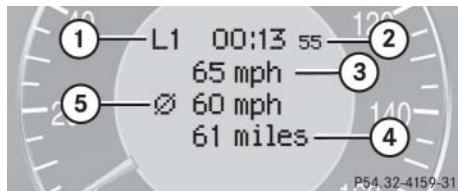

- ① Lap number
- ② Lap time
- ③ Maximum speed
- ④ Lap length
- ⑤ Average speed during lap

- ▶ Press button  or  to see other lap analyses.

i Each lap is shown in its own submenu. The fastest lap is indicated by flashing symbol ①.

AUDIO menu



The functions in the AUDIO menu operate the audio equipment which you currently have turned on.

If no audio equipment is currently turned on, the message AUDIO off is shown in the multifunction display.

The following functions are available:

Function	Page
Selecting radio station	151
Selecting satellite radio station*	151
Operating CD player	151

Selecting radio station

- ▶ Turn on COMAND and select radio. Refer to separate COMAND operating instructions.
- ▶ Press button  or  repeatedly until the currently tuned station in the multifunction display appears.



- ① Waveband setting
- ② Station frequency

- ▶ Press button  or  repeatedly until the desired station is found.

i You can only store new stations using the corresponding feature on the radio, see separate operating instructions.

You can also operate the radio in the usual manner.



Selecting satellite radio station* (USA only)

The satellite radio is treated as a radio application.

- ▶ Select SAT radio with the corresponding softkey in the radio menu.



- ① SAT mode and preset number
- ② Setting for station selection using memory
- ③ Channel name or number

- ▶ Press button  or  repeatedly until the desired channel is found.

i Additional optional satellite radio equipment and a subscription to satellite radio service provider are required for satellite radio operation. Contact an authorized Mercedes-Benz Center for details and availability for your vehicle.



For more information, refer to separate COMAND operating instructions.

Operating CD player

i The COMAND system and the CD changer can play audio CDs as well as MP3-CDs.

For more information on operating the CD changer refer to separate COMAND operating instructions.

Selecting CD track

- ▶ Turn on COMAND and select CD or CD changer. Refer to separate COMAND operating instructions.
- ▶ Press button  or  repeatedly until the settings for the CD currently being played appear in the multifunction display.



Control system

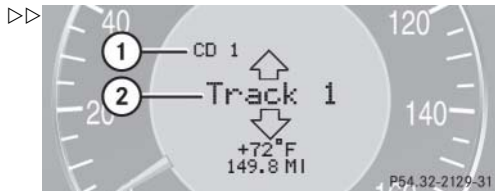



- ① Current CD (for CD changer)
- ② Current track

▶ Press button  or  repeatedly until the desired track is selected.

i To select a CD from the CD changer magazine, press a number on the COMAND system key pad located in the center console.

Selecting MP3-CD track

- ▶ Turn on COMAND and select CD or CD changer*. Refer to separate COMAND operating instructions.
- ▶ Press button  or  repeatedly until the settings for the MP3-CD currently being played appear in the multifunction display.

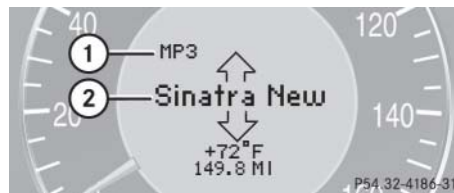



- ① MP3 mode
- ② Current track

i Level of information displayed will vary depending on the information contained on the MP3-CD insert in the single CD player of the COMAND system.

To select a MP3-CD from the CD changer magazine, press a number on the COMAND system key pad located in the center console.

NAV* menu

The NAV menu contains the functions needed to operate your navigation system.



- ▶ Press button  or  repeatedly until the message NAV appears in the multifunction display.
- If COMAND is switched off, the message NAV off is shown in the multifunction display.
- With COMAND switched on but route guidance not activated, the direction of travel and, if available, the name of the street currently traveled on appear in the multifunction display.
- With COMAND switched on and route guidance activated, the direction of travel and maneuver instructions appear in the multifunction display.

Please refer to the COMAND manual for instructions on how to activate the route guidance system.

Distronic* menu

Use the DISTRONIC menu to display the current settings for your DISTRONIC system. What information is shown in the multifunction display depends on whether the DISTRONIC system is active or inactive.

Please refer to the “Driving systems” section of this manual (> page 218) for instructions on how to activate DISTRONIC.

- ▶ Press button  or  repeatedly until one of the following two pictures appears in the multifunction display.

Distronic deactivated

When DISTRONIC is deactivated, you will see the standard display in the multifunction display.

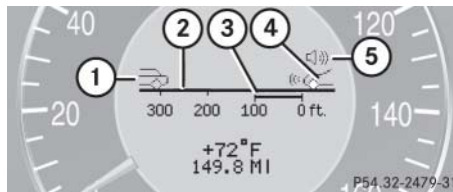

- ① Vehicle ahead, if detected
- ② Actual distance to vehicle ahead
- ③ Preset distance threshold to vehicle ahead
- ④ Your vehicle
- ⑤ Symbol for activated distance warning function

Distronic activated

With DISTRONIC activated, the DISTRONIC display is shown in the multifunction display and one or two segments around the set speed are illuminated in the speedometer.

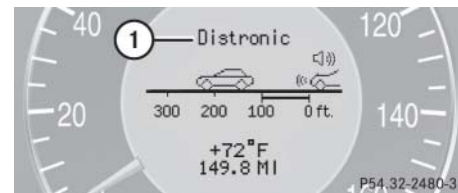

- ① DISTRONIC activated

Vehicle status message memory menu

Use the vehicle status message memory menu to scan malfunction and warning messages that may be stored in the system. Such messages appear in the multifunction display and are based on conditions or system status the vehicle's system has recorded.



Control system

The vehicle status message memory menu only appears if there are any messages stored.

Warning!





Malfunction and warning messages are only indicated for certain systems and are intentionally not very detailed. The malfunction and warning messages are simply a reminder with respect to the operation of certain systems and do not replace the owner's and/or driver's responsibility to maintain the vehicle's operating safety by having all required maintenance and safety checks performed on the vehicle and by bringing the vehicle to an authorized Mercedes-Benz Center to address the malfunction and warning messages (▷ page 356).

- ▶ Press button  or  repeatedly until the vehicle status message memory appears in the multifunction display.

Vehicle status messages have been recorded

If conditions have occurred causing status messages to be recorded, the number of messages appears in the multifunction display:



- ▶ Press button  or .

The stored messages will now be displayed in the order in which they have occurred. For malfunction and warning messages, see “Vehicle status messages in the multifunction display” (▷ page 356).



Should the vehicle's system record any conditions while driving, the number of messages will reappear in the multifunction display when the SmartKey in the starter switch is turned to position **0** or removed from the starter switch.

i *The vehicle status message memory will be cleared when you turn the SmartKey in the starter switch to position **1** or **2**. You will then only see high priority messages in the multifunction display (▷ page 356).*

Settings menu

In the Settings menu there are two functions:

- The function To reset: Press reset button for 3 seconds, with which you can reset all the settings to the original factory settings.
- A collection of submenus with which you can make individual settings for your vehicle.

- ▶ Press button  or  repeatedly until the Settings menu is seen in the multifunction display.



Resetting all settings

You can reset all the functions of all submenus to the factory settings.

- ▶ Press the reset button (▷ page 138) for approximately 3 seconds.

In the multifunction display you will see the request to press the reset button again to confirm.

- ▶ Press the reset button again.

The functions of all the submenus will reset to factory settings.

 *The settings you have changed will not be reset unless you confirm the action by pressing the reset button a second time. After approximately five seconds, the Settings menu reappears in the multifunction display.*

For safety reasons, the Headlamp mode function in the Lighting submenu is not reset while driving.

Submenus in the Settings menu



- ▶ Press button .



In the multifunction display the collection of the submenus appears.





- ▶ Press button .

The selection marker moves to the next submenu.

The submenus are arranged by hierarchy. Scroll down with the  button, scroll up with the .

With the selection marker on the desired submenu, use the  button to access the individual functions within that submenu. Once within the submenu, you can use the button  to move to the next function or the button  to move to the previous function within that submenu.

The settings themselves are made with button  or .

Control system

The table below shows what settings can be changed within the various menus.

Detailed instructions on making individual settings can be found on the following pages.

Instrument cluster (▷ page 157)	Time/Date (▷ page 159)	Lighting (▷ page 161)	Vehicle (▷ page 164)	Convenience (▷ page 165)
Selecting speedometer display mode	Synchronizing the time	Setting daytime running lamp mode (USA only)	Setting automatic locking	Activating easy-entry/exit feature
Selecting language	Setting time (hours)	Setting locator lighting	Audio search function	Setting parking position for exterior rear view mirror ¹
Selecting display (speed display or outside temperature) for status line	Setting time (minutes)	Setting ambient lighting		
Selecting display (speed display or outside temperature) for basic display	Setting date (month)	Setting night security illumination		
	Setting date (day)	Setting interior lighting delayed shut-off		
	Setting date (year)			

¹ If equipped

Instrument cluster submenu

Access the Instr. cluster submenu via the Settings menu. Use the Instr. cluster submenu to change the instrument cluster display settings. The following functions are available:

Function	Page
Selecting speedometer display mode	157
Selecting language	157
Selecting display (speed display or outside temperature) for status display	158
Selecting display (speed display or outside temperature) for basic display	158

Selecting speedometer display mode

- ▶ Move the selection marker with the **+** or **-** button to the Instr. cluster submenu.
- ▶ Press button **▲** or **▼** repeatedly until the message **Display unit Speed-/odometer** appears in the multifunction display.

The selection marker is on the current setting.



- ▶ Press button **+** or **-** to set speedometer unit to km or miles.

Selecting language

- ▶ Move the selection marker with the **+** or **-** button to the Instr. cluster submenu.
- ▶ Press button **▲** or **▼** repeatedly until the message **Language** appears in the multifunction display.

The selection marker is on the current setting.



Control system

- ▷▷ Press button **+** or **-** to select the language to be used for the multifunction display messages.

Available languages:

- German
- English
- French
- Italian
- Spanish
- Dutch
- Danish
- Swedish
- Portuguese
- Turkish
- Russian (Canada only)

Selecting display (speed display or outside temperature) for status line display

- ▶ Move the selection marker with the **+** or **-** button to the Instr. cluster submenu.
- ▶ Press button **↕** or **↕** repeatedly until the message *Status line display* appears in the multifunction display.

The selection marker is on the current setting.

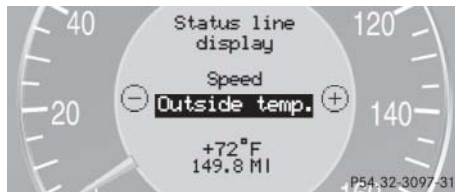

- ▶ Press button **+** or **-** to select the status line to *Speed* or *Outside temp.*

i You will see the status indicator when you have called up a different display from the standard display.

Selecting display (speed display or outside temperature) for basic display

- ▶ Move the selection marker with the **+** or **-** button to the Instr. cluster submenu.
- ▶ Press button **↕** or **↕** repeatedly until the message *Basic display* appears in the multifunction display.

The selection marker is on the current setting.



- ▶ Press button **+** or **-** to select the display permanently shown in the multifunction display.

Time/Date submenu

Access the **Time/Date** submenu via the **Settings** menu. Use the **Time/Date** submenu to change the time and date display settings. The following functions are available:

Function	Page
Synchronizing the time	159
Setting time (hours)	159
Setting time (minutes)	160
Setting date (month)	160
Setting date (day)	160
Setting date (year)	161

i Information on setting the time, refer to separate **COMAND** instructions.

Synchronizing the time

This function can only be seen on vehicles with **COMAND** and navigation module*.

- ▶ Move the selection marker with the **+** or **-** button to the **Time/Date** submenu.
- ▶ Press button **▲** or **▼** repeatedly until the message **Time, synchroniz. with Head Unit** appears in the multifunction display.

The selection marker is on the current setting.

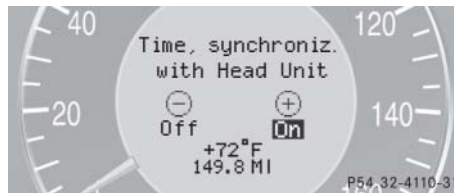

- ▶ Press button **+** or **-** to select the desired setting.

Setting time (hours)

This function can only be seen when time synchronization is switched off.

- ▶ Move the selection marker with the **+** or **-** button to the **Time/Date** submenu.
- ▶ Press button **▲** or **▼** repeatedly until the message **Time, hours** appears in the multifunction display.

The selection marker is on the hour setting.

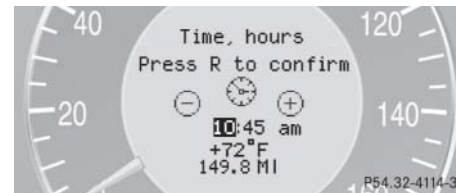

- ▶ Press button **+** or **-** to set the hour.
- ▶ Confirm by pressing reset button (▷ page 138).

Control system

Setting time (minutes)

This function can only be seen when time synchronization is switched off.

- ▶ Move the selection marker with the **+** or **-** button to the Time/Date submenu.
- ▶ Press button **↕** or **↓** repeatedly until the message Time, minute(s) Press R to confirm appears in the multifunction display.

The selection marker is on the minute setting.



- ▶ Press button **+** or **-** to set the minutes.
- ▶ Confirm by pressing reset button (▷ page 138).

Setting date (month)

- ▶ Move the selection marker with the **+** or **-** button to the Time/Date submenu.
- ▶ Press button **↕** or **↓** repeatedly until the message Set date Month appears in the multifunction display.

The selection marker is on the month setting.



- ▶ Press button **+** or **-** to set the month.

Setting date (day)

- ▶ Move the selection marker with the **+** or **-** button to the Time/Date submenu.
- ▶ Press button **↕** or **↓** repeatedly until the message Set date Day appears in the multifunction display.

The selection marker is on the day setting.



- ▶ Press button **+** or **-** to set the day.

Setting date (year)

- ▶ Move the selection marker with the **+** or **-** button to the Time/Date submenu.
- ▶ Press button **↕** or **↓** repeatedly until the message Set date Year appears in the multifunction display.

The selection marker is on the year setting.



- ▶ Press button **+** or **-** to set the year.

Lighting submenu

Access the Lighting submenu via the Settings menu. Use the Lighting submenu to change the lamp and lighting settings on your vehicle. The following functions are available:

Function	Page
Setting daytime running lamp mode (USA only)	161
Setting locator lighting	162
Setting ambient lighting	163
Setting night security illumination	163
Setting interior lighting delayed shut-off	164

Setting daytime running lamp mode (USA only)

i This function is not available in countries where the daytime running lamp mode is mandatory and therefore in a constant mode.

- ▶ Move the selection marker with button **+** or **-** to the Lighting submenu.
- ▶ Press button **↕** or **↓** repeatedly until the message Headlamp mode appears in the multifunction display.

The selection marker is on the current setting.

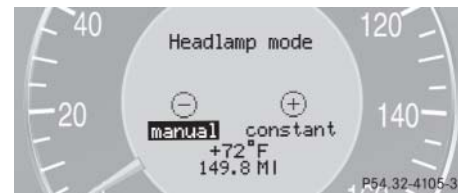

- ▶ Press button **+** or **-** to select manual operation (manual) or daytime running lamp mode (constant). ▷▷

Control system

▷▷ With daytime running lamp mode activated and the exterior lamp switch in position **0** or **AUTO**, the low beam headlamps are switched on when the engine is running.

In low ambient light conditions the following lamps will switch on additionally:

- Parking lamps
- Tail lamps
- License plate lamps
- Side marker lamps

For more information on the daytime running lamp mode, see “Lighting” (▷ page 128).

i For safety reasons, resetting the Lighting submenu to factory settings while driving (▷ page 155) will not deactivate the daytime running lamp mode.

The following message appears in the multifunction display: Cannot be completely reset to factory settings while driving.

Setting locator lighting

With the locator lighting feature activated and the exterior lamp switch in position **AUTO**, the following lamps will switch on during darkness when the vehicle is unlocked with the SmartKey or KEYLESS-GO*:

- Parking lamps
- Tail lamps
- License plate lamps
- Side marker lamps
- Front fog lamps

The locator lighting switches off when the driver’s door is opened.

If you do not open a door after unlocking the vehicle with the SmartKey, the lamps will switch off automatically after approximately 40 seconds.

- ▶ Move the selection marker with button **+** or **-** to the Lighting submenu.

- ▶ Press button **↶** or **↷** repeatedly until the message Function Surround lighting appears in the multifunction display.

The selection marker is on the current setting.

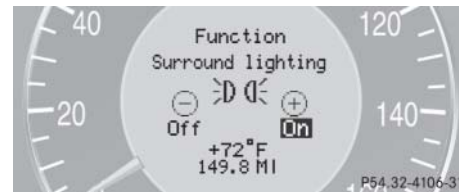

- ▶ Press button **+** or **-** to switch the locator lighting function On or Off.
- ▶ Turn the exterior lamp switch to position **AUTO** when exiting the vehicle. The locator lighting feature is activated.

Setting ambient lighting

Use this function to adjust the brightness of the ambient lighting.

- ▶ Move the selection marker with button **+** or **-** to the Lighting submenu.
- ▶ Press button **↕** or **↙** repeatedly until the message Ambient light level appears in the multifunction display.

The selection marker is on the current setting.

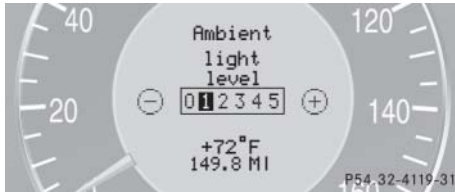

- ▶ Press button **+** or **-** to select the desired brightness of the ambient lighting.

The setting 1 represents the darkest level and setting 5 the brightest level.

The ambient light is switched off at setting 0.

Setting night security illumination (Headlamps delayed shut-off feature)

Use this function to set whether you would like the exterior lamps to remain on for 15 seconds during darkness after exiting the vehicle and closing all doors.

With the delayed shut-off feature activated and the exterior lamp switch in position **AUTO** before the engine is turned off, the following lamps will switch on when the engine is turned off.

- Parking lamps
- Tail lamps
- License plate lamps
- Side marker lamps
- Front fog lamps

If after turning off the engine you do not open a door or do not close an opened door, the lamps will automatically switch off after 60 seconds.

- ▶ Move the selection marker with button **+** or **-** to the Lighting submenu.
- ▶ Press button **↕** or **↙** repeatedly until the message Headlamps delayed shut-off appears in the multifunction display.

The selection marker is on the current setting.



- ▶ Press button **+** or **-** to switch the headlamps delayed shut-off feature On or Off.
- ▶ Turn the exterior lamp switch to position **AUTO** before turning off the engine.

The headlamps delayed shut-off feature is activated.

Control system

You can temporarily deactivate the delayed shut-off feature:

- ▶ Before exiting the vehicle, turn the SmartKey in the starter switch to position **0**.
- ▶ Then turn it to position **2** and back to position **0**.

The delayed shut-off feature is deactivated. It will reactivate as soon as you reinsert the SmartKey in the starter switch.

Vehicles with KEYLESS-GO*:

- ▶ Press the KEYLESS-GO start/stop button on the gear selector lever (▷ page 39).

Setting interior lighting delayed shut-off

Use this function to set whether you would like the interior lighting to remain lit during darkness for 10 seconds after you have removed the SmartKey from the starter switch.

- ▶ Move the selection marker with button **+** or **-** to the **Lighting** submenu.
- ▶ Press button **▲** or **▼** repeatedly until the message **Interior lighting delayed shut-off** appears in the multifunction display.

The selection marker is on the current setting.

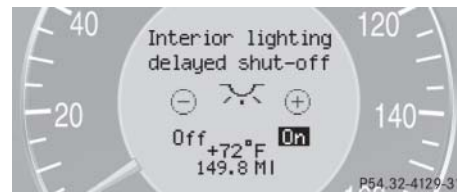

- ▶ Press button **+** or **-** to switch the interior lighting delayed shut-off feature **On** or **Off**.

Vehicle submenu

Access the **Vehicle** submenu via the **Settings** menu. Use the **Vehicle** submenu to make general vehicle settings. The following functions are available:

Function	Page
Setting automatic locking	165
Audio search function	165

Setting automatic locking

Use this function to activate or deactivate the automatic central locking. With the automatic central locking system activated, the vehicle is centrally locked at vehicle speeds of approximately 9 mph (15 km/h).

- ▶ Move the selection marker with the **+** or **-** button to the Vehicle submenu.
- ▶ Press button **▲** or **▼** repeatedly until the message **Automatic door locking** appears in the multifunction display.

The selection marker is on the current setting.



- ▶ Press button **+** or **-** to switch Automatic door locking On or Off.

Setting station selection mode

Use the Audio search function to select the manual or memory station selection mode for the radio (▷ page 150).

- ▶ Move the selection marker with the **+** or **-** button to the Vehicle submenu.
- ▶ Press button **▲** or **▼** repeatedly until the message **Audio search function** appears in the multifunction display.

The selection marker is on the current setting.



- ▶ Press **+** or **-** to select the desired station selection mode. You can select:

- frequenc.
- memory selects next stored station

Convenience submenu

Access the Convenience submenu via the Settings menu. Use the Convenience submenu to change the settings for a number of convenience features. The following functions are available:

Function	Page
Activating easy-entry/exit feature	166
Setting parking position for exterior rear view mirror ¹	166

¹ If equipped

Control system

Activating easy-entry/exit feature

Use this function to activate and deactivate the easy-entry/exit feature (▷ page 45).

Warning!





You must make sure no one can become trapped or injured by the moving steering wheel when the easy-entry/exit feature is activated.

To stop steering wheel movement, do one of the following:

- Move steering wheel adjustment stalk (▷ page 44).
- Press one of the memory position buttons or the memory button **M** (▷ page 126).

Do not leave children unattended in the vehicle, or with access to an unlocked vehicle. Children could open the driver's door and unintentionally activate the easy-entry/exit feature, which could result in an accident and/or serious personal injury.

- ▶ Move the selection marker with the **+** or **-** button to the Convenience submenu.
- ▶ Press button  or  repeatedly until the message *Easy-entry function* appears in the multifunction display.

The selection marker is on the current setting.





- ▶ Press button **+** or **-** to switch *Easy-entry function* On or Off.

Setting parking position for exterior rear view mirror

Depending on production date, your vehicle may not be equipped with this function.

Use the *Mirror adjust. parking aid* function to select whether the passenger-side exterior rear view mirror should be turned downward during parking maneuvers when reverse gear **R** is engaged. For additional information, see “Activating exterior rear view mirror parking position” (▷ page 187).

- ▶ Move the selection marker to the Convenience submenu using the **+** or **-** button.
- ▶ Press button  or  repeatedly until you see *Mirror adjust. parking aid* in the multifunction display.

The selection marker is on the current setting.



- ▶ Press button **+** or **-** to switch function On or Off.

Trip computer menu

Use the trip computer menu to call up statistical data on your vehicle. The following information is available:

Function	Page
Fuel consumption statistics since start	167
Fuel consumption statistics since last reset	167
Resetting fuel consumption statistics	168
Distance to empty	168

Fuel consumption statistics since start

- ▶ Press button or repeatedly until the first function of the trip computer menu appears.
- ▶ Press button or repeatedly until the message From start appears in the multifunction display.



- ① Distance driven since start
- ② Time elapsed since start
- ③ Average speed since start
- ④ Average fuel consumption since start

Fuel consumption since last reset

- ▶ Press button or repeatedly until the first function of the trip computer menu appears.

- ▶ Press button or repeatedly until the message Since reset appears in the multifunction display.

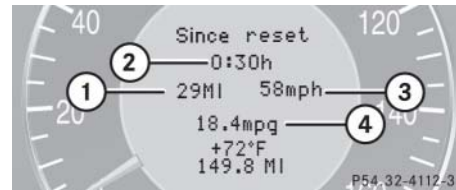





- ① Distance driven since last reset
- ② Time elapsed since last reset
- ③ Average speed since last reset
- ④ Average fuel consumption since last reset

i All statistics stored since the last engine start will be reset approximately 4 hours after the SmartKey in the starter switch is turned to position 0 or removed from the starter switch.





Resetting will not occur if you turn the SmartKey back to position 1 or 2 within this time period.

Control system

Resetting fuel consumption statistics

- ▶ Press button  or  repeatedly until the first function of the trip computer menu appears.
- ▶ Press button  or  repeatedly until the reading that you want to reset in the multifunction display appears.
- ▶ Press and hold the reset button (\triangleright page 138) until the value is reset to 0.

Distance to empty

- ▶ Press button  or  repeatedly until the first function of the trip computer menu appears.
- ▶ Press button  or  repeatedly until the message **Range:** appears in the multifunction display.

The calculated remaining driving range based on the current fuel tank level appears in the multifunction display.



i *If only very little fuel is left in the tank, a vehicle at the fuel pump is shown instead of the range.*

TEL* menu

Warning!





A driver's attention to the road must always be his/her primary focus when driving. For your safety and the safety of others, we recommend that you pull over to a safe location and stop before placing or taking a telephone call. If you choose to use the telephone while driving, please use the hands-free device and only use the telephone when weather, road and traffic conditions permit.

Some jurisdictions prohibit the driver from using a cellular telephone while driving a vehicle.

Bear in mind that at a speed of just 30 mph (approximately 50 km/h), your vehicle is covering a distance of 44 feet (approximately 14 m) every second.

Never operate radio transmitters equipped with a built-in or attached antenna (i.e. without being connected to an external antenna) from inside the vehicle while the engine is running. Doing so could lead to a malfunction of the vehicle's electronic system, possibly resulting in an accident and/or personal injury.

You can use the functions in the **Te1** menu to operate your telephone, provided it is connected to a hands-free system and switched on.

- ▶ Switch on the telephone and COMAND.
- ▶ Press button  or  on the steering wheel repeatedly until the **Te1** menu appears in the multifunction display.

Which messages will appear in the multifunction display depends on whether your telephone is switched on or off:

- If the telephone is off, the message in the multifunction display is: **TEL off.**
- If the telephone is on:

The telephone will then search for a network. During this time the multifunction display is empty.

As soon as the telephone has found a network, **READY** appears in the multifunction display.



This standby message indicates that your telephone is ready for use and you can operate it using the control system.

Answering a call

When your telephone is ready to receive calls, you can answer a call at any time. In the multifunction display you will then see the message or if supported, the caller ID (name and number):



- ▶ Press button .

You have answered the call. In the multifunction display you see the length of the call.





Ending and rejecting a call

- ▶ Press button .

Control system



Dialing a number from the phone book

If your telephone is ready to receive calls, you may select and dial a number from the phone book at any time.



- ▶ Press button  or  repeatedly until the **Te1** menu appears in the multifunction display.
- ▶ Press button  or .

The control system reads the phone book which is stored in the telephone. This may take several minutes. In the multifunction display you will see the message **Please wait**.

When the message **Please wait** disappears, the phone book has been loaded.

- ▶ Press button  or  repeatedly until the desired name appears in the multifunction display.

The stored names are displayed in ascending or descending alphabetical order.

 If you press and hold  or  for longer than 1 second, the system scrolls rapidly through the list of names until you release the button again.

Cancel the quick search mode by pressing .

- ▶ Press button .

The system dials the selected phone number.



- If the connection is successful, the name of the party you called and the duration of the call will appear in the multifunction display.





- If no connection is made, the control system stores the dialed number in the redial memory.

Redialing

The control system stores the most recently dialed phone numbers. This eliminates the need to search through your entire phone book.

- ▶ Press button  or  repeatedly until the **Te1** menu appears in the multifunction display.
- ▶ Press button .

In the multifunction display the first number in the redial memory appears.

- ▶ Press button  or  repeatedly until the desired name appears in the multifunction display.
- ▶ Press button .

The control system dials the selected phone number.

▼ Automatic transmission

For more information on driving with an automatic transmission, see “Automatic transmission” (▷ page 51).

Your vehicle’s transmission adapts its gear shifting process to your individual driving style by continually adjusting the shift points up or down. These shift point adjustments are performed based on current operating and driving conditions.

If the operating conditions change, the automatic transmission reacts by adjusting its shift program.

i *During the brief warm-up, transmission upshifting is delayed. This allows the catalytic converter to heat up more quickly to operating temperature.*

Warning!



Make sure that absolutely no objects are obstructing the pedals’ range of movement. Keep the driver’s footwell clear of all obstacles. If there are any floor mats or carpets in the footwell, make sure that the pedals still have sufficient clearance.

During sudden driving or braking maneuvers the objects could get caught between the pedals. You could then no longer brake or accelerate. This could lead to accidents and injury.

Gear selector lever

The gear selector lever is located on the lower part of the center console.



Gearshift pattern for automatic transmission

- P** Park position
- R** Reverse gear
- N** Neutral
- D** Drive position

i *The current gear selector lever position **P**, **R**, **N** or **D** appears in the multifunction display (▷ page 173).*

Warning!



It is dangerous to shift the gear selector lever out of park position **P** or neutral position **N** if the engine speed is higher than idle speed. If your foot is not firmly on the brake pedal, the vehicle could accelerate quickly forward or reverse. You could lose control of the vehicle and hit someone or something. Only shift into gear when the engine is idling normally and when your right foot is firmly on the brake pedal.

An additional indication of the current gear selector lever position can be found on the cover of the shifting-gate.

The indicators come on when you activate a switch (e.g. unlocking the vehicle or opening a door) and go out after approximately 15 minutes.

Shifting procedure

The automatic transmission selects individual gears automatically, depending on:

- gear selector lever position **D** (▷ page 173) with gear ranges (▷ page 176)
- the selected program mode:
(**C/S**) (▷ page 177)
or
(**M/C/S**) (CLS 63 AMG only)
(▷ page 181)
- the position of the accelerator pedal (▷ page 175)
- the vehicle speed

! Allow engine to warm up under low load use. Do not place full load on the engine until the operating temperature has been reached.

Shift into reverse gear **R** or park position **P** only when the vehicle is stopped.

Avoid spinning of a drive wheel for an extended period when driving off on slippery road surfaces. This may cause serious damage to the drivetrain which is not covered by the Mercedes-Benz Limited Warranty.

When the gear selector lever is in drive position **D**, you can influence transmission shifting by:

- limiting the gear range
- changing gears manually

Gear selector lever positions

The current gear selector lever position appears in the multifunction display.



① Current gear selector lever position

	Effect
P	<p>Park position</p> <p>Gear selector lever position when the vehicle is parked. Place gear selector lever in park position P only when vehicle is stopped. The park position is not intended to serve as a brake when the vehicle is parked. Rather, the driver should always set the parking brake in addition to placing the gear selector lever in park position P to secure the vehicle.</p>

	Effect
	<p>The SmartKey can only be removed from the starter switch with the gear selector lever in park position P. With the SmartKey removed, the gear selector lever is locked in park position P.</p> <p>If the vehicle's electrical system is malfunctioning, the gear selector lever could remain locked in park position P (▷ page 398).</p>
R	<p>Reverse gear</p> <p>Place gear selector lever in position R only when vehicle is stopped.</p>

Automatic transmission

	Effect
N	<p>Neutral</p> <p>No power is transmitted from the engine to the drive axle. When the brakes are released, the vehicle can be moved freely (pushed or towed).</p> <p>To avoid damage to the transmission, never engage neutral position N while driving.</p> <p>If the ESP® is deactivated or malfunctioning: Move gear selector lever to neutral position N only if the vehicle is in danger of skidding, e.g. on icy roads.</p>
D	<p>Drive</p> <p>The transmission shifts automatically. All forward gears are available.</p>

! *Coasting the vehicle, or driving for any other reason with gear selector lever in neutral position **N** can result in transmission damage that is not covered by the Mercedes-Benz Limited Warranty.*

Warning!



Getting out of your vehicle with the gear selector lever not fully engaged in park position **P** is dangerous. Also, park position **P** alone is not intended to or capable of preventing your vehicle from moving, possibly hitting people or objects.

Always set the parking brake in addition to shifting to park position **P** (▷ page 53).

When parked on an incline, turn the front wheels towards the road curb.

Do not park this vehicle in areas where combustible materials such as grass, hay or leaves can come into contact with the hot exhaust system, as these materials could be ignited and cause a vehicle fire.

Warning!



When leaving the vehicle, always remove the SmartKey or SmartKey with KEYLESS-GO* from the starter switch, take it with you, and lock the vehicle. Do not leave children unattended in the vehicle, or with access to an unlocked vehicle. Children could move the gear selector lever from park position **P**, which could result in an accident and/or serious personal injury.

Driving tips

Accelerator position

Your driving style influences the transmission's shifting behavior:

Less throttle	Earlier upshifting
More throttle	Later upshifting

Kickdown

Use kickdown when you want maximum acceleration.

- ▶ Press the accelerator past the point of resistance.

Depending on the engine speed the transmission shifts into a lower gear.

- ▶ Ease on the accelerator when you have reached the desired speed.

The transmission shifts up again.

Stopping

When you stop briefly, e.g. at traffic lights:

- ▶ Leave the transmission in gear.
- ▶ Hold the vehicle with the brake.

When you stop for a longer period of time with the engine idling and/or on a hill:

- ▶ Set the parking brake.
- ▶ Move the gear selector lever to park position **P**.

Maneuvering

When you maneuver in tight areas, e.g. when pulling into a parking space:

- ▶ Control the vehicle speed by gradually releasing the brakes.
- ▶ Accelerate gently.
- ▶ Never abruptly step on the accelerator.

Working on the vehicle

Warning!



When working on the vehicle, set the parking brake and move gear selector lever to park position **P**. Otherwise the vehicle could roll away.

Automatic transmission

Gear ranges

With the gear selector lever in drive position **D** and driving in program mode **C** or **S** (▷ page 177), you can select a gear range for the automatic transmission to operate within.

Gear selector lever (▷ page 178):

You can limit the gear range by pressing the gear selector lever to the left (**D-**), and reverse the gear range limit by pressing the gear selector lever to the right (**D+**).

Steering wheel gearshift control*

(▷ page 179):

You can limit the gear range by pulling the left gearshift paddle on the steering wheel gearshift control, and reverse the gear range limit by pulling the right gearshift paddle on the steering wheel gearshift control.

The selected gear range appears in the multifunction display.



① Current gear range

	Effect
6	The transmission shifts through sixth gear only.
5	The transmission shifts through fifth gear only.
4	The transmission shifts through fourth gear only.

	Effect
3	The transmission shifts through third gear only. With this selection you can use the braking effect of the engine.
2	The transmission shifts through second gear only. Allows the use of engine's braking power when driving <ul style="list-style-type: none"> • on steep downgrades • in mountainous regions • under extreme operating conditions
1	The transmission operates in first gear only. For maximum use of engine's braking effect on very steep or lengthy downgrades.

Automatic shift program

The program mode selector switch is located on the lower part of the center console.



Program mode selector switch

- C** Comfort For comfort driving
- S** Sport For standard driving



Program mode selector switch (CLS 63 AMG only)

- M** Manual For manual gear shifting (▷ page 181)
- C** Comfort For standard driving
- S** Sport For sporty driving

The selected program mode appears in the multifunction display.



① Current program mode

! Never change the program mode when the gear selector lever is out of park position **P**. This could result in a change of driving characteristics for which you may not be prepared.

i The last selected program mode (**C** or **S**) is switched on when the engine is restarted.

Automatic transmission

- ▶ Press program mode selector switch repeatedly until the letter of the desired program mode appears in the multifunction display.

Select **C** for comfort driving (CLS 63 AMG: for standard driving):

- The vehicle starts out in second gear (both forward and reverse) for gentler starts. This does not apply if full throttle is applied or gear range **1** is selected.
- Traction and driving stability are improved on icy roads.
- Upshifts occur earlier even when you give more gas. The engine then operates at lower rpms and the wheels are less likely to spin.

Select **S** for standard driving (CLS 63 AMG: for sporty driving):

- The vehicle starts out in first gear.
- Upshifts occur later.

Gear selector lever one-touch gearshifting

With the gear selector lever in drive position **D** and driving in program mode **C** or **S**, you can limit or extend the gear range.

If your vehicle is equipped with manual shift program **M**, you can use the gear selector lever to manually shift the gears.

i For information on using the gear selector lever in program mode **M**, see “Manual shift program CLS 63 AMG” (▷ page 181).

! Allow engine to warm up under low load use. Do not place full load on the engine until the operating temperature has been reached.

Shift into reverse gear **R** or park position **P** only when the vehicle is stopped.

Avoid spinning of a drive wheel for an extended period when driving off on slippery road surfaces. This may cause serious damage to the drivetrain which is not covered by the Mercedes-Benz Limited Warranty.

The following instructions describe operation of the gear selector lever when driving in the automatic program mode **C** or **S**.

Limiting gear range

Warning!



On slippery road surfaces, never downshift in order to obtain braking action. This could result in drive wheel slip and reduced vehicle control. Your vehicle's ABS will not prevent this type of loss of control.

- ▶ Briefly press the gear selector lever to the left in the **D-** direction.

The transmission will shift to the next lower gear as permitted by the shift program. This action simultaneously limits the gear range of the transmission (▷ page 176).

i To avoid overrevving the engine when downshifting, the transmission will not shift to a lower gear if the engine's max. speed would be exceeded.

Extending gear range

- ▶ Briefly press the gear selector lever to the right in the **D+** direction.

The transmission will shift to the next higher gear as permitted by the shift program. This action simultaneously extends the gear range of the transmission.

 *If you press on the accelerator when the engine has reached its rpm limit, the transmission will upshift beyond any gear range limit selected.*

Canceling gear range limit

- ▶ Press and hold the gear selector lever in the **D+** direction until **D** reappears in the multifunction display (▷ page 173).

The transmission will shift from the current gear range directly to gear range **D**.

Shifting into optimal gear range

- ▶ Press and hold the gear selector lever in the **D-** direction.

The transmission will automatically select the gear range suited for optimal acceleration and deceleration. This will involve shifting down one or more gears.

Steering wheel gearshift control one-touch gearshifting*

Steering wheel gearshift control is available on vehicles with AMG-Sport Package* and CLS 63 AMG only.

With the gear selector lever in drive position **D** and driving in program mode **C** or **S**, you can limit or extend the gear range.

If your vehicle is equipped with manual shift program **M**, you can use the steering wheel gearshift control to manually shift the gears.

 *For information on using the steering wheel gearshift control in program mode **M**, see "Manual shift program CLS 63 AMG" (▷ page 181).*

Automatic transmission

! Allow engine to warm up under low load use. Do not place full load on the engine until the operating temperature has been reached.

Shift into reverse gear **R** or park position **P** only when the vehicle is stopped.

Avoid spinning of a drive wheel for an extended period when driving off on slippery road surfaces. This may cause serious damage to the drivetrain which is not covered by the Mercedes-Benz Limited Warranty.

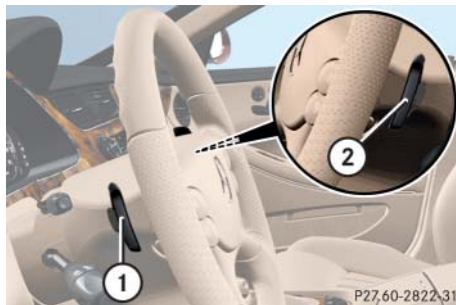

Gearshift paddles (example illustration vehicles with AMG-Sport Package*)

- ① Left shift paddle: limiting gear range or downshift (in program mode **M**)
- ② Right shift paddle: extending gear range or upshift (in program mode **M**)

i You cannot shift with the steering wheel gearshift paddles when the gear selector lever is in position **P**, **N** or **R**.

The following instructions describe operation of the steering wheel gearshift control when driving in the automatic program mode **C** or **S**.

Limiting gear range

Warning!



On slippery road surfaces, never downshift in order to obtain braking action. This could result in drive wheel slip and reduced vehicle control. Your vehicle's ABS will not prevent this type of loss of control.

- ▶ Briefly pull left shift paddle ①.

The transmission will shift to the next lower gear as permitted by the shift program. This action simultaneously limits the gear range of the transmission (▷ page 176).

i To avoid overrevving the engine when downshifting, the transmission will not shift to a lower gear if the engine's max. speed would be exceeded.

Extending gear range

- ▶ Briefly pull right shift paddle ②.

The transmission will shift to the next higher gear as permitted by the shift program. This action simultaneously extends the gear range of the transmission.

i *If you press on the accelerator when the engine has reached its rpm limit, the transmission will upshift beyond any gear range limit selected.*

Canceling gear range limit

- ▶ Pull and hold right shift paddle ② until **D** reappears in the multifunction display (▷ page 173).

The transmission will shift from the current gear range directly to gear range **D**.

Shifting into optimal gear range

- ▶ Pull and hold left shift paddle ①.

The transmission will automatically select the gear range suited for optimal acceleration and deceleration. This will involve shifting down one or more gears.

Manual shift program CLS 63 AMG

In addition to the automatic shift program **C** or **S**, your vehicle is equipped with the manual shift program **M**.

In the manual program mode **M**, system-controlled automatic gearshifting is switched off and you need to change the gears by manually upshifting or downshifting using the steering wheel gearshift paddles (▷ page 180) or the gear selector lever.

! *Allow engine to warm up under low load use. Do not place full load on the engine until the operating temperature has been reached.*

*Shift into reverse gear **R** or park position **P** only when the vehicle is stopped.*

Avoid spinning of a drive wheel for an extended period when driving off on slippery road surfaces. This may cause serious damage to the drivetrain which is not covered by the Mercedes-Benz Limited Warranty.

Automatic transmission

The program mode selector switch is located on the lower part of the center console.



Program mode selector switch

M Manual	For manual gear shifting
C Comfort	For standard driving
S Sport	For sporty driving

The selected program mode appears in the multifunction display (▷ page 177).

i For information on automatic program modes **C** or **S**, see “Automatic shift program” (▷ page 177), “Gear selector lever one-touch gearshifting” (▷ page 178), and “Steering wheel gearshift control one-touch gearshifting*” (▷ page 179).

Activating manual shift program

- ▶ Press program mode selector switch repeatedly until the **M** for manual program mode **M** appears in the multifunction display.

The transmission switches to the manual program mode **M**. Automatic shifting is switched off. The gear range is not limited.

You can change the gears manually when the gear selector lever is in drive position **D**. You can upshift or downshift through the gears in succession.

i The manual program mode **M** will not be stored. When the engine is turned off with the manual program mode **M** selected, the transmission will go to the automatic program mode (**C** or **S**) when the engine is restarted.

Upshifting

! In the manual program mode **M**, the transmission will not upshift, even if the engine has reached its overrevving range. Shift up to the next gear before the engine has reached its overrevving range. Make absolutely certain that the engine speed does not reach the red marking on the tachometer (▷ page 26). Otherwise the engine could be damaged which is not covered by the Mercedes-Benz Limited Warranty.

- ▶ Briefly press the gear selector lever to the right in the **D+** direction.

or

- ▶ Briefly pull right shift paddle ② (▷ page 180).

The transmission shifts to the next higher gear.

If, instead of the manual program mode symbol **M**, the **⬆** symbol appears in the multifunction display (▷ page 177), shift to the next higher gear. The fuel supply will otherwise be interrupted to prevent the engine from overrevving.

If you have selected the AMG menu in the control system and you are driving in the manual program mode **M**, upshift indicator ② in the multifunction display advises you to upshift before the engine reaches the overspeed range. Thus you can drive at the maximum engine speed for each gear without overrevving the engine.

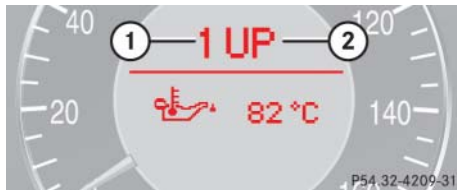

- ① Gear indicator
- ② Upshift indicator

- ▶ Shift to the next higher gear.

The fuel supply will otherwise be interrupted to prevent the engine from overrevving.

Downshifting

Warning!



On slippery road surfaces, never downshift in order to obtain braking action. This could result in drive wheel slip and reduced vehicle control. Your vehicle's ABS will not prevent this type of loss of control.

- ▶ Briefly press the gear selector lever to the left in the **D**-direction.

or

- ▶ Briefly pull left shift paddle ① (▷ page 180).

The transmission shifts to the next lower gear.

- i** *When you brake or stop, the transmission shifts down to a gear from which you can easily accelerate or take off.*

Kickdown

Using the kickdown when driving in the manual program mode **M** is not possible.

Deactivating manual shift program

- ▶ Press the program mode selector switch (▷ page 182) repeatedly until **C** or **S** appears in the multifunction display.

or

- ▶ Restart the engine.

The transmission will go to the automatic program mode (**C** or **S**).

The manual program mode **M** is not stored.

Automatic transmission

Emergency operation (Limp-Home Mode)

If vehicle acceleration becomes less responsive or sluggish or the transmission no longer shifts, the transmission is most likely operating in limp-home (emergency operation) mode. In this mode only second gear and reverse gear can be selected.

- ▶ Stop the vehicle in a safe location.
- ▶ Move the gear selector lever to park position **P**.
- ▶ Turn off the engine.
- ▶ Wait at least 10 seconds before restarting.
- ▶ Restart the engine.
- ▶ Move the gear selector lever to position **D** (for second gear) or position **R**.
- ▶ Have the transmission checked at an authorized Mercedes-Benz Center as soon as possible.

▼ Good visibility

For information on windshield wipers, see “Windshield wipers” (▷ page 56).

Headlamp cleaning system*

The button is located on the left side of the dashboard.



① Headlamp cleaning button

- ▶ Switch on the ignition (▷ page 38).
- ▶ Press button ①.

The headlamps are cleaned with a high-pressure water jet.

i The headlamps will automatically be cleaned when you have

- switched on the headlamps
and
- operated the windshield wipers with windshield washer fluid fifteen times

When you switch off the ignition, the counter resets.

For more information on filling up the washer reservoir, see “Windshield washer system and headlamp cleaning system*” (▷ page 292).

Rear view mirrors

For more information on setting the rear view mirrors, see “Mirrors” (▷ page 46).

Auto-dimming mirrors

The reflection brightness of the exterior rear view mirror on the driver’s side and the interior rear view mirror will respond automatically to glare when

- the ignition is switched on
and
- incoming light from headlamps falls on the sensor in the interior rear view mirror

The rear view mirrors will not react if

- reverse gear is engaged
- the interior lighting is turned on

Good visibility

Warning!



The auto-dimming function does not react if incoming light is not aimed directly at the sensors in the interior rear view mirror.

The interior rear view mirror and the exterior rear view mirror on the driver's side do not react, for example, if the rear window sunshade* is in raised position.

Light hitting the mirror(s) at certain angles (incident light) could blind you. As a result, you may not be able to observe traffic conditions and could cause an accident.

Warning!



In case of an accident, liquid electrolyte may escape from the mirror housing if the mirror glass breaks.

Electrolyte has an irritating effect. Do not allow the liquid to come into contact with eyes, skin, clothing, or respiratory system. In case it does, immediately flush affected area with water, and seek medical help if necessary.

! *Electrolyte drops coming into contact with the vehicle paint finish can be completely removed only while in the liquid state by applying plenty of water.*

Warning!



Exercise care when using the passenger-side exterior rear view mirror. The mirror surface is convex (outwardly curved surface for a wider field of view). Objects in mirror are closer than they appear. Check your interior rear view mirror or glance over your shoulder before changing lanes.

Activating exterior rear view mirror parking position

Follow these steps to activate the mirror parking position so that the passenger-side exterior rear view mirror will be turned downward to the stored position.

The buttons are located on the driver's door.



- ① Driver's side exterior rear view mirror button
- ② Passenger-side exterior rear view mirror button

- ▶ Switch on the ignition (▷ page 38).
- ▶ Make sure you have stored a parking position for the passenger-side exterior rear view mirror (▷ page 127).
- ▶ Vehicles equipped with Mirror adjust. parking aid in the Convenience submenu (▷ page 166): Make sure the Mirror adjust. parking aid function in the Convenience submenu of the control system is switched to On.
- ▶ Press button ② for the passenger-side exterior rear view mirror.
- ▶ Place the gear selector lever in reverse gear **R**.

The passenger-side exterior rear view mirror will be turned downward to the stored position.

The exterior rear view mirror returns to its previously stored driving position:

- 10 seconds after you put the gear selector lever out of position **R**
- immediately once you exceed a vehicle speed of approximately 6 mph (10 km/h)
- immediately when you press button ① for driver's side mirror.

Sun visors

The sun visors protect you from sun glare while driving.

Warning!



Do not use the vanity mirror while driving. Keep the mirrors in the sun visors closed while vehicle is in motion. Reflected glare can endanger you and others.

Good visibility

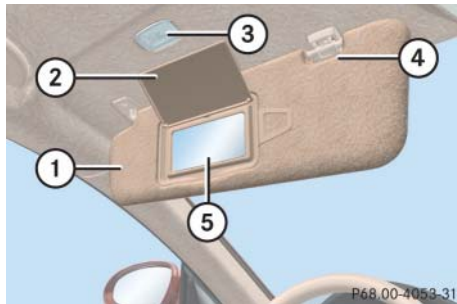

- ① Sun visor
- ② Mirror cover
- ③ Mirror lamp
- ④ Mounting
- ⑤ Vanity mirror

- ▶ Swing sun visors ① down when you experience glare.
- ▶ To use the vanity mirror ⑤, lift up the mirror cover ②.

Make sure the sun visor is properly engaged in the mounting ④.

Lamp ③ switches on.

If sunlight enters through a side window:

- ▶ Disengage sun visor ① from mounting ④.
- ▶ Pivot sun visor to the side.

i If sun visor ① is disengaged from mounting ④ with mirror cover ② open, mirror lamp ③ will switch off.

Rear window sunshade*

The switch is located in the center console.



- ① Rear window sunshade switch

- ▶ Switch on the ignition (▷ page 38).
- ▶ Press switch ① briefly to raise the sunshade.
- ▶ Press switch ① briefly to lower the sunshade.

Always raise the sunshade fully for its support against the window frame.

Warning!



When operating the rear window sunshade, be sure that there is no danger of anyone being harmed by the raising or lowering procedure.

The raising or lowering procedure can be immediately halted by briefly pressing switch ①. To reverse direction of movement, press switch ① again.

Warning!

When leaving the vehicle, always remove the SmartKey or the SmartKey with KEYLESS-GO* from the starter switch, take it with you, and lock the vehicle. Do not leave children unattended in the vehicle, or with access to an unlocked vehicle. A child's unsupervised access to a vehicle could result in an accident and/or serious personal injury.

Rear window defroster



The rear window defroster uses a large amount of power. To keep the battery drain to a minimum, switch off the defroster as soon as the rear window is clear. The defroster is automatically deactivated after approximately 6 to 20 minutes of operation depending on the outside temperature.

Warning!

Any accumulation of snow and ice should be removed from the rear window before driving. Visibility could otherwise be impaired, endangering you and others.

- ▶ Switch on the ignition (▷ page 38).

Activating

- ▶ Press button  (▷ page 193) or button  (▷ page 192) on the respective climate control panel.

The indicator lamp on the button comes on.

Deactivating

- ▶ Press button  (▷ page 193) or button  (▷ page 192) again.

The indicator lamp on the button goes out.

! *If the rear window defroster switches off too soon and the indicator lamp starts flashing, this means that too many electrical consumers are operating simultaneously and there is insufficient voltage in the battery. The system responds automatically by deactivating the rear window defroster.*

As soon as the battery has sufficient voltage, the rear window defroster automatically turns itself back on.

4-zone automatic climate control

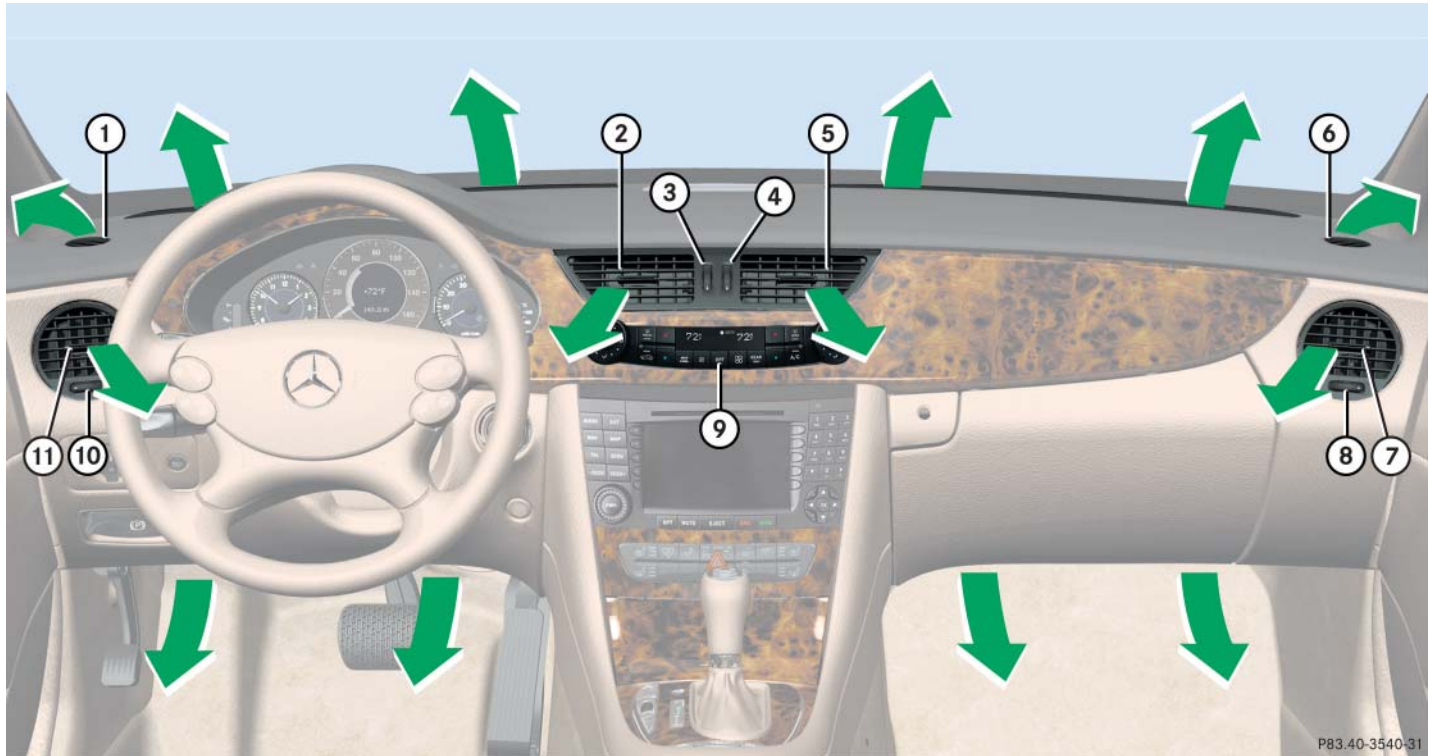

- ① Left side defroster vent, fixed
- ② Left center air vent, adjustable
- ③ Thumbwheel for air volume control for left center air vent
- ④ Thumbwheel for air volume control for right center air vent
- ⑤ Right center air vent, adjustable
- ⑥ Right side defroster air vent, fixed
- ⑦ Right side air vent, adjustable
- ⑧ Thumbwheel for air volume control for right side air vent
- ⑨ Climate control panel
- ⑩ Thumbwheel for air volume control for left side air vent
- ⑪ Left side air vent, adjustable

i For draft-free ventilation, move the sliders for the center air vents and side air vents to the middle position.

4-zone automatic climate control



P83.40-3539-31

USA only

- | | | | | | |
|---|---|---|---|---|--|
| ① | Air distribution, driver's side | ⑦ | Air distribution, passenger side | ⑫ | Climate control on/off |
| ② | Front window defroster | ⑧ | Air distribution and air volume, passenger side (automatic, manual) | ⑬ | Decreasing air volume |
| ③ | Temperature rocker switch, driver's side | ⑨ | AC cooling on/off | ⑭ | MAX COOL on/off |
| ④ | Display | ⑩ | Rear air-conditioning remote control | ⑮ | Air recirculation |
| ⑤ | Temperature rocker switch, passenger side | ⑪ | Increasing air volume | ⑯ | Air distribution and air volume, driver's side (automatic, manual) |
| ⑥ | Rear window defroster | | | | |

4-zone automatic climate control



P83.40-3538-31

Canada only

① Air distribution, driver's side	⑦ Air distribution, passenger side	⑫ Climate control on/off
② Front window defroster	⑧ Air distribution and air volume, passenger side (automatic, manual)	⑬ Decreasing air volume
③ Temperature rocker switch, driver's side	⑨ AC cooling on/off	⑭ Residual heat/ventilation
④ Display	⑩ Rear air-conditioning remote control	⑮ Air recirculation
⑤ Temperature rocker switch, passenger side	⑪ Increasing air volume	⑯ Air distribution and air volume, driver's side (automatic, manual)
⑥ Rear window defroster		

4-zone automatic climate control

Warning!



When operating the climate control, the air that enters the passenger compartment through the air vents can be very hot or very cold (depending on the set temperature). This may cause burn or frostbite to unprotected skin in the immediate area of the air vents. Always keep sufficient distance between unprotected parts of the body and the air vents. If necessary, use the air distribution controls (> page 192) or (> page 193) to direct the air to air vents in the vehicle interior that are not in the immediate area of unprotected skin.

The climate control is a 4-zone intelligent climate control system. Your vehicle interior is divided into 4 zones.



P83.40-2877-31

With the help of a sun sensor, the climate control determines the relation of the sun to the vehicle and automatically adjusts the inside temperature for every individual zone.

You can set the temperature for each of the 4 zones separately.

The climate control is operational whenever the engine is running. It cools the vehicle's interior according to the angle and intensity of the sun's rays, the outside temperature and the selected temperature. You can operate the climate control system in either the automatic or manual mode.

Nearly all dust particles, pollutants and odors are filtered out before outside air enters the passenger compartment through the air distribution system.

The air conditioning will not engage (no cooling) if the **A/C** mode (> page 203) is deactivated.

4-zone automatic climate control

Warning!

Follow the recommended settings for heating and cooling given on the following pages. Otherwise the windows could fog up, impairing visibility and endangering you and others.

i Severe conditions (e.g. strong air pollution) may require replacement of the filter before its scheduled interval. A clogged filter will reduce the air volume to the interior.

If the vehicle interior is hot, ventilate the interior before driving off, see “Summer opening feature” (▷ page 210). The climate control will then adjust the interior temperature to the set value much faster.

Keep the air intake grille in front of the windshield free of snow and debris.

Do not obstruct air flow by placing objects on the air flow-through exhaust slots below the rear window.

Deactivating the climate control system**Warning!**

When the climate control is switched off, the outside air supply and circulation are also switched off. Only choose this setting for a short time. Otherwise the windows could fog up, impairing visibility and endangering you and others.

Deactivating

- ▶ Press button **OFF** (▷ page 192) or (▷ page 193) until the display ④ (▷ page 192) or (▷ page 193) is cleared.

Reactivating

- ▶ Make sure the ignition is switched on.
- ▶ Press button **OFF** (▷ page 192) or (▷ page 193) again.

The previous settings are once again in effect.

i To switch the system on, you can also press another button, with the exception of **REC** or **REST** (▷ page 192) or (▷ page 193).

4-zone automatic climate control

Operating the climate control system in automatic mode

i When operating the climate control system in automatic mode, you will only rarely need to adjust the temperature, air volume and air distribution.

In automatic mode, cooling with dehumidify is switched on. This function can be switched off.

Warning!



If you switch off the cooling function the windows can fog up more quickly. Window fogging may impair visibility and endanger you and others.

i You can switch the automatic climate control system on and off for each side of the passenger compartment as desired.

Activating



- ▶ Press one button **AUTO** (▷ page 192) or (▷ page 193) while the engine is running.

The indicator lamp on the button comes on. AUTO appears in the display ④ (▷ page 192) or (▷ page 193). The air volume and air distribution are adjusted automatically.

- ▶ Use temperature rocker switches ③ and ⑤ (▷ page 192) or (▷ page 193) to separately adjust the air temperature on each side of the passenger compartment.

The temperature of the vehicle interior is adjusted automatically.

Deactivating

- ▶ Press button  or  (▷ page 192) or (▷ page 193).

The AUTO indicator in the display ④ (▷ page 192) or (▷ page 193) goes out. The automatic function for air volume is switched off, and air volume is controlled according to the desired setting.

or

- ▶ Turn air distribution controls ① and ⑦ (▷ page 192) or (▷ page 193) on each side of the passenger compartment to the desired symbol.

The indicator lamp on the corresponding button goes out. Automatic air distribution is switched off in the corresponding zone, and air distribution is controlled according to the desired position.

The automatic air volume remains switched on.

4-zone automatic climate control

Setting the temperature

Use temperature control rocker switches ③ and ⑤ (▷ page 192) or (▷ page 193) to separately adjust the air temperature on each side of the passenger compartment. You should raise or lower the temperature setting in small increments, preferably starting at 72°F (22°C). The adjusted temperature appears in the display ④ (▷ page 192) or (▷ page 193). The climate control will adjust to the set temperature as fast as possible.

i You can also adjust the temperature in the rear passenger compartment (▷ page 204).

i When operating the climate control system in automatic mode, you will only rarely need to adjust the temperature, air volume and air distribution.

Increasing

- ▶ Push top of temperature control rocker switch ③ and/or ⑤ (▷ page 192) or (▷ page 193).

The climate control system will correspondingly adjust the interior air temperature.

Decreasing





- ▶ Push bottom of temperature control rocker switch ③ and/or ⑤ (▷ page 192) or (▷ page 193).

The climate control system will correspondingly adjust the interior air temperature.

Adjusting air distribution

Use the air distribution controls ① and ⑦ (▷ page 193) or (▷ page 192) to separately adjust the air distribution on each side of the passenger compartment.

The following symbols are located on the controls:

Symbol	Function
	Directs air through the center, side and rear passenger compartment air vents
	Directs air to the windshield and through the side air vents
	Directs air into the entire vehicle interior
	Directs air to the footwells

4-zone automatic climate control

- ▶ Turn air distribution controls ① and ⑦ (▷ page 193) or (▷ page 192) on each side of the passenger compartment to the desired symbol.

The indicator lamp on the corresponding button goes out and the automatic air distribution is switched off for the corresponding side. The air distribution is controlled according to the thumbwheel setting.

i You can also turn the air distribution control to a position between two symbols.

Opening the center air vents

- ▶ Turn thumbwheels ③ and ④ (▷ page 190) upward.

The side air vents ② and ⑤ are open.

Closing the center air vents

- ▶ Turn thumbwheels ③ and ④ (▷ page 190) downward.



The side air vents ② and ⑤ are closed.

Opening and closing side air vents



- ▶ Turn thumbwheels ⑧ and ⑩ (▷ page 190) in the required direction.

The side air vents ⑦ and ⑪ are open or closed.

Adjusting air volume

Use buttons **AUTO** (▷ page 192) or (▷ page 193) for automatic mode or air volume buttons  or  (▷ page 192) or (▷ page 193) to adjust air volume manually.

Nine blower speeds are available.

- ▶ Press button  to decrease or button  to increase air volume to the desired level.

The **AUTO** indicator for air volume in the display ④ goes out (▷ page 192) or (▷ page 193). The selected blower speed is shown in the display ④. Automatic air distribution remains switched on.



The indicator lamps on the **AUTO** buttons remain lit.

Front defroster

You can use this setting to defrost the windshield, for example if it is iced up. You can also defog the windshield and the side windows.

 *Keep this setting selected only until the windshield or the side windows are clear again.*



Activating

- ▶ Press button  or  (▷ page 192) or (▷ page 193).



The indicator lamp on the button comes on. Display ④ (▷ page 192) or (▷ page 193) is cleared.

The air conditioning switches automatically to the following functions:

- cooling on to dehumidify
- maximum blowing and heating power (depends on cooling temperature)
- air flows onto the windshield and the front side windows
- the air recirculation mode is switched off

 *If you have switched on the defrost function using the  button, you cannot make any other settings.*

Deactivating

- ▶ Press button  or  (▷ page 192) or (▷ page 193) again.

The indicator lamp on the button goes out. Defrosting is turned off.

The previous settings are once again in effect.



 *The cooling remains switched on.*

Windshield fogged on the outside

 *Keep this setting selected only until the windshield is clear again.*

- ▶ Switch windshield wipers on (▷ page 57).
- ▶ Press button **AUTO** (▷ page 192) or (▷ page 193).

If the automatic mode of the climate control is switched off:



- ▶ Turn air distribution control ① and ⑦ to  or  (▷ page 192) or (▷ page 193).

4-zone automatic climate control

Maximum cooling MAX COOL (USA only)

You can use this setting to provide the fastest possible cooling of the vehicle interior (when windows and tilt/sliding sunroof or tilt/sliding panel* are closed).



Activating

- ▶ Press button  (▷ page 192).
MAX COOL appears in the display  (▷ page 192).





The air conditioning switches automatically to the following functions:

- maximum cooling
- maximum blowing power
- the air recirculation mode is switched on

Deactivating

- ▶ Press button  (▷ page 192) again.
MAX COOL disappears in the display  (▷ page 192).

The previous settings are once again in effect.



-  *To switch the maximum cooling function off, you can also press button , ,  or  (▷ page 192).*

Air recirculation mode

Switch to air recirculation mode to prevent unpleasant odors from entering the vehicle from the outside (e.g. before driving through a tunnel). This setting cuts off the intake of outside air and recirculates the air in the passenger compartment.

Warning!



Fogged windows impair visibility, endangering you and others. If the windows begin to fog on the inside, switching off the air recirculation mode immediately should clear interior window fogging. If interior window fogging persists, make sure the air conditioning (▷ page 203) is activated, or press button  or .

4-zone automatic climate control

Activating

- ▶ Press button  (▷ page 192) or (▷ page 193).

The indicator lamp on the button comes on.

 *The air recirculation mode is activated automatically at high outside temperatures and if the concentration of carbon monoxide (CO) and nitrogen oxide in the outside air increases, for example in a tunnel.*

The indicator lamp on button  is not lit when the air recirculation mode is automatically switched on.

A quantity of outside air is added after approximately 30 minutes.

Deactivating

- ▶ Press button  (▷ page 192) or (▷ page 193) again.

The indicator lamp on the button goes out.

 *The air recirculation mode is deactivated automatically:*

- *after 5 minutes if the outside temperature is below approximately 41 °F (5 °C)*
- *after 5 minutes if the air conditioning is turned off*
- *after 30 minutes if the outside temperature is above approximately 41 °F (5 °C)*

Air recirculation mode with convenience closing or opening feature

Warning!

Never operate the windows and tilt/sliding sunroof or tilt/sliding panel* if there is the possibility of anyone being harmed by the opening or closing procedure.

In the event that the procedure causes potential danger, the closing of the windows can be immediately halted by pressing or pulling the respective window switch. The closing of the tilt/sliding sunroof can be immediately halted by moving the switch for the tilt/sliding sunroof in any direction.

The closing of the windows and the tilt/sliding sunroof can be reversed by again pressing and holding the  button.

4-zone automatic climate control

Convenience closing



- ▶ Press button  (▷ page 192) or (▷ page 193) for approximately 2 seconds.

The windows and tilt/sliding sunroof will close. You can release button  once the closing procedure has begun. The windows and tilt/sliding sunroof continue closing until they are fully closed. The indicator lamp on the button comes on. The air recirculation mode is activated.

Convenience opening

- ▶ Press button  for approximately 2 seconds.

The windows and tilt/sliding sunroof will return to their previous position. You can release button, once the opening procedure has begun. The windows and tilt/sliding sunroof continue opening until they have reached their previous position. The indicator lamp on the button goes out. The air recirculation mode is deactivated.

 *A window or tilt/sliding sunroof will only return to its previous position if it has not been moved to another position using the respective window switch or tilt/sliding sunroof switch after it was closed with button .*

A window or tilt/sliding sunroof that has been moved will remain in its current position if button  is used to re-open the remaining windows or tilt/sliding sunroof.

Combination filter with pollutant-sensitive air-recirculation mode

The combination filter reduces pollutants and unpleasant odors in the outside air. The pollutant-sensitive air-recirculation mode automatically switches off the supply of outside air when pollutants are detected in the air.

 *The pollutant-sensitive air-recirculation mode is not possible if you have switched off the air conditioning or if the temperature falls below 41 °F (5 °C).*

4-zone automatic climate control

Air conditioning

The cooling function, only operational when the engine is running, cools the vehicle interior down to the selected temperature. The cooling function also dehumidifies the air in the vehicle interior, thus preventing the windows from fogging up.

 *Condensation may drip out from underneath the vehicle. This is normal and not an indication of a malfunction.*

Warning!

If you turn off the cooling function, the vehicle will not be cooled when weather conditions are warm. The windows can fog up more quickly. Window fogging may impair visibility and endanger you and others.

Deactivating

It is possible to deactivate the air conditioning (cooling) function of the climate control system. The air in the vehicle will then no longer be cooled or dehumidified.

- ▶ Press button  (▷ page 192) or (▷ page 193).

The indicator lamp on the button goes out.

Activating

Moist air can fog up the windows. You can dehumidify the air with the air conditioning.

- ▶ Press button  (▷ page 192) or (▷ page 193) again.

The indicator lamp on the button comes on.

The air conditioning uses the refrigerant R134a. This refrigerant is free of CFCs which are harmful to the ozone layer.

 *If the air conditioning cannot be turned on again, this indicates that the air conditioning is losing refrigerant. The compressor has turned itself off.*

Have the air conditioning checked at the nearest authorized Mercedes-Benz Center.

Residual heat and ventilation
(Canada only)

With the engine switched off, it is possible to continue to heat or ventilate the interior for up to 30 minutes. This feature makes use of the residual heat produced by the engine.

 *If you switch on the residual heat function when temperatures are high, only the ventilation will be switched on.*

 *Regardless of the selected air volume, the blower operates at low speed.*

4-zone automatic climate control

i How long the system will provide heating depends on

- the coolant temperature
- the temperature set by the operator

The blower will run at speed setting **1** regardless of the air distribution control setting.

Activating

► Switch off the ignition.

► Press button **REST** (▷ page 193).

REST in the display **④** (▷ page 193) comes on.

Deactivating

► Press button **REST** (▷ page 193) again.

REST in the display **④** (▷ page 193) goes out.

i The residual heat is automatically turned off:

- when the ignition is switched on
- after about 30 minutes
- if the battery voltage drops
- if the coolant temperature is too low

Rear climate control

The rear climate control is adjusted via the front climate control panel (▷ page 192) or (▷ page 193) or the rear climate control panel.

The rear climate control panel is located in the rear center console.

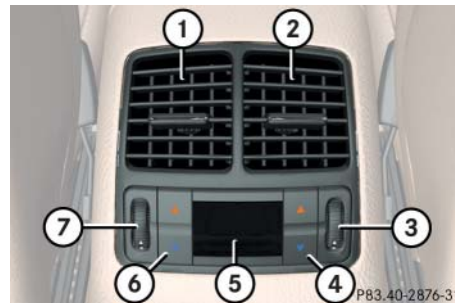

- | | |
|---|--|
| ① | Left rear center air vent, adjustable |
| ② | Right rear center air vent, adjustable |
| ③ | Thumbwheel for air volume control for right rear center air vent |
| ④ | Temperature rocker switch, right |
| ⑤ | Display |
| ⑥ | Temperature rocker switch, left |
| ⑦ | Thumbwheel for air volume control for left rear center air vent |

4-zone automatic climate control

Setting the temperature

Use temperature control rocker switches ④ and ⑥ to separately adjust the air temperature on each side of the rear passenger compartment.

i You can also adjust the rear temperature using the front climate control panel (▷ page 192) or (▷ page 193).

You should raise or lower the temperature setting in small increments, preferably starting at 72°F (22°C). The adjusted temperature appears in the display ⑤. The rear climate control will adjust to the set temperature as fast as possible.

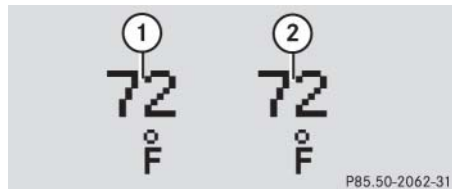

- ① Temperature, left
- ② Temperature, right

- ▶ Adjust the temperature to the desired setting for each side of the passenger compartment using the left and right temperature buttons.

The temperature in the rear passenger compartment is adjusted automatically.

i The rear climate control will not cool the air when the air conditioning is switched off (▷ page 203).

Adjusting air distribution

- ▶ Move the slider for the left center vent ① or right center vent ② to the left, right, up, or down.

The air flow is directed in the corresponding direction.

i For draft-free ventilation, push slides ① and ② (▷ page 204) upward.

Adjusting air volume



- ▶ Turn thumbwheel ③ or ⑦ (▷ page 204) up or down.

The air volume is increased or decreased.

4-zone automatic climate control

Adjusting the rear settings with the front control panel

You can adjust the temperature for the rear climate control from the front climate control panel.

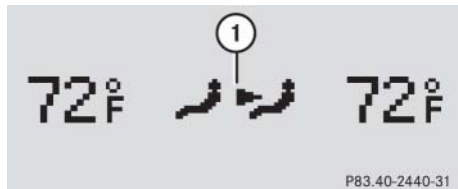

- ▶ Press button  or  (▷ page 192) or (▷ page 193).

The display switches over.



- ① Rear climate control display
- ▶ Set the desired temperature for the rear passenger compartment using temperature rocker switches ④ and ⑥ (▷ page 204).

After approximately 5 seconds after the last adjustment, the display switches back to its standard display.

i You can also press button  or  (▷ page 192) or (▷ page 193) once more to switch back to the standard display.

Front center console storage compartment ventilation

The front center console storage compartment under the armrest has its own air vent. The air temperature is about the same as that of the dashboard air vents.

The lever is located in the front center vent.



- ① Lever

- ▶ To open air vent slide the lever ① up.
- ▶ To close air vent slide the lever ① down.

i The compartment can get very warm due to its confined space. When storing heat sensitive objects (e.g. groceries) in the compartment, close the air vent while heating the passenger compartment.

▼ Power windows

Opening and closing the windows

The side windows are opened and closed electrically. The switches for all of the side windows are on the driver's door. The switches for the respective windows are on the front passenger door and the rear doors.



- ① Rear window override switch
(▷ page 89)
- ② Right front window
- ③ Right rear window
- ④ Left rear window
- ⑤ Left front window

Warning!



When closing the windows, make sure that there is no danger of anyone being harmed by the closing procedure.

The closing of the door windows can be immediately halted by releasing the switch or, if switch was pulled past the resistance point and released, by either pressing or pulling the respective switch.

The door windows are equipped with the express-close and automatic reversal function. If the window encounters an obstruction that blocks its path in a circumstance where you pulled the switch past the resistance point and released it to close the window, the automatic reversal function will stop the window and open it slightly.

If the window encounters an obstruction that blocks its path in a circumstance where you are closing the window by pulling and holding the switch, by pressing and holding button  on the SmartKey, by pressing and holding the lock button (vehicles with KEYLESS-GO*) on an outside door handle, the automatic reversal function will not operate.

When leaving the vehicle, always remove the SmartKey or SmartKey with KEYLESS-GO* from the starter switch, take it with you, and lock the vehicle. Do not leave children unattended in the vehicle, or with access to an unlocked vehicle. A child's unsupervised access to a vehicle could result in an accident and/or serious personal injury.

Power windows

i You can also open or close the windows using the SmartKey, see “Summer opening feature” (▷ page 210) and “Convenience closing feature” (▷ page 210).

Depending on current position, the windows may also open or close when the air recirculation button  in the automatic climate control (▷ page 193) or (▷ page 192) is pressed and held.

i Operating the windows from the rear is not possible if you activate the override switch (▷ page 89).

i With the SmartKey in starter switch position **0** or removed from the starter switch, the power windows can be operated:

- until you open the driver's or front passenger's door
 - for at least 5 minutes if no door was opened
- ▶ Switch on the ignition (▷ page 38).

Opening the windows

- ▶ Press switch ② to ⑤ to the resistance point.

The corresponding window will move downwards until you release the switch.

Closing the windows

- ▶ Pull switch ② to ⑤ to the resistance point.

The corresponding window will move upwards until you release the switch.

Warning!



If you pull and hold the switch up when closing the window, and upward movement of the window is blocked by some obstruction including but not limited to arms, hands, fingers, etc., the automatic reversal will not operate.

Fully opening the windows (Express-open)

- ▶ Press switch ② to ⑤ past the resistance point and release.

The corresponding window opens completely.

Fully closing the windows (Express-close)

- ▶ Pull switch ② to ⑤ past the resistance point and release.

The corresponding window closes completely.

Warning!



Driver's door only:

If within 5 seconds switch is again pulled past the resistance point and released, the automatic reversal will not operate.

! *If the upward movement of the window is blocked during the closing procedure, the window will stop and open slightly.*

Remove the obstruction, pull the respective power window switch again past the resistance point and release.

If the window still does not close when there is no obstruction, pull and hold the respective power window switch. The side window will then close without the obstruction sensor function.

Stopping windows during Express-operation

- ▶ Press or pull the respective power window switch again.

Synchronizing power windows

The power windows must be synchronized

- after the battery has been disconnected
- if the power windows cannot be fully opened (Express-open) or closed (Express-close)

Synchronizing

- ▶ Close all doors.
- ▶ Switch on the ignition (▷ page 38).
- ▶ Pull switch ② to ⑤ until the side windows are completely closed.
- ▶ Hold on to switches ② to ⑤ for approximately 1 second.

The power windows are synchronized.

Power windows

Summer opening feature



If the weather is warm, you can ventilate the vehicle before driving off by simultaneously:

- ▶ opening the side windows
- ▶ opening the tilt/sliding sunroof
- ▶ turning on the seat ventilation* for the driver's seat

i *The seat ventilation* for the driver's seat is automatically set to the highest level if activated via summer opening feature.*



SmartKey

- ▶ Aim transmitter eye of the SmartKey or SmartKey with KEYLESS-GO* at the driver's outside door handle. The SmartKey or SmartKey with KEYLESS-GO* must be in close proximity to the driver's outside door handle.
- ▶ Press and hold button  until the windows and the tilt/sliding sunroof have reached the desired position.
- ▶ Release button  to interrupt procedure.

Convenience closing feature

When you lock the vehicle, you can close the windows, tilt/sliding sunroof simultaneously.

- ▶ Aim transmitter eye of the SmartKey at the driver's outside door handle (> page 210). The SmartKey or SmartKey with KEYLESS-GO* must be in close proximity to the driver's outside door handle.
- ▶ Press and hold button  until the windows, the tilt/sliding sunroof are completely closed.

Vehicles with KEYLESS-GO*:

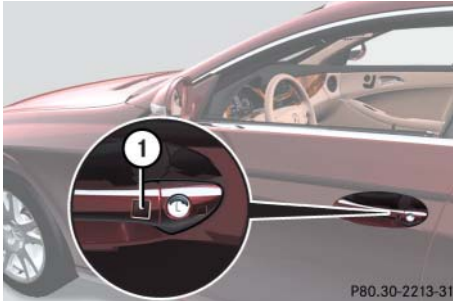

① Lock button



- ▶ Press and hold the lock button ① at an outside door handle until the windows, the tilt/sliding sunroof are completely closed.
- ▶ Release the lock button ① at the outside door handle to interrupt procedure.

Warning!



When closing the windows and the tilt/sliding sunroof, make sure that there is no danger of anyone being harmed by the closing procedure.

If potential danger exists, proceed as follows:

- Release button  to stop the closing procedure. To open, press and hold button . To continue the closing procedure after making sure that there is no danger of anyone being harmed by the closing procedure, press and hold button .

Vehicles with KEYLESS-GO*:

- Release the lock button (▷ page 62) on the exterior driver's door handle to stop the closing procedure.
- Pull on the exterior driver's door handle and hold firmly. The side windows and the tilt/sliding sunroof will open for as long as the door handle is held but the door not opened.

Power tilt/sliding sunroof

Opening and closing the power tilt/sliding sunroof

The tilt/sliding sunroof can be opened and closed electrically. The switch for the tilt/sliding sunroof is on the overhead control panel.

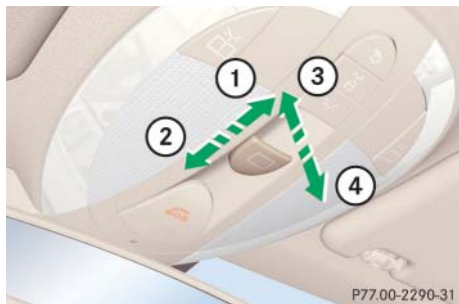

Sunroof switch

- ① Push back to slide sunroof open
- ② Push forward to slide sunroof closed
- ③ Push up to raise sunroof at rear
- ④ Pull down to lower sunroof at rear

With the sunroof closed or tilted open, a screen can be slid into the sunroof opening to guard against sun rays. When sliding the sunroof open, the screen will also retract.



Warning!



When closing the tilt/sliding sunroof, make sure there is no danger of anyone being harmed by the closing procedure.

The opening/closing procedure of the tilt/sliding sunroof can be immediately halted by releasing the switch or, if the switch was moved past the resistance point and released, by moving the switch in any direction.

The tilt/sliding sunroof is made out of glass. In the event of an accident, the glass may shatter. This may result in an opening in the roof.

In a vehicle rollover, occupants not wearing their seat belts or not wearing them properly may be thrown out of the opening. Such an opening also presents a potential for injury for occupants wearing their seat belts properly as entire body parts or portions of them may protrude from the passenger compartment.

When leaving the vehicle, always remove the SmartKey or the SmartKey with KEYLESS-GO* from the starter switch, take it with you, and lock the vehicle. Do not leave children unattended in the vehicle, or with access to an unlocked vehicle. A child's unsupervised access to a vehicle could result in an accident and/or serious personal injury.

! To avoid damaging the seals, do not transport any objects with sharp edges which can stick out of the tilt/sliding sunroof.

Do not open the tilt/sliding sunroof if there is snow or ice on the roof, as this could result in malfunctions.

The tilt/sliding sunroof can be opened or closed manually should an electrical malfunction occur (▷ page 400).

! Please keep in mind that weather conditions can sometimes change rapidly. Make sure to close the tilt/sliding sunroof when leaving the vehicle. If water enters the vehicle interior, vehicle electronics could be damaged which is not covered by the Mercedes-Benz Limited Warranty.

i When the tilt/sliding sunroof is open, resonance noises may result in addition to the usual wind noises. They are caused by minimal pressure changes in the passenger compartment. To reduce or eliminate these noises, change the position of the tilt/sliding sunroof or open a side window slightly.

i You can also open or close the tilt/sliding sunroof using the SmartKey (summer opening/convenience closing feature) (▷ page 210).

Depending on current position, the tilt/sliding sunroof may also open or close when the air recirculation button  in the automatic climate control (▷ page 193) or (▷ page 192) is pressed and held.

► Switch on the ignition (▷ page 38).

Opening and closing the power tilt/sliding sunroof

► To open, close, raise or lower the tilt/sliding sunroof, move the sunroof switch to resistance point in the required direction of arrows ① to ④.

Release the sunroof switch when the tilt/sliding sunroof has reached the desired position.

Power tilt/sliding sunroof

Fully opening (Express-open) and closing (Express-close) the power tilt/sliding sunroof

- ▶ To open or close the tilt/sliding sunroof, move the sunroof switch past the resistance point in the direction of arrow ① to ② and release.

The tilt/pop up roof opens or closes completely.

Stopping the power tilt/sliding sunroof during Express-operation

- ▶ Move the sunroof switch in any direction.

i If the movement of the tilt/sliding sunroof is blocked during the closing procedure, the tilt/sliding sunroof will stop and reopen slightly.

Synchronizing the power tilt/sliding sunroof

The tilt/sliding sunroof must be synchronized

- after the battery has been disconnected or discharged
 - after the tilt/sliding sunroof has been closed manually (▷ page 400)
 - after a malfunction
 - if the tilt/sliding sunroof does not open smoothly
- ▶ Remove the respective fuse from the main fuse box (▷ page 428).
 - ▶ Reinsert the fuse in the main fuse box.
 - ▶ Switch on the ignition (▷ page 38).

- ▶ Move and hold the sunroof switch in the direction of arrow ③ until the tilt/sliding sunroof is fully raised at the rear.

Keep holding the sunroof switch in the direction of arrow ③ for approximately 1 second.

- ▶ Check the Express-open feature (▷ page 214).

If the tilt/sliding sunroof opens completely, the roof is synchronized. Otherwise repeat the above steps.

▼ Driving systems

The following driving systems are explained on the following pages:

- Cruise control and Distronic*, with which the vehicle can maintain a preset speed
- Airmatic DC adjusts the vehicle suspension characteristics automatically and controls the vehicle level
- Parktronic system*, which assists the driver during parking maneuvers

For information on the BAS, ABS, ESP® and EBP, see “Driving safety systems” (▷ page 91).

Cruise control

The cruise control automatically maintains the speed you set for your vehicle.

Use of cruise control is recommended for driving at a constant speed for extended periods of time. You can set or resume cruise control at any speed above 20 mph (30 km/h).

The cruise control function is operated by means of the cruise control lever.

The cruise control lever is the uppermost lever on the left-hand side of the steering column (▷ page 24).

Warning!



The cruise control is a convenience system designed to assist the driver during vehicle operation. The driver is and must always remain responsible for the vehicle's speed and for safe brake operation.

Only use the cruise control if the road, traffic, and weather conditions make it advisable to travel at a steady speed.

- The use of cruise control can be dangerous on winding roads or in heavy traffic because conditions do not allow safe driving at a steady speed.
- The use of cruise control can be dangerous on slippery roads. Rapid changes in tire traction can result in wheel spin and loss of control.
- Deactivate the cruise control when driving in fog.

The “Resume” function should only be operated if the driver is fully aware of the previously set speed and wishes to resume this particular preset speed.

Driving systems

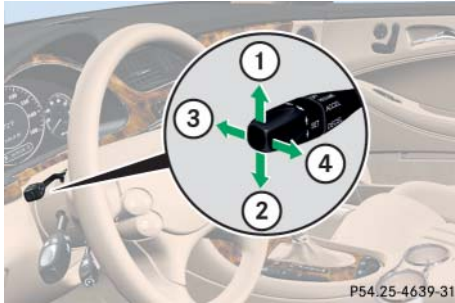

- ① Set current or higher speed
- ② Set current or lower speed
- ③ Cancel cruise control
- ④ Resume at last set speed

Warning!



The cruise control brakes automatically so that the set speed is not exceeded.

Keep in mind that the cruise control is a convenience system designed to assist the driver during vehicle operation. The driver is and must always remain responsible for the vehicle's speed and for safe brake operation.

Setting current speed

- ▶ Accelerate or decelerate to the desired speed.
- ▶ Briefly lift ① or depress ② the cruise control lever.

The current speed is set.

- ▶ Remove your foot from the accelerator pedal.

Cruise control is activated.

The selected speed appears in the multi-function display for approximately 5 seconds, and the corresponding speedometer segments from the selected speed to the vehicle maximum speed are illuminated.

i On uphill or downhill grades, the cruise control may not be able to maintain the set speed. Once the grade eases, the set speed will be resumed.

On downhill grades, the cruise control maintains the set speed with active braking action. In addition, on longer downhill grades the automatic transmission will automatically downshift.

Canceling cruise control

There are several ways to cancel the cruise control:

- ▶ Step on the brake pedal.

The cruise control is canceled. The last speed set is stored for later use.

or

- ▶ Briefly push the cruise control lever in direction of arrow ③ (▷ page 216).

The cruise control is canceled. The last speed set is stored for later use.

- i** *The last stored speed is canceled when you turn off the engine.*

- i** *The cruise control automatically switches off, if*

- *you step on the brake pedal.*
- *you depress the parking brake pedal.*

In this case the segments in the multifunction display (▷ page 141) go out and no warning sounds.

- *the vehicle speed is below 20 mph (30 km/h).*
- *the ESP® is in operation or switched off with the ESP® switch (▷ page 96).*
- *you move the gear selector lever to position **N** while driving.*

The segments in the multifunction display (▷ page 141) go out, and an acoustic warning sounds.

- !** *Moving the gear selector lever to position **N** while driving also cancels the cruise control. However, the gear selector lever should not be moved to position **N** while driving except to coast when the vehicle is in danger of skidding (e.g. on icy roads).*

- i** *Depressing the accelerator pedal does not deactivate the cruise control. After brief acceleration (e.g. for passing), the cruise control will resume the last speed set.*

Setting a higher speed

- ▶ Lift the cruise control lever in direction of arrow ① (▷ page 216) and hold it up until the desired speed is reached.
- ▶ Release the cruise control lever.
The new speed is set.

Setting a lower speed

- ▶ Depress the cruise control lever in direction of arrow ② (▷ page 216) and hold it down until the desired speed is reached.
- ▶ Release the cruise control lever.
The new speed is set.

- i** *When you use the cruise control lever to decelerate, the brake system will automatically brake the vehicle if the engine's braking power does not brake the vehicle sufficiently.*

Driving systems

Fine adjustment in 1 mph (Canada: 1 km/h) increments

Faster

- ▶ Briefly tip the cruise control lever in direction of arrow ① (▷ page 216).

Slower

- ▶ Briefly tip the cruise control lever in direction of arrow ② (▷ page 216).

Setting to last stored speed ("Resume" function)

Warning!



The speed stored in memory should only be set again if prevailing road conditions permit. Possible acceleration or deceleration differences arising from returning to the preset speed could cause an accident and/or serious injury to you and others.

- ▶ Briefly pull the cruise control lever to position ④ (▷ page 216).
The cruise control resume the last set speed.
- ▶ Remove your foot from the accelerator pedal.

The selected speed appears in the multi-function display for approximately 5 seconds, and the corresponding speedometer segments from the selected speed to the vehicle maximum speed are illuminated.

Distronic*

When activated, the Distronic adaptive cruise control system increases driving convenience afforded by the cruise control during travel on expressways and other major roads.

- If the Distronic distance sensor detects a slower moving vehicle directly ahead, your vehicle speed will be reduced so that you follow that vehicle at a preset distance.
- If there is no vehicle directly ahead of you, Distronic will function in the same way as cruise control (▷ page 216).

Warning!



Distronic adaptive cruise control is no substitute for active driving involvement. It does not react to stationary objects, nor recognize or predict the curvature and lane layout or the movement of vehicles ahead. Distronic can only apply a maximum of 20% of the vehicle's braking power.

It is the driver's responsibility at all times to be attentive to road, traffic, and weather conditions and to provide the steering, braking and other driving inputs necessary to retain control of the vehicle.

Warning!

Distronic is a convenience system. Its speed adjustment reduction capability is intended to make cruise control more effective and usable when traffic speeds vary. It is not however, intended to, nor does it, replace the need for extreme care. The responsibility for the vehicle speed and the distance to the vehicle ahead, including most importantly brake operation to assure safe stopping distance, always rests with the driver.

Distronic cannot take street and traffic conditions into account.

Warning!

Distronic requires familiarity with its operational characteristics. We strongly recommend that you review the following information carefully before operating the system.

i *USA only: This device has been approved by the FCC as a "Vehicular Radar System". The radar sensor is intended for use in an automotive radar system only. Removal, tampering, or altering of the device will void any warranties, and is not permitted by the FCC. Do not tamper with, alter, or use in any non-approved way.*

Any unauthorized modification to this device could void the user's authority to operate the equipment.

i *Canada only:*

This device complies with RSS-210 of Industry Canada. Operation is subject to the following two conditions:

- (1) This device may not cause interference, and*
- (2) this device must accept any interference received, including interference that may cause undesired operation of the device.*

Removal, tampering, or altering of the device will void any warranties, and is not permitted. Do not tamper with, alter, or use in any non-approved way.

Any unauthorized modification to this device could void the user's authority to operate the equipment.

Driving systems

Warning!



Distronic cannot take street and traffic conditions into account. Only use DISTRONIC if the road, weather and traffic conditions make it advisable to travel at a steady speed.

Warning!



Use of DISTRONIC can be dangerous on slippery roads. Rapid changes in tire traction can result in wheel spin and loss of control. DISTRONIC does not act upon adverse sight distance conditions. Do not use DISTRONIC during conditions of fog and heavy rain, snow or sleet.

Warning!



DISTRONIC cannot take weather conditions into account. Switch off DISTRONIC or do not turn it on if:

- roads are slippery or covered with snow or ice. The wheels could lose traction while braking or accelerating, and the vehicle could skid
- the sensor is dirty or visibility is diminished due to snow, rain or fog. The distance control could be impaired

Always pay attention to traffic conditions even while DISTRONIC is switched on. Otherwise, you may not be able to recognize dangerous situations until it is too late and could cause an accident resulting in personal or fatal injury to you or others.

Warning!



Close attention to road and traffic conditions is imperative at all times, regardless of whether or not DISTRONIC is activated.

Use of DISTRONIC can be dangerous on winding roads or in heavy traffic because conditions do not allow safe driving at a steady speed.

DISTRONIC will not react to stationary objects in the roadway (e.g. a stopped vehicle in a traffic jam or a disabled vehicle). DISTRONIC will also not respond to oncoming vehicles.

Switch off DISTRONIC:

- when changing from the left to the right lane if vehicles are moving more slowly in the left lane
- when entering a turn lane or highway off ramp
- in complex driving situations, such as in highway construction zones

In these situations, DISTRONIC will continue to maintain the set speed unless deactivated.

Distronic is designed and intended only to maintain a set speed and keep a set distance from moving objects in front of it.

Warning!



The “Resume” function should only be operated if the driver is fully aware of the previously set speed and wishes to resume this particular preset speed.

Distronic displays in the speedometer dial



① Set speed

If Disticronic is activated, one or two segments come on around the set speed.

i *The vehicle speed displayed on the speedometer can briefly vary from the speed setting on the Disticronic system.*



① Segments

If Disticronic detects a vehicle directly ahead, the segments (representing the difference) from the speed of the vehicle ahead to the set speed come on.

If Disticronic calculates that there is a danger of collision:

- The distance warning lamp  in the instrument cluster comes on red.
- An intermittent warning sounds.

Driving systems

- ▶ Immediately brake the vehicle to avoid a collision.

Under no circumstances should the driver await the intermittent warning sound before braking. See the following warning note.

The intermittent warning sound ceases and the red distance warning lamp  goes out when the necessary distance to the vehicle ahead is again established.

Warning!



An intermittent warning sounds and the distance warning lamp  in the instrument cluster is illuminated if the Distronic system calculates that the distance to the vehicle ahead and your vehicle's current speed indicate that Distronic will not be capable of slowing the vehicle sufficiently to maintain the preset following distance, which creates a danger of a collision.

Immediately brake the vehicle to increase the distance to the vehicle in front of you. The warning sound is intended as a final caution that you have not interceded with your own braking inputs to avoid a potentially dangerous situation. Do not wait for the operation of the warning signal to intercede with your own braking, as that will result in potentially dangerous emergency braking which will not always result in an impact being avoided.

Tailgating increases the risk of an accident.

Warning!



Distronic brakes your vehicle with a maximum deceleration of 6.5 ft/s² (2 m/s²). This corresponds to about 20% of the maximum deceleration ability of your vehicle.

Distronic brakes the vehicle in an effort to restore the preset distance or to maintain the speed.

Driving systems

Cruise control lever

The Distronic system is operated by means of the cruise control lever.

The cruise control lever is the uppermost lever on the left-hand side of the steering column.

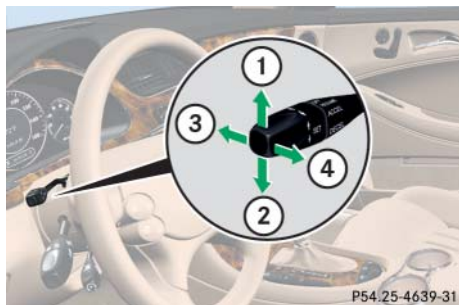

- ① Set current or higher speed
- ② Set current or lower speed
- ③ Deactivate Distronic
- ④ Resume at last set speed

Activating Distronic

You can activate Distronic if:

- you are driving between 20 mph (30 km/h) and 110 mph (180 km/h)
- the ESP® is activated (▷ page 94)

If Distronic has not been activated after pressing the cruise control lever you will see the message --- in the multifunction display.

In the following cases you cannot activate Distronic:

- up to 2 minutes after starting the engine
- when you brake
- if you have set the parking brake
- if the gear selector lever is in position **P**, **R** or **N**
- if the ESP® is switched off

Setting the current speed

- ▶ Accelerate or decelerate to the desired speed.
- ▶ Briefly lift or depress the cruise control lever.

Distronic is activated and the current speed is set.

- ▶ Remove your foot from the accelerator pedal.

i *If you do not take your foot off the accelerator completely, the following message will appear in the multifunction display: DISTRONIC override. The distance to a slower moving vehicle in front of you will not be set. Your vehicle speed will then be determined only by the accelerator pedal position.*

Setting a higher speed

- ▶ Briefly tip the cruise control lever in the direction of arrow ① (▷ page 224) to increase vehicle speed in increments of 5 mph (Canada: 10 km/h).

The new speed is set.

The stored speed is displayed in the multifunction display for approximately 5 seconds (▷ page 223), and one or two segments around the stored speed come on, on the speedometer (▷ page 221).

i *Depressing the accelerator pedal does not deactivate DISTRONIC. After brief acceleration (e.g. for passing), the cruise control will resume the last speed set.*

Setting a lower speed

- ▶ Briefly tip the cruise control lever in the direction of arrow ② (▷ page 224) to decrease vehicle speed in increments of 5 mph (Canada: 10 km/h).

The new speed is set.

The stored speed is displayed in the multifunction display for approximately 5 seconds (▷ page 223), and one or two segments around the stored speed come on, on the speedometer (▷ page 221).

i *When you use the cruise control lever to decelerate, the brakes will be applied to support deceleration.*

In addition, the transmission will automatically downshift on long downhill grades.

Fine adjustment in 1 mph (Canada: 1 km/h) increments

Faster

- ▶ Briefly tip the cruise control lever in the direction of arrow ④ (▷ page 224).

Driving systems

Setting stored speed ("Resume" function)

Warning!



The speed stored in memory should only be set again if prevailing road conditions permit. Possible acceleration or deceleration differences arising from returning to the pre-set speed could cause an accident and/or serious injury to you and others.

- ▶ Briefly tip the cruise control lever in the direction of arrow ④ (▷ page 224).
Distronic is activated and set to the last stored speed.
- ▶ Remove your foot from the accelerator pedal.

Deactivating Distronic

There are several ways to deactivate the Distronic system:

- ▶ Briefly tip the cruise control lever in the direction of arrow ③ (▷ page 224).

or

- ▶ Step on the brake pedal.

Distronic will be deactivated. The last speed set will be stored in memory.

i *The following message will appear in the multifunction display for approximately 5 seconds: DISTRONIC Off.*

The last stored speed is deleted when you turn off the engine.

Distronic deactivates automatically when:

- you set the parking brake
- you drive slower than 20 mph (30 km/h)
- the ESP® is active (▷ page 94) or you deactivate the ESP®
- you move the gear selector lever into position **N**

A signal will sound. The **DISTRONIC Off** message appears in the multifunction display for approximately 5 seconds.

Warning!



Distronic switches off and releases the brakes when the vehicle decelerates below the minimum speed of approximately 20 mph (30 km/h) by operation of the system. At that time the driver must apply the brakes in order to reduce vehicle speed further or bring it to a stop.

Setting the following distance in DISTRONIC

You can set the specified following distance for DISTRONIC by varying the time setting between 1.0 and 2.0 seconds. Using this time setting and the current speed of your vehicle, DISTRONIC calculates and sets the required following distance to the vehicle ahead. The set distance will be shown in the multifunction display field.

The thumbwheel for making the time setting is located on the lower section of the center console.

Warning!



It is up to the driver to exercise discretion to select the appropriate setting given road conditions, traffic, driver's preferred driving style and applicable laws and driving recommendations for safe following distance.



- ① Distance warning function on/off switch
- ② Indicator lamp
- ③ Thumbwheel for setting distance

Increasing distance

Increasing the distance setting tells DISTRONIC to maintain a greater following distance to the vehicle ahead.

- ▶ Turn thumbwheel ③ towards .

Decreasing distance

Decreasing the distance setting tells DISTRONIC to maintain a shorter following distance to the vehicle ahead.

- ▶ Turn thumbwheel ③ towards .

Distance warning function

When DISTRONIC is deactivated, this function will continue to warn you when recognizing a stationary obstacle or a slower vehicle moving in the vehicle's path and the danger of a collision exists:

- The distance warning lamp  in the instrument cluster comes on.
- An intermittent warning will sound if necessary.

If these warnings are issued, you must brake manually to maintain a safe distance and avoid a collision with the vehicle ahead.

Driving systems

When pressing the brake pedal, the warning sound ceases. The warning sound will also cease when the distance to the vehicle ahead is sufficient again without applying the brakes. In this case, the distance warning lamp also goes out.

Warning!



If the distance warning lamp  in the instrument cluster comes on while driving and/or an intermittent warning sounds, immediate attention on the part of the driver is required. As required by the traffic situation, apply the brakes and navigate around a possible obstacle. However, do not drive by relying on the distance warning function, as this will result in an emergency braking application. Especially depending on road surface conditions and driver reaction, this will not always enable you to avoid a collision.

i *Complex driving situations are not always fully recognized by Distronic. This could result in wrong or missing distance warnings.*

Activating

- ▶ Press switch ①.

The indicator lamp ② on the switch comes on. A loudspeaker symbol appears in the multifunction display (▶ page 223).

Deactivating

- ▶ Press switch ①.

The indicator lamp ② on the switch goes out. No loudspeaker symbol appears in the multifunction display.

Driving with Distronic

This section describes a number of driving situations where special precaution is required on the part of the driver. Be prepared to brake in such situations. This will deactivate the Distronic system.

Warning!



Distronic works to maintain the speed selected by the driver unless a moving obstacle proceeding directly ahead of it in the same travel direction is detected (e.g. following another vehicle ahead of you at a distance set by Distronic). This means that:

- Your vehicle can pass another vehicle after you change lanes.
- While in a sharp turn or if the vehicle in front is in a sharp turn, Distronic could lose sight of a vehicle traveling in front of it, then your vehicle could accelerate to the previously selected speed.

DISTRONIC regulates only the distance between your vehicle and those directly ahead of it, but does not register stationary objects in the road, e.g.:

- a stopped vehicle in a traffic jam
- a disabled vehicle
- an oncoming vehicle

The driver must always be on the alert, observe all traffic and intercede as required by steering or braking the vehicle.

Warning!



DISTRONIC should not be used in snowy or icy road conditions.

The most likely cause for a malfunctioning system is a dirty sensor (located behind the hood grille), especially at times of snow and ice or heavy rain. In such a case, DISTRONIC will switch off, and the message **DISTRONIC currently unavailable** See Operator's Manual appears in the multifunction display.

For cleaning and care of the DISTRONIC sensor, see "Cleaning the DISTRONIC* system sensor cover" (▷ page 336).

i *If the message **DISTRONIC currently unavailable** See Operator's Manual disappears during driving and the last speed stored flashes for approximately 5 seconds, the dirt (e.g. slush) has dissolved; DISTRONIC works again.*

Turns and bends

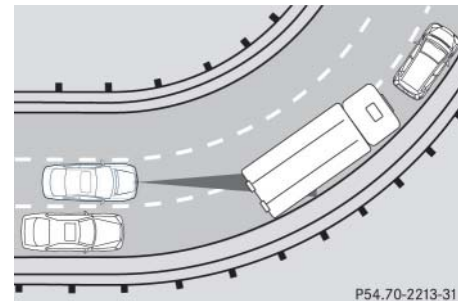

P54.70-2213-31

In turns or bends, DISTRONIC may not detect a moving vehicle in front, or it may detect one too soon. This may cause your vehicle to brake late or unexpectedly.

Driving systems

Offset driving

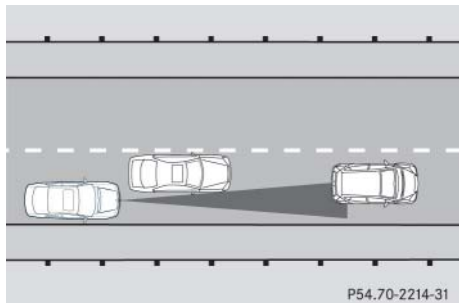

A vehicle traveling in your lane but offset from your direct line of travel may not be detected by DISTRONIC. There will be insufficient distance to the vehicle ahead.

Lane changing

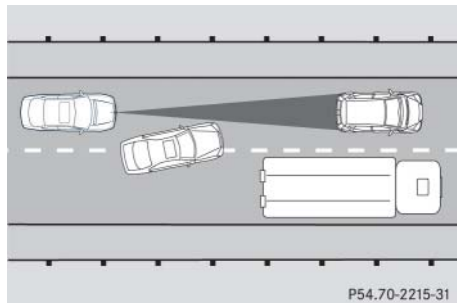

DISTRONIC has not yet detected the vehicle changing lanes. There will be insufficient distance to the lane-changing vehicle.

Narrow vehicles

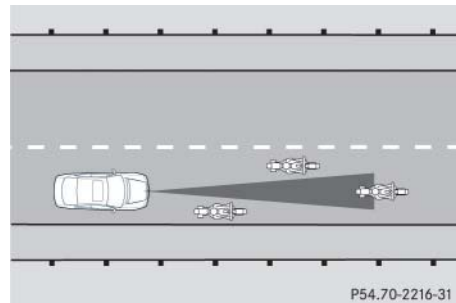

Because of their narrow profile, the vehicles traveling near the outer edges of the lane have not yet been detected by DISTRONIC. There will be insufficient distance to the vehicles ahead.

Airmatic DC (Dual Control)

Airmatic automatically selects the optimum suspension tuning and ride height for your vehicle. The Airmatic consists of two components:

- Adaptive Damping System (ADS)
- Vehicle level control

The ADS automatically selects the optimum damping for the respective driving conditions. At the same time the suspension is set to either Sport 1, Sport 2 or Comfort.

Suspension tuning

The suspension tuning is set according to:

- Your driving style
- Road surface conditions
- Your choice of suspension style, Sport 1, Sport 2 or Comfort, which you select using the damping button

The following suspension styles are available:

- Comfort
Both indicator lamps ② are off.
- Sport 1
One indicator lamp ② is on.
- Sport 2
Both indicator lamps ② are on.



- ① Damping button
- ② Indicator lamps

- ▶ Start the engine (▷ page 51).
- ▶ Press the damping button ① until the desired suspension style is set.

! If you have selected the Comfort suspension tuning (▷ page 231), the vehicle lowers slightly when you lock it within approximately 60 seconds after switching off the engine. When parking, make sure that your vehicle cannot come into contact with other objects, such as a curb, while lowering. Your vehicle could otherwise be damaged.

i The selected suspension style is stored in memory, even after the SmartKey is removed from the starter switch.

Driving systems

Vehicle level control

Your vehicle automatically adjusts its ride height to

- increase vehicle safety
- reduce fuel consumption

The following vehicle chassis ride heights can be selected:

- Normal
- Raised

The vehicle chassis ride height is raised or lowered according to the selected level setting and to the vehicle speed:

- At a speed exceeding approximately 68 mph (110 km/h) with normal level set or exceeding 75 mph (120 km/h) with raised level set, the ride height is reduced automatically. The table on the next page provides an overview of the vehicle levels.

- With decreasing speed, the ride height is again raised to the normal level.

i *These height adjustments are so small that you may not notice any change.*

Select the raised level only when required by current driving conditions. Otherwise

- handling may be impaired
- fuel consumption may increase

Warning!



To help avoid personal injury, keep hands and feet away from wheel housing area, and stay away from under the vehicle when lowering the vehicle chassis.

The following vehicle level settings can be selected when the vehicle is stationary and the engine is running:

Vehicle level when stationary	Indicator lamp (▷ page 234)	Suspension tuning	Use for	Ride height increase over normal	Automatic lowering
Normal	Lamp off	Comfort	For driving on normal roads	None	Max. approx. 0.4 in (10 mm)
Normal	Lamp off	Sport 1 or 2	For driving on normal roads	None	Max. approx. 0.6 in (15 mm)
Raised	Lamp on	Comfort	For driving on rough roads or with snow chains	Approx. 0.8 in (20 mm)	Max. approx. 1.2 in (30 mm)
Raised	Lamp on	Sport 1 or 2	For driving on rough roads or with snow chains	Approx. 0.8 in (20 mm)	Max. approx. 1.4 in (35 mm)

Driving systems

The button is located in the lower section of the center console.



- ① Vehicle level control button
- ② Indicator lamp

- ▶ Start the engine (▷ page 51).
- ▶ Briefly press button ① to change from normal level to raised level. When vehicle is at raised level, pressing the button will return the vehicle to normal level.

When raised level is set, indicator lamp ② in the button comes on.

When normal level is set, indicator lamp ② in the button goes out.

i At a speed of approximately above 75 mph (120 km/h) or if the speed amounts to between 50 mph (80 km/h) and 75 mph (120 km/h) for approximately five minutes, the setting raised is canceled. The indicator lamp ② in the button goes out.

If you do not drive in this speed range, the raised level remains stored even if the SmartKey is removed from the starter switch.

Parktronic system (Parking assist)***Warning!**

Parktronic is a supplemental system. It is not intended to, nor does it replace, the need for extreme care. The responsibility during parking and other critical maneuvers always rests with the driver.

Special attention must be paid to objects with smooth surfaces or low silhouettes (e.g. trailer couplings, painted posts, or road curbs). Such objects may not be detected by the system and can damage the vehicle.

The operational function of the Parktronic system can be affected by dirty sensors, especially at times of snow and ice, see “Cleaning the Parktronic* system sensors” (▷ page 336).

Interference caused by other ultrasonic signals (e.g. working jackhammers, car wash or the air brakes of trucks) can cause the system to send erratic indications, and should be taken into consideration.

Warning!

Make sure no persons or animals are in the area in which you are maneuvering. You could otherwise injure them.

The Parktronic system is an electronic aid designed to assist the driver during parking maneuvers. It visually and audibly indicates the relative distance between the vehicle and an obstacle.

The Parktronic system is automatically activated when you switch on the ignition, release the parking brake, and placed the gear selector lever in position **D**, **R**, or **N**. The Parktronic system deactivates at speeds over approximately 11 mph (18 km/h). At lower speeds the Parktronic system turns on again.

The Parktronic system also deactivates when you place the gear selector lever in position **P** or depress the parking brake pedal.

The Parktronic system monitors the surroundings of your vehicle with six sensors in the front bumper and four sensors in the rear bumper.

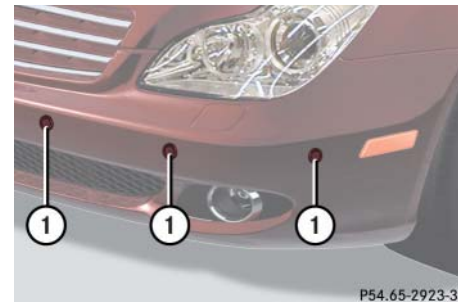

① Sensors in the front bumper

Range of the sensors

To function properly, the sensors must be free of dirt, ice, snow and slush. Clean the sensors regularly, being careful not to scratch or damage the sensors, see “Cleaning the Parktronic* system sensors” (▷ page 336).

Driving systems

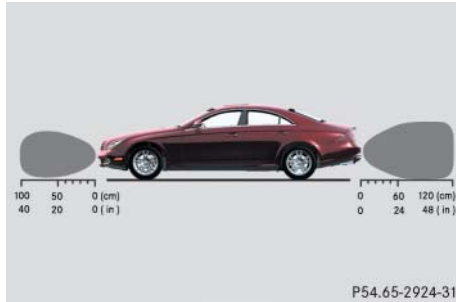

Front sensors

Center	approx. 40 in (100 cm)
Corners	approx. 24 in (60 cm)

Rear sensors

Center	approx. 48 in (120 cm)
Corners	approx. 32 in (80 cm)

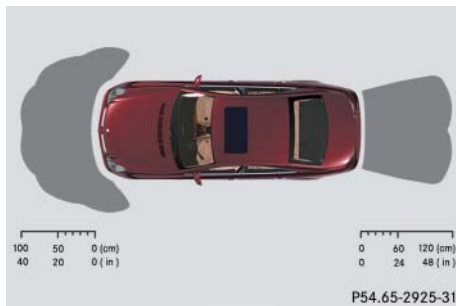

! *During parking maneuvers, pay special attention to objects located above or below the height of the sensors (e.g. planters or trailer hitches). The Parktronic system will not detect such objects at close range and damage to your vehicle or the object may result.*

Ultrasonic signals from outside sources (e.g. truck air brakes, car wash or jackhammers) may impair the operation of the Parktronic system.

Minimum distance

Center	approx. 8 in (20 cm)
Corners	approx. 6 in (15 cm)

If the system detects an obstacle in this range, all the distance warning segments illuminate and you hear a warning signal. If the obstacle is closer than the minimum distance, the actual distance might no longer be indicated by the system.

Warning indicators

Visual signals indicate to the driver the relative distance between the sensors and an obstacle. The warning indicator for the front area is located above the center air vents in the dashboard. The warning indicator for the rear area is integrated in the rear trim.

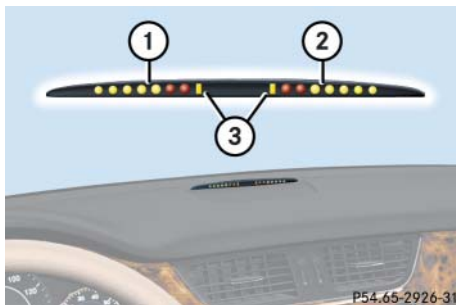

Front area warning indicator

- ① Left side of the vehicle
- ② Right side of the vehicle
- ③ Readiness indicators

Each warning indicator is divided into five yellow and two red segments for either side of the vehicle. The Parktronic system is operational when the yellow readiness indicators ③ are illuminated.

The position of the gear selector lever determines which warning indicators will be activated.

Gear selector lever position	Warning indicator
D	Front area activated
R or N	Front and rear area activated
P	Neither activated

As your vehicle approaches an object, one or more segments will come on, depending on the distance. When the seventh segment illuminates, you have reached the minimum distance.

- Front area: An intermittent acoustic warning will sound as the first red distance segment illuminates and a constant acoustic warning lasting a maximum of 2 seconds will sound for the second red distance segment. The signal is canceled when the gear selector lever is placed in position **P** or the parking brake is activated.
- Rear area: An intermittent acoustic warning will sound as the first red distance segment illuminates and a constant acoustic warning lasting a maximum of 2 seconds will sound for the second red distance segment. The signal is canceled when the gear selector lever is placed in position **D**, **P** or the parking brake is activated.

Driving systems

Switching the Parktronic system on/off

The Parktronic system can be switched off manually.

The Parktronic switch is located in the lower part of the center console (▷ page 30).

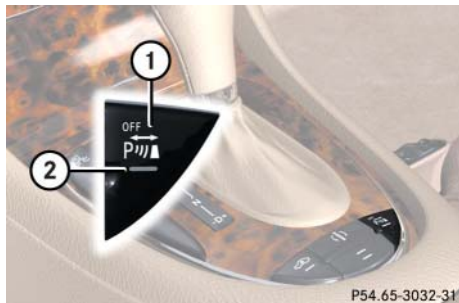

- ① Parktronic switch
- ② Indicator lamp

Switching off the Parktronic system

- ▶ Press Parktronic switch ①.
- Indicator lamp ② comes on.

Switching on the Parktronic system

- ▶ Press Parktronic switch ① again.
- Indicator lamp ② goes out.

i The Parktronic system is automatically switched on when the ignition is switched on (▷ page 38).

Parktronic system malfunction

If only the red distance segments illuminate and an acoustic warning sounds, there is a malfunction in the Parktronic system. The Parktronic system will automatically switch off after 20 seconds and the indicator lamp in the Parktronic switch comes on.

- ▶ Have the Parktronic system checked by an authorized Mercedes-Benz Center as soon as possible.

If only the red distance segments illuminate and no acoustic warning sounds, the Parktronic system sensors are dirty or there is an interference from other radio or ultrasonic signals. The Parktronic system will automatically switch off after 20 seconds and the indicator lamp in the Parktronic switch comes on.

- ▶ Switch off the ignition (▷ page 38).
- ▶ Clean the Parktronic system sensors (▷ page 336).
- ▶ Switch on the ignition (▷ page 38).
- or
- ▶ Check the Parktronic system operation at another location to rule out interference from outside radio or ultrasonic signals.

▼ Loading

Roof rack*

Warning!



Only use roof racks approved by Mercedes-Benz for your vehicle model to avoid damage to the vehicle.

Follow the manufacturer's installation instructions. Otherwise, an improperly attached roof rack system or its load could become detached from the vehicle.

Do not exceed the maximum roof load of 220 lb (100 kg).

Take into consideration that when the roof rack is loaded, the handling characteristics are different from those when operating the vehicles without the roof rack loaded.

! Load the roof rack in such a way that the vehicle cannot be damaged while driving.

Make sure

- you can fully raise the tilt/sliding sunroof
- you can fully open the trunk

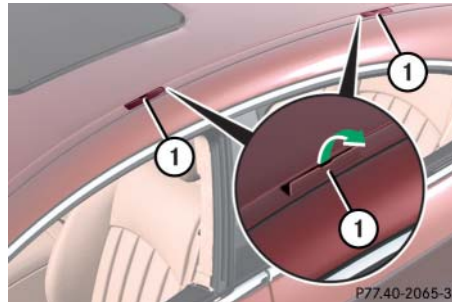

① Trim

- ▶ Open trim ① at the trim strips in the roof.
- ▶ Secure the roof rack according to manufacturer's instructions for installation.

Loading instructions

The total load weight including vehicle occupants and luggage/cargo should not exceed the total load limit indicated on the corresponding placard located on the driver's door B-pillar.

The handling characteristics of a fully loaded vehicle depend greatly on the load distribution. It is therefore recommended to load the vehicle according to the illustrations shown, with the heaviest items being placed towards the front of the vehicle.

Always place items being carried against front or rear seat backrests, and fasten them as securely as possible.

The heaviest portion of the cargo should always be kept as low as possible since it influences the handling characteristics of the vehicle.

Warning!



Always fasten items being carried as securely as possible using fastening materials appropriate for the weight and size of the load.

In an accident, during hard braking or sudden maneuvers, loose items will be thrown around inside the vehicle and can cause injury to vehicle occupants unless the items are securely fastened in the vehicle.

To help avoid personal injury during a collision or sudden maneuver, exercise care when transporting cargo. Put luggage or cargo in the trunk if possible. Do not pile luggage or cargo higher than the seat backs. Do not place anything on the rear-window shelf.

Never drive vehicle with trunk open. Deadly carbon monoxide (CO) gases may enter vehicle interior, resulting in unconsciousness and death.

Ski bag* (Canada only)

Unfolding and loading

- ▶ Fold rear armrest down (arrow).

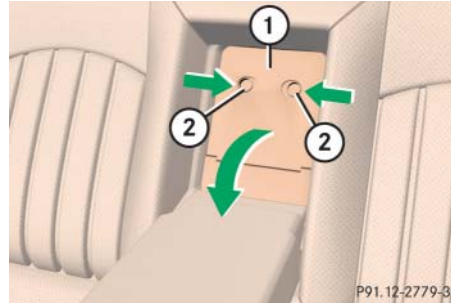

- ① Cover
- ② Catch
- ▶ Pull catches ② in direction of arrows.
- ▶ Open the cover ① downwards in the direction of the arrow.

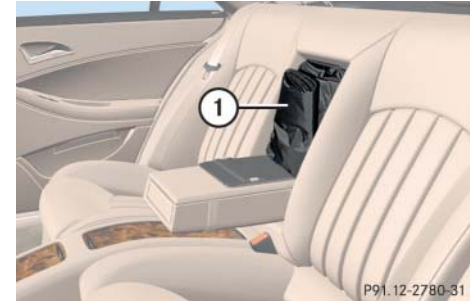

- ① Hook and loop fastener
- ▶ Unfasten hook and loop fastener ①.
- ▶ Pull ski bag into passenger compartment and unfold.
- ▶ Open the front storage compartment in the rear center console (▶ page 248).
- ▶ Remove the cup holder (▶ page 248).

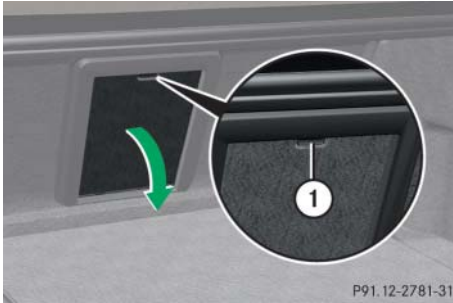

P91.12-2781-31

① Button

- ▶ Open the trunk.
- ▶ Press button ①.

The flap opens in direction of arrow.

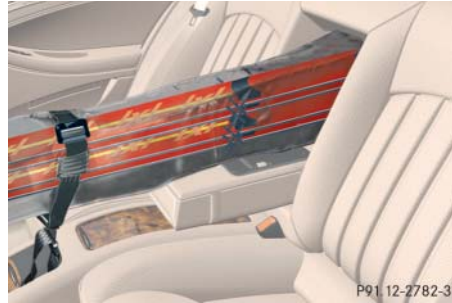

P91.12-2782-31

- ▶ From trunk, slide skis into ski bag.

Warning!



The ski bag is designed for up to four pairs of skis. Do not load the ski bag with other objects.

Always fasten the ski bag securely. In an accident, an unfastened ski bag can cause injury to vehicle occupants.



P91.12-2783-31

① Strap

- ▶ Tighten strap ① by pulling at the loose end (arrow) until the skis in the ski bag are tightly secured. ▷▷

Loading



① Cover

- ▶ With insert or cup holder removed, fold cover ① upward.



① Hook

② Eye

- ▶ Connect hook ① to eye ② located in the front storage compartment in the rear center console.
- ▶ Tighten strap by pulling at the loose end (arrow).

Unloading and folding

- ▶ Loosen both straps.
- ▶ Disconnect hook ① from eye ②.
- ▶ Unload skis.
- ▶ Close flap in trunk.
- ▶ Fold and flatten ski bag lengthwise.
- ▶ Place folded ski bag inside recess of backrest.
- ▶ Fasten hook and loop fastener
- ▶ Close ski bag compartment cover.

Removal of ski bag

For removal of the ski bag, we recommend that you contact an authorized Mercedes-Benz Center.

Warning!



Never drive vehicle with trunk open while the ski bag is removed. Deadly carbon monoxide (CO) gases may enter vehicle interior, resulting in unconsciousness and death.

i To prevent unauthorized persons from access to the trunk, always close the cover.

Cargo tie-down rings

Four rings are located in the trunk.



- Carefully secure cargo by applying even load on all rings with rope of sufficient strength to hold down the cargo. Always follow loading instructions (▷ page 239).

Retaining hooks

Depending on vehicle production date one or two hooks are located on the upper edge of the trunk and can be used to attach cargo items such as bags.

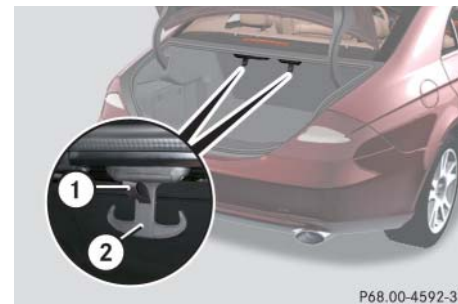

- Pull tab ① of retaining hook ② down.

! Do not use the retaining hooks to tie down cargo.

Useful features

Storage compartments

Warning!



To help avoid personal injury during a collision or sudden maneuver, exercise care when storing objects in the vehicle. Put luggage or cargo in the trunk if possible. Do not pile luggage or cargo higher than the seat backs. Do not place anything on the shelf below the rear window.

Luggage nets cannot secure hard or heavy objects.

Keep compartment lids closed. This will help to prevent stored objects from being thrown about and injuring vehicle occupants during an accident.

Glove box

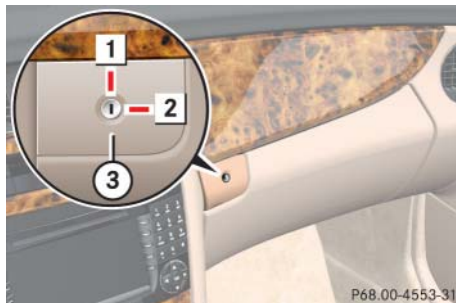

- | | |
|---|-----------------------|
| 1 | Unlocked |
| 2 | Locked |
| ③ | Glove box lid release |

Opening and closing the glove box

- ▶ Press glove box lid release ③ to open.
The glove box lid opens downward.
- ▶ Push lid up to close.

Locking and unlocking the glove box

- ▶ Insert mechanical key (▷ page 396) into the glove box lock.
- ▶ Turn the mechanical key to position 2 to lock or to position 1 to unlock the glove box.

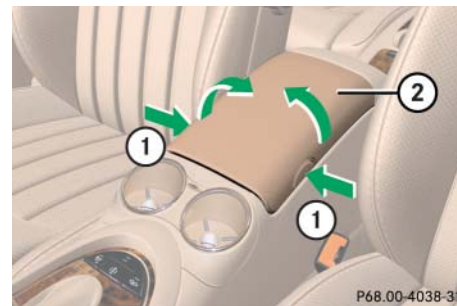

Storage compartment/telephone* compartment under center armrest



- ① Button to open storage/telephone* compartment
- ② Cover

Opening

- ▶ Press button ① right or left and fold the cover ② sideward.

i The mobile phone cradle (▷ page 254), the Roadside Assistance button  and the Information button  (▷ page 257) are located below the cover ②.

Rear storage compartment in the rear center console

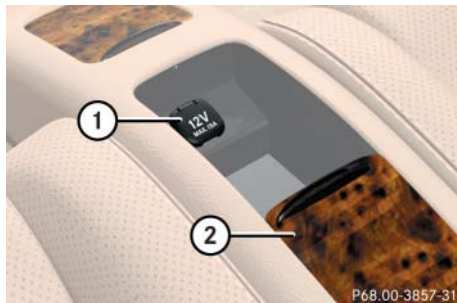

- ① Power outlet (▷ page 251)
- ② Cover
- ▶ Slide cover ② back.

Storage compartment in the rear armrest



- ▶ Press the handle upwards and fold the rear armrest cover up.

! Do not sit on or lean your body weight against the armrest when it is folded down, as you could otherwise damage it.

Storage compartment under the driver's seat

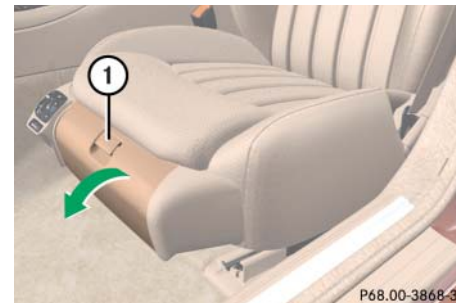

- ① Tab
- ▶ Pull tab ① upward.
- ▶ Fold the covering forward.

Useful features

Ruffled storage bags



Ruffled storage bags are located on the back of the front seats.

Warning!



USA only: Do not place objects with a combined weight of more than 4.4 lb (2 kg) into the ruffled storage bag. Otherwise, the Occupant Classification System OCS (▷ page 71) may not be able to properly approximate the occupant weight category.

The ruffled storage bag is intended for storing light-weight items only.

Heavy objects, objects with sharp edges or fragile objects may not be transported in the parcel net. In an accident, during hard braking, or sudden maneuvers, they could be thrown around inside the vehicle and cause injury to vehicle occupants.

The ruffled storage bag cannot protect transported goods in the event of an accident.

Parcel net in front passenger footwell



A small convenience parcel net is located in the front passenger footwell. It is for small and light items, such as road maps, mail, etc.

Warning!



The parcel net is intended for storing light-weight items only.

Heavy objects, objects with sharp edges or fragile objects may not be transported in the parcel net. In an accident, during hard braking, or sudden maneuvers, they could be thrown around inside the vehicle and cause injury to vehicle occupants.

The parcel net cannot protect transported goods in the event of an accident.

Cup holders

Warning!



In order to help prevent spilling liquids on vehicle occupants and/or vehicle equipment, only use containers that fit into the cup holder. Use lids on open containers and do not fill containers to a height where the contents, especially hot liquids, could spill during braking, vehicle maneuvers, or in an accident. Liquids spilled on vehicle occupants may cause serious personal injury. Liquids spilled on vehicle equipment may cause damage not covered by the Mercedes-Benz Limited Warranty.

The cup holder must be extended when in use with bottles.

When not in use, keep the cup holder closed. An open cup holder may cause injury to you or others when contacted during braking, vehicle maneuvers, or in an accident.

Keep in mind that objects placed in the cup holder may come loose during braking, vehicle maneuvers, or in an accident and be thrown around in the vehicle interior. Objects thrown around in the vehicle interior may cause an accident and/or serious personal injury.

Cup holder in the center console

Extending the cup holder



- ▶ Briefly press mark on cup holder.
The cup holder automatically extends upward.

Retracting the cup holder

- ▶ Press mark on cup holder and push cup holder in until it engages.

Useful features

Removing the cup holder

i The cup holder can be removed for cleaning. Clean the cup holder with clear, lukewarm water.

- ▶ Extend cup holder (▷ page 247).
- ▶ Press mark on cup holder and remove cup holder by pulling it upward.

Reinstalling the cup holder

- ▶ Insert cup holder into opening.

! Make sure that the cup holder is correctly positioned in the guide while you are reinstalling it. Otherwise the cup holder can be damaged.

- ▶ Press mark on cup holder and press cup holder downward until it engages.

Cup holder in the rear center console



① Cover

- ▶ Slide cover ① forward.

Removing cup holder

i The cup holder can be removed for cleaning. Clean the cup holder with clear, lukewarm water.



① Cup holder

② Locking pin

- ▶ Move pin ② in direction of arrow to unlock the cup holder.
- ▶ With the cup holder unlocked, take cup holder ① out upwards.

Reinstalling cup holder

- ▶ Insert cup holder ①.
- ▶ Move pin ② against direction of arrow to lock the cup holder.

Cup holder in the rear seat armrest



- ▶ Briefly press the front of the rear armrest.

The cup holder extends automatically.

Ashtrays

Center console ashtray



- ① Cover
- ② Sliding button

Opening ashtray

- ▶ Briefly press the marking on the bottom of cover ①.

The ashtray opens automatically.

Removing ashtray insert

Warning!



Remove front ashtray only with vehicle standing still. Set the parking brake to secure vehicle from movement. Move gear selector lever to position **N**. With gear selector lever in position **N**, turn off the engine.

- ▶ Secure vehicle from movement by setting the parking brake. Move the gear selector lever to position **N**.

Now you have more room to take out the insert.

- ▶ Push sliding button ② to the right and hold.
- ▶ Grip and remove insert from ashtray frame.

Useful features

Reinstalling ashtray insert

- ▶ Install insert by pushing it back into frame until it engages again.

Rear door ashtray

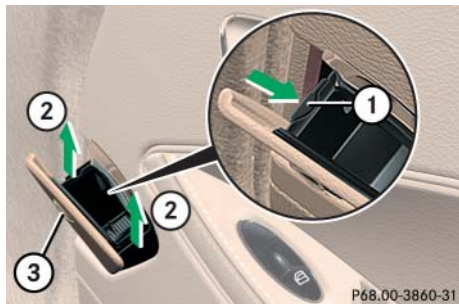

- ① Sliding button
- ② Insert slides out
- ③ Ashtray

Opening rear seat ashtray

- ▶ Briefly press the top of ashtray ③.
The ashtray opens.

Removing ashtray insert

- ▶ Push sliding button ① and remove insert ② upwards from ashtray frame.

Reinstalling ashtray insert

- ▶ Install insert by pushing it back into ashtray frame until it engages again.

Cigarette lighter

Warning!



Never touch the heating element or sides of the lighter; they are extremely hot. Hold the knob only.

Make sure that any children traveling with you do not injure themselves or start a fire with the hot cigarette lighter.

When leaving the vehicle, always remove the SmartKey or the SmartKey with KEYLESS-GO* from the starter switch, take it with you, and lock the vehicle. Do not leave children unattended in the vehicle, or with access to an unlocked vehicle. A child's unsupervised access to a vehicle could result in an accident and/or serious personal injury.

The cigarette lighter is located in the center console compartment in front of the center armrest (▷ page 30).



① Cigarette lighter

- ▶ Switch on the ignition (▷ page 38).
- ▶ Push in cigarette lighter ①.

The lighter will pop out automatically when hot.

! *The lighter socket can be used to accommodate 12V DC electrical accessories (up to a maximum 85 W) designed for use with the standard “cigarette lighter” plug type. Keep in mind, however, that connecting accessories to the lighter socket (for example extensive connecting and disconnecting, or using plugs that do not fit properly) can damage the lighter socket. With the socket damaged, the lighter may no longer be able to be placed in the heating (pushed-in) position, or the lighter may pop out too early with the lighter not hot enough.*

To help avoid damaging the cigarette lighter socket, we recommend connecting 12V DC electrical accessories designed for use with a standard “cigarette lighter” plug type to the 12V power outlets (▷ page 251) in your vehicle whenever possible.

Power outlets

! *Make sure no fluids come into contact with the power outlet, as this could cause a short circuit.*

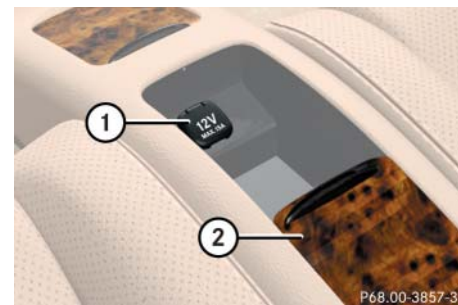

Power outlet in rear center console

- ① Power outlet
- ② Cover
- ▶ Slide cover ② back.

i *Make sure the override switch is not activated (▷ page 89). The power outlet in the rear center console will not function if the override switch is activated.*



Useful features



P68.00-4457-31

Power outlet in trunk

① Power outlet

i The power outlet can be used to accommodate 12-V DC electrical accessories (e.g. air pump, auxiliary lamps) up to a maximum 180 W.

Heated steering wheel (Canada only)

The steering wheel heating warms up the leather area of the steering wheel.

The stalk is on the lower left-hand side of the steering wheel.

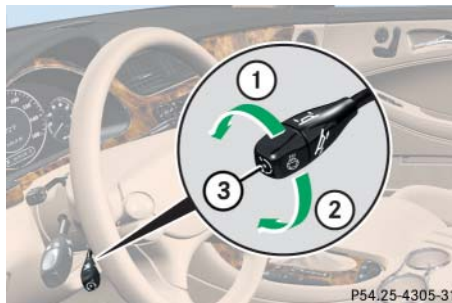

P54.25-4305-31

- ① Switching on
- ② Switching off
- ③ Indicator lamp

Switching on

- ▶ Switch on the ignition (▷ page 38).
- ▶ Turn switch at the tip of stalk in direction of arrow ①.

The steering wheel is heated. Indicator lamp ③ comes on.

i The steering wheel heating is temporarily suspended while indicator lamp ③ remains on when

- the temperature of the vehicle interior is above 86°F (30°C)
- the temperature of the steering wheel is above 95°F (35°C)

When these conditions do not apply anymore, steering wheel heating continues.

Switching off

- ▶ Turn switch at the tip of stalk in direction of arrow ②.

The heated steering wheel is switched off. Indicator lamp ③ goes out.

- i** Indicator lamp ③ flashes or goes out
 - in case of power surge or undervoltage
 - in case of a steering wheel heating malfunction

i The steering wheel heating switches off automatically when you remove the SmartKey from the starter switch or, on vehicles with KEYLESS-GO*, when you switch off the ignition (▷ page 61) and open the driver's door.

For information on steering wheel, see "Multifunction steering wheel" (▷ page 142).

Floormats

Warning!



Whenever you are using floormats, make sure there is enough clearance and that the floormats are securely fastened.

Floormats should always be securely fastened using eyelets ② and retainer pins ①.

Before driving off, check that the floormats are securely in place and adjust them if necessary. A loose floormat could slip and hinder proper functioning of the pedals.

Do not place several floormats on top of each other as this may impair pedal movement.

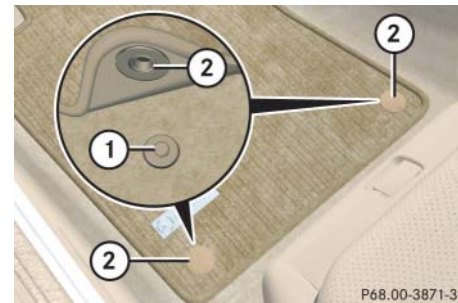

① Retainer pins

② Eyelets

i To install or remove the floormat more easily, move the driver's seat or front passenger seat as far to the rear as possible (▷ page 42).

Removing

- ▶ Pull floormats off of retainer pins ①.
- ▶ Remove the floormats.

Installing

- ▶ Lay down the floormat.
- ▶ Press the floormat eyelets ② onto retainer pins ①.

Useful features

Telephone*

Warning!



Never operate radio transmitters equipped with a built-in or attached antenna (i.e. without being connected to an external antenna) from inside the vehicle while the engine is running. Doing so could lead to a malfunction of the vehicle's electronic system, possibly resulting in an accident and/or serious personal injury.

Radio transmitters, such as a portable telephone or a citizens band unit, should only be used inside the vehicle if they are connected to an antenna that is installed on the outside of the vehicle.

The external antenna must be approved by Mercedes-Benz. Please contact an authorized Mercedes-Benz Center for information on the installation of an approved external antenna. Refer to the radio transmitter operation instructions regarding use of an external antenna.

Warning!



Please do not forget that your primary responsibility is to drive the vehicle. A driver's attention to the road must always be his/her primary focus when driving. For your safety and the safety of others, we recommend that you pull over to a safe location and stop before placing or taking a telephone call.



If you choose to use the telephone¹ while driving, please use the hands-free device and only use the telephone when road, weather and traffic conditions permit. Some jurisdictions prohibit the driver from using a mobile telephone while driving a vehicle.

Only operate the COMAND (Cockpit Management and Data System)¹ if road, weather and traffic conditions permit.

Bear in mind that at a speed of just 30 mph (approximately 50 km/h), your vehicle is covering a distance of 44 feet (approximately 14 m) every second.

¹ Observe all legal requirements.

When the mobile phone is inserted in the cradle, you can operate the telephone using the following devices:

- mobile phone keypad
- COMAND (see separate operating instructions)
- buttons  and  on the multi-function steering wheel
- Voice Control* (see separate operating instructions)

See also separate operating manual for instructions on how to use the mobile phone.

 *Various mobile phone cradles can be installed in the cockpit. These mobile phone cradles can be obtained from an authorized Mercedes-Benz Center.*

The functions and services available to you while using the mobile phone depend on your service provider and the type of mobile phone you are using.

The cradle is located in the center armrest.

- ▶ Open the telephone compartment under center armrest (▷ page 244).

Inserting mobile phone in mobile phone cradle

Once the mobile phone has been inserted in the mobile phone cradle, calls can only be made via the Voice Control*.

! Do not try to remove the mobile phone along with the cradle. You could otherwise damage the mobile phone cradle.

- ▶ If applicable, remove the cover for the external antenna connection from the back of the mobile phone and store it in a safe place. Be sure to comply with the mobile phone's operating instructions, as well.

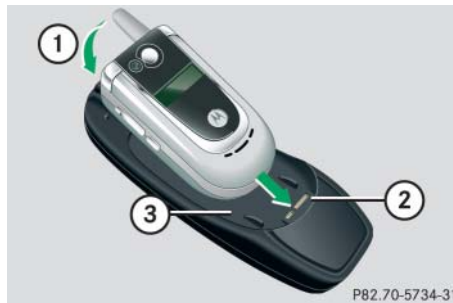

Example illustration

- ① Insert the mobile phone
 - ② Connector contact
 - ③ Mobile phone cradle
- ▶ Slide the lower end of the mobile phone into connector contact ② on cradle ③.
 - ▶ Push the top of the mobile phone in direction of arrow ①, until the lug on the mobile phone release button engages.

The mobile phone is connected to the network via the external antenna.

The mobile phone is linked to the hands-free device and the multifunction steering wheel.

The battery is charged depending on its charge status and the position of the SmartKey in the starter switch. The charge procedure will be indicated in the mobile phone's display.

You can place or receive phone calls. You can control other functions of the mobile phone via the control system (▷ page 168), COMAND or Voice Control* (see separate operating instructions).

i When you take the SmartKey or SmartKey with KEYLESS-GO* out of the starter switch, the mobile phone remains switched on for approx. 10 minutes. If you place or receive a call during this time, the mobile phone switches off 10 minutes after the call has been completed.

Useful features

Removing mobile phone from mobile phone cradle



Example illustration

- ① Release catch for mobile phone
- ② Mobile phone cradle

i When using a flip-style mobile phone, open flip top before removing from the cradle while a call is connected. Otherwise, the call will be disconnected.

- ▶ Press release catch in direction of arrow ① and take mobile phone out of mobile phone cradle ②.

Changing mobile phone cradle

If you require a different cradle for your mobile phone, remove the present cradle before installing a new one.

Removing an existing mobile phone cradle

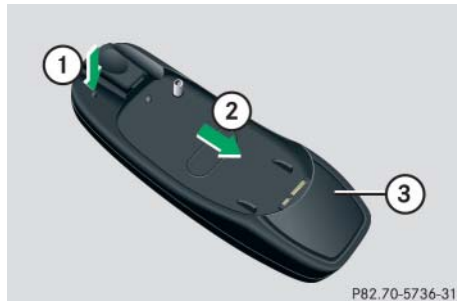

Example illustration

- ① To release the mobile phone cradle
- ② To remove the mobile phone cradle
- ③ Mobile phone cradle

- ▶ Press release button in direction of arrow ① and take mobile phone cradle ③ out in direction of arrow ②.

Installing a different mobile phone cradle

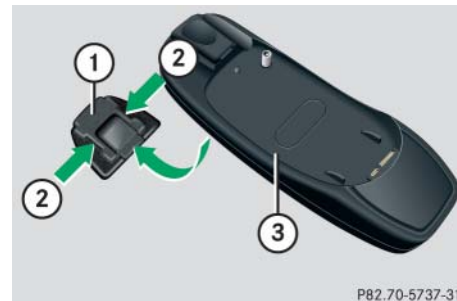

Example illustration

- ① Contact plate
 - ② Recesses
 - ③ Mobile phone cradle
- ▶ Insert mobile phone cradle ③ into recesses ② of contact plate ①.
 - ▶ Push mobile phone cradle ③ forward until it engages.

Tele Aid

! *The initial activation of the Tele Aid system may only be performed by completing the subscriber agreement and placing an acquaintance call using the  button. Failure to complete either of these steps will result in a system that is not activated.*

If you have any questions regarding activation, please call the Response Center at 1-800-756-9018 (in the USA) or 1-888-923-8367 (in Canada).

Shortly after the completion of your Tele Aid acquaintance call, you will receive a user ID and password. By visiting www.mbusa.com and selecting “Tele Aid” (USA only), you will have access to account information, remote door unlock and more.



The Tele Aid system



(Telematic Alarm Identification on Demand)

The Tele Aid system consists of three types of response:



- automatic and manual emergency
- roadside assistance
- information

The Tele Aid system is operational providing that the vehicle’s battery is charged, properly connected, not damaged and cellular and GPS coverage is available.

The speaker volume of a Tele Aid call can be adjusted when using the volume control on the COMAND System or on the multifunction steering wheel. To raise, turn the rotary volume control on COMAND System clockwise or press button  on the multifunction steering wheel. To lower, turn the rotary volume control on COMAND System control counterclockwise or press button  on the multifunction steering wheel.

- ▶ To activate, press the SOS button, the Roadside Assistance button  or the Information button , depending on the type of response required.

i *The SOS button is located in the overhead control panel (▷ page 259).*



The Roadside Assistance button  and the Information button  are located below the center armrest cover (▷ page 244).

Useful features

! *The Tele Aid system utilizes the cellular network for communication and the GPS (Global Positioning System) satellites for vehicle location. If either of these signals are unavailable, the Tele Aid system may not function and if this occurs, assistance must be summoned by other means.*

i *When a Tele Aid call has been initiated, the COMAND System audio is muted and the selected mode (radio, tape or CD) pauses. The optional cellular phone (if installed) and inserted in cradle switches off. If you must use this phone, we recommend that you use it only with the vehicle at a standstill in a safe location. Remove the phone from the cradle and place the call. The navigation* system (if engaged) will continue to run. The multifunction display in the instrument cluster is available for use, and spoken commands are only available by pressing the RPT button on the COMAND System. A pop-up window will appear in the COMAND System display to indicate that a Tele Aid call is in progress. After the Tele Aid call has ended, the optional cellular phone switches on again. A PIN entry might be necessary.*

System self-check

Initially, after switching on ignition, malfunctions are detected and indicated (the indicator lamps in the SOS button, the Roadside Assistance button  and the Information button  stay on longer than 10 seconds or do not come on). The message `Malfunction Visit workshop` appears in the multifunction display.

Warning!



If the indicator lamps on the SOS button, on the Roadside Assistance button, and/or on the Information button remain illuminated continuously in red and/or the message `Malfunction Visit workshop` is displayed in the multifunction display after the system self-check, a malfunction in the system has been detected.

If a malfunction is indicated as outlined above, the system may not operate as expected. Have the system checked at the nearest Mercedes-Benz Center as soon as possible.

Emergency calls

An emergency call is initiated automatically following an accident in which the emergency tensioning devices (ETDs) or air bags deploy.

An emergency call can also be initiated manually by opening the cover next to the interior rear view mirror labeled SOS, then briefly pressing the button located under the cover. See (▷ page 259) for instructions on initiating an emergency call manually.

Once the emergency call is in progress, the indicator lamp on the SOS button will begin to flash. The message `Connecting call` appears in the multifunction display. When the connection is established, the message `Call connected` appears in the multifunction display. All information relevant to the emergency, such as the location of the vehicle (determined by the GPS satellite location system), vehicle model, identification number and color are generated.

A voice connection between the Response Center and the occupants of the vehicle will be established automatically soon after the emergency call has been initiated. The Response Center will attempt to determine more precisely the nature of the accident provided they can speak to an occupant of the vehicle.

The Tele Aid system is available if

- it has been activated and is operational. Activation requires a subscription for monitoring services, connection and cellular air time
- the relevant cellular phone network and GPS signals are available and pass the information on to the response center

i Location of the vehicle on a map is only possible if the vehicle is able to receive signals from the GPS satellite network and pass the information on to the Response Center.

Warning!



If the indicator lamp in the SOS button is flashing continuously and there was no voice connection to the Response Center established, then the Tele Aid system could not initiate an emergency call (e.g. the relevant cellular phone network is not available). The message `Call failed` appears in the multifunction display for approximately 10 seconds.

Should this occur, assistance must be summoned by other means.

Initiating an emergency call manually

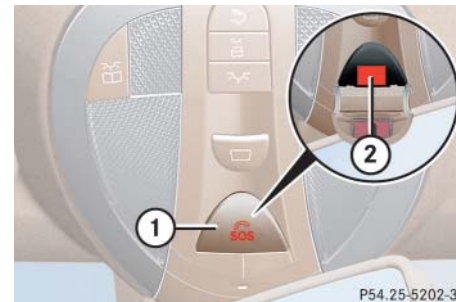

① Cover

② SOS button

- ▶ Briefly press on cover ①.

The cover will open.

- ▶ Press SOS button ② briefly.

The indicator lamp in SOS button ② will flash until the emergency call is concluded.

- ▶ Wait for a voice connection to the Response Center.
- ▶ Close cover ① after the emergency call is concluded.

Warning!



If you feel at any way in jeopardy when in the vehicle (e.g. smoke or fire in the vehicle, vehicle in a dangerous road location), please do not wait for voice contact after you have pressed the emergency button. Carefully leave the vehicle and move to a safe location. The Response Center will automatically contact local emergency officials with the vehicle's approximate location if they receive an automatic SOS signal and cannot make voice contact with the vehicle occupants.

Roadside Assistance button

The Roadside Assistance button  is located below the center armrest cover.

- ▶ Open the storage compartment under the center armrest (▷ page 244).
- ▶ Press and hold button (for longer than 2 seconds).

A call to a Mercedes-Benz Roadside Assistance dispatcher will be initiated. The button will flash while the call is in progress. The message *Connecting call* will appear in the multifunction display.

When the connection is established, the message *Call connected* appears in the multifunction display. The Tele Aid system will transmit data generating the vehicle identification number, model, color and location (subject to availability of cellular and GPS signals).

 *While the call is connected you can change to the navigation menu by pressing NAVI button on the COMAND System unit.*



A voice connection between the Roadside Assistance dispatcher and the occupants of the vehicle will be established.

- ▶ Describe the nature of the need for assistance.

The Mercedes-Benz Roadside Assistance dispatcher will either dispatch a qualified Mercedes-Benz technician or arrange to tow your vehicle to the nearest Mercedes-Benz Center. For services such as labor and/or towing, charges may apply. Refer to the Roadside Assistance Manual for more information.

These programs are only available in the USA:

- Sign and Drive services: Services such as jump start, a few gallons of fuel or the replacement of a flat tire with the vehicle spare tire are obtainable.

i The indicator lamp on the Roadside Assistance button  remains illuminated in red for approximately 10 seconds during the system self-check after switching on the ignition (together with the SOS button and the Information button ).

See system self-check (▷ page 258) if the indicator lamp does not come on in red or stays on longer than approximately 10 seconds.

If the indicator lamp on the Roadside Assistance button  is flashing continuously and there was no voice connection to the Response Center established, then the Tele Aid system could not initiate a Roadside Assistance call (e.g. the relevant cellular phone network was not available). The message `Call failed` appears in the multifunction display.

Roadside Assistance calls can be terminated using the  button on the multifunction steering wheel or the END Button on the COMAND System.

Information button

The Information button  is located below the center armrest cover.

- ▶ Open the storage compartment under the center armrest (▷ page 244).
- ▶ Press and hold button (for longer than 2 seconds).



A call to the Customer Assistance Center will be initiated. The button will flash while the call is in progress. The message `Connecting call` will appear in the multifunction display.

When the connection is established, the message `Call connected` appears in the multifunction display. The Tele Aid system will transmit data generating the vehicle identification number, model, color and location (subject to availability of cellular and GPS signals).

i While the call is connected, you can change to the navigation menu by pressing NAVI button on the COMAND System.

A voice connection between the Customer Assistance Center representative and the occupants of the vehicle will be established. Information regarding the operation of your vehicle, the nearest Mercedes-Benz Center or Mercedes-Benz USA products and services is available to you.

For more details concerning the Tele Aid system, please visit www.mbusa.com and use your ID and password (sent to you separately) to learn more (USA only).

i The indicator lamp in the Information button  remains illuminated in red for approximately 10 seconds during the system self-check after switching on the ignition (together with the SOS button and the Roadside Assistance button .

See system self-check (▷ page 258) if the indicator lamp does not come on in red or stays on longer than approximately 10 seconds.

Useful features

If the indicator lamp in the Information button  is flashing continuously and there was no voice connection to the Response Center established, then the Tele Aid system could not initiate an Information call (e.g. the relevant cellular phone network is not available). The message **Call failed** appears in the multifunction display.

Information calls can be terminated using the  button on the multifunction steering wheel or the END Button on the COMAND System.

! If the indicator lamps do not start flashing after pressing one of the buttons or remain illuminated (in red) at any time, the Tele Aid system has detected a malfunction or the service is not currently active, and may not initiate a call. Visit your authorized Mercedes-Benz Center and have the system checked or contact the Response Center at 1-800-756-9018 (in the USA) or 1-888-923-8367 (in Canada) as soon as possible.

Call priority

If other service calls such as a Roadside Assistance call or Information call are active, an Emergency call is still possible. In this case, the Emergency call will take priority and override all other active calls.

i The indicator lamp in the respective button flashes until the call is concluded. Emergency calls can only be terminated by a Response Center or Customer Assistance Center representative, whereas Roadside Assistance and Information calls can also be terminated by pressing button  on the multifunction steering wheel or using the END button on the COMAND System.

! If the indicator lamp continues to flash or the system does not reset, contact the Response Center at 1-800-756-9018 (in the USA) or 1-888-923-8367 (in Canada), or Mercedes-Benz Customer Assistance at 1-800-FOR-MERCEdes (1-800-367-6372) in the USA or Customer Service at 1-800-387-0100 in Canada.

Remote door unlock

In case you have locked your vehicle unintentionally (e.g. SmartKey inside vehicle), and the reserve SmartKey is not handy:

- ▶ Contact the Mercedes-Benz Response Center at 1-800-756-9018 (in the USA) or 1-888-923-8367 (in Canada).

You will be asked to provide your password which you provided when you completed the subscriber agreement.

- ▶ Then return to your vehicle and pull the tailgate recessed handle for minimum of 20 seconds until the SOS button is flashing.

The message **Connecting call** appears in the multifunction display.

As an alternative, you may unlock the vehicle via Internet using the ID and password sent to you shortly after the completion of your acquaintance call.

The Response Center will then unlock your vehicle with the remote door unlocking feature.

i The remote door unlock feature is available if the relevant cellular phone network is available.

The SOS button will flash and the message Connecting call will appear in the multifunction display to indicate receipt of the door unlock command.

Once the vehicle is unlocked, a Response Center specialist may attempt to establish voice contact with the vehicle occupants.

If the tailgate recessed handle was pulled for more than 20 seconds before door unlock authorization was received by the Response Center, you must wait 15 minutes before pulling the tailgate recessed handle again.

Stolen Vehicle Recovery services

In the event your vehicle was stolen:

- ▶ Report the incident to the police.
The police will issue a numbered incident report.
- ▶ Pass this number on to the Mercedes-Benz Response Center along with your password issued to you when you subscribed to the service.

The Response Center will then attempt to covertly contact the vehicle's Tele Aid system. Once the vehicle is located, the Response Center will contact the local law enforcement and you. The vehicle's location will only be provided to law enforcement.

i When the anti-theft alarm or the tow-away alarm stays on for more than 30 seconds, a call is initiated automatically to the Response Center. See anti-theft alarm system (▷ page 99).

Garage door opener

The integrated remote control is capable of operating up to three separately controlled devices. It provides a convenient way to replace up to three hand-held remote controls used to operate devices such as garage door openers, gate openers, or other devices compatible with HomeLink® or some other systems.

Before the integrated remote control can be used, it must be programmed to the garage door opener, gate operator or other device you wish to operate. See the following instructions for programming information.

Useful features

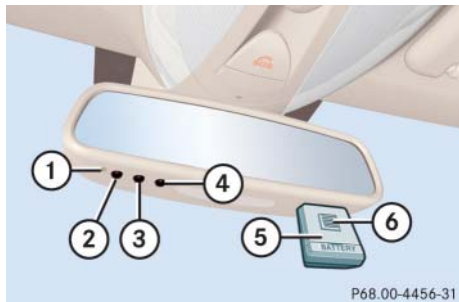

Interior rear view mirror with integrated remote control

- ① Indicator lamp
- ② ③ ④ Signal transmitter button

Needed for programming (not part of vehicle equipment):

- ⑤ Hand-held remote control of garage door opener, gate operator or other device
- ⑥ Hand-held remote control button

Warning!



Before programming the integrated remote control to a garage door opener or gate operator, make sure people and objects are out of the way of the device to prevent potential harm or damage. When programming a garage door opener, the door moves up or down. When programming a gate operator, the gate opens or closes.

Do not use the integrated remote control with any garage door opener that lacks safety stop and reverse features as required by U.S. federal safety standards (this includes any garage door opener model manufactured before April 1, 1982).

A garage door that cannot detect an object – signaling the door to stop and reverse – does not meet current U.S. federal safety standards.

When programming a garage door opener, park the vehicle outside the garage.

Do not run the engine while programming the integrated remote control. Inhalation of exhaust gas is hazardous to your health. All exhaust gas contains carbon monoxide (CO), and inhaling it can cause unconsciousness and possible death.

Programming integrated remote control

Step 1:

- ▶ Switch on the ignition (▷ page 38).

Step 2:

- ▶ If you have previously programmed a signal transmitter button and wish to retain its programming, proceed to step 3.

If you are programming the integrated remote control for the first time, press and hold the two outer signal transmitter buttons (2) and (4) and release them only when indicator lamp (1) begins to flash after approximately 20 seconds (do not hold the button for longer than 30 seconds). This procedure erases any previous settings for all three channels and initializes the memory.

If you later wish to program a second and/or third hand-held transmitter to the remaining two signal transmitter buttons, do not repeat this step and begin directly with step 3.

Step 3:

- ▶ Hold the end of hand-held remote control (5) of the device you wish to train approximately 2 to 5 in (5 to 12 cm) away from the signal transmitter button (2), (3) or (4) to be programmed, while keeping indicator lamp (1) in view.

Step 4:

- ▶ Using both hands, simultaneously press hand-held remote control button (6) and the desired signal transmitter button (2), (3) or (4). Do not release the buttons until step 5 is completed.

Indicator lamp (1) will flash, first slowly and then rapidly.

i Indicator lamp (1) flashes immediately the first time the signal transmitter button is programmed. If this button has already been programmed, the indicator lamp will only start flashing after 20 seconds.

Step 5:

- ▶ After indicator lamp (1) changes from a slow to a rapidly flashing light, release the hand-held remote control button and the signal transmitter button.

Step 6:

- ▶ Press and hold the just-trained signal transmitter button (2), (3) or (4) and observe indicator lamp (1).

If indicator lamp (1) stays on constantly, programming is complete and your device should activate when the respective signal transmitter button (2), (3) or (4) is pressed and released.

i If indicator lamp (1) flashes rapidly for about 2 seconds and then turns to a constant light, continue with programming steps 8 through 12 as your garage door opener may be equipped with the “rolling code” feature.

Step 7:

- ▶ To program the remaining two signal transmitter buttons, repeat the steps above starting with step 3.

Useful features

Rolling code programming

To train a garage door opener (or other rolling code devices) with the rolling code feature, follow these instructions after completing the “Programming” portion (steps 1 through 6) of this text. (A second person may make the following training procedures quicker and easier.)

Step 8:

- ▶ Locate “training” button on the garage door opener motor head unit.

Exact location and color of the button may vary by garage door opener brand. Depending on manufacturer, the “training” button may also be referred to as “learn” or “smart” button. If there is difficulty locating the transmitting button, refer to the garage door opener operator’s manual.

Step 9:

- ▶ Press the “training” button on the garage door opener motor head unit.

The “training light” is activated.

You have 30 seconds to initiate the following two steps.

Step 10:

- ▶ Return to the vehicle and firmly press, hold for 2 seconds and release the programmed signal transmitter button (②, ③ or ④).

Step 11:

- ▶ Press, hold for 2 seconds and release same signal transmitter button a second time to complete the training process.

i *Some garage door openers (or other rolling code equipped devices) may require you to press, hold for 2 seconds and release the same signal transmitter button a third time to complete the training process.*

Step 12:

- ▶ Confirm the garage door operation by pressing the programmed signal transmitter button (②, ③ or ④).

Step 13:

- ▶ To program the remaining two signal transmitter buttons, repeat the steps above starting with step 3.

Gate operator/Canadian programming

Canadian radio-frequency laws require transmitter signals to “time-out” (or quit) after several seconds of transmission which may not be long enough for the integrated signal transmitter to pick up the signal during programming. Similar to this Canadian law, some U.S. gate operators are designed to “time-out” in the same manner.

If you live in Canada or if you are having difficulties programming a gate operator (regardless of where you live) by using the programming procedures, replace step 4 with the following:

Step 4:

- ▶ Press and hold the signal transmitter button (②, ③ or ④). Do not release this button until it has been successfully trained.
- ▶ While still holding down the signal transmitter button (②, ③ or ④), “cycle” your hand-held remote control button ⑥ as follows: Press and hold button ⑥ for 2 seconds, then release it for 2 seconds, and again press and hold it for 2 seconds. Repeat this sequence on the hand-held remote control until the frequency signal has been learned. Upon successful training, indicator lamp ① will flash slowly and then rapidly after several seconds.
- ▶ Proceed with programming step 5 and step 6 to complete.

i Upon completion of programming the integrated remote control, make sure you retain the hand-held remote control that came with the garage door opener, gate operator or other device. You may need it for use in other vehicles, for future programming of an integrated remote control, or simply for continued use as a hand-held remote control to operate the respective device in other situations.

Reprogramming a single signal transmitter button

To program a device using a signal transmitter button previously trained, follow these steps:

- ▶ Switch on the ignition (▷ page 38).
- ▶ Press and hold the desired signal transmitter button (②, ③ or ④). Do not release the button.
- ▶ Indicator lamp ① will begin to flash after 20 seconds. Without releasing the signal transmitter button, proceed with programming starting with step 3.

Operation of integrated remote control

- ▶ Switch on the ignition (▷ page 38).
- ▶ Select and press the appropriate integrated signal transmitter button (②, ③ or ④) to activate the remote controlled device.

The integrated remote control transmitter continues to send the signal as long as the button is pressed – up to 20 seconds.

Erasing integrated remote control memory

- ▶ Switch on the ignition (▷ page 38).
- ▶ Simultaneously press and hold outer signal transmitter buttons ② and ④, for approximately 20 seconds, until indicator lamp ① flashes rapidly. Do not hold for longer than 30 seconds.

The codes of all three channels are erased.

i If you sell your vehicle, erase the codes of all three channels.

Useful features

Programming tips

If you are having difficulty programming the integrated remote control, here are some helpful tips:

- Check the frequency of hand-held remote control ⑤ (typically located on the reverse side of the remote). The integrated remote control is compatible with radio-frequency devices operating between 280-390 MHz.
- Put a new battery in hand-held remote control ⑤. This will increase the likelihood of the hand-held remote control sending a faster and more accurate signal to the integrated remote control.
- While performing step 3, hold hand-held remote control ⑤ at different lengths and angles from the signal transmitter button (②, ③ or ④) you are programming. Attempt varying angles at the distance of 2 to 5 in (5 to 12 cm) away or the same angle at varying distances.

- If another hand-held remote control is available for the same device, try the programming steps again using that other hand-held remote control. Make sure new batteries are in the hand-held remote control before beginning the procedure.
- Straighten the antenna wire from the garage door opener assembly. This may help improve transmitting and/or receiving signals.

i Certain types of garage door openers are incompatible with the integrated remote control. If you should experience further difficulties with programming the integrated remote control, contact an authorized Mercedes-Benz Center, or call Mercedes-Benz Customer Assistance Center (in the USA only) at 1-800-FOR-MERcedes, or Customer Service (in Canada) at 1-800-387-0100.

i USA only:

This device complies with Part 15 of the FCC Rules. Operation is subject to the following two conditions:

- (1) *This device may not cause harmful interference, and*
- (2) *this device must accept any interference received, including interference that may cause undesired operation.*

Any unauthorized modification to this device could void the user's authority to operate the equipment.

i Canada only:

This device complies with RSS-210 of Industry Canada. Operation is subject to the following two conditions:

- (1) *This device may not cause interference, and*
- (2) *this device must accept any interference received, including interference that may cause undesired operation of the device.*

Any unauthorized modification to this device could void the user's authority to operate the equipment.

The first 1000 miles (1500 km)

Driving instructions

At the gas station

Engine compartment

Tires and wheels

Winter driving

Maintenance

Vehicle care



The first 1 000 miles (1 500 km)

In the “Operation” section you will find detailed information on operating, maintaining and caring for your vehicle.

The more cautiously you treat your vehicle during the break-in period, the more satisfied you will be with its performance later on.

- Drive your vehicle during the first 1 000 miles (1 500 km) at varying but moderate vehicle and engine speeds.
- During this period, avoid heavy loads (full throttle driving) and excessive engine speeds (no more than $\frac{2}{3}$ of maximum rpm in each gear).
- Avoid accelerating by kickdown.
- Do not attempt to slow the vehicle down by shifting to a lower gear using the gear selector lever.
- Select positions **3**, **2** or **1** only when driving at moderate speeds (for hill driving).
- Select **C** as the preferred shift program (▷ page 177) for the first 1 000 miles (1 500 km).

After 1 000 miles (1 500 km) you may gradually increase vehicle and engine speeds to the permissible maximum.

! *Additional instructions for AMG vehicles:*

- *During the first 1 000 miles (1 500 km), do not exceed a speed of 85 mph (140 km/h).*
- *During this period, avoid engine speeds above 4500 rpm in each gear.*

All of the above instructions, as may apply to your vehicle type, also apply when driving the first 1 000 miles (1 500 km) after the engine or the rear differential has been replaced.

i *Always obey applicable speed limits.*

▼ Driving instructions

Drive sensibly – save fuel

Fuel consumption, to a great extent, depends on driving habits and operating conditions.

To save fuel you should:

- Keep tires at the recommended inflation pressures.
- Remove unnecessary loads.
- Remove roof rack when not in use.
- Allow engine to warm up under low load use.
- Avoid frequent acceleration and deceleration.
- Have all maintenance work performed at the intervals specified in the Maintenance Booklet and as required by the Maintenance System. Contact an authorized Mercedes-Benz Center.

Fuel consumption is also increased by driving in cold weather, in stop-and-go traffic, on short trips and in hilly area.

Drinking and driving

Warning!



Drinking and driving and/or taking drugs and driving are very dangerous combinations. Even a small amount of alcohol or drugs can affect your reflexes, perceptions and judgment.

The possibility of a serious or even fatal accident are greatly increased when you drink or take drugs and drive.

Do not drink or take drugs and drive or allow anyone to drive who has been drinking or taking drugs.

Pedals

Warning!



Make sure that absolutely no objects are obstructing the pedals range of movement. Keep the driver's footwell clear of all obstacles. If there are any floor mats or carpets in the footwell, make sure that the pedals still have sufficient clearance.

Driving instructions

Power assistance

Warning!



With the engine not running, there is no power assistance for the brake and steering systems. In this case, it is important to keep in mind that a considerably higher degree of effort is necessary to brake and steer the vehicle.

Brakes

Warning!



After driving in heavy rain for some time without applying the brakes or through water deep enough to wet brake components, the first braking action may be somewhat reduced and increased pedal pressure may be necessary to obtain expected braking effect. Maintain a safe distance from vehicles in front.

Resting your foot on the brake pedal will cause excessive and premature wear of the brake pads.

It can also result in the brakes overheating, thereby significantly reducing their effectiveness. It may not be possible to stop the vehicle in sufficient time to avoid an accident.

! Because the ESP® operates automatically, the engine and ignition must be shut off (SmartKey in starter switch position **0** or **1** or KEYLESS-GO* start/stop button in position **0** or **1**) when testing the brakes on a brake test dynamometer and such testing should be no longer than 10 seconds.

Active braking action through ESP® may otherwise seriously damage the brake system which is not covered by the Mercedes-Benz Limited Warranty.

To help prevent brake disk corrosion after driving on wet road surfaces (particularly salted roads), it is advisable to brake the vehicle with considerable force prior to parking. The heat generated serves to dry the brakes.

If your brake system is normally only subjected to moderate loads, you should occasionally test the effectiveness of the brakes by applying above-normal braking pressure at higher speeds. This will also enhance the grip of the brake pads.

Warning!

Make sure not to endanger any other road users when carrying out these braking maneuvers.

Refer to the description of the Brake Assist System (BAS) (▷ page 92).

Brake pad wear or a leak in the system may be the reason for low brake fluid in the reservoir.

The brake fluid level in the reservoir may be too low if the brake warning lamp in the instrument cluster comes on and an acoustic warning sounds although the parking brake is released (▷ page 344). Observe additional messages in the multi-function display that may appear (▷ page 372).

Have the brake system inspected immediately. Contact an authorized Mercedes-Benz Center.

All checks and service work on the brake system should be carried out by qualified technicians only. Contact an authorized Mercedes-Benz Center.

Only install brake pads and brake fluid recommended by Mercedes-Benz.

Warning!

If other than recommended brake pads are installed, or other than recommended brake fluid is used, the braking properties of the vehicle can be degraded to an extent that safe braking is substantially impaired. This could result in an accident.

Be certain to read and observe the warning notices on brake pad replacement (▷ page 371).

! *When driving down long and steep grades, relieve the load on the brakes by shifting into a lower gear to use the engine's braking power. This helps prevent overheating of the brakes and reduces brake pad wear.*

After hard braking, it is advisable to drive on for some time, rather than immediately park, so that the air stream will cool down the brakes faster.

Driving instructions

High-performance brake system (CLS 63 AMG only)

The high-performance brake system is designed to operate under the extremely high operating demands required to accommodate the performance capabilities of the vehicle. The brakes may produce a squeaking-type noise depending on the

- vehicle speed
- brake force applied
- ambient conditions, e.g. temperature and humidity

As with any brake system, the wear of individual brake system components such as brake pads or disks strongly depends on your driving style and the conditions under which you operate the vehicle. Thus, a driving style calling for high demand braking will cause your vehicle's brakes to wear more quickly.

Warning!



New vehicle brake pads and discs, and replacement brake pads and discs may take several hundred miles of driving until they provide optimum braking efficiency. Until that time, you may need to use increased brake pedal pressure while braking. Please be aware of this and adjust your driving and braking accordingly during this break-in period.

Excessive high demand braking will cause correspondingly high brake wear. Please be attentive to the brake warning lamp in the instrument cluster and brake condition messages in the multifunction display. Especially for high performance driving, it is important to maintain and have the brake system checked regularly.

Driving off

Apply the brakes to test them briefly after driving off. Perform this procedure only when the road is clear of other traffic.

Warm up the engine smoothly. Do not place full load on the engine until the operating temperature has been reached.

When starting off on a slippery surface, do not allow a drive wheel to spin for an extended period with the ESP® switched off. Doing so may cause serious damage to the drive train which is not covered by the Mercedes-Benz Limited Warranty.

! *When driving off on a slippery surface, do not allow a drive wheel to spin for an extended period with the ESP® switched off. Doing so may cause serious damage to the drivetrain which is not covered by the Mercedes-Benz Limited Warranty.*

! *Simultaneously depressing the accelerator pedal and applying the brake reduces engine performance and causes premature brake and drivetrain wear.*

Parking

Warning!



Do not park this vehicle in areas where combustible materials such as grass, hay or leaves can come into contact with the hot exhaust system, as these materials could be ignited and cause a vehicle fire.

To reduce the risk of personal injury, or damage to the vehicle drivetrain, as a result of vehicle movement, before turning off the engine and leaving the vehicle always:

- Keep right foot on brake pedal.
- Firmly depress parking brake pedal.
- Move the gear selector lever to position **P**.
- Slowly release brake pedal.

- Slowly release brake pedal.
- When parked on an incline, turn front wheel towards the road curb.
- Turn the SmartKey in the starter switch to position **0** and remove the SmartKey from the starter switch, or press KEYLESS-GO* start/stop button (vehicles with KEYLESS-GO*).
- Take the SmartKey or the SmartKey with KEYLESS-GO* with you and lock vehicle when leaving.

Tires

Warning!



If you feel a sudden significant vibration or ride disturbance, or you suspect that possible damage to your vehicle has occurred, you should turn on the hazard warning flashers, carefully slow down, and drive with caution to an area which is a safe distance from the road.

Inspect the tires and the vehicle underbody for possible damage. If the vehicle or tires appear unsafe, have the vehicle towed to the nearest Mercedes-Benz Center or tire dealer for repairs.

Treadwear indicators (TWI) are required by law. These indicators are located in six places on the tread circumference and become visible at a tread depth of approximately $\frac{1}{16}$ in (1.6 mm), at which point the tire is considered worn and should be replaced.

The treadwear indicator appears as a solid band across the tread.

Driving instructions

Warning!



Although the applicable federal motor vehicle safety laws consider a tire to be worn when the treadwear indicators (TWI) become visible at approximately $\frac{1}{16}$ in (1.6 mm), we recommend that you do not allow your tires to wear down to that level. As tread depth approaches $\frac{1}{8}$ in (3 mm), the adhesion properties on a wet road are sharply reduced.

Depending upon the weather and/or road surface (conditions), the tire traction varies widely.

Specified tire inflation pressures must be maintained. This applies particularly if the tires are subjected to high loads (e.g. high speeds, heavy loads, high ambient temperatures).

Warning!



Do not drive with a flat tire. A flat tire affects the ability to steer or brake the vehicle. You may lose control of the vehicle. Continued driving with a flat tire or driving at high speed with a flat tire will cause excessive heat build-up and possibly a fire.

For more information, see “Tires and wheels” (▷ page 293).

Hydroplaning

Depending on the depth of the water layer on the road, hydroplaning may occur, even at low speeds and with new tires. Reduce vehicle speed, avoid track grooves in the road and apply brakes cautiously in the rain.

Tire traction

The safe speed on a wet, snow covered or icy road is always lower than on a dry road.

You should pay particular attention to the condition of the road whenever the outside temperatures are close to the freezing point.

Warning!



If ice has formed on the road, tire traction will be substantially reduced. Under such weather conditions, drive, steer and brake with extreme caution.

Mercedes-Benz recommends winter tires (▷ page 327) with a minimum tread depth of approximately $\frac{1}{6}$ in (4 mm) on all four wheels for the winter season to make sure normal balanced handling characteristics. On packed snow, they can reduce your stopping distance compared to summer tires. Stopping distance, however, is still considerably greater than when the road is not covered with snow or ice. Exercise appropriate caution.

! *Avoid spinning of a drive wheel. This may cause serious damage to the drivetrain which is not covered by the Mercedes-Benz Limited Warranty.*

Tire speed rating

Regardless of the tire speed rating, local speed limits should be obeyed. Use prudent driving speeds appropriate to prevailing conditions.

Warning!



Even when permitted by law, never operate a vehicle at speeds greater than the maximum speed rating of the tires.

Exceeding the maximum speed for which tires are rated can lead to sudden tire failure, causing loss of vehicle control and possibly resulting in an accident and/or personal injury and possible death, for you and for others.

An electronic speed limiter prevents your vehicle from exceeding a speed of:

- CLS 550
CLS 550 (Sport Package*):
130 mph (210 km/h)
- CLS 63 AMG:
155 mph (250 km/h)
- CLS 63 AMG (Performance Package*):
186 mph (300 km/h)

The factory equipped tires on your vehicle may have a tire speed rating above the maximum speed permitted by the electronic speed limiter.

Make sure your tires have the required tire speed rating as specified for your vehicle in the “Technical data” section (▷ page 438), for example when purchasing new tires.

Driving instructions

For information on how to identify the tire speed rating on a tire's sidewall, see "Tire size designation, load and speed rating" (▷ page 314).

If you are uncertain about the correct reading of the information given on a tire's sidewall, any authorized Mercedes-Benz Center will be glad to assist you.

i For information on speed rating for winter tires, see "Winter driving" (▷ page 327).

For additional general information on tire speed markings on tire sidewall, see "Tire speed rating" (▷ page 316).

Winter driving instructions

The most important rule for slippery or icy roads is to drive sensibly and to avoid abrupt acceleration, braking and steering maneuvers. Do not use the cruise control system under such conditions.

When the vehicle is in danger of skidding, move gear selector lever to position **N**. Try to keep the vehicle under control by corrective steering action.

i For more information on driving with snow chains, see "Snow chains" (▷ page 328).

Warning!



On slippery road surfaces, never downshift in order to obtain braking action. This could result in drive wheel slip and reduced vehicle control. Your vehicle's ABS will not prevent this type of control loss.

Road salts and chemicals can adversely affect braking efficiency. Increased pedal force may become necessary to produce the normal braking effect.

Depressing the brake pedal periodically when traveling at length on salt-strewn roads can bring road-salt-impaired braking efficiency back to normal.

If the vehicle is parked after being driven on salt-treated roads, the braking efficiency should be tested as soon as possible after driving is resumed.

Warning!

Make sure not to endanger any other road users when carrying out these braking maneuvers.

Warning!

If the vehicle becomes stuck in snow, make sure that snow is kept clear of the exhaust pipe and from around the vehicle with the engine running. Otherwise, deadly carbon monoxide (CO) gases may enter vehicle interior resulting in unconsciousness and possible death.

To assure sufficient fresh air ventilation, open a window slightly on the side of the vehicle not facing the wind.

Warning!

The outside temperature indicator is not designed to serve as an ice-warning device and is therefore unsuitable for that purpose. Indicated temperatures just above the freezing point do not guarantee that the road surface is free of ice.

For more information, see “Winter driving” (▷ page 327).

Standing water

! Do not drive through flooded areas or water of unknown depth. Before driving through water, determine its depth. Never accelerate before driving into water. The bow wave could force water into the engine and auxiliary equipment, thus damaging them.

If you must drive through standing water, drive slowly to prevent water from entering the passenger compartment or the engine compartment. Water in these areas could cause damage to electrical components or wiring of the engine or transmission, or could result in water being ingested by the engine through the air intake causing severe internal engine damage. Any such damage is not covered by the Mercedes-Benz Limited Warranty.

Driving instructions

Passenger compartment

Warning!



Always fasten items being carried as securely as possible.

In an accident, during hard braking or sudden maneuvers, loose items will be thrown around inside the vehicle, and cause injury to vehicle occupants unless the items are securely fastened in the vehicle.

The trunk is the preferred place to carry objects.

Driving abroad

Abroad, there is an extensive Mercedes-Benz service network at your disposal. If you plan to drive into areas which are not listed in the index of your Mercedes-Benz Center directory, you should request pertinent information from your authorized Mercedes-Benz Center.

Control and operation of radio transmitter

COMAND, radio and telephone*

Warning!



Please do not forget that your primary responsibility is to drive the vehicle safely. Only operate the COMAND (Cockpit Management and Data System), radio or telephone¹ if road, weather and traffic conditions permit.

Bear in mind that at a speed of just 30 mph (approximately 50 km/h), your vehicle is covering a distance of 44 feet (approximately 14 m) every second.

¹ Observe all legal requirements.

Telephones and two-way radios

Warning!



Never operate radio transmitters equipped with a built-in or attached antenna (i.e. without being connected to an external antenna) from inside the vehicle while the engine is running. Doing so could lead to a malfunction of the vehicle's electronic system, possibly resulting in an accident and/or personal injury.

Radio transmitters, such as a portable telephone or a citizens band unit should only be used inside the vehicle if they are connected to an antenna that is installed on the outside of the vehicle.

Refer to the radio transmitter operation instructions regarding use of an external antenna.

Catalytic converter

Your Mercedes-Benz is equipped with monolithic-type catalytic converters, an important element in conjunction with the oxygen sensors to achieve substantial control of the pollutants in the exhaust emissions. Keep your vehicle in proper operating condition by following our recommended maintenance instructions as outlined in your Maintenance Booklet.

! *To prevent damage to the catalytic converters, only use premium unleaded gasoline in this vehicle.*

Any noticeable irregularities in engine operation should be repaired promptly. Otherwise, excessive unburned fuel may reach the catalytic converter, causing it to overheat, which could potentially start a fire.

Warning!



As with any vehicle, do not idle, park or operate this vehicle in areas where combustible materials such as grass, hay or leaves can come into contact with the hot exhaust system, as these materials could be ignited and cause a vehicle fire.

Emission control

Certain parts of the engine and the emission control system serve to keep the toxic components of the exhaust gases within permissible limits required by law.

These systems will function properly only when maintained strictly according to factory specifications. Any adjustments on the engine should, therefore, be carried out only by qualified Mercedes-Benz Center authorized technicians.

Engine adjustments should not be altered in any way. Moreover, the specified service procedures must be carried out regularly according to Mercedes-Benz servicing requirements. For details refer to the Maintenance Booklet.

Warning!



Inhalation of exhaust gas is hazardous to your health. All exhaust gas contains carbon monoxide (CO), and inhaling it can cause unconsciousness and possible death.

Do not run the engine in confined areas (such as a garage) which are not properly ventilated. If you think that exhaust gas fumes are entering the vehicle while driving, have the cause determined and corrected immediately. If you must drive under these conditions, drive only with at least one window fully open at all times.

Driving instructions

Coolant temperature

During severe operating conditions and stop-and-go city traffic, the coolant temperature may rise close to approximately 248°F (120°C).

The engine should not be operated with the coolant temperature over 248°F (120°C). Doing so may cause serious engine damage which is not covered by the Mercedes-Benz Limited Warranty.

Warning!



- Driving when your engine is badly overheated can cause some fluids, which may have leaked into the engine compartment, to catch fire. You could be seriously burned.
- Steam from an overheated engine can cause serious burns and can occur just by opening the engine hood. Stay away from the engine if you see or hear steam coming from it.

Turn off the engine, get out of the vehicle and do not stand near the vehicle until the engine has cooled down.

▼ At the gas station

Refueling

Warning!

Gasoline is highly flammable and poisonous. It burns violently and can cause serious personal injury.

Never allow sparks, flame or smoking materials near gasoline!

Turn off the engine before refueling.

Whenever you are around gasoline, avoid inhaling fumes and skin or clothing contact, extinguish all smoking materials.

Direct skin contact with fuels and the inhalation of fuel vapors can damage your health.

! *Damage resulting from the use of non approved fuels or fuel additives or resulting from mixing gasoline with diesel fuel is not covered by the Mercedes-Benz Limited Warranty.*

The fuel filler flap is located on the right-hand side of the vehicle towards the rear. Locking/unlocking the vehicle with the remote control automatically locks/unlocks the fuel filler flap.

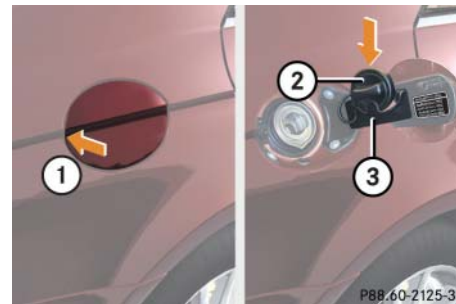

- ① Fuel filler flap
- ② Fuel filler cap
- ③ Holder

▶ Turn the engine off

- by turning the SmartKey to position **0**.
- by pressing the KEYLESS-GO* start/stop button. Open the driver's door (with the driver's door open, starter switch is now in position **0**, same as SmartKey removed from starter switch).



At the gas station

- ▷▷ Open fuel filler flap ① by pushing at the point indicated by the arrow.

The fuel filler flap springs open.

- ▶ Turn fuel cap ② counterclockwise and hold on to it until possible pressure is released.
- ▶ Take off fuel cap ② and place it into holder ③ located on the inside of the fuel filler flap.

To prevent fuel vapors from escaping into open air, fully insert filler nozzle unit.

- ▶ Only fill your tank until the filler nozzle unit cuts out – **do not top off or over-fill**.

Warning!





Overfilling of the fuel tank may create pressure in the system which could cause a gasoline fuel discharge. This could cause the gasoline fuel to spray back out when removing the fuel pump nozzle, which could cause personal injury.

- ▶ Replace fuel cap by turning it clockwise until it audibly engages.

i Make sure to close the fuel filler flap before locking your vehicle as the flap locking pin prevents closing after you have locked the vehicle.

- ▶ Close the fuel filler flap.

i Leaving the engine running and the fuel cap open can cause the yellow fuel tank reserve warning lamp to flash and the malfunction indicator lamp  (USA only) or the malfunction indicator lamp  (Canada only) to illuminate.

See also “Practical hints” section (▷ page 345).

i Only use premium unleaded gasoline with a minimum Posted Octane Rating of 91 (average of 96 RON/86 MON). Information on gasoline quality can normally be found on the fuel pump.

For more information on gasoline, see the Factory Approved Service Products pamphlet.

Check regularly and before a long trip

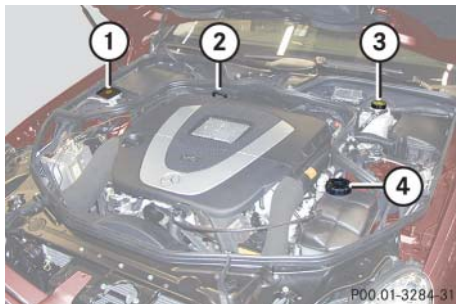

- ① Windshield washer and headlamp cleaning system*
For more information on refilling the reservoir, see “Windshield washer system and headlamp cleaning system*” (▷ page 292).
- ② Engine oil level
For more information on engine oil level, see “Engine oil” (▷ page 287).
- ③ Brake fluid
For more information on brake fluid, see “Brake fluid” (▷ page 451).
- ④ Coolant level
For more information on the coolant level, see “Coolant level” (▷ page 290).

! If you find that the brake fluid in the brake fluid reservoir has fallen to the minimum mark or below, have the brake system checked for brake pad thickness and leaks immediately. Notify an authorized Mercedes-Benz Center immediately. Do not add brake fluid as this will not solve the problem. For more information, see “Practical hints” (▷ page 344).

Vehicle lighting

Check function and cleanliness. For more information on replacing light bulbs, see the “Practical hints” section (▷ page 404).

For more information, see “Exterior lamp switch” (▷ page 128).

Tire inflation pressure

For more information, see “Checking tire inflation pressure” (▷ page 302).

Engine compartment

Hood

Warning!



Do not pull the release lever while the vehicle is in motion. Otherwise the hood could be forced open by passing air flow.

This could cause the hood to come loose and injure you and/or others.

Opening

Warning!



If you see flames or smoke coming from the engine compartment, or if the coolant temperature gauge indicates that the engine is overheated, do not open the hood. Move away from vehicle and do not open the hood until the engine has cooled. If necessary, call the fire department.

Warning!



You could be injured when the hood is open – even when the engine is turned off.

Parts of the engine can become very hot. To prevent burns, let the engine cool off completely before touching any components on the vehicle. Comply with all relevant safety precautions.

Warning!



To help prevent personal injury, stay clear of moving parts when the hood is open and the engine is running.

The radiator fan may continue to run for approximately 30 seconds or even restart after the engine has been turned off. Stay clear of fan blades.

Warning!



The engine is equipped with a transistorized ignition system. Because of the high voltage it is dangerous to touch any components (ignition coils, spark plug sockets, diagnostic socket) of the ignition system

- with the engine running
- while starting the engine
- if ignition is “on” and the engine is turned manually



① Release lever

- ▶ Pull release lever ①.

The hood is unlocked.

! To avoid damage to the windshield wipers or hood, never open the hood if the wiper arms are folded forward away from the windshield.



- ① Lever for opening the hood
- ▶ Push lever ① on the hood upwards.
- ▶ Pull up on the hood and then release it.

The hood will be automatically held open at shoulder height by gas-filled struts.

Closing

Warning!



When closing the hood, use extreme caution not to catch hands or fingers. Be careful that you do not close the hood on anyone.

Make sure that the hood is securely engaged before driving off. Do not continue driving if the hood can no longer engage after an accident, for example. The hood could otherwise come loose while the vehicle is in motion and endanger you and/or others.

- ▶ Let the hood drop from a height of approximately 1 ft (30 cm).
The hood will lock audibly.
- ▶ Check to make sure the hood is fully closed.

If you can raise the hood at a point above the headlamps, then it is not properly closed. Open it again and let it drop with somewhat greater force.

Engine oil

The amount of oil your engine needs will depend on a number of factors, including driving style. Higher oil consumption can occur when

- the vehicle is new
- the vehicle is driven frequently at higher engine speeds

Engine oil consumption checks should only be made after the vehicle break-in period.

i Do not use any special lubricant additives, as these may damage the drive assemblies. Using special additives not approved by Mercedes-Benz may cause damage not covered by the Mercedes-Benz Limited Warranty. More information on this subject is available at any Mercedes-Benz Center.

Engine compartment

Checking engine oil level

When checking the oil level

- the vehicle must be parked on level ground
- with the engine at operating temperature, the vehicle must have been stationary for at least 5 minutes with the engine turned off
- with the engine not at operating temperature yet, the vehicle must have been stationary for at least 5 minutes with the engine turned off

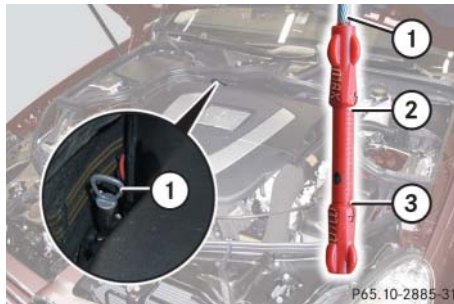

- ① Oil dipstick
- ② Upper (max) mark
- ③ Lower (min) mark

To check the engine oil level with the oil dipstick, do the following:

- ▶ Open the hood (▷ page 286).
- ▶ Pull out oil dipstick ①.
- ▶ Wipe oil dipstick ① clean.
- ▶ Fully insert oil dipstick ① into the dipstick guide tube.

- ▶ Pull out oil dipstick ① again after approximately 3 seconds to obtain accurate reading.

The oil level is correct when it is between the lower (min) mark ③ and upper (max) mark ② of oil dipstick ①.

i *CLS 550 only:*

The filling quantity between the upper and lower marks on the oil dipstick is approximately 2.1 US qt. (2.0 l).

i *CLS 63 AMG only:*

The filling quantity between the upper and lower marks on the oil dipstick is approximately 1.6 US qt. (1.5 l).

- ▶ If necessary, add engine oil.

For adding engine oil, see “Adding engine oil” (▷ page 289).

For more information on engine oil, see “Fuels, coolants, lubricants etc.” (▷ page 449).

For more information on messages in the multifunction display concerning engine oil, see the “Practical hints” section (▷ page 377).

Adding engine oil

! Only use approved engine oils and oil filters required for vehicles with Maintenance System (U.S. vehicles) or FSS PLUS (Canada vehicles). For a listing of approved engine oils and oil filters, refer to the Factory Approved Service Products pamphlet (USA only) in your vehicle literature portfolio, or contact an authorized Mercedes-Benz Center.

Using engine oils and oil filters of specification other than those expressly required for the Maintenance System (U.S. vehicles) or FSS PLUS (Canada vehicles), or changing of oil and oil filter at change intervals longer than those called for by the Maintenance System (U.S. vehicles) or FSS PLUS (Canada vehicles) will result in engine or emission control system damage not covered by the Mercedes-Benz Limited Warranty.



CLS 550



CLS 63 AMG

- ▶ Unscrew filler cap ① from filler neck.
- ▶ Add engine oil as required. Be careful not to overfill with oil.

Be careful not to spill any oil when adding. Avoid environmental damage caused by oil entering the ground or water.

! Excess oil must be siphoned or drained off. It could cause damage to the engine and emission control system not covered by the Mercedes-Benz Limited Warranty.

- ▶ Screw filler cap ① back on filler neck.

For more information on engine oil, see the “Technical data” section (▷ page 449) and (▷ page 451).

Transmission fluid level

The transmission fluid level does not need to be checked. If you notice transmission fluid loss or gear shifting malfunctions, have an authorized Mercedes-Benz Center check the transmission.

Engine compartment

Coolant level

The engine coolant is a mixture of water and anticorrosion/antifreeze. To check the coolant level, the vehicle must be parked on level ground and the engine must be cool.

Warning!



In order to avoid potentially serious burns:

- Use extreme caution when opening the hood if there are any signs of steam or coolant leaking from the cooling system, or if the coolant temperature gauge indicates that the coolant is overheated.
- Do not remove pressure cap on coolant reservoir if coolant temperature is above 158°F (70°C). Allow engine to cool down before removing cap. The coolant reservoir contains hot fluid and is under pressure.

- Using a rag, slowly open the cap approximately $1/2$ turn to relieve excess pressure. If opened immediately, scalding hot fluid and steam will be blown out under pressure.
- Do not spill antifreeze on hot engine parts. Antifreeze contains ethylene glycol which may burn if it comes into contact with hot engine parts.

The coolant expansion tank is located on the driver's side of the engine compartment.

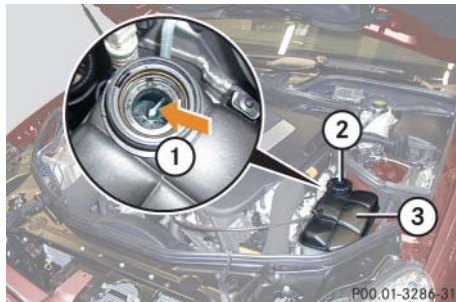

- ① Marking bar in the expansion tank
- ② Cap
- ③ Coolant expansion tank

- ▶ Using a rag, turn cap ② slowly approximately one half turn counterclockwise to release any excess pressure.
- ▶ Continue turning the cap ② counterclockwise and remove it.

The coolant level is correct if the level:

- for cold coolant: reaches marking bar ① in the expansion tank ③
 - for warm coolant: is approximately 0.6 in (1.5 cm) higher
- ▶ Add coolant as required.
 - ▶ Replace and tighten cap ②.

For more information on coolant, see the “Technical data” section (▶ page 453).

Battery

Your vehicle's battery is located in the trunk on the right hand side (▷ page 420):

The battery should always be sufficiently charged in order to achieve their rated service life. Refer to Maintenance Booklet for battery maintenance intervals.

If you use your vehicle mostly for short-distance trips, you will need to have the battery charge checked more frequently.

When replacing the battery, always use batteries approved by Mercedes-Benz.

If you do not intend to operate your vehicle for an extended period of time, consult an authorized Mercedes-Benz Center about steps you need to observe.

Warning!



Observe all safety instructions and precautions when handling automotive batteries.



Risk of explosion.



Fire, open flames and smoking are prohibited when handling batteries. Avoid creating sparks.



Battery acid is caustic. Do not allow it to come into contact with skin, eyes or clothing.

Wear suitable protective clothing, especially gloves, apron and faceguard.



Wear eye protection.

Rinse any acid spills immediately with clear water. Contact a physician if necessary.



Keep children away.



Follow the instructions in this Operator's Manual.

Batteries contain materials that can harm the environment if disposed of improperly. Recycling of batteries is the preferred method of disposal. Many states require sellers of batteries to accept old batteries for recycling.

Engine compartment

Windshield washer system and headlamp cleaning system*

The windshield washer reservoir is located in the engine compartment.

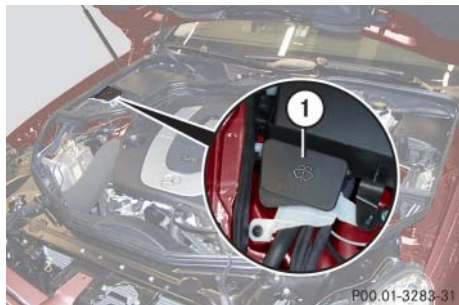

① Cap for windshield washer reservoir

Fluid for the windshield washer system and the headlamp cleaning system is supplied from the windshield washer reservoir. It has a capacity of approximately 6.9 US qt (6.5 l).

During all seasons, add MB Windshield Washer Concentrate “MB SummerFit” to water. Premix the windshield washer fluid in a suitable container.

Warning!



Washer solvent/antifreeze is highly flammable. Do not spill washer solvent/antifreeze on hot engine parts, because it may ignite and burn. You could be seriously burned.

- ▶ Use the tab to pull cap ① upwards.
- ▶ Refill the reservoir with MB Windshield Washer Concentrate “MB SummerFit” and water (or commercially available premixed windshield washer solvent/antifreeze, depending on ambient temperatures).

! Always use washer solvent/antifreeze where temperatures may fall below freezing point. Failure to do so could result in damage to the washer system/reservoir.

! Only use washer fluid which is suitable for plastic lenses. Improper washer fluid can damage the plastic lenses of the headlamps.

For more information, see “Windshield and headlamp washer fluid mixing ratio” (▷ page 456).

▼ Tires and wheels

See an authorized Mercedes-Benz Center for information on tested and recommended rims and tires for summer and winter operation. They can also offer advice concerning tire service and purchase.

Warning!



Replace rims or tires with the same designation, manufacturer and type as shown on the original part. See an authorized Mercedes-Benz Center for further information. If incorrectly sized rims and tires are mounted:

- The wheel brakes or suspension components can be damaged.
- The correct operating clearance of the wheels and the tires are no longer guaranteed.

Warning!



Worn, old tires can cause accidents. If the tire tread is badly worn, or if the tires have sustained damage, replace them.

When replacing rims, only use genuine Mercedes-Benz wheel bolts specified for the particular rim type. Failure to do so can result in the bolts loosening and possibly an accident.

Retreaded tires are not tested or recommended by Mercedes-Benz, since previous damage cannot always be recognized on retreads. The operating safety of the vehicle cannot be assured when such tires are used.

Important guidelines

- Only use sets of tires and rims of the same type and make.
- Tires must be of the correct size for the rim.
- Break in new tires for approximately 60 miles (100 km) at moderate speeds.
- Regularly check the tires and rims for damage. Dented or bent rims can cause tire inflation pressure loss and damage to the tire beads.
- If vehicle is heavily loaded, check tire inflation pressure and correct as required.
- Do not allow your tires to wear down too far. Adhesion properties on wet roads are sharply reduced at tread depths of less than $1/8$ in (3 mm).
- The wheels on the front and rear axles are different. For this reason, pay attention to the markings on the inside of the wheel rims. Wheels marked “REAR AXLE ONLY” on the inside of the rim may only be fitted on the rear axle.
- When replacing individual tires, you should mount new tires on the front wheels first (on vehicles with same-sized wheels all around).

Tires and wheels

Tire care and maintenance

Warning!



Regularly check the tires for damage. Damaged tires can cause tire inflation pressure loss. As a result, you could lose control of your vehicle.

Worn, old tires can cause accidents. If the tire tread is badly worn, or if the tires have sustained damage, replace them.

Regularly check your tire inflation pressure at least once a month. For more information on checking tire inflation pressure see “Recommended tire inflation pressure” (▷ page 301).

Tire inspection

Every time you check your tire inflation pressure, you should also inspect your tires for the following:

- excessive treadwear (▷ page 294)

- cord or fabric showing through the tire’s rubber
- bumps, bulges, cuts, cracks or splits in the tread or side of the tire

Replace the tire if you find any of the above conditions.

Make sure you also inspect the spare tire periodically for condition and inflation. Spare tires will age and become worn over time even if never used, and thus should be inspected and replaced when necessary.

Life of tire

The service life of a tire is dependent upon varying factors including but not limited to:

- Driving style
- Tire inflation pressure
- Distance driven

Warning!



Tires and spare tire should be replaced after 6 years, regardless of the remaining tread.

Tread depth

Do not allow your tires to wear down too far. Adhesion properties on wet roads are sharply reduced at tread depths of less than $\frac{1}{8}$ in (3 mm).

Tread wear indicators (TWI) are required by law. These indicators are located in six places on the tread circumference and become visible at a tread depth of approximately $\frac{1}{16}$ in (1.6 mm), at which point the tire is considered worn and should be replaced.

Recommended minimum tire tread depth:

- Summer tires $\frac{1}{8}$ in (3 mm)
- Winter tires $\frac{1}{6}$ in (4 mm)

Warning!



Although the applicable federal motor safety laws consider a tire to be worn when the treadwear indicators (TWI) become visible at approximately $\frac{1}{16}$ in (1.6 mm), we recommend that you do not allow your tires

to wear down to that level. As tread depth approaches $\frac{1}{8}$ in (3 mm), the adhesion properties on a wet road are sharply reduced.

Depending upon the weather and/or road surface (conditions), the tire traction varies widely.

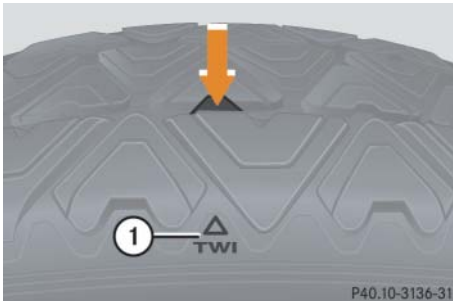

① TWI (Tread Wear Indicator)

The treadwear indicator appears as a solid band across the tread.

Storing tires

! *Keep unmounted tires in a cool, dry place with as little exposure to light as possible. Protect tires from contact with oil, grease and gasoline.*

Cleaning tires

! *Never use a round nozzle to power wash tires. The intense jet of water can result in damage to the tire.*

Always replace a damaged tire.

Direction of rotation

Unidirectional tires offer added advantages, such as better hydroplaning performance. To benefit, however, you must make sure the tires rotate in the direction specified.

An arrow on the sidewall indicates the intended direction of rotation (spinning) of the tire.

i *Spare wheels may be mounted against the direction of rotation (spinning) even with a unidirectional tire for temporary use only until the regular drive wheel has been repaired or replaced. Always observe and follow applicable temporary use restrictions and speed limitations indicated on the spare wheel.*

Tires and wheels

Loading the vehicle

Two labels on your vehicle show how much weight it may properly carry.

- 1) The Tire and Loading Information placard can be found on the driver's door B-pillar. This placard tells you important information about the number of people that can be in the vehicle and the total weight that can be carried in the vehicle. It also contains information on the proper size and recommended tire inflation pressures for the original equipment tires on your vehicle.

- 2) The Certification label, also found on the driver's door B-pillar tells you about the gross weight capacity of your vehicle, called the Gross Vehicle Weight Rating (GVWR). The GVWR includes the weight of the vehicle, all occupants, fuel and cargo. The Certification label also tells you about the front and rear axle weight capacity, called the Gross Axle Weight Rating (GAWR). The GAWR is the total allowable weight that can be carried by a single axle (front or rear). Never exceed the GVWR or GAWR for either the front axle or rear axle.



① Driver's door B-pillar

Following is a discussion on how to work with the information contained on the placard with regards to loading your vehicle.

Tire and Loading Information

Warning!



Do not overload the tires by exceeding the specified total load limit as indicated on the placard on the driver's door B-pillar. Overloading the tires can overheat them, possibly causing a blowout. Overloading the tires can also result in handling or steering problems, or brake failure.

i Data shown on placard example are for illustration purposes only. Load limit data are specific to each vehicle and may vary from data shown in the illustration below. Refer to placard on vehicle for actual data specific to your vehicle.

Tire and Loading Information placard

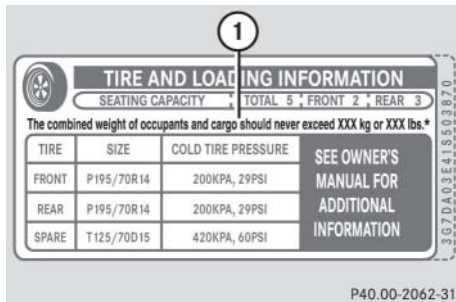

- ① Load limit information on the Tire and Loading Information placard

The placard showing the load limit information is located on the driver’s door B-pillar.

- ▶ Locate the statement “The combined weight of occupants and cargo should never exceed XXX kilograms or XXX lbs.” on this placard.

The combined weight of all occupants, cargo/luggage and trailer tongue load (if applicable) should never exceed the weight referenced in that statement.

Seating capacity

The seating capacity gives you important information on the number of occupants that can be in the vehicle. Observe front and rear seating capacity. The Tire and Loading Information placard showing the seating capacity is located on the driver’s door B-pillar (▷ page 296).

- ① *Data shown on placard example are for illustration purposes only. Load limit data are specific to each vehicle and may vary from data shown in the illustration below. Refer to placard on vehicle for actual data specific to your vehicle.*

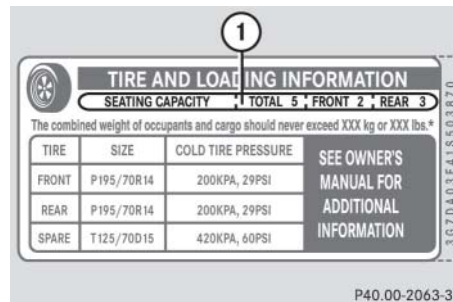

- ① Seating capacity information on the Tire and Loading Information placard

Steps for determining correct load limit

The following steps have been developed as required of all manufacturers under Title 49, Code of U.S. Federal Regulations, Part 575 pursuant to the “National Traffic and Motor Vehicle Safety Act of 1966”.

Step 1

- ▶ Locate the statement “The combined weight of occupants and cargo should never exceed XXX kg or XXX lbs.” on your vehicle’s placard.

Step 2

- ▶ Determine the combined weight of the driver and passengers that will be riding in your vehicle.

Step 3

- ▶ Subtract the combined weight of the driver and passengers from XXX kilograms or XXX lbs.



Tires and wheels

▷▷ Step 4

- ▶ The resulting figure equals the available amount of cargo and luggage load capacity. For example, if the “XXX” amount equals 1400 lbs. and there will be five 150 lbs. passengers in your vehicle, the amount of available cargo and luggage load capacity is 650 lbs. (1400-750 (5 x 150) = 650 lbs.)

Step 5

- ▶ Determine the combined weight of luggage and cargo being loaded on the vehicle. That weight may not safely exceed the available cargo and luggage load capacity calculated in step 4.

Step 6 (if applicable)

- ▶ If your vehicle will be towing a trailer, load from your trailer will be transferred to your vehicle. Consult this manual to determine how this reduces the available cargo and luggage load capacity of your vehicle (▷ page 300).

The following table shows examples on how to calculate total and cargo load capacities with varying seating configurations and number and size of occupants. The following examples use a load limit of 1500 lbs. **This is for illustration purposes only.** Make sure you are using the actual load limit for your vehicle stated on the vehicle’s placard (▷ page 297).

Example	Combined weight limit of occupants and cargo from placard	Number of occupants (driver and passengers)	Seating configuration	Occupants weight	Combined weight of all occupants	Available cargo/luggage and trailer tongue weight (total load limit from placard minus combined weight of all occupants)
1	1500	4	front: 2 rear: 2	Occupant 1: 150 lbs Occupant 2: 180 lbs Occupant 3: 160 lbs Occupant 4: 140 lbs	630 lbs	1500 lbs - 630 lbs = 870 lbs
2	1500	3	front: 1 rear: 2	Occupant 1: 200 lbs Occupant 2: 190 lbs Occupant 3: 150 lbs	540 lbs	1500 lbs - 540 lbs = 960 lbs
3	1500	1	front: 1	Occupant 1: 150 lbs	150 lbs	1500 lbs - 150 lbs = 1350 lbs

The higher the weight of all occupants, the less cargo and luggage load capacity is available.

For more information, see “Trailer tongue load” (> page 300).

Tires and wheels

Certification label

Even after careful determination of the combined weight of all occupants, cargo and the trailer tongue load (if applicable) (▷ page 300) as to not exceed the permissible load limit, you must make sure that your vehicle never exceeds the Gross Vehicle Weight Rating (GVWR) and the Gross Axle Weight Rating (GAWR) for either the front or rear axle. You can obtain the GVWR and GAWR from the Certification label. The Certification label can be found on the driver's door B-pillar, see "Technical data" (▷ page 434).

Gross Vehicle Weight Rating (GVWR): The total weight of the vehicle, all occupants, all cargo, and the trailer tongue load (▷ page 300) must never exceed the GVWR.

Gross Axle Weight Rating (GAWR): The total allowable weight that can be carried by a single axle (front or rear).

To assure that your vehicle does not exceed the maximum permissible weight limits (GVWR and GAWR for front and rear axle), have the loaded vehicle (including driver, passengers and all cargo and, if applicable, trailer fully loaded) weighed on a suitable commercial scale.

Trailer tongue load

The tongue load of any trailer is an important weight to measure because it affects the load you can carry in your vehicle. If a trailer is towed, the tongue load must be added to the weight of all occupants riding and any cargo you are carrying in the vehicle. The tongue load typically is between 10% and 15% of the trailer weight and everything loaded in it.

Your Mercedes-Benz has been designed primarily to carry passengers and their cargo. Mercedes-Benz does not recommend trailer towing with your vehicle.

Recommended tire inflation pressure

Warning!



Follow recommended tire inflation pressures.

Do not underinflate tires. Underinflated tires wear excessively and/or unevenly, adversely affect handling and fuel economy, and are more likely to fail from being overheated.

Do not overinflate tires. Overinflated tires can adversely affect handling and ride comfort, wear unevenly, increase stopping distance, and result in sudden deflation (blowout) because they are more likely to become punctured or damaged by road debris, potholes etc.

Your vehicle is equipped with the Tire and Loading Information placard located on the driver's door B-pillar (▷ page 296).

The tire inflation pressure should be checked regularly and should only be adjusted on cold tires. The tires can be considered cold if the vehicle has been parked for at least 3 hours or driven less than 1 mile (1.6 km).

Follow recommended cold tire inflation pressures listed on Tire and Loading Information placard on the driver's B-pillar.

Keeping the tires properly inflated provides the best handling, tread life and riding comfort.

In addition to the Tire and Loading Information placard on the driver's door B-pillar, also consult the fuel filler flap for any additional information pertaining to special driving situations. For more information, see "Important notes on tire inflation pressure" (▷ page 302).

i Data shown on placard example are for illustration purposes only. Load limit data are specific to each vehicle and may vary from data shown in the illustration below. Refer to placard on vehicle for actual data specific to your vehicle.

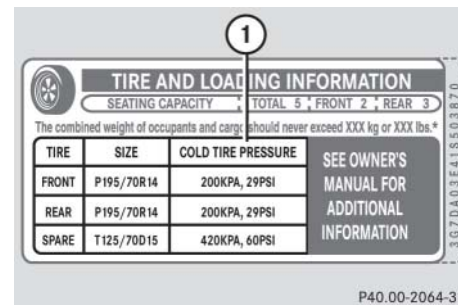

① Tire and Loading Information placard with recommended cold tire inflation pressures

The Tire and Loading Information placard lists the recommended cold tire inflation pressures for maximum loaded vehicle weight. The tire inflation pressures listed apply to the tires installed as original equipment.

Tires and wheels

Important notes on tire inflation pressure

Warning!



If the tire inflation pressure repeatedly drops:

- Check the tires for punctures from foreign objects.
- Check to see whether air is leaking from the valves or from around the rim.

Tire temperature and tire inflation pressure are also increased while driving, depending on the driving speed and the tire load.

If you will be driving your vehicle at high speeds of 100 mph (160 km/h) or higher, where it is legal and conditions allow, consult the placard on the inside of the fuel filler flap on how to adjust the cold tire inflation pressure. If you do not adjust the tire inflation pressure, excessive heat can build up and result in sudden tire failure.

i *Driving comfort may be reduced when the tire inflation pressure is adjusted to the value for speeds above 100 mph (160 km/h) as specified on the placard located on the inside of the fuel filler flap.*

Be sure to readjust the tire inflation pressure for normal driving speeds. You should wait until the tires are cold before adjusting the tire inflation pressure.

Some vehicles may have supplemental tire inflation pressure information for vehicle loads less than the maximum loaded vehicle condition. If such information is provided, it can be found on the placard located on the inside of the fuel filler flap.

Tire inflation pressure changes by approximately 1.5 psi (0.1 bar) per 18°F (10°C) of air temperature change. Keep this in mind when checking tire inflation pressure where the temperature is different from the outside temperature.

Checking tire inflation pressure

Regularly check your tire inflation pressure at least once a month.

Check and adjust the tire inflation pressure when the tires are cold. The tires can be considered cold if the vehicle has been parked for at least 3 hours or driven less than 1 mile (1.6 km).

If you check the tire inflation pressure when the tires are warm (the vehicle has been driven for several miles or sitting less than 3 hours), the reading will be approximately 4 psi (0.3 bar) higher than the cold reading. This is normal. Do not let air out to match the specified cold tire inflation pressure. Otherwise, the tire will be underinflated.

Warning!

Follow recommended tire inflation pressures.

Do not underinflate tires. Underinflated tires wear excessively and/or unevenly, adversely affect handling and fuel economy, and are more likely to fail from being overheated.

Do not overinflate tires. Overinflated tires can adversely affect handling and ride comfort, wear unevenly, increase stopping distance, and result in sudden deflation (blowout) because they are more likely to become punctured or damaged by road debris, potholes etc.

Do not overload the tires by exceeding the specified total load limit as indicated on the placard located on the driver's door B-pillar. Overloading the tires can overheat them, possibly causing a blowout.

Checking tire inflation pressure manually

Follow the steps below to achieve correct tire inflation pressure:

- ▶ Remove the cap from the valve on one tire.
- ▶ Firmly press a tire gauge onto the valve.
- ▶ Read tire inflation pressure on tire gauge and check against the recommended tire inflation pressure on the placard on the driver's door B-pillar (▷ page 296) or, if available, the inside of the fuel filler flap. If necessary, add air to achieve the recommended tire inflation pressure.

i *If you have overfilled the tire, release tire inflation pressure by pushing the metal stem of the valve with e.g. a tip of a pen. Then recheck the tire inflation pressure with the tire gauge.*

- ▶ Install the valve cap.
- ▶ Repeat this procedure for each tire.

Tires and wheels

Run Flat Indicator (Canada only)

While the vehicle is being driven, the Run Flat Indicator monitors the set tire inflation pressures by evaluating each wheel's rotational speed. This allows the system to detect a significant loss of pressure in a tire. If a wheel's rotational speed changes due to falling tire inflation pressure, you will see a corresponding warning message in the multifunction display.

The Run Flat Indicator may function in a restricted manner or with a delay

- if snow chains are mounted to the vehicle
- in winter road conditions prevail in presence of ice and snow
- if you are driving on a loose surface (e.g. sand or gravel)
- if you are driving in a very sporty manner (involving rapid acceleration or high speeds in curves)

Warning!



When the multifunction display shows the message **Tire pressure Check tires**, one or more of your tires is significantly under-inflated. You should stop and check your tires as soon as possible, and inflate them to the proper tire inflation pressure as indicated on the vehicle's tire and Loading Information placard. Driving on a significantly under-inflated tire causes the tire to overheat and can lead to tire failure. Under-inflation also reduces fuel efficiency and tire tread life, and may affect the vehicle's handling and stopping ability. Each tire, including the spare, should be checked monthly when cold and set to the recommended tire inflation pressure as specified in the vehicle placard and owner's manual.

i *The recommended tire inflation pressures for your vehicle can be found on the tire placard located on the driver's door B-pillar (▷ page 296). The tire inflation pressures are not listed in the owner's manual.*

Warning!



The Run Flat Indicator does not provide a warning for wrongly selected tire inflation pressures. Always adjust tire inflation pressure according to the placard on the driver's door B-pillar or fuel filler flap.

The Run Flat Indicator does not replace regular checks of the tire inflation pressures since a gradual pressure loss in more than one tire cannot be detected by the Run Flat Indicator.

The Run Flat Indicator is not able to issue a warning due to a sudden dramatic loss of tire inflation pressure (e.g. tire blowout caused by a foreign object). In this case bring the vehicle to a halt by carefully applying the brakes and avoiding abrupt steering maneuvers.

Reactivating the Run Flat Indicator

The tire inflation pressure monitor must be reactivated in the following situations:



- If you have changed the tire inflation pressure
- If you have replaced the wheels or tires
- If you have installed new wheels or tires
- ▶ Using the tire placard on the driver's door B-pillar or, if available, the inside of the fuel filler flap, make sure the tire inflation pressure of all four tires is correct.

Warning!



The Run Flat Indicator can only warn you in a reliable manner if you have set the correct tire inflation pressures for each tire.

If an incorrect tire inflation pressure was set, the system will monitor the pressure according to the incorrect value.

- ▶ Switch on the ignition (▷ page 38).
Make sure the standard display menu appears in the multifunction display (▷ page 141).
- ▶ Press button  or  repeatedly until the following message appears in the multifunction display:
Run Flat Indicator
active
Menu: R-Button
- ▶ Press the reset button (▷ page 27).

The following message will appear in the multifunction display:
Restart
Run Flat Indicator?
Cancel
Yes

If you wish to confirm activation:

- ▶ Press button .

The following message will appear in the multifunction display:
Run Flat Indicator
restarted

After a certain “learning phase”, the Run Flat Indicator checks the set pressure values for all four tires.

If you wish to cancel activation:

- ▶ Press button .

or

- ▶ Wait until the message
Restart
Run Flat Indicator?
Cancel
Yes
disappears.

Tires and wheels

Checking tire pressure electronically with the Tire Pressure Monitoring System (TPMS), (USA only)

i The Tire Pressure Monitoring System (TPMS) is equipped with a combination low tire pressure/TPMS malfunction telltale in the instrument cluster (▷ page 27). Depending on how the telltale illuminates, it indicates a low tire pressure condition or a malfunction in the TPMS system itself:

- If the telltale illuminates continuously, one or more of your tires is significantly under-inflated. There is no malfunction in the TPMS.
- If the telltale flashes for 60 seconds and then stays illuminated, the TPMS system itself is not operating properly.

The TPMS only functions on wheels that are equipped with the proper electronic sensors. It monitors the tire inflation pressure, as selected by the driver, in all four tires. A warning is issued to alert you to a decrease in pressure in one or more of the tires.

i This device complies with Part 15 of the FCC Rules. Operation is subject to the following two conditions:

- (1) This device may not cause harmful interference, and
- (2) this device must accept any interference received, including interference that may cause undesired operation.

Any unauthorized modification to this device could void the user's authority to operate the equipment.

Warning!



The TPMS does not indicate a warning for wrongly selected inflation pressures. Always adjust tire inflation pressure according to the placard on the driver's door B-pillar or, if available, the supplemental tire pressure information on the inside of the fuel filler flap.

The TPMS is not able to issue a warning due to a sudden dramatic loss of pressure (e.g. tire blowout caused by a foreign object). In this case bring the vehicle to a halt by carefully applying the brakes and avoiding abrupt steering maneuvers.

Warning!

Each tire, including the spare (if provided), should be checked monthly when cold and inflated to the inflation pressure recommended by the vehicle manufacturer on the vehicle placard or the tire inflation pressure label. (If your vehicle has tires of a different size than the size indicated on the vehicle placard or the tire inflation pressure label, you should determine the proper tire inflation pressure for those tires).

As an added safety feature, your vehicle has been equipped with a tire pressure monitoring system (TPMS) that illuminates a low tire pressure telltale when one or more of your tires is significantly under-inflated. Accordingly, when the low tire pressure telltale illuminates, you should stop and check your tires as soon as possible, and inflate them to the proper pressure. Driving on a significantly under-inflated tire causes the tire to overheat and can lead to tire failure.

Under-inflation also reduces fuel efficiency and tire tread life, and may affect the vehicle's handling and stopping ability. Please note that the TPMS is not a substitute for proper tire maintenance, and it is the driver's responsibility to maintain correct tire pressure, even if under-inflation has not reached the level to trigger illumination of the TPMS low tire pressure telltale.

Your vehicle has also been equipped with a TPMS malfunction indicator to indicate when the system is not operating properly. The TPMS malfunction indicator is combined with the low tire pressure telltale. When the system detects a malfunction, the telltale will flash for approximately one minute and then remain continuously illuminated. This sequence will continue upon subsequent vehicle start-ups as long as the malfunction exists. When the malfunction indicator is illuminated, the system may not be able to detect or signal low tire pressure as intended.

TPMS malfunctions may occur for a variety of reasons, including the installation of incompatible replacement or alternate tires or wheels on the vehicle that prevent the TPMS from functioning properly. Always check the TPMS malfunction telltale after replacing one or more tires or wheels on your vehicle to ensure that the replacement or alternate tires and wheels allow the TPMS to continue to function properly.

i *If a condition causing the TPMS to malfunction develops, it may take up to 10 minutes for the system to signal a malfunction using the TPMS telltale flashing and illumination sequence.*

The telltale extinguishes after a few minutes driving if the malfunction has been corrected.

i *Operating radio transmission equipment (e.g. wireless headsets, two-way radios) in or near the vehicle could cause the TPMS to malfunction.*

Tires and wheels

Reactivating the TPMS

The TPMS must be reactivated when you have adjusted the tire inflation pressure to a new level (e.g. because of different load or driving conditions). The TPMS is then recalibrated to the current tire inflation pressures.





Warning!



It is the driver's responsibility to calibrate the TPMS on the recommended cold inflation pressure. Underinflated tires affect the ability to steer or brake the vehicle. You might lose control over the vehicle.

- ▶ Using the tire placard on the driver's door B-pillar (▷ page 296) or, if available, the supplemental tire pressure information on the inside of the fuel filler flap (▷ page 283), make sure the tire inflation pressure of all four tires is correct.

i Reactivate the TPMS after adjusting the tire inflation pressure to the inflation pressure recommended for the vehicle operating condition. Tire pressure should only be adjusted on cold tires. Observe the recommended tire inflation pressure on the placard on the driver's door B-pillar (▷ page 296). Some vehicles may have supplemental tire pressure information for driving at high speeds (▷ page 302) or for vehicle loads less than the maximum loaded vehicle condition (▷ page 302). If such information is provided, it can be found on the inside of the fuel filler flap (▷ page 283).

- ▶ Press button  or  on the multifunction steering wheel repeatedly until the standard display menu appears in the multifunction display (▷ page 141).
- ▶ Press the  or  button repeatedly until you see the following message:
Tire pressure
monitor active
Menu: R-button

- ▶ Press the reset button (▷ page 27).

The following message will appear in the multifunction display:

```
Restart
tire pressure
monitor?
Cancel
Yes
```

- ▶ Press the  button.

The following message will appear in the multifunction display:

```
Tire pres. monitor
restarted
```

After driving a few minutes the system verifies that the current tire inflation pressures are within the system's specified range. Afterwards the current tire inflation pressures are accepted as reference pressures and then monitored.

If you wish to cancel activation:

- ▶ Press the  button.

Checking tire pressure electronically with the Advanced Tire Pressure Monitoring System* (Advanced TPMS*), (Canada only)

i This device complies with RSS-210 of Industry Canada. Operation is subject to the following two conditions:



- (1) This device may not cause interference, and
- (2) this device must accept any interference received, including interference that may cause undesired operation of the device.

Any unauthorized modification to this device could void the user's authority to operate the equipment.

The TPMS only functions on wheels that are equipped with the proper electronic sensors. It monitors the tire inflation pressure, as selected by the driver, in all four tires. A warning is issued to alert you to a decrease in pressure in one or more of the tires.

Tire pressure inquiries are made using the multifunction display. The present inflation pressures are displayed only after a few minutes travel time.

i Possible differences between the readings of a tire pressure gauge of an air hose, e.g. gas station equipment, and the vehicle's control system can occur. Usually the readings issued by the control system are more precise.

- ▶ Switch on the ignition (▷ page 38).
- ▶ Press the  or  button until the current inflation pressures for each tire appear in the multifunction display.

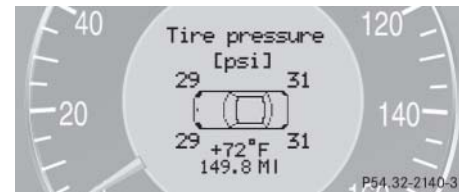

i When the message Tire pressure is only displayed only after driving for a few minutes appears in the display, the individual inflation pressure values are matched with the tires. The individual values are displayed after a few minutes driving.

Warning!



It is the driver's responsibility to calibrate the TPMS on the recommended cold inflation pressure. Underinflated tires affect the ability to steer or brake the vehicle. You might lose control over the vehicle.



Tires and wheels

- ▷▷ **i** *With a spare wheel without wheel sensor mounted, the system may still indicate the tire inflation pressure of the removed wheel for some minutes. If this happens, keep in mind that the indicated value where the spare wheel is mounted does not reflect the actual spare tire inflation pressure.*

Warning!



The TPMS does not indicate a warning for wrongly selected inflation pressures. Always adjust tire inflation pressure according to the placard on the driver's door B-pillar or, if available, the supplemental tire pressure information on the inside of the fuel filler flap.

The TPMS is not able to issue a warning due to a sudden dramatic loss of pressure (e.g. tire blowout caused by a foreign object). In this case bring the vehicle to a halt by carefully applying the brakes and avoiding abrupt steering maneuvers.

Warning!



Each tire, including the spare (if provided), should be checked monthly when cold and inflated to the inflation pressure recommended by the vehicle manufacturer on the vehicle placard or the tire inflation pressure label. (If your vehicle has tires of a different size than the size indicated on the vehicle placard or the tire inflation pressure label, you should determine the proper tire inflation pressure for those tires).

As an added safety feature, your vehicle has been equipped with a tire pressure monitoring system (TPMS) that illuminates a low tire pressure telltale when one or more of your tires is significantly under-inflated. Accordingly, when the low tire pressure telltale illuminates, you should stop and check your tires as soon as possible, and inflate them to the proper pressure. Driving on a significantly under-inflated tire causes the tire to overheat and can lead to tire failure.

Under-inflation also reduces fuel efficiency and tire tread life, and may affect the vehicle's handling and stopping ability. Please note that the TPMS is not a substitute for proper tire maintenance, and it is the driver's responsibility to maintain correct tire pressure, even if under-inflation has not reached the level to trigger illumination of the TPMS low tire pressure telltale.

i *Operating radio transmission equipment (e.g. wireless headsets, two-way radios) in or near the vehicle could cause the TPMS to malfunction.*

Reactivating Advanced TPMS*

The TPMS must be reactivated when you have adjusted the tire inflation pressure to a new level (e.g. because of different load or driving conditions). The TPMS is then recalibrated to the current tire inflation pressures.

Warning!







It is the driver's responsibility to calibrate the TPMS on the recommended cold inflation pressure. Underinflated tires affect the ability to steer or brake the vehicle. You might lose control over the vehicle.

- ▶ Using the tire placard on the driver's door B-pillar or, if available, the supplemental tire pressure information on the

inside of the fuel filler flap, make sure the tire inflation pressure of all four tires is correct.

i *Reactivate the TPMS after adjusting the tire inflation pressure to the inflation pressure recommended for the vehicle operating condition. Tire pressure should only be adjusted on cold tires. Observe the recommended tire inflation pressure on the placard on the driver's door B-pillar (▷ page 296). Some vehicles may have supplemental tire pressure information for driving at high speeds (▷ page 302) or for vehicle loads less than the maximum loaded vehicle condition. If such information is provided, it can be found on the inside of the fuel filler flap.*

- ▶ Press button  or  on the multifunction steering wheel repeatedly until the standard display menu appears in the multifunction display (▷ page 147).

- ▶ Press the  or  button repeatedly until you see the current inflation pressures for each tire appear in the multifunction display or the following message appears in the multifunction display:

Tire pressure is only displayed after driving for a few minutes

- ▶ Press the reset button (▷ page 27).

The following message will appear in the multifunction display:

Restart tire pressure monitor?



Tires and wheels

▷▷ Press the **+** button.

The following message will appear in the multifunction display:

Tire pres. monitor
restarted

After a few minutes driving, the current tire inflation pressure values are accepted as reference values and then monitored.

If you wish to cancel activation:

▶ Press the **-** button.

Potential problems associated with underinflated and overinflated tires

Underinflated tires

Underinflated tires can:

- cause excessive and uneven tire wear
- adversely affect fuel economy
- lead to tire failure from being overheated
- adversely affect handling characteristics

Warning!



Follow recommended tire inflation pressures.

Do not underinflate tires. Underinflated tires wear excessively and/or unevenly, adversely affect handling and fuel economy, and are more likely to fail from being overheated.

Overinflated tires

Overinflated tires can:

- adversely affect handling characteristics
- cause uneven tire wear
- be more prone to damage from road hazards
- adversely affect ride comfort
- increase stopping distance

Warning!



Follow recommended tire inflation pressures.

Do not overinflate tires. Overinflated tires can adversely affect handling and ride comfort, wear unevenly, increase stopping distance, and result in sudden deflation (blowout) because they are more likely to become punctured or damaged by road debris, potholes etc.

MOExtended system*

The MOExtended system allows you to continue driving your vehicle even if there is a total loss of pressure in one or more tires.

You may only use the MOExtended system in conjunction with the Run Flat Indicator (Canada only) (▷ page 304) or the TPMS (USA only) (▷ page 306) or the Advanced TPMS* (Canada only) (▷ page 309).

For information on driving in case of pressure loss in one or more tires (emergency mode), see the “Practical hints” section (▷ page 419).

Tire labeling

Besides tire name (sales designation) and manufacturer name, a number of markings can be found on a tire.

Following are some explanations for the markings on your vehicle’s tires:

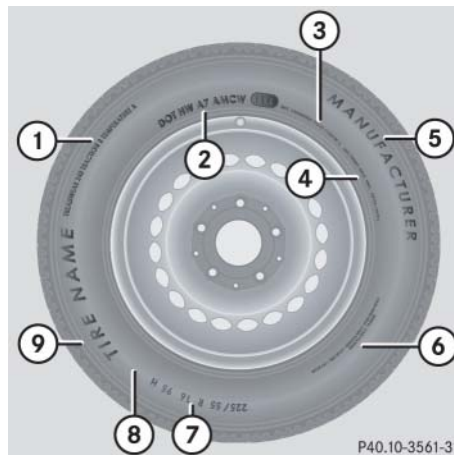

- ① Uniform Tire Quality Grading Standards (▷ page 320)
- ② DOT, Tire Identification Number (TIN) (▷ page 318)
- ③ Maximum tire load (▷ page 319)
- ④ Maximum tire inflation pressure (▷ page 320)
- ⑤ Manufacturer
- ⑥ Tire ply material (▷ page 322)
- ⑦ Tire size designation, load and speed rating (▷ page 314)
- ⑧ Load identification (▷ page 317)
- ⑨ Tire name

i For illustration purposes only. Actual data on tires are specific to each vehicle and may vary from data shown in above illustration.

For more information, see “Rims and tires” (▷ page 438).

Tires and wheels

Tire size designation, load and speed rating

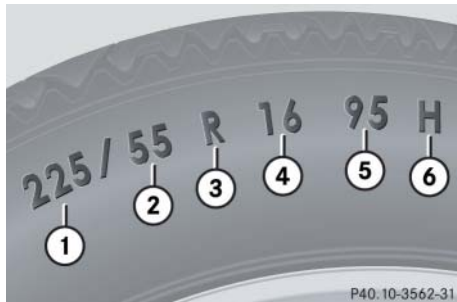

- ① Tire width
- ② Aspect ratio in %
- ③ Radial tire code
- ④ Rim diameter
- ⑤ Tire load rating
- ⑥ Tire speed rating

i For illustration purposes only. Actual data on tires are specific to each vehicle and may vary from data shown in above illustration.

General:

Depending on the design standards used, the tire size molded into the sidewall may have no letter or a letter preceding the tire size designation.

No letter preceding the size designation (as illustrated above): Passenger car tire based on European design standards.

Letter “P” preceding the size designation: Passenger car tire based on U.S. design standards.

Letter “LT” preceding the size designation: Light Truck tire based on U.S. design standards.

Letter “T” preceding the size designation: Temporary spare tires which are high pressure compact spares designed for temporary emergency use only.

Tire width

The tire width ① (▷ page 314) indicates the nominal tire width in mm.

Aspect ratio

The aspect ratio ② (▷ page 314) is the dimensional relationship between tire section height and section width and is expressed in percentage. The aspect ratio is arrived at by dividing section height by section width.

Tire code

The tire code ③ (▷ page 314) indicates the tire construction type. The “R” stands for radial tire type. Letter “D” means diagonal or bias ply construction; letter “B” means belted-bias ply construction.

At the tire manufacturer’s option, any tire with a speed capability above 149 mph (240 km/h) can include a “ZR” in the size designation (for example: 245/40 ZR 18). For additional information, see “Tire speed rating” (▷ page 316).

Rim diameter

The rim diameter ④ (▷ page 314) is the diameter of the bead seat, not the diameter of the rim edge. Rim diameter is indicated in inches (in).

Tire load rating

The tire load rating ⑤ (▷ page 314) is a numerical code associated with the maximum load a tire can support.

For example, a load rating of 91 corresponds to a maximum load of 1356 lbs (615 kg) the tire is designed to support. See also “Maximum tire load” (▷ page 319) where the maximum load associated with the load index is indicated in kilograms and lbs.

Warning!



The tire load rating must always be at least half of the GAWR (▷ page 323) of your vehicle. Otherwise, tire failure may be the result which may cause an accident and/or serious personal injury to you or others.

Always replace rims and tires with the same designation, manufacturer and type as shown on the original part.

Warning!



Do not overload the tires by exceeding the specified total load limit as indicated on the placard located on the driver’s door B-pillar. Overloading the tires can overheat them, possibly causing a blowout. Overloading the tires can also result in handling or steering problems, or brake failure.

For additional information on tire load rating, see “Load identification” (▷ page 317).

i *Tire load rating ⑤ (▷ page 314) and Tire speed rating ⑥ (▷ page 314) are also referred to as “service description”.*

Tires and wheels

Tire speed rating

The tire speed rating ⑥ (▷ page 314) indicates the approved maximum speed for the tire.

Warning!



Even when permitted by law, never operate a vehicle at speeds greater than the maximum speed rating of the tires.

Exceeding the maximum speed for which tires are rated can lead to sudden tire failure, causing loss of vehicle control and possibly resulting in an accident and/or personal injury and possible death, for you and for others.

i Tire load rating ⑤ (▷ page 314) and Tire speed rating ⑥ (▷ page 314) are also referred to as “service description”.

Summer tires

Index	Speed rating
Q	up to 100 mph (160 km/h)
R	up to 106 mph (170 km/h)
S	up to 112 mph (180 km/h)
T	up to 118 mph (190 km/h)
H	up to 130 mph (210 km/h)
V	up to 149 mph (240 km/h)
W	up to 168 mph (270 km/h)
Y	up to 186 mph (300 km/h)
(Y)	above 186 mph (300 km/h)
ZR	above 149 mph (240 km/h)

- At the tire manufacturer’s option, any tire with a speed capability above 149 mph (240 km/h) can include a “ZR” in the size designation (for example: 245/40 ZR18). To determine the maximum speed capability of the tire, the service description for the tire must be referred to. The service description

is comprised of the tire load rating ⑤ (▷ page 314) and the tire speed rating ⑥ (▷ page 314).

If your tire includes “ZR” in the size designation and no service description ⑤ and ⑥ (▷ page 314) is given, the tire manufacturer must be consulted for the maximum speed capability.

If a service description ⑤ and ⑥ (▷ page 314) is given, the speed capability is limited by the speed symbol in the service description.

Example: 245/40 ZR18 97Y.



In this example, “97Y” is the service description. The letter “Y” designates the speed rating and the speed capability of the tire is limited to 186 mph (300 km/h).

- Any tire with a speed capability above 186 mph (300 km/h) must include a “ZR” in the size designation AND the service description must be placed in parenthesis. Example: 275/40 ZR 18 (99Y). The “(Y)” speed rating in parenthesis designates the maximum speed capability of the tire as being above 186 mph (300 km/h). Consult the tire manufacturer for the actual maximum permissible speed of the tire.

All-season and winter tires

Index	Speed rating
Q M+S ¹	up to 100 mph (160 km/h)
T M+S ¹	up to 118 mph (190 km/h)
H M+S ¹	up to 130 mph (210 km/h)
V M+S ¹	up to 149 mph (240 km/h)

¹ or M+S  for winter tires

 *Not all M+S rated tires provide special winter performance. Make sure the tires you use show M+S and the mountain/snowflake  marking on the tire sidewall. These tires meet specific snow traction performance requirements of the Rubber Manufacturers Association (RMA) and the Rubber Association of Canada (RAC) and have been designed specifically for use in snow conditions.*

Load identification



① Load identification

 *For illustration purposes only. Actual data on tires are specific to each vehicle and may vary from data shown in above illustration.*

In addition to tire load rating, special load identification ① may be molded into the tire sidewall following the letter designating the tire speed rating ⑥ (▷ page 314).

No specification given: absence of any text (like in above example) indicates a standard load (SL) tire.

XL or Extra Load: designates an extra load (or reinforced) tire.

Light Load: designates a light load tire.

C, D, E: designates load range associated with the maximum load a tire can carry at a specified pressure.

Tires and wheels

DOT, Tire Identification Number (TIN)

U.S. tire regulations require each new tire manufacturer or tire retreader to mold a TIN into or onto a sidewall of each tire produced.

The TIN is a unique identifier which facilitates efforts by tire manufacturers to notify purchasers in recall situations or other safety matters concerning tires and gives purchasers the means to easily identify such tires.

The TIN is comprised of “Manufacturer’s identification mark”, “Tire size”, “Tire type code” and “Date of manufacture”.

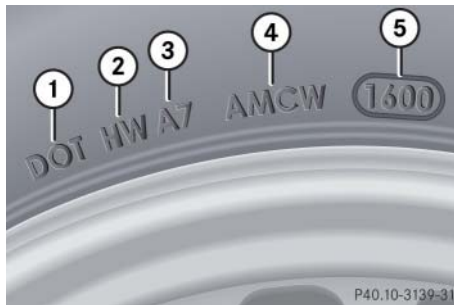

- ① DOT
- ② Manufacturer’s identification mark
- ③ Tire size
- ④ Tire type code (at the option of the tire manufacturer)
- ⑤ Date of manufacture

i For illustration purposes only. Actual data on tires are specific to each vehicle and may vary from data shown in above illustration.

DOT (Department of Transportation)

A tire branding symbol ① (▷ page 318) which denotes the tire meets requirements of the U.S. Department of Transportation.

Manufacturer’s identification mark

The manufacturer’s identification mark ② (▷ page 318) denotes the tire manufacturer.

New tires have a mark with two symbols.

Retreaded tires have a mark with four symbols. For more information on retreaded tires, see (▷ page 293).

Tire size

The code ③ (▷ page 318) indicates the tire size.

Tire type code

The code ④ (▷ page 318) may, at the option of the manufacturer, be used as a descriptive code for identifying significant characteristics of the tire.

Date of manufacture

The date of manufacture ⑤ (▷ page 318) identifies the week and year of manufacture.

The first two figures identify the week, starting with “01” to represent the first full week of the calendar year. The second two figures represent the year.

For example, “3202” represents the 32nd week of 2002.

Maximum tire load



① Maximum tire load rating

i For illustration purposes only. Actual data on tires are specific to each vehicle and may vary from data shown in above illustration.

The maximum tire load is the maximum weight the tires are designed to support.

Warning!



Do not overload the tires by exceeding the specified total load limit as indicated on the placard located on the driver's door B-pillar. Overloading the tires can overheat them, possibly causing a blowout. Overloading the tires can also result in handling or steering problems, or brake failure.

For more information on tire load rating (▷ page 315).

For information on calculating total and cargo load capacities (▷ page 297).

Tires and wheels

Maximum tire inflation pressure



- ① Maximum permissible tire inflation pressure

i For illustration purposes only. Actual data on tires are specific to each vehicle and may vary from data shown in above illustration.

This is the maximum permissible tire inflation pressure for the tire.

Always follow the recommended tire inflation pressure (▷ page 301) for proper tire inflation.

Warning!



Never exceed the max. tire inflation pressure. Follow recommended tire inflation pressures.

Do not underinflate tires. Underinflated tires wear excessively and/or unevenly, adversely affect handling and fuel economy, and are more likely to fail from being overheated.

Do not overinflate tires. Overinflated tires can adversely affect handling and ride comfort, wear unevenly, increase stopping distance, and result in sudden deflation (blowout) because they are more likely to become punctured or damaged by road debris, potholes etc.

Uniform Tire Quality Grading Standards (U.S. vehicles)

Tire manufacturers are required to grade tires based on three performance factors: treadwear, traction and temperature resistance.

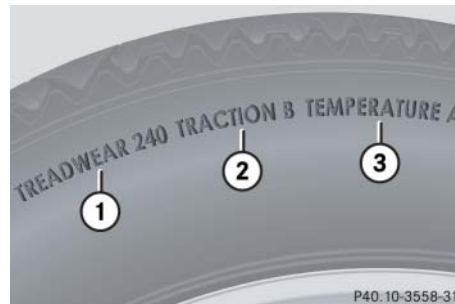

- ① Treadwear
- ② Traction
- ③ Temperature resistance

i For illustration purposes only. Actual data on tires are specific to each vehicle and may vary from data shown in above illustration.

Quality grades can be found, where applicable, on the tire sidewall between tread shoulder and maximum section width. For example:

Treadwear	Traction	Temperature
200	AA	A

All passenger car tires must conform to federal safety requirements in addition to these grades.

Treadwear

The treadwear grade is a comparative rating based on the wear rate of the tire when tested under controlled conditions on a specified government test course. For example, a tire graded 150 would wear one and one-half ($1\frac{1}{2}$) times as well on the government course as a tire graded 100. The relative performance of tires depends upon the actual conditions of their use, however, and may depart significantly from the norm due to variations in driving habits, service practices and differences in road characteristics and climate.

Traction

The traction grades, from highest to lowest, are AA, A, B, and C. Those grades represent the tire's ability to stop on wet pavement as measured under controlled conditions on specified government test surfaces of asphalt and concrete. A tire marked C may have poor traction performance.

Warning!



The traction grade assigned to this tire is based on straight-ahead braking traction tests, and does not include acceleration, cornering, hydroplaning, or peak traction characteristics.

Tires and wheels

Temperature

The temperature grades are A (the highest), B, and C, representing the tire's resistance to the generation of heat and its ability to dissipate heat when tested under controlled conditions on a specified indoor laboratory test wheel. Sustained high temperature can cause the material of the tire to degenerate and reduce tire life, and excessive temperature can lead to sudden tire failure. The grade C corresponds to a level of performance which all passenger car tires must meet under the Federal Motor Vehicle Safety Standard No. 109. Grades B and A represent higher levels of performance on the laboratory test wheel than the minimum required by law.

Warning!



The temperature grade for this tire is established for a tire that is properly inflated and not overloaded. Excessive speed, underinflation, or excessive loading, either separately or in combination, can cause excessive heat build-up and possible tire failure.

Tire ply material

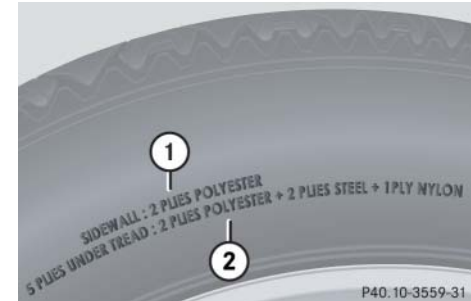

- ① Plies in sidewall
- ② Plies under tread

i For illustration purposes only. Actual data on tires are specific to each vehicle and may vary from data shown in above illustration.

This marking tells you about the type of cord and number of plies in the sidewall and under the tread.

Tire and loading terminology

Accessory weight

The combined weight (in excess of those standard items which may be replaced) of automatic transmission, power steering, power brakes, power windows, power seats, radio, and heater, to the extent that these items are available as factory-installed equipment (whether installed or not).

Air pressure

The amount of air inside the tire pressing outward on each square inch of the tire. Air pressure is expressed in pounds per square inch (psi), or kilopascal (kPa) or bars.

Aspect ratio

Dimensional relationship between tire section height and section width expressed in percentage.

Bar

Another metric unit for air pressure. There are 14.5038 pounds per square inch (psi) to 1 bar; there are 100 kilopascals (kPa) to 1 bar.

Bead

The tire bead contains steel wires wrapped by steel cords that hold the tire onto the rim.

Cold tire inflation pressure

Tire inflation pressure when your vehicle has been sitting for at least 3 hours or driven no more than 1 mile (1.6 km).

Curb weight

The weight of a motor vehicle with standard equipment including the maximum capacity of fuel, oil, and coolant, and, if so equipped, air conditioning and additional optional equipment, but without passengers and cargo.

DOT (Department of Transportation)

A tire branding symbol which denotes the tire meets requirements of the U.S. Department of Transportation.

GAWR (Gross Axle Weight Rating)

The GAWR is the maximum permissible axle weight. The gross vehicle weight on each axle must never exceed the GAWR for the front and rear axle indicated on the Certification label located on the driver's door B-pillar.

GVW (Gross Vehicle Weight)

The GVW comprises the weight of the vehicle including fuel, tools, spare wheel, installed accessories, passengers and cargo and, if applicable, trailer tongue load. The GVW must never exceed the GVWR indicated on the Certification label located on the driver's door B-pillar.

Tires and wheels

GVWR (Gross Vehicle Weight Rating)

This is the maximum permissible vehicle weight of the fully loaded vehicle (weight of the vehicle including all options, passengers, fuel, and cargo and, if applicable, trailer tongue load). It is indicated on Certification label located on the driver's door B-pillar.

Kilopascal (kPa)

The metric unit for air pressure. There are 6.9 kPa to 1 psi; another metric unit for air pressure is bars. There are 100 kilopascals (kPa) to 1 bar.

Maximum load rating

The maximum load in kilograms and pounds that can be carried by the tire.

Maximum loaded vehicle weight

The sum of curb weight, accessory weight, total load limit and production options weight.

Maximum tire inflation pressure

This number is the greatest amount of air pressure that should ever be put in the tire under normal driving conditions.

Normal occupant weight

The number of occupants the vehicle is designed to seat, multiplied by 68 kilograms (150 lbs).

Occupant distribution

The distribution of occupants in a vehicle at their designated seating positions.

Production options weight

The combined weight of those installed regular production options weighing over 5 lbs (2.3 kilograms) in excess of those standard items which they replace, not previously considered in curb weight or accessory weight, including heavy duty brakes, ride levelers, roof rack, heavy duty battery, and special trim.

PSI (Pounds per square inch)

A standard unit of measure for air pressure -> bar, kilopascal (kPa).

Recommended tire inflation pressure

Recommended tire inflation pressure listed on placard located on driver's door B-pillar for normal driving conditions. Provides best handling, tread life and riding comfort.

Rim

A metal support for a tire or a tire and tube assembly upon which the tire beads are seated.

Sidewall

The portion of a tire between the tread and the bead.

TIN (Tire Identification Number)

Unique identifier which facilitates efforts by tire manufacturers to notify purchasers in recall situations or other safety matters concerning tires and gives purchases the means to easily identify such tires. The TIN is comprised of “Manufacturer’s identification mark”, “Tire size”, “Tire type code” and “Date of manufacture”.

Tire load rating

Numerical code associated with the maximum load a tire can support.

Tire ply composition and material used

This indicates the number of plies or the number of layers of rubber-coated fabric in the tire tread and sidewall. Tire manufacturers also must indicate the ply materials in the tire and sidewall, which include steel, nylon, polyester, and others.

Tire speed rating

Part of tire designation; indicates the speed range for which a tire is approved.

Total load limit

Rated cargo and luggage load plus 68 kilograms (150 lbs) times the vehicle’s designated seating capacity.

Traction

Force exerted by the vehicle on the road via the tires. The amount of grip provided.

Tread

The portion of a tire that comes into contact with the road.

Treadwear indicators

Narrow bands, sometimes called “wear bars” that show across the tread of a tire when only $\frac{1}{16}$ in (1.6 mm) of tread remains.

Uniform Tire Quality Grading Standards

A tire information system that provides consumers with ratings for a tire’s traction, temperature and treadwear. Ratings are determined by tire manufacturers using government testing procedures. The ratings are molded into the sidewall of the tire.

Vehicle maximum load on the tire

Load on an individual tire that is determined by distributing to each axle its share of the maximum loaded vehicle weight and dividing it by two.

Tires and wheels

Rotating tires

Warning!



Rotate front and rear wheels only if they are of the same size.

If your vehicle is equipped with mixed-size tires (different tire dimensions front vs. rear), tire rotation is not possible.

Tire rotation can be performed on vehicles with tires of the same dimension all around. If your vehicle is equipped with tires of the same dimension all around, tires can be rotated, observing a front-to-rear rotation pattern that will maintain the intended rotation (spinning) direction of the tire (▷ page 295).

In some cases, such as when your vehicle is equipped with mixed-size tires (different tire dimension front vs. rear), tire rotation is not possible.

If applicable to your vehicle's tire configuration, tires can be rotated according to the tire manufacturer's recommended intervals in the tire manufacturer's warranty pamphlet located in your vehicle literature portfolio. If none is available, tires should be rotated every 3000 to 6000 miles (5000 to 10000 km), or sooner if necessary, according to the degree of tire wear. The same rotation (spinning) direction must be maintained (▷ page 295).

Rotate tires before the characteristic tire wear pattern becomes visible (shoulder wear on front tires and tread center wear on rear tires).

Thoroughly clean the mounting face of wheels and brake disks, i.e. the inner side of the wheels/tires, during each rotation. Check for and ensure proper tire inflation pressure.

Warning!



Have the tightening torque checked after changing a wheel. Wheels could become loose if not tightened with a torque of 96 lb-ft (130 Nm).

Only use Genuine Mercedes-Benz wheel bolts specified for your vehicle's rims.

For information on wheel change, see the "Practical hints" section (▷ page 391) and (▷ page 412).

▼ Winter driving

Before the onset of winter, have your vehicle winterized at an authorized Mercedes-Benz Center. This service includes:

- Check of anticorrosion and antifreeze concentration
- Addition of cleaning concentrate to the water of the windshield and headlamp cleaning system
Add MB Concentrate “S” to a premixed windshield washer solvent/antifreeze which is formulated for temperatures below freezing point (▷ page 456).
- Battery test
Battery capacity drops with decreasing ambient temperature. A well charged battery helps to make sure that the engine can be started, even at low ambient temperatures.
- Tire change

Winter tires

Always use winter tires at temperatures below 45°F (7°C) and whenever wintry road conditions prevail. Not all M+S rated tires provide special winter performance. Make sure the tires you use show the mountain/snowflake  marking on the tire sidewall. These tires meet specific snow traction performance requirements of the Rubber Manufacturers Association (RMA) and The Rubber Association of Canada (RAC) and have been designed specifically for use in snow conditions. Use of winter tires is the only way to achieve the maximum effectiveness of the ABS and ESP® in winter operation.

For safe handling, make sure that all mounted winter tires are of the same make and have the same tread design.

Warning!



Winter tires with a tread depth of less than $\frac{1}{6}$ in (4 mm) must be replaced. They are no longer suitable for winter operation.

Always observe the speed rating of the winter tires installed on your vehicle. If the maximum speed for which your tires are rated is below the speed rating of your vehicle, you must place a notice to this effect where it will be seen by the driver. Such notices are available at your tire dealer or any authorized Mercedes-Benz Center.

Warning!



If you use your spare tire when winter tires are fitted on the other wheels, be aware that the difference in tire characteristics may very well impair turning stability and that overall driving stability may be reduced. Adapt your driving style accordingly.

Have the spare tire replaced with a winter tire at the nearest authorized Mercedes-Benz Center.

Block heater* (Canada only)

The engine is equipped with a block heater.

The electrical cable may be installed at an authorized Mercedes-Benz Center.

Snow chains

! When driving with snow chains, always select the raised level of the level control system Airmatic (▷ page 231). Other settings may result in damage to your vehicle.

! Some tire sizes do not leave adequate clearance for snow chains. To help avoid serious damage to your vehicle or tires, make sure that the use of snow chains is permissible as specified in the “Technical data” section of this Operator’s Manual, see “Rims and tires” (▷ page 438).

Snow chains should only be driven on snow-covered roads at speeds not to exceed 30 mph (50 km/h). Remove chains as soon as possible when driving on roads without snow.

Please observe the following guidelines when using snow chains:

- Use of snow chains is not permissible with all wheel/tire combinations (▷ page 438).
- Use snow chains in pairs and on rear wheels only. Follow the manufacturer’s mounting instructions.

! If snow chains are mounted to the front wheels, they may scrape against the body or axle components. The tires or the vehicle could be damaged as a result.

- Only use snow chains that are approved by Mercedes-Benz. Any authorized Mercedes-Benz Center will be glad to advise you on this subject.
- Use of snow chains may be prohibited depending on location. Always check local and state laws before installing snow chains.
- Do not use snow chains on the spare wheel (▷ page 445).

i When driving with snow chains, you may wish to deactivate the ESP® (▷ page 95) before setting the vehicle in motion. This will improve the vehicle’s traction.

i CLS 63 AMG:
Do not switch off the ESP® when driving in snow or with snow chains mounted.

▼ Maintenance

We strongly recommend that you have your vehicle serviced by an authorized Mercedes-Benz Center, in accordance with the Maintenance Booklet at the times called for by the maintenance service indicator.

Failure to have the vehicle maintained in accordance with the Maintenance Booklet and maintenance service indicator at the designated times/mileage will result in vehicle damage not covered by the Mercedes-Benz Limited Warranty.

Maintenance service indicator message

The maintenance service indicator will notify you when the next maintenance service is due.

Starting approximately 1 month before the next maintenance service is due, one of the following messages will appear in the multifunction display while you are driving or when you switch on the ignition (example service A):

Service A in XXXX Miles (km)
 Service A in XX Days
 Service A in X Day
 Service A due now

The maintenance services will be indicated by showing a service type A through type H in the multifunction display. Types A through H are classified based on estimated time needed to perform the maintenance service, ranging:

from Service A
 (approx. 1 hour)
 to Service H
 (approx. 8 hours)

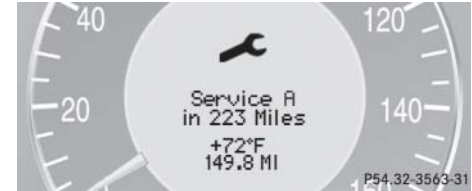

Refer to Maintenance Booklet for a listing of maintenance services and intervals they need to be performed at.

Maintenance

i Vehicles equipped with Maintenance System only (U.S. vehicles. Canada vehicles, depending on production date):
The Maintenance System in your vehicle tracks distance driven and the time elapsed since the last maintenance service and calculates other maintenance service work required.

i Vehicles equipped with FSS PLUS (Flexible Service System PLUS) only (Canada vehicles, depending on production date):

- FSS PLUS evaluates engine temperature, oil level, vehicle speed, engine speed, distance driven and the time elapsed since the last service and calculates other maintenance service work required.
- The interval between maintenance services depends on your driving habits. A gentle driving style, moderate engine speeds and the avoidance of short-distance trips will lengthen the interval between services.

Clearing the maintenance service indicator

The maintenance service indicator message is automatically cleared

- after approximately 10 seconds, when you switch on the ignition or when reaching the service threshold while driving
- after approximately 30 seconds, once the suggested maintenance service term has passed

You can also clear it yourself.



① Reset button

- ▶ Press the reset button ① on the instrument cluster.

The maintenance service indicator message is cleared and the standard display appears in the multifunction display (▷ page 147).

Maintenance service term exceeded

If you have exceeded the suggested maintenance service term, you will see the following message in the multifunction display:

Service A exceeded by XXXXX Miles (km)
Service A exceeded by XXX Days
Service A exceeded by X Day

In addition, a signal sounds when the message appears.

Any authorized Mercedes-Benz Center will reset the maintenance service indicator following a completed maintenance service.





Calling up the maintenance service indicator

 The menu overview can be found on [page 145](#).

You can call up the maintenance service indicator display, in the multifunction display, every time, to check when the next maintenance service is due.

- ▶ Switch on the ignition ([page 38](#)).

The standard display of the control system appears ([page 147](#)).

- ▶ Press button  or  on the multifunction steering wheel repeatedly until the standard display appears in the multifunction display ([page 141](#)).
- ▶ Press button  or  until the maintenance service indicator display with the service symbol  and the service deadline appears in the multifunction display.

 *If the battery is disconnected, the days of disconnection will not be included in the count shown by the maintenance service indicator. To arrive at the true maintenance service deadline, you will need to subtract these days from the days shown in the maintenance service indicator message or the maintenance service indicator display.*

Do not confuse the maintenance service indicator with the engine oil level indicator .

Resetting the maintenance service indicator

In the event that the maintenance service on your vehicle is not carried out by an authorized Mercedes-Benz Center, you can have the maintenance service indicator reset. The automotive maintenance facility carrying out the maintenance service will find the information for resetting the maintenance service indicator in the maintenance-relevant literature for your vehicle. Such literature is available from either your authorized Mercedes-Benz Center or directly from Mercedes-Benz.

 *If the maintenance service indicator was inadvertently reset, have an authorized Mercedes-Benz Center correct it.*

Only reset if the proper maintenance service has been performed. Resetting the system without performing the proper service as called for by the maintenance service indicator will result in engine damage and/or other vehicle damage not covered by the Mercedes-Benz Limited Warranty.

Cleaning and care of vehicle

Regular and proper care will help to maintain the value of your vehicle. The best way to protect your vehicle from harmful environmental influences is to wash it and use protective treatments regularly.

Warning!



Many cleaning products can be hazardous. Some are poisonous, others are flammable. Always follow the instructions on the particular container. Always open your vehicle's doors or windows when cleaning the inside.

Never use fluids or solvents that are not designed for cleaning your vehicle.

Always lock away cleaning products and keep them out of reach of children.

While in operation, even while parked, your vehicle is subjected to varying external influences which, if gone unchecked, can attack the paintwork as well as the vehicle underbody and cause lasting damage.

Such damage is caused not only by extreme and varying climatic conditions, but also by:

- Air pollution
- Road salt
- Tar
- Gravel and stone chipping

To avoid paint damage, you should immediately remove:

- Grease and oil
- Fuel
- Coolant
- Brake fluid
- Bird droppings
- Insects
- Tree resins etc.

Frequent washing reduces and /or eliminates the aggressiveness and potency of the above adverse influences.

More frequent washings are necessary to deal with unfavorable conditions:

- near the ocean
- in industrial areas (smoke, exhaust emissions)
- during winter operation

You should check your vehicle from time to time for stone chipping or other damage. Any damage should be repaired as soon as possible to prevent corrosion.

In doing so, do not neglect the underbody of the vehicle. A prerequisite for a thorough check is a washing of the underbody followed by a thorough inspection. Damaged areas need to be re-undercoated.

Your vehicle has been treated at the factory with a wax-base rustproofing in the body cavities which will last for the lifetime of the vehicle. Post-production treatment is neither necessary nor recommended by Mercedes-Benz because of the possibility of incompatibility between materials used in the production process and others applied later.

We have selected car-care products and compiled recommendations which are specially matched to our vehicles and which always reflect the latest technology. You can obtain Mercedes-Benz approved car-care products at an authorized Mercedes-Benz Center.

Scratches, corrosive deposits, corrosion or damage due to negligent or incorrect care cannot always be removed or repaired with the car-care products recommended here. In such cases it is best to seek aid at an authorized Mercedes-Benz Center.

The following topics deal with the cleaning and care of your vehicle and give important “how-to” information as well as references to Mercedes-Benz approved car-care products.

Power washer

! *Follow the instructions provided by the power washer manufacturer on maintaining a distance between the vehicle and the nozzle of the power washer.*

Never use a round nozzle to power-wash tires. The intense jet of water can result in damage to the tire.

Always replace a damaged tire.

Always keep the jet of water moving across the surface. Do not aim directly at electrical parts, electrical connectors, seals, or other rubber parts.

i *Vehicles with KEYLESS-GO*:
If a door handle is hit by a strong jet of water, and a SmartKey with KEYLESS-GO* is in close proximity, i.e. within approximately 3 ft (approximately 1 m), the vehicle could be inadvertently locked or unlocked.*

Tar stains

Quickly remove tar stains before they dry and become more difficult to remove. A tar remover is recommended.

Vehicle care

Paintwork, painted body components

! *Affixing stickers, magnets, adhesive tape or similar materials to painted body components may damage the paintwork.*

Mercedes-Benz approved Paint Care should be applied when water drops on the paint surface do not “bead up”. This should normally be done every 3 to 5 months, depending on the climate and washing detergent used.

Mercedes-Benz approved Paint Cleaner should be applied if the paint surface shows signs of embedded dirt (i.e. loss of gloss).

Do not apply any of these products or wax if your vehicle is parked in the sun or if the hood is still hot.

- ▶ Use the appropriate MB-Touch-Up Stick for quick and provisional repairs of minor paint damage (i.e. chips from stones, vehicle doors, etc.).

Engine cleaning

Prior to cleaning the engine compartment, make sure to protect electrical components and connectors from contact with water and cleaning agents.

Corrosion protection, such as MB Anticorrosion Wax, should be applied to the engine compartment after every engine cleaning. Before applying, all control linkage bushings and joints should be lubricated. The poly-V-belt and all pulleys should be protected from any wax.

Vehicle washing

In the winter, thoroughly remove all traces of road salt as soon as possible.

When washing the vehicle underbody, do not forget to clean the inner sides of the wheels.

i *Vehicles with KEYLESS-GO*:
If a door handle is hit by a strong jet of water, and a SmartKey with KEYLESS-GO* is in close proximity, i.e. within approximately 3 ft (approximately 1 m), the vehicle could be inadvertently locked or unlocked.*

Hand-wash

Do not use hot water or wash your vehicle in direct sunlight.

- ▶ Only use a mild car wash detergent, such as Mercedes-Benz approved Car Shampoo.
- ▶ Thoroughly spray the vehicle with a diffused jet of water.

Direct only a very weak spray towards the ventilation intake.

- ▶ Use plenty of water and rinse the sponge and chamois frequently.
- ▶ Rinse with clean water and thoroughly dry with a chamois.

Do not allow cleaning agents to dry on the finish.

! Do not use scouring agents on these parts.

Never apply strong force and only use a soft, non-scratching cloth when cleaning the vehicle. Do not attempt to wipe the surface with a dry cloth or sponge.

Otherwise you may scratch or damage the paint.

Automatic car wash

You can have your car washed in an automatic car wash from the start. Automatic car washes without brushes are preferable.

- ▶ To protect the filter system, switch the automatic climate control to air recirculation mode (▷ page 192) or (▷ page 193).

! Do not clean your vehicle in an automatic touchless car wash which uses caustic spray. Otherwise the caustic spray will damage the paint or ornamental moldings.

If the vehicle is very dirty, prewash it before running it through the automatic car wash.

! Make sure that the windshield wiper switch is set to **0** (▷ page 57). Otherwise, e.g. the rain sensor could activate and cause the wipers to move unintentionally. This may lead to vehicle damage.

Due to the width of the vehicle, fold in exterior rear view mirrors prior to running the vehicle through an automatic car wash to prevent damage to the mirrors.

i After running the vehicle through an automatic car wash, wipe any wax off of the windshield (▷ page 337). This will prevent smears and reduce wiping noise which can be caused by residual wax on the windshield.

When leaving the car wash, make sure that the mirrors are folded out. Otherwise they may vibrate.

Ornamental moldings

For regular cleaning and care of ornamental moldings, use a damp cloth.

! Do not use chrome cleaner on ornamental moldings. Although ornamental moldings may have chrome appearance, they could be made of anodized aluminum that will be damaged when cleaned with chrome cleaner. Instead, use a damp cloth to clean those ornamental moldings.

For very dirty ornamental moldings of which you are sure are chrome-plated, use a chrome cleaner. If in doubt whether an ornamental molding is chrome-plated, contact an authorized Mercedes-Benz Center.

Vehicle care

Headlamps, tail lamps, side markers, turn signal lenses

- ▶ Use a mild car wash detergent, such as Mercedes-Benz approved Car Shampoo, with plenty of water.

! Only use window cleaning solutions that are suitable for plastic lamp lenses. Window cleaning solutions which are not suitable may damage the plastic lamp lenses of the headlamps. Therefore, do not use abrasives, solvents or cleaners that contain solvents.

Never apply strong force and only use a soft, non-scratching cloth when cleaning the lenses. Do not attempt to wipe dirty lenses with a dry cloth or sponge.

Otherwise you may scratch or damage the lens surface.

Cleaning the DISTRONIC* system sensor cover

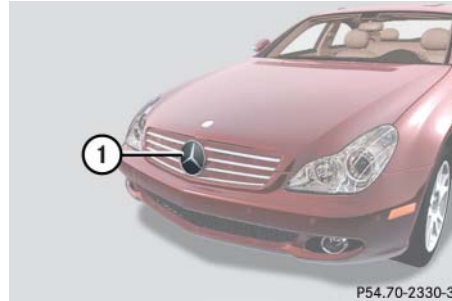

① DISTRONIC system sensor cover

- ▶ Switch off the ignition (▷ page 60).
- ▶ Use a mild car wash detergent, such as Mercedes-Benz approved Car Shampoo, with plenty of water and a non-scratching cloth to clean sensor cover ①.

! To prevent scratches or damage, never apply strong force and only use a soft, non-scratching cloth when cleaning the sensor cover ①. Do not attempt to wipe dirty sensors with a dry cloth or sponge.

- ▶ Restart the engine after cleaning sensor cover ①.

Cleaning the Parktronic* system sensors

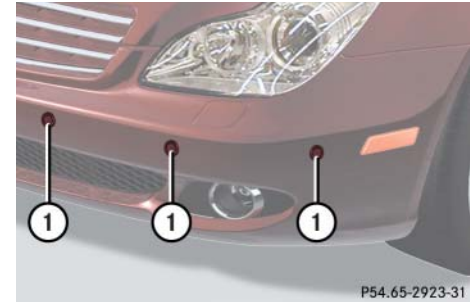

① Parktronic system* sensors in the front bumper

- ▶ Use a mild car wash detergent, such as Mercedes-Benz approved Car Shampoo, with plenty of water and a soft, non-scratching cloth to clean sensors ① on the bumpers.

! Do not apply strong pressure to the sensor covers. Applying strong pressure may damage the sensor covers.

Follow the instructions provided by the power washer manufacturer on maintaining a distance between the vehicle and the nozzle of the power washer.

! To prevent scratches, never apply strong force and only use a soft, non-scratching cloth when cleaning the sensors. Do not attempt to wipe dirty sensors with a dry cloth or sponge.

Cleaning the windows and the wiper blades

! The windshield wipers must be in a vertical position before folding them away from the windshield. They could otherwise damage the hood.

Never open the hood when the wiper arms are folded forward.

- ▶ Make sure the hood is fully closed.
- ▶ Switch on the ignition (▷ page 38).
- ▶ Turn combination switch to wiper setting  (▷ page 57).
- ▶ With wiper arms in vertical position, switch off the ignition (▷ page 60).

Warning!



For safety reasons, switch off wipers and remove SmartKey from starter switch (vehicles with KEYLESS-GO*: Make sure the vehicle's on-board electronics has status **0**) before cleaning the windshield and/or the wiper blades. Otherwise, the wiper motor could suddenly turn on and cause injury.

! Do not pull on the wiper blade inserts. They could tear.

- ▶ Fold the wiper arms forward until they snap into place.
- ▶ Clean the wiper blade inserts with a clean cloth and detergent solution.
- ▶ Use a soft, clean cloth and a mild window cleaning solution on all outside and inside glass surfaces.

An automotive glass cleaner is recommended.



Vehicle care

- ▷▷ **!** *Fold the windshield wiper arms back onto the windshield before turning the SmartKey in the starter switch or pressing the KEYLESS-GO start/stop button (vehicles with KEYLESS-GO*). Hold on to the wiper when folding the wiper arm back. If released, the force of the impact from the tensioning spring could crack the windshield.*

! *To clean the window interior, do not use a dry cloth, abrasives, solvents or cleaners containing solvents. Do not touch the inside of the front, rear or side windows with hard objects such as an ice scraper or ring. Doing so may damage the windows.*

Light alloy wheels

If possible, clean wheels once a week.

- ▶ Use Mercedes-Benz approved Wheel Care, a soft bristle brush and a strong spray of water for cleaning the light alloy wheels.

! *Only use acid-free cleaning materials. Acid may cause corrosion or damage the clear coat.*

! *The vehicle should not be parked for an extended period of time immediately after it has been cleaned, especially not after the wheel rims have been cleaned with wheel rim cleaner.*

Wheel rim cleaners can lead to increased corrosion of the brake disks and brake pads.

Non-approved wheel cleaners may also damage the wheel paint if the car is not driven after cleaning. Therefore, the vehicle's brake system should always be warmed-up before it is parked after cleaning. To do so, please drive your vehicle for several minutes to allow the brakes to dry.

When applying Mercedes-Benz approved Tire Care and Mercedes-Benz approved Wheel Care products, take care not to spray them on the brake disks.

Plastic and rubber parts

- ▶ Use a gentle dishwashing detergent or mild detergent for delicate fabrics as a washing solution.
- ▶ Wipe with a cloth moistened in a luke-warm solution.

The surface may temporarily change color. If this is the case, wait for it to dry.

Warning!



Do not use cleaners or cockpit care sprays containing solvents to clean the cockpit or the steering wheel. Cleaners containing solvents will make the surface porous and vehicle occupants could suffer serious injuries from plastic parts coming loose in the event of air bag deployment.

! Do not use oil, wax or scouring agents on these parts.

Never apply strong force and only use a soft, non-scratching cloth when cleaning the surface. Do not attempt to wipe the surface with a dry cloth or sponge.

Otherwise you may scratch or damage the surface.

Hard plastic trim items

- ▶ Use Mercedes-Benz approved Interior Care, a soft, lint-free cloth and apply with light pressure.

! Never apply strong force and only use a soft, non-scratching cloth when cleaning the surface. Do not attempt to wipe the surface with a dry cloth or sponge.

Otherwise you may scratch or damage the surface.

Steering wheel and gear selector lever

- ▶ Wipe with a damp cloth and dry thoroughly or clean with Mercedes-Benz approved Leather Care.

Carpets

- ▶ Use Mercedes-Benz approved Carpet and Fabric Care for cleaning the carpets.

Headliner and shelf below rear window

- ▶ Use a soft bristle brush or a dry-shampoo cleaner in case of excessive dirt.

Seat belts

- ▶ Only use clear, lukewarm water and soap.

! The seat belts must not be treated with chemical cleaning agents. Do not dry the seat belts at temperatures above 176 °F (80 °C) or in direct sunlight.

Warning!



Do not bleach or dye seat belts as this may severely weaken them. In a crash they may not be able to provide adequate protection.

Upholstery

Using aftermarket seat covers or wearing clothing that have the tendency to give off coloring (e.g. when wet, etc.) may cause the upholstery to become permanently discolored. By lining the seats with a proper intermediate cover, contact-discoloration will be prevented.

Warning!



Only use seat or head restraint covers which have been tested and approved by Mercedes-Benz for your vehicle model. Using other seat or head restraint covers may interfere with or prevent the activation of the active head restraints. Contact an authorized Mercedes-Benz Center for availability.

Vehicle care

Leather upholstery

Please note that leather upholstery is a natural product and is therefore subject to a natural aging process. Leather upholstery may also react to certain ambient influences such as high humidity or high temperature by showing wrinkles for example.

- ▶ Wipe leather upholstery with a damp cloth and dry thoroughly or clean with Mercedes-Benz approved Leather Care.

! *Wipe with light pressure to avoid damage to the upholstery.*

Exercise particular care when cleaning perforated leather as its underside should not become wet.

Wood trims

- ▶ Dampen cloth using water and use damp cloth to clean wood trims in your vehicle.

! *Do not use solvents like tar remover or wheel cleaner nor polishes or waxes as these may be abrasive.*



What to do if ...

Where will I find...?

Unlocking/locking in an emergency

Opening/closing in an emergency

Resetting activated head restraints

Replacing SmartKey batteries

Replacing bulbs

Replacing wiper blades

Flat tire

Battery

Jump starting

Towing the vehicle

Fuses

What to do if ...



Lamps in instrument cluster

General information:

If any of the following lamps in the instrument cluster fails to come on during the

bulb self-check when switching on the ignition, have the respective bulb checked and replaced if necessary.

Problem	Possible cause/consequence	Suggested solution
 <p>The yellow ABS indicator lamp comes on while the engine is running.</p>	<p>The ABS has detected a malfunction and has switched off. The BAS, EBP, ESP® and PRE-SAFE® are also switched off (see messages in multifunction display).</p> <p>The brake system is still functioning normally but without the ABS available.</p> <p>If the ABS control unit is malfunctioning, other systems such as the Parktronic system*, Distronic*, navigation system*, or the automatic transmission may also be malfunctioning.</p> <p>The charging voltage has fallen below 10 volts. The ABS has switched off.</p> <p>The battery may not be sufficiently charged.</p>	<ul style="list-style-type: none"> ▶ Continue driving with added caution. Wheels may lock during hard braking, reducing steering capability. ▶ Read and observe messages in the multifunction display (▷ page 356). ▶ Have the system checked at an authorized Mercedes-Benz Center as soon as possible. <p>Failure to follow these instructions increases the risk of an accident.</p> <p>When the voltage is above this value again, the ABS is operational again and the ABS indicator lamp should go out.</p> <p>If the ABS indicator lamp does not go out:</p> <ul style="list-style-type: none"> ▶ Have the generator (alternator) and battery checked.

Problem	Possible cause/consequence	Suggested solution
 The yellow ESP® warning lamp comes on while the engine is running.	<p>The ESP® is deactivated.</p> <p>Risk of accident!</p> <p>When the ESP® is switched off it will not stabilize the vehicle if the system recognizes that the vehicle starts to skid or that a wheel is spinning.</p>	<ul style="list-style-type: none"> ▶ Switch the ESP® back on (▷ page 98) Exceptions: (▷ page 95). <p>If the ESP® cannot be switched back on, have the system checked at an authorized Mercedes-Benz Center as soon as possible.</p>
 The yellow ESP® warning lamp flashes while driving.	<p>The ESP® or traction control has come into operation because of detected traction loss in at least one tire.</p> <p>The cruise control or DISTRONIC* is deactivated.</p>	<ul style="list-style-type: none"> ▶ When driving off, apply as little throttle as possible. ▶ While driving, ease up on the accelerator. ▶ Adapt your speed and driving to the prevailing road and weather conditions. ▶ Do not deactivate the ESP®. Exceptions: (▷ page 95). <p>Failure to follow these instructions increases the risk of accidents.</p>

What to do if ...

Problem	Possible cause/consequence	Suggested solution
<p>BRAKE (USA only)</p> <p>(i) (Canada only)</p> <p>The red brake warning lamp comes on while driving and you hear a warning sound.</p>	You are driving with the parking brake set.	▶ Release the parking brake.
<p>BRAKE (USA only)</p> <p>(i) (Canada only)</p> <p>The red brake warning lamp comes on when the engine is running and you hear a warning sound.</p>	There is insufficient brake fluid in the reservoir.	▶ Risk of accident! Do not drive any further. Consult a Mercedes-Benz Service Center. Under no circumstances should you top up the brake fluid. This will not solve the problem.



Warning!



Driving with the brake warning lamp illuminated can result in an accident. Have your brake system checked immediately if the brake warning lamp stays on. Do not add brake fluid before checking the brake system.

Overfilling the brake fluid reservoir can result in spilling brake fluid on hot engine parts and the brake fluid catching fire. You can be seriously burned.



! If you find that the brake fluid in the brake fluid reservoir has fallen to the minimum mark or below, have the brake system checked for brake pad thickness and leaks.

Problem	Possible cause/consequence	Suggested solution
<p> (USA only)</p> <p> (Canada only)</p> <p>The yellow engine malfunction indicator lamp comes on while driving.</p>	<p>There is a malfunction in:</p> <ul style="list-style-type: none"> • The fuel management system • The ignition system • The emission control system • Systems which affect emissions <p>Such malfunctions may result in excessive emissions values and may switch the engine to its limp-home (emergency operation) mode.</p>	<p>► Have the vehicle checked as soon as possible by an authorized Mercedes-Benz Center.</p> <p>An on-board diagnostic connector is used by the service station to link the vehicle to the shop diagnostics system. It allows the accurate identification of system malfunctions through the read-out of diagnostic trouble codes. It is located in the front left area of the footwell next to the parking brake.</p>

 *Some states may by law require you to contact a workshop immediately as soon as the engine malfunction indicator lamp comes on. Check local requirements.*

What to do if ...

Problem	Possible cause/consequence	Suggested solution
<div data-bbox="86 230 145 262" style="display: inline-block; border: 1px solid black; padding: 2px;">check engine</div> <div data-bbox="86 275 145 306" style="display: inline-block; border: 1px solid black; padding: 2px;"></div> <p>(USA only)</p> <p>(Canada only)</p> <p>The yellow engine malfunction indicator lamp comes on while driving.</p>	<p>A loss of pressure has been detected in the fuel system. The fuel cap may not be closed properly or the fuel system may be leaky.</p> <hr/> <p>Your fuel tank is empty.</p>	<ul style="list-style-type: none"> ▶ Check the fuel cap. <p>If it is not closed properly:</p> <ul style="list-style-type: none"> ▶ Close the fuel cap. <p>If it is closed properly:</p> <ul style="list-style-type: none"> ▶ Have the fuel system checked by an authorized Mercedes-Benz Center. <hr/> <ul style="list-style-type: none"> ▶ After refuelling start, turn off and re-start the engine three or four times in succession. <p>The limp-home mode is canceled. You do not need to have your vehicle checked.</p>

Problem	Possible cause/consequence	Suggested solution
 <p>The red coolant temperature warning lamp comes on when the engine is running.</p>	<p>There is insufficient coolant in the reservoir.</p> <p>If this warning lamp comes on frequently, there is a leak in the cooling system.</p> <p>If the coolant level is correct, the electric radiator fan may be broken.</p>	<ul style="list-style-type: none"> ▶ Immediately add coolant to prevent engine from overheating (▷ page 290). ▶ Have the cooling system checked. ▶ If the coolant temperature is below 248°F (120°C), you can continue driving to the nearest authorized Mercedes-Benz Center. ▶ Avoid high engine loads (e.g. driving uphill) and stop-and-go driving.
 <p>The red coolant temperature warning lamp comes on while driving and you hear a warning sound.</p>	<p>The coolant temperature has exceeded 248°F (120°C).</p>	<ul style="list-style-type: none"> ▶ Stop in a safe location as soon as possible and allow the engine and coolant to cool down.

Warning!









Driving when your engine is badly overheated can cause some fluids which may have leaked into the engine compartment to catch fire. You could be seriously burned.

Steam from an overheated engine can cause serious burns and can occur just by opening the engine hood. Stay away from the engine if you see or hear steam coming from it.

Turn off the engine, get out of the vehicle and do not stand near the vehicle until the engine has cooled down.

What to do if ...

Problem	Possible cause/consequence	Suggested solution
 The red distance warning lamp comes on while driving.	You are too close to the vehicle in front of you to maintain selected speed.	▶ Apply the brakes immediately to increase the following distance.
 The red distance warning lamp comes on while driving and you hear a warning chime sound.	<ul style="list-style-type: none"> • You are gaining too rapidly on the vehicle ahead of you. • The distance warning system has recognized a stationary obstacle on your probable line of travel. 	▶ Apply the brakes immediately. ▶ Carefully observe the traffic situation. You may need to brake or maneuver to avoid hitting an obstacle.
 The yellow fuel tank reserve warning lamp comes on while driving.	The fuel level has gone below the reserve mark.	▶ Refuel at the next gas station (▷ page 283).
 The red seat belt telltale comes on for a maximum of 6 seconds after starting the engine.	The seat belt telltale reminds you and your passengers to fasten your seat belts before driving off.	▶ Fasten your seat belts. Regardless of whether the seat belts are fastened or not, the seat belt telltale always comes on and remains lit for 6 seconds after starting the engine.
 You hear a warning chime for a maximum of 6 seconds after starting the engine.	You have forgotten to fasten your seat belt.	▶ Fasten your seat belt. The warning chime stops sounding.

Problem	Possible cause/consequence	Suggested solution
 <p>The red seat belt telltale comes on while the vehicle is standing still and the engine is running or during driving.</p>	<p>You and/or your front passenger have forgotten to fasten your seat belts.</p>	<p>► Fasten your seat belts. The seat belt telltale goes out.</p>
	<p>There are items placed on the front passenger seat and therefore the system senses the front passenger seat as being occupied.</p>	<p>► Remove the items from the front passenger seat and put them in a safe place. The seat belt telltale goes out.</p>
 <p>During driving the red seat belt telltale flashes and you additionally hear an intermittent warning chime with increasing intensity.</p>	<p>The vehicle's speed once exceeded 15 mph (25 km/h) and you and/or your front passenger have forgotten to fasten your seat belts.</p>	<p>► Fasten your seat belts. The seat belt telltale goes out and the warning chime stops sounding.</p>
	<p>There are items placed on the front passenger seat and therefore the system senses the front passenger seat as being occupied.</p>	<p>► Remove the items from the front passenger seat and put them in a safe place. The seat belt telltale goes out and the warning chime stops sounding.</p>

i After 60 seconds with an unfastened seat belt the warning chime stops sounding and the seat belt telltale illuminates continuously. The seat belt telltale will only go out if both, the

driver's and the front passenger's seat belt are fastened, or the vehicle is standing still and a front door is opened.



What to do if ...

Problem	Possible cause/consequence	Suggested solution
SRS The red SRS indicator lamp comes on while driving.	There is a malfunction in the restraint systems. The air bags or emergency tensioning devices (ETDs) could deploy unexpectedly or fail to activate in an accident.	► Drive with added caution to the nearest authorized Mercedes-Benz Center.

Warning!



In the event a malfunction of the SRS is indicated as outlined above, the SRS may not be operational. For your safety, we strongly recommend that you contact an authorized Mercedes-Benz Center immediately to have the system checked; otherwise the SRS may not be activated when needed in an accident, which could result in serious or fatal injury, or it might deploy unexpectedly and unnecessarily which could also result in an accident and/or injury to you or to others.

Problem	Possible cause/consequence	Suggested solution
<p> (USA only) Combination low tire pressure/TPMS malfunction telltale for the TPMS illuminates continuously.</p> <p>(Canada only) Low tire pressure telltale for the Advanced TPMS* illuminates continuously.</p>	<p>The TPMS (USA only) or Advanced TPMS* (Canada only) detects a loss of pressure in at least one tire.</p>	<ul style="list-style-type: none"> ▶ Carefully bring the vehicle to a halt, avoiding abrupt steering and braking maneuvers. Observe the traffic situation around you. ▶ Read and observe messages in the multifunction display (▷ page 356). <p>If the tire inflation pressure in the respective tire(s) has (have) been corrected, the combination low tire pressure/TPMS malfunction telltale goes out after few minutes driving.</p>
<p> (USA only) Combination low tire pressure/TPMS malfunction telltale for the TPMS flashes for 60 seconds and then stays illuminated.</p>	<p>There is a malfunction in the TPMS.</p>	<ul style="list-style-type: none"> ▶ Read and observe messages in the multifunction display (▷ page 356). ▶ Have the TPMS checked by an authorized Mercedes-Benz Center. <p>After the malfunction has been remedied the combination low tire pressure/TPMS malfunction telltale goes out after few minutes driving.</p>

What to do if ...

Warning!



Each tire, including the spare (if provided), should be checked monthly when cold and inflated to the inflation pressure recommended by the vehicle manufacturer on the vehicle placard or the tire inflation pressure label. (If your vehicle has tires of a different size than the size indicated on the vehicle placard or the tire inflation pressure label, you should determine the proper tire inflation pressure for those tires).



As an added safety feature, your vehicle has been equipped with a tire pressure monitoring system (TPMS) that illuminates a low tire pressure telltale when one or more of your tires is significantly under-inflated. Accordingly, when the low tire pressure telltale illuminates, you should stop and check your tires as soon as possible, and inflate them to the proper pressure. Driving on a significantly under-inflated tire causes the tire to overheat and can lead to tire failure.

Under-inflation also reduces fuel efficiency and tire tread life, and may affect the vehicle's handling and stopping ability. Please note that the TPMS is not a substitute for proper tire maintenance, and it is the driver's responsibility to maintain correct tire pressure, even if under-inflation has not reached the level to trigger illumination of the TPMS low tire pressure telltale.

Your vehicle has also been equipped with a TPMS malfunction indicator to indicate when the system is not operating properly. The TPMS malfunction indicator is combined with the low tire pressure telltale. When the system detects a malfunction, the telltale will flash for approximately one minute and then remain continuously illuminated. This sequence will continue upon subsequent vehicle start-ups as long as the malfunction exists. When the malfunction indicator is illuminated, the system may not be able to detect or signal low tire pressure as intended.

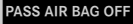

TPMS malfunctions may occur for a variety of reasons, including the installation of incompatible replacement or alternate tires or wheels on the vehicle that prevent the TPMS from functioning properly. Always check the TPMS malfunction telltale after replacing one or more tires or wheels on your vehicle to ensure that the replacement or alternate tires and wheels allow the TPMS to continue to function properly.

Lamp in center console

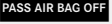

Problem	Possible cause/consequence	Suggested solution
(USA only)   The indicator lamp illuminates and remains illuminated with the weight of a typical adult or someone larger than a small individual on the front passenger seat.	The system is malfunctioning.	<ul style="list-style-type: none"> ▶ Have the system checked as soon as possible by an authorized Mercedes-Benz Center. ▶ Read and observe messages in the multifunction display and follow corrective steps (▷ page 356).

Warning!





If the   indicator lamp illuminates and remains illuminated with the weight of a typical adult or someone larger than a small individual on the front passenger seat, do not have any passenger use the front passenger seat until the system has been repaired.

What to do if ...

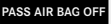

Problem	Possible cause/consequence	Suggested solution
<p>(USA only)</p> <p> </p> <p>The indicator lamp does not illuminate and/or does not remain illuminated with the weight of a typical 12-month-old child in a standard child restraint or less on the front passenger seat.</p>	<p>The system is malfunctioning.</p>	<ul style="list-style-type: none"> ▶ Make sure that there is nothing between seat cushion and child seat and check installation of the child seat. ▶ Make sure that no objects applying supplemental weight onto the seat are present. ▶ Make sure that no objects which apply forces to the seat are present (e.g. objects such as books, brief-cases etc. lodged behind or around the seat, head restraints pushing against roof etc.). The system may recognize such forces as supplemental weight. ▶ If the light remains out, have the system checked as soon as possible by an authorized Mercedes-Benz Center. Do not transport a child on the front passenger seat until the system has been repaired. ▶ Read and observe messages in the multifunction display and follow corrective steps (▷ page 356).

Warning!



If the   indicator lamp does not illuminate or remains out with the weight of a typical 12-month-old child

in a standard child restraint or less on the front passenger seat, do not transport a child on the front passenger seat until the system has been repaired.

Problem	Possible cause/consequence	Suggested solution
<p>(Canada only)</p> <p> </p> <p>The indicator lamp illuminates and remains illuminated (▷ page 76).</p>	<p>A BabySmart™ child seat is installed on the passenger seat. Therefore the passenger front air bag is switched off.</p> <p>The system is malfunctioning when there is no BabySmart™ child seat installed on the passenger seat.</p>	<p>▶ Have the system checked at an authorized Mercedes-Benz Center as soon as possible.</p>
<p>The indicator lamp does not illuminate or does not remain illuminated with a BabySmart™ child seat properly installed on the passenger seat.</p>	<p>The system is malfunctioning.</p>	<p>▶ Make sure there is nothing between seat cushion and child seat.</p> <p>▶ Check installation of the child seat (▷ page 87).</p> <p>If the passenger front air bag off indicator lamp remains out:</p> <p>▶ Have the system checked at an authorized Mercedes-Benz Center as soon as possible.</p> <p>Do not use the BabySmart™ restraint to transport children on the front passenger seat until the system has been repaired.</p>

What to do if ...

Vehicle status messages in the multifunction display





Warning and malfunction messages appear in the multifunction display located in the instrument cluster.





Certain warning and malfunction messages are accompanied by an audible signal.

Address these messages accordingly and follow the additional instructions given in this Operator's Manual.

Selecting the vehicle status message memory menu in the control system (▷ page 141) displays both cleared and unclesared messages.

High-priority messages appear in the multifunction display in red color.

Certain messages of high priority cannot be cleared from the multifunction display using the reset button (▷ page 26) or button , ,  or  on the multifunction steering wheel.

Other messages of high priority and messages of less immediate priority can be cleared from the multifunction display using the reset button or button , ,  or  on the multifunction steering wheel. They are then stored in the vehicle status message memory (▷ page 153). Remember that clearing a message will only make the message disappear. Clearing a message will not correct the condition that caused the message to appear.

Warning!



All categories of messages contain important information which should be taken note of and, where a malfunction is indicated, addressed as soon as possible at an authorized Mercedes-Benz Center.

Failure to repair condition noted may cause damage not covered by the Mercedes-Benz Limited Warranty, or result in property damage or personal injury.

Warning!

No messages will be displayed if either the instrument cluster or the multifunction display is inoperative.

As a result, you will not be able to see information about your driving conditions, such as speed or outside temperature, warning/indicator lamps, malfunction/warning messages or the failure of any systems. Driving characteristics may be impaired.

If you must continue to drive, please do so with added caution. Contact an authorized Mercedes-Benz Center as soon as possible.

i *Switching on the ignition causes all instrument cluster lamps (except high beam headlamp indicator lamp and turn signal indicator lamps unless activated) as well as the multifunction display to come on. Make sure the lamps and multifunction display are in working order before starting your journey.*

On the pages that follow, you will find a compilation of the most important warning and malfunction messages that may appear in the multifunction display.

For your convenience the messages are divided into two sections:

- Text messages (▷ page 358)
- Symbol messages (▷ page 370)

What to do if ...

Text messages

Display message	Possible cause/consequence	Possible solution
<p>ABS</p> <p>ABS, ESP inoperative See Operator's Man.</p>	<p>ABS, ESP[®] as well as PRE-SAFE[®] have switched off due to a malfunction.</p> <p>BAS is also switched off.</p> <p>The brake system is still functioning normally but without the ABS, BAS, ESP[®] and PRE-SAFE[®] available.</p>	<ul style="list-style-type: none"> ▶ Continue driving with added caution. Wheels will lock during hard braking, reducing steering capability. ▶ Have the system checked at an authorized Mercedes-Benz Center as soon as possible. <p>Failure to follow these instructions increases the risk of an accident.</p>
<p>ABS</p> <p>ABS, ESP unavailable See Operator's Man.</p>	<p>ABS, ESP[®] as well as PRE-SAFE[®] are not available due to a malfunction. BAS is also switched off. The system's self-diagnosis may not be completed yet.</p> <p>The brake system is still functioning normally but without ABS, BAS, ESP[®] and PRE-SAFE[®] available.</p>	<ul style="list-style-type: none"> ▶ Drive a short distance with gentle turns above a speed of 12 mph (20 km/h). <p>The message disappears when ABS, BAS, ESP[®] and PRE-SAFE[®] are again available.</p> <p>If the message does not disappear:</p> <ul style="list-style-type: none"> ▶ Continue driving with added caution. Wheels will lock during hard braking, reducing steering capability. ▶ Have the system checked at an authorized Mercedes-Benz Center as soon as possible. <p>Failure to follow these instructions increases the risk of an accident.</p>

Display message	Possible cause/consequence	Possible solution
<p>ABS</p> <p>ABS, ESP unavailable See Operator's Man.</p>	<p>The ABS, ESP® as well as PRE-SAFE® were deactivated because of insufficient power supply. The charging voltage has fallen below 10 volts.</p> <p>The brake system still functions normally but without the ABS, ESP® and PRE-SAFE® available.</p>	<p>When the voltage is above this value again, the ABS, ESP® and PRE-SAFE® are operational again and the message in the multifunction display should disappear.</p> <p>If the message in the multifunction display does not disappear:</p> <ul style="list-style-type: none"> ▶ Have the generator (alternator) and the battery checked.
<p>Cruise control</p> <p>--- mph (USA only) --- km/h (Canada only)</p>	<p>You have tried to switch on cruise control below a speed of 20 mph (30 km/h).</p>	<ul style="list-style-type: none"> ▶ Drive faster than 20 mph (30 km/h) and save the speed.
<p>Distronic</p> <p>--- mph (USA only) --- km/h (Canada only)</p> <p>inoperative</p>	<p>You have tried to switch on Distronic below a speed of 20 mph (30 km/h).</p> <p>The Distronic* is malfunctioning or the display is malfunctioning.</p>	<ul style="list-style-type: none"> ▶ Drive faster than 20 mph (30 km/h) and save the speed. ▶ Contact an authorized Mercedes-Benz Center as soon as possible.

What to do if ...



Display message	Possible cause/consequence	Possible solution
<p>Distronic currently unavailable See Operator's Manual</p>	<p>Distronic* is switched off and is temporarily unavailable.</p> <p>Distronic* is deactivated if:</p> <ul style="list-style-type: none"> • the DISTRONIC* cover in the radiator grille is dirty • its function is impaired by heavy precipitation or fog 	<p>► If necessary, clean the DISTRONIC* cover in the area of the radiator grille (▷ page 336).</p> <p>► Restart the vehicle.</p> <p>or</p> <p>Distronic* becomes operational again without the engine being restarted when:</p> <ul style="list-style-type: none"> • dirt on the radiator grille has fallen off while driving (e.g. slush or snow) • the system recognizes full sensor availability (due to lessening rain or the road surface drying) • the message in the multifunction display disappears • the speed last stored flashes in the display for 5 seconds. <p>You can operate DISTRONIC* as usual again.</p>

Display message	Possible cause/consequence	Possible solution
Distronic currently unavailable See Operator's Manual	Distronic* is deactivated because the functionality is impaired by external interferences, e.g. high-frequency sources such as too stations, speed measuring systems etc.	<ul style="list-style-type: none"> ▶ Leave the area of the external interference. ▶ Activate Distronic* again (▷ page 223) when the message <code>DISTRONIC available</code> again appears.
	Distronic* is deactivated because the Distronic* sensor has not sensed any other vehicles or objects, e.g. road sign or such, for a long time.	<ul style="list-style-type: none"> ▶ Activate Distronic* again (▷ page 223) when the message <code>DISTRONIC available</code> again appears.
ESP inoperative See Operator's Man.	The ESP® as well as BAS and PRE-SAFE® have detected a malfunction and switched off. The ABS may not be operational. The brake system is still functioning normally but without the ABS, BAS, ESP® and PRE-SAFE® available.	<ul style="list-style-type: none"> ▶ Continue driving with added caution. ▶ Have the system checked at an authorized Mercedes-Benz Center as soon as possible. Failure to follow these instructions increases the risk of an accident.

! When synchronizing the ESP®, make sure you can turn the steering wheel in both directions as far as it will go without the wheels hitting any objects, e.g. a road curb.

What to do if ...

Display message	Possible cause/consequence	Possible solution
<p>(USA only) Front passenger airbag enabled See Operator's Manual</p>	<p>Front passenger front air bag is activated while driving even though a child, small individual, or object below the system's weight threshold is on the front passenger seat, or the front passenger seat is empty. Objects on the seat or forces acting on the seat may make the system sense supplemental weight.</p>	<p>Stop the vehicle in a safe location as soon as possible and check the front passenger seat for the following:</p> <ul style="list-style-type: none"> ▶ Apply the parking brake. ▶ Switch off the ignition (▷ page 38). ▶ Open the front passenger door. ▶ Remove child and child restraint from front passenger seat and properly secure the child in rear seat employing the child restraint if necessary. ▶ Remove any other items from on and around the front passenger seat and make sure the storage pocket on the back of the front passenger seat is empty. ▶ Make sure that no objects which apply forces to the seat are present (e.g. objects such as books, briefcases etc. lodged behind or around the seat, head restraints pushing against roof etc.). The system may recognize such forces as supplemental weight and sense that an occupant on the front passenger seat is of a greater weight than actually present. ▶ Keep the seat unoccupied, close the front passenger door and turn on the ignition (▷ page 38). <p>(Continued on next page)</p>

Display message	Possible cause/consequence	Possible solution
		<p>Monitor the PASS AIR BAG OFF  indicator lamp on the center console (▷ page 29) and the multifunction display in the instrument cluster (▷ page 27) for the following:</p> <p>With the seat unoccupied and the ignition turned on,</p> <ul style="list-style-type: none"> the PASS AIR BAG OFF  indicator lamp on the center console should illuminate and remain illuminated, indicating that the OCS (▷ page 71) has deactivated the front passenger front air bag. the message Front passenger airbag enabled See Operator's Manual or the message Front passenger airbag disabled See Operator's Manual should not appear in the multifunction display at any time the seat is unoccupied. Wait at least 60 seconds for the system to complete the necessary check cycles and to make sure neither message appears in the multifunction display. <p>If above conditions are met, you can occupy the front passenger seat again. Depending on the front passenger classification sensed by the OCS (▷ page 71), the PASS AIR BAG OFF  indicator lamp will remain illuminated or go out.</p> <p>If above conditions are not met, the system is not working properly. Have the system checked as soon as possible by an authorized Mercedes-Benz Center.</p>

Warning!





If the **PASS AIR BAG OFF**  indicator lamp

remains out even after performing the above corrective steps, do not have any children 12 years old and under and other small

individuals use the front passenger seat until the system has been repaired.

What to do if ...

Display message	Possible cause/consequence	Possible solution
<p>(USA only) Front passenger airbag disabled See Operator's Manual</p>	<p>Front passenger front air bag is deactivated while driving even though an adult or someone larger than a small individual is occupying the front passenger seat. Forces acting on the seat may make the system sense a decrease in weight.</p>	<p>Stop the vehicle in a safe location as soon as possible and check the front passenger seat for the following:</p> <ul style="list-style-type: none"> ▶ Switch off the ignition (▷ page 60). ▶ Have the front passenger vacate the seat and exit the vehicle. ▶ Adjust the seat in a height position (▷ page 42). ▶ Make sure that no objects which apply forces to the seat are present (e.g. objects such as books, briefcases etc. lodged underneath, behind or around the seat). Such forces may cause the system to sense that an occupant of a lesser weight than actually present is on the front passenger seat. ▶ Keep the seat unoccupied, close the front passenger door and turn on the ignition (▷ page 38). <p>(Continued on next page)</p>

Display message	Possible cause/consequence	Possible solution
		<p>Monitor the PASS AIR BAG OFF  indicator lamp on the center console (▷ page 29) and the multifunction display in the instrument cluster (▷ page 26) for the following:</p> <p>With the seat unoccupied and the ignition turned on,</p> <ul style="list-style-type: none"> the PASS AIR BAG OFF  indicator lamp on the center console should illuminate and remain illuminated, indicating that the OCS (▷ page 71) has deactivated the front passenger front air bag. the message Front passenger airbag enabled See Operator's Manual or the message Front passenger airbag disabled See Operator's Manual should not appear in the multifunction display at any time the seat is unoccupied. Wait at last 60 seconds for the system to complete the necessary check cycles and to make sure neither message appears in the multifunction display. <p>If above conditions are met, you can occupy the front passenger seat again. Depending on the front passenger classification sensed by the OCS (▷ page 71), the PASS AIR BAG OFF  indicator lamp will remain illuminated or go out.</p> <p>If above conditions are not met, the system is not working properly. Have the system checked as soon as possible by an authorized Mercedes-Benz Center.</p>

Warning!



If the **PASS AIR BAG OFF**  indicator lamp

remains illuminated with an adult occupant on the front passenger seat even after performing the above corrective steps,

do not have any passenger use the front passenger seat until the system has been repaired.

What to do if ...

Display message	Possible cause/consequence	Possible solution
P Gear selector lever in Park position	<p>You have tried to start the engine with the KEYLESS-GO* start/stop button with the gear selector lever not in position P.</p> <p>You have tried to turn off the engine with the KEYLESS-GO* start/stop button with the gear selector lever not in position P.</p>	▶ Place the gear selector lever in position P .
P/N Shift gear select. lever to Neutral or Park	You have tried to start the engine with the KEYLESS-GO* start/stop button while the gear selector lever was in position R or D .	▶ Place the gear selector lever in position P or N . Make sure the brake pedal is depressed.
PRE-SAFE inoperative See Operator's Man.	PRE-SAFE® itself has failed. All other occupant safety systems, such as the air bags, are still available.	▶ Contact an authorized Mercedes-Benz Center as soon as possible.

Display message	Possible cause/consequence	Possible solution
Run Flat Indicator inactive	Canada only: Run Flat Indicator is malfunctioning.	▶ Have the Run Flat Indicator checked by an authorized Mercedes-Benz Center.
Check tires Then reactivate Run Flat Indicator	Canada only: There was a warning message about a loss in the tire inflation pressure and the Run Flat Indicator has not been reactivated yet.	▶ Make sure that the correct tire inflation pressure is set for each tire. ▶ Then reactivate the Run Flat Indicator.
Run Flat Indicator unavailable	Canada only: The Run Flat Indicator* has been switched off due to an error.	▶ Have the Run Flat Indicator checked by an authorized Mercedes-Benz Center.
Tire pressure Check tires	Canada only: The Run Flat Indicator indicates that the pressure is too low in one or more tires.	▶ Carefully bring the vehicle to a halt, avoiding abrupt steering and braking maneuvers. Observe the traffic situation around you. ▶ Check and adjust tire inflation pressure as required (▷ page 302). ▶ If necessary, change the wheel (▷ page 412). ▶ Reactivate the Run Flat Indicator after adjusting the tire inflation pressure values (▷ page 305).





What to do if ...





Display message	Possible cause/consequence	Possible solution
Tire pressure displayed only after driving a few minutes	Vehicles with Advanced TPMS*: The tire inflation pressure is being checked.	▶ Drive the vehicle for a few minutes.
Tire pres. monitor currently unavailable	The TPMS or Advanced TPMS* is unable to monitor the tire pressure due to <ul style="list-style-type: none"> • a nearby radio interference source • excessive wheel sensor temperatures 	▶ As soon as the causes for the malfunction are no longer present, the Advanced TPMS* automatically becomes active again after a few minutes driving.
Tire pres. monitor inoperative	The TPMS or Advanced TPMS* is malfunctioning.	▶ Have the TPMS or Advanced TPMS* checked by an authorized Mercedes-Benz Center.

Display message	Possible cause/consequence	Possible solution
Tire pres. monitor inoperative No wheel sensors	There are wheels without appropriate wheel sensors mounted (e.g. winter tires).	<ul style="list-style-type: none"> ▶ Have the TPMS or Advanced TPMS* checked by an authorized Mercedes-Benz Center. ▶ Have the wheel sensors installed by an authorized Mercedes-Benz Center.
Tire pres. monitor Wheel sensor missing	<ul style="list-style-type: none"> • One or more sensors malfunction (e.g. battery is empty). • One or more wheels without appropriate wheel sensors mounted (e.g. spare tire). <p>The tire inflation pressure for the respective tire is not shown in the multifunction display.</p>	<ul style="list-style-type: none"> ▶ Have the TPMS or Advanced TPMS* checked by an authorized Mercedes-Benz Center. ▶ Have the wheel sensors installed by an authorized Mercedes-Benz Center. <p>Vehicles with Advanced TPMS*: The tire pressure for the respective tire is shown in the multifunction display.</p>

What to do if ...







Symbol messages

Display symbol	Display messages	Possible cause/consequence	Possible solution
		You are driving with one or more doors open.	▶ Close the doors.
		You are driving with the hood open.	▶ Close the hood (▷ page 286).
		This message will appear whenever the trunk is open.	▶ Close the trunk.
		<p>The battery is no longer charging.</p> <p>Possible causes:</p> <ul style="list-style-type: none"> • alternator malfunctioning • broken poly-V-belt <p>Do not forget that the brake system requires electrical energy and may be operating with restricted capability. Considerably greater brake pedal force is required and the stopping distance is increased.</p>	<p>▶ Stop immediately in a safe location or as soon as it is safe to do so and check the poly-V-belt.</p> <p>If it is broken:</p> <p>▶ Do not continue to drive. Otherwise the engine will overheat due to an inoperative water pump which may result in damage to the engine. Notify an authorized Mercedes-Benz Center.</p> <p>If it is intact:</p> <p>▶ Drive immediately to the nearest authorized Mercedes-Benz Center. Adjust driving to be consistent with reduced braking responsiveness.</p>

Display symbol	Display messages	Possible cause/consequence	Possible solution
		There is a malfunction in the electronic system.	▶ Have the system checked at an authorized Mercedes-Benz Center as soon as possible.
	Battery/Alternator Stop vehicle	The battery is malfunctioning. The brake system requires electrical energy and therefore has only limited operation. Considerably greater brake pedal force is required and the stopping distance is increased.	▶ Stop the vehicle as soon as it is safe to do so. Adjust driving to be consistent with reduced braking responsiveness. ▶ Call Roadside Assistance. ▶ Notify an authorized Mercedes-Benz Center.
	Low voltage Start engine	The battery has insufficient voltage.	▶ Start the engine (▷ page 51).
	Brakepad wear	The brake pads have reached their wear limit.	▶ Have the brake pads replaced as soon as possible.

! Brake pad thickness must be visually inspected by a qualified technician at the intervals specified in the Maintenance Booklet.

What to do if ...

Display symbol	Display messages	Possible cause/consequence	Possible solution
(USA only)  (Canada only) 	Release parking brake	You are driving with the parking brake set.	▶ Release the parking brake (▷ page 53).
(USA only)  (Canada only) 	EBV, ABS, ESP inoperative See Operator's Man.	ABS, ESP®, EBP as well as PRE-SAFE® have switched off due to a malfunction. BAS is also switched off. The brake system is still functioning normally but without the ABS, BAS, ESP® and PRE-SAFE® available.	▶ Continue driving with added caution. ▶ Adjust driving to be consistent with reduced braking responsiveness. ▶ Contact an authorized Mercedes-Benz Center as soon as possible.
(USA only)  (Canada only) 	Check brake fluid level	There is insufficient brake fluid in the reservoir.	▶ Risk of accident! Stop the vehicle in a safe location and notify an authorized Mercedes-Benz Center. Do not add brake fluid! This will not solve the problem.



Warning!



Driving with the messages **Check brake fluid level** displayed can result in an accident. Have your brake system checked immediately.

Do not add brake fluid before checking the brake system. Overfilling the brake fluid reservoir can result in spilling brake fluid on hot engine parts and the brake fluid catching fire. You can be seriously burned.

! If you find that the brake fluid in the brake fluid reservoir has fallen to the minimum mark or below, have the brake system checked for brake pad thickness and leaks.

Display symbol	Display messages	Possible cause/consequence	Possible solution
(USA only)  (Canada only) 	Visit workshop	There may be a malfunction in the: <ul style="list-style-type: none"> • fuel injection system • ignition system • exhaust system • fuel system 	► Have the measuring system checked by an authorized Mercedes-Benz Center.
	Top up coolant See Operator's Manual	The coolant level is too low.	► Add coolant (▷ page 290). ► If you have to add coolant frequently, have the cooling system checked by an authorized Mercedes-Benz Center.

Warning!



Do not spill antifreeze on hot engine parts. Antifreeze contains ethylene glycol which may burn if it comes into contact with hot engine parts. You could be seriously burned.

! Do not ignore the low engine coolant level warning. Extended driving with the message and symbol displayed may cause serious engine damage not covered by the Mercedes-Benz Limited Warranty.

Do not drive without sufficient amount of coolant in the cooling system. The engine will overheat causing major engine damage.

What to do if ...

Display symbol	Display messages	Possible cause/consequence	Possible solution
	Coolant Stop, turn engine off	The coolant is too hot.	<ul style="list-style-type: none"> ▶ Stop the vehicle in a safe location or as soon as it is safe to do so and immediately turn off the engine. ▶ Only start the engine again after the message disappears. You could otherwise damage the engine. ▶ Apply the parking brake (▷ page 53). ▶ Observe the coolant temperature indicator in the instrument cluster (▷ page 26). <p>If the temperature rises again:</p> <ul style="list-style-type: none"> ▶ Contact an authorized Mercedes-Benz Center immediately.

Warning!



Driving when your engine is badly overheated can cause some fluids which may have leaked into the engine compartment to catch fire. You could be seriously burned.

Steam from an overheated engine can cause serious burns and can occur just by opening

the engine hood. Stay away from the engine if you see or hear steam coming from it.



Stop the vehicle in a safe location away from other traffic. Turn off the engine, get out of the vehicle and do not stand near the vehicle until the engine has cooled down.

During severe operation conditions and stop-and-go city traffic, the coolant temperature may rise close to 248°F (120°C).

! *The engine should not be operated with the coolant temperature above 248°F (120°C). Doing so may cause serious damage which is not covered by the Mercedes-Benz Limited Warranty.*

Display symbol	Display messages	Possible cause/consequence	Possible solution
	<p>Coolant Stop, turn engine off</p>	<p>The poly-V-belt could be broken.</p>	<ul style="list-style-type: none"> ▶ Stop the vehicle in a safe location and immediately turn off the engine. ▶ Check the poly-V-belt. <p>If it is broken:</p> <ul style="list-style-type: none"> ▶ Do not continue to drive. Otherwise the engine will overheat due to an inoperative water pump which may result in damage to the engine. Notify an authorized Mercedes-Benz Center. <p>If it is intact:</p> <ul style="list-style-type: none"> ▶ Do not continue to drive the vehicle with this message displayed. Doing so could result in serious engine damage that is not covered by the Mercedes-Benz Warranty. ▶ Observe the coolant temperature indicator in the instrument cluster (▷ page 26). ▶ Drive immediately to the nearest authorized Mercedes-Benz Center.

What to do if ...

Display symbol	Display messages	Possible cause/consequence	Possible solution
		The cooling fan for the coolant is malfunctioning.	<ul style="list-style-type: none"> ▶ Observe the coolant temperature indicator in the instrument cluster (▷ page 26). If the coolant temperature is under 120°C, you may continue driving to an authorized Mercedes-Benz Center. ▶ Avoid placing heavy loads on the engine (e.g. by driving uphill) as well as stop-and-go traffic. ▶ Have the fan replaced as soon as possible.
	Display malfunction Visit workshop	<p>Certain electronic systems are unable to relay information to the control system. The following systems may have failed:</p> <ul style="list-style-type: none"> • Coolant temperature display • Tachometer • Cruise control display 	<ul style="list-style-type: none"> ▶ Have the electronic systems checked by an authorized Mercedes-Benz Center.
	Engine Service	<p>There may be a malfunction in:</p> <ul style="list-style-type: none"> • the fuel injection system • the ignition system • the exhaust system 	<ul style="list-style-type: none"> ▶ Have the engine checked as soon as possible by an authorized Mercedes-Benz Center.

Display symbol	Display messages	Possible cause/consequence	Possible solution
	Check oil level at next refueling	There is no oil in the engine. There is a danger of engine damage.	<ul style="list-style-type: none"> ▶ Check the engine oil level (▷ page 288) and add engine oil as required (▷ page 289). ▶ If you must add engine oil frequently, have the engine checked for possible leaks.





When the Check oil level - at next refueling message appears while the engine is running and at operating temperature, the engine oil level has dropped to approximately the minimum level.

When this occurs, the warning will first come on intermittently and then stay on if the oil level drops further.

If no oil leaks are noted, continue to drive to the nearest service station where the engine oil should be topped to the required level with an approved engine oil. For information on approved engine oils, refer to the Factory Approved Service Products pamphlet (USA only) or contact an authorized Mercedes-Benz Center.



! *The engine oil level warnings should not be ignored. Extended driving with the symbol displayed could result in serious engine damage that is not covered by the Mercedes-Benz Limited Warranty.*

What to do if ...

Display symbol	Display messages	Possible cause/consequence	Possible solution
	Reserve fuel	The fuel level has dropped below the reserve mark.	▶ Refuel at the next gas station (▷ page 283).
	Gas cap is open	A loss of pressure has been detected in the fuel system. The fuel cap may not be closed properly or the fuel system may be leaky.	▶ Check the fuel cap (▷ page 283). If it is not closed properly: ▶ Close the fuel cap. If it is closed properly: ▶ Have the fuel system checked by an authorized Mercedes-Benz Center.
	Replace air cleaner	The air cleaner is clogged.	▶ Have the air cleaner checked by an authorized Mercedes-Benz Center.
	Remove key	You have forgotten to remove the SmartKey.	▶ Remove the SmartKey from the starter switch.
	Get a new key	The SmartKey is malfunctioning.	▶ Contact an authorized Mercedes-Benz Center.
	Key still in vehicle	A SmartKey with KEYLESS-GO* left in the vehicle was recognized while locking the vehicle from the outside.	▶ Take the SmartKey with KEYLESS-GO* out of the vehicle.

Display symbol	Display messages	Possible cause/consequence	Possible solution
	Please don't forget your key	This display appears (for a maximum of 60 seconds) if the driver's door is opened with the engine turned off and no SmartKey in the starter switch. This message is only a reminder.	▶ Take the SmartKey or SmartKey with KEYLESS-GO* with you when leaving the vehicle.
	Change key batteries	The SmartKey with KEYLESS-GO* batteries are discharged.	▶ Replace the batteries (▷ page 402).
	Key not recognized	The SmartKey with KEYLESS-GO* is not recognized while the engine is running because <ul style="list-style-type: none"> • the SmartKey with KEYLESS-GO* is not in the vehicle • there is strong radio-frequency interference 	▶ Stop the vehicle as soon as it is safe to do so. ▶ Search for the SmartKey. Otherwise the vehicle cannot be centrally locked nor can the engine be started again after the engine is stopped.
	Key not recognized	The SmartKey with KEYLESS-GO* is momentarily not recognized.	▶ Change the position of the SmartKey in the vehicle. ▶ Operate the vehicle with the SmartKey in the starter switch if necessary.

What to do if ...

Display symbol	Display messages	Possible cause/consequence	Possible solution
	Change key batteries	The SmartKey with KEYLESS-GO* batteries are discharged.	▶ Replace the batteries (▷ page 402).
	Key not detected	The SmartKey with KEYLESS-GO* is not recognized while the engine is running because <ul style="list-style-type: none"> • the SmartKey with KEYLESS-GO* is not in the vehicle • there is strong radio-frequency interference 	▶ Stop the vehicle as soon as it is safe to do so. ▶ Search for the SmartKey. Otherwise the vehicle cannot be centrally locked nor can the engine be started again after the engine is stopped.
	Key not detected	The SmartKey with KEYLESS-GO* is momentarily not recognized.	▶ Change the position of the SmartKey in the vehicle. ▶ Operate the vehicle with the SmartKey in the starter switch if necessary.
	Active headlamps inoperative	The active Bi-Xenon* headlamp system is malfunctioning.	▶ Contact an authorized Mercedes-Benz Center as soon as possible.
	Active headlamps	The active Bi-Xenon* headlamps are malfunctioning.	▶ Contact an authorized Mercedes-Benz Center as soon as possible.

Display symbol	Display messages	Possible cause/consequence	Possible solution
	Reverse lamp left side	The left reverse lamp is malfunctioning.	▶ Contact an authorized Mercedes-Benz Center as soon as possible.
	Reverse lamp right side	The right reverse lamp is malfunctioning.	▶ Contact an authorized Mercedes-Benz Center as soon as possible.
	Brake-/tail lamp, left Auxiliary bulb on	The left brake/tail lamp is malfunctioning. This message will only appear if a critical number of LEDs have stopped working. An auxiliary bulb is being used.	▶ Contact an authorized Mercedes-Benz Center as soon as possible.
	Brake-/tail lamp, right Auxiliary bulb on	The right brake/tail lamp is malfunctioning. This message will only appear if a critical number of LEDs have stopped working. An auxiliary bulb is being used.	▶ Contact an authorized Mercedes-Benz Center as soon as possible.
	3rd brake lamp	The high mounted brake lamp is malfunctioning.	▶ Contact an authorized Mercedes-Benz Center as soon as possible.
	Front foglamp left side	The left front fog lamp is malfunctioning.	▶ Contact an authorized Mercedes-Benz Center as soon as possible.
	Front foglamp right side	The right front fog lamp is malfunctioning.	▶ Contact an authorized Mercedes-Benz Center as soon as possible.

What to do if ...

Display symbol	Display messages	Possible cause/consequence	Possible solution
	Front left marker lamp	The front left side marker lamp is malfunctioning.	▶ Contact an authorized Mercedes-Benz Center as soon as possible.
	Front right marker lamp	The front right side marker lamp is malfunctioning.	▶ Contact an authorized Mercedes-Benz Center as soon as possible.
	Front left park. lamp Auxiliary bulb on	The left front parking lamp is malfunctioning. An auxiliary bulb is being used.	Halogen headlamp: ▶ Replace the bulb as soon as possible (▷ page 404). Bi-Xenon* headlamp: ▶ Contact an authorized Mercedes-Benz Center as soon as possible.
	Front right park. lamp Auxiliary bulb on	The right front parking lamp is malfunctioning. An auxiliary bulb is being used.	Halogen headlamp: ▶ Replace the bulb as soon as possible (▷ page 404). Bi-Xenon* headlamp: ▶ Contact an authorized Mercedes-Benz Center as soon as possible.
	High beam left side	The left high beam lamp is malfunctioning.	▶ Replace the bulb as soon as possible (▷ page 404).
	High beam right side	The right high beam lamp is malfunctioning.	▶ Replace the bulb as soon as possible (▷ page 404).



Display symbol	Display messages	Possible cause/consequence	Possible solution
	License plate lamp left side	The left license plate lamp is malfunctioning.	▶ Replace the bulb as soon as possible (▷ page 404).
	License plate lamp right side	The right license plate lamp is malfunctioning.	▶ Replace the bulb as soon as possible (▷ page 404).
	AUTO-Light inoperative	The light sensor is malfunctioning. The headlamps switch on automatically.	▶ In the control system, set lamp operation to manual mode (▷ page 161). ▶ Switch on headlamps using the exterior lamp switch.
	Low beam left side	The left low beam lamp is malfunctioning.	Halogen headlamp: ▶ Replace the bulb as soon as possible (▷ page 404). Bi-Xenon* headlamp: ▶ Contact an authorized Mercedes-Benz Center as soon as possible.
	Low beam right side	The right low beam lamp is malfunctioning.	Halogen headlamp: ▶ Replace the bulb as soon as possible. Bi-Xenon* headlamp: ▶ Contact an authorized Mercedes-Benz Center as soon as possible.

What to do if ...

Display symbol	Display messages	Possible cause/consequence	Possible solution
	Rear left foglamp	The left rear fog lamp is malfunctioning.	▶ Contact an authorized Mercedes-Benz Center as soon as possible.
	Rear right foglamp	The right rear fog lamp is malfunctioning.	▶ Contact an authorized Mercedes-Benz Center as soon as possible.
	Switch off lights	You have removed the SmartKey from the starter switch, opened the driver's door and left the headlamps on or removed the SmartKey with KEYLESS-GO* from the vehicle and left the headlamps on.	▶ Switch off the headlamps.
	Switch off lights or remove key	The exterior lamp switch is set to AUTO and you have forgotten to take out the SmartKey. The parking lamps remain switched on.	▶ Switch off the headlamps (▷ page 128). or ▶ Remove the SmartKey from the starter switch.
	Tail lamp, left side Auxiliary bulb on	The left tail lamp is malfunctioning. An auxiliary bulb is being used.	▶ Contact an authorized Mercedes-Benz Center as soon as possible.
	Tail lamp, right side Auxiliary bulb on	The right tail lamp is malfunctioning. An auxiliary bulb is being used.	▶ Contact an authorized Mercedes-Benz Center as soon as possible.

Display symbol	Display messages	Possible cause/consequence	Possible solution
	Cornering lamp left	The left corner-illuminating front fog lamp* is malfunctioning.	▶ Contact an authorized Mercedes-Benz Center as soon as possible.
	Cornering lamp right	The right corner-illuminating front fog lamp* is malfunctioning.	▶ Contact an authorized Mercedes-Benz Center as soon as possible.
	Rear right left signal	The left rear turn signal lamp is malfunctioning.	▶ Contact an authorized Mercedes-Benz Center as soon as possible.
	Rear right turn signal	The right rear turn signal lamp is malfunctioning.	▶ Contact an authorized Mercedes-Benz Center as soon as possible.
	Front left turn signal	The left front turn signal lamp is malfunctioning.	▶ Replace the bulb as soon as possible (▷ page 404).
	Front right turn signal	The right front turn signal lamp is malfunctioning.	▶ Replace the bulb as soon as possible (▷ page 404).
	Left mirror turn signal	The turn signal in the left exterior rear view mirror is malfunctioning. This message will only appear if a critical number of LEDs have stopped working.	▶ Contact an authorized Mercedes-Benz Center as soon as possible.

What to do if ...

Display symbol	Display messages	Possible cause/consequence	Possible solution
	Right mirror turn signal	The turn signal in the right exterior rear view mirror is malfunctioning. This message will only appear if a critical number of LEDs have stopped working.	▶ Contact an authorized Mercedes-Benz Center as soon as possible.
	Tele Aid inoperative	One or more main functions of the Tele Aid system are malfunctioning.	▶ Have the Tele Aid system checked by an authorized Mercedes-Benz Center.
	Tele Aid battery	The emergency power battery for the Tele Aid system is malfunctioning. If the vehicle battery is also dead, Tele Aid will not be operational.	▶ Have the Tele Aid system checked by an authorized Mercedes-Benz Center.
	Restraint system malfunction Visit workshop	The system is malfunctioning.	▶ Drive with added caution to the nearest authorized Mercedes-Benz Center.

Warning!



In the event a malfunction of the SRS is indicated as outlined above, the SRS may not be operational.

For your safety, we strongly recommend that you contact an authorized Mercedes-Benz Center immediately

to have the system checked; otherwise the SRS may not be activated when needed in an accident, which could result in serious or fatal injury, or it might deploy unexpectedly and unnecessarily which could also result in injury.

Display symbol	Display messages	Possible cause/consequence	Possible solution
	Caution Tire defect	One or more tires are deflating. The respective tire is shown in the multifunction display.	<ul style="list-style-type: none"> ▶ Carefully bring the vehicle to a halt, avoiding abrupt steering and braking maneuvers. ▶ If necessary, change the wheel (▷ page 412). ▶ Have the damaged wheel repaired or replaced at an authorized Mercedes-Benz Center.
	Check tires	Vehicles with Advanced TPMS*: The tire pressure in one or more tires is already below the minimum value. The respective tire is shown in the multifunction display.	<ul style="list-style-type: none"> ▶ Carefully bring the vehicle to a halt, avoiding abrupt steering and braking maneuvers. ▶ Check and adjust tire pressure as required. ▶ If necessary, change the wheel (▷ page 412). ▶ Have the damaged wheel repaired or replaced at an authorized Mercedes-Benz Center.

Warning!



Do not drive with a flat tire. A flat tire affects the ability to steer or brake the vehicle.

You may lose control of the vehicle. Continued driving with a flat tire will cause excessive heat build-up and possibly a fire.

What to do if ...





Display symbol	Display messages	Possible cause/consequence	Possible solution
	Please rectify tire pressure	The pressure is too low in one or more tires.	▶ Check and correct tire inflation pressure as required (▷ page 302).
	Tire pressure Caution, tire defect	One or more tires are deflating.	▶ Carefully bring the vehicle to a halt, avoiding abrupt steering and braking maneuvers. ▶ If necessary, change the wheel (▷ page 412). ▶ Have the damaged wheel repaired or replaced at an authorized Mercedes-Benz Center.
	Tire pressure Check tires	Vehicles with Advanced TPMS*: The tire pressure in one or more tires is already below the minimum value.	▶ Carefully bring the vehicle to a halt, avoiding abrupt steering and braking maneuvers. ▶ Check and adjust tire pressure as required. ▶ If necessary, change the wheel (▷ page 412). ▶ Have the damaged wheel repaired or replaced at an authorized Mercedes-Benz Center.

Warning!



Do not drive with a flat tire. A flat tire affects the ability to steer or brake the vehicle.

You may lose control of the vehicle. Continued driving with a flat tire will cause excessive heat build-up and possibly a fire.

Display symbol	Display messages	Possible cause/consequence	Possible solution
	Function unavailable	This display appears if button  or  on the multifunction steering wheel is pressed and the vehicle is not equipped with a telephone.	
	Top up washer fluid	The fluid level has dropped to about $\frac{1}{3}$ of total reservoir capacity.	▶ Add washer fluid (▷ page 292).
	Vehicle rising	Your vehicle is adjusting to your level selection.	
	Vehicle rising Please wait	The vehicle level is too low.	▶ Do not drive off. The Airmatic has not yet adjusted the vehicle level to the necessary height required for driving. ▶ Wait until the message disappears from the multifunction display. You may then drive off.

What to do if ...

Display symbol	Display messages	Possible cause/consequence	Possible solution
	STOP, car too low	The Airmatic* is malfunctioning.	<p>Avoid excessive steering input. The fender or tires could otherwise be damaged. Listen for scraping noises.</p> <ul style="list-style-type: none"> ▶ Do not drive faster than 50 mph (80 km/h). ▶ Drive to the side of the road and select a higher vehicle level (▷ page 232). <p>Depending on the type of malfunction, this may raise the vehicle's level.</p> <ul style="list-style-type: none"> ▶ Contact an authorized Mercedes-Benz Center as soon as possible. <p>There is otherwise danger of an accident.</p>
	Malfunction	<p>The system display or the system is malfunctioning.</p> <p>The system is functional only to a limited extent.</p>	<ul style="list-style-type: none"> ▶ Do not drive faster than 50 mph (80 km/h). ▶ Have the vehicle checked at an authorized Mercedes-Benz Center.

▼ **Where will I find...?**

First aid kit

The first aid kit is in the storage compartment at the front edge of the front passenger seat.

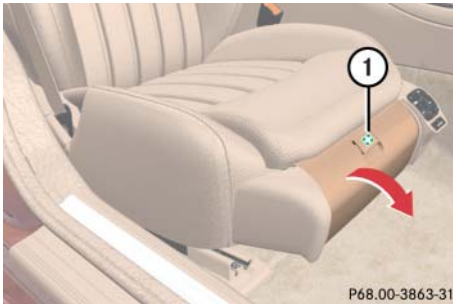

① Tab

- ▶ Pull tab ① upward.
- ▶ Fold the covering forward.
- ▶ Remove the first aid kit.

i Check expiration dates and contents for completeness at least once a year and replace missing/expired items.

Spare wheel

The spare wheel is located under the trunk floor.

- ▶ Lift the trunk floor and engage the handle in the upper edge of trunk.
- ▶ Remove the luggage box (▶ page 395).

Minispare wheel (CLS 550 only)



- ① Vehicle tool kit
- ② Minispare wheel
- ③ Luggage bowl

Removing the Minispare wheel

- ▶ Turn luggage bowl ③ counterclockwise.
- ▶ Remove Minispare wheel ②.

Storing the Minispare wheel after use

- ▶ Place Minispare wheel ② in wheel well.
- ▶ Turn luggage bowl clockwise to its stop to secure the Minispare wheel.

! Always lower trunk floor before closing the trunk.

Where will I find...?

Collapsible tire (CLS 63 AMG only)

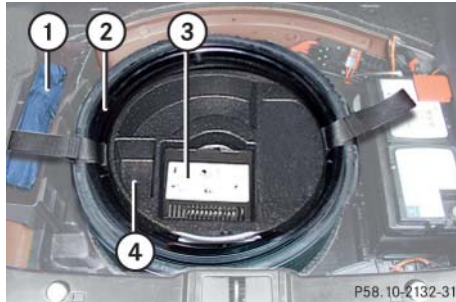

- ① Vehicle tool kit
- ② Collapsible tire
- ③ Electric air pump
- ④ Storage well casing

Removing the collapsible tire

- ▶ Remove storage well casing that contains the vehicle tool kit and the electric air pump.

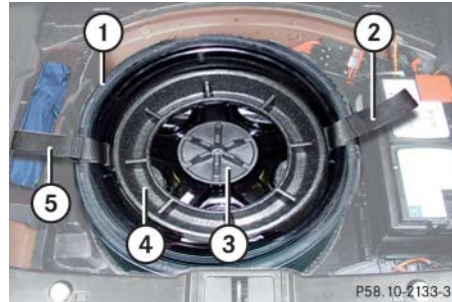

- ① Collapsible tire
 - ② Tensioning strap (vehicles with 19" collapsible tire only)
 - ③ Retaining screw
 - ④ Storage well casing base
 - ⑤ Tensioning strap (vehicles with 19" collapsible tire only)
- ▶ Remove storage well casing base ④.
 - ▶ Remove retaining screw ③ by turning it counterclockwise.

- ▶ Remove collapsible tire ①.

Storing the collapsible tire after use

If you wish to store the collapsible tire after use, carry out the following steps. Otherwise, the collapsible tire may not fit the spare wheel well.

! Make sure the collapsible tire is dry before storing it.

- ▶ Unscrew the valve cap from the valve of the collapsible tire.
 - ▶ Take the valve extractor from the vehicle tool kit (▷ page 393).
 - ▶ Unscrew the valve insert from the valve and allow the air to escape.
- i** It may take a few minutes for the collapsible tire to deflate completely.
- ▶ Screw the valve insert back into the valve.
 - ▶ Screw the valve cap back onto the valve.

i Vehicles with 19" collapsible tire only: Before storing the collapsible tire in trunk fasten tensioning straps, see "Compressing the collapsible tire (CLS 63 AMG with Performance Package* only)" (▷ page 393).

- ▶ Store the collapsible tire by carrying out the steps described in "Removing the collapsible tire" (▷ page 392) in reverse order.

! Always lower trunk floor before closing the trunk.

i The electrical air pump is located in the storage well casing (▷ page 392).

Compressing the collapsible tire (CLS 63 AMG with Performance Package* only)

The 19" collapsible tire must be compressed with two tensioning straps before you can store it back in the trunk.

i The tensioning straps are shown in red for illustration purposes. The tensioning straps on the spare wheel of your vehicle are black.

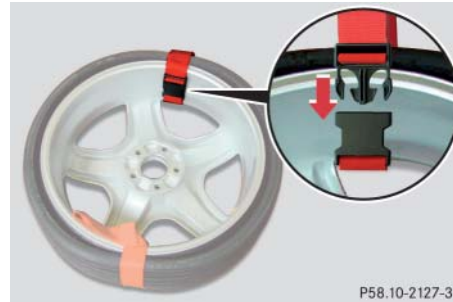

- ▶ Extend the tensioning strap by pulling the slider.
- ▶ Place tensioning strap around spare wheel rim and collapsible tire with the buckle facing the inside of the rim.
- ▶ Close the buckle.
- ▶ Pull the loose end of the tensioning strap.

The tensioning strap must be pulled as tight as possible.

Vehicle tool kit

The vehicle tool kit is stored in the compartment underneath the trunk floor (▷ page 391).

The vehicle tool kit includes:

- One pair of universal pliers
- One towing eye bolt
- One wheel wrench
- One alignment bolt
- One fuse extractor
- One collapsible wheel chock
- Spare fuses

Where will I find...?

Vehicle jack

Warning!



The jack is designed exclusively for jacking up the vehicle at the jack take-up brackets built into both sides of the vehicle. To help avoid personal injury, use the jack only to lift the vehicle during a wheel change. Never get beneath the vehicle while it is supported by the jack. Keep hands and feet away from the area under the lifted vehicle. Always firmly set parking brake and block wheels before raising vehicle with jack.

Do not disengage parking brake while the vehicle is raised. Be certain that the jack is always vertical (plumb line) when in use, especially on hills. Always try to use the jack on a level surface. Make sure the jack arm is fully seated in the jack take-up bracket. Always lower the vehicle onto sufficient capacity jackstands before working under the vehicle.

The vehicle jack is located in the storage compartment underneath the trunk floor.

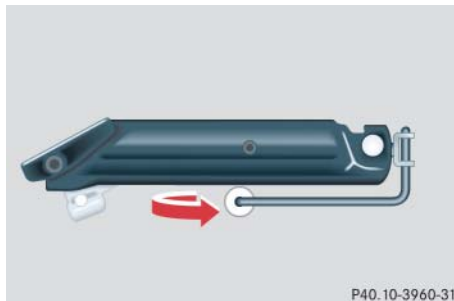

P40.10-3960-31

Storage position

- ▶ Remove vehicle jack from its compartment.
- ▶ Turn crank handle in direction of arrow as far as it will go.

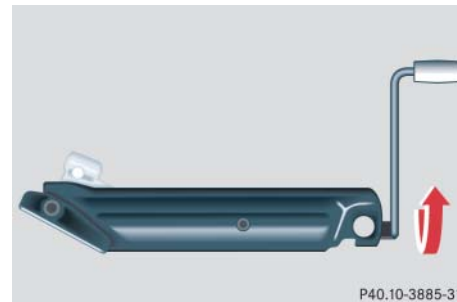

P40.10-3885-31

Operational position

- ▶ Turn crank handle clockwise.

Before storing the vehicle jack in its compartment:

- It should be fully collapsed.
- The handle must be folded in (storage position).

Setting up the collapsible wheel chock

The collapsible wheel chock serves to additionally secure the vehicle, e.g. while changing the wheel.

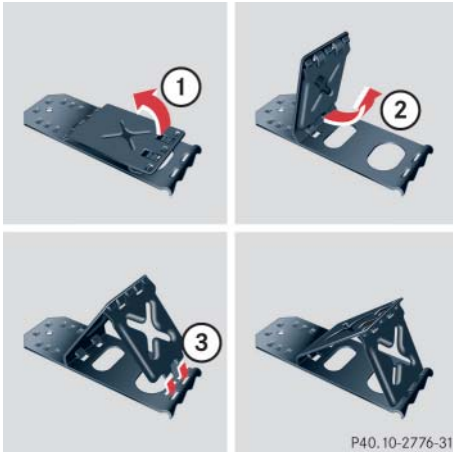

- ① Tilt the plate upward
- ② Fold the lower plate outward
- ③ Insert the plate

- ▶ Tilt both plates upward ①.
- ▶ Fold the lower plate outward ②.
- ▶ Guide the tabs of the lower plate all the way into the openings of the base plate ③.

For information on where to place wheel chocks when changing a wheel, see “Lifting the vehicle” (> page 413).

Luggage box

Remove luggage box

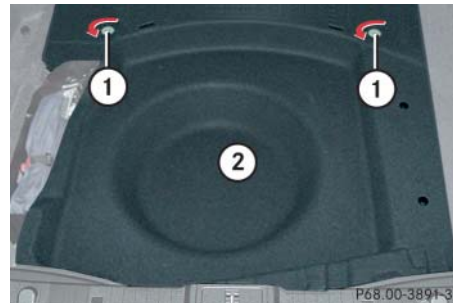

- ① Fastening clip
- ② Luggage box

- ▶ Turn fastening clips ① to the left upwards from fastening bolts.
- ▶ Lift luggage box in the area of the fastening bolts and remove it from trunk.

Install luggage box



- ▶ Insert luggage box into trunk so that fastening clips are in line with fastening bolts.
- ▶ Push front edge of luggage box in direction of arrow under cover of trunk sill.
- ▶ Press fastening clips onto fastening bolts until they lock into place.

Unlocking/locking in an emergency

Unlocking the vehicle

If you cannot unlock the vehicle with the SmartKey or KEYLESS-GO*, unlock the driver's door and the trunk using the mechanical key.

i *Unlocking your vehicle with the mechanical key and opening the driver's door or the trunk will trigger the anti-theft alarm system.*

To cancel the alarm, Insert the SmartKey or SmartKey with KEYLESS-GO in the starter switch.*

Removing the mechanical key

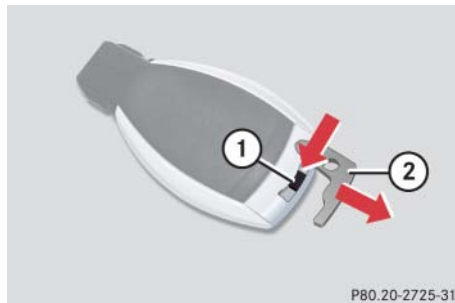

① Mechanical key locking tab

② Mechanical key

- ▶ Move locking tab ① in direction of arrow.
- ▶ Slide mechanical key ② out of the housing.

Unlocking the driver's door

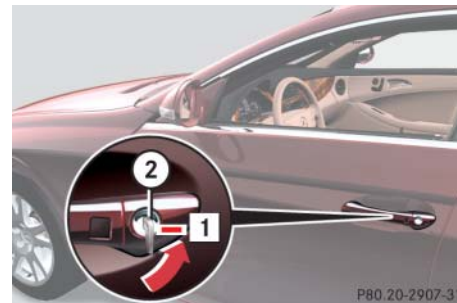

1 Unlocking

② Mechanical key

- ▶ Insert mechanical key ② into the driver's door lock until it stops.
- ▶ Turn mechanical key ② counterclockwise to position 1 until the locking knob moves up.
The driver's door is unlocked.
- ▶ Pull the door handle to open the driver's door.

Unlocking/locking in an emergency

Unlocking the trunk

A minimum height clearance of 5.90 ft (1.80 m) is required to open the trunk lid.

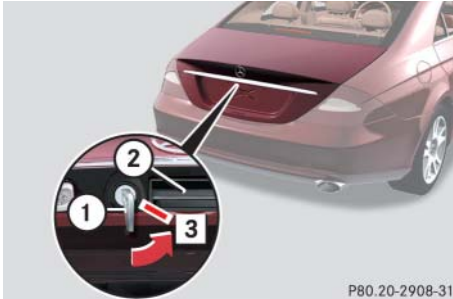

- ① Mechanical key
- ② Handle
- 3 Unlocking in an emergency

- ▶ Insert the mechanical key into the trunk lid lock until it stops.
- ▶ Turn the mechanical key ① counter-clockwise to position 3 and hold it in this position.

- ▶ Pull the handle ② and lift the trunk lid.

The trunk opens.

- ▶ **!** Always make sure there is sufficient overhead clearance.
- ▶ Turn the mechanical key back and remove it from the trunk lid lock.

Locking the vehicle

If you cannot lock the vehicle with the SmartKey or SmartKey with KEYLESS-GO*, do the following:

- ▶ Close the passenger door, the rear doors and the trunk.
- ▶ Press the central locking switch in the center console (▷ page 118).
- ▶ Check to see whether the locking knobs on the doors have moved down.
- ▶ If necessary, push them down manually.
- ▶ Remove the mechanical key out of the SmartKey (▷ page 396).
- ▶ Check whether the trunk is locked.
- ▶ If necessary, lock the trunk with the mechanical key (▷ page 117).

Except for the driver's door, the vehicle should now be locked.



Unlocking/locking in an emergency

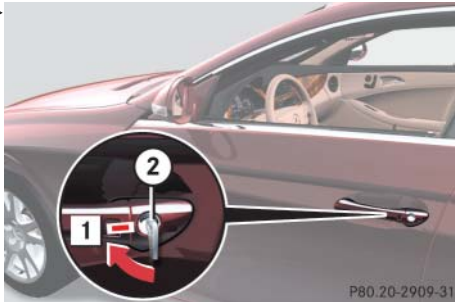

1 Locking

② Mechanical key

- ▶ Insert the mechanical key ② into the driver's door lock until it stops.
- ▶ Turn the mechanical key clockwise to position 1.

The driver's door is locked.

i This procedure does not arm the anti-theft alarm system, nor does it lock the fuel filler flap.

Fuel filler flap emergency release

In case the central locking system does not release the fuel filler flap, you can open it manually.

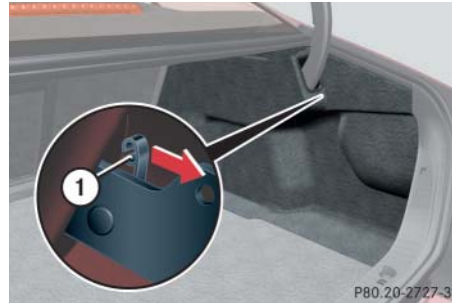

① Release knob

- ▶ Open trunk.
- ▶ Remove right-side tail trim.
- ▶ Pull release knob ① in the direction of arrow.

The fuel filler flap can now be opened.

Manually unlocking the gear selector lever

In case of power failure, the gear selector lever can be manually unlocked, e.g. to tow the vehicle.



① Selector lever cover

② Release

- ▶ Insert flat, blunt object (e.g. screwdriver) into the left edge of cover ① at the position indicated by the arrows.
- ▶ Loosen cover ① using this object.
- ▶ Using your hands, pull cover ① out and remove.
- ▶ Push down and hold release ② in direction of arrow.
- ▶ Simultaneously move gear selector lever out of position **P**.

The gear selector lever is unlocked now.

i *The gear selector lever is locked again as soon as you place it in position **P** again.*

Opening/closing in an emergency

Power tilt/sliding sunroof

You can open or close the tilt/sliding sunroof manually should an electrical malfunction occur.

The tilt/sliding sunroof drive is located behind lens ① of the interior overhead light.

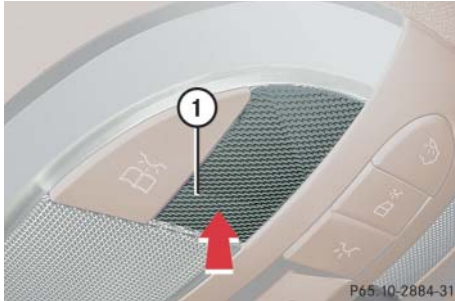

① Cover

- ▶ Remove the SmartKey from the starter switch.
- ▶ Press on cover ① in direction of the arrow to release it.

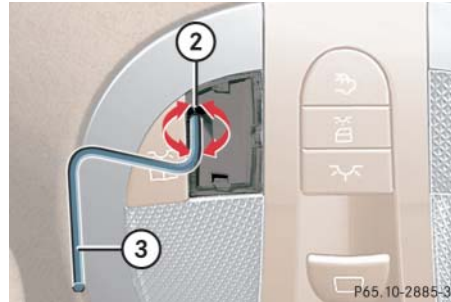

② Hole

③ Crank

- ▶ Take crank ③ out of the glove box.
- ▶ Insert crank ③ through hole ②.
- ▶ Turn crank ③ clockwise to:
 - slide roof panel/sunroof closed
 - raise roof panel/sunroof at the rear
- ▶ Turn crank ③ counterclockwise to:
 - slide roof panel/sunroof open
 - lower roof panel/sunroof at the rear

i Turn crank ③ slowly and smoothly.

The tilt/sliding sunroof must be synchronized after being operated manually (▷ page 214).

Resetting activated head restraints

▼ Resetting activated head restraints

If the active head restraint have been triggered in an accident, the head restraints must be reset. Otherwise, active head restraint cannot offer any additional protection in the event of another rear-end collision.

You can tell that the head restraints have been activated when they have been moved forward and cannot be adjusted.

i For your convenience, we recommend that you have this work carried out by an authorized Mercedes-Benz Center.

You will find the reset tool for manually operating the head restraints in the Mercedes-Benz vehicle literature pouch.

Warning!



For safety reasons, have the active head restraints checked by an authorized Mercedes-Benz Center after a rear-end collision.

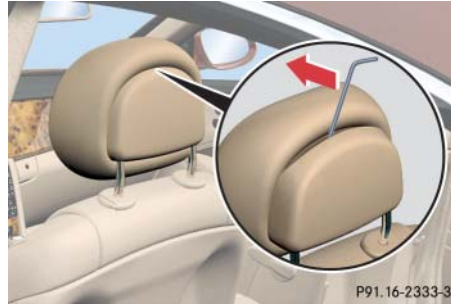

- ▶ Take the reset tool out of the Mercedes-Benz vehicle literature pouch.
- ▶ Guide reset tool into center of head restraint between head restraint cushion and rear head restraint cover.

! Be careful not to damage upholstery.

- ▶ Press reset tool forward in direction of arrow.
- ▶ Press reset tool downward until you hear the head restraint release mechanism audibly engage.
- ▶ Pull out reset tool.
- ▶ Firmly press head restraint cushion backward towards rear head restraint cover until it engages.

Warning!



When pushing back the head restraint cushion, take care that your fingers do not become caught between the head restraint cushion and the cover. Failing to do so may lead to injury.

- ▶ Repeat this procedure for second head restraint.

For information on head restraint adjustment, see “Seats” (▷ page 41).

Replacing SmartKey batteries

If the batteries in the SmartKey/SmartKey with KEYLESS-GO* are discharged, the vehicle can no longer be locked or unlocked. It is recommended to have the batteries replaced at an authorized Mercedes-Benz Center.

Warning!



Batteries contain poisonous and corrosive substances. Therefore keep the batteries out of reach of children.

If a battery is swallowed, seek medical help immediately.

Batteries contain materials that can harm the environment if disposed of improperly. Recycling of batteries is the preferred method of disposal. Many states require sellers of batteries to accept old batteries for recycling.

i When inserting the batteries, make sure they are clean and free of lint.

i When changing batteries, always replace both batteries.

The required replacement batteries are available at any authorized Mercedes-Benz Center.

SmartKey/SmartKey with KEYLESS-GO*

Replacement batteries: Lithium, type CR 2025 or equivalent.

- ▶ Remove the mechanical key out of the SmartKey/SmartKey with KEYLESS-GO* (> page 396).

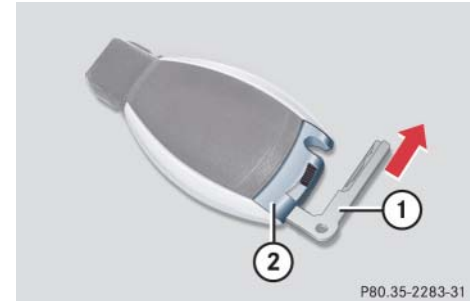

- ① Mechanical key
- ② Battery compartment

- ▶ Insert mechanical key ① into opening.
- ▶ Press mechanical key ① in direction of arrow.

The battery compartment is unlatched.

Replacing SmartKey batteries

- ▶ Pull battery compartment ② out of the housing.

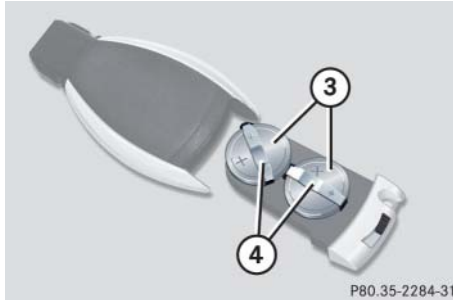

- ③ Batteries
- ④ Contact springs

- ▶ Pull out batteries ③.

- ▶ Using a line-free cloth, insert new batteries ③ under contact springs ④ with the positive terminal (+) side facing up.
- ▶ Return battery compartment ② (▷ page 402) into housing until it locks into place.
- ▶ Slide the mechanical key back into the SmartKey/SmartKey with KEYLESS-GO*.
- ▶ Check the operation of the SmartKey/SmartKey with KEYLESS-GO*.

Replacing bulbs

Bulbs

Safe vehicle operation depends on proper exterior lighting and signaling. It is therefore essential that all bulbs and lamp assemblies are in good working order at all times.

Correct headlamp adjustment is extremely important. Have headlamps checked and readjusted at regular intervals and when a bulb has been replaced. See your authorized Mercedes-Benz Center for headlamp adjustment.

i *If the headlamps or front fog lamps are fogged up on the inside as a result of high humidity, driving the vehicle a distance with the lights on should clear up the fogging.*

i *Auxiliary bulbs will be brought into use when lamps malfunction. Read and observe the messages in the multifunction display (▷ page 380).*

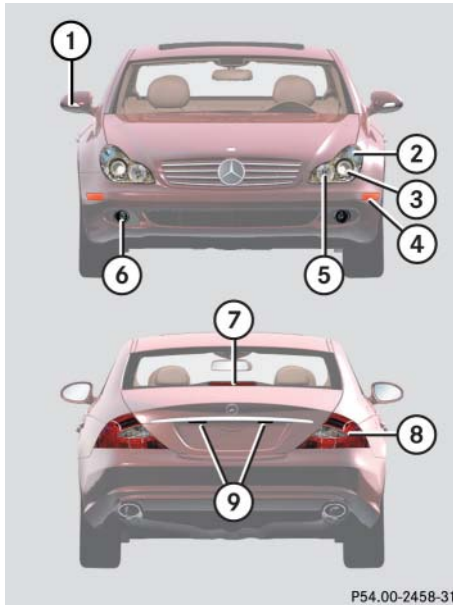

P54.00-2458-31

Front lamps

	Lamp	Type
①	Additional turn signal lamps	LED
②	Turn signal lamp	3457 AK
③	Halogen headlamps: Low beam	H7 (55 W)
	Bi-Xenon* headlamps: Low and high beam ¹	D2S-35 W
④	Side marker lamp	W 5 W

¹ Vehicles with Bi-Xenon* headlamps: Low beam and high beam use the same D2S-35W lamp. Do not replace the Bi-Xenon bulbs yourself. Contact your authorized Mercedes-Benz Center.

	Lamp	Type
⑤	Halogen headlamps: High beam/high beam flasher	H7 (55 W)
	Bi-Xenon* headlamps: High beam flasher	H7 (55 W)
	Halogen headlamps: Parking and standing lamp	W 5 W Blue Vision
⑥	Bi-Xenon* headlamps: Parking and standing lamp	LED
	Front fog lamp	H11 (55 W)
	Corner-illuminating front fog lamp*	H11 (55 W)

Replacing bulbs

Rear lamps

	Lamp	Type
⑦	High mounted brake lamp	LED
⑧	Brake, tail, parking, standing, backup lamps and turn signal lamps. Rear fog lamp	HiP LED*
⑨	License plate lamps	C 5 W

Warning!



Bulbs and bulb sockets can be very hot. Allow the lamp to cool down before changing a bulb.

Keep bulbs out of reach of children.

Halogen lamps contain pressurized gas. A bulb can explode if you:

- touch or move it when hot
- drop the bulb
- scratch the bulb

Wear eye and hand protection.

Because of high voltage in Xenon lamps, it is dangerous to replace the bulb or repair the lamp and its components. We recommend that you have such work done by a qualified technician.

Notes on bulb replacement

- Use only 12 volt bulbs of the same type and with the specified watt rating.
- Switch lights off before changing a bulb to prevent short circuits.
- Always use a clean lint-free cloth when handling bulbs.
- Your hands should be dry and free of oil and grease.
- If the newly installed bulb does not light up, contact an authorized Mercedes-Benz Center.

Have the LEDs and bulbs for the following lamps replaced by an authorized Mercedes-Benz Center:

- Additional turn signals in the exterior rear view mirrors
- High mounted brake lamp
- Bi-Xenon* lamps
- Front fog lamps
- Front side marker lamps
- Front lamps (except license plate lamps)
- Parking and standing lamps (vehicles with Bi-Xenon* headlamps only)
- Rear lamps (except license plate lamps)

! Do not replace the LEDs yourself. You could otherwise damage the LEDs or parts of the vehicle. Only have the LEDs replaced by an authorized Mercedes-Benz Center.

Replacing bulbs for front lamps

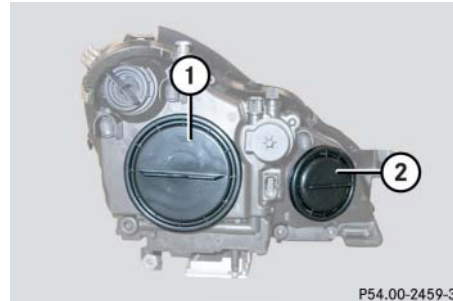

- ① Housing cover for low beam halogen or Bi-Xenon* headlamp
- ② Housing cover for high beam headlamp/high beam flasher bulb and for parking and standing lamp bulb

Warning!



Do not remove the cover ① for the Bi-Xenon* headlamp. Because of high voltage in Xenon* lamps, it is dangerous to replace the bulb or repair the lamp and its components. We recommend that you have such work done by a qualified technician.

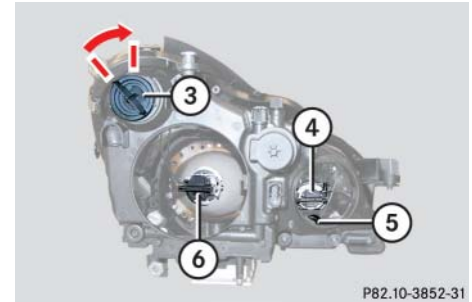

- ③ Bulb socket for turn signal lamp bulb
- ④ Bulb holder of high beam bulb
- ⑤ Bulb socket for parking and standing lamp bulb
- ⑥ Bulb holder of low beam bulb

Before you start to replace a bulb for a front lamp, do the following first:

- ▶ Turn the exterior lamp switch to position **0** (▷ page 128).
- ▶ Open the hood (▷ page 286) (except for side marker lamps).

Replacing bulbs

Low beam bulb (halogen headlamps only)

- ▶ Turn housing cover ① counterclockwise and remove it.
- ▶ Turn bulb holder ⑥ with the bulb counterclockwise and remove it.
- ▶ Pull the bulb at its socket out of bulb holder ⑥.
- ▶ Insert the new bulb so that its socket locates in the recess of bulb holder ⑥ and is level to it.
- ▶ Reinsert bulb holder ⑥ with the bulb in the lamp and turn clockwise.
- ▶ Align housing cover ① and turn it clockwise.

High beam bulb/high beam flasher bulb (halogen headlamps)/high beam flasher bulb (Bi-Xenon* headlamps)

- ▶ Turn housing cover ② counterclockwise and remove it.
- ▶ Turn bulb holder ④ with the bulb counterclockwise and remove it.
- ▶ Pull the bulb at its socket out of bulb holder ④.
- ▶ Insert the new bulb so that its socket locates in the recess of bulb holder ④ and is level to it.
- ▶ Reinsert bulb holder ④ with the bulb in the lamp and turn clockwise.
- ▶ Align housing cover ② and turn it clockwise.

Front turn signal lamp bulb

- ▶ Turn bulb socket ③ with the bulb counterclockwise and remove it.
- ▶ Press gently onto the bulb and turn counterclockwise out of bulb socket ③.
- ▶ Press the new bulb gently into bulb socket ③ and turn clockwise until it engages.
- ▶ Place bulb socket ③ back into the lamp and turn it clockwise.

Parking and standing lamp bulb

Halogen headlamps

- ▶ Turn housing cover ② counterclockwise and remove it.
- ▶ Pull out bulb socket ⑤ with the bulb.
- ▶ Pull the bulb out of the bulb socket ⑤.
- ▶ Press the new bulb into bulb socket ⑤.
- ▶ Press bulb socket ⑤ back into the lamp.
- ▶ Align housing cover ② and turn it clockwise.

Bi-Xenon* headlamps

In vehicles with Bi-Xenon* headlamps, the bulbs of the parking and standing lamps are LEDs.

! Do not replace the LEDs yourself. You could otherwise damage the LEDs or parts of the vehicle. Only have the LEDs replaced by an authorized Mercedes-Benz Center.

Replacing bulbs for rear lamps

Tail lamp unit

The tail lamps are equipped with HiP bulbs.

Warning!



The bulbs in the tail lamps cannot be replaced individually. The tail lamp bulbs are under pressure and could explode during an attempt to replace them.

If the tail lamps are malfunctioning, have them exchanged at an authorized Mercedes-Benz Center.

License plate lamp

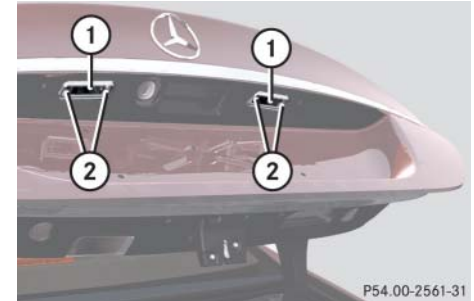

① License plate lamp

② Screws

- ▶ Turn the exterior lamp switch to position **0** (▷ page 128).
- ▶ Loosen both screws ②.
- ▶ Remove the license plate lamp ①.
- ▶ Replace the bulb.
- ▶ Reinstall the license plate lamp ①.
- ▶ Retighten screws ②.

Replacing wiper blades

Warning!



For safety reasons, switch off wipers and remove SmartKey from starter switch (vehicles with KEYLESS-GO*: make sure the vehicle's on-board electronics have status **0**) before replacing a wiper blade. Otherwise, the wiper motor could suddenly turn on and cause injury.

Warning!



Wiper blades are components that are subject to wear and tear. Change the wiper blades twice a year, preferably in the spring and fall. Otherwise the windows will not be properly wiped. As a result, you may not be able to observe surrounding traffic conditions and could cause an accident.

Wiper blades

! *Never open the hood when the wiper arms are folded forward.*

Hold on to the wiper when folding the wiper arm back. If released, the force of the impact from the tensioning spring could crack the windshield.

Do not allow the wiper arms to contact the windshield glass without a wiper blade inserted.

For your convenience, we recommend that you have this work carried out by an authorized Mercedes-Benz Center.

! *To avoid damage to the hood the wiper arms should only be folded forward when in the vertical position.*

- ▶ Turn the SmartKey in the starter switch to position **1**.
- ▶ Turn combination switch to wiper setting **...** (▷ page 57).
- ▶ With wiper arms in the vertical position, turn SmartKey in the starter switch to position **0**.



Wiper blades in vertical position

- ▶ Remove SmartKey from the starter switch.

Vehicles with KEYLESS-GO*:

- ▶ Make sure the vehicle's on-board electronics have status **0**.

Removing wiper

! Do not pull on the wiper blade inserts. They could tear.

- ▶ Fold the wiper arm forward until it snaps into place.

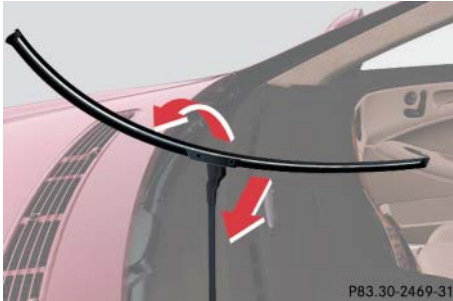

- ▶ Turn the wiper blade at a right angle to wiper arm.
- ▶ Slide the wiper blade sideways out of the retainer.

Installing wiper blades

- ▶ Slide wiper blade onto wiper arm until it locks in place.
- ▶ Rotate wiper blade into position parallel to wiper arm.
- ▶ Fold the wiper arm backward to rest on the windshield. Make sure you hold on to the wiper when folding the wiper arm back.

! Make sure that the wiper blades are properly installed. Improperly installed wiper blades may cause windshield damage.

Flat tire

Preparing the vehicle

- ▶ Park the vehicle in a safe distance from moving traffic on a hard, flat surface when possible.
- ▶ Turn on the hazard warning flashers.
- ▶ Turn the steering wheel so that the front wheels are in a straight ahead position.
- ▶ Set the parking brake.
- ▶ Move the gear selector lever to **P**.

Vehicles with SmartKey:

- ▶ Turn off the engine (▷ page 60).
- ▶ Remove the SmartKey from the starter switch.

Vehicles with KEYLESS-GO*:

- ▶ Turn off the engine by pressing the KEYLESS-GO* button on the gear selector lever once (▷ page 60).
 - ▶ Open the driver's door (this puts the starter switch in position **0**, same as with the SmartKey removed from the starter switch). The driver's door then can be closed again.
-  *Open door only when conditions are safe to do so.*
- ▶ Have any passenger exit the vehicle at a safe distance from the roadway.

Mounting the spare wheel

Warning!



The dimensions of the spare wheel (Minispare or collapsible tire) are different from those of the road wheels. As a result, the vehicle handling characteristics change when driving with a spare wheel mounted. Adapt your driving style accordingly.

The spare wheel is for temporary use only. When driving with spare wheel mounted, ensure proper tire pressure and do not exceed a vehicle speed of 50 mph (80 km/h).

Drive to the nearest Mercedes-Benz Center as soon as possible to have the spare wheel replaced with a regular road wheel.

Never operate the vehicle with more than one spare wheel mounted.

Do not switch off the ESP[®] when a Minispare or collapsible tire is mounted.

Preparing the vehicle

Prepare the vehicle as described under “Preparing the vehicle” on this page.

- ▶ Take the spare wheel out of the trunk (> page 391).
- ▶ Take the wheel wrench and the jack out of the trunk (> page 391).

Removing tensioning straps

(CLS 63 AMG with Performance Package* only)

A 19" spare wheel has two tensioning straps on it that must both be removed before mounting the spare wheel.

i The tensioning straps are shown in red for illustration purposes. The tensioning straps on the spare wheel of your vehicle are black.

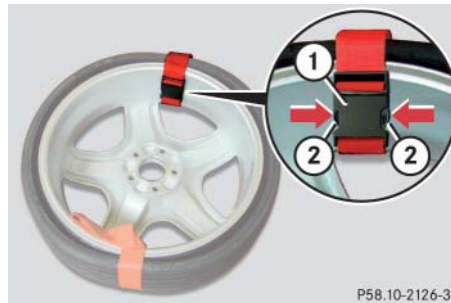

- ① Buckle
- ② Clip

- ▶ Press on both clips ② simultaneously to release buckle ①.

i Keep the tensioning straps in a safe place. You will need them to store the spare wheel in the trunk after use (> page 392).

Lifting the vehicle

- ▶ Prevent the vehicle from rolling away by blocking wheels with wheel chocks or other sizeable objects.

When changing wheel on a level surface:

- ▶ Place the wheel chock in front of and another sizeable object behind the wheel that is diagonally opposite to the wheel being changed.

Always try lifting the vehicle using the jack on a level surface. However, should circumstances require you to do so on a hill, place the wheel chock and the other sizeable object as follows:

- ▶ Place the wheel chock and another sizeable object on the downhill side blocking both wheels of the axle not being worked on.

Flat tire

Warning!



The jack is designed exclusively for jacking up the vehicle at the jack take-up brackets built into either side of the vehicle. To help avoid personal injury, use the jack only to lift the vehicle during a wheel change. Never get beneath the vehicle while it is supported by the jack. Keep hands and feet away from the area under the lifted vehicle. Always firmly set parking brake and block wheels before raising vehicle with jack.

Do not disengage parking brake while the vehicle is raised. Be certain that the jack is always vertical (plumb line) when in use, especially on hills. Always try to use the jack on level surface. Be sure that the jack arm is fully seated in the jack take-up bracket. Always lower the vehicle onto sufficient capacity jackstands before working under the vehicle.

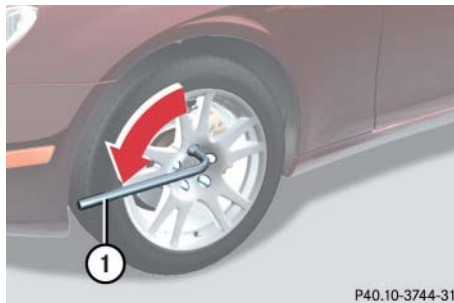

① Wheel wrench

- ▶ On wheel to be changed, loosen but do not yet remove the wheel bolts (approximately one full turn with wrench ①).

The jack take-up brackets are located directly behind the front wheel housings and in front of the rear wheel housings.

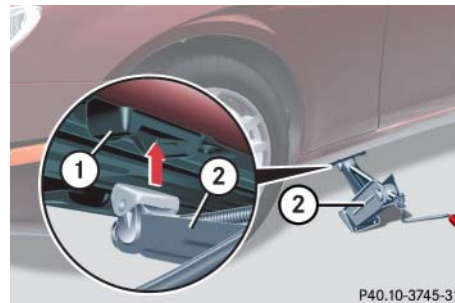

① Jack take-up bracket

② Jack

- ▶ Place jack ② on firm ground.
- ▶ Position jack ② under take-up bracket ① so that it is always vertical (plumb-line) as seen from the side, even if the vehicle is parked on an incline.

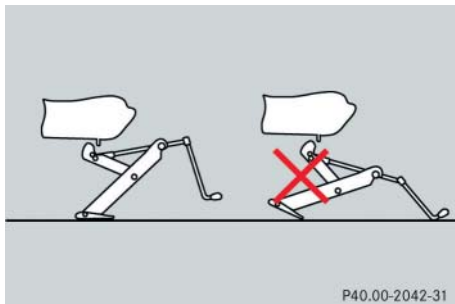

- ▶ Jack up the vehicle until the wheel is a maximum of 1.2 in (3 cm) from the ground. Never start engine while vehicle is raised.

Warning!



The jack is intended only for lifting the vehicle briefly for wheel changes. It is not suited for performing maintenance work under the vehicle.

- Never start the engine when the vehicle is raised.
- Never lie down under the raised vehicle.

Removing the wheel



- ① Alignment bolt
- ▶ Unscrew the upper-most wheel bolt and remove.
- ▶ Replace this wheel bolt with alignment bolt ① supplied in the tool kit.
- ▶ Remove the remaining bolts.
- ❗ *Do not place wheel bolts in sand or dirt. This could result in damage to the bolt and wheel hub threads.*
- ▶ Remove the wheel.

Mounting the spare wheel

Warning!



Vehicles with collapsible tire:
Inflate collapsible tire only after the wheel is properly mounted.

Inflate the collapsible tire using the electric pump (▷ page 416) before lowering the vehicle.

- ▶ Clean contact surfaces of wheel and wheel hub.
- ▶ Guide the spare wheel onto the alignment bolt and push it on.
- ▶ Insert wheel bolts and tighten them slightly.
- ❗ *To avoid paint damage, place wheel flat against hub and hold it there while installing first wheel bolt.*

Flat tire

Warning!



Always replace wheel bolts that are damaged or rusted.

Never apply oil or grease to wheel bolts.

Damaged wheel hub threads should be repaired immediately. Do not continue to drive under these circumstances! Contact an authorized Mercedes-Benz Center or call Roadside Assistance.

Incorrect wheel bolts or improperly tightened wheel bolts can cause the wheel to come off. This could cause an accident. Be sure to use the correct wheel bolts.

Warning!



Only use genuine Mercedes-Benz wheel bolts. Other wheel bolts may come loose.

Do not tighten the wheel bolts when the vehicle is raised. Otherwise the vehicle could fall off the jack.

- ▶ Unscrew the alignment bolt, install last wheel bolt and tighten slightly.

Vehicles with Minispare wheel:

- ▶ Continue the procedure by following the instructions under “Lowering the vehicle” (▷ page 418).

Vehicles with collapsible tire:

- ▶ Continue the procedure by following the instructions under “Inflating the collapsible tire” and then “Lowering the vehicle” (▷ page 418).

Inflating the collapsible tire

! Do not lower the vehicle before inflating the collapsible tire. Otherwise the rim may be damaged.

- ▶ Take the electric air pump out of the trunk (▷ page 391).

Warning!



Observe instructions on air pump label.

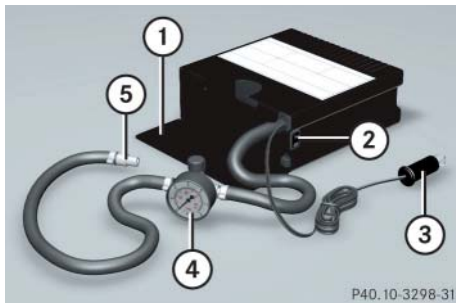

P40.10-3298-31

- ① Flap
 - ② Air pump switch
 - ③ Electrical plug
 - ④ Air hose with pressure gauge and vent screw
 - ⑤ Union nut
- ▶ Open flap ① on the air pump.
 - ▶ Pull out electrical plug ③ and air hose with pressure gauge ④.
 - ▶ Make sure the vent screw on air hose ④ is closed.
 - ▶ Remove the valve cap from the tire valve.

- ▶ Screw union nut ⑤ onto the tire valve.
 - ▶ Insert electrical plug ③ into vehicle cigarette lighter socket (▷ page 250).
 - ▶ Turn the SmartKey in the starter switch to position 1.
- or
- ▶ Press the KEYLESS-GO* start/stop button on the gear selector lever once without depressing the brake pedal.
 - ▶ Press I on electric air pump switch ②.
- The electric air pump should now switch on and inflate the tire.
- ▶ Inflate the tire to approximately 51 psi (3.5 bar).
- This takes about 5 minutes for the collapsible tire. Air hose ④ and union nut ⑤ can become hot during inflation. Exercise proper caution to avoid burning yourself when using the equipment.

! Do not operate the air pump longer than 8 minutes without interruption. Otherwise it may overheat.

You may operate the air pump again after it has cooled off.

- ▶ Press 0 on electric air pump switch ②.
 - ▶ Turn the SmartKey in the starter switch to position 0.
- or
- ▶ Press KEYLESS-GO* start/stop button on the gear selector lever twice without depressing the brake pedal.
- The electric air pump should now be switched off.
- ▶ If the tire inflation pressure is above 51 psi (3.5 bar), release excess tire inflation pressure using the vent screw. ▷▷

Flat tire



Warning!



Follow recommend inflation pressures.

Do not overinflate tires. Overinflating tires can result in sudden deflation (blowout) because they are more likely to become punctured or damaged by road debris, potholes, etc.

Do not underinflate tires. Underinflated tires wear unevenly, adversely affect handling and fuel economy, and are more likely to fail from being overheated.

- ▶ Detach the electric air pump.
- ▶ Stow electrical plug ③ and air hose ④ behind flap ① and place the air pump back in the trunk.

i *Vehicles with Advanced TPMS*:
Do not activate the tire inflation pressure monitor (▷ page 309) until a full size wheel/tire with functioning sensor has been placed back into service on the vehicle.*

Lowering the vehicle

- ▶ Lower vehicle by turning crank counterclockwise until vehicle is resting fully on its own weight.
- ▶ Remove the jack.

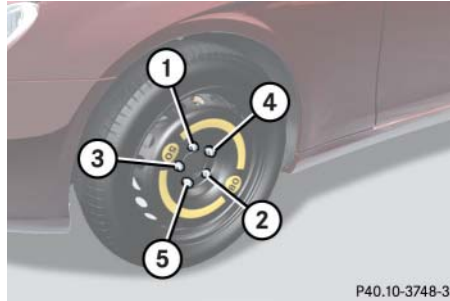

① - ⑤ Wheel bolts

- ▶ Tighten the five wheel bolts evenly, following the diagonal sequence illustrated (① to ⑤), until all bolts are tight. Observe a tightening torque of 96 lb-ft (130 Nm).

Warning!



Have the tightening torque checked after changing a wheel. The wheels could come loose if they are not tightened to a torque of 96 lb-ft (130 Nm).

- ▶ Before storing the jack in the trunk, it should be fully collapsed.

i *Wrap the damaged wheel in the protective film that comes with the spare wheel and put the wheel in the trunk.*

You can also place the damaged wheel down into the spare wheel well. In this case, you must stow the luggage bowl in the trunk.

MOExtended system*

The MOExtended system allows you to continue driving your vehicle even if there is a total loss of pressure in one or more tires.

You may only use the MOExtended system in conjunction with Tire Pressure Monitoring System (U.S. vehicles), Run Flat Indicator (Canada vehicles), or Advanced Tire Pressure Monitoring System* (Canada only).

! *The maximum distance in emergency mode depends on the vehicle's load. It is 30 miles (50 km) if the vehicle is partially loaded and 18 miles (30 km) if the vehicle is fully loaded.*

The point at which the maximum driving distance begins in emergency mode is when the warning message appears in the multifunction display indicating that there is a loss of tire inflation pressure.

Do not exceed the maximum speed of 50 mph (80 km/h).

Warning!



In emergency mode, your vehicle's driving characteristics are diminished in such situations as:

- driving around curves
- while braking
- while accelerating rapidly

Therefore, your driving style must be adapted accordingly. Avoid abrupt steering and driving maneuvers, as well as driving over obstacles (road curbs, potholes, or off-road areas). This is especially important if the vehicle is heavily loaded.

The emergency driving distance that can be achieved greatly depends on the demands placed on the vehicle. Depending on speed, load, driving maneuvers, road conditions, outside temperature, etc., the distance can be significantly shorter or, if the vehicle is driven cautiously, somewhat longer.

Do not continue driving in emergency mode if

- you notice knocking sounds
- the vehicle starts to shake
- smoke develops and you smell rubber
- ESP® is intervening continuously
- you notice tears on the tire sidewalls

After driving in emergency mode, you must have the rims inspected by an authorized Mercedes-Benz Center to check if they are suitable for further use. The failed tire must be replaced in any case.

i *When replacing individual or all tires on the vehicle, make sure only matching tires marked with "MOExtended" are mounted in the size specified for your vehicle (▷ page 444).*

Battery

The battery is located on the right hand side of the trunk under the luggage box (▷ page 395).

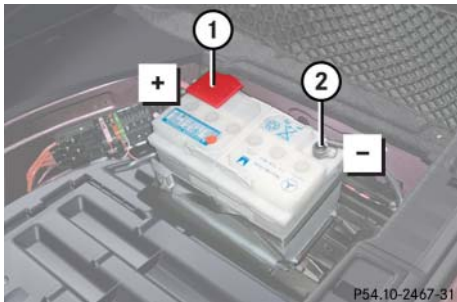

- ① Positive terminal cover
- ② Negative terminal

Warning!



Do not place metal objects on the battery as this could result in a short circuit.

Use leak-proof battery only to avoid the risk of acid burns in the event of an accident.

Warning!



Failure to follow these instructions can result in severe injury or death.

Observe all safety instructions and precautions when handling automotive batteries (▷ page 291).

Never lean over batteries while connecting, you might get injured.

Battery fluid contains sulfuric acid. Do not allow this fluid to come in contact with eyes, skin or clothing. In case it does, immediately flush affected area with water and seek medical help if necessary.

A battery will also produce hydrogen gas, which is flammable and explosive. Keep flames or sparks away from battery, avoid improper connection of jumper cables, smoking etc.

! Depending on vehicle production date, the battery is a Valve-Regulated Lead Acid (VRLA) battery, also referred to as “fleece” battery. Such batteries do not require topping-up of the electrolyte level. VRLA batteries therefore do not have cell caps and the battery cover is non-removable. Do not attempt to open the battery as otherwise the battery will be damaged.

Even though VRLA batteries do not require topping-up of the electrolyte level and cannot be opened to check the electrolyte level, the battery condition must be checked periodically by performing a battery conductance test. Refer to Maintenance Booklet for battery condition testing intervals.

The factory-equipped VRLA battery is leak-proofed. Only use a battery as replacement that has the same security features and is of identical size, voltage, and capacity as the factory-equipped battery.

! As with any other battery, disconnect the battery if you do not intend to operate your vehicle for an extended period of time to prevent battery discharge or connect an accessory battery charge unit expressly approved by Mercedes-Benz for your vehicle model to maintain the battery charge. Contact an authorized Mercedes-Benz Center for further information.

The battery, the battery ventilation hose and the lateral plug must always be securely installed when the vehicle is in operation.

! Never loosen or detach battery terminal clamps while the engine is running or the SmartKey is in the starter switch. Otherwise the alternator and other electronic components could be severely damaged.

Have the battery checked regularly by an authorized Mercedes-Benz Center.

Refer to Maintenance Booklet for maintenance intervals or contact your authorized Mercedes-Benz Center for further information.

Disconnecting the battery

Warning!



With a disconnected battery

- you will no longer be able to turn the SmartKey in the starter switch and pressing the KEYLESS-GO* start/stop button on the gear selector lever will have no effect
 - the gear selector lever will remain locked in position **P**
- ▶ Depress parking brake firmly or move gear selector lever to position **P**.
 - ▶ Turn off all electrical consumers.
 - ▶ Remove SmartKey from starter switch.
- Vehicles with KEYLESS-GO*:
- ▶ Press the start/stop button until the engine shuts off.
 - ▶ Open the driver's door.

- ▶ Open the trunk.
- ▶ Read and observe safety instructions and precautions (▷ page 420).
- ▶ Remove the luggage box (▷ page 395).
- ▶ Disconnect battery negative lead ②.
- ▶ Remove cover ① from the positive terminal.
- ▶ Disconnect the battery positive lead.

Removing the battery

- ▶ Remove the screw-nuts securing the battery.
- ▶ Remove the battery bracket.
- ▶ Pull out the battery ventilation tube from the battery (depending on battery arrangement in your vehicle model, the battery ventilation tube is located on the left or right side of the battery).
- ▶ Take out the battery.

Battery

Charging and reinstalling the battery

Warning!



Never charge a battery while still installed in the vehicle unless the accessory battery charge unit* approved by Mercedes-Benz is being used. Gases may escape during charging and cause explosions that may result in paint damage, corrosion or personal injury.

An accessory battery charge unit* specially adapted for Mercedes-Benz vehicles and tested and approved by Mercedes-Benz is available, permitting the charging of the battery in its installed position. Contact an authorized Mercedes-Benz Center for information and availability. Charge battery in accordance with the separate instructions for the accessory battery charger*.

- ▶ Charge battery in accordance with the instructions of the battery charger manufacturer.
- ▶ Reinstall the charged battery. Follow the previously described steps in reverse order.

! *The battery, its filler caps and the battery ventilation tube must always be securely installed when the vehicle is in operation.*

Reconnecting the battery

- ▶ Turn off all electrical consumers.
 - ▶ Remove the SmartKey from the starter switch.
 - ▶ Connect the positive lead and fasten its cover.
 - ▶ Connect the negative lead.
- !** *Never invert the terminal connections!*
- ▶ Install the luggage box (▷ page 395).

i *The following procedures must be carried out following any interruption of battery power (e.g. due to reconnection):*

- *Set the clock (▷ page 159) (see COMAND operator's manual).*
- *Resynchronize the side windows (▷ page 209).*
- *Resynchronize the tilt/sliding sunroof (▷ page 214).*

Batteries contain materials that can harm the environment if disposed of improperly. Large 12 volt storage batteries contain lead. Recycling of batteries is the preferred method of disposal. Many states require sellers of batteries to accept old batteries for recycling.

▼ Jump starting

Warning!



Failure to follow these directions will cause damage to the electronic components, and can lead to a battery explosion and severe injury or death.

Never lean over batteries while connecting or jump starting, you might get injured.

Battery fluid contains sulfuric acid. Do not allow this fluid to come in contact with eyes, skin or clothing. In case it does, immediately flush affected area with water, and seek medical help if necessary.

A battery will also produce hydrogen gas, which is flammable and very explosive. Keep flames or sparks away from battery, avoid improper connection of jumper cables, smoking, etc.

Attempting to jump start a frozen battery can result in it exploding, causing personal injury.

Read all instructions before proceeding.

! Do not tow-start the vehicle.

! Avoid repeated and lengthy starting attempts.

Do not attempt to start the engine using a battery quick charge unit.

If the engine does not run after several unsuccessful starting attempts, have it checked at the nearest authorized Mercedes-Benz Center.

Excessive unburned fuel generated by repeated failed starting attempts may damage the catalytic converter and may present a fire risk.

Make sure the jumper cables do not have loose or missing insulation.

Make sure the cable clamps do not touch any other metal part while the other end is still attached to a battery.

If the battery is discharged, the engine can be started with jumper cables and the battery of another vehicle. Observe the following:

- Jump starting should only be performed when the engine and catalytic converter are cold.

- Do not start the engine if the battery is frozen. Let the battery thaw out first.
- Only jump start from batteries with the same voltage rating (12 V). Jump starting with a higher voltage battery could damage the vehicle's electrical system, which will not be covered by the Mercedes-Benz Limited Warranty.
- Use only jumper cables with sufficient cross-section and insulated terminal clamps.
- Always make sure the jumper cables are not on or near pulleys, fans or other parts that move when the engine is started or running.

Warning!



Keep flames or sparks away from battery. Do not smoke.

Observe all safety instructions and precautions when handling automotive batteries (▷ page 291).

Jump starting

The main battery is located in the trunk underneath the luggage box (▷ page 395). Only jump start the vehicle from the battery in the trunk.

- ▶ Make sure the two vehicles do not touch.
- ▶ Turn off all electrical consumers.
- ▶ Apply parking brake (▷ page 59).
- ▶ Make sure the gear selector lever is set to position **P**.
- ▶ Open the trunk.

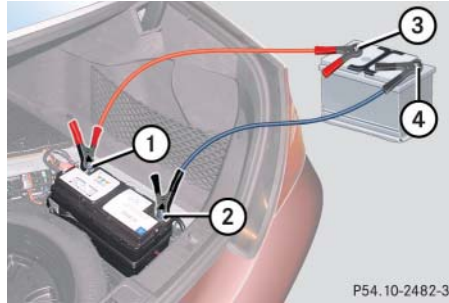

- ① Positive terminal of discharged battery
- ② Negative terminal of discharged battery
- ③ Positive terminal of charged battery
- ④ Negative terminal of charged battery

- ▶ Connect positive terminals ① and ③ of the batteries with the jumper cable. Clamp cable to charged battery ③ first.

! *Never invert the terminal connections!*

- ▶ Start engine of the vehicle with the charged battery and run at idle speed.

- ▶ Connect negative terminals ④ and ② of the batteries with the jumper cable. Clamp cable to charged battery ④ first.

- ▶ Start the engine of the disabled vehicle.

You can now turn on the electrical consumers. Do not switch on the headlamps under any circumstances.

- ▶ Remove the jumper cables first from negative terminals ② and ④ and then from positive terminals ① and ③.

You can now switch on the headlamps.

- ▶ Have the battery checked at the nearest authorized Mercedes-Benz Center.

▼ Towing the vehicle

Mercedes-Benz recommends that the vehicle be transported with all wheels off the ground using flatbed or appropriate wheel lift/dolly equipment. This method is preferable to other types of towing.

! *Do not tow-start the vehicle.*

! *Use flatbed or wheel lift/dolly equipment with SmartKey in starter switch turned to position **0**.*

Do not tow with sling-type equipment. Towing with sling-type equipment over bumpy roads will damage radiator and supports.

To prevent damage during transport, do not tie down vehicle by its chassis or suspension parts.

Switch off the automatic central (> page 165) locking.

When circumstances do not permit the recommended towing methods, the vehicle may be towed with all wheels on the ground or front wheels raised only so far as necessary to have the vehicle moved to a safe location where the recommended towing methods can be employed.

Warning!



If circumstances require towing the vehicle with all wheels on the ground, always tow with a tow bar if:

- the engine will not run
 - there is a malfunction in the brake system
 - there is a malfunction in the power supply or in the vehicle's electrical system
- as that will be necessary to adequately control the towed vehicle.

Prior to towing the vehicle with all wheels on the ground, make certain that the SmartKey is in starter switch position **2**.

If the SmartKey is left in the starter switch position **0** for an extended period of time, it can no longer be turned in the switch. In this case, the steering is locked. To unlock, remove SmartKey from starter switch and reinsert.

Warning!



With the engine not running, there is no power assistance for the steering system. In this case, it is important to keep in mind that a considerably higher degree of effort is necessary to steer the vehicle. Adapt your driving accordingly.

! *If the vehicle is towed with the front axle raised, the gear selector lever must be in position **N** and the engine must be shut off (SmartKey in starter switch position **0** or **1**). Active braking action through the ESP® may otherwise seriously damage the brake system.*

*When towing the vehicle with all wheels on the ground, the selector lever must be in position **N** and the SmartKey must be in starter switch position **2**.*

When towing the vehicle with all wheels on the ground or the front axle raised, the vehicle may be towed only for distances up to 30 miles (50 km) and at a speed not to exceed 30 mph (50 km/h).

Towing the vehicle

! Towing of the vehicle should only be done using the properly installed towing eye bolt. Never attach tow cable, tow rope or tow rod to the vehicle chassis, frame or suspension parts.

i When towing the vehicle with all wheels on the ground, please note the following:

With the automatic central locking activated and the SmartKey in starter switch position **2**, or KEYLESS-GO* start/stop button in position **2**, the vehicle doors lock if the left front wheel as well as the right rear wheel are turning at vehicle speeds of approximately 9 mph (15 km/h) or more.

To prevent the vehicle door locks from locking, deactivate the automatic central locking (▷ page 118).

i To signal turns while being towed with the hazard warning flasher in use, turn SmartKey in starter switch to position **2** and activate the combination switch for the left or right turn signal in the usual manner – only the selected turn signal will operate.

Upon canceling the turn signal, the hazard warning flasher will operate again.

i The selector lever will remain locked in position **P** and the SmartKey will not turn in the starter switch if the battery is disconnected or discharged. For more information see “Battery” (▷ page 420) or “Jump starting” (▷ page 423).

For information on manual unlocking of the gear selector lever, see (▷ page 398).

Installing towing eye bolt

Front of vehicle

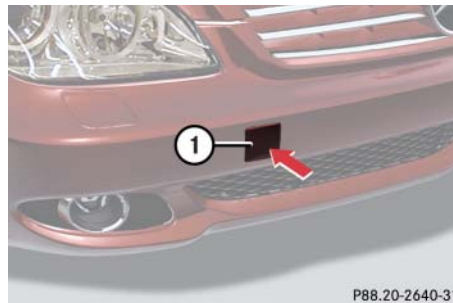

① Cover on right side of front bumper

To remove cover:

- ▶ Press mark on cover in direction of arrow.
- ▶ Lift cover off to reveal the threaded hole for towing eye bolt.

The towing eye bolt is supplied with the tool kit (located in the storage compartment under the trunk floor).

- ▶ Screw towing eye bolt in to its stop and tighten with lug wrench.

To reinstall cover:

- ▶ Fit cover and snap into place.

Rear of vehicle

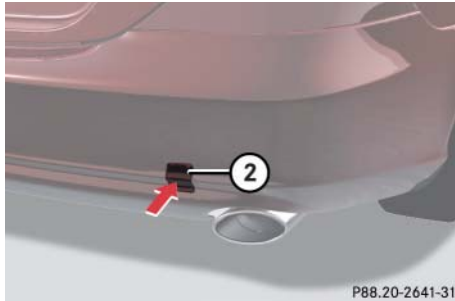

② Cover on right side of rear bumper

To remove cover:

- ▶ Press mark on cover in the direction of the arrow.
- ▶ Fold cover down to reveal the threaded hole for the towing eye bolt.

The towing eye bolt is supplied with the tool kit (located in the storage compartment under the trunk floor).

- ▶ Screw towing eye bolt in to its stop and tighten with lug wrench.

To reinstall cover:

- ▶ Fit cover and snap into place.

Fuses

The electrical fuses in your vehicle serve to switch off malfunctioning power circuits.

If a fuse is blown, the components and systems secured by that fuse will stop operating.

Warning!



Only use fuses approved by Mercedes-Benz with the specified amperage for the system in question and do not attempt to repair or bridge a blown fuse. Using other than approved fuses or using repaired or bridged fuses may cause an overload leading to a fire, and/or cause damage to electrical components and/or systems. Have the cause determined and remedied by an authorized Mercedes-Benz Center.

i *A blown fuse must be replaced by an appropriate spare fuse (recognizable by its color or the fuse rating given on the fuse) of the amperage recommended in the fuse chart. Any Mercedes-Benz Center will be glad to advise you on this subject.*

If a newly inserted fuse blows again, have the cause determined and rectified by an authorized Mercedes-Benz Center.

The following aids are available to help you replace fuses:

- Fuse chart

The fuse chart is located in the fuse box in the passenger compartment (▷ page 429). The fuse chart explains the fuse allocation and fuse amperages.

- Spare fuses

Spare fuses are located in the vehicle tool kit in the trunk (▷ page 393).

- Fuse extractor

The fuse extractor is located in the vehicle tool kit in the trunk (▷ page 393).

The electrical fuses are located in different fuse boxes:

- Main fuse box in passenger compartment (▷ page 429)
- Fuse box in trunk (▷ page 429)

Before replacing fuses:

- ▶ Apply the parking brake (▷ page 59).
- ▶ Make sure the gear selector lever is set to position **P** (▷ page 171).
- ▶ Turn off all electrical consumers.
- ▶ Turn off the engine (▷ page 60).
- ▶ Remove the SmartKey from the starter switch.

Vehicles with KEYLESS-GO*:

- ▶ Open the driver's door.

Main fuse box in passenger compartment

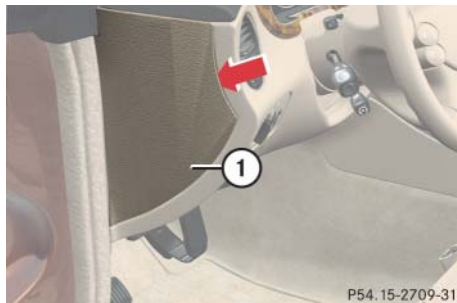

① Cover

! Do not use sharp objects such as a screw driver to open the fuse box cover ① in the dashboard, as this could damage it.

Opening

- ▶ Open the front passenger door.
- ▶ Insert flat, blunt object as a lever in into on the edge of cover ① at the position indicated by the arrow.
- ▶ Loosen cover ① from the dashboard using lever.
- ▶ Using your hands, pull cover ① in the direction of the arrow and remove.

Closing

- ▶ Hook cover ① into the opening at the front.
- ▶ Press cover ① back on until it engages.

Fuse box in trunk

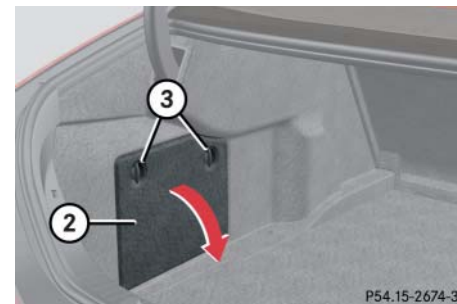

② Cover

③ Catches

- ▶ Turn catches ③ counter-clockwise and remove cover ②.

Parts service

Warranty coverage

Identification labels

Layout of poly-V-belt drive

Engine

Rims and tires

Electrical system

Main dimensions and weights

Fuels, coolants, lubricants etc.



Parts service

The “Technical data” section provides the necessary technical data for your vehicle.

All authorized Mercedes-Benz Centers maintain a stock of Genuine Mercedes-Benz Parts required for maintenance and repair work. In addition, strategically located parts distribution centers provide quick and reliable parts service.

More than 300 000 different parts for Mercedes-Benz models are available.

Genuine Mercedes-Benz Parts are subjected to stringent quality inspections. Each part has been specifically developed, manufactured or selected for and adapted to Mercedes-Benz vehicles.

Therefore, Genuine Mercedes-Benz parts should be installed.

! *The use of non-genuine Mercedes-Benz parts and accessories not authorized by Mercedes-Benz could damage the vehicle, which is not covered by the Mercedes-Benz Limited Warranty, or could compromise the vehicle’s durability or safety.*

▼ Warranty coverage

Your vehicle is covered under the terms of the warranties printed in the Service and Warranty Information Booklet. Your authorized Mercedes-Benz Center will exchange or repair any defective parts originally installed in the vehicle in accordance with the terms of the following warranties:

- New Car Limited Warranty
- Emission System Warranty
- Emission Performance Warranty
- California, Maine, Massachusetts, and Vermont Emission Control System Warranty

Replacement parts and accessories are covered by the Mercedes-Benz Parts and Accessories Warranties, copies of which are available at any authorized Mercedes-Benz Center.

Loss of Service and Warranty Information Booklet

Should you lose your Service and Warranty Information Booklet, have your authorized Mercedes-Benz Center arrange for a replacement. It will be mailed to you.

Identification labels

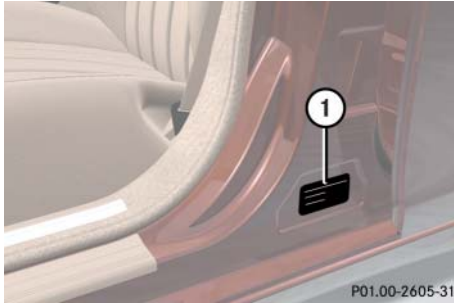

P01.00-2605-31

① Certification label (includes Paintwork code)

The Vehicle Identification Number (VIN) can be found in the following locations:

- on the Certification label
- embossed underneath a cover in the center armrest
- on the lower edge of the windshield

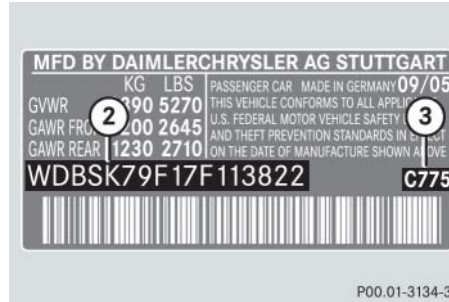

P00.01-3134-31

Example Certification label (U.S. vehicles)

- ② VIN
- ③ Paintwork code



P00.01-3271-31

Example Certification label (Canada vehicles)

- ② VIN
- ③ Paintwork code

i Data shown on Certification label are for illustration purposes only. These data are specific to each vehicle and may vary from data shown in the illustration. Refer to Certification label on vehicle for actual data specific to your vehicle.

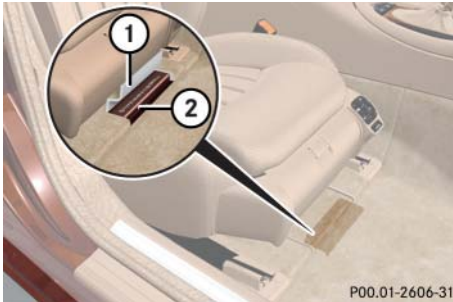

- ① Cover
- ② VIN

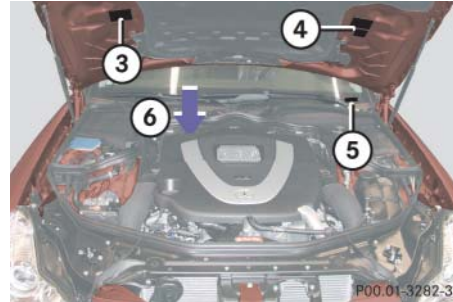

- ③ Emission control information label, includes both federal and California certification exhaust emission standards
- ④ Vacuum line routing diagram label
- ⑤ VIN (lower edge of windshield)
- ⑥ Engine number (engraved on engine)

i When ordering parts, please specify vehicle identification and engine numbers.

Layout of poly-V-belt drive

CLS 550

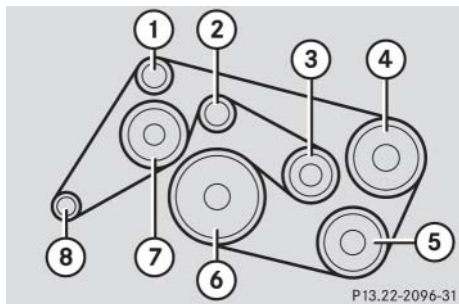

- ① Idler pulley
- ② Idler pulley
- ③ Automatic belt tensioner
- ④ Power steering pump
- ⑤ Air conditioning compressor
- ⑥ Crankshaft
- ⑦ Coolant pump
- ⑧ Generator (alternator)

CLS 63 AMG

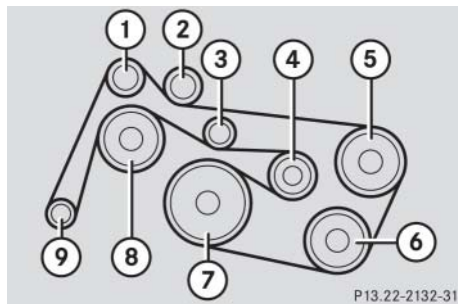

- ① Idler pulley
- ② Idler pulley
- ③ Idler pulley
- ④ Automatic belt tensioner
- ⑤ Power steering pump
- ⑥ Air conditioning compressor
- ⑦ Crankshaft
- ⑧ Coolant pump
- ⑨ Generator (alternator)

▼ Engine

Model	CLS 550 (219.372 ¹)	CLS 63 AMG (219.377 ¹)
Engine	273	156
Mode of operation	4-stroke engine, gasoline injection	4-stroke engine, gasoline injection
No. of cylinders	8	8
Bore	3.86 in (98.00 mm)	4.02 in (102.20 mm)
Stroke	3.56 in (90.50 mm)	3.72 in (94.60 mm)
Total piston displacement	333.3 cu in (5461 cm ³)	378.8 cu in (6208 cm ³)
Compression ratio	10.7:1	11.3:1
Output acc. to SAE J 1349	382 hp/6 000 rpm ² (285 kW/6 000 rpm)	507 hp/6 800 rpm ² (378 kW/6 800 rpm)
Maximum torque acc. to SAE J 1349	391 lb-ft/2 800 rpm - 4 800 rpm (530 Nm/2 800 rpm - 4 800 rpm)	468 lb-ft/5 200 rpm (635 Nm/5 200 rpm)
Maximum engine speed	6 500 rpm	7 200 rpm
Firing order	1-5-4-2-6-3-7-8	1-5-4-2-6-3-7-8
Poly-V-belt	2404 mm	2369 mm

¹ The quoted data apply only to the standard vehicle. See an authorized Mercedes-Benz Center for the corresponding data of all special bodies and special equipment.

² Premium fuel required. Performance may vary with fuel octane rating.

Rims and tires

! Only use tires which have been tested and approved by Mercedes-Benz. Tires approved by Mercedes-Benz are developed to provide best possible performance in conjunction with the driving safety systems on your vehicle such as ABS or ESP®. Tires specially developed for your vehicle and tested and approved by Mercedes-Benz can be identified by finding the following on the tire's sidewall:

- MO = Mercedes-Benz Original equipment tires

AMG vehicles:

Does not apply to all approved tires on AMG vehicles. For information on tested and approved tires for AMG vehicles, contact an authorized Mercedes-Benz Center.

- MOE = Mercedes-Benz Original Extended (tires with limited run-flat characteristics) original equipment tires

Using tires other than those approved by Mercedes-Benz may result in damage that is not covered by the Mercedes-Benz Limited Warranty.

i For information on driving with MOExtended tires, see "MOExtended system*" (▷ page 313).

! Using tires other than those approved by Mercedes-Benz can have detrimental effects, such as

- poor handling characteristics
- increased noise
- increased fuel consumption

Moreover, tires and rims not approved by Mercedes-Benz may, under load, exhibit dimensional variations and different tire deformation characteristics that could cause them to come into contact with the vehicle body or axle parts. Damage to the tires or the vehicle may be the result.

i Further information on tires and rims is available at any authorized Mercedes-Benz Center. A placard with the recommended tire inflation pressures is located on the driver's door B-pillar. Some vehicles may have supplemental tire inflation pressure information for driving at high speeds (▷ page 302) or for vehicle loads less than the maximum loaded vehicle condition (▷ page 302). If such information is provided, it can be found on the placard located on the inside of the fuel filler flap.

The tire inflation pressure should be checked regularly and should only be adjusted on cold tires. Follow tire manufacturer's maintenance recommendation included with vehicle.

i The following pages also list the approved wheel rim and tire sizes for equipping your vehicles with winter tires. Winter tires are not available as standard or optional factory equipment, but can be purchased from an authorized Mercedes-Benz Center.

Depending on vehicle model and the standard or optional factory-equipped wheel rim/tire configuration on your vehicle (Appearance Package, AMG Sport Package etc.), equipping your vehicle with winter tires approved for your vehicle model may also require the purchase of two or four wheel rims of the recommended size for use with these winter tires. See an authorized Mercedes-Benz Center for more information.

Same size tires

Model	CLS 550
Rims (light alloy)	8.5 J x 18 H2
Wheel offset (front axle)	1.38 in (28 mm)
Wheel offset (rear axle)	0.71 in (18 mm)
Summer tires¹	-
Winter tires^{1,2}	245/40 R18 97V XL (Extra Load) M+S 

¹ Radial-ply tires

² Not available as factory equipment.

! *Winter tires on rims with different wheel offset front vs. rear cannot be rotated.*

Rims and tires

Model	CLS 550 (AMG Sport Package*)	CLS 63 AMG
Rims (light alloy)	8.5 J x 18 H2	8.5 J x 18 H2
Wheel offset	0.98 in (25 mm)	0.98 in (25 mm)
Summer tires¹	-	-
Winter tires^{1,2}	245/40 R18 97V XL (Extra Load) M+S 	245/40 R18 97V XL (Extra Load) M+S 

¹ Radial-ply tires

² Not available as factory equipment.

Model	CLS 63 AMG (Performance Package*)
Rims (light alloy)	8.5 J x 19 H2
Wheel offset	0.98 in (25 mm)
Summer tires¹	-
Winter tires^{1,2,3}	245/35 R19 93V XL (Extra Load) M+S 

¹ Radial-ply tires

² Not available as factory equipment.

³ Maximum permissible vehicle speed of 137 mph (220 km/h).

Mixed size tires

Model	CLS 550	CLS 550 (AMG Sport Package [*])
Front axle:		
Rims (light alloy)	8.5 J x 18 H2	8.5 J x 18 H2
Wheel offset	1.10 in (28 mm)	0.98 in (25 mm)
Summer tires¹	245/40 R18 93Y	255/40 ZR18 95Y or 255/40 ZR18 99Y XL (Extra Load)
All-season tires¹	245/40 R18 93V M+S	-
Rear axle:		
Rims (light alloy)	9.5 J x 18 H2	9.5 J x 18 H2
Wheel offset	1.30 in (33 mm)	1.10 in (28 mm)
Summer tires^{1,2}	275/35 R18 95Y	285/35 ZR18 97Y or 285/35 ZR18 101Y XL (Extra Load)
All-season tires^{1,2}	275/35 R18 95V M+S	-

¹ Radial-ply tires



² Must not be used with snow chains.

Rims and tires

Model	CLS 63 AMG	CLS 63 AMG*
Front axle:		
Rims (light alloy)	8.5 J x 18 H2	8.5 J x 19 H2
Wheel offset	0.98 in (25 mm)	0.98 in (25 mm)
Summer tires¹	255/40 R18 99Y XL (Extra Load)	255/35 ZR19 96Y XL (Extra Load)
Winter tires	-	-
Rear axle:		
Rims (light alloy)	9.5 J x 18 H2	9.5 J x 19 H2
Wheel offset	1.10 in (28 mm)	1.10 in (28 mm)
Summer tires^{1,2}	285/35 R18 101Y XL (Extra Load)	285/30 ZR19 98Y XL (Extra Load)
Winter tires	-	-

¹ Radial-ply tires

² Must not be used with snow chains.

Model	CLS 63 AMG (Performance Package*)	CLS 63 AMG (Performance Package*)
Front axle:		
Rims (light alloy)	8.5 J x 19 H2	8.5 J x 19 H2
Wheel offset	0.98 in (25 mm)	0.98 in (25 mm)
Summer tires¹	255/35 ZR19 96Y XL (Extra Load)	-
Winter tires^{1,3}	-	245/35 R19 93V XL (Extra Load) M+S 
Rear axle:		
Rims (light alloy)	9.5 J x 19 H2 or 10 J x 19 H2	9.5 J x 19 H2
Wheel offset	1.10 in (28 mm)	1.10 in (28 mm)
Summer tires^{1,2}	285/30 ZR19 98Y XL (Extra Load)	-
Winter tires^{1,2,3}	-	275/30 R19 96Y XL (Extra Load) M+S 

¹ Radial-ply tires.

² Must not be used with snow chains.

³ Not available as factory equipment.

Rims and tires

MOExtended tires*

Model	CLS 550 CLS 550 (AMG Sport Package*)	CLS 550 CLS 550 (AMG Sport Package*)
Front axle:		
Rims (light alloy)	8.5 J x 18 H2	8.5 J x 18 H2
Wheel offset	1.10 in (28 mm)	1.10 in (28 mm)
Summer tires^{1,2}	245/40 R18 93Y MOExtended	–
Winter tires^{1,2,3}	–	245/40 R18 97V XL (Extra Load) M+S  MOExtended
Rear axle:		
Rims (light alloy)	9.5 J x 18 H2	8.5 J x 18 H2
Wheel offset	1.30 in (33 mm)	0.71 in (18 mm)
Summer tires^{1,2,4}	275/35 R18 95Y MOExtended	–
Winter tires^{1,2,3}	–	245/40 R18 97V XL (Extra Load) M+S  MOExtended

¹ Radial-ply tires.

² Must be used in conjunction with Tire Pressure Monitoring System (U.S. vehicles), Run Flat Indicator (Canada vehicles), or Advanced Tire Pressure Monitoring System* (Canada only).

³ Not available as factory equipment.

⁴ Must not be used with snow chains.

Spare wheel

Model	CLS 550	CLS 550 (AMG Sport Package*)
Rim	4.0 B x 17 H2	6.0 B x 18 H2
Wheel offset	1.34 in (34 mm)	0.98 in (25 mm)
Minispare tire ¹	T 155/70 R17 110M	-
Collapsible tire ¹	-	175/55-18 91P

¹ Must not be used with snow chains.

Rims and tires

Model	CLS 63 AMG	CLS 63 AMG (Performance Package*)
Rim	6.0 B x 18 H2	6.5 B x 19 H2
Wheel offset	0.98 in (25 mm)	0.55 in (14 mm)
Minispare tire	–	–
Collapsible tire ¹	175/55-18 95P	175/50-19 97P

¹ Must not be used with snow chains.

! Please compare the recommended tire inflation pressure for your vehicle with the tire inflation pressure on the yellow label located on the spare wheel rim.

If the tire inflation pressure on the yellow label on the spare wheel rim differs from the values given in this Operator's Manual, inflate the spare wheel tire to the recommended tire inflation pressure given on the yellow label on the spare wheel rim.

i Please note that the tire inflation pressure of the Minispare tire and the collapsible tire differs from the tire inflation pressure of the road tires.

Make sure the Minispare tire is inflated to approximately 61 psi (4.2 bar).

Inflate the collapsible tire to approximately 51 psi (3.5 bar).

▼ **Electrical system**

Model	CLS 550	CLS 63 AMG
Generator (alternator)	14 V/180 A	14 V/180 A
Starter motor	14 V/1.7 kW	12 V/2.1 kW
Battery	12 V/95 Ah ¹	12 V/95 Ah
Spark plugs	Bosch F8 DPP 332U NGK PFR 5R-11	NGK ILZKAR7A10
Electrode gap	0.039 in (1.00 mm)	0.039 in (1.00 mm)
Tightening torque	18.5 - 22 lb-ft (25 - 30 Nm)	15 - 18.5 lb-ft (20 -25 Nm)

¹ Depending on production date, your vehicle may be equipped with a 12 V/100 Ah battery.

Main dimensions and weights

Main dimensions

Model	CLS 550	CLS 63 AMG
Overall vehicle length	193.3 in (4910 mm)	193.5 in (4915 mm)
Overall vehicle width (exterior rear view mirrors folded out)	81.1 in (2059)	81.1 in (2059 mm)
Overall vehicle height	55.7 in (1414 mm)	54.5 in (1389 mm)
Wheelbase	112.4 in (2854 mm)	112.4 in (2854 mm)
Track, front	62.5 in (1587 mm)	63 in (1599 mm)
Track, rear	61.8 in (1570 mm)	62.3 in (1583 mm)

Weights

Roof load max.	220 lb (100 kg)
Trunk load max.	220 lb (100 kg)

Fuels, coolants, lubricants etc.

▼ **Fuels, coolants, lubricants etc.**

Capacities

Vehicle components and their respective lubricants must match. Therefore only use products tested and approved by Mercedes-Benz.

Please refer to the Factory Approved Service Products pamphlet (USA only), or inquire at an authorized Mercedes-Benz Center.

Warning!



Comply with all valid regulations with respect to handling, storing and disposing of service fluids. Otherwise you could endanger persons or the environment.

Keep service fluids out of the reach of children.

For health reasons, you should prevent service fluids from coming into direct contact with your skin or clothing.

If a service fluid is swallowed, contact a physician immediately.

	Model	Capacity	Fuels, coolants, lubricants etc.
Engine with oil filter	CLS 550	9.0 US qt (8.5 l)	Approved engine oils
Engine with oil filter including oil cooler	CLS 63 AMG	9.3 US qt (8.8 l)	Approved engine oils
Automatic transmission	CLS 550	9.7 US qt (9.2 l)	MB Automatic Transmission Fluid
	CLS 63 AMG	9.0 US qt (8.5 l)	
Rear axle	CLS 550	1.37 US qt (1.3 l)	Hypoid gear oil SAE 85 W 90
	CLS 63 AMG	1.27 US qt (1.2 l)	

Fuels, coolants, lubricants etc.

	Model	Capacity	Fuels, coolants, lubricants etc.
Power steering	CLS 550	approx. 1.0 US qt (0.9 l)	MB Power Steering Fluid (Pentosin CHF 11S or, depending on vehicle production date, Chevron Texaco PSF 9109) ¹
	CLS 63 AMG	approx. 1.3 US qt (1.2 l)	
Front wheel hubs	CLS 550	approx. 3.0 oz (85 g) each	High temperature roller bearing grease
	CLS 63 AMG	approx. 3.2 oz (90 g) each	
Brake system	All models	0.63 US qt (0.6 l)	MB Brake Fluid (DOT 4+)
Cooling system	CLS 550	11.9 US qt (11.3 l)	MB 325.0 Anticorrosion/Antifreeze
	CLS 63 AMG	12.5 US qt (11.8 l)	
Fuel tank including a reserve of	All models	21.12 US gal (80.0 l)	Premium unleaded gasoline Minimum Posted Octane 91 (Avg. of 96 RON/86 MON)
	CLS 550	2.38 US gal (9.0 l)	
	CLS 63 AMG	3.7 US gal (14.0 l)	
Air conditioning system	All models		R-134a refrigerant and special PAG lubricant oil (never R-12)
Windshield washer system	All models	4.8 US qt (4.5 l)	MB Windshield Washer Concentrate ²
Windshield washer and head-lamp cleaning* system	All models	6.9 US qt (6.5 l)	

¹ For detailed information, please refer to the Factory Approved Service Products pamphlet (USA only) or contact an authorized Mercedes-Benz Center.

² Use MB Windshield Washer Concentrate “MB SummerFit” and water for temperatures above freezing or MB Windshield Washer Concentrate “MB SummerFit” and commercially available premixed windshield washer solvent/antifreeze for temperatures below freezing point. Follow suggested mixing ratios (▷ page 456).

Engine oils

Engine oils are specifically tested for their suitability in our engines and durability for our service intervals. Therefore, only use approved engine oils and oil filters required for vehicles with Maintenance System (U.S. vehicles) or FSS PLUS (Canada vehicles). For a listing of approved engine oils and oil filters, refer to the Factory Approved Service Products pamphlet (USA only), or contact an authorized Mercedes-Benz Center.

! *Using engine oils and oil filters of specification other than those expressly required for the Maintenance System (U.S. vehicles) or FSS PLUS (Canada vehicles), or changing of oil and oil filter at change intervals longer than those called for by the Maintenance System (U.S. vehicles) or FSS PLUS (Canada vehicles) will result in engine or emission control system damage not covered by the Mercedes-Benz Limited Warranty.*

Please follow Maintenance System (U.S. vehicles) or FSS PLUS (Canada vehicles) recommendations for scheduled oil changes. Failure to do so could result in engine or emission control system damage not covered by the Mercedes-Benz Limited Warranty.

Engine oil additives

! *Do not blend oil additives with engine oil. They may damage the engine. Damage or malfunctions resulting from blending oil additives are not covered by the Mercedes-Benz Limited Warranty.*

Air conditioning refrigerant

R-134a (HFC) refrigerant and special PAG lubricating oil are used in the air conditioning system.

! *Never use R-12 (CFC) or mineral-based lubricating oil. Otherwise damage to the system will occur.*

Brake fluid

Warning!



During vehicle operation, the boiling point of the brake fluid is continuously reduced through the absorption of moisture from the atmosphere. Under extremely strenuous operating conditions, this moisture content can lead to the formation of bubbles in the system, thus reducing the system's efficiency.

Therefore, the brake fluid must be replaced regularly. Refer to your vehicle's Maintenance Booklet for replacement interval.

Only brake fluid approved by Mercedes-Benz is recommended. Your authorized Mercedes-Benz Center will provide you with additional information.

Fuels, coolants, lubricants etc.

Premium unleaded gasoline

Warning!



Gasoline is highly flammable and poisonous. It burns violently and can cause serious personal injury.

Never allow sparks, flame or smoking materials near gasoline!

Turn off the engine before refueling.

Whenever you are around gasoline, avoid inhaling fumes and skin or clothing contact, extinguish all smoking materials.

Direct skin contact with fuels and the inhalation of fuel vapors can damage your health.

! *To maintain the engine's durability and performance, premium unleaded gasoline must be used. If premium unleaded gasoline is not available and low octane fuel is used, follow these precautions:*

- *Have the fuel tank only partially filled with unleaded regular gasoline and fill up with premium unleaded gasoline as soon as possible.*
- *Avoid full throttle driving and abrupt acceleration*
- *Do not exceed an engine speed of 3000 rpm if the vehicle is loaded with a light load such as two persons and no luggage.*
- *Do not exceed $\frac{2}{3}$ of maximum accelerator pedal position if the vehicle is fully loaded or operating in mountainous terrain.*

Fuel requirements

Only use premium unleaded fuel:

The octane number (posted at the pump) must be 91 min. It is an average of both the Research Octane Number (RON) and the Motor Octane Number (MON): $(RON+MON)/2$. This is also known as the ANTI-KNOCK INDEX.

Unleaded gasoline containing oxygenates such as ethanol, IPA, IBA and TBA can be used provided the ratio of any one of these oxygenates to gasoline does not exceed 10%; MTBE must not exceed 15%.

The ratio of methanol to gasoline must not exceed 3% plus additional cosolvents.

Using mixtures of ethanol and methanol is not allowed. Gasohol, which contains 10% ethanol and 90% unleaded gasoline, can be used.

These blends must also meet all other fuel requirements, such as resistance to spark knock, boiling range, vapor pressure, etc.

Gasoline additives

A major concern among engine manufacturers is carbon build-up caused by gasoline. Mercedes-Benz recommends only the use of quality gasoline containing additives that prevent the build-up of carbon deposits.

After an extended period of using fuels without such additives, carbon deposits can build up especially on the intake valves and in the combustion area, leading to engine performance problems such as:

- Warm-up hesitation
- Unstable idle
- Knocking/pinging
- Misfire
- Power loss

In areas where carbon deposits may be encountered due to lack of availability of gasolines which contain these additives, Mercedes-Benz recommends the use of additives approved by us for use on Mercedes-Benz vehicles. Refer to Factory Approved Service Products Pamphlet (USA only) or contact an authorized Mercedes-Benz Center for a listing of approved product(s). Follow directions on product label.

Do not blend other fuel additives with fuel. This only results in unnecessary costs and may be harmful to the engine operation.

! *Damage or malfunction resulting from poor fuel quality or from blending additional fuel additives other than those tested and approved by us for use on Mercedes-Benz vehicles listed in the Factory Approved Service Products pamphlet are not covered by the Mercedes-Benz Limited Warranty.*

For a listing of approved products, refer to the Factory Approved Service Products pamphlet (USA only) or contact an authorized Mercedes-Benz Center.

Coolants

The engine coolant is a mixture of water and anticorrosion/antifreeze, which provides:

- Corrosion protection
- Freeze protection
- Boiling protection (by increasing the boiling point)

The cooling system was filled at the factory with a coolant providing freeze protection to approximately -22°F (-30°C) and corrosion protection.

! *Add premixed coolant solution only. Adding water and MB 325.0 Anticorrosion/Antifreeze separately from each other, could cause engine damage not covered by the Mercedes-Benz Limited Warranty.*

Fuels, coolants, lubricants etc.

If the antifreeze mixture is effective to -22°F (-30°C), the boiling point of the coolant in the pressurized cooling system is reached at approximately 266°F (130°C).

The coolant solution must be used year round to provide the necessary corrosion protection and increase boil-over protection. Refer to Maintenance Booklet for replacement interval.

Coolant system design and coolant used determine the replacement interval. The replacement interval published in the Maintenance Booklet is only applicable if MB 325.0 Anticorrosion/Antifreeze solution or other Mercedes-Benz approved products of equal specification (see Factory Approved Service Products pamphlet) are used to renew the coolant concentration or bring it back up to the proper level.

For information on other Mercedes-Benz approved products of equal specification, refer to the Factory Approved Service Products pamphlet (USA only) or contact an authorized Mercedes-Benz Center.

To provide important corrosion protection, the solution must be at least 50% anticorrosion/antifreeze (equivalent to freeze protection to approximately -35°F [-30°C]). If you use a solution that is more than 55% anticorrosion/antifreeze (freeze protection to approximately -49°F [-45°C]), the engine temperature will increase due to the lower heat transfer capability of the solution. Therefore, do not use more than this amount of anticorrosion/antifreeze.

If the coolant level is low, water and MB 325.0 Anticorrosion/Antifreeze should be used to bring it up to the proper level (have cooling system checked for signs of leakage). Please make sure the mixture is in accordance with label instructions.

The water in the cooling system must meet minimum requirements, which are usually satisfied by normal drinking water. If you are not sure about the water quality, consult an authorized Mercedes-Benz Center.

Anticorrosion/antifreeze

Your vehicle contains a number of aluminum parts. The use of aluminum components in motor vehicle engines necessitates that anticorrosion/antifreeze coolant used in such engines be specifically formulated to protect the aluminum

parts. Failure to use such anticorrosion/antifreeze coolant will result in a significantly shortened service life.

Therefore, the following product is strongly recommended for use in your vehicle: MB 325.0 Anticorrosion/Antifreeze agent.

Before the start of the winter season (or once a year in hot southern regions), you should have the anticorrosion/antifreeze concentration checked. The coolant is also regularly checked each time you bring your vehicle to your authorized Mercedes-Benz Center for service.

Anticorrosion/antifreeze quantity

Model	Approx. freeze protection	
	-35°F (-37°C)	-49°F (-45°C)
CLS 550	6.0 US qt (5.7 l)	6.6 US qt (6.2 l)
CLS 63 AMG	6.2 US qt (5.9 l)	6.9 US qt (6.5 l)

Fuels, coolants, lubricants etc.

Windshield washer system and headlamp cleaning system*

Both the windshield washer and headlamp cleaning system* are supplied from the windshield washer fluid reservoir.

The washer fluid reservoir has a capacity of approximately 6.9 US qt. (6.5 l).

- ▶ Refill the reservoir with MB Windshield Washer Concentrate and water (or concentrate and commercially available premixed windshield washer solvent/antifreeze, depending on ambient temperatures).

Warning!



Washer solvent/antifreeze is highly flammable. Do not spill washer solvent/antifreeze on hot engine parts, because it may ignite and burn. You can be seriously burned.

Windshield and headlamp washer fluid mixing ratio

For temperatures above freezing point, use MB Windshield Washer Concentrate “MB SummerFit” and water:

- 1 part “MB SummerFit” to 100 parts water
(1.34 fl oz [40 ml] “MB SummerFit” to 1 gallon [4.0 l] water).

For temperatures below freezing point use MB Windshield Washer Concentrate “MB SummerFit” and commercially available premixed windshield washer solvent/antifreeze:

- 1 part “MB SummerFit” to 100 parts solvent
(1.34 fl oz [40 ml] “MB SummerFit” to 1 gallon [4.0 l] solvent).

- A**
- ABS 91
 - Indicator lamp 342
 - Messages in display 358, 372
 - Accelerator position, automatic transmission 175
 - Accessory weight 323
 - Accident 58
 - Active Bi-Xenon headlamps see Headlamps
 - Active head restraints 83
 - resetting 401
 - Adaptive Damping System 231
 - Adjusting 41
 - ADS 231
 - Air bags 66
 - Children 67
 - Front, Driver 69
 - Front, Passenger 69
 - Knee bag 70
 - Safety guidelines 68
 - Side impact 70
 - Window curtain 70
 - Air conditioning refrigerant 451
 - Air conditioning system see Climate control system 203
 - Air conditioning, Cooling 194, 203
 - Air distribution 197
 - Air pressure 323
 - Air pressure see Tire inflation pressure
 - Air pump, electric 417
 - Air recirculation mode 200
 - Air vents 191
 - Air volume 198
 - Airmatic DC (Dual Control) 231
 - Message in display 389, 390
 - Suspension tuning 231
 - Vehicle level control 231
 - Alarm
 - Audible alarm and flashing exterior lamps (Panic alarm) 90
 - Canceling 100
 - Visual 99
 - Alarm system see Anti-theft systems
 - Alignment bolt (vehicle tool kit) 393, 415
 - AMG menu 147
 - Lap analysis 150
 - Overall analysis 150
 - RACETIMER 148
 - Vehicle supply voltage 148
 - Anticorrosion/antifreeze 455
 - Antilock Brake System see ABS
 - Anti-theft systems 99
 - Anti-theft alarm system 99
 - Immobilizer 99
 - Aquaplaning see Hydroplaning
 - Ashtrays 249
 - Aspect ratio 323
 - AUDIO menu 150
 - Audio search function 165
 - Audio system
 - CD mode 151
 - Selecting radio station 151
 - Selecting satellite radio station* 151
 - Auto-dimming, Rear view mirrors 185
 - Automatic central locking, Control system 165

- Automatic climate control (4-zone) 190
 - Air recirculation mode 200
 - Deactivating 195
 - Rear window defroster 189
 - Setting the temperature 197
- Automatic headlamp mode 129
- Automatic lighting control, Interior lighting 135
- Automatic locking when driving 165
- Automatic shift program 177
- Automatic transmission
 - Accelerator position 175
 - Automatic shift program 177
 - Emergency operation (limp-home mode) 184
 - Gear ranges 176
 - Gear selector lever 171
 - Gear selector lever control one-touch gearshifting 178
 - Gear selector lever positions 173
 - Gear shifting malfunctions 184
 - Kickdown 175
 - Kickdown, manual shift program
 - CLS 63 AMG 183
- Manual shift program
 - CLS 63 AMG 181
- Program mode selector switch 177
- Shifting procedure 172
- Starting the engine 51
- Steering wheel gearshift control
 - one-touch gearshifting* 179
- Auxiliary bulbs 404
 - Messages in display 381
- B**
- BabySmart™
 - Airbag deactivation system 76
 - Self-test 77
- Backrest
 - Seat 42
 - Seat, multicontour* 122
- Backup lamps see Reverse lamps
- Bar 323
- BAS 92
- Batteries, SmartKey
 - Checking battery condition 110
 - Replacing 402
- Batteries, SmartKey with KEYLESS-GO*
 - Checking battery condition 110
 - Replacing 402
- Batteries, vehicle 420
 - Charging 422
 - Disconnecting 421
 - Jump starting 423
 - Messages in display 370, 371
 - Reconnecting 422
 - Reinstalling 422
 - Removing 421
- Bead 323
- Beverage holder see Cup holders
- Bi-Xenon headlamps see Headlamps 128
- Block heater* (Canada only) 328
- Brake fluid
 - Checking 285
- Brake lamps
 - Cleaning lenses 336
 - Replacing bulbs 406
- Brake pads
 - Message in display 371
- Brakes
 - High-performance brake system (CLS 63 AMG only) 274
 - Warning lamp 344
- Break-in period 270
- Bulbs, replacing see Replacing bulbs

- C**
- California retail buyers and lessees, important notice for 11
 - Can holder see Cup holders
 - Capacities and recommended fuels/lubricants 449
 - Cargo tie-down rings 243
 - Carpets, cleaning 339
 - Catalytic converter 281
 - CD player 151
 - Center console
 - Lower part 30
 - PASS AIR BAG OFF indicator lamp 353
 - Upper part 29
 - Central locking
 - Automatic 118
 - Locking/unlocking from inside 118
 - Switching on/off (control system) 165
 - Central locking switch 118
 - Certification label 300
 - Checking tire pressure electronically with the Advanced Tire Pressure Monitoring System* (Advanced TPMS*), (Canada only) 309
 - Checking tire pressure electronically with the Tire Pressure Monitoring System (TPMS), (USA only) 306
 - Children in the vehicle 84
 - Air bags 67
 - Indicator lamp, front passenger front air bag 76
 - Infant and child restraint systems 84
 - LATCH-type child seat anchors 88
 - Override switch for rear passenger compartment 89
 - Cigarette lighter 250
 - Climate control system
 - Air conditioning refrigerant 451
 - Air conditioning, Cooling 203
 - Air distribution 197
 - Air recirculation mode 200
 - Air volume 198
 - Automatic mode 196
 - Control panel, Rear 204
 - Deactivating system 196
 - Front defroster 199
 - Maximum cooling MAX COOL 200
 - Rear climate control 204
 - Residual engine heat (REST) 203
 - Clock 27, 159
 - Setting time 159
 - Cockpit 24
 - Cold tire inflation pressure 323
 - Collapsible tire
 - Inflating 416
 - Collapsible wheel chock 395
 - COMAND see separate operating instructions
 - Combination filter with pollutant-sensitive air-recirculation mode 202
 - Combination switch 55, 132
 - Control system 141
 - Functions 145
 - Multifunction display 141
 - Multifunction steering wheel 142
 - Resetting to factory default 155
 - Control system menus 144, 145
 - AUDIO 150
 - Distronic* 153
 - NAV* 152
 - Settings 154
 - Standard display 147
 - TEL* 168
 - Trip computer 167
 - Vehicle status message memory 153

- Control system submenus
 - Convenience 165
 - Instrument cluster 157
 - Lighting 161
 - Time/Date 159
 - Vehicle 164
- Convenience submenu 165
 - Activating easy-entry/exit feature* 166
 - Setting parking position for exterior rear view mirror 166
- Coolant
 - Checking level 290
 - Messages in display 373, 374, 375
 - Temperature 282
 - Temperature indicator 139
 - Warning lamp 347
- Corner-illuminating front fog lamps* 132
- Cruise control 215
 - Canceling 217
 - Driving downhill 216
 - Driving uphill 216
 - Fine adjustment 218
 - Lever 224
 - Saving current speed 216
 - Setting speed 216
- Cruise control lever 215, 224
- Cup holders 247
- Curb weight 323
- D**
- Date display, setting 160, 161
- Daytime running lamp mode 130
 - Setting 161
- Deceleration
 - With Distronic* 222
- Deep water see Standing water
- Defogging windshield 199
- Defrosting
 - Front 199
 - Rear window 189
- Delayed shut-off
 - Exterior lamps 163
 - Interior lighting 164
- Department of Transportation see DOT
- Dialing
 - A number (telephone) 170
- Difficulties
 - While driving 58
 - With starting 52
- Digital clock see Clock
- Digital speedometer 147
- Dimensions, vehicle 448
- Direction of rotation (tires) 295
- Displays
 - Digital speedometer 147
 - Distronic* 221
 - Maintenance service indicator message 329
 - Messages in display 356
 - Multifunction display 141
 - Outside temperature 141, 158
 - Selecting 158
 - Symbol messages 370
 - Text messages 358
 - Vehicle status message memory 153
 - Vehicle system settings, Control system 154
- Distance
 - Decreasing in Distronic* 227
 - Increasing in Distronic* 227
 - Warning function 227
- Distance to empty (range)
 - Trip computer 167

- Distronic* 218
 - Activating/deactivating 223
 - Cleaning system sensor 336
 - Control system 153
 - Distance warning function 227
 - Driving hints 228
 - Intermittent warning sound 227
 - Menu 223
 - Messages in display 359, 360
 - Sensor cover 336
 - Symbol in multifunction display 153
 - Warning and indicator lamps 221
- Door
 - Entry lamps 137
 - Locking/unlocking, SmartKey 104
 - Locking/unlocking, SmartKey with KEYLESS-GO* 108
 - Message in display 370
 - Opening from inside/outside 111
 - Remote door unlock (Tele Aid) 262
- Door control panel 34
- Door handle, inside 34
- DOT 323
- Drinking and driving 271
- Driving
 - Abroad 280
 - Hydroplaning 276
 - In winter 278
 - Instructions 48
 - Problems 58
 - Safety systems 91
 - Systems 215
 - Through standing water 279
 - With DISTRONIC* 218
- Driving off 274
- Driving safety systems
 - ABS 91
 - BAS 92
 - EBP 93
 - Electronic traction system 95
 - ESP® 94
- Driving systems 215
 - Airmatic DC 231
 - Cruise control 215
 - Distronic* 218
 - Parktronic* 235
- Driving tips 175
 - Accelerator position 175
 - Kickdown 175
- Dual control
 - Airmatic DC 231
- E**
 - Easy-entry/exit feature* 45, 166
 - EBP 93
 - Electric air pump 416
 - Electrical fuses see Fuses
 - Electrical system, Technical data 447
 - Electronic Brake Proportioning see EBP
 - Electronic Stability Program see ESP®
 - Emergency calls
 - Tele Aid calls 258
 - Emergency operation
 - (Limp-Home Mode) 184
 - Emergency operations
 - Fuel filler flap 398
 - Gear selector lever, Unlocking 398
 - Locking/unlocking the vehicle 396
 - Power tilt/sliding sunroof, manual operation 400
 - Remote door unlock 262
 - Trunk lid, Releasing from inside 116
 - Trunk lid, Unlocking 112

- Emergency Tensioning Device see ETD
 - Emergency, In case of
 - Batteries, Jump starting 423
 - First aid kit 391
 - Flat tire, changing 412
 - Fuses 428
 - Hazard warning flasher 134
 - Instrument cluster, indicator lamps 342
 - Roadside Assistance 12
 - Towing the vehicle 342
 - Emission control 281
 - Information label 435
 - System warranties 10
 - Vacuum line routing diagram label 435
 - Engine 437
 - Belt layout 436
 - Block heater* (Canada only) 328
 - Break-in recommendations 270
 - Cleaning 334
 - Compartment 286
 - Malfunction indicator lamp 345, 346, 373
 - Maximum engine speed 437
 - Number 434, 435
 - Starting 51
 - Starting with KEYLESS-GO* 52
 - Tachometer 27
 - Technical data 437
 - Turning off with KEYLESS-GO* 61
 - Turning off with the SmartKey 61
 - Engine compartment
 - Hood 286
 - Engine coolant see Coolant 290
 - Engine oil 287, 449
 - Adding 289
 - Additives 451
 - Changing 451
 - Checking level 288
 - Consumption 287
 - Filler neck 289
 - Messages in display 377
 - Oil dipstick 288
 - Recommended engine oils and oil filters 451
 - ESP® 94
 - Messages in display 358, 372
 - Warning lamp 343
 - ETD
 - Safety guidelines 68
 - Exterior lamp switch 128
 - Exterior rear view mirrors 47
 - Parking position 166, 187
 - Exterior view 22
- F**
- Factory settings
 - Resetting 155
 - SmartKey with KEYLESS-GO* 108
 - Filler neck, Engine oil 289
 - First aid kit 391
 - Flat tire 412
 - Collapsible tire 415, 416
 - Jacking up the vehicle 414
 - Lowering the vehicle 418
 - Mounting the spare wheel 412, 415
 - Preparing the vehicle 412
 - Spare wheel 412

- Flexible Service System see FSS PLUS
- Floormats 253
- Fluids
 - Automatic transmission fluid 449
 - Brake fluid 450
 - Capacities 449
 - Engine coolant 450
 - Engine oil 449
 - Power steering fluid 450
 - Windshield washer and headlamp cleaning system 450
- Fog lamp, rear 131
- Fog lamps 131
 - Messages in display 380, 381, 382, 383, 384
- Fog lamps, front
 - Corner-illuminating* 132
 - Switching on 131
- Front air bags 69
- Front lamps see Headlamps
- Front passenger front air bag
 - Messages in display 353
- Front passenger front air bag off indicator lamp 70, 75
- Front seat head restraints see Head restraints
- FSS PLUS (Canada vehicles) 330
- Fuel
 - Additives 453
 - Capacities, Fuel tank 450
 - Filler flap and cap 283
 - Filling the tank 283
 - Fuel reserve warning lamp 348
 - Premium unleaded gasoline 284
 - Requirements
 - Gasoline additives 453
 - Premium unleaded gasoline 452
- Fuel consumption statistics
 - Since last reset 167
 - Since start 167
- Fuel filler flap 283
 - Locking/unlocking 283
 - Opening 283
- Fuel tank
 - Capacity 283
 - Filler flap 283
- Fuels, coolants, lubricants etc. 449
- Fuse box in trunk 429
- Fuses 428
 - Aids for replacing fuses 428
 - Fuse box (main) in passenger compartment 429
 - Fuse box in trunk 429
 - Fuse chart 428
 - Fuse extractor 428
 - Replacing 428
 - Spare fuses 428
- G**
- Garage door opener 263
- Gasoline see Fuel
- GAWR 323
- Gear range
 - Automatic transmission 176
 - Limiting 176
 - Shifting into optimal 179, 181
- Gear selector lever 171
 - Cleaning 339
 - Gearshift pattern 171
 - Lock 51
 - Position 172, 173
 - Shifting procedure 172
 - Unlocking in an emergency 398

- Gear selector lever one-touch gearshifting
 - Automatic transmission 178
- Global locking 104
- Global locking/unlocking see Key, Smart-Key or Key, SmartKey with KEY-LESS-GO*
- Glove box 244
- Good visibility 185
- Gross Axle Weight Rating see GAWR
- Gross Vehicle Weight Rating see GVWR
- Gross Vehicle Weight see GVW
- GVW 323
- GVWR 324
- H**
- Halogen headlamps see Headlamps
- Hands-free microphone 31
- Hard plastic trim items, cleaning 339
- Hazard warning flasher 134
- Head restraints 120
 - Active head restraints 83
 - Comfort head restraint*,
 - Adjusting 43
 - Folding back 121
 - Front seat, Adjusting 43
 - Front seat, Removing
 - Rear seat, Removing and installing 120
- Headlamp cleaning system* 185
- Headlamp shut off delay see Delayed shut-off, Exterior lamps 163
- Headlamps
 - Automatic headlamp mode 129
 - Bi-Xenon headlamps, Active 128
 - Cleaning lenses 336
 - Cleaning system* 185
 - Halogen 405
 - High beam 55
 - High beam flasher 55
 - High beam see High beam headlamps
 - Low beam 55
 - Manual headlamp mode 129
 - Replacing bulbs 404
 - Switch 55
- Headliner and shelf below rear window, cleaning 339
- Heated seats* 123
- Heated steering wheel (Canada only) 252
- Height adjustment
 - Head restraints 43
 - Seats 42
 - Steering wheel 44
 - Vehicle level control 232
- High beam flasher 55, 132
- High beam headlamps
 - Replacing bulbs 408
 - Switching on 55, 132
- High mounted brake lamp 406
- High-performance brake system (CLS 63 AMG only) 274
- Hood 286
 - Message in display 370
- Horn 25
- HVAC see Climate control system
- Hydroplaning 276

I

- Identification labels 434
- Identification Number, Vehicle (VIN) 435
- Ignition 38, 40
- Immobilizer 99
- Indicator lamps see Lamps, indicator and warning
- Infant and child restraint systems see Children in the vehicle
- Inflation pressure see
 - Tires, Inflation pressure 301
- Information button (Tele Aid) 261
- Inside door handle 111
- Installing
 - Wiper blades 411
- Instrument cluster 26, 138
 - Coolant temperature indicator 139
 - Illumination brightness 138
 - Lamps 342
 - Messages in the multifunction display 356
 - Multifunction display 141
 - Outside temperature indicator 140
- Instrument lighting see Instrument cluster, Illumination brightness 138
- Instrument panel see Instrument cluster 138
- Instruments and controls see
 - Cockpit 138
- Interior lighting 135
 - Delayed shut-off 164
- Interior rear view mirror 47, 185
 - Auto dimming 185
- Interior storage space see Storage compartments

J

- Jack 394
- Jacking up the vehicle 414
- Jump starting 423

K

- Key, Mechanical 396
 - Loss of 110

Key, SmartKey

- Battery check lamp 105
- Checking batteries 110
- Factory setting 103
- Global locking 104, 105
- Global unlocking 104
- Locking/unlocking 102, 105
- Loss of 110
- Messages in display 378
- Opening and closing the power tilt/sliding sunroof 210
- Opening and closing the windows 210
- Remote control 102
- Replacing batteries 402
- Restoring to factory setting 105
- Selective setting 104
- Starter switch positions 38
- Starting the engine 51, 52
- Turning off the engine 60

- Key, SmartKey with KEYLESS-GO*
 - Battery check lamp 105
 - Checking batteries 110
 - Factory setting 108
 - Global locking 108, 109
 - Global unlocking 108, 109
 - Locking/unlocking 105
 - Locking/unlocking, Selective setting 109
 - Loss of 110
 - Messages in display 378, 379, 380, 383
 - Opening and closing the power tilt/sliding sunroof 210
 - Opening and closing the windows 210
 - Opening the trunk 112
 - Remote control 105
 - Replacing batteries 402
 - Restoring to factory setting 109
 - Selective setting 109
 - Starter switch positions 39
 - Starting the engine 52
 - Turning off engine 61
 - Turning off the engine 61
- KEYLESS-GO* see Key, SmartKey with KEYLESS-GO*
- Kickdown 175
- Kilopascal 324
- Knee bag 70
- L**
- Labels
 - Certification 434
 - Emission control information 435
 - Vacuum line routing diagram 435
- Lamp bulbs, exterior 404
- Lamps, exterior
 - Front 405
 - Messages in display 380
 - Rear 406
 - Replacing bulbs 404
 - Switching on/off 128
- Lamps, indicator and warning
 - ABS 27, 342
 - Air bag off 70
 - Battery (SmartKey) 104
 - Brakes 344
 - CHECK ENGINE 27, 345, 346
 - Coolant 347
 - Distance warning lamp* 221, 227
 - Engine diagnostics 345, 346
 - Engine malfunction 27, 345, 346
 - ESP® 27, 343
 - Fog lamps 131
 - Front passenger front air bag off 29, 76, 353, 354
 - Fuel reserve 27, 348
 - High beam headlamps 27
 - Instrument cluster 342
 - Seat belt telltale 27, 348, 349
 - SRS 65
 - Turn signals 27
- Language, Setting 157
- LATCH type child seat anchors 88
- Layout of poly-V-belt drive 436
- License plate lamps 406
 - Messages in display 383
 - Replacing bulbs 409
- Light alloy wheels, cleaning 338
- Lighter see Cigarette lighter

- Lighting 128
 - Automatic headlamp mode 129
 - Combination switch 132
 - Daytime running lamp mode 130
 - Door entry lamps 137
 - Exterior lamp switch 128
 - Front fog lamps 131
 - High beams 132
 - Instrument cluster illumination 138
 - Interior 135
 - Locator lighting 131
 - Low beam 128
 - Manual headlamp mode 129
 - Night security illumination 131
 - Parking lamps 128
 - Rear fog lamp 131
 - Settings (control system) 161
 - Trunk lamp 137
- Limp-home mode 184
- Loading see Vehicle loading
- Loading the vehicle 296
- Locator lighting 131, 162
- Lock button (KEYLESS-GO*)
 - Door handle 62
 - Trunk lid 109
- Locking the vehicle 59
 - In an emergency 397
- Locking/Unlocking, SmartKey 36, 104
- Locking/Unlocking, SmartKey with KEYLESS-GO* 37
- Loss of
 - Key, Mechanical 110
 - Key, SmartKey 110
 - Key, SmartKey with KEYLESS-GO* 110
- Loss of Service and Warranty Information
 - Booklet 433
- Low beam headlamps 55
 - Replacing bulbs 408
 - Switching on 55
- Lubricants 449
- Lumbar support 121
- M**
- Main Dimensions 448
- Maintenance 12
 - Calling up service indicator 331
 - Clearing service indicator message 330
 - FSS PLUS (Canada vehicles) 330
 - Maintenance System 330
 - Resetting service indicator 331
 - Service indicator message 329
 - Service term exceeded 330
- Manual headlamp mode 129
- Manual shift program CLS 63 AMG 181
 - Deactivating 183
- Maximum load rating, Tires 324
- Maximum loaded vehicle weight 324
- Maximum tire inflation pressure 324
- Mechanical key 396
- Memory functions 125
- Menus see Control system menus
- Microphone, Hands-free 31

- Minispare wheel see Spare wheel 391
 - Mirrors
 - Adjusting 46
 - Auto-dimming 185
 - Exterior rear view mirror 47
 - Exterior rear view mirror parking positions 166, 187
 - Interior rear view mirror 47
 - Storing exterior mirror parking position 127
 - Mobile phone see Telephone*
 - MOE tires* see MOExtended system*
 - MOExtended system* 313, 419
 - MOExtended tires* 313, 444
 - MON 284
 - MP3
 - Selecting track 152
 - Multicontour seat* 122
 - Multifunction display 141
 - Changing settings see Control system menus and Control system submenus 141
 - Selecting language 157
 - Multifunction display messages
 - ABS 358, 372
 - Airmatic DC 389, 390
 - Brake fluid 372
 - Brake pads 371
 - Check engine 345, 346
 - Coolant 373, 374, 375
 - Cruise control 359
 - Distronic* 359
 - Door 370
 - Engine oil 377
 - ESP® 358, 361, 372
 - Fog lamps 380, 381, 382, 383, 384
 - Hood 370
 - Light sensor 383
 - Parking brake 372
 - Parking lamps 382
 - PRE-SAFE® 358, 366
 - Reserve fuel 378
 - SmartKey with KEYLESS-GO* 378, 379, 380
 - SRS 386
 - Taillamps 384, 385
 - Tele Aid 386
 - Telephone* 389
 - Tires 388
 - Trunk 370
 - Turn signals 385
 - Windshield washer fluid 389
 - Multifunction steering wheel 28, 142
 - Button operation 142
- N**
- NAV* menu (Control system) 152
 - Navigation system see separate COMAND operating instructions
 - Net, parcel 246
 - Neutral gear position, Automatic transmission 171, 173
 - Night security illumination 131
 - Normal occupant weight 324
 - Number, Vehicle Identification (VIN) 434

- O**
- Occupant Classification System see OCS
 - Occupant distribution 324
 - Occupant safety 64
 - Air bags 66
 - Children and air bags 67
 - Children in the vehicle 84
 - Fastening the seat belt 48
 - Front passenger front air bag off indicator lamp 75
 - Infant and child restraint systems 84
 - LATCH type child seat anchors 88
 - OCS 71
 - Seat belts 48, 68
 - OCS 71
 - Self-test 76
 - Odometer 27
 - Oil
 - Consumption 287
 - Oil see Engine oil
 - One-touch gearshifting
 - Gear selector lever 178
 - Steering wheel gearshift control* 179
 - Operating safety 16
 - Ornamental moldings, cleaning 335
 - Outside temperature see Displays
 - Overdue maintenance service 329
 - Overhead control panel 31
- P**
- Paintwork, Cleaning 334
 - Panic alarm 90
 - Parcel net
 - Front passenger footwell 246
 - Parking 59
 - On hills 59
 - Over things that burn, Potential consequences 59
 - Parking brake 53, 59
 - Message in display 372
 - Parking lamps 405
 - Replacing bulbs 409
 - Parking position
 - Exterior rear view mirrors 127, 166
 - Gear position 51
 - Parktronic system (Parking assist)* see Parktronic*
 - Parktronic* 235
 - Activating/deactivating 238
 - Cleaning system sensors 336
 - Malfunctioning 238
 - Minimum distance 236
 - Range 235
 - System sensors 336
 - Warning indicators 25, 237
 - Warning sounds 238
 - Parts service 432
 - PASS AIR BAG OFF indicator lamp see Front passenger front air bag off indicator lamp
 - Passenger compartment
 - Interior lighting 135
 - Interior rear view mirror 47
 - Main fuse box 429
 - Parcel net in the front passenger footwell 246
 - Passenger safety see Occupant safety
 - Pedals 271
 - Phone see Telephone*
 - Plastic parts, cleaning 338

- Pliers, universal (vehicle tool kit) 393
 - Poly-V-belt drive
 - Layout 436
 - Positions (Memory function) see Seats
 - Power assistance 272
 - Power outlet 251
 - Power seat see Seats 43
 - Power tilt/sliding sunroof 212
 - Opening/closing 212
 - Opening/closing in an emergency 400
 - Stopping 214
 - Synchronizing 214
 - Power washer 333
 - Power windows 207
 - Cleaning 337
 - Operating 207
 - Rear door window, blocking operation 89
 - Side windows 207
 - Synchronizing 209
 - Practical hints 342
 - PRE-SAFE®
 - Messages in display 358
 - Problems
 - While driving 58
 - With vehicle 17
 - Product information 9
 - Production options weight 324
 - Program mode see Automatic transmission, Automatic shift program
 - Program mode selector switch
 - Automatic shift program 177
 - PSI 324
 - Push-start see Tow-start
- R**
- RACETIMER 148
 - Radio
 - Selecting stations 151
 - Selecting stations (satellite*) 151
 - Radio transmitters 280
 - Range (distance to empty) 168
 - Reading lamp
 - Front 135
 - Rear 136
 - Rear door ashtray see Ashtrays 250
 - Rear door window
 - Blocking operation 89
 - Rear fog lamp see Fog lamps
 - Rear lamp 406
 - Rear lamps see Tail lamps
 - Rear seat head restraints see Head restraints
 - Rear storage compartment in the rear center console 245
 - Rear view mirrors see Mirrors
 - Rear window defroster 189
 - Rear window sunshade* 188
 - Recommended tire inflation pressure 324
 - Recovery services, Stolen vehicle (Tele Aid) 263
 - Refrigerant, Air conditioning 451

- Refueling 283
- Regular checks 285
- Reminder, seat belts see Seat belts, Tell-tale
- Remote control see Key, SmartKey
- Remote door unlock (Tele Aid) 262
- Replacing bulbs
 - Additional turn signals 407
 - Brake lamps 407
 - Front lamps 407
 - Headlamps 405
 - High beam headlamps 408
 - High mounted brake lamp 407
 - License plate lamps 409
 - Low beam headlamps 408
 - Parking lamps 409
 - Side marker lamps 407
 - Tail lamps 409
 - Turn signal lamps 408
- Reporting safety defects 18
- Research octane number see RON
- Reserve fuel
 - Message in display 378
- Reset button in the instrument
 - cluster 138, 155
- Reset tool (Active head restraints) 401
- Restraint system see Children in the vehicle
- Retaining hooks 243
- Reverse gear position, Automatic
 - transmission 171, 173
- Rims 324, 438
- Roadside assistance 12
 - Button 260
- RON 284
- Roof rack* 239
- Rotating tires 326
- Rubber parts, cleaning 338
- Run Flat Indicator* 304
- S**
- Safety
 - Driving safety systems 91
 - Occupant 64
 - Reporting defects 18
- Safety belts see Seat belts
- Satellite radio* 151
- Seat belt force limiter 81
- Seat belts 78
 - Children in the vehicle 84
 - Cleaning 339
 - Fastening 48
 - Height adjustment 50
 - Proper use of 50, 79
 - Safety guidelines 68
 - Telltale 27, 348, 349
 - Warning lamp 348, 349
- Seating capacity 297
- Seats 41, 120
 - Adjusting 41
 - Easy entry/exit feature* 45
 - Heater* 123
 - Memory function 125
 - Multicontour seat* 122
 - Ventilation* 124
- Securing cargo
 - Cargo tie-down rings 243
- Selecting display 158

- Selective setting see Key, SmartKey or Key, SmartKey with KEYLESS-GO*
- Selector lever see Gear selector lever
- Self-test
 - BabySmart™ airbag deactivation system 77
 - OCS 76
 - Tele Aid 258
- Service and warranty information 10
- Service intervals see Maintenance, Service indicator
- Service life
 - Tires 294
- Service see Maintenance
- Service system see FSS PLUS (Canada vehicles) or Maintenance system (US vehicles)
- Service, Parts 432
- Settings 108, 154
 - Control system menus and submenus 143
 - Date 160
 - Individual, Vehicle 154
 - Memory function 126
 - Resetting all, Control system 155
 - Selective, SmartKey 104
 - Selective, SmartKey with KEYLESS-GO* 109
 - Suspension tuning 231
 - Temperature (interior) 197
 - Time 159
- Settings menu
 - Functions in 154
 - Submenus 155
- Shelf below rear window, cleaning 339
- Shift program mode, Automatic transmission 177
- Shifting, Automatic transmission 171
- Side impact air bags 70
- Side marker lamps
 - Cleaning lenses 336
- Side windows
 - Synchronizing power windows 209
- Side windows see Power windows
- Sidewall 324
- Ski bag* (Canada only) 240
- SmartKey see Key, SmartKey
- SmartKey with KEYLESS-GO* see Key, SmartKey with KEYLESS-GO*
- Snow chains 328
- Snow tires 327
- Spare fuses 428
- Spare wheel 391, 445
 - Mounting 412
- Speed settings
 - Cruise control 215
 - Distronic* 224

- Speedometer 27
 - Selecting display mode 157
- SRS 64
 - Indicator lamp 27, 350
 - Messages in display 386
- Standing lamps 128
- Standing water, Driving through 279
- Starter switch 38
- Starter switch positions 38
- Starting difficulties 52
- Starting position 38
- Starting the engine
 - SmartKey 51
 - SmartKey with KEYLESS-GO* 52
- Steering wheel 28
 - Adjustment 44
 - Buttons 28
 - Cleaning 339
- Steering wheel gearshift control one-touch gearshifting*
 - Automatic transmission 179
- Stolen Vehicle Recovery services 263
- Storage compartments 32, 244
 - Center armrest 244
 - Cup holder 247
 - Glove box 244
 - Parcel net in front passenger footwell 246
 - Rear armrest 245
 - Rear center console 245
 - Ruffled storage bags 246
 - Under seat 245
- Storing
 - Positions into memory (Memory function*) 126
 - Tires 295
- Submenus see Control system submenus
- Substitute bulbs see Auxiliary bulbs
- Sun visors 187
- Sunroof see Power tilt/sliding sunroof
- Sunshade*, rear window 188
- Suspension tuning
 - For comfortable driving style 231
 - For sporty driving style 231
- Symbols used in this operator's manual 15
- T**
- Tachometer 27, 139
 - Overspeed range 139
- Tail lamps
 - Messages in display 384, 385
 - Replacing bulbs 409
- Tar stains 333
- Technical data
 - Air conditioning refrigerant 451
 - Brake fluid 451
 - Capacities fuels, lubricants etc. 449
 - Coolant 453
 - Dimensions 448
 - Electrical system 447
 - Engine 437
 - Engine oil additives 451
 - Engine oils 451
 - Fuel requirements 452
 - Gasoline additives 453
 - Premium unleaded gasoline 452
 - Rims and tires 438
 - Weights 448
 - Windshield washer and headlamp cleaning system 450

- Tele Aid 257
 - Emergency calls 258
 - Information 261
 - Initiating an emergency call manually 259
 - Messages in display 386
 - Remote door unlock 262
 - Roadside assistance 260
 - SOS button 259
 - Stolen vehicle Recovery services 263
 - System self-check 258
- Telephone cradle
 - Changing 256
- Telephone* 28, 254
 - Answering/ending a call 169
 - Changing mobile phone cradle 256
 - Compartment 244
 - Hands-free microphone 31
 - Inserting in cradle 255
 - Installing a different mobile phone cradle 256
 - Messages in the display 389
 - Operation 168
 - Phone book 170
 - Redialing 170
 - Removing from cradle 256
- Temperature
 - Engine 54
 - Interior temperature 197
 - Outside temperature 158
- Tether anchorage points, see Children in the vehicle
- Tie-down rings, Trunk 243
- Tightening torque, Wheel bolts 418
- Time
 - Setting 159
 - Synchronizing 159
- TIN 325
- Tire and Loading Information
 - Placard 296
 - Terminology 323
- Tire inflation pressure
 - Checking 301
 - Placard on the fuel filler flap 297
- Tire Pressure Monitoring System (TPMS), (USA only)
 - Checking tire pressure electronically 306
- Tires
 - Advanced Tire Pressure Monitoring System* (Advanced TPMS*) (Canada only) 309
 - Advanced TPMS* malfunction telltale 351
 - Air pressure 301
 - Care and maintenance 294
 - Cleaning 295
 - Combination low tire pressure/TPMS malfunction telltale, USA only 27
 - Direction of rotation, Spinning 295
 - Driving instructions 275
 - Important notes, Tire inflation pressure 302
 - Inflation pressure 301, 302
 - Information placard 297
 - Inspection 294
 - Load rating 325
 - Low tire pressure telltale* (Canada only) 27, 351
 - Messages in display 367, 388
 - MO*Extended** 313, 419
 - Ply composition and material used 325
 - Problems with under-/overinflation 312
 - Retreads 293
 - Rims and tires 438
 - Rotation 326

- Service life 294
- Sizes 439
- Snow 327
- Snow chains 328
- Spare wheel 391
- Speed rating 316, 325
- Storing 295
- Temperature 302, 322
- Terminology 323
- Tire Identification Number see TIN
- Tire Pressure Monitoring System (TPMS) (USA only) 306
- TPMS malfunction telltale 351
- Traction 276, 321, 325
- Tread 325
- Tread depth 294, 327
- Treadwear indicators 325
- Vehicle maximum load on 325
- Wear pattern 326
- Winter 327
- Tools 393
- Top tether
 - Children in the vehicle 87
- Total load limit 325
- Towing eye bolt 426
- Towing the vehicle 425
- Tow-start 423, 425
- Traction 325
- Transmission fluid level 289
- Transmission gear selector lever see Gear selector lever
- Transmission see Automatic transmission
- Traveling abroad 280
- Tread 325
- Tread depth 294, 327
- Tread depth (tires) 327
- Treadwear indicators 325
- Trip computer 167
- Trip odometer
 - Resetting 139
- Trunk
 - Closing the lid 113
 - Fuse box 429
 - Lamp 137
 - Lock button, KEYLESS-GO* 109
 - Message in display 370
 - Opening 112
 - Tie-down rings 243
 - Trunk lid emergency release 116
 - Unlocking in an emergency 397
 - Valet locking 117
- Turn signals 55
 - Additional in mirrors 405
 - Bulbs 405
 - Cleaning lenses 336
 - Indicator lamps 27
 - Messages in display 385
 - Replacing bulbs 408
- Turning off engine 60
- U**
- Uniform Tire Quality Grading Standards 325
- Units, Settings
 - Speedometer 157
 - Temperature 158
- Unleaded gasoline, Premium 452
- Unlocking 36
 - In an emergency 396
 - Mechanical Key 396
- Uphill driving, Cruise control 216
- Upholstery
 - Cleaning 339
- Useful features 244

V

- Vacuum line routing diagram label 435
- Valet locking 117
- Vehicle
 - Battery 420
 - Care 332
 - Control system, settings menu 141
 - Dimensions 448
 - Individual settings 154
 - Locking/unlocking 102
 - Locking/unlocking in an emergency 396, 397
 - Lowering 418
 - Modifications and alterations, operating safety 16
 - Towing 425
 - Washing 334
 - Weights 448
- Vehicle jack 394
- Vehicle level control see Airmatic DC (Dual Control)
- Vehicle lighting
 - Checking 285

Vehicle loading

- Cargo tie-down rings 243
- Instructions 239
- Load limit 296
- Roof rack* 239
- Ski bag* 240
- Terminology 323
- Vehicle maximum load on the tire 325
- Vehicle Recovery services, Stolen (Tele Aid) 263
- Vehicle status message memory 153
- Vehicle tool kit 393
- Vehicle washing 332

W

- Warning lamps see Lamps, indicator and warning
- Warning sounds
 - Distance warning function* 227
 - Distronic* 222
 - Driver's or passenger's seat belt 80
 - Parking brake 53
 - Parktronic* 235
 - Seat belt telltale 349

- Warranty coverage 433
- Washer fluid see Windshield washer fluid
- Washer reservoir level 292
- Washing the vehicle 332
- Wear pattern, Tires 326
- Weights, Vehicle 448
- Wheel
 - Change 412
 - Removing 415
 - Spare 391
 - Tightening torque 418
- Wheels, Sizes 439
- Wheels, Tires and 293
- Window curtain air bags 70
- Windows see Power windows
- Windows, cleaning 337
- Windshield
 - Cleaning wiper blades 337
 - Defogging 199
- Windshield washer fluid 292
- Messages in display 389
- Refilling 292
- Wiping 58

- Windshield washer system 58
- Windshield wipers 56
 - Cleaning wiper blades 337
 - Replacing wiper blades 410, 411
 - Wiping with windshield washer fluid 58
- Winter driving
 - Block heater* (Canada only) 328
 - Snow chains 328
 - Tires 327
- Winter driving instructions 278
- Winter tires 327
- Wood trims, cleaning 340

X

- Xenon headlamps see Headlamps,
Bi-Xenon

Service and Literature

Your authorized Mercedes-Benz Center has trained technicians and Genuine Mercedes-Benz Parts to service your vehicle properly.
For expert advice and quality service, contact an authorized Mercedes-Benz Center.

If you are interested in obtaining service literature for your vehicle, please contact an authorized Mercedes-Benz Center.
We consider this the best way for you to obtain accurate information for your vehicle.

For further information you can find us on the Mercedes-Benz web-site www.mbusa.com or www.mercedes-benz.ca.

Warning!



To help avoid personal injury, be extremely careful when performing any service work or repairs. Improper or incomplete service or the use of incorrect or inappropriate parts or materials may damage the vehicle or its equipment, which may in turn result in personal injury.

If you have any questions about carrying out any type of service, turn to the advice of an authorized Mercedes-Benz Center.

We reserve the right to make changes in design and equipment.

Therefore, information, illustrations and descriptions in this Operator's Manual might differ from your vehicle.
Reprinting, translation and copying, even of excerpts, is not permitted without our prior authorization in writing.

Press time August 02, 2006

GSP/TIP

Printed in U. S. A.

