

Acheron® Designer Screen Channel Loudspeaker



***Keep these important operating instructions.
Check www.meyersound.com for updates.***

DECLARATION OF CONFORMITY ACCORDING TO ISO/IEC GUIDE 22 AND EN 45014

Manufacturer's Name: Meyer Sound Laboratories Inc.

Manufacturer's Address: 2832 San Pablo Avenue
Berkeley, CA 94702-2204, USA

Declares that the product:

Product Names: Acheron Designer Screen Channel Loudspeaker System

Product Options: All

Conforms to the following Product Specifications:

Safety: EN 60065:2002

Supplementary Information: The product herewith complies with the requirements of the Low Voltage Directive (LVD) 2006/95/EC and the EMC Directive 2004/108/EC.

Signature:



Ms. Margie Garza
Director of Quality
Meyer Sound Laboratories Inc.
Berkeley, California 94702 USA
Issued October 13, 2011

European Contact:
Your local Meyer Sound dealer or
Meyer Sound Germany, GmbH.

© 2012

Meyer Sound. All rights reserved.





Acheron Designer Operating Instructions, PN 05.211.005.01 A

The contents of this manual are furnished for informational purposes only, are subject to change without notice, and should not be construed as a commitment by Meyer Sound Laboratories Inc. Meyer Sound assumes no responsibility or liability for any errors or inaccuracies that may appear in this manual. Except as permitted by applicable copyright law, no part of this publication may be reproduced, stored in a retrieval system, or transmitted, in any form or by any means, electronic, mechanical, recording or otherwise, without prior written permission from Meyer Sound.

EXP, Intelligent AC, MAPP Online Pro, RMS, QuietCool, and all alpha-numeric designations for Meyer Sound products and accessories are trademarks of Meyer Sound. Acheron Designer, Compass, Galileo, Meyer Sound, the Meyer Sound wave logo, and SIM are registered trademarks of Meyer Sound Laboratories Inc. (Reg. U.S. Pat. & Tm. Off.). All third-party trademarks mentioned herein are the property of their respective trademark holders.

SYMBOLS USED

These symbols indicate important safety or operating features in this booklet and on the chassis:

			
Dangerous voltages: risk of electric shock	Important operating instructions	Frame or chassis	Protective earth ground
Pour indiquer les risques résultant de tensions dangereuses	Pour indiquer important instructions	Masse, châssis	Terre de protection
Warnung vor gefährlicher elektrischer Spannung	Wichtige Betriebsanweisung oder Gebrauchsanleitung	Rahmen oder Gehäuse	Masse Schutzleiter
Para indicar voltajes peligrosos	Instrucciones importantes de funcionamiento y/o mantenimiento	Armadura o chasis	Tierra proteccionista

IMPORTANT SAFETY INSTRUCTIONS

1. Read these instructions.
2. Keep these instructions.
3. Heed all warnings.
4. Follow all instructions.
5. Do not use this loudspeaker near water.
6. Clean only with dry cloth.
7. Do not block any ventilation openings. Install in accordance with Meyer Sound's installation instructions.
8. Do not install near any heat sources such as radiators, heat registers, stoves, or other apparatus that produce heat.
9. Do not defeat the safety purpose of the grounding-type plug. A grounding type plug has two blades and a third grounding prong. The third prong is provided for your safety. If the provided plug does not fit into your outlet, consult an electrician for replacement of the obsolete outlet.
10. Protect the power cord from being walked on or pinched, particularly at plugs, convenience receptacles, and the point where they exit from the loudspeaker. The AC mains plug or appliance coupler shall remain readily accessible for operation.
11. Only use attachments/accessories specified by Meyer Sound.
12. If applicable, use only with the caster rails or rigging specified by Meyer Sound, or sold with the loudspeaker. Handles are for carrying only.

 **CAUTION:** Rigging should only be done by experienced professionals.
13. Unplug this loudspeaker during lightning storms or when unused for long periods of time.
14. Disconnect the mains plug before disconnecting the power cord from the loudspeaker.
15. Refer all servicing to qualified service personnel. Servicing is required when the loudspeaker has been damaged in any way, such as when the power-supply cord or plug has been damaged; liquid has been spilled or objects have fallen into the loudspeaker; rain or moisture has entered the loudspeaker; the loudspeaker has been dropped; or when for undetermined reasons the loudspeaker does not operate normally.

 **CAUTION:** To reduce the risk of electric shock, do not expose this loudspeaker to rain or moisture. Do not install the loudspeaker in wet or humid locations without using weather protection equipment from Meyer Sound.

SAFETY SUMMARY

English

- To reduce the risk of electric shock, disconnect the loudspeaker from the AC mains before installing audio cable. Reconnect the power cord only after making all signal connections.
- Connect the loudspeaker to a two-pole, three-wire grounding mains receptacle. The receptacle must be connected to a fuse or circuit breaker. Connection to any other type of receptacle poses a shock hazard and may violate local electrical codes.
- Do not install the loudspeaker in wet or humid locations without using weather protection equipment from Meyer Sound.
- Do not allow water or any foreign object to get inside the loudspeaker. Do not put objects containing liquid on or near the unit.
- To reduce the risk of overheating the loudspeaker, avoid exposing it to direct sunlight. Do not install the unit near heat-emitting appliances, such as a room heater or stove.
- This loudspeaker contains potentially hazardous voltages. Do not attempt to disassemble the unit. The unit contains no user-serviceable parts. Repairs should be performed only by factory-trained service personnel.

Français

- Pour réduire le risque d'électrocution, débrancher la prise principale de l'haut-parleur, avant d'installer le câble d'interface allant à l'audio. Ne rebrancher le bloc d'alimentation qu'après avoir effectué toutes les connections.
- Branchez l'haut-parleur dans une prise de courant à 3 dérivations (deux pôles et la terre). Cette prise doit être munie d'une protection adéquate (fusible ou coupe-circuit). Le branchement dans tout autre genre de prise pourrait entraîner un risque d'électrocution et peut constituer une infraction à la réglementation locale concernant les installations électriques.

- Ne pas installer l'haut-parleur dans un endroit où il y a de l'eau ou une humidité excessive.
- Ne pas laisser de l'eau ou tout objet pénétrer dans l'haut-parleur. Ne pas placer de récipients contenant un liquide sur cet appareil, ni à proximité de celui-ci.
- Pour éviter une surchauffe de l'haut-parleur, conserver-la à l'abri du soleil. Ne pas installer à proximité d'appareils dégageant de la chaleur tels que radiateurs ou appareils de chauffage.
- Ce haut-parleur contient des circuits haute tension présentant un danger. Ne jamais essayer de le démonter. Il n'y a aucun composant qui puisse être réparé par l'utilisateur. Toutes les réparations doivent être effectuées par du personnel qualifié et agréé par le constructeur.

Deutsch

- Um die Gefahr eines elektrischen Schlages auf ein Minimum zu reduzieren, den Lautsprecher vom Stromnetz trennen, bevor ggf. ein Audio-Schnittstellensignalkabel angeschlossen wird. Das Netzkabel erst nach Herstellung aller Signalverbindungen wieder einstecken.
- Der Lautsprecher an eine geerdete zweipolige Dreiphasen-Netzsteckdose anschließen. Die Steckdose muß mit einem geeigneten Abzweigschutz (Sicherung oder Leistungsschalter) verbunden sein. Der Anschluß der unterbrechungsfreien Stromversorgung an einen anderen Steckdosentyp kann zu Stromschlägen führen und gegen die örtlichen Vorschriften verstoßen.
- Der Lautsprecher nicht an einem Ort aufstellen, an dem sie mit Wasser oder übermäßig hoher Luftfeuchtigkeit in Berührung kommen könnte.
- Darauf achten, daß weder Wasser noch Fremdkörper in das Innere den Lautsprecher eindringen. Keine Objekte, die Flüssigkeit enthalten, auf oder neben die unterbrechungsfreie Stromversorgung stellen.

- Um ein Überhitzen dem Lautsprecher zu verhindern, das Gerät vor direkter Sonneneinstrahlung fernhalten und nicht in der Nähe von wärmeabstrahlenden
- Haushaltsgeräten (z.B. Heizgerät oder Herd) aufstellen.
- Im Inneren diesem Lautsprecher herrschen potentiell gefährliche Spannungen. Nicht versuchen, das Gerät zu öffnen. Es enthält keine vom Benutzer reparierbaren Teile. Reparaturen dürfen nur von ausgebildetem Kundendienstpersonal durchgeführt werden.

Español

- Para reducir el riesgo de descarga eléctrica, desconecte de la red de voltaje el altoparlante antes de instalar el cable de señal de audio. Vuelva a conectar la alimentación de voltaje una vez efectuadas todas las interconexiones de señalización de audio.
- Conecte el altoparlante a un tomacorriente bipolar y trifilar con neutro de puesta a tierra. El tomacorriente debe estar conectado a la protección de derivación apropiada (ya sea un fusible o un disyuntor). La conexión a cualquier otro tipo de tomacorriente puede constituir peligro de descarga eléctrica y violar los códigos eléctricos locales.
- No instale el altoparlante en lugares donde haya agua o humedad excesiva.
- No deje que en el altoparlante entre agua ni ningún objeto extraño. No ponga objetos con líquidos encima de la unidad ni cerca de ella.
- Para reducir el riesgo de sobrecalentamiento, no exponga la unidad a los rayos directos del sol ni la instale cerca de artefactos que emiten calor, como estufas o cocinas.
- Este altoparlante contiene niveles de voltaje peligrosos en potencia. No intente desarmar la unidad, pues no contiene piezas que puedan ser reparadas por el usuario. Las reparaciones deben efectuarse únicamente por parte del personal de mantenimiento capacitado en la fábrica.

CONTENTS

Chapter 1: Introduction	7
How to Use This Manual	7
Acheron Designer Screen Channel Loudspeaker	7
Chapter 2: Power Requirements	9
AC Connectors	9
Wiring for AC Connections	10
AC Power Distribution	10
Acheron Designer Voltage Requirements	11
Powering Up the Acheron Designer	11
Acheron Designer Current Requirements	11
Electrical Safety Guidelines	12
Chapter 3: Amplification and Audio	13
Audio Connectors	13
Limiting	14
On/Status LED	15
Chapter 4: Rigging	17
MYA-DES Cradle-Style Yoke	17
Chapter 5: RMS Remote Monitoring System	19
RMS Software	19
RMS Module	20
Neuron ID for the RMS Module	21
Resetting the RMS Module	21
Chapter 6: System Design and Integration Tools	23
MAPP Online Cinema	23
SIM 3 Measurement System	24
Appendix A: Acheron Designer Specifications	25

CHAPTER 1: INTRODUCTION

HOW TO USE THIS MANUAL

Make sure to read these operating instructions in their entirety before configuring a loudspeaker system with Acheron Designer loudspeakers. In particular, pay close attention to material related to safety issues.

As you read these operating instructions, you will encounter the following icons for notes, tips, and cautions:

 **NOTE:** A note identifies an important or useful piece of information relating to the topic under discussion.

 **TIP:** A tip offers a helpful tip relevant to the topic at hand.

 **CAUTION:** A caution gives notice that an action may have serious consequences and could cause harm to equipment or personnel, and could cause delays or other problems.

Information and specifications are subject to change. Updates and supplementary information are available at www.meyersound.com.

Meyer Sound Technical Support is available at:

- **Tel:** +1 510 486.1166
- **Tel:** +1 510 486.0657 (after hours support)
- **Web:** www.meyersound.com/support
- **Email:** techsupport@meyersound.com

ACHERON DESIGNER SCREEN CHANNEL LOUDSPEAKER

At the heart of Meyer Sound's EXP line of cinema products are the Acheron® high-performance screen channel loudspeakers. The Acheron Designer is the most compact of the Acheron models, making it an excellent choice for sound design suites, screening rooms, private theatres, and small commercial theatres. Optimized for installation behind perforated screens, the Acheron Designer combines the advantages of self-powered technology and innovative horn design to deliver exceptional, precise coverage for the left, center, and right screen channels for cinema.



Acheron Designer (without Optional Grille Frame)

The Acheron Designer uses the same patent-pending horn technology and high-frequency compression driver as the other Acheron models, delivering the same 38 Hz to 17 kHz frequency response. This consistency of fidelity between Acheron models ensures that soundtracks monitored with the Acheron Designer translate accurately when played back in larger rooms with the Acheron 100, Acheron 80, Acheron Studio, or other calibrated cinema system.

Designed specifically for cinema, the Acheron horn features a very soft roll-off beyond its 80-degree horizontal by 50-degree vertical coverage pattern. The extremely well-behaved horn ensures an accurate acoustic crossover and consistent vertical coverage pattern through the critical crossover range between the low- and high-frequency drivers. The optimized crossover point places most of the dialog in the horn, which is ideal for cinema applications.

Designed and manufactured at Meyer Sound's headquarters in Berkeley, California, the Acheron Designer's drivers include one 12-inch low-frequency cone driver, housed in an optimally tuned, ported enclosure, and one high-frequency 4-inch diaphragm compression driver. The drivers yield uncompromising quality and are powered by sophisticated onboard amplification. The self-powered design ensures consistent results and simplifies installations in both new and existing rooms.



Acheron Designer with Recessed Heat Sink

A proprietary two-channel, Class-D amplifier powers each driver channel independently. Onboard processing includes driver protection circuitry, an electronic crossover, and correction filters, ensuring flat frequency and phase responses. The rear-mounted, recessed heat sink yields efficient convection cooling, and allows the unit to be placed flat against walls, when necessary.

The optional RMS™ remote monitoring system provides comprehensive monitoring of system parameters on a Windows®-based computer.

The Acheron Designer enclosure is constructed of premium birch plywood and coated with a low-gloss, black-textured finish. The cabinet bottom is fitted with two threaded M6 attachment points for the optional MYA-DES cradle-style yoke, allowing the unit to be suspended from a single hanging point.



Acheron Designer with Optional MYA-DES Cradle-Style Yoke

An optional, black cloth grille frame update kit is available for installations where the Acheron Designer is not placed behind a screen.

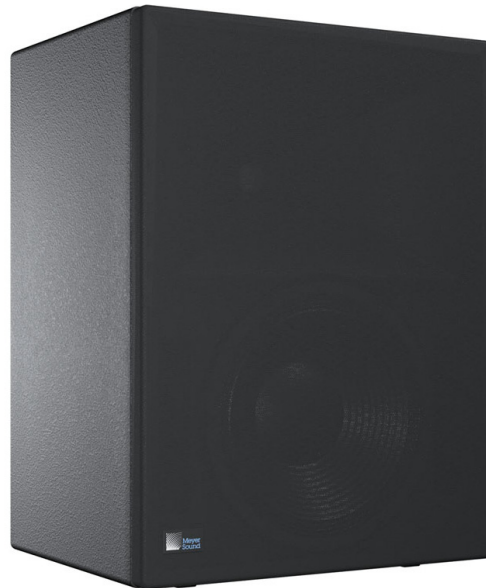

Acheron Designer with Optional Grille Frame

CHAPTER 2: POWER REQUIREMENTS

The Acheron Designer combines advanced loudspeaker technology with equally advanced power capabilities. Understanding power distribution, voltage and current requirements, and electrical safety guidelines is critical to the safe operation of the Acheron Designer.

AC CONNECTORS

The Acheron Designer user panel includes 3-pole, PowerCon AC connectors.

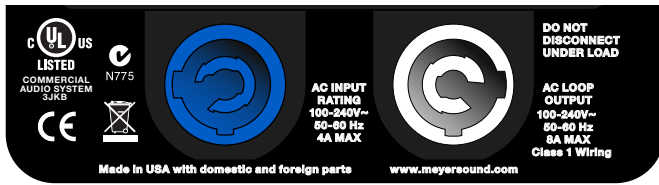

AC Input (Left) and AC Loop Output (Right) Connectors

AC Input Connector (Blue)

The blue AC Input connector supplies power to the Acheron Designer loudspeaker. The connector is rated at 20 amps and uses a PowerCon3 AC mains locking connector that prevents accidental disconnections. A 10-foot AC power cable, rated at 15 amps, is included with each Acheron Designer. If you replace the included AC power cable, make sure to use a cable with the appropriate power plug (on the other end) for the region in which you will operate the unit.

The AC Input connector also supplies power to any additional loudspeakers connected to the Acheron Designer's gray Loop Output connector. Each Acheron Designer loudspeaker requires approximately 3.24 A rms maximum at 115 V AC and 1.74 A rms maximum at 230 V AC for proper operation.

CAUTION: When using the included AC power cable, do not loop more than three additional Acheron Designers from the AC Loop Output connector at 115 V (four total for the circuit), and not more than seven at 230 V (eight total for the circuit).

AC Loop Output Connector (Gray)

The gray AC Loop Output connector allows multiple Acheron Designers to be looped and powered from a single power source. Connect the AC Loop Output of the first Acheron Designer to the AC Input of the second unit, and so forth. The AC Loop Output uses a PowerCon3 AC mains locking connector that prevents accidental disconnections.

The maximum number of loudspeakers that can be looped from the Loop Output connector is determined by the voltage of the power source, the current draw of the looped loudspeakers, the circuit breaker rating, and the rating of the AC power cable connected to Acheron Designer.

Table 1: Maximum Number of Acheron Designers that Can Be Looped with AC Power

Circuit Breaker/ Connector Rating	115 V AC	230 V AC	100 V AC
15 amps	3 looped (4 total)	7 looped (8 total)	2 looped (3 total)
20 amps	5 looped (6 total)	10 looped (11 total)	3 looped (4 total)

NOTE: The Acheron Designer current draw is dynamic and fluctuates as operating levels change. The numbers in Table 1 assume that operating levels are normal and not such that the loudspeakers are constantly limiting.

Each Acheron Designer ships with one AC looping connector for making AC looping cables. Assembled AC looping cables are available from Meyer Sound.

CAUTION: Do not exceed the current capability of the 20-amp Input connector for the Acheron Designer. When looping loudspeakers, consider the total current draw for all loudspeakers on the circuit, *including* the first loudspeaker.

WIRING FOR AC CONNECTIONS

The Acheron Designer requires a grounded outlet. To operate safely and effectively, it is extremely important that the entire system be properly grounded.

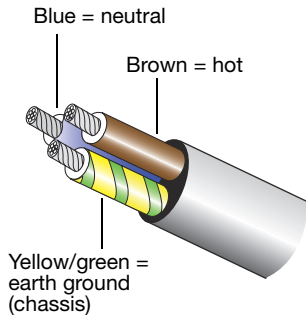

AC Cable Wiring Scheme

When wiring international or special-purpose AC power cables and connectors, use the following wiring scheme:

- Connect the blue wire to the black terminal, or the terminal marked with an N.
- Connect the brown wire to the red terminal, or the terminal marked with an L.
- Connect the yellow and green wire to the green (or green and yellow) terminal, or the terminal marked with an E.

CAUTION: When creating AC power cables and distribution systems, it is important to preserve AC line polarity and connect the earth ground on both ends of the cable. The Acheron Designer requires a grounded connection. Always use a grounded outlet and plug. It is extremely important that the system be properly grounded to operate safely and properly. Do not ground-lift the AC cable.

AC POWER DISTRIBUTION

All components in an audio system (self-powered loudspeakers, mixing consoles, and processors) must be properly connected to an AC power distribution system to ensure that AC line polarity is preserved, and that all grounding points are connected to a single node or common point using the same cable gauge as the neutral and line cables.

NOTE: Improper grounding of connections between loudspeakers and the rest of the audio system may produce noise or hum, or cause serious damage to the input and output stages of the system's electronic components.

CAUTION: Before applying AC power to any Meyer Sound self-powered loudspeaker, make sure that the voltage potential difference between the neutral and earth-ground lines is less than 5 V AC when using single-phase AC wiring.

Figure 1 illustrates a basic three-phase AC distribution system with the loudspeaker load distributed across the three phases. All loudspeakers are connected to common neutral and earth-ground lines.

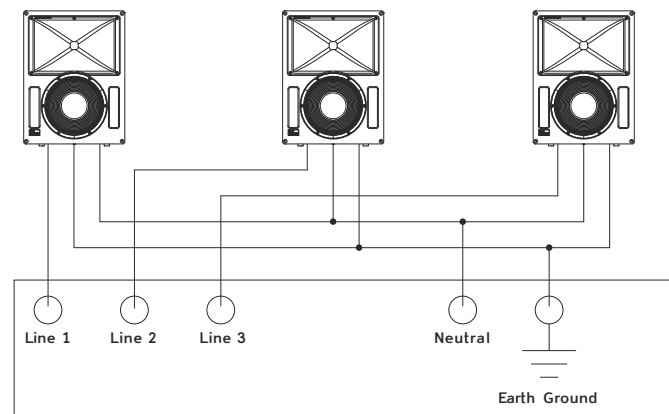

Figure 1: AC Power Distribution System

ACHERON DESIGNER VOLTAGE REQUIREMENTS

The Acheron Designer operates safely and continuously when the AC voltage stays within 100–264 V AC at 50 or 60 Hz. The loudspeaker can withstand continuous voltages up to 275 volts and allows any combination of voltage to GND (neutral-line-ground or line-line-ground).

If the voltage drops below 90 V (brownout), the unit uses stored power to continue operating temporarily; the loudspeaker shuts down if the voltage does not rise above the low boundary before the stored power is used.

If the voltage rises above 275 V, the power supply immediately shuts off to prevent damage to the unit.

If the Acheron Designer shuts down due to either low or high voltage, its power supply automatically powers up again after three seconds, so long as the voltage has returned to its normal operating window. If the Acheron Designer does not power up after 10 seconds, remove AC power immediately and contact Meyer Sound Technical Support.

 **CAUTION:** The power source for the Acheron Designer should always operate within the required voltage range, at least a few volts from the upper and lower ranges. This ensures that AC voltage variations from the service entry — or peak voltage drops due to cable runs — will not cause the loudspeaker's amplifier to cycle on and off or cause damage to the power supply.

 **NOTE:** When voltage fluctuates within the Acheron Designer's operating range, automatic tap selection stabilizes the operating voltage. This tap selection is instantaneous with no audible artifacts.

 **TIP:** Since the Acheron Designer does not require a dedicated neutral line, and it can tolerate elevated voltages from the ground line, it can be connected to line-line terminals in 120 V, 3-phase Wye systems. This results in 208 V AC between lines (nominal) and therefore draws less current than when using 120 V AC (line-neutral). Make sure that the voltage remains within the Acheron Designer's recommended operating window (100–264 V AC). The ground line must always be used for safety reasons and the line-to-ground voltage should never exceed 264 V AC (typically 120 V AC from line-to-ground).

POWERING UP THE ACHERON DESIGNER

When AC power is applied to the Acheron Designer, its Intelligent AC™ power supply automatically selects the correct operating voltage, allowing it to be used internationally without manually setting voltage switches. In addition, Intelligent AC provides soft-start power up, eliminating high inrush currents; suppresses high-voltage transients up to several kilovolts; filters common mode and differential mode radio frequencies (EMI); and sustains operation temporarily during low-voltage periods.

When powering up the Acheron Designer, the following startup events take place over several seconds.

1. Audio output is muted.
2. Voltage is detected and the power supply mode is automatically adjusted as necessary. The power supply ramps up.
3. During the power up sequence, the three-color On/Status LED flashes all three colors.
4. After the power up sequence and system check have completed, the ON/Status LED turns solid green, indicating the loudspeaker is ready to reproduce audio.

 **CAUTION:** If the On/Status LED does not turn green, or the Acheron Designer does not output audio after ten seconds, remove AC power immediately and verify that the voltage is within the required range. If the problem persists, contact Meyer Sound Technical Support.

ACHERON DESIGNER CURRENT REQUIREMENTS

The Acheron Designer current draw is dynamic and fluctuates as operating levels change. Since different cables and circuit breakers heat up at varying rates, it is important to understand the following types of current ratings and how they affect circuit breaker and cable specifications.

- **Idle Current** — The maximum rms current during idle periods.
- **Maximum Long-Term Continuous Current** — The maximum rms current during a period of at least 10 seconds. The Maximum Long-Term Continuous Current is used to calculate temperature increases for cables, to ensure that cable sizes and gauges conform to electrical code standards. The current rating is also used as a rating for slow-reacting thermal breakers.

- **Burst Current** — The maximum rms current during a period of around one second. The Burst Current is used as a rating for magnetic breakers. It is also used for calculating the peak voltage drop in long AC cable runs according to the following formula:

$$V_{pk}(\text{drop}) = I_{pk} \times R(\text{cable total})$$

The Burst Current can also be used to calculate the AC looping capability of Acheron Designer.

- **Ultimate Short-Term Peak Current** — A rating for fast-reacting magnetic breakers.
- **Inrush Current** — The spike of initial current encountered when powering on.

You can use Table 2 as a guideline for selecting cable gauges and circuit breaker ratings for the system’s operating voltage.

Table 2: Acheron Designer Current Draw

Current Draw	115 V AC	230 V AC	100 V AC
Idle Current	0.23 A rms	0.19 A rms	0.24 A rms
Maximum Long-Term Continuous Current	1.58 A rms	0.83 A rms	1.78 A rms
Burst Current	3.1 A rms	1.4 A rms	3.6 A rms
Ultimate Short-Term Peak Current	12.0 A peak	8.0 A peak	12.4 A peak
Inrush Current	25 A peak	54 A peak	20 A peak

The minimum electrical service amperage required by an Acheron Designer loudspeaker system is the sum of the Maximum Long-Term Continuous Current for each loudspeaker. An additional 30 percent above the minimum amperage is recommended to prevent peak voltage drops at the service entry.

 **NOTE:** For best performance, the AC cable voltage drop should not exceed 10 V, or 10 percent at 115 V and 5 percent at 230 V. Make sure that even with AC voltage drops that the AC voltage always remains within the operating windows.

ELECTRICAL SAFETY GUIDELINES

Pay close attention to these important electrical and safety guidelines.

- The Acheron Designer requires a grounded outlet. Always use a grounded outlet and plug.

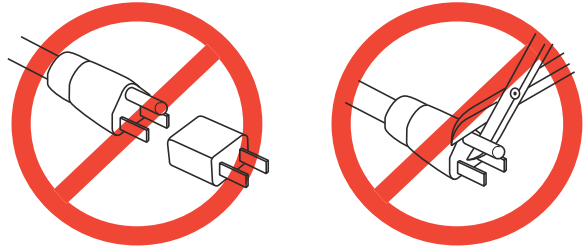

- Do not use a ground-lifting adapter or cut the AC cable ground pin.

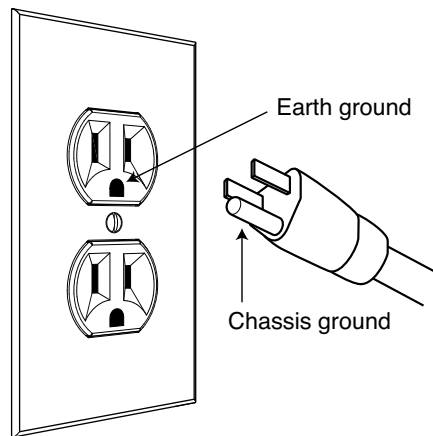

- Do not exceed the current capability of the 20-amp AC Input connector for the loudspeaker. When looping loudspeakers, consider the total current draw for all loudspeakers on the circuit, including the first loudspeaker.
- Make sure the AC power cable for the loudspeaker has the appropriate power plug (on the other end) for the area in which you will operate the loudspeaker. In addition, the AC power cable must be rated for the total current draw of all loudspeakers looped from the power source.
- Do not operate the unit if its power cable is frayed or broken.
- Keep all liquids away from the Acheron Designer to avoid hazards from electrical shock.

CHAPTER 3: AMPLIFICATION AND AUDIO

The Acheron Designer’s low- and high-frequency drivers are powered by an extremely efficient onboard two-channel, Class-D amplifier that uses minimal AC power when idle. Internal signal processing includes a complex crossover, frequency and phase correction, and limiters that prevent driver overexcursion and regulate voice coil temperatures, ensuring maximum driver lifespan.

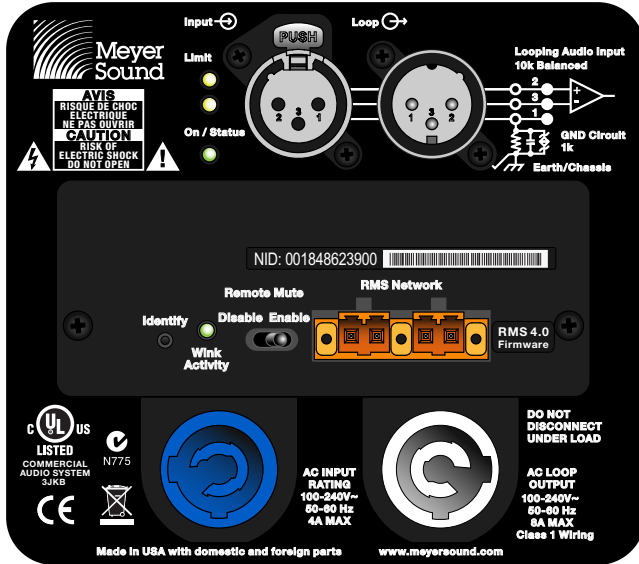

Acheron Designer Rear Panel with Optional RMS Module

The Acheron Designer rear panel includes a slot for the optional RMS module, used for connecting to the RMS remote monitoring system (see Chapter 5, “RMS Remote Monitoring System”).

AUDIO CONNECTORS

The Acheron Designer includes female XLR Input and male XLR Loop output connectors.

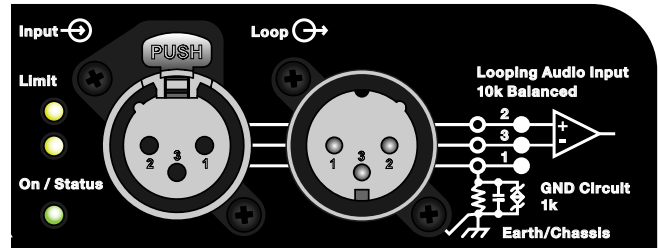

Acheron Designer Audio Connectors, Input and Loop Output

Input Connector

The female XLR Input connector accepts a balanced audio signal with an input impedance of 10 kOhm. The connector uses the following wiring:

- **Pin 1** – 1 kOhm to chassis and earth ground (ESD clamped)
- **Pin 2** – Signal (+)
- **Pin 3** – Signal (-)
- **Case** – Earth (AC) ground and chassis

Pins 2 and 3 carry the input as a differential signal. Pin 1 is connected to earth through a 1 kOhm, 1000 pF, 15 V clamped network. This circuitry provides virtual ground lift for audio frequencies while allowing unwanted signals to bleed to ground. Make sure to use standard, balanced XLR audio cables with all three pins connected on both ends. Telescopic grounding is not recommended, and shorting an input connector pin to the case may cause a ground loop, resulting in hum.

 **TIP:** If unwanted noise or hiss is produced by the loudspeaker, disconnect its input cable. If the noise stops, there is most likely nothing wrong with the loudspeaker. To locate the source of the noise, check the audio cable, source audio, and AC power.

Loop Output Connector

The male XLR Loop output connector allows multiple Acheron Designers to be looped from a single audio source. For applications that require multiple Acheron Designers, connect the Loop output of the first unit to the Input of the second, and so forth.

NOTE: The order in which loudspeakers are connected when looping audio signals is unimportant. The Loop connector is wired in parallel to the Input connector and transmits the unbuffered source signal even when the Acheron Designer is powered off.

To avoid distortion when looping multiple Acheron Designers, make sure the source device can drive the total load impedance of the looped loudspeakers. In addition, the source device must be capable of delivering approximately 20 dBV (10 V rms into 600 ohms) to yield the maximum peak SPL over the entire operating bandwidth of the loudspeakers. Most professional audio equipment can transmit these source levels.

To calculate the load impedance for the looped loudspeakers, divide 10 kOhms (the input impedance for a single Acheron Designer) by the number of looped loudspeakers. For example, the load impedance for 10 Acheron Designer loudspeakers is 1000 ohms (10 kOhms / 10). To drive this number of looped loudspeakers, the source device should have an output impedance of 100 ohms or less. This same rule applies when looping Acheron Designer loudspeakers with other self-powered Meyer Sound loudspeakers and subwoofers.

NOTE: Most source devices are capable of driving loads no smaller than 10 times their output impedance.

CAUTION: Make sure that all cabling for looped loudspeakers is wired correctly (Pin 1 to Pin 1, Pin 2 to Pin 2, and so forth) to prevent the polarity from being reversed. If one or more loudspeakers in a system have reversed polarity, frequency response and coverage will be significantly degraded.

LIMITING

When source levels for the Acheron Designer exceed optimum input levels for its drivers, limiting is engaged and is indicated by the two Limit LEDs on the rear panel. The bottom LED indicates limiting for the low-frequency channel. The top LED indicates limiting for the high-frequency channel. When engaged, limiting not only protects the drivers, but also prevents signal peaks from causing excessive distortion in the amplifier's channels, thereby preserving headroom and maintaining smooth frequency responses at high levels. When source levels return to normal, below the limiter's threshold, limiting ceases.

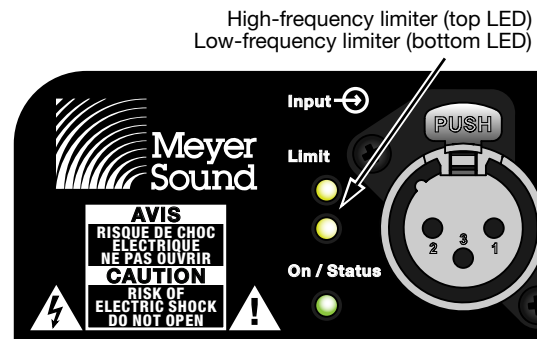

Limit LEDs

The Acheron Designer performs within its acoustical specifications at normal temperatures when the Limit LEDs are unlit, or if the LEDs are lit for two seconds or less and then turn off for at least one second. If an LED remains lit for longer than three seconds, the loudspeaker enters hard limiting where:

- Increases to the input level have no effect.
- Distortion increases due to clipping and nonlinear driver operation.
- The drivers are subjected to excessive heat and excursion, which will compromise their life span and may eventually lead to damage over time.

NOTE: The Acheron Designer uses digital limiters that add no noise and have no effect on the signal when the limiters are not engaged and the Limit LEDs are not lit.

ON/STATUS LED

During normal operation, the Acheron Designer's On/Status LED is green. If the loudspeaker's internal temperature reaches 75° C (167° F), the LED turns solid yellow and the loudspeaker's gain is reduced by 3 dB. Though the Acheron Designer will continue to operate normally with the lower gain, when the On/Status LED is yellow, this is an indication that the loudspeaker is reaching its maximum heat dissipation and a reduction in SPL is recommended. When the loudspeaker's internal temperature cools to 60° C (140° F), the amplifier returns to normal operation.

CAUTION: If the loudspeaker's internal temperature reaches 125° C (257° F), gain is reduced by 6 dB to avoid damage to the loudspeaker.

TIP: When the Acheron Designer is connected to an RMS network, the RMS software provides additional feedback on the loudspeaker's operating temperature. For more information, see Chapter 6, "RMS Remote Monitoring System."

Amplifier Cooling System

The Acheron Designer's amplifier relies solely on natural convection for cooling from air flowing over its heat sink. The rear-mounted, recessed heat sink yields efficient cooling and allows the unit to be placed flat against walls, when necessary. The amplifier and heat sink keep temperatures low, even when the unit is used at high ambient temperatures, and when driven continuously at high output levels.

CAUTION: The Acheron Designer's heat sink can reach temperatures of up to 85° C (185° F) during extreme operation. Use extreme caution when approaching the rear of the loudspeaker.

Heat Sink Ventilation Requirements

When installing the Acheron Designer flush against walls, or when mounting them in soffits or baffle walls, make sure to allow plenty of ventilation above the loudspeaker.

- When installing the Acheron Designer in a soffit with the loudspeaker flush against the back of the soffit (see Figure 2), allow at least 6 inches above the loudspeaker for ventilation.

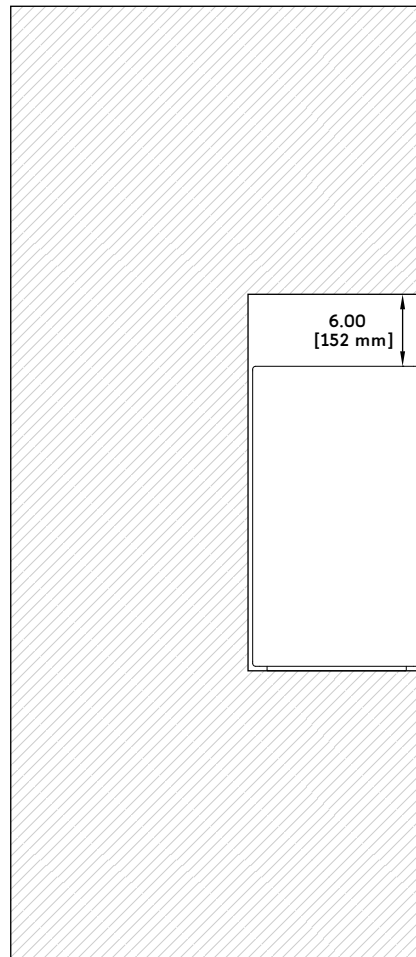

Figure 2: Acheron Designer Mounted in Soffit, Flush Against Back of Soffit with 6" of Ventilation Above Loudspeaker

- When installing the Acheron Designer in a soffit with the loudspeaker 1 inch from the back of the soffit (see Figure 3), allow at least 3 inches above the loudspeaker for ventilation.

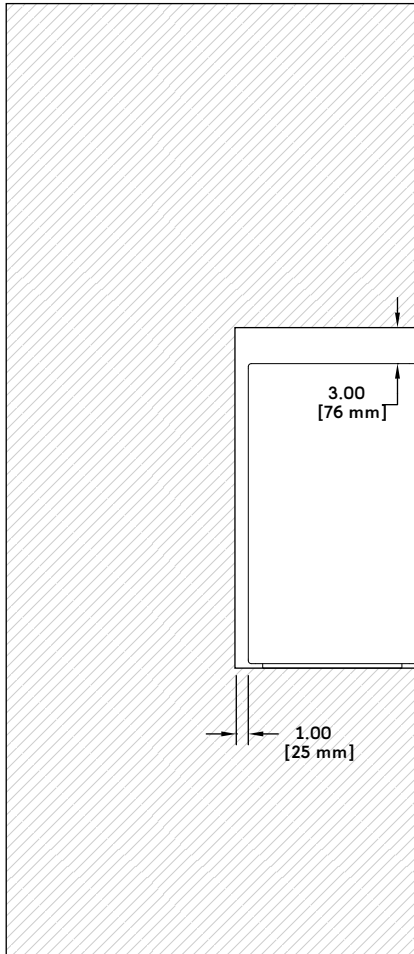

Figure 3: Acheron Designer Mounted in Soffit, 1" Behind and 3" Above Loudspeaker for Ventilation

- When installing the Acheron Designer in a baffle wall with no opening in the front of the wall for ventilation (see Figure 4), allow for plenty of ventilation above the loudspeaker within the baffle wall.

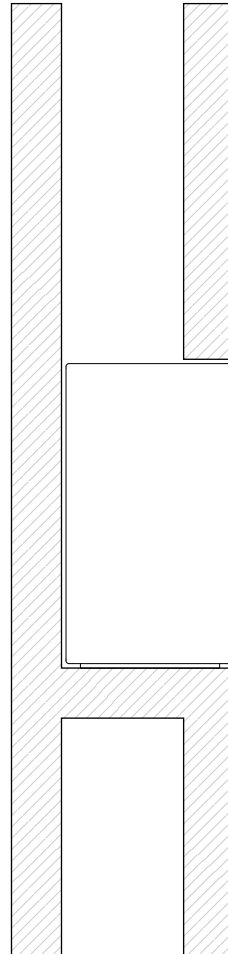

Figure 4: Acheron Designer Mounted in Baffle Wall with Open Ventilation Above Loudspeaker

CHAPTER 4: RIGGING

Important Safety Considerations!

When installing Meyer Sound loudspeakers and subwoofers, the following precautions should always be observed:

- All Meyer Sound products must be used in accordance with local, state, federal, and industry regulations. It is the owner's and user's responsibility to evaluate the reliability of any mounting and rigging method for their application. Mounting and rigging should only be carried out by experienced professionals.
- Use mounting and rigging hardware that has been rated to meet or exceed the weight being hung.
- Make sure to attach mounting hardware to the building's structural components (studs or joists), and not just to the wall surface. Verify that the building's structure and the anchors used for the installation will safely support the total weight of the mounted loudspeakers.
- Use mounting hardware appropriate for the surface where the loudspeaker will be installed.
- Make sure bolts and eyebolts are tightened securely. Meyer Sound recommends using Loctite® on eyebolt threads and safety cables.
- Inspect mounting and rigging hardware regularly. Immediately replace any worn or damaged components.

MYA-DES CRADLE-STYLE YOKE

The Acheron Designer includes M6 threaded attachment points on the cabinet bottom for the optional MYA-DES cradle-style yoke, allowing the unit to be suspended from a single hanging point.

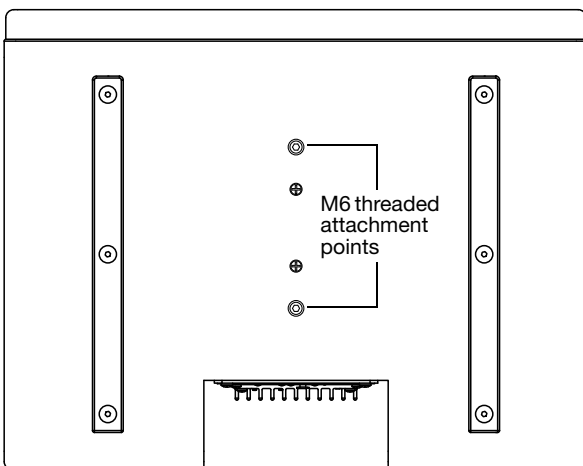

Acheron Designer Cabinet Bottom, M6 Threaded Attachment Points

The yoke's cradle can be pivoted to install the loudspeaker with downtilt or uptilt. A "C" or "G" hanging clamp and steel safety cable (not included) are required to suspend the yoke.

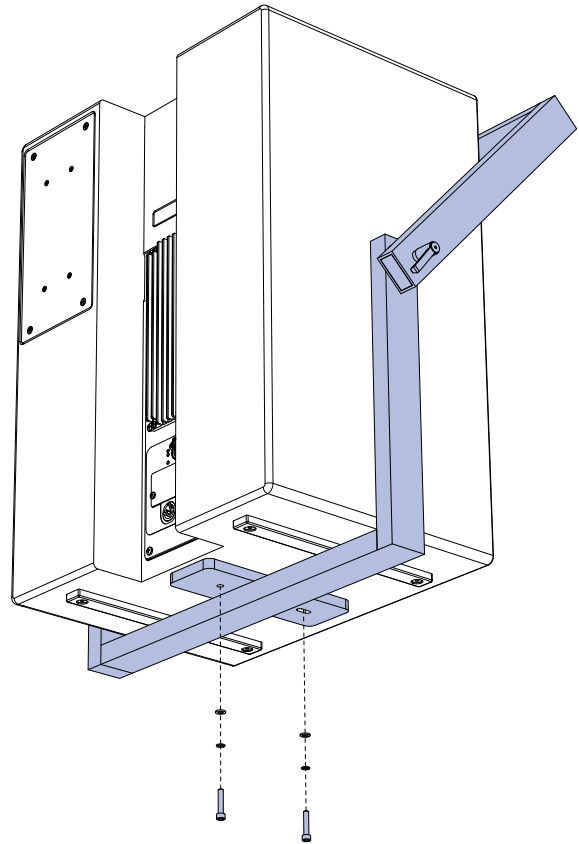

MYA-DES Cradle-Style Yoke, Bottom View

CAUTION: The MYA-DES mounting yoke is rated for a maximum downtilt of 45 degrees.

NOTE: The top bar of the MYA-DES yoke accommodates hanging clamps with standard 1/2-inch or 12 mm bolts.

NOTE: For Acheron Designer dimensions and weight with the MYA-DES yoke, refer to Appendix A, "Acheron Designer Specifications."

CHAPTER 5: RMS REMOTE MONITORING SYSTEM

The Acheron Designer is optionally available with the RMS remote monitoring system module, allowing it to be connected to an RMS network. RMS allows real-time monitoring of multiple Meyer Sound self-powered loudspeakers from a Windows-based computer. The RMS host computer communicates with Meyer Sound loudspeakers (equipped with RMS modules) via a simple twisted pair network, or an Ethernet network using an FT-10 to Ethernet adapter.

 **NOTE:** For the latest RMS system requirements, visit www.meyersound.com.

 **NOTE:** The RMS software allows you to disable Mute and Solo functions to eliminate any possibility of accidentally muting loudspeakers. Mute and solo capability can also be disabled by removing the Mute Jumper from RMS modules. For more information, refer to the *RMS User Guide*.

 **NOTE:** RMS does not control AC power.

RMS SOFTWARE

The optional RMS software provides extensive system status and performance data for each loudspeaker, including amplifier voltage, limiting activity, power output, driver status, as well as mute and solo capability. Loudspeakers are added to the RMS network and assigned a node name during a one-time commissioning procedure where the loudspeaker is identified by either entering its unique Neuron ID, or by pressing its Identify button.

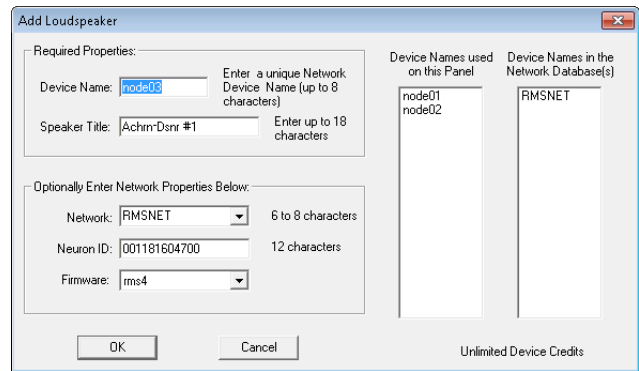

RMS Add Loudspeaker Dialog Box

Once loudspeakers are identified on the RMS network, they appear in the RMS software as icons and views; they are also automatically added to the RMS database on the host computer.

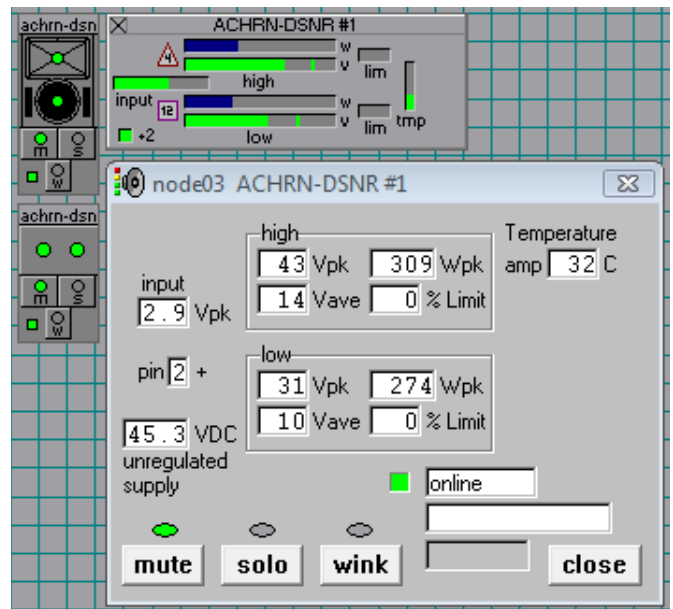

Acheron Designer RMS Icons

RMS software displays all loudspeakers on the network in a panel with icons, Meter views, and Text views that can be customized to suit your needs. Loudspeaker data is updated 2–5 times per second. Individual loudspeakers can be physically identified with the Wink option in RMS, which lights the Wink LED on the RMS module for that particular loudspeaker. Conversely, a loudspeaker can be identified in the RMS software by pressing the Identify button on the loudspeaker's RMS module.

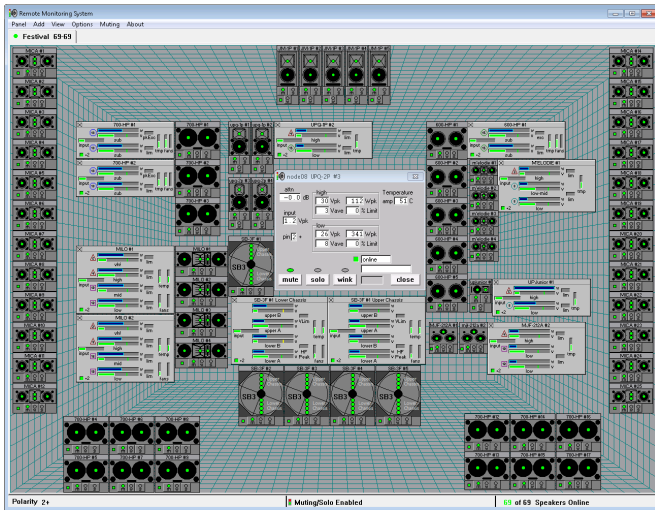

RMS Panel with Icons

Loudspeaker icons and views can be arranged to represent how loudspeakers have been deployed in the system. Multiple panels can be saved and recalled for specific performances and venues.

NOTE: When the Acheron Designer heat sink reaches 85° C (185° F), the On/Status LED turns red, while its loudspeaker icon in the RMS software turns yellow — indicating the loudspeaker is running hot, but still within safe operating limits. Make sure that the loudspeaker is properly ventilated.

RMS MODULE

The Acheron Designer RMS module includes an Identify button, Wink/Activity LED, Remote Mute switch, and two Network connectors.

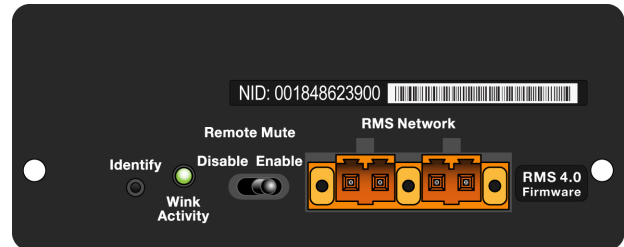

Figure 5: Acheron Designer RMS Module

NOTE: The buttons and LED on the Acheron Designer RMS module are used exclusively by RMS and have no effect on the acoustic or electrical activity of the loudspeaker.

Identify Button

The Identify button serves the following functions:

- If the loudspeaker has not yet been commissioned (Wink/Activity LED not lit), press the Identify button to identify the loudspeaker on the RMS network and commission it.
- To decommission the loudspeaker, press and hold the Identify button during startup (see “Resetting the RMS Module” on page 21).
- To *wink* a commissioned loudspeaker, press the Identify button. The Wink LED on the loudspeaker icon in the RMS software lights up and the Wink/Activity LED on the loudspeaker's RMS user panel turns solid green. Press the Identify button again to unwink the loudspeaker.

TIP: The Wink function is useful for identifying the physical loudspeaker corresponding to a loudspeaker icon in the RMS software.

Wink/Activity LED (Green)

The green Wink/Activity LED indicates the status of the loudspeaker:

- During startup, the LED blinks 10 times.
- If the loudspeaker has not yet been commissioned, the LED is not lit after startup.
- If the loudspeaker has been successfully commissioned, the LED flashes continuously and flashes more rapidly with increased data activity.
- When the loudspeaker is winked, either by clicking the Wink button in the RMS software or by pressing the Identify button on the RMS user panel, the LED is solid green.



TIP: The Wink function is useful for identifying the physical loudspeaker corresponding to a loudspeaker icon in the RMS software.

Remote Mute Switch

The recessed Remote Mute switch on the Acheron Designer RMS module determines whether the RMS software can control muting and soloing of the loudspeaker. The Acheron Designer ships from the factory with the switch enabled.



Remote Mute Switch

- **Disable:** When the Remote Mute switch is set to Disable (to the left), the loudspeaker cannot be muted and soloed from the RMS software.
- **Enable:** When the Remote Mute switch is set to Enable (to the right), the loudspeaker can be muted and soloed from the RMS software.



NOTE: The RMS software also allows you to disable Mute and Solo functions to eliminate any possibility of accidentally muting loudspeakers. For more information, refer to the *RMS User Guide*.

RMS Network Connectors

The two Weidmuller connectors transfer data to and from the RMS network. Two connectors are provided to allow for easy connection of multiple (daisy-chained) loudspeakers on the network. Included with each RMS-equipped loudspeaker are RMS cable connectors and mounting blocks for constructing RMS cables. The RMS blocks allow the cables to be securely attached to the RMS module with screws.

NEURON ID FOR THE RMS MODULE

Each Acheron Designer RMS module has a unique 12-character Neuron ID (NID) that identifies the loudspeaker on the network. When commissioning the loudspeaker, the NID must either be entered manually or retrieved from the loudspeaker by pressing its Identify button. The NID for the RMS module is located on the user panel above the orange RMS Network connectors (see Figure 5 on page 20).

RESETTING THE RMS MODULE

You can use the Identify button to reset the Acheron Designer RMS module when powering up the loudspeaker. This will cause the module to be decommissioned from the network.

To reset the Acheron Designer RMS module:

1. Disconnect the loudspeaker's power cord.
2. Press and hold the Identify button.
3. While continuing to hold down the Identify button, reconnect the power cord.
4. After the Wink/Activity LED blinks on and off, release the Identify button. The RMS module is reset and the loudspeaker is decommissioned.

CHAPTER 6: SYSTEM DESIGN AND INTEGRATION TOOLS

Meyer Sound offers two comprehensive tools to assist with the acoustical and functional requirements of system design and optimization. This chapter introduces MAPP Online Cinema, Meyer Sound's patented online acoustical prediction tool, and SIM 3, a comprehensive system for measurement and analysis.

MAPP ONLINE CINEMA

MAPP Online Cinema is a powerful, cross-platform, Java-based application for accurately predicting the coverage pattern, frequency response, impulse response, and maximum SPL output of Meyer Sound cinema loudspeakers.

Residing on your local computer, the MAPP Online Cinema client lets you configure Meyer Sound loudspeaker systems and define the environment in which they will operate, including air temperature, pressure, humidity, and even the location and composition of walls. CAD (DXF) files containing detailed venue information can also be imported.

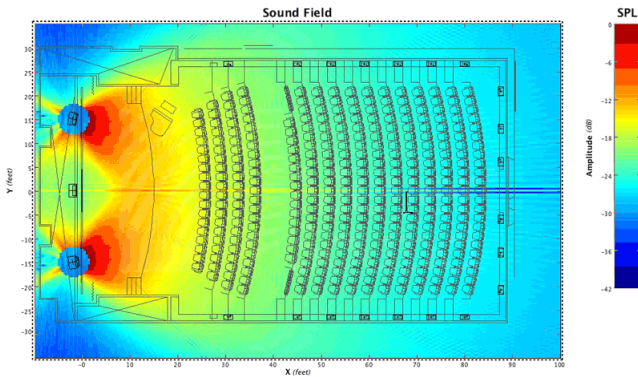

Air Attenuation On
Temperature = 68.0°F
Pressure = 1,013.25 mb
Relative Humidity = 50.0%

Relative Bandwidth = 1 octave
Center Frequency = 4,000 Hz
Start Frequency = 2,822 Hz
Stop Frequency = 5,664.3 Hz

MAPP Online Cinema

Sound system designers can use MAPP Online Cinema to accurately predict the appropriate loudspeaker deployment for each job, complete with coverage data, system delay and equalization settings, and detailed design illustrations. MAPP Online Cinema's accurate, high-resolution predictions ensure that systems will perform as expected, thereby eliminating unexpected coverage problems and minimizing on-site adjustments.

The key to the accuracy of MAPP Online Cinema's predictions is its exhaustive database of Meyer Sound loudspeaker measurements. Performance predictions for each loudspeaker are based on 360 1/48th-octave-band measurements taken with a SIM audio analyzer in the Meyer Sound anechoic chamber. The extraordinary consistency between Meyer Sound loudspeakers guarantees that predictions from MAPP Online Cinema will closely match their actual performance.

MAPP Online Cinema predictions are requested by the client software and sent via the Internet to the high-speed Meyer Sound servers where high-resolution (magnitude and phase) polar data is processed with sophisticated acoustical prediction algorithms. The resulting predictions are then returned to and displayed on the local computer running the MAPP Online Cinema client software.



TIP: Meyer Sound offers seminars and webinars on using MAPP Online Cinema. For more information, visit www.meyersound.com.

MAPP Online Cinema Applications

With MAPP Online Cinema, you can:

- Simulate different loudspeaker configurations to refine system design and zero-in on the best coverage for intended audience areas
- Simulate different screen types to evaluate their transparency and reflectivity
- Monitor loudspeaker interactions to locate destructive interferences so that loudspeakers can be re-aimed and repositioned as necessary
- Place microphones anywhere in the sound field and predict their frequency response, impulse response, and sound pressure
- Determine delay settings for surround loudspeakers
- Try out virtual Galileo equalization to determine optimum real-world settings for the best system response
- Generate and export system images for client presentations

Using MAPP Online Cinema

MAPP Online Cinema is compatible with the following operating systems:

- Windows
- Linux®
- Unix®
- Mac OS®

For information on which operating system versions are supported, visit www.meysound.com.

Downloading and Installing MAPP Online Cinema

To use MAPP Online Cinema, you must register online at www.meysound.com. After entering your registration information, an email will be sent to you with your user name, password, and the MAPP Online Cinema download location. On-screen instructions will guide you through the download and installation process.

The MAPP Online Cinema client software is regularly upgraded to add support for the latest Meyer Sound loudspeakers, as well as to add feature enhancements. Most upgrades are downloaded automatically when logging on to a MAPP Online Cinema session. The MAPP Online Cinema database includes all Meyer Sound EXP screen channel loudspeakers, surround loudspeakers, subwoofers, and processors.

SIM 3 MEASUREMENT SYSTEM

The SIM 3 audio analyzer is a high-resolution audio measurement system comprised of software, hardware, microphones, and accessory cables. The SIM 3 is optimized for measuring audio frequencies with resolutions up 1/48th of an octave, allowing you to apply precise corrections to balance system response using frequency and phase domain information.

Source Independent Measurement Technique

The SIM 3 audio analyzer implements Meyer Sound's source independent measurement technique, a dual-channel method that accommodates statistically unpredictable excitation signals. Any excitation signal within a desired frequency range can be used to obtain highly accurate measurements for acoustical or electronic systems. For example, concert halls and loudspeaker systems can be captured during a performance and used as a SIM 3 test signal, so you can:

- View measurement data as amplitude versus time (impulse response) or amplitude and phase versus frequency (frequency response)
- Utilize a single-channel spectrum mode
- View frequency domain data within a logarithmic frequency axis
- Determine and internally compensate for propagation delays using the SIM 3 Delay Finder

SIM 3 Applications

The SIM 3's primary applications are testing and aligning loudspeaker systems, which entails:

- Measuring propagation delays between subsystems to determine appropriate polarities and delay times
- Measuring variations in frequency response caused by the acoustical environment and the placement and interaction of loudspeakers to determine corrective equalization
- Optimizing subwoofer integrations
- Optimizing loudspeaker arrays

The SIM 3 is also versatile and accurate enough for the following applications:

- Microphone calibration and equalization
- Transducer evaluation and correction
- Echo detection and analysis
- Vibration analysis
- Architectural acoustics
- Underwater acoustics

APPENDIX A: ACHERON DESIGNER SPECIFICATIONS

ACOUSTICAL	
Operating Frequency Range	37 Hz – 18 kHz Note: Recommended maximum operating frequency range. Response depends on loading conditions and room acoustics.
Frequency Response	38 Hz – 17 kHz ± 4 dB Note: Measured free field with 1/3 octave frequency resolution at 4 meters.
Phase Response	230 Hz to 17 kHz $\pm 30^\circ$
Maximum Peak SPL	130 dB Note: Measured free field with music referred to 1 meter.
Dynamic Range	>110 dB
Coverage	80° horizontal by 50° vertical
Crossover	680 Hz Note: At this frequency, both transducers produce equal sound pressure levels.
TRANSDUCERS	
Low Frequency	One 12" cone driver Nominal impedance: 2 Ω Voice coil size: 4"
High Frequency	One 4" compression driver Nominal impedance: 8 Ω Voice coil size: 4" Diaphragm size: 4" Exit size: 1.5"
AUDIO INPUT	
Type	Differential, electronically balanced
Maximum Common Mode Range	± 5 V DC, clamped to earth for voltage transient protection
Connectors	Female XLR input with male XLR loop output
Input Impedance	10 k Ω differential between pins 2 and 3
Wiring	Pin 1: Chassis/earth through 1 k Ω , 1000 pF, 15 V clamp network to provide virtual ground lift at audio frequencies Pin 2: Signal + Pin 3: Signal – Case: Earth ground and chassis
DC Blocking	Differential DC blocking up to the maximum common mode voltage
CMRR	>50 dB, typically 80 dB (50 Hz – 500 Hz)
RF Filter	Common mode: 425 kHz Differential mode: 142 kHz
TIM Filter	<80 kHz, integral to signal processing
Nominal Input Sensitivity	10 dBV (3.2 V rms, 4.5 V peak) continuous is typically the onset of limiting for noise and music
Input Level	Audio source must be capable of producing +20 dBV (10 V rms, 14 V peak) into 600 Ω to produce the maximum peak SPL over the operating bandwidth of the loudspeaker
AMPLIFIER	
Type	Two-channel, Class-D

Output Power	700 W total (550 W low channel, 250 W high channel) Note: Amplifier wattage rating based on the maximum unclipped burst sine-wave RMS voltage the amplifier will produce into the nominal load impedance: low-frequency channel, 33 V rms into 2 Ω; high-frequency channel, 33 V rms into 8 Ω.
Total Output	1400 W peak Note: Peak power output based on the maximum unclipped peak voltage the amplifier will produce into the nominal load impedance: low-frequency channel, 46 V peak into 2 Ω; high-frequency channel, 46 V peak into 8 Ω.
THD, IM TIM	<.02%
Load Capacity	2 Ω low channel, 8 Ω high channel
Cooling	Convection, with recessed heat sink
AC POWER	
Connectors	PowerCon with loop output
Voltage Selection	Automatic, continuous range from 90–265 V AC
Safety Agency Rated Operating Voltage	100–240 V AC, 50/60 Hz
Turn On/Turn Off Points	90 V AC on, no turn-off, only fuse-protect above 265 V AC
Current Draw	
Idle Current	0.23 A rms (115 V AC); 0.19 A rms (230 V AC); 0.24 A rms (100 V AC)
Maximum Long-Term Continuous Current	1.58 A rms (115 V AC); 0.83 A rms (230 V AC); 1.78 A rms (100 V AC)
Burst Current	3.1 A peak (115 V AC); 1.4 A peak (230 V AC); 3.6 A peak (100 V AC) Note: AC power cabling must be of sufficient gauge so that under burst current rms conditions, cable transmission losses do not drop below the loudspeaker's specified operating voltage range.
Ultimate Short-Term Peak Current	12.0 A peak (115 V AC); 8.0 A peak (230 V AC); 12.4 A peak (100 V AC)
Inrush Current	25 A peak (115 V AC); 54 A peak (230 V AC); 20 A peak (100 V AC)
PHYSICAL	
Enclosure	Premium birch plywood
Finish	Low gloss, black textured
Protective Grille (Optional)	Attachment points on cabinet front corners for optional grille frame with black cloth Note: Weight for grille frame is 2.0 lbs (0.9 kg).
Rigging (Optional)	Two threaded M6 attachment points on cabinet bottom for optional MYA-DES cradle-style yoke Note: Weight for MYA-DES is 28.5 lbs (12.9 kg).
Dimensions	19.00" w x 25.38" h x 14.58" d (483 mm x 645 mm x 370 mm) without optional grille frame
Weight	Weight 76.0 lbs (34.5 kg) without optional grille frame
ENVIRONMENTAL	
Operating Temperature	0° C to +45° C
Non Operating Temperature	<-40° C or >+75° C
Humidity	to 95% at 35° C
Operating Altitude	to 4600 m (15,000 ft)
Non Operating Altitude	to 95% at 35° C
Shock	30 g 11 msec half-sine on each of 6 sides
Vibration	10 Hz – 55 Hz (0.010 m peak-to-peak excursion)

ACHERON DESIGNER COMPLIANCE



ACHERON DESIGNER DIMENSIONS

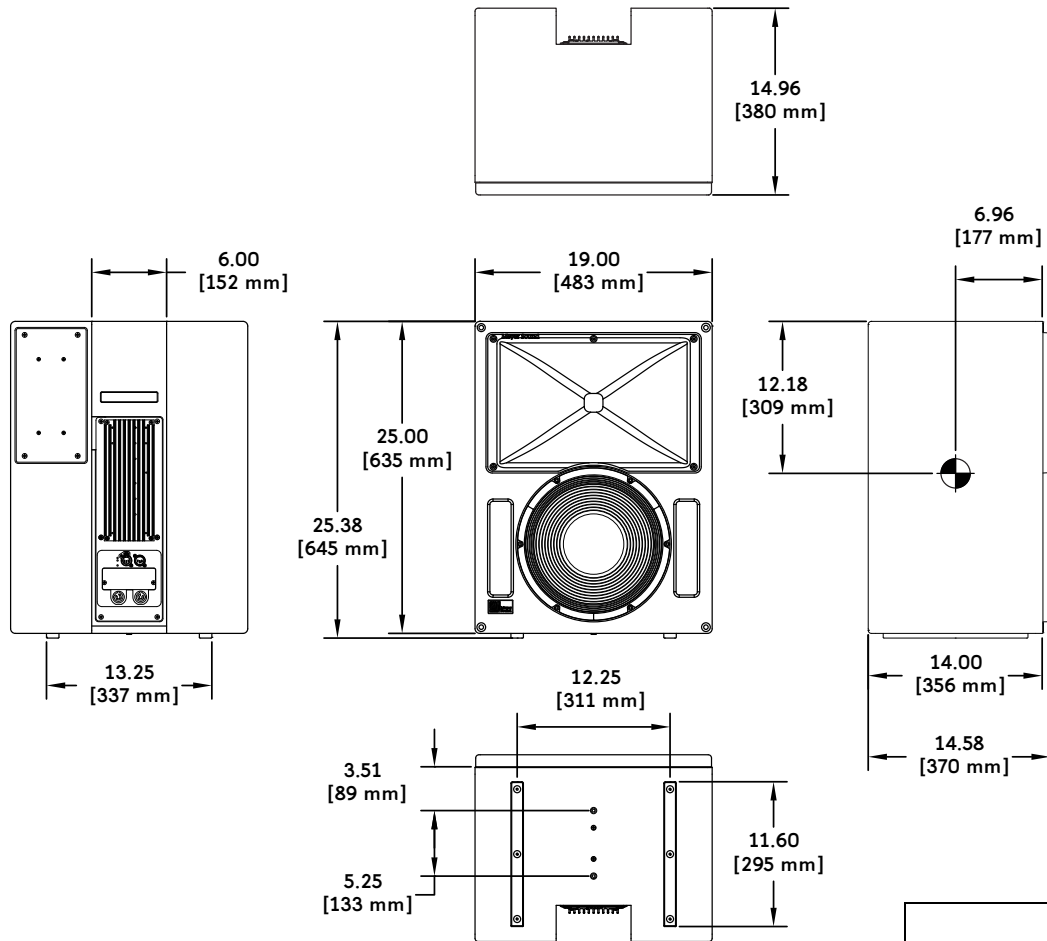

	Acheron Designer Weight
Without Grille Frame	76.0 lbs (34.5 kg)
With Grille Frame	78.0 lbs (35.4 kg)

Acheron Designer Dimensions

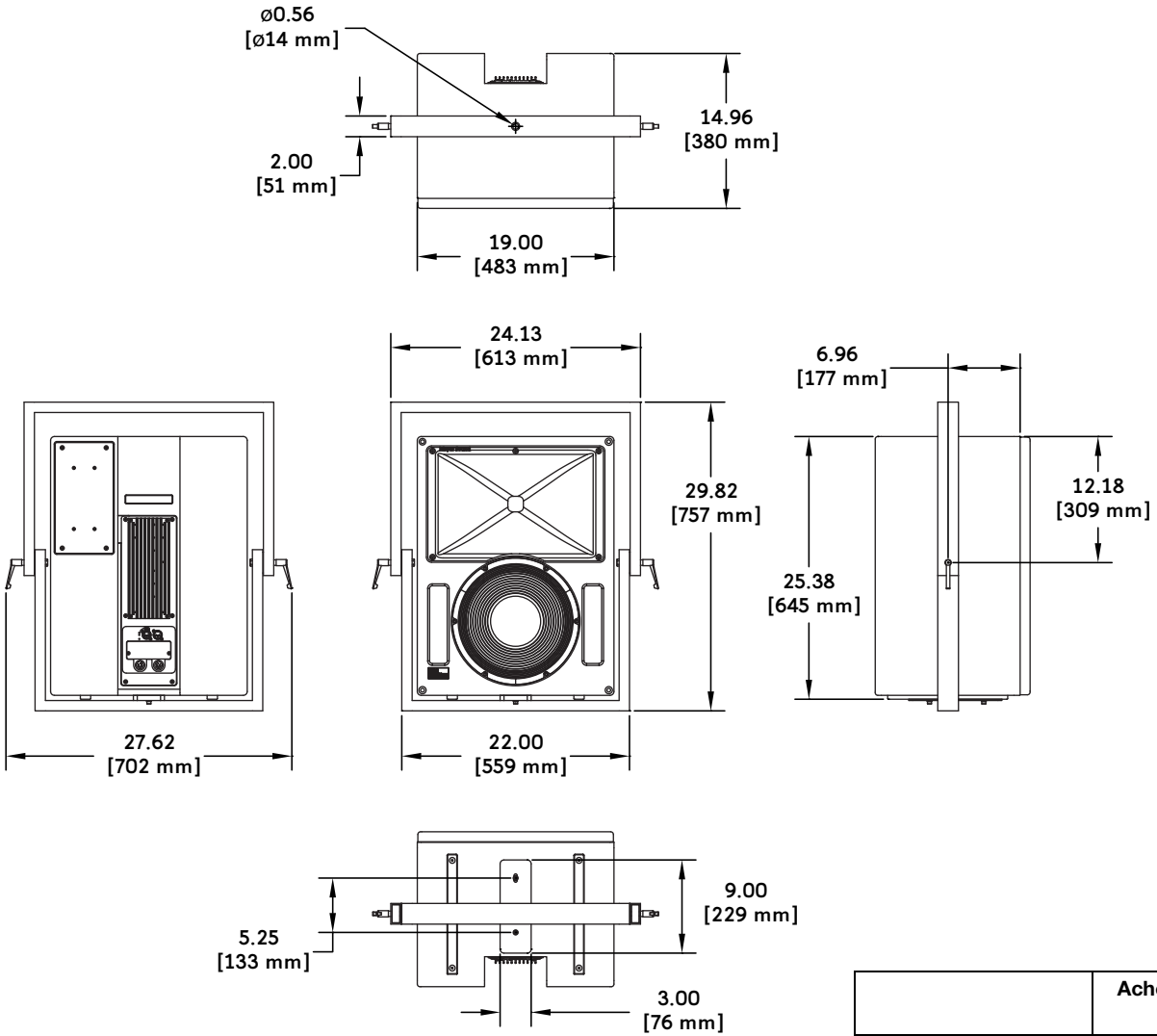

	Acheron Designer Weight
Without MYA-DES Yoke	76.0 lbs (34.5 kg)
With MYA-DES Yoke	104.5 lbs (47.4 kg)

Acheron Designer Dimensions with MYA-DES Cradle-Style Yoke







thinking sound



Meyer Sound Laboratories Inc.
2832 San Pablo Avenue
Berkeley, CA 94702

www.meyersound.com
T: +1 510 486.1166
F: +1 510 486.835

© 2012
Meyer Sound. All rights reserved.
Acheron Designer Operating Instructions, PN 05.211.005.01 A