

---

# **CHAPTER 1**

Preface

---

## Table of Content

### Preface

<b>Table of Content</b> .....	<b>1-2</b>
<b>Regulations Information</b> .....	<b>1-5</b>
FCC-B Radio Frequency Interference Statement .....	1-5
FCC Conditions .....	1-6
<b>Safety Instructions</b> .....	<b>1-7</b>
<b>Safety Guideline for Using Lithium Battery</b> .....	<b>1-9</b>
<b>WEEE Statement</b> .....	<b>1-13</b>
<b>Trademarks</b> .....	<b>1-20</b>
<b>Release History</b> .....	<b>1-20</b>

### Introductions

<b>Manual Map</b> .....	<b>2-2</b>
<b>Unpacking</b> .....	<b>2-3</b>
<b>Specification</b> .....	<b>2-4</b>
<b>Product Overview</b> .....	<b>2-9</b>
Top-Open View .....	2-9
Front Side View .....	2-13
Left Side View .....	2-15
Right Side View .....	2-17

Rear Side View .....	2-19
Bottom Side View .....	2-20

## Getting Started

<b>Power Management .....</b>	<b>3-2</b>
ECO Engine--Power Saving Function .....	3-2
AC Adapter .....	3-4
Battery Pack .....	3-6
Using the Battery Pack .....	3-9
Basic Operations .....	3-11
Safety and Comfort Tips .....	3-11
Having a Good Work Habit .....	3-12
Knowing the Keyboard .....	3-13
Knowing the Touchpad .....	3-17
About Hard Disk Drive .....	3-20
<b>Connecting the External Devices .....</b>	<b>3-21</b>
Using the External Optical Storage Device .....	3-21
Connecting the Peripheral Devices .....	3-23
Connecting the Communication Devices .....	3-26
<b>Safely Remove Hardware .....</b>	<b>3-27</b>

## BIOS Setup

<b>About BIOS Setup</b> .....	<b>4-2</b>
When to Use BIOS Setup.....	4-2
How to Run BIOS Setup.....	4-2
Control Keys.....	4-3
<b>BIOS Setup Menu</b> .....	<b>4-4</b>
Main menu.....	4-5
Advanced menu.....	4-7
Security menu.....	4-9
Boot menu.....	4-11
Save & Exit menu.....	4-12

## Regulations Information

### FCC-B Radio Frequency Interference Statement

This equipment has been tested and found to comply with the limits for a Class B digital device, pursuant to part 15 of the FCC rules. These limits are designed to provide reasonable protection against harmful interference in a residential installation. This equipment generates, uses and radiates radio frequency energy, and, if not installed and used in accordance with the instructions, may cause harmful interference to radio communications. However, there is no guarantee that interference will not occur in a particular installation. If this equipment does cause harmful interference to radio or television reception, which can be determined by turning the equipment off and on, the user is encouraged to try to correct the interference by one or more of the following measures:

- Reorient or relocate the receiving antenna.
- Increase the separation between the equipment and receiver.
- Connect the equipment into an outlet on a circuit different from that to which the receiver is connected.
- Consult the dealer or an experienced radio TV technician for help.

#### **NOTE**

- ◆ The changes or modifications not expressly approved by the party responsible for compliance could void the user's authority to operate the equipment.

- Shield interface cables and AC power cord, if any, must be used in order to comply with the emission limits.

## FCC Conditions

This device complies with part 15 of the FCC Rules. Operation is subject to the following two conditions:

- This device may not cause harmful interference.
- This device must accept any interference received, including interference that may cause undesired operation.



廢電池請回收

For better environmental protection, waste batteries should be collected separately for recycling or special disposal.

## Safety Instructions

---



Read the safety instructions carefully and thoroughly.

All cautions and warnings on the equipment or user's manual should be noted.



Keep the User's Guide that comes with the package for future reference.

---



Keep this equipment away from humidity and high temperature.



Lay this equipment on a stable surface before setting it up.

---



The openings on the enclosure are used for air convection and to prevent the equipment from overheating. Do not cover the openings.



Make sure the power voltage is within safety range and has been adjusted properly to the value of 100~240V before connecting the equipment to the power outlet.

---



Never pour liquid into the opening that could damage the equipment or cause an electrical shock.



Do not leave the equipment in an unconditioned environment with a storage temperature above 60°C (140°F) or below 0°C (32°F), which may damage the equipment.

---



Place the power cord in a way that people are unlikely to step on it. Do not place anything on top of the power cord.



Always unplug the power cord before inserting any add-on card or module.



To prevent explosion caused by improper battery replacement, use the same or equivalent type of battery recommended by the manufacturer only.



When installing the coaxial cable to the TV Tuner, it is necessary to ensure that the metal shield is reliably connected to protective earthing system of the building.



Always keep the battery in a safe place.



Always keep the strong magnetic or electrical objects away from the equipment.

If any of the following situations arises, get the equipment checked by a service personnel:



- ◆ The power cord or plug is damaged.
- ◆ Liquid has penetrated into the equipment.
- ◆ The equipment has been exposed to moisture.
- ◆ The equipment has not worked well or you can not get it work according to User's Manual.
- ◆ The equipment was dropped and damaged.
- ◆ The equipment has obvious signs of breakage.



## Safety Guideline for Using Lithium Battery

---

(English) **CAUTION:** Danger of explosion if battery is incorrectly replaced. Replace only with the same or equivalent type recommended by the equipment manufacturer. Discard used batteries according to manufacturer's instructions.

---

(French) (**Français**) **ATTENTION:** Il y a danger d'explosion s'il y a remplacement incorrect de la batterie. Remplacer uniquement avec une batterie du même type ou d'un type équivalent recommandé par le constructeur. Mettre au rebut les batteries usagées conformément aux instructions du fabricant.

---

(German) (**Deutsch**) **VORSICHT:** Explosionsgefahr bei unsachgemäßem Austausch der Batterie. Ersatz nur durch denselben oder einen vom Hersteller empfohlenen gleichwertigen Typ. Entsorgung gebrauchter Batterien nach Angaben des Herstellers.

---

(Spanish) (**Español**) **PRECAUCIÓN:** Peligro de explosión si la batería es reemplazada incorrectamente. Cámbiela solo por la misma o un tipo equivalente recomendado por el fabricante. Descarte usar baterías usadas de acuerdo con las instrucciones del fabricante.

---

(Italian) (**Italiano**) **ATTENZIONE:** Pericolo di esplosione della batteria se sostituita in modo non corretto. Sostituire solo con la stesso tipo o con uno equivalente come indicato nel manuale del produttore. Smaltire le batterie usate come da istruzioni del produttore.

---

(Russian) (**Русский**) **Внимание:** Существует опасность взрыва батареи в случае неправильной замены. Для замены всегда используйте такую же или эквивалентную, рекомендованную производителем оборудования. Следуйте инструкциям производителя при утилизации использованных батарей.

---

(Turkish) (**Türkçe**) **UYARI:** Pili yanlış yerleştirilirse patlayabilir. Aynı ya da muadili bir pille değiştiriniz. Kullanılmış pilleri

---

üreticinin talimatlarına göre degerlendiriniz.

(Greek) (Ελληνικά) ΠΡΟΣΟΧΗ: Κίνδυνος έκρηξης εάν η μπαταρία τοποθετηθεί λανθασμένα. Να αντικαθιστάτε μόνο με τον ίδιο ή αντίστοιχο τύπο με αυτό που συνιστά ο κατασκευαστής του εξοπλισμού. Να απορρίψετε τις χρησιμοποιημένες μπαταρίες ως απορρίμματα σύμφωνα με τις οδηγίες του κατασκευαστή.

(Polish) (Polski) OSTRZEŻENIE: Nieprawidłowa wymiana może spowodować eksplozję baterii. Zamianę można wykonać wyłącznie na baterię tego samego lub równoważnego typu zalecaną przez producenta urządzenia. Zużyte baterie można wyrzucić zgodnie z instrukcjami producenta.

(Hungarian) (Magyar) VIGYÁZAT: A nem megfelelő akkumulátor használatáért a termék nem felelős. Csak a gyártó által ajánlott, egyenértékű típust használjon. Az elhasznált akkumulátorokat a gyártó utasításának megfelelően ártalmatlanítsák.

(Czech) (Čeština) UPOZORNĚNÍ: Nebezpečí výbuchu při chybné výměně baterie. Nahradte pouze stejným nebo ekvivalentním typem doporučeným výrobcem zařízení. Použité baterie zlikvidujte podle pokynů výrobce

(Traditional Chinese) (繁體中文) 注意: 若電池若未正確更換, 可能會爆炸。請用原廠建議之同款或同等級的電池來更換。請依原廠指示處理廢棄電池。

(Simplified Chinese) (简体中文) 注意: 若電池若未正確更換, 可能會爆炸。請用原廠建議之同款或同等級的電池來更換。請依原廠指示處理廢棄電池。

(Japanese) (日本語) 警告: バッテリーの取り扱いを誤ると、液漏れや破裂などにより生命や財産に重大な影響を及ぼす恐れがあります。指定された型番以外のバッテリーは使用しないでください。バッテリーを廃棄する場合は、各自治体の規則に従って適切に処理して下さい。

(Korean) (한국어) 주의: 배터리를 올바르게 교체하지 않으면 폭발할 위험이 있습니다. 타입이 장치 제조업체에서

---

권장하는 것과 동일하거나 동등한 배터리로만 교체하십시오. 사용한 배터리는 제조업체의 지침에 따라 폐기하십시오.

---

(Vietnamese) (Tieng Viet) LƯU Ý: Thay thế pin không tương thích có thể dẫn đến nguy cơ bị nổ. Chỉ thay thế bằng pin cùng loại hoặc loại tương ứng khuyến dùng bởi nhà sản xuất thiết bị. Vứt bỏ pin đã sử dụng theo hướng dẫn của nhà sản xuất.

---

(Thai) (ไทย) ข้อควรระวัง: ถ้าใส่แบตเตอรี่อย่างไม่ถูกต้อง อาจมีอันตรายจากการระเบิดขึ้นได้ ใช้เฉพาะแบตเตอรี่ชนิดเดียวกัน หรือเทียบเท่า ที่แนะนำโดยผู้ผลิตอุปกรณ์เท่านั้น ทั้งแบตเตอรี่ที่ใช้แล้วตามคำแนะนำของผู้ผลิต

---

(Indonesian) (Bahasa Indonesia) PERHATIAN: Bahaya ledakan dapat terjadi jika salah memasang baterai. Ganti baterai hanya dengan jenis yang sama atau setara sesuai rekomendasi pabrik peralatan tersebut. Buang baterai bekas sesuai petunjuk pabrik

---

(Serbian) (Srpski) OPREZ: Ukoliko baterija nije ispravno postavljena, postoji opasnost od eksplozije. Zamenu izvršite koristeći isključivo istu ili ekvivalentnu bateriju koju preporučuje proizvođač opreme. Odbacite iskorišćene baterije u skladu sa uputstvima proizvođača.

---

(Netherlands) (Nederlands) LET OP: Er is explosiegevaar als de batterij niet goed geplaatst wordt. Uitsluitend te vervangen door een batterij van hetzelfde of een gelijkwaardig type, zoals aanbevolen door de fabrikant. Gooi batterijen weg volgens de plaatselijke instructies.

---

(Romanian) (Română) ATENȚIE: Pericol de explozie dacă bateria este înlocuită incorect. Înlocuiți doar cu același tip sau echivalent recomandat de fabricantul echipamentului. Evacuați bateriile folosite conform instrucțiunilor fabricantului.

---

(Portuguese) (Português) ADVERTÊNCIA: Perigo de explosão se a bateria é substituída incorretamente. Substitua somente com o mesmo tipo ou equivalente recomendado por o fabricante do seu equipamento. Descarte as baterias

---

---

utilizadas de acordo com as instruções do fabricante.

---

(Swedish) (Svenska) VARNING: Explosionsfara vid felaktigt batteritype. Använd samma batterityp eller en ekvivalent typ som rekommenderas av apparattillverkaren. Kassera använt batteri enligt fabrikanterns instruktion.

---

(Finnish) (Suomi) VAROITUS: Paristo voi räjähtää, jos se on virheellisesti asennettu. Vaihda paristo ainoastaan valmistajan suosittelemaan tyyppiin. Hävitä käytetty paristo valmistajan ohjeiden mukaisesti.

---

(Slovakian) (Slovensky/Slovenčina) UPOZORNENIE: V prípade nesprávnej výmeny batérie existuje nebezpečenstvo výbuchu. Vymeňte iba za rovnakú batériu alebo za rovnocenný typ batérie, ktorý odporúča výrobca zariadenia. Batérie zneškodnite podľa pokynov výrobcu.

---

(Slovenian) (Slovensko/ Slovenščina) POZOR: V primeru nepravilne zamenjave baterije obstaja nevarnost njene eksplozije. Baterijo zamenjajte le z enako ali ekvivalentno vrsto, ki jo priporoča proizvajalec. Odpadne baterije odstranite skladno z navodili proizvajalca.

---

(Danish) (Dansk) ADVARSEL! Lithiumbatteri --- Eksplosionsfare ved fejlagtig håndtering. Udskiftning må kun ske med batteri af same fabrikat og type. Lev det brugte batteri tilbage til leverandøren.

---

(Norwegian) (Norsk) ADVARSEL: Eksplosjonsfare ved feilaktig skifte av batteri. Benytt same batteritype eller en tilsvarende type anbefalt av apparatfabrikanten. Brukte batterier kasseres i henhold til fabrikanterns instruksjoner.

---

(Bulgarian) (български) ВНИМАНИЕ: Опасност от експлозия ако батерията бъде неправилно поставена. Поставете батерия от същия вид или еквивалентна батерия, която се препоръчва от производителя. Изхвърлете използваните батерии като спазвате указанията на производителя.

---

(Croatian) (Hrvatski) OPREZ: Opasnost od eksplozije ako se baterija zamijeni neprikladnom. Zamijenite je samo jednakom ili nadomjesnom vrstom prema preporuci proizvođača. Istrošene baterije zbrinite u skladu s uputama

---

proizvođača.

(Estonian) (Eesti) ETTEVAATUSTI Plahvatusoht, kui aku on valesti paigaldatud. Asendage ainult sama või tootja poolt soovitatud võrdväärse akuga. Hävitage kasutatud aku vastavalt tootja juhistele.

(فارسی) (Persian)

أخطار: در صورت عدم نصب و جاگذاری صحیح باتری، احتمال انفجار باتری وجود دارد. در صورت تعویض باتری، تنها از باتریهای پیشنهادی شرکت تولید کننده استفاده نمایید. از دور انداختن باتری خودداری کنید و بر طبق راهنمایی شرکت تولید کننده عمل نمایید.

(العربية) (Arabic)

تحذير: خطر، قد تتعرض البطارية للانفجار والتلف إذا تم استبدالها بنوع غير أصلي. استبدل فقط بنفس أو نوع مكافئ أوصى به من قبل منتج الجهاز. تجاهل البطاريات المستعملة وفقا لإرشادات الشركة المصنعة.



## WEEE Statement

(English) Under the European Union ("EU") Directive on Waste Electrical and Electronic Equipment, Directive 2002/96/EC, which takes effect on August 13, 2005, products of "electrical and electronic equipment" cannot be discarded as municipal waste anymore and manufacturers of covered electronic equipment will be obligated to take back such products at the end of their useful life.

(French) (Français) Au sujet de la directive européenne (EU) relative aux déchets des équipements électriques et électroniques, directive 2002/96/EC, prenant effet le 13 août 2005, que les produits électriques et électroniques ne peuvent être déposés dans les décharges ou tout simplement mis à la poubelle. Les fabricants de ces équipements

---

seront obligés de récupérer certains produits en fin de vie.

---

(German) (*Deutsch*) Gemäß der Richtlinie 2002/96/EG über Elektro- und Elektronik-Altgeräte dürfen Elektro- und Elektronik-Altgeräte nicht mehr als kommunale Abfälle entsorgt werden, die sich auf 13. August, 2005 wirken. Und der Hersteller von bedeckt Elektronik-Altgeräte gesetzlich zur gebrachten Produkte am Ende seines Baruchbarkeitsdauer zurückzunehmen.

---

(Spanish) (*Español*) Bajo la directiva 2002/96/EC de la Unión Europea en materia de desechos y/o equipos electrónicos, con fecha de rigor desde el 13 de agosto de 2005, los productos clasificados como "eléctricos y equipos electrónicos" no pueden ser depositados en los contenedores habituales de su municipio, los fabricantes de equipos electrónicos, están obligados a hacerse cargo de dichos productos al termino de su período de vida.

---

(Italian) (*Italiano*) In base alla Direttiva dell'Unione Europea (EU) sullo Smaltimento dei Materiali Elettrici ed Elettronici, Direttiva 2002/96/EC in vigore dal 13 Agosto 2005, prodotti appartenenti alla categoria dei Materiali Elettrici ed Elettronici non possono più essere eliminati come rifiuti municipali: i produttori di detti materiali saranno obbligati a ritirare ogni prodotto alla fine del suo ciclo di vita.

---

(Russian) (*Русский*) В соответствии с директивой Европейского Союза (EC) по предотвращению загрязнения окружающей среды использованным электрическим и электронным оборудованием (директива WEEE 2002/96/EC), вступающей в силу 13 августа 2005 года, изделия, относящиеся к электрическому и электронному оборудованию, не могут рассматриваться как бытовой мусор, поэтому производители вышеперечисленного электронного оборудования обязаны принимать его для переработки по окончании срока службы.

---

(Turkish) (*Türkçe*) Avrupa Birliği (AB) Karamamesi Elektrik ve Elektronik Malzeme Atığı, 2002/96/EC Karamamesi altında 13 Ağustos 2005 tarihinden itibaren geçerli olmak üzere, elektrikli ve elektronik malzemeler diğer atıklar gibi çöpe atılmayacak ve bu elektronik cihazların üreticileri, cihazların kullanım süreleri bittikten sonra ürünleri geri toplamakla

---

---

yükümlü olacaktir.

---

(Greek) (Ελληνικά) Σύμφωνα με την Οδηγία 2002/96/EK της Ευρωπαϊκής Ένωσης («ΕΕ») περί Απόρριψης Ηλεκτρικού και Ηλεκτρονικού Εξοπλισμού (WEEE), η οποία λαμβάνει ισχύ στις 13 Αυγούστου 2005, τα προϊόντα «ηλεκτρικού και ηλεκτρονικού εξοπλισμού» δεν είναι δυνατόν να απορριφθούν πλέον ως κοινά απορρίμματα και οι κατασκευαστές καταλλυμένων ηλεκτρονικού εξοπλισμού είναι υποχρεωμένοι να πάρουν πίσω αυτά τα προϊόντα στο τέλος της ωφέλιμης ζωής τους.

---

(Polish) (Polski) Zgodnie z Dyrektywą Unii Europejskiej ("UE") dotyczącą odpadów produktów elektrycznych i elektronicznych (Dyrektywa 2002/96/EC), która wchodzi w życie 13 sierpnia 2005, tzw. "produkty oraz wyposażenie elektryczne i elektroniczne" nie mogą być traktowane jako śmieci komunalne, tak więc producenci tych produktów będą zobowiązani do odbierania ich w momencie gdy produkt jest wycofywany z użycia.

---

(Hungarian) (Magyar) Az Európai Unió („EU”) 2005. augusztus 13-án hatályba lépő, az elektromos és elektronikus berendezések hulladékkairól szóló 2002/96/EK irányelve szerint az elektromos és elektronikus berendezések többé nem kezelhetők lakossági hulladékként, és az ilyen elektronikus berendezések gyártói köteleessé válnak az ilyen termékek visszavételére azok hasznos élettartama végén.

---

(Czech) (Čeština) Podle směrnice Evropské unie ("EU") o likvidaci elektrických a elektronických výrobků 2002/96/EC platné od 13. srpna 2005 je zakázáno likvidovat "elektrické a elektronické výrobky" v běžném komunálním odpadu a výrobci elektronických výrobků, na které se tato směrnice vztahuje, budou povinni odebírat takové výrobky zpět po skončení jejich životnosti.

---

(Traditional Chinese) (繁體中文) 歐盟已制訂有關廢電機電子設備法令，亦即自 2005 年 8 月 13 日生效的 2002/96/EC，明文規定「電機電子設備產品」不可再以都市廢棄物處理，且所有相關電子設備製造商，均須在產品使用壽命結束後進行回收。

---

---

(Simplified Chinese) (简体中文) 欧盟已制订有关废电机电子设备法令，亦即自 2005 年 8 月 13 日生效的 2002/96/EC，明文规定「电机电子设备产品」不可再以都市废弃物处理，且所有相关电子设备制造商，均须在产品使用寿命结束后进行回收。

---

(Japanese) (日本語) (Japanese) (日本語) 2005 年 8 月 13 日以降に EU 加盟国を流通する電気・電子製品には WEEE 指令によりゴミ箱に×印のリサイクルマークの表示が義務づけられており、廃棄物として捨てることの禁止とリサイクルが義務づけられています。

---

(Korean) (한국어) 2005 년 8 월 13 일자로 시행된 폐전기전자제품에 대한 유럽연합("EU") 지침, 지침 2002/96/EC 에 의거하여, "전기전자제품"은 일반 쓰레기로 폐기할 수 없으며 제품의 수명이 다하면 해당 전자제품의 제조업체가 이러한 제품을 회수할 책임이 있습니다.

---

(Vietnamese) (Tieng Viet) Theo Hướng dẫn của Liên minh Châu Âu ("EU") về Thiết bị điện & điện tử đã qua sử dụng, Hướng dẫn 2002/96/EC, vốn đã có hiệu lực vào ngày 13/8/2005, các sản phẩm thuộc "thiết bị điện và điện tử" sẽ không còn được vứt bỏ như là rác thải đồ thị nữa và các nhà sản xuất thiết bị điện tử tuân thủ hướng dẫn sẽ phải thu hồi các sản phẩm này vào cuối vòng đời.

---

(Thai) (ไทย) ภายใต้ข้อกำหนดของสหภาพยุโรป ("EU") เกี่ยวกับของเสียจากอุปกรณ์ไฟฟ้า และอิเล็กทรอนิกส์ เลขที่ 2002/96/EC ซึ่งมีผลบังคับใช้ตั้งแต่วันที่ 13 สิงหาคม 2005 ผู้ใช้ไม่สามารถทิ้งผลิตภัณฑ์ที่เป็น "อุปกรณ์ไฟฟ้าและอิเล็กทรอนิกส์" ประปนกับของเสียทั่วไปของชุมชนได้อีกต่อไป และผู้ผลิตอุปกรณ์อิเล็กทรอนิกส์ดังกล่าวจะต้องบังคับให้นำผลิตภัณฑ์ดังกล่าวกลับคืนเมื่อสิ้นสุดอายุการใช้งานของผลิตภัณฑ์

---

(Indonesian) (Bahasa Indonesia) Sesuai dengan Regulasi Uni Eropa ("UE") perihal WEEE (Limbah Peralatan Listrik dan Elektronik), Directive 2002/96/EC, yang berlaku sejak 13, 2005, produk "peralatan listrik dan elektronik" tidak lagi dapat dibuang sebagai sampah umum dan pabrik peralatan elektronik diwajibkan untuk mengambil kembali produk tersebut pada saat masa pakainya habis.

---



---

(Serbian) (**Srpski**) Po Direktivi Evropske unije ("EU") o odbačenoj eelektronskoj i električnoj opremi, Direktiva 2002/96/EC, koja stupa na snagu od 13. Avgusta 2005, proizvodi koji spadaju pod "elektronsku i električnu opremu" ne mogu više biti odbačeni kao običan otpad i proizvođači ove opreme biće prinuđeni da uzmu natrag ove proizvode na kraju njihovog uobičajenog veka trajanja.

---

(Netherlands) (**Nederlands**) De richtlijn van de Europese Unie (EU) met betrekking tot Vervuiling van Electriche en Electronische producten (2002/96/EC), die op 13 Augustus 2005 in zal gaan kunnen niet meer beschouwd worden als vervuiling. Fabrikanten van dit soort producten worden verplicht om producten retour te nemen aan het eind van hun levenscyclus..

---

(Romanian) (**Română**) În baza Directivei Uniunii Europene ("UE") privind Evacuarea Echipamentului Electric și Electronic, Directiva 2002/96/EC, care intră în vigoare pe 13 august, 2005, produsele din categoria "echipament electric și electronic" nu mai pot fi evacuate ca deșeurî municipale, iar fabricanții echipamentului electronic vizat vor fi obligați să primească înapoi produsele respective la sfârșitul duratei lor de utilizare.

---

(Portuguese) (**Português**) De acordo com a Directiva 2002/96/EC de Resíduos de Equipamentos Eléctricos e Electrónicos da União Europeia (UE), efectiva desde o 13 de Agosto do ano 2005, os produtos de "equipamento eléctrico e electrónico" não podem ser descartados como resíduo municipal e os fabricantes do equipamento electrónico sujeitos a esta legislação estarão obrigados a recolher estes produtos ao finalizar sua vida útil.

---

(Swedish) (**Svenska**) Under Europeiska unionens ("EU") Weee-direktiv (Waste Electrical and Electronic Equipment), Direktiv 2002/96/EC, vilket trädde i kraft 13 augusti, 2005, kan inte produkter från "elektriska och elektroniska utrustningar" kastas i den vanliga hushållssoporna längre och tillverkare av inbyggd elektronisk utrustning kommer att tvingas att ta tillbaka sådana produkter när de är förbrukade.

---

(Finnish) (**Suomi**) Euroopan unionin (EU) 13.8.2005 voimaan tulleen sähkö- ja elektroniikkalaiteromua koskevan

---

---

direktiivin 2002/96/EY mukaisesti "sähkö- ja elektroniikkalaitteita" ei saa enää hävittää talousjätteiden mukana. Direktiivin alaisen sähkö- tai elektroniikkalaitteen valmistajan on otettava laitteet takaisin niiden käyttöiän päättyessä.

---

(Slovakian) (Slovensky/ Slovenčina) Na základe smernice Európskej únie („EU“) o elektrických a elektronických zariadeniach číslo 2002/96/ES, ktorá vstúpila do platnosti 13. augusta 2005, výrobky, ktorými sú „elektrické a elektronické zariadenia“ nesmú byť zneškodňované spolu s komunálnym odpadom a výrobcovia patričných elektronických zariadení sú povinní takého výrobky na konci životnosti prevziať naspäť.

---

(Slovenian) (Slovensko/ Slovenščina) Skladno z določili direktive Evropske unije ("EU") o odpadni električni in elektronski opremi, Direktiva 2002/96/ES, ki je veljavna od 13. avgusta, izdelkov "električne in elektronske opreme" ni dovoljeno odstranjevati kot običajne komunalne odpadke, proizvajalci zadevne elektronske opreme pa soavezani, da tovrstne izdelke na koncu njihove življenjske dobe sprejmejo nazaj.

---

(Danish) (Dansk) I henhold til direktiv fra den europæiske union (EU) vedrørende elektrisk og elektronisk affald , Direktiv 2002/96/EC, som træder i kraft den 13. august 2005, må produkter som "elektrisk og elektronisk udstyr" ikke mere bortskaffes som kommunalt affald. Producenter af det pågældende, elektroniske udstyr vil være forpligtet til at tage disse produkter tilbage ved afslutningen på produkternes levetid.

---

(Norwegian) (Norsk) Under den europeiske unionens ("EU") direktiv om deponering av elektronisk og elektrisk utstyr, direktiv 2002/96/EC, som trer i effekt 13. august 2005, kan ikke produkter av "elektronisk og elektrisk utstyr" lenger deponeres som husholdningsavfall og fabrikantene av disse produktene er forpliktet å ta tilbake slike produkter ved slutten av produktets levetid.

---

(Bulgarian) (Български) Според директивата на Европейския съюз относно отпадъците от електрическо и електронно оборудване, директива 2002/96/ЕС, вважана от 13 август, 2005 г., електрическо и електронно оборудване не може да се извървя заедно с битовите отпадъци и производителите на такова оборудване са

---

задължени да приемат обратно съответните продукти в края на експлоатационния им период.

(Croatian) (Hrvatski) U okviru Direktive Europske Unije ("EU") o Otpadnim električnim i elektroničkim uređajima, Direktiva 2002/96/EC, koja je na snazi od 13. kolovoza 2005., "električni i elektronički uređaji" se ne smiju više bacati zajedno s kućnim otpadom i proizvođači su obvezni zbrinuti takve proizvode na kraju njihovog životnog vijeka.

(Estonian) (Eesti) Vastavalt Euroopa Liidu ("EL") direktiivile 2002/96/EÜ (elektri- ja elektroonikaseadmete jäätmete kohta), mis jõustus 13. augustil 2005, on keelatud kodumajapidamiste "elektri- ja elektroonikaseadmete" jäätmete hävitamine koos majapidamisjäätmetega, ja elektri- ja elektroonikaseadmete tootjad on kohustatud sellised tooted pärast nende kasutuselt kõrvaldamist tagasi võtma.

(Persian) (فارسی)

اتحادیه اروپا که از تاریخ 13 اگوست سال 2005 میلادی قبل اجراست ، کلیه شرکت های 2002/96/EC بر طبق قانون دفع زباله های الکتریکی و الکترونیکی (بند تولید کننده موظف به جمع آوری زباله محصولات خود پس از پایان دوره مصرف می باشند.

(Arabic) (العربية)

في إطار اتفاقية الإتحاد الأوروبي ("الإتحاد الأوربي") التوجيه بشأن نفايات المعدات والأجهزة الكهربائية والإلكترونية، توجيه 2002/96/EC للمجموعة الأوربية، الذي أصبح ساري المفعول في 13 أغسطس/آب، 2005، ان منتجات "أجهزة كهربائية والإلكترونية" لا يمكن التخلص عنها بوصفها نفايات، ومنتجات المعدات الإلكترونية سيكون لزاما عليهم استرداد مثل هذه المنتجات في نهاية مدة صلاحيتها.

## Trademarks

All trademarks are the properties of their respective owners.

## Release History

Version	Revision Note	Date
1.0	First Released	03, 2009

---

# **CHAPTER 2**

## **Introductions**

---

Congratulations on becoming a user of this notebook, the finely designed notebook. This brand-new exquisite notebook will give you a delightful and professional experience in using notebook. We are proud to tell our users that this notebook is thoroughly tested and certified by our reputation for unsurpassed dependability and customer satisfaction.

## Manual Map

This User's Manual provides instructions and illustrations on how to operate this notebook. It is recommended to read this manual carefully before using this notebook.

**Chapter 1. Preface.** gives users the basic safety information and caution that is interrelated to using this notebook. It is recommended to read these information or caution when using this notebook for the first time.

**Chapter 2. Introductions.** includes the descriptions of all the accessories of this notebook. It is recommended to check out that if you have all the accessories included when you open the packing box. If any of these accessories is damaged or missing, please contact the vendor where you purchased this notebook. Also, this chapter provides the specification of this notebook, and introduces the function buttons, quick launch buttons, connectors, LEDs and externals of this notebook.

**Chapter 3. Getting Started.** gives the basic operation instructions on using keyboard, touchpad, and hard disk drive. Beside, the steps of installing and uninstalling the battery; and the procedures of connecting the various external devices, communication devices, and so on, are also provided to help users getting familiar with this notebook.

**Chapter 4. BIOS Setup**, provides information on BIOS Setup program and allows you to configure the system for optimum use.

## Unpacking

First, unpack the shipping carton and check all items carefully. If any item contained is damaged or missing, please contact your local dealer immediately. Also, keep the box and packing materials in case you need to ship the unit in the future. The package should contain the following items:



Notebook



Quick Start Manual

---



High-capacity Li-ion battery



AC adapter and power cord

---



Carry bag (optional)

---



All-in-one application disk, containing the full version of user's manual, drivers, utilities, and optional recovery function, etc..

---

### INFO

*These accessories listed above may change without notice.*

## Specification

### Physical Characteristic

---

Dimension	330 (W) x 224 (D) x 20~6 (H) mm (minimum height is 6mm)
Weight	1.4 kg (with 4 cell battery)

### CPU

---

Processor Type	Intel® Micro FCBGA
Support Processor	Intel® Penryn SFF ULV processor/ Intel® Atom™ processor (optional)
L2 Cache	Based on the CPU type
FSB Speed	533 / 667 MHz or 800/ 1066 MHz
Special Notification	The actual processor preinstalled in the notebook depends on the model you purchased. Please contact the local dealer for detailed information.

### Core Chips

---

North Bridge+ South Bridge	Intel ® Poulso (single chip) / Intel ® GS45 + Intel ® ICH9M-SFF Enhanced
----------------------------	--



---

**Memory**

Technology	DDR2 800MHz
Memory	DDR2 SO-DIMM X 1 slot
Maximum	2GB /4GB (optional)

---

**Power**

AC Adapter	40W, 20V (optional)
Battery Type	4 cells 8 cells (optional)
RTC Battery	Yes
Special Notification	The actual battery pack that comes with the package may vary without notice.

---

**Storage** (Items listed here may vary without notice)

HDD form factor	2.5", 9.5 mm High, SATA
SSD (solid-state disk)	32GB (optional)
External Optical Device	USB External ODD (optional)
Special Notification	The actual HDD and SSD preinstalled in the notebook depends on the model you purchased.

## I/O Port

---

Monitor (VGA)	15 pin D-Sub x 1
USB	USB 2.0 x 2 / x 3 (optional)
HDMI	x 1 (optional)
Mic-in	x 1(support Headphone-out function)
Headphone-out	x 1
Internal Microphone	x 1
RJ45	x 1
Card Reader	x 1 (SD/ SDHC/ MMC) (optional)

The supported memory cards may vary without notice.

## Communication Port (Items listed here may vary without notice)

---

LAN	10/100 Ethernet (optional) 10/100/1000 Ethernet (optional)
Wireless LAN	Support
Bluetooth	Support (optional)
3.5G	Support (optional)

## Display

---

LCD Type	13.4" WXGA (Glare type)
Brightness	Brightness controlled by K/B hot-keys

**Video (optional)**

---

Graphics	Intel® Graphics Media Accelerator 4500MHD (optional) Intel® Poulso (optional)
VRAM	Share with the memory
LCD Resolution	1366 x 768
CRT Output	Supported
Dual View Function	LCD or CRT will be auto detected when connected.

**WebCam**

---

CMOS	1.3 Mega Pixel
------	----------------

**Audio**

---

Sound Controller	Realtek® ALC 888-VC2-GR
Internal Speaker	2 speakers with housing
Sound Volume	Adjust by K/B hot-key & SW

**Software & BIOS**

---

USB Flash Boot	Yes, USB floppy boot up DOS only
BIOS	Fast Boot Support --- Yes

**Others**

---

Compliance	WHQL
------------	------

### **Upgrade and Warranty**

---

Please be noticed that the memory, hard disk drive, optical storage drive, and battery pack preinstalled in the product users purchased may be replaceable and upgradable by user's request.

However, please always contact the authorized dealer or service center for the upgrade service due to any attempt to replace the components of the product may cause the warranty void.

## Product Overview

This section provides the description of basic aspects of the notebook. It will help you to know more about the appearance of this notebook before using it. Please be aware that the notebook shown in this section may vary from the actual one that users purchased.

### Top-open View

The figure of top-open view and description shown below will lead you to browse the main operating area of your notebook.

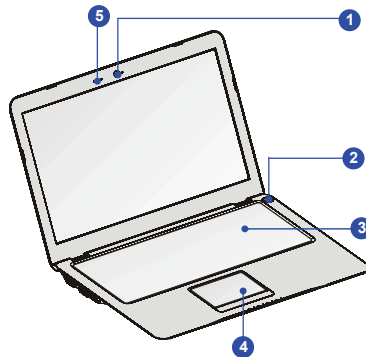

1. WebCam
2. Power Button / Power LED
3. Keyboard
4. Touchpad
5. Internal Microphone



The figures show here are  
for reference only.

### 1. Webcam / Webcam LED

- This built-in Webcam can be used for picture taking, video recoding or conferencing, and any other interactive applications.
- Webcam LED indicator, next to the webcam, grows white when webcam function is activated; LED goes out when this function is turned off.

### 2. Power Button / Power LED

#### Power Button



- Press the power button to turn the notebook power ON and OFF.

#### Power LED:

- Glowing white when the notebook power is turned on.

### 3. Keyboard

The built-in keyboard provides all the functions of a full-sized keyboard.

#### Quick Launch [Fn] Buttons

Use the [Fn] buttons on the keyboard to activate the specific applications or tools.

With the help of these quick launch buttons, users will be able to do work more efficiently.



Webcam

- Press and hold the **Fn** button, and then press the **F6** button to turn the **Webcam** function on. Press again to turn it off.
- Read the icon on behalf of the Webcam function appearing on the display to learn the **Webcam** function status.

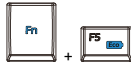

**ECO Engine**  
(Power Saving)

- Press and hold the **Fn** button, and then press the **F5** button to turn the **ECO Engine** function on.
- Refer to the Power Management section in chapter 3 of this manual for the detailed information of this ECO Engine, Power Saving Function.



**Wireless LAN(WiFi)**

- Press and hold the **Fn** button, and then press the **F8** button to turn the **Wireless LAN (WiFi)** function on. Press again to turn it off.
- Read the icon on behalf of the function of **Wireless LAN (WiFi)** appearing on the display to learn the function status.
- The actual activate function will be controlled by the Intel PROSet software



**Bluetooth**  
(optional)

- Press and hold the **Fn** button, and then press the **F9** button to turn the **Bluetooth** function on. Press again to turn it off.
- Read the icon on behalf of the function of **Bluetooth** appearing on the display to learn the function status.

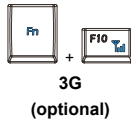

- Press and hold the **Fn** button, and then press the **F10** button to turn the **3G** function on. Press again to turn it off.
- Read the icon on behalf of the function of **3G** appearing on the display to learn the function status.
- If the model you purchased is without 3G function, there is no function when you Press and hold the **Fn** button, and then press the **F10** button repeatedly.

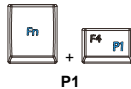

- Press and hold the **Fn** button, and then press the **F4** button to turn the windows search function on. Press again to turn it off.
- Read the icon on behalf of the **P1** function appearing on the display to learn the function status.

#### 4. Touchpad

This is a pointing device of the notebook.

#### 5. Internal Microphone

There is built-in microphone and its function is the same with microphone.



## Front Side View

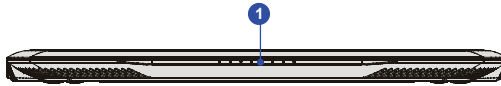

1. Status LED

### 1. Status LED



**Bluetooth  
(optional)**

#### **Bluetooth:**

Glowing white when Bluetooth function is activated.



#### **Power On/ Off/ Suspend:**

- ◆ Glowing white when the system is activated.
- ◆ Blinking white when the system is in suspend mode.
- ◆ LED goes out when the system is turned off.



#### **Battery:**

- ◆ Glowing white when the battery is being charged.
- ◆ Glowing amber when the battery is in low battery status.
- ◆ Blinking amber if the battery fails and it is recommended to replace a

---

new battery. Consult the local dealer for purchasing an equivalent type of battery recommended by the manufacturer.

- ◆ Battery LED goes out when it is fully charged or when the AC adapter is disconnected.



**Wireless LAN  
and 3G/  
Wireless LAN**

---

**Wireless LAN and 3G/ Wireless LAN :**

- ◆ Glowing white when wireless LAN function is enabled.
- ◆ Glowing yellow green when 3G function is enabled.
- ◆ LED goes out when all functions are disabled.

Note: For flight safety consideration, make sure this LED goes out when you are in flight.



---

**Scroll Lock:** Glowing white when the Scroll Lock function is activated.



---

**Caps Lock:** Glowing white when the Caps Lock function is activated.



---

**Num Lock:** Glowing white when the Num Lock function is activated.



---

**Hard Disk:**

Blinking white when the system is accessing the hard disk drive device.

## Left Side View

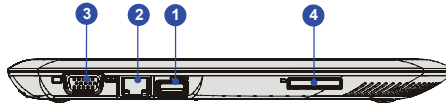

1. USB Port/  
HDMI Connector
2. RJ-45 Connector
3. VGA Port
4. Card Reader

### 1. USB Port/ HDMI Connector (optional)

#### USB Port

The USB 2.0 port allows you to connect USB-interface peripheral devices, such as the mouse, keyboard, modem, portable hard disk module, printer and more.

#### HDMI Connector

HDMI (High Definition Multimedia Interface Support) is a new interface standard for PCs, displays and consumer electronics devices that supports standard, enhanced and high-definition video, plus multi-channel digital audio on a single cable.

### 2. RJ-45 Connector

The Ethernet connector is used to connect a LAN cable for network connection.

### 3. VGA Port

The 15-pin-D-sub VGA port allows you to connect an external monitor or other standard VGA-compatible device (such as a projector) for a great view of the computer display.

### 4. Card Reader

The built-in card reader may support various types of memory card, such as MMC (Multi-Media Card), or SD (Secure Digital), SDHC (SD High Capacity) cards. Contact the local dealer for further and correct information and be noted that **the supported memory cards may vary without notice.**

## Right Side View

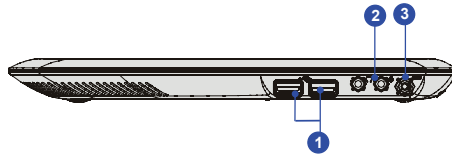

1. USB Port
2. Audio Port Connectors
3. Power Connector

### 1. USB Port

The USB 2.0 port allows you to connect USB-interface peripheral devices, such as the mouse, keyboard, modem, portable hard disk module, printer and more.

## 2. Audio Port Connectors

Make high quality sound blaster with stereo system and Hi-Fi function supported.

---

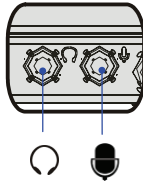

**Mic-in:** Used for an external microphone.

**Line In:** Used for an external audio device.

**Headphone-out:** A connector for speakers or headphones.

---



**Headphone-out:** A connector for speakers or headphones.

---

## 3. Power Connector

To connect the AC adapter and supply power for the notebook.

## Rear Side View



1. Battery Pack

### 1. Battery Pack

This notebook will be powered by the battery pack when the AC adapter is disconnected.

## Bottom Side View

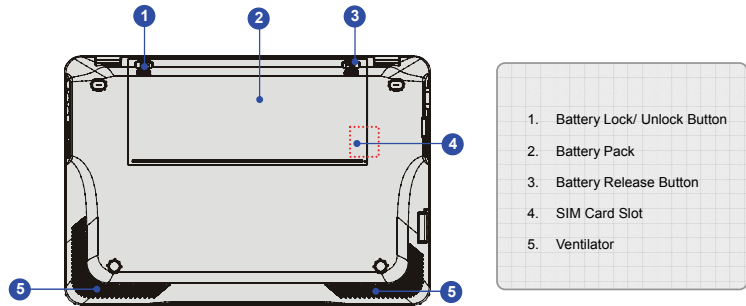

### 1. Battery Lock/ Unlock Button

Battery cannot be moved when the button is positioned on lock status. Once the button is slid to unlock position, the battery is removable.

### 2. Battery Pack

This notebook will be powered by the battery pack when the AC adapter is disconnected.



**3. Battery Release Button**

It is a bounce-back device as a preparation for releasing the battery pack. Slide it with one hand and pull the battery pack carefully with the other.

**4. SIM card slot (optional)**

The notebook provides a SIM Card slot in the battery bay. Insert your SIM card into the SIM card slot properly to activate the internet connecting function.

**5. Ventilator**

The ventilator is designed to cool the system. DO NOT block the ventilator for air circulation.

---

# **CHAPTER 3**

Getting Started

---

## Power Management

### ECO Engine -- Power Saving Function

**ECO Engine**, the outstanding and unique power saving function, provides 5 different power saving modes – **Gaming mode**, **Movie mode**, **Presentation mode**, **Office mode**, and **Turbo Battery mode**, to extend the battery running time while performing different tasks with this notebook.

Press and hold the Fn button, and then press the F5 button repeatedly to switch among these 5 different modes or to turn this ECO Engine off recurrently.

To learn which power saving mode is activated presently, read the icon on behalf of each mode appearing on the display when selected.



**Gaming Mode**

#### **Gaming Mode**

Select this mode while performing game applications.



**Movie Mode**

#### **Movie Mode**

Select this mode while playing multimedia applications

---

**Presentation Mode**

Select this mode while performing presentation applications.

Presentation Mode

---

**Office Mode**

Select this mode while dealing with office documentation tasks.

Office Mode

---

**Turbo Battery Mode**

Select this mode to maximize the battery running time.

Turbo Battery Mode

---

**ECO Off**

Selected to disable ECO Engine.

---

## AC Adapter

Please be noted that it is strongly recommended to connect the AC adapter and use the AC power while using this notebook for the first time. When the AC adapter is connected, the battery is being charged immediately.

Note that the AC adapter included in the package is approved for your notebook; using other adapter model may damage either the notebook or other devices attached to it.

### **Connecting the AC Power**

1. Unpack the package to find the AC adapter and power cord.
2. Attach the power cord to the connector of the AC adapter.
3. Plug the DC end of the adapter to the notebook, and the male end of the power cord to the electrical outlet.

### **Disconnecting the AC Power**

When you disconnect the AC adapter, you should:

1. Unplug the power cord from the electrical outlet first.
2. Unplug the connector from the notebook.
3. Disconnect the power cord and the connector of AC adapter.
4. When unplugging the power cord, always hold the connector part of the cord. Never pull the cord directly!

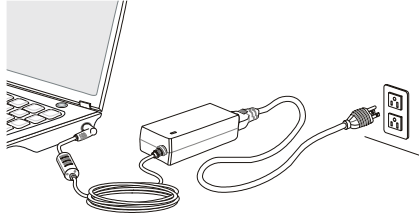

## Battery Pack

This notebook is equipped with a high-capacity Li-ion battery pack. The rechargeable Li-ion battery pack is an internal power source of the notebook.

Be aware of that this battery pack may be damaged if users try to disassemble the battery pack on their own.

Also, note that the limited warranty to the battery pack may also lose its efficacy when this battery pack is disassembled not by an authorized machinist.

Please follow your local laws and regulations to recycle the unused battery pack.

Be noted that the figures show here are for reference only.

### **Releasing the Battery Pack**

It is always recommended to have another battery in reserve for enough power supply. Please contact your local dealer to buy a battery pack that is compliant to your notebook. To remove the battery pack, following the steps below:

1. Make sure the notebook is turned off, and the AC power is disconnected.
2. Press the lock/unlock button to the unlocked position.
3. Locate the battery release button on the bottom side.
4. Push and hold the release button to the battery releasing direction as shown on the bottom side.
5. Carefully slide out the battery pack a bit to the location with "open" mark.
6. Take the battery pack out of the battery tray.

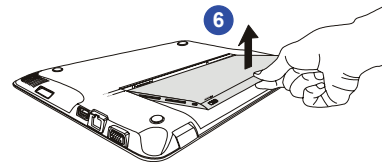
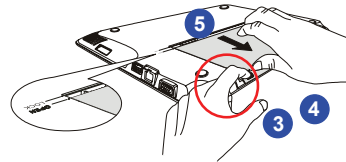
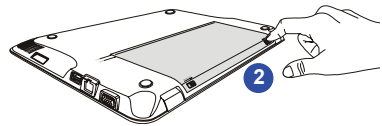



## **Replacing the Battery Pack**

To insert the battery pack, following the steps below:

1. Align the front edge of the battery pack to the location with “open” mark shown aside the battery tray
2. Place the battery pack into the battery tray vertically with correct orientation.
3. Fasten the battery pack by pressing it forward to the “Lock” position
4. Press the lock/unlock button to the Lock position to make sure the battery pack is securely fastened.

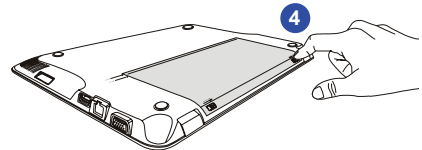
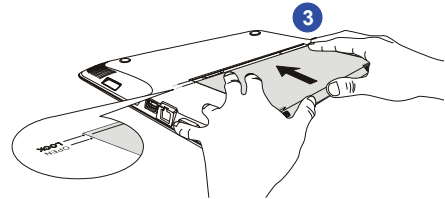
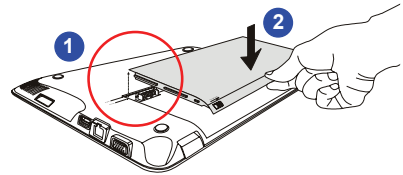

## Using the Battery Pack

### **Battery Safety Tips**

Replacing or handling the battery incorrectly may present a risk of fire or explosion, which could cause serious injury.

- ◆ Only replace the main battery pack with the same or equivalent type of battery.
- ◆ Do not disassemble, short-circuit or incinerate batteries or store them to temperatures above +60° C (+140° F).
- ◆ Do not temper with batteries. Keep away from the reach of children.
- ◆ Do not use rusty or damaged batteries.
- ◆ Dispose of batteries according to local regulations. Check with your local solid waste officials for details about recycling options or for proper disposal in your area.

### **Conserving Battery Power**

Efficient battery power is critical to maintain a normal operation. If the battery power is not managed well, the saved data and customized settings may be lost.

To optimize battery life and avoid a sudden power loss, read the tips below:

- ◆ Suspend system operation if the system will be idle for a while or shorten the suspend timer's time period.
- ◆ Turn off the system if you won't be using it for a period of time.
- ◆ Disable unnecessary settings or remove idle peripherals.
- ◆ Connect an AC adapter to the system whenever possible.

### **Charging the Battery Pack**

The battery pack can be recharged while it is installed in the notebook. Please pay attention to the following tips before recharging the battery:

- ♦ If a charged battery pack is not available, save your work and close all running programs and shut down the system or Save-to-Disk.
- ♦ Plug in an external AC/DC power source.
- ♦ You can use the system, suspend system operation or shut down and turn off the system without interrupting the charging process.
- ♦ The battery pack uses Lithium-ion battery cells that have no “memory effect.” It is unnecessary to discharge the battery before recharging. However, to optimize the life of battery, we suggest that consuming the battery power completely once a month is necessary.
- ♦ If you do not use the notebook for a long time, it is suggested to remove the battery pack from your notebook. This may be helpful to extend your battery life.
- ♦ The actual charging time will be determined by the applications in use.

## Basic Operations

If you are a beginner to the notebook, please read the following instructions to assure your own safety, and make yourself comfortable during the operations.

### Safety and Comfort Tips

The notebook is a portable platform that allows you to work anywhere. However, choosing a good workspace is important if you have to work with your notebook for a long period of time.

- Your work area should have enough illumination.
- Choose the proper desk and chair and adjust their height to fit your posture when operating.
- When sitting on the chair, adjust the chair's back (if available) to support your back comfortably.
- Place your feet flat and naturally on the floor, so that your knees and elbows have the proper position (about 90-degree) when operating.
- Put your hands on the desk naturally to support your wrists.
- Adjust the angle/position of the LCD panel to have an optimal view.
- Avoid using your notebook in the space where may cause you discomfort (such as on the bed).
- The notebook is an electrical device, please treat it with great care to avoid personal injury

1. Keep your hands and feet with optimal comfort.
2. Adjust the angle and position of LCD panel.
3. Adjust the desk's height.
4. Sit straight and keep a good posture.
5. Adjust the chair's height.



## Having a Good Work Habit

Having a good work habit is important if you have to work with your notebook for long periods of time; otherwise, it may cause discomfort or injury to you. Please keep the following tips in mind when operating.

- ♦ Change your posture frequently.
- ♦ Stretch and exercise your body regularly.
- ♦ Remember to take a break after working for a period of time.

## Knowing the Keyboard

This notebook provides a full-functioned keyboard. This keyboard can be divided into four categories: **Typewriter keys**, **Cursor keys**, **Numeric keys** and **Function keys**.

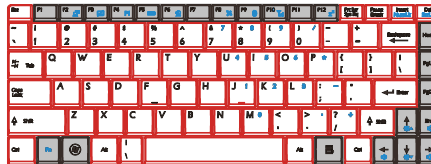

Typewriter keys

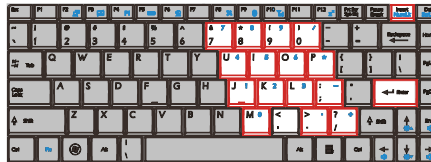

Numeric keys



Cursor keys /  
Function keys

### INFO

The keyboard shown here may vary from the actual one, depending on which county users purchase the notebook.

### Typewriter Keys

In addition to providing the major function of the keyboard, these typewriter keys also provide several keys for special purposes, such as **[Ctrl.]**, **[Alt.]** and **[Esc]** key.

When the lock keys are pressed, the corresponding LEDs will light up to indicate their status:

- **Num Lock:** Press and hold the **[Fn]** key and press this key to toggle the Num Lock on and off. When this function is activated, you can use the numeric keys that are embedded in the typewriter keys.
- **Caps Lock:** Press this key to toggle the Caps Lock on and off. When this function is activated, the letters you type are kept in uppercase.
- **Scroll Lock:** Press and hold the **[Fn]** key and press this key to toggle the Scroll Lock on and off. This function is defined by individual programs, and is usually used under DOS.

### Numeric Keys

Find the numeric keys among the keyboard, and activate the Num Lock function to use these numeric keys to enter numbers and calculations.

## Cursor Keys

The four cursor (arrow) keys and **[Home]**, **[PgUp]**, **[PgDn]**, **[End]** keys are used to control the cursor movement.



Move the cursor left for one space.



Move to the previous page.



Move the cursor right for one space.



Move to the next page.



Move the cursor up for one line.



Move to the beginning of the line (or document).



Move the cursor down for one line.



Move to the end of the line (or document).

The **Backspace** key, **[Ins]** and **[Del]** keys at upper right corner are use for editing purpose.



This key is used to switch the typing mode between “insert” and “overtyping” modes.



Press this key to delete one character to the right of the cursor and move the following text left for one space.





Press this key to delete one character to the left of the cursor and move the following text left for one space.



## Function Keys

### ■ Windows Keys

You can find the Windows Logo key (  ) and one Application Logo key (  ) on the keyboard, which are used to perform Windows-specific functions, such as opening the Start menu and launching the shortcut menu. For more information of the two keys, please refer to your Windows manual or online help.

### ■ [Fn] Key

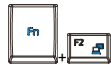

Switch the display output mode between the LCD, external monitor and both.

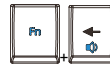

Decrease the built-in speaker's volume.

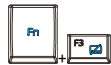

Enable or disable the touchpad function.

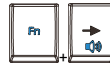

Increase the built-in speaker's volume.



Decrease the LCD brightness.

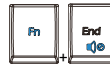

Disable the computer's audio function.



Increase the LCD brightness.

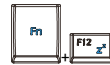

Force the computer into suspend mode (depending on the system configuration).

## Knowing the Touchpad

The touchpad integrated in your notebook is a pointing device that is compatible with standard mouse, allowing you to control the notebook by pointing the location of the cursor on the screen and making selection with its two buttons.

### 1. Cursor Movement Area

This pressure-sensitive area of the touchpad, allows you to place your finger on and control the cursor on the screen by moving one of your finger.

### 2. Right / Left Buttons

Acts as the mouse's right/ left button.

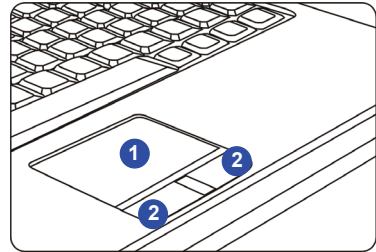

## **Using the Touchpad**

Read the following description to learn how to use the touchpad:

### ■ **Configuring the Touchpad**

You can customize the pointing device to meet your personal needs. For example, if you are a left-handed user, you may want to swap the functions of the two buttons. In addition, you can change the size, shape, moving speed and other advanced features of the cursor on the screen. To configure the touchpad, you can use the standard Microsoft or IBM PS/2 driver in your Windows operating system. The **Mouse Properties** in **Control Panel** allows you to change the configuration.

### ■ **Positioning and Moving**

Place your finger on the touchpad (usually using the forefinger), and the rectangular pad will act as a miniature duplicate of your display. When you move your fingertip across the pad, the cursor on the screen will move simultaneously to the same direction. When your finger reaches the edge of the pad, lift your finger and place it on a proper location of the touchpad to continue the movement.

### ■ **Point and Click**

When you have moved and placed the cursor over an icon, a menu item or a command that you want to execute, simply tap slightly on the touchpad or press the left button to select. This procedure, called as point and click is the basics of operating your notebook. Unlike the traditional pointing device such as the mouse, the whole touchpad can act as a left button, so

that your each tap on the touchpad is equivalent to pressing the left button. Tapping twice more rapidly on the touchpad is to execute a double-click.

### ■ Drag and Drop

You can move files or objects in your notebook by using drag-and-drop. To do so, place the cursor on the desired item and slightly tap twice on the touchpad, and then keep your fingertip in contact with the touchpad on the second tap. Now, you can drag the selected item to the desired location by moving your finger on the touchpad, and then lift your finger from the touchpad to drop the item into place. Alternately, you can press and hold the left button when you select an item, and then move your finger to the desired location; finally, release the left button to finish the drag-and-drop operation.

1. Move the cursor by sliding your fingertip.
2. Put your wrist on the desk comfortably.

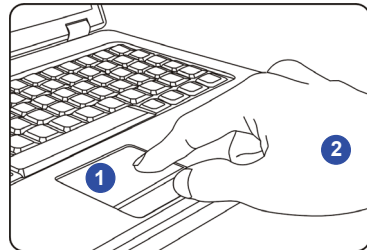

## About Hard Disk Drive

Your notebook is equipped with a 2.5-inch hard disk drive. The hard disk drive is a storage device with much higher speed and larger capacity than other storage devices, such as the floppy disk drive and optical storage device. Therefore, it is usually used to install the operating system and software applications.

To avoid unexpected data loss in your system, please backup your critical files regularly.

Do not turn off the notebook when the hard disk In-use LED is on.

Do not remove or install the hard disk drive when the notebook is turned on. The replacement of hard disk drive should be done by an authorized retailer or service representative.

## Connecting the External Devices

The I/O (input/output) ports on the notebook allow you to connect peripheral devices. All devices listed here are for reference only.

### Using the External Optical Storage Device

An optional external optical storage device may come with the package of the notebook. The actual external optical storage device may vary depending on the model you purchased.

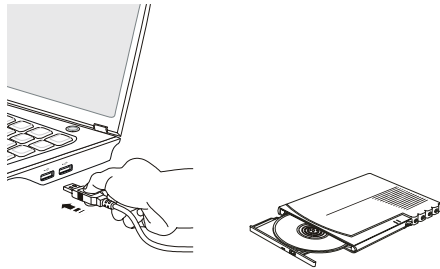

#### INFO

*The devices shown in the reference figures here may be different from the devices users have.*

- **DVD Combo Drive:** This device allows you to read DVD and CD, and record CD format.
- **DVD Dual Drive:** In addition to read DVD and CD, this device allows you to record CD format and both the –R/RW and +R/RW DVD formats.
- **Super Multi:** Works as a multi-functional DVD Dual Drive and a DVD RAM Drive.
- **Blu-ray:** It is a high-capacity optical disc that holds the high-definition video (HD) on a single-sided disk. Blu-ray supports the more advanced H.264 and VC-1 video encoding algorithms (codecs) as well as MPEG-2, which is used for DVD. It also supports the highest HDTV resolution.

## Connecting the Peripheral Devices

### Connecting the USB devices

This notebook provides USB ports for connecting various USB devices, such as mouse, keyboard, digital camera, webcam, printer, and external optical storage device, etc.. To connect these devices, install the drivers for each device first if necessary, and then connect the device to the notebook. This notebook is capable to auto detect the USB devices installed, and if there is no detection of the devices, please manually enable the USB devices by going to **Start Menu / Control Panel / Add Hardware** to add the new device.

---

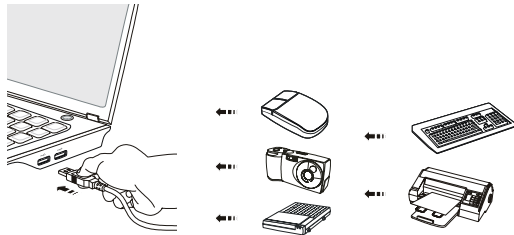



### **Connecting the External Display Devices**

This notebook provides a VGA port for connecting a larger display with higher resolution. The 15-pin-D-sub VGA port allows users to connect an external monitor or other standard VGA-compatible device (such as a projector) for a great view of the notebook display.

---

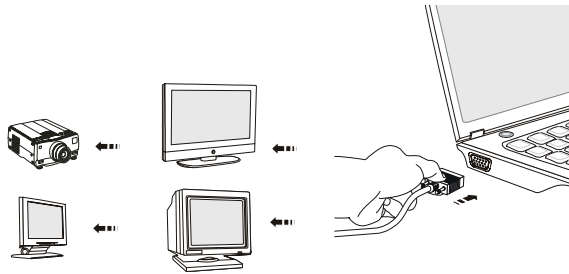

This notebook provides a HDMI port (optional) for connecting a larger display with higher resolution. HDMI (High Definition Multimedia Interface Support) is a new interface standard for PCs, displays and consumer electronics devices that supports standard, enhanced and high-definition video, plus multi-channel digital audio on a single cable.

---

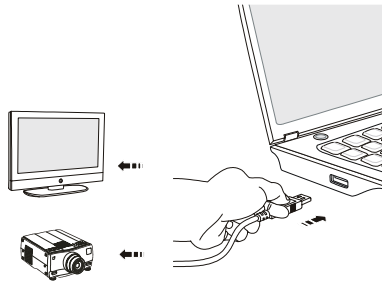

---

Once the display is connected to the notebook, power on the notebook and the external display should respond by default. If not, you can switch the display mode by pressing **[Fn]+[F2]**. Alternately, you can change the display mode by configuring the settings in **Display Properties** of Windows operating system.

## Connecting the Communication Devices

### Using the LAN

The RJ-45 connector of the notebook allows you to connect the LAN (local area network) devices, such as a hub, switch and gateway, to build a network connection.

For more instructions or detailed steps on connecting to the LAN, please ask your MIS staff or network manager for help.

---

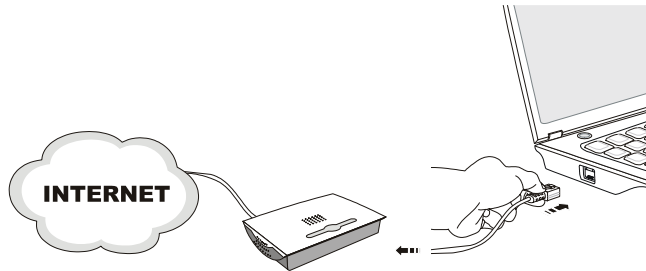

## Safely Remove Hardware

When any peripheral device is connected to the notebook, the Safely Remove Hardware icon will appear on the taskbar. Double-click the icon to bring up the Safely Remove Hardware dialog box. You can see all connected peripheral devices here. If you want to remove any of the devices, move the cursor to the device and click **Stop**. The diagram shown below is for reference only.

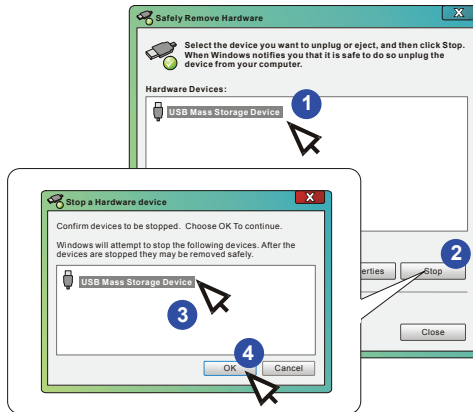

---

# **CHAPTER 4**

## **BIOS Setup**

---

## About BIOS Setup

### When to Use BIOS Setup?

You may need to run the BIOS Setup when:

- An error message appears on the screen during the system booting up and is requested to run SETUP.
- You want to change the default settings for customized features.
- You want to reload the default BIOS settings.

### How to Run BIOS Setup?

To run the BIOS Setup Utility, turn on the notebook and press the [Del] key during the POST procedure.

If the message disappears before you respond and you still wish to enter Setup, either restart the system by turning it OFF and ON, or simultaneously pressing [Ctrl]+[Alt]+[Delete] keys to restart.

Be noted that the screen snaps and setting options in this chapter are for your references only. The actual setting screens and options on your Notebook may be different because of BIOS update.

## Control Keys

You can use only the keyboard to control the cursor in the BIOS Setup Utility.



Press left arrow to select one menu title.



Press right arrow to select one menu title.



Press up arrow to select one item under the menu title.



Press down arrow to select one item under the menu title.



+



Increase the setting value or make changes.



Decrease the setting value or make changes.



- 1) Open the selected item to change setting options.
- 2) Bring up a sub-menu when available.



In some items, press this key to change setting field.



Bring up help screen providing the information of control keys.



- 1) Exit the BIOS Setup Utility.
- 2) Return to the previous screen in a sub-menu.

## BIOS Setup Menu

Once you enter the BIOS Setup Utility, the Main Menu will appear on the screen. Select the tags to enter the other menus.

### Main Menu

Show system overview information about BIOS version, CPU features, memory size and setting of system time and date.

### Advanced Menu

Adjust the advanced settings, such as power consumption, USB/ PCI devices, of the notebook in order to achieve a better performance.

### Security Menu

Install or clear the password settings for supervisor and user.

### Boot Menu

Set up boot type and boot sequence.

### Exit Menu

Save or discard the changes before leaving the BIOS Setup Menu.

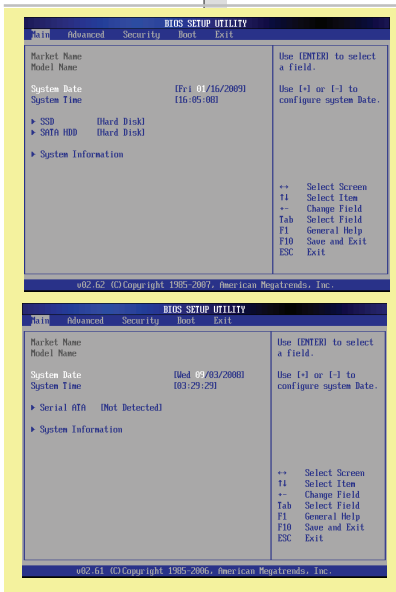



## Main Menu

- **System Date**

This item allows you to set the system date. The date format is [day:month.date:year].

---

### Day

Day of the week, from Sun to Sat, which is determined by BIOS (read-only).

---

### Month (Month)

The month from 01 (January) to 12 (December).

---

### Date (Date)

The date from 01 to 31.

---

### Year (Year)

The year can be adjusted by users.

---

- **System Time**

This item allows you to set the system time. The system clock will go on no matter you shut down the PC or get into sleep mode. The time format is [hour:minute:second].

- **SSD/ SATA HDD (optional)**

This item displays the types of Hard Disk Drives that installed in the notebook. Press **[Enter]** to bring up a window showing the detailed information of the device, including the device name, vendor, etc..

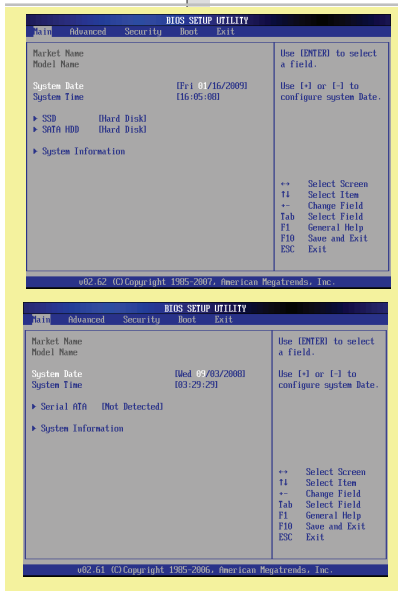

- **Serial ATA (optional)**

The item displays the types of the SATA devices installed in the notebook. Press **[Enter]** to bring up a window showing the detailed information of the device, including the device name, vendor, LBA mode, PIO mode and more.

- **System Information**

This item provides the information about the firmware, processor, and system memory.

## Advanced Menu

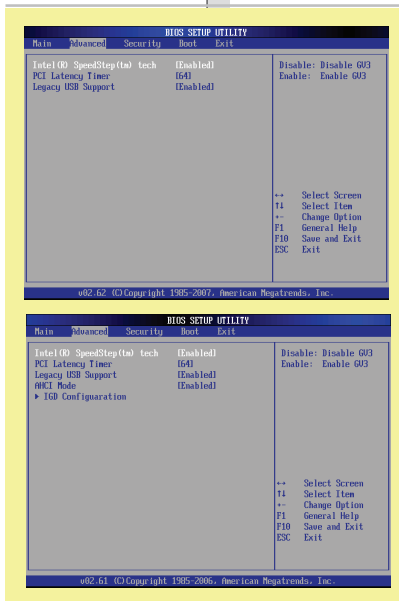

- ◆ **Intel(R) SpeedStep(tm) tech.**

This item allows you to enable or disable Intel SpeedStep technology. When set to **Disabled**, the system always operates in a conserve power mode (the processor works at FSB400-600MHz or FSB533-800MHz). If you want optimize the processor, set this item to **Enabled**, so that the processor's speed will be controlled by the use of your operating system and applications. Setting options: **Enabled**, and **Disabled**.

- ◆ **PCI Latency Timer**

This item controls how long each PCI device can hold the bus before another takes over. When set to higher values, every PCI device can conduct transactions for a longer time and thus improve the effective PCI bandwidth. For better PCI performance, you should set the item to higher values. Setting options: **32, 64, 96, 128, 160, 192, 224, and 248**.

- ◆ **Legacy USB Support**

Selecting **Enabled** allows users to use USB devices, such as mouse, keyboard, or portable disk, in DOS system; or allows users to boot the system by USB device. Setting options: **Auto, Enabled** and **Disabled**.

- **AHCI Mode** (Advanced Host Controller Interface) (**optional**)

Use this item to enable or disable the AHCI Mode. Setting options:

**Disabled** and **Enabled**. The default setting is **Disabled**.

## Security Menu

- ◆ **Change Supervisor Password**

When this item is selected, a message box shall appear on the screen as below:

**Enter New Password**

Type a maximum of eight-digit password and press **[Enter]**. The password typed now will replace any previously set password from CMOS memory. You may also press **[ESC]** to abandon new password setting.

When the Supervisor Password is set, new items **Change User Password** and **Password Check** will be added in the menu.

Select **Change User Password** to give or to abandon password setting same as Change Supervisor Password item above.

Note that **Supervisor Password** field allows users to enter and change the settings of the BIOS SETUP UTILITY, while **User Password** field only allows users to enter the BIOS SETUP UTILITY without having the authorization to make any change.

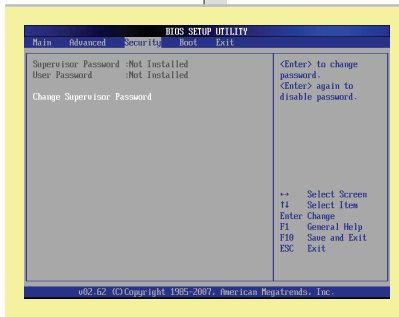

The **Password Check** item is used to specify the type of BIOS password protection that is implemented. Settings are described below:

---

<b>Setup</b>	The password is required only when users try to access to BIOS SETUP UTILITY.
<b>Always</b>	The password is required every time when the Notebook is powered on or when users try to access to BIOS SETUP UTILITY.

---

To clear a set Supervisor Password/ User Password, just press **[Enter]** under **Change Supervisor Password/ Change User Password** field when you are prompted to enter the password. Please note that when Supervisor Password has been cleared, User Password will be cleared as well. A message box will pop up confirming password will be disabled. Once the password is disabled, the system will boot and user can enter setup without entering password.

## Boot Menu

- **Boot Settings Configuration**  
Configure settings during system boot.
- **Boot Device Priority**  
These items showing the sequence of boot devices where BIOS attempts to load the disk operating system.
- **Hard Disk Drives (optional)**  
This item specifies the boot device priority from available hard disk when BIOS attempts to load the operating system.

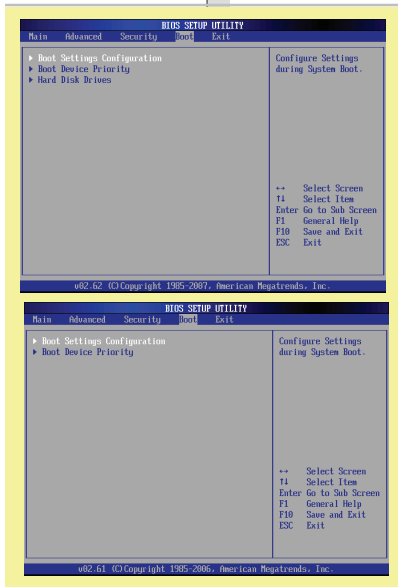

## Exit Menu



- ♦ **Exit & Save Changes**  
Save the changes you have made and exit the utility.
- ♦ **Exit & Discard Changes**  
Exit the utility without saving the changes you have made.
- ♦ **Discard Changes**  
Abandon your changes and reload the previous configuration before running the utility.
- ♦ **Load Setup Defaults**  
Select this item to load the default settings.