

***MP54GBT3 (MS-6855C)***  
***Wireless 11g + Bluetooth***  
***Combo MiniPCI Card***

---

***User's Guide***

## ***FCC Caution***

1. The device complies with Part 15 of the FCC rules. Operation is subject to the following two conditions:
  - (1) This device may not cause harmful interference, and
  - (2) This device must accept any interference received, including interference that may cause undesired operation.
2. FCC RF Radiation Exposure Statement: The equipment complies with FCC RF radiation exposure limits set forth for an uncontrolled environment. This equipment should be installed and operated with a minimum distance of 20 centimeters between the radiator and your body.
3. This Transmitter must not be co-located or operating in conjunction with any other antenna or transmitter.
4. Changes or modifications to this unit not expressly approved by the party responsible for compliance could void the user authority to operate the equipment.

## ***FCC Statement***

This device is intended only for OEM integrators under the following

- 1) The antenna must be installed such that 20 cm is maintained between antenna and users, and
- 2) The transmitter module may not be co-located with any other transmitter or antenna.

As long as 2 conditions above are met, further transmitter test will not required. However, the OEM integrator is still responsible for testing end-product for any additional compliance requirements required with module installed (for example, digital device emissions, PC peripheral requirements, etc.).

## ***Important Note***

In the event that these conditions can not be example certain laptop configurations or co-location with another transmitter), then the FCC authorization is no longer considered valid the FCC ID can not be used on the final product. In these circumstances, OEM integrator will be responsible for re-evaluating the end product (including the transmitter) and obtaining a separate FCC authorization.

## ***End Product Labeling***

This transmitter module is authorized only for use in device where antenna may be installed such that 20 cm may be maintained between antenna and users (for example access points, routers, wireless ADSL and similar equipment). The final end product must be labeled in a area with the following: “Contains TX FCC ID: I4L-MS6855C6”.

## ***Manual Information for End Users***

The end user must not have manual instructions to remove or install device. The user manual for end users must include the following information in a prominent location: “IMPORTANT NOTE: To comply with FCC RF exposure compliance requirements, the antenna used for this transmitter must be installed to provide a separation distance of at least 20 cm from all persons and must not be co-located operating in conjunction with any other antenna or transmitter.” as a result of e-mail transmission.”

## ***Important Safety Precautions***

Always read and follow these basic safety precautions carefully when handling any piece of electronic component.

1. Keep this *User's Guide* for future reference.
2. Keep this equipment away from humidity.
3. Lay this equipment on a reliable flat surface before setting it up.
4. The openings on the enclosure are for air convection hence protects the equipment from overheating.
5. All cautions and warnings on the equipment should be noted.
6. Never pour any liquid into the opening that could damage or cause electrical shock.
7. If any of the following situations arises, get the equipment checked by a service personnel:
  - ❶ Liquid has penetrated into the equipment
  - ❷ The equipment has been exposed to moisture
  - ❸ The equipment has not work well or you can not get it work according to User's Manual
  - ❹ The equipment has dropped and damaged
  - ❺ If the equipment has obvious sign of breakage
8. DO NOT LEAVE THIS EQUIPMENT IN AN ENVIRONMENT UNCONDITIONED, STORAGE TEMPERATURE ABOVE 60°C OR BELOW -20°C, IT MAY DAMAGE THE EQUIPMENT.

# 1

## Introduction

### >>> 1.1 MP54GBT3 (MS-6855C) - Wireless 11g + Bluetooth Combo MiniPCI Card

MSI MP54GBT3, the Wireless 11g + Bluetooth Combo miniPCI Card, is a **Type IIIB** card, which can be used to integrate with such systems as notebook, mini-barebone, PDA, portable PC. With MSI MP54GBT3 embedded inside, a system could provide users with the ability and flexibility to connect up to Internet wirelessly via **802.11g** with speed up to 54Mbps, and to link with peripherals wirelessly through **Bluetooth™ v2.0** and advanced **EDR (Enhanced Data Rate)** technology. **Bluetooth™ v2.0** technology increases the data rate of **Bluetooth™ v1.1/1.2** from 1.0Mbps to 2.1Mbps.

MSI MP54GBT3 is taking advantage of leading technologies from Ralink and CSR. It addresses the co-existence issues in PAN (Personal Area Network) and WLAN (Wireless Local Area Network) markets by providing true simultaneous connectivity while deploying IEEE 802.11g and Bluetooth v2.0. Along with this combo solution, a system installed with a single card is able to offer dual mode capability of WiFi and Bluetooth™. It will benefit system vendors in miniaturization of system dimension and BOM cost reduction, as well as also make users happy with the all-in-one functionality.

**Preface**

**Chapter 1**

**General Introductions**

**Chapter 2**

**Getting Started**

**Chapter 3**

**Customizing this Notebook**

**Chapter 4**

**BIOS setup**



## Regulations Information

### FCC-B Radio Frequency Interference Statement

This equipment has been tested and found to comply with the limits for a Class B digital device, pursuant to part 15 of the FCC rules. These limits are designed to provide reasonable protection against harmful interference in a residential installation. This equipment generates, uses and can radiate radio frequency energy and, if not installed and used in accordance with the instructions, may cause harmful interference to radio communications. However, there is no guarantee that interference will not occur in a particular installation. If this equipment does cause harmful interference to radio or television reception, which can be determined by turning the equipment off and on, the user is encouraged to try to correct the interference by one or more of the following measures:

- w Reorient or relocate the receiving antenna.
- w Increase the separation between the equipment and receiver.
- w Connect the equipment into an outlet on a circuit different from that to which the receiver is connected.
- w Consult the dealer or an experienced radio TV technician for help.

#### NOTE

1. *The changes or modifications not expressly approved by the party responsible for compliance could void the user's authority to operate the equipment.*
2. *Shield interface cables and AC power cord, if any must be used in order to comply with the emission limits.*

## FCC Conditions

This device complies with part 15 of the FCC Rules. Operation is subject to the following two conditions:

1. This device may not cause harmful interference.
2. This device must accept any interference received, including interference that may cause undesired operation.



廢電池請回收

For better environmental protection, waste batteries should be collected separately for recycling or special disposal.

## ***FCC Caution***

1. The device complies with Part 15 of the FCC rules. Operation is subject to the following two conditions:
  - (1) This device may not cause harmful interference, and
  - (2) This device must accept any interference received, including interference that may cause undesired operation.
2. FCC RF Radiation Exposure Statement: The equipment complies with FCC RF radiation exposure limits set forth for an uncontrolled environment. This equipment should be installed and operated with a minimum distance of 20 centimeters between the radiator and your body.
3. This Transmitter must not be co-located or operating in conjunction with any other antenna or transmitter.
4. Changes or modifications to this unit not expressly approved by the party responsible for compliance could void the user authority to operate the equipment.

## ***FCC Statement***

This device is intended only for OEM integrators under the following

- 1) The antenna must be installed such that 20 cm is maintained between antenna and users, and
- 2) The transmitter module may not be co-located with any other transmitter or antenna.

As long as 2 conditions above are met, further transmitter test will not required. However, the OEM integrator is still responsible for testing end-product for any additional compliance requirements required with module installed (for example, digital device emissions, PC peripheral requirements, etc.).

## ***Important Note***

In the event that these conditions can not be example certain laptop configurations or co-location with another transmitter), then the FCC authorization is no longer considered valid the FCC ID can not be used on the final product. In these circumstances, OEM integrator will be responsible for re-evaluating the end product (including the transmitter) and obtaining a separate FCC authorization.



## Safety Guideline for Using Lithium Battery

(Danish) ADVARSEL! Lithumbatteri --- Eksplosionsfare ved fejlagtig håndtering. Udskiftning må kun ske med batteri af same fabrikat og type. Levé det brugte batteri tilbage til leverandøren.

(Deutsch) VORSICHT: Explosionsgefahr bei unsachgemäßem Austausch der Batterie. Ersatz nur durch denselben oder einen vom Hersteller empfohlenen gleich-wertigen Typ. Entsorgung gebrauchter Batterien nach Angaben des Herstellers.

(English) CAUTION: Danger of explosion if battery is incorrectly replaced. Replace only with the same or equivalent type recommended by the equipment manufacturer. Discard used batteries according to manufacturer's instructions.

(中文) 警告 :錯誤地使用電池可能有爆炸的危險。僅可使用製造商指定的電池。請依據製造商指示處理廢棄電池。

(Finnish) VAROITUS: Paristo voi räjähtää, jos se on virheellisesti asennettu. Vaihda paristo ainoastaan valmistajan suosittelemaan tyyppiin. Hävitä käytetty paristo valmistajan ohjeiden mukaisesti.

(French) ATTENTION: Il y a danger d'explosion s'il y a remplacement incorrect de la batterie. Remplacer uniquement avec une batterie du même type ou d'un type équivalent recommandé par le constructeur. Jeter les batteries usagées conformément aux instructions du fabricant.

(Norwegian) ADVARSEL: Eksplosjonsfare ved feilaktig skifte av batteri. Benytt same batteritype eller en tilsvarende type anbefalt av apparatfabrikanten. Brukte batterier kasseres i henhold til fabrikantens

instruksjoner.

(Swedish) VARNING: Explosionsfara vid felaktigt batteribyte. Använd samma batterityp eller en ekvivalent typ som rekommenderas av apparatillverkaren. Kassera använt batteri enligt fabrikantens instruction.

## Caution on Using Modem

1. Never install telephone wiring during a lightning storm.
2. Never install telephone jacks in wet locations unless the jack is specifically designed for wet locations.
3. Never touch uninsulated telephone wires or terminals unless the telephone line has been disconnected at the network interface.
4. Use caution when installing or modifying telephone lines.
5. Avoid using the telephone function (other than a cordless type) during an electrical storm. There may be a remote risk of electric shock from lightning.
6. Do not use the telephone function to report a gas leak in the vicinity of the leak.

## Optical Disc Drive Notice

CAUTION: This appliance contains a laser system and is classified as a "CLASS 1 LASER PRODUCT." To use this model properly, read the instruction manual carefully and keep this manual for your future reference.

In case of any trouble with this model, please contact your nearest

“AUTHORIZED service station.” To prevent direct exposure to the laser beam, do not try to open the enclosure.

## Macrovision Notice

This product incorporates copyright protection technology that is protected by U.S. patents and other intellectual property rights. Use of this copyright protection technology must be authorized by Macrovision, and is intended for home and other limited viewing uses only unless otherwise authorized by Macrovision. Reverse engineering or disassembly is prohibited.

## Safety Instructions

1. Read the safety instructions carefully and thoroughly.
2. Save this User Guide for possible use later.
3. Keep this equipment away from humidity and high temperature.
4. Lay this equipment on a stable surface before setting it up.
5. The openings on the enclosure are used for air convection and to prevent the equipment from overheating. Do not cover the openings.
6. Make sure that the power voltage is within its safety range and has been adjusted properly to the value of 100~240V before connecting the equipment to the power inlet.
7. Place the power cord in a way that people are unlikely to step on it. Do not place anything on the power cord.
8. Always unplug the power cord before inserting any add-on card or module.
9. All cautions and warnings on the equipment should be noted.

10. If any of the following situations arises, get the equipment checked by a service personnel:
  - w The power cord or plug is damaged.
  - w Liquid has penetrated into the equipment.
  - w The equipment has been exposed to moisture.
  - w The equipment has not worked well or you can not get it work according to User's Manual.
  - w The equipment was dropped and damaged.
  - w The equipment has obvious signs of breakage.
11. Never pour any liquid into the opening that could damage the equipment or cause an electrical shock.
12. Do not leave the equipment in an unconditioned environment with a storage temperature of 60°C (140°F) or above, which may damage the equipment.
13. To prevent explosion caused by improper battery replacement, use the same or equivalent type of battery recommended by the manufacturer only.



## WEEE Statement

(English) Under the European Union ("EU") Directive on Waste Electrical and Electronic Equipment, Directive 2002/96/EC, which takes effect on August 13, 2005, products of "electrical and electronic equipment" cannot be discarded as municipal waste anymore and manufacturers of covered electronic equipment will be obligated to take back such products at the end of their useful life.

(Deutsch) Gemäß der Richtlinie 2002/96/EG über Elektro- und Elektronik-Altgeräte dürfen Elektro- und Elektronik-Altgeräte nicht mehr als kommunale Abfälle entsorgt werden, die sich auf 13. August, 2005 wirken. Und der Hersteller von bedeckt Elektronik-Altgeräte gesetzlich zur gebrachten Produkte am Ende seines Baruchbarkeitsdauer zurückzunehmen.

(Français) Selon la directive européenne (EU) relative aux déchets des équipements électriques et électroniques, directive 2002/96/EC, prenant effet le 13 août 2005, les produits électriques et électroniques ne peuvent être déposés dans les décharges ou tout simplement mis à la poubelle. Les fabricants de ces équipements seront obligés de récupérer certains produits en fin de vie.

(Русский) В соответствии с директивой Европейского Союза (ЕС) по предотвращению загрязнения окружающей среды использованным электрическим и электронным оборудованием (директива WEEE 2002/96/EC), вступающей в силу 13 августа 2005 года, изделия, относящиеся к электрическому и электронному оборудованию, не могут

рассматриваться как бытовой мусор, поэтому производители вышеперечисленного электронного оборудования обязаны принимать его для переработки по окончании срока службы.

(Español) Bajo la directiva 2002/96/EC de la Unión Europea en materia de desechos y/o equipos electrónicos, con fecha de rigor desde el 13 de agosto de 2005, los productos clasificados como "eléctricos y equipos electrónicos" no pueden ser depositados en los contenedores habituales de su municipio, los fabricantes de equipos electrónicos, están obligados a hacerse cargo de dichos productos al termino de su período de vida.

(Nederlands) De richtlijn van de Europese Unie (EU) met betrekking tot Vervuiling van Elektrische en Electronische producten (2002/96/EC), die op 13 Augustus 2005 in zal gaan kunnen niet meer beschouwd worden als vervuiling. Fabrikanten van dit soort producten worden verplicht om producten retour te nemen aan het eind van hun levenscyclus..

(Srpski) Po Direktivi Evropske unije ("EU") o odbačenoj eelektronskoj i električnoj opremi, Direktiva 2002/96/EC, koja stupa na snagu od 13. Avgusta 2005, proizvodi koji spadaju pod "elektronsku i električnu opremu" ne mogu više biti odbačeni kao običan otpad i proizvođači ove opreme biće prinuđeni da uzmu natrag ove proizvode na kraju njihovog uobičajenog veka trajanja.

(Polski) Zgodnie z Dyrektywą Unii Europejskiej ("UE") dotyczącą odpadów produktów elektrycznych i elektronicznych (Dyrektywa 2002/96/EC), która wchodzi w życie 13 sierpnia 2005, tzw. "produkty oraz wyposażenie elektryczne i elektroniczne" nie mogą być traktowane jako śmieci komunalne, tak więc producenci tych produktów będą zobowiązani do odbierania ich w

momencie gdy produkt jest wycofywany z użycia.

(TÜRKÇE) Avrupa Birliği (AB) Kararnamesi Elektrik ve Elektronik Malzeme Atığı, 2002/96/EC Kararnamesi altında 13 Ağustos 2005 tarihinden itibaren geçerli olmak üzere, elektrikli ve elektronik malzemeler diğer atıklar gibi çöpe atılamayacak ve bu elektronik cihazların üreticileri, cihazların kullanım süreleri bittikten sonra ürünleri geri toplamakla yükümlü olacaktır.

(ČESKY) Podle směrnice Evropské unie ("EU") o likvidaci elektrických a elektronických výrobků 2002/96/EC platné od 13. srpna 2005 je zakázáno likvidovat "elektrické a elektronické výrobky" v běžném komunálním odpadu a výrobci elektronických výrobků, na které se tato směrnice vztahuje, budou povinni odebrat takové výrobky zpět po skončení jejich životnosti.

(MAGYAR) Az Európai Unió („EU”) 2005. augusztus 13-án hatályba lépő, az elektromos és elektronikus berendezések hulladékairól szóló 2002/96/EK irányelve szerint az elektromos és elektronikus berendezések többé nem kezelhetők lakossági hulladékként, és az ilyen elektronikus berendezések gyártói kötelessé válnak az ilyen termékek visszavételére azok hasznos élettartama végén.

(Italiano) In base alla Direttiva dell'Unione Europea (EU) sullo Smaltimento dei Materiali Elettrici ed Elettronici, Direttiva 2002/96/EC in vigore dal 13 Agosto 2005, prodotti appartenenti alla categoria dei Materiali Elettrici ed Elettronici non possono più essere eliminati come rifiuti municipali: i produttori di detti materiali saranno obbligati a ritirare ogni prodotto alla fine del suo ciclo di vita..

## Trademarks

All trademarks are the properties of their respective owners.

- w Microsoft is a registered trademark of Microsoft Corporation. Windows®98/ME, 2000/XP are registered trademarks of Microsoft Corporation.
- w AMI® is a registered trademark of American Megatrends Inc.
- w PCMCIA and CardBus are registered trademarks of the Personal Notebook Memory Card International Association.

## Release History

Version	Revision Note	Date
1.0	First Release	September 2006



# Table of Content

## Preface

---

<b>Regulations Information .....</b>	<b>II</b>
FCC-B Radio Frequency Interference Statement .....	II
FCC Conditions .....	III
<b>Safety Guideline for Using Lithium Battery .....</b>	<b>IV</b>
<b>Caution on Using Modem .....</b>	<b>V</b>
<b>Optical Disc Drive Notice.....</b>	<b>V</b>
<b>Macrovision Notice .....</b>	<b>VI</b>
<b>Safety Instructions .....</b>	<b>VI</b>
<b>WEEE Statement .....</b>	<b>VIII</b>
<b>Trademarks .....</b>	<b>XI</b>
<b>Release History.....</b>	<b>XI</b>

## Introductions

---

<b>How to Use This Manual .....</b>	<b>1-2</b>
<b>Unpacking .....</b>	<b>1-4</b>

## Getting Started

---

<b>Specification</b> .....	<b>2-2</b>
<b>Product View</b> .....	<b>2-6</b>
Top-open View .....	2-6
Front View .....	2-10
Right-side View .....	2-11
Left-side View .....	2-13
Rear View .....	2-14
Bottom View .....	2-15
<b>Power Management</b> .....	<b>2-17</b>
AC Adapter .....	2-17
Battery Pack .....	2-19
Using the Battery Pack .....	2-22
<b>Basic Operations</b> .....	<b>2-24</b>
Safety and Comfort Tips .....	2-24
Have a Good Work Habit .....	2-25
Knowing the Keyboard .....	2-26
Knowing the Touchpad .....	2-32
About Fingerprint Identification (Optional, for 87-Key Series Only) .....	2-36
About Hard Disk Drive .....	2-46
Using the Optical Storage .....	2-47

## Customizing this Notebook

---

<b>Connecting the External Devices .....</b>	<b>3-2</b>
Connecting the Peripheral Devices .....	3-3
Connecting the Communication Devices.....	3-6
<b>PC Card Installation.....</b>	<b>3-7</b>
Installing the PC card .....	3-7
Removing the PC card .....	3-8
<b>Express Card Installation .....</b>	<b>3-9</b>
Installing the Express card .....	3-9
Removing the Express card .....	3-9
<b>Safely Remove Hardware.....</b>	<b>3-10</b>

## BIOS Setup

---

<b>About BIOS Setup.....</b>	<b>4-2</b>
When to Use BIOS Setup .....	4-2
How to Run BIOS Setup.....	4-2
Control Keys .....	4-3
<b>BIOS Setup Menu.....</b>	<b>4-4</b>
Main menu .....	4-5
Advanced menu.....	4-7
Boot menu.....	4-8
Security menu.....	4-9
Exit menu .....	4-11



	Preface
<b>Chapter 1</b>	<b>General Introductions</b>
<b>Chapter 2</b>	<b>Getting Started</b>
<b>Chapter 3</b>	<b>Customizing this Notebook</b>
<b>Chapter 4</b>	<b>BIOS setup</b>



**C**ongratulations on becoming a new user of this notebook, the finely designed notebook. This brand-new exquisite notebook will give you a delightful and professional experience in using notebook. We are proud to tell our users that this notebook is thoroughly tested and certified by our reputation for unsurpassed dependability and customer satisfaction.

## How to Use This Manual

This User's Manual provides instructions and illustrations on how to operate this notebook. It is recommended to read this manual carefully before using this notebook.

**Chapter 1, General Introductions**, includes the descriptions of all the accessories of this notebook. It is recommended to check out that if you have all the accessories included when you open the packing box. If any item is damaged or missing, please contact the vendor where you purchased this notebook.

**Chapter 2, Getting Started**, provides the specification of this notebook, and introduces the function buttons, quick launch buttons, connectors, LEDs and externals of this notebook. Also, this chapter instructs the correct procedure of installing or uninstalling the battery pack, and the brief ideas on how to use this notebook.

**Chapter 3, Customizing this Notebook**, gives instructions not only in connecting the mouse, keyboard, webcam, printer, external monitor, IEEE 1394 devices, and communication devices, but also in installing and removing the PC card.

**Chapter 4, BIOS setup**, provides information on BIOS Setup program and allows you to configure the system for optimum use.

## Unpacking

First, unpack the shipping carton and check all items carefully. If any item contained is damaged or missing, please contact your local dealer immediately. Also, keep the box and packing materials in case you need to ship the unit in the future.

The package should contain the following items:

- w Notebook
- w User's Manual or Quick Start Guide
- w All-in-one application disk, containing the drivers, utilities and optional recovery function.
- w High-capacity Li-ion battery pack
- w AC adapter and power cord
- w Phone cable/Phone jack (optional)
- w Notebook carry bag (optional)

**These accessories listed above may change without notice.**



	<b>Preface</b>
<b>Chapter 1</b>	<b>General Introductions</b>
<b>Chapter 2</b>	<b>Getting Started</b>
<b>Chapter 3</b>	<b>Customizing this Notebook</b>
<b>Chapter 4</b>	<b>BIOS setup</b>



## Specification

Physical Characteristic	
Dimension	358mm(L) x 259mm(D) x 27~33mm(H)
Weight	2.7kg with 6 cell battery 2.9kg with 9 cell battery
CPU	
Processor Type	638-pin (uPGA)
Support Processor	Turion 64 bit Taylor processor 2.2 GHz, dual core 35W
L1 Cache	64K
L2 Cache	1MB / 512KB
FSB Speed	800MHz
Socket	Socket S1 (638-pin)
Core Chips	
North Bridge	nVidia C51MV
South Bridge	nVidia MCP51M
Memory	
Technology	DDRII 533/667 MHz
Memory	DDRII SO-DIMM X 2 slots 256/512/1024MB DDRII SDRAM
Maximum	2GB (1024MB DDRII SO-DIMM X 2)
Power	
AC Adapter	90W, 19 Volt

Battery Type	6 cells (Li-ion)/9 cells (Li-ion)
<b>Storage</b>	
HDD form factor	2.5", 9.5mm High
Optical Device	DVD Combo/ DVD dual/Super Multi/DVD Dual Layer/Light Scribe
<b>I/O Port</b>	
Monitor	DVI x 1
USB	x 4 (USB version 2.0)
Mic-in	x 1
Lin-in	x 1
Headphone/SPDIF Out	x 1
RJ11	x 1
RJ45	x 1
IEEE1394	x 1
Internal Microphone	x 1
5-in-1 Card Reader	x 1 (SD, MMC, MS/MS-Pro, XD, SM )
Express Card Slot	x 1
TV-Out	x 1 (S-Video)
<b>Camera</b>	
CMOS	1.3 M Pixel
<b>Communication Port</b>	
56K Fax/MODEM	MDC (Azalia)
MDC (AZALIA)	I/F --- AZALIA S/W Modem Wake on Ring --- Support on S3/S4/S5

	<p>State</p> <p>PTT Approval --- Yes (FCC/CTR21/JATE)</p>
LAN	<p>10/100/1000 Base on board LAN</p> <p>Wake on LAN --- Support on S3/S4/S5</p> <p>State</p> <p>LAN Boot --- Yes</p> <p>Wfm --- Wfm 2.0 support</p>
Wireless LAN	IEEE 802.11b/g
Bluetooth	Support (Optional)
<b>Display</b>	
LCD Type	Glare 15.4" WXGA
Brightness	Brightness controlled by K/B hot-keys
<b>Video</b>	
Controller	G73M
VRAM	DDRIII/256MB
LCD	1280 x 800 WXGA
CRT	<p>640x480, max, 32bit color</p> <p>800x600, max, 32bit color</p> <p>1024x768, max, 32bit color</p> <p>1152 x 768, max 32bit color</p> <p>1280 x 1024, max. 32bit color</p> <p>1400x1050, max, 32bit color</p> <p>1600 x 1200, max.32bit color</p> <p>1800 x 1440, max. 32bit color</p>

Display Detect	<p>System auto detects LCD or CRT:</p> <ol style="list-style-type: none"> <li>1. Display to CRT - only if LCD lid is closed;</li> <li>2. Display to LCD - only if no CRT detected;</li> <li>3. Display can scan CRT &amp; LCD simultaneously if both are detected and activate.</li> </ol>
<b>Audio</b>	
Sound Codec chip	Realtek ALC883 (Azalia)
Internal Speaker	2 Speakers
Internal Microphone	Yes
SoundBlaster	<p>SoundBlaster compatible</p> <p>(Not support DOS)</p>
H/W Wave Table MIDI	S/W wave table
Sound Volume	Adjust by volume button, K/B hot-key & SW
<b>Software &amp; BIOS</b>	
USB Flash Boot	Yes, USB floppy and USB flash driver boot up DOS only
BIOS	Fast Boot Support --- Yes
<b>Others</b>	
Kensington Lock Hole	Support
Fingerprint	Optional (for 87-key series only)
WHQL	PC2001

## Product Overview

This section provides you the description of basic aspects of your Notebook. It will help you to know more about the appearance of this Notebook before using it.

### Top-open View

Press the Cover Latch to open the top cover (LCD Panel). The figure of top-open view and description showing below will lead you to browse the main operating area of your NOTEBOOK.

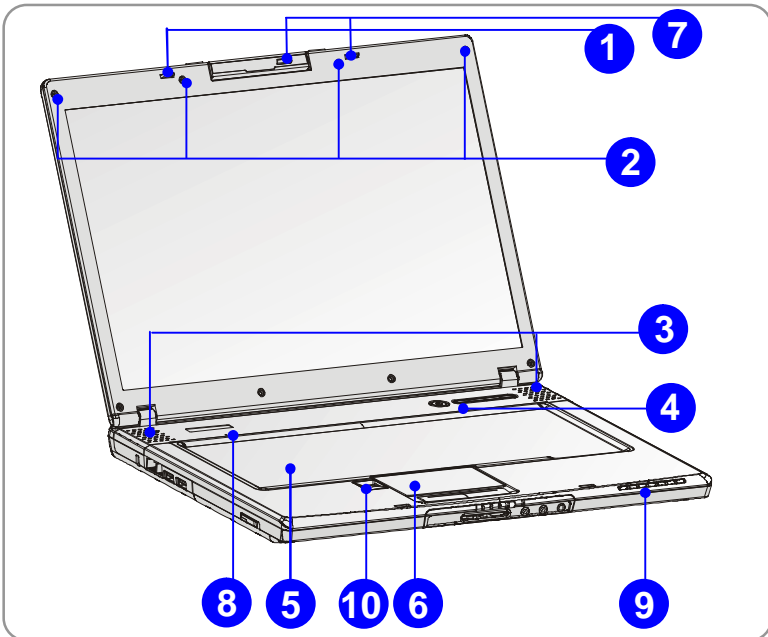

#### 1. Cover Latch (Internal View)

It is a bounce-back device to lock the cover with the deck when closing your Notebook PC.





#### 2. Rubber Pads

Protect your Notebook PC from random closing.

#### 3. Stereo Speakers

Make high quality sound blaster with stereo system and Hi-Fi function supported.

#### 4. Quick Launch Buttons and Power Button

	<p><b>Power Button:</b> To turn your Notebook power ON and OFF.</p>
<p><b>Quick Launch Buttons:</b> Simply click the quick launch buttons to speed up the starting of the programs in common use. It helps you to do works more efficiently.</p>	
 <b>E-mail</b>	<p>Press the E-mail Quick Launch Button to launch the E-mail application.</p>
 <b>Internet</b>	<p>Press the Internet Quick Launch Button to activate the Internet browser.</p>
<p><b>P1</b>  <b>Search or Dual Core Cell</b></p>	<p>Press the P1 Quick Launch Button to activate the Windows Search function or the Dual Core Cell program, depending on the default setting.</p>
 <b>WLAN &amp; BT(optional)</b>	<p>Press the WLAN &amp; BT(optional) Quick Launch Button to enable/disable the Wireless LAN or</p>

	Bluetooth (optional) function.
--	--------------------------------

#### 5. Keyboard

The built-in keyboard provides all the functions of a full-sized keyboard.

#### 6. Touchpad

It is the pointing device of the computer.





#### 7. Webcam Power Button

Press this power to enable Webcam function firstly. This camera takes pictures every few minutes and updates those pictures to a Web page where everyone can watch.



#### 8. Internal Microphone

There is built-in microphone and its function is the same with microphone.

#### 9. Status LED

	<b>Num Lock:</b> Glowing Blue when the Num Lock function is activated.
	<b>Caps Lock:</b> Glowing Blue when the Caps Lock function is activated.
	<b>Scroll Lock:</b> Glowing Blue when the Scroll Lock function is activated.
	<b>Hard Disk In-use:</b> Glowing Blue when the Notebook PC is accessing the hard disk drive.
	<b>Battery:</b> Glowing Orange when recharging. Battery LED goes out when recharging is done or when the AC adapter is disconnected.



	<p>Glowing Blue when the battery is in low battery status.</p> <p>Blinking Blue if the battery is out of order, and it is recommended to replace a new battery.</p>
	<p><b>Power On / Standby:</b> It is Blue when the power is on; it is blinking blue when it is in standby mode.</p>
	<p><b>1. Wireless LAN/ 2. Bluetooth (optional):</b></p> <p>1. Glowing Green when wireless LAN function of the computer is enabled. LED goes out when wireless LAN function is disabled.</p> <p>2. Glowing Blue when Bluetooth function of the computer is enabled. LED goes out when Bluetooth function is disabled.</p>

#### 10. Finger Print Identification (optional, for 87-key series only)

This area is for finger print identification.

## Front View

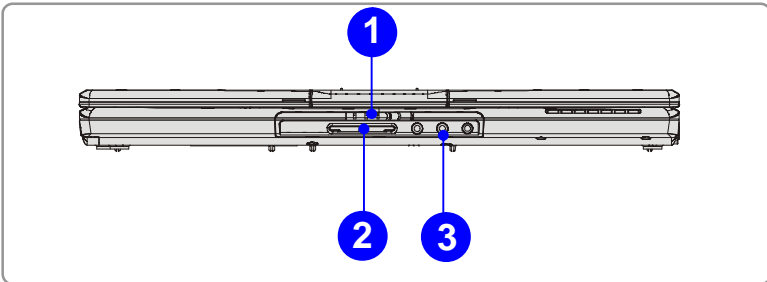

### 1. Cover Latch (External View)

Press Cover Latch rightward and lift the cover. The Cover Latch will bounce back when loosing it.

### 2. 5 in 1 Card Reader

The built-in card reader supports MMC (multi-media card), SD (secure digital), MS (memory stick)/MS Pro, SM and XD cards.

### 3. Audio Port Connectors

Make high quality sound blaster with stereo system and Hi-Fi function supported.

		<b>Microphone:</b> Used for an external microphone.
		<b>Line In:</b> Used for an external audio device.
		<b>Line Out:</b> A connector for speakers or headphones.

## Right-side View

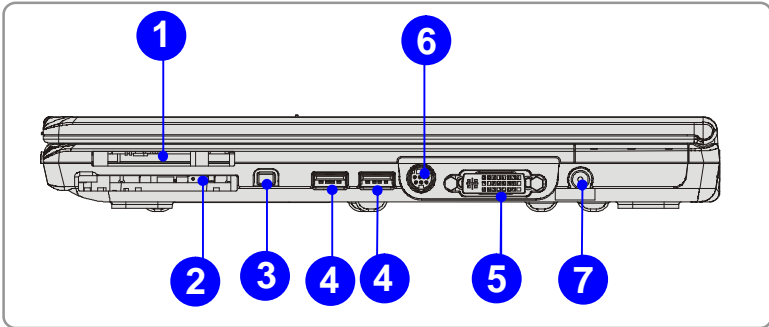

### 1. Express Card Slot

The computer provides an Express Card slot. The new Express Card interface is smaller and faster than PC Card interface. The Express Card technology takes advantage of the scalable, high-bandwidth serial PCI Express and USB 2.0 interfaces.

### 2. PC Card Slot

The computer provides a PC card slot to support one Type-II PC card for expansion functions, such as LAN/WLAN card, modem card, memory card, etc.

### 3. IEEE 1394

The IEEE 1394 port is a high-speed bus that allows you to connect high-end digital devices such as the DV (digital video camera).

### 4. USB Port

The USB 2.0 port allows you to connect USB-interface peripheral devices, such as the mouse, keyboard, modem, portable hard disk module, printer and more.



**5. DVI-I Port**

DVI stands for Digital Visual Interface, and is a standard for connecting computers to digital monitors. The DVI-I port provides a pure digital video signal to a digital flat-panel display or projector for a great view of the computer display.

**6. S-Video Connector**

By using a Super VHS (S-Video) cable, this connector allows you to connect a television (NTSC/PAL system) to use as a computer display.

**7. Power Connector**

To connect the AC adapter and supply power for the computer.

## Left-side View

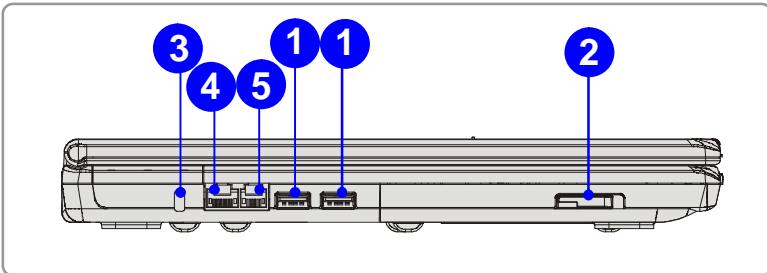

### 1. USB Port

The USB 2.0 port allows you to connect USB-interface peripheral devices, such as the mouse, keyboard, modem, portable hard disk module, printer and more.

### 2. Optical Storage Device

A slim DVD Combo/ DVD dual/Super Multi/DVD Dual Layer/Light Scribe drive is available in the computer, depending on the model you purchased. The optical device allows you to use the CD/DVD disc for installing software, accessing data and playing music/movie on the computer.

### 3. Kensington Lock

This port is used to lock the computer to location for security.

### 4. RJ-45 Connector

The Ethernet connector is used to connect a LAN cable for network connection.

### 5. RJ-11 Connector

The computer provides a built-in modem that allows you to connect an RJ-11 telephone line through this connector. With the 56K V.90 modem, you can make a dial-up connection.

## Rear View

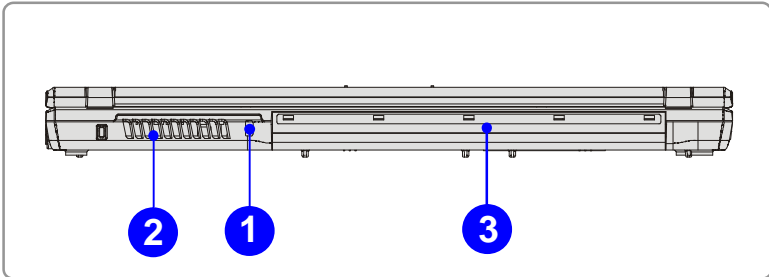

### 1. Kensington Lock

This port is used to lock the computer to location for security.

### 2. Ventilator

The ventilator is designed to cool the system. DO NOT block the ventilator for air circulation.

### 3. Battery Pack (Rear View)

To supply power to computer when AC adapter is not connected.

## Bottom View

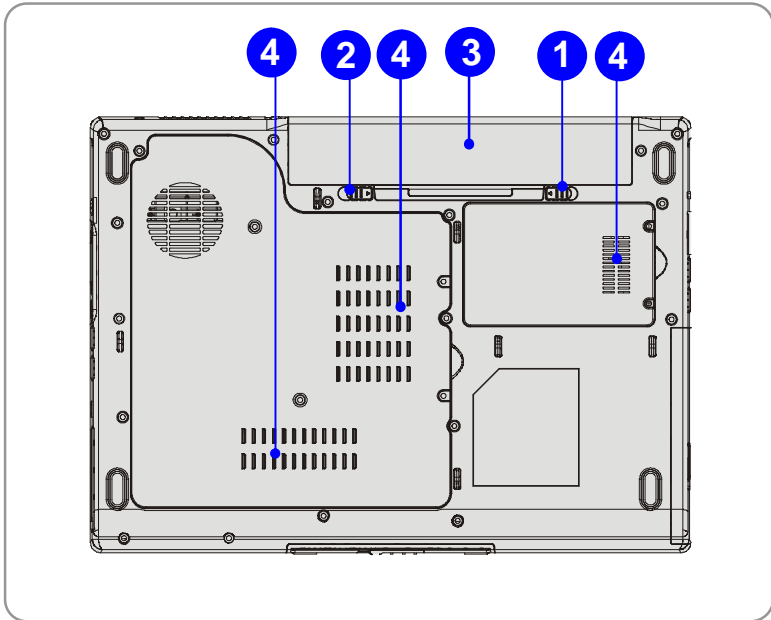

### 1. Battery Release Button

It is a bounce-back device as a preparation for releasing the battery pack.

Press it with one hand and pull the battery pack carefully with the other.

### 2. Battery Lock/Unlock Button

Battery cannot be moved when the button is positioned on lock status.

Once the button is pushed to unlock position, the battery is removable.

### 3. Battery Pack

Supply power to your computer when the AC adapter is not connected.

**4. Ventilator**

The ventilator is designed to cool the system. DO NOT block the ventilator for air circulation.



## Power Management

### AC Adapter

Please be noted that it is strongly recommended to connect the AC adapter and use the AC power while using this Notebook for the first time. When the AC adapter is connected, the battery is being charged immediately.

*NOTE that the AC adapter included in the package is approved for your Notebook; using other adapter model may damage the Notebook or other devices on the Notebook.*

#### Connecting the AC Power

1. Unpack the package to find the AC adapter and power cord.
2. Attach the power cord to the connector of the AC adapter.
3. Plug the DC end of the adapter to the Notebook, and the male end of the power cord to the electrical outlet.

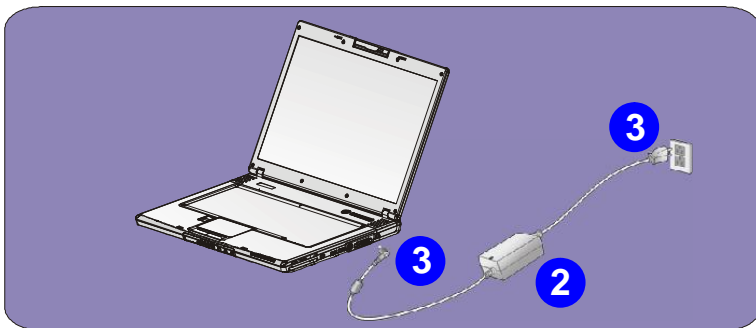

## **Disconnecting the AC Power**

When you disconnect the AC adapter, you should:

1. Unplug the power cord from the electrical outlet first.
2. Unplug the connector from the Notebook.
3. Disconnect the power cord and the connector of AC adapter.
4. When unplugging the power cord, always hold the connector part of the cord. Never pull the cord directly!

## Battery Pack

This Notebook is equipped with a high-capacity 6-cell/9-cell Li-ion Battery pack. The rechargeable Li-ion battery pack is an internal power source of the Notebook.

### **Releasing the Battery Pack**

It's a better way to have extra battery for enough power supply, so you don't have to worry about the lack of battery power. It's recommend to buy a battery pack from your local dealer.

To remove the battery pack:

1. Make sure the computer is turned off.
2. Check the Lock/Unlock button is in unlocked status.
3. Locate the Battery Release Button on the bottom side.
4. Push the Release Button to the direction of arrow showing above the button.
5. Slide the left side of the battery pack first out of the compartment and then pull the right side of the battery pack.

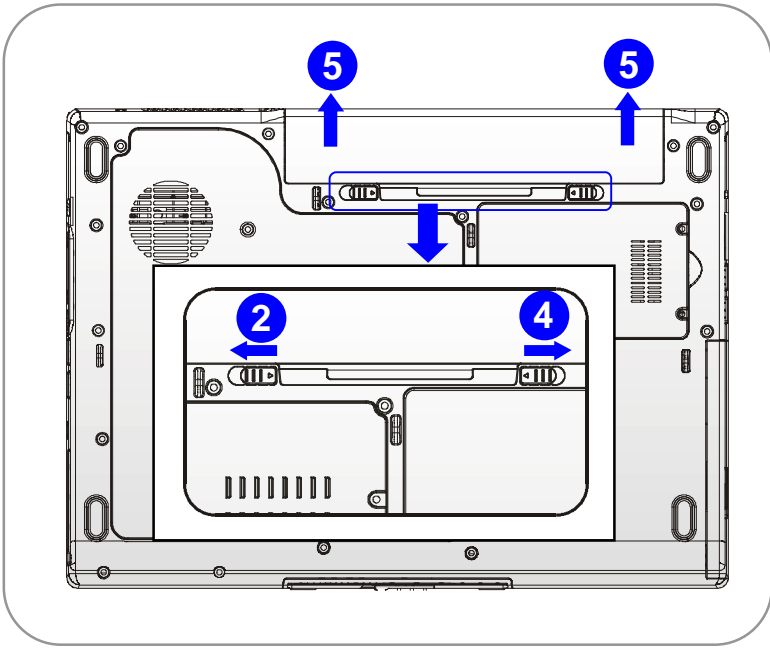

## Replacing the Battery Pack

1. Insert the right side of battery pack into the compartment.
2. Slightly slide and press the battery pack into the right place.
3. After the right side of the battery pack fitting the right track, then slightly press the left side of battery pack into the battery chamber.
4. Make sure the Lock/Unlock Button is in lock position.

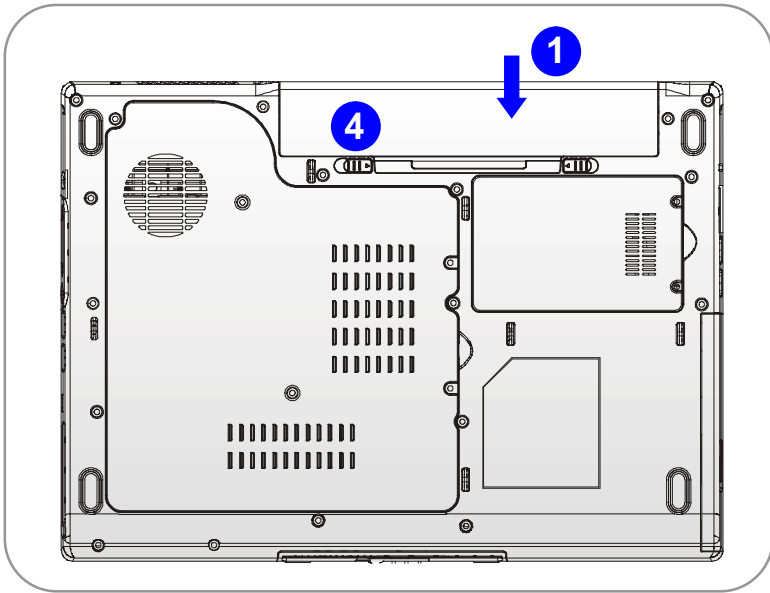

## info

### Warning

1. Do not try to disassemble THE BATTERY PACK.
2. Please follow your local laws and regulations to recycle the unused battery pack.

## Using the Battery Pack

### **Battery Safety Tips**

Replacing or handling the battery incorrectly may present a risk of fire or explosion, which could cause serious injury.

- w Only replace the main battery pack with the same or equivalent type of battery.
- w Do not disassemble, short-circuit or incinerate batteries or store them to temperatures above +60° C (+140° F).
- w Do not temper with batteries. Keep them away from children.
- w Do not use rusty or damaged batteries.
- w Dispose of batteries according to local regulations. Check with your local solid waste officials for details about recycling options or for proper disposal in your area.

### **Conserving Battery Power**

Efficient battery power is critical to maintain a normal operation. If the battery power is not managed well, the saved data and customized settings may be lost.

Follow these tips to help optimizing battery life and avoid a sudden power loss.

- w Suspend system operation if the system will be idle for a while or shorten the Suspend Timer's time period.
- w Turn off the system if you won't be using it for a period of time.
- w Disable unneeded settings or remove idle peripherals to conserve power.
- w Connect an AC adapter to the system whenever possible.

## **Charging the Battery Pack**

The battery pack can be recharged while it is installed in the Notebook. Please pay attention to the following tips before recharging the battery:

- w If a charged battery pack is not available, save your work and close all running programs and shut down the system or Save-to-Disk.
- w Plug in an external AC/DC power source.
- w You can use the system, suspend system operation or shut down and turn off the system without interrupting the charging process.
- w The battery pack uses Lithium-ion battery cells that have no “memory effect.” You do not need to discharge the battery pack before you begin charging. However, to optimize the life of battery, we suggest that consuming the battery power completely once a month is necessary.
- w If you do not use the Notebook for a long time, it is suggested to remove the battery pack from your Notebook. This may be helpful to extend your battery life.
- w The actual charging time will be determined by the applications in use.

## Basic Operations

If you are a beginner to the Notebook, please read the following tips to make yourself safe and comfortable during the operations.

### Safety and Comfort Tips

The Notebook is a portable platform that allows you to work anywhere. However, choosing a good workspace is important if you have to work with your Notebook for long periods of time.

- w Your work area should have enough illumination.
- w Choose the proper desk and chair and adjust their height to fit your posture when operating.
- w When sitting on the chair and adjust the chair's back (if available) to support your back comfortably.
- w Place your feet flat and naturally on the floor, so that your knees and elbows have the proper position (about 90-degree) when operating.
- w Put your hands on the desk naturally to support your wrists.
- w Adjust the angle/position of the LCD panel, so that you can have the optimal view.
- w Avoid using your Notebook in the space where may cause your discomfort (such as on the bed).
- w The Notebook is an electrical device, please treat it with great care to avoid personal injury.



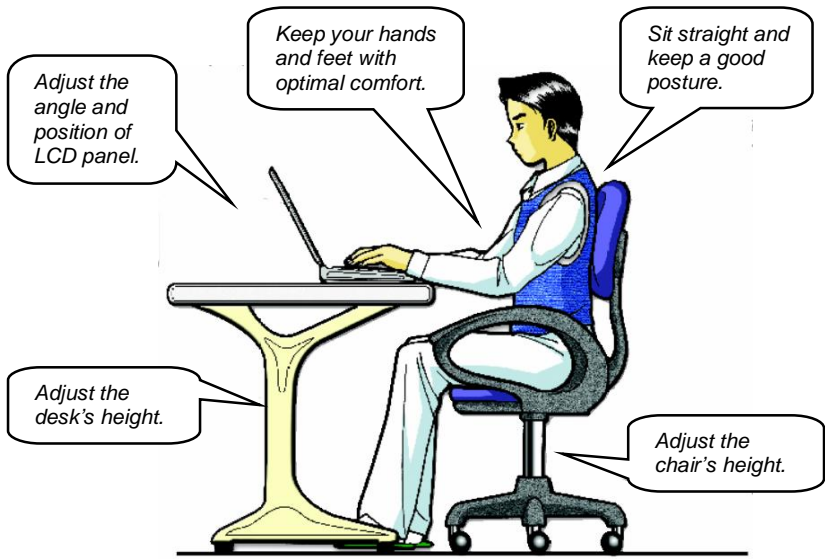

## Have a Good Work Habit

Have a good work habit is important if you have to work with your Notebook for long periods of time; otherwise, it may cause discomfort or injury to you. Please keep the following tips in mind when operating.

- w Change your posture frequently.
- w Stretch and exercise you body regularly.
- w Remember to take breaks after working for a period of time.

## Knowing the Keyboard

The Notebook's keyboard provides all the functions of a full-sized keyboard and an additional [Fn] key for specific functions on the Notebook. The keyboard can be divided into four categories: **Typewriter keys**, **Cursor keys**, **Numeric keys** and **Function keys**.

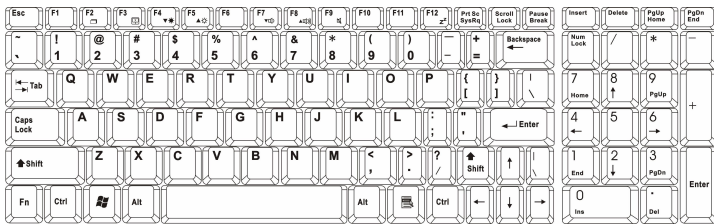

103-Key series

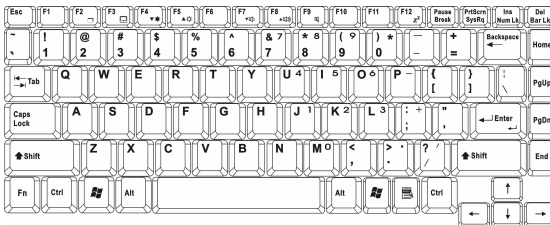

87-Key series

## Typewriter Keys

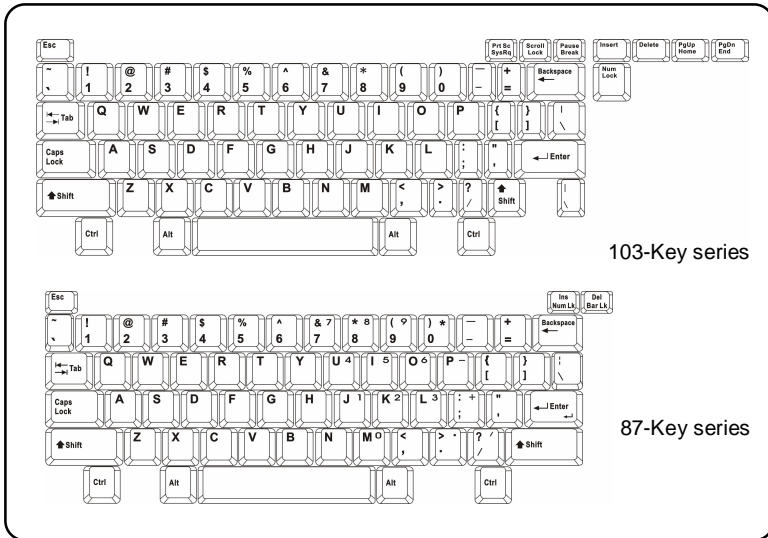

103-Key series

87-Key series

The function of these Typewriter keys is the major function of the keyboard, which is similar to the keys on a typewriter. It also provides several keys for special purposes, such as the [Ctrl], [Alt] and [Esc] key.

When the lock keys are pressed, the corresponding LEDs will light up to indicate their status:





- n **Num Lock:** Press and hold the [Fn] key and press this key to toggle the Num Lock on and off. When this function is activated, you can use the numeric keys that are embedded in the typewriter keys.
- n **Caps Lock:** Press this key to toggle the Caps Lock on and off. When this function is activated, the letters you type are kept in uppercase.
- n **Scroll Lock:** Press and hold the [Fn] key and press this key to toggle the



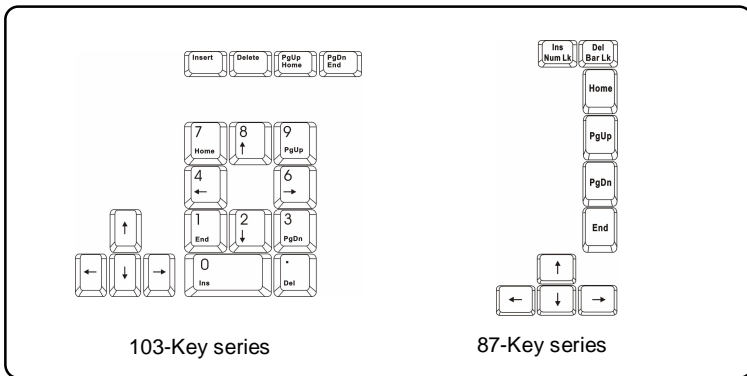



Scroll Lock on and off. This function is defined by individual programs, and it is usually used under DOS.

## Cursor Keys



The keyboard provides four cursor (arrow) keys and [Home], [PgUp], [PgDn], [End] keys at the lower right corner, which are used to control the cursor movement.



	Move the cursor left for one space.
	Move the cursor right for one space.
	Move the cursor up for one line.
	Move the cursor down for one line.

 + 	Move to the previous page.
 + 	Move to the next page.
	Move to the beginning of the line (or document).
	Move to the end of the line (or document).

The Backspace key, [Ins] and [Del] keys at upper right corner are use for editing purpose.

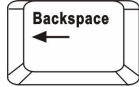
	This key is used to switch the typing mode between “insert” and “overwrite” modes.
	Press this key to delete one character to the right of the cursor and move the following text left for one space.
	Press this key to delete one character to the left of the cursor and move the following text left for one space.

## Numeric Keys

The keyboard provides a set of numeric keypad, which is embedded in the typewriter keys. When the Num Lock is activated, you can use these numeric keys to enter numbers and calculations.

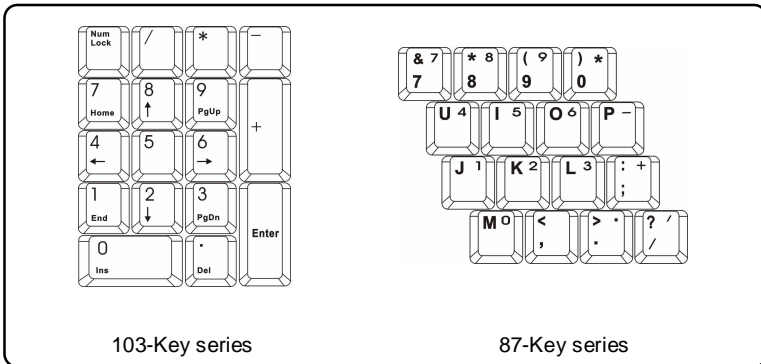



103-Key series

87-Key series





## Function Keys

### n Windows Keys

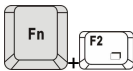
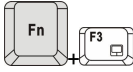
You can find the Windows Logo key () and one Application Logo key () on the keyboard, which are used to perform Windows-specific functions, such as opening the Start menu and launching the shortcut menu. For more information of the two keys, please refer to your Windows manual or online help.

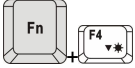
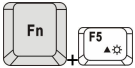
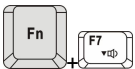
### n [Fn] Key

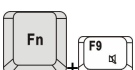
	Switch the display output mode between the LCD, external monitor and Both.
	Enable or disable the touchpad function.

	Decrease the LCD brightness.
	Increase the LCD brightness.
	Decrease the built-in speaker's volume.
	Increase the built-in speaker's volume.
	Disable the computer's audio function.
	Force the computer into suspend mode (depending on the system configuration).

## Knowing the Touchpad

The touchpad integrated in your Notebook is a pointing device that is compatible with standard mouse, allowing you to control the Notebook by pointing the location of the cursor on the screen and making selection with its two buttons.

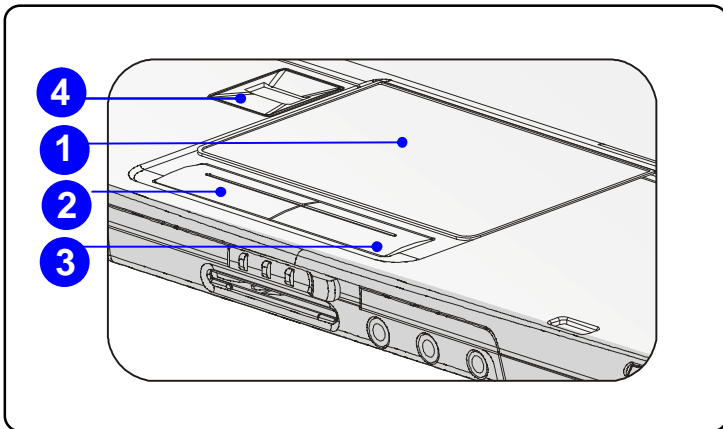

### 1. Cursor Movement Area

This pressure-sensitive area of the touchpad, allows you to place your finger on it and control the cursor on the screen by moving your finger.

### 2. Left Button

Acts as the mouse's left button.

### 3. Right Button

Acts as the mouse's right button.

### 4. Finger Print Identification (optional, for 87-key series only)

This area is for finger print identification.



## Using the Touchpad

Read the following description to learn how to use the touchpad:

### **n Positioning and Moving**

Place your finger on the touchpad (usually using the forefinger), and the rectangular pad will act as a miniature duplicate of your display. When you move your fingertip across the pad, the cursor on the screen will move simultaneously in the same direction. When your finger reaches the edge of the pad, lift your finger and replace it on a proper location of the touchpad.

### **n Point and Click**

When you have moved and placed the cursor over an icon, a menu item or a command that you want to execute, simply tap slightly on the touchpad or press the left button to select. This procedure, called as point and click is the basics of operating your Notebook. Unlike the traditional pointing device such as the mouse, the whole touchpad can act as a left button, so that your each tap on the touchpad is equivalent to pressing the left button. Tapping twice more rapidly on the touchpad is to execute a double-click.

### **n Drag and Drop**

You can move files or objects in your Notebook by using drag-and-drop. To do so, place the cursor on the desired item and slightly tap twice on the touchpad, and then keep your fingertip in contact with the touchpad on the second tap. Now, you can drag the selected item to the desired location by moving your finger on the touchpad, and then lift your finger from the touchpad to drop the item into place. Alternately, you can press and hold the left button when you select an item, and then move your finger to the

desired location; finally, release the left button to finish the drag-and-drop operation.

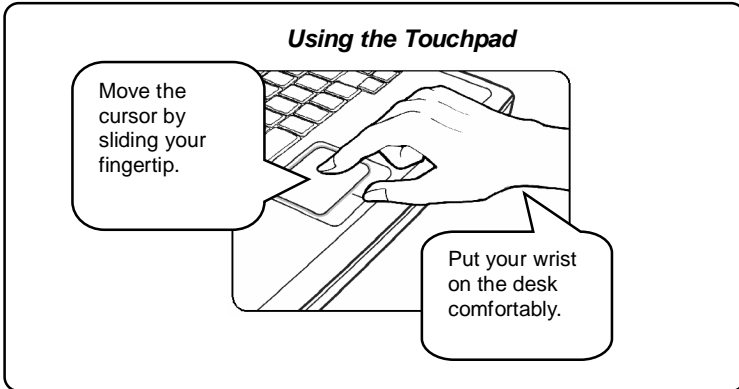

## n Configuring the Touchpad

You can customize the pointing device to meet your personal needs. For example, if you are a left-hand user, you may want to swap the functions of the two buttons. In addition, you can change the size, shape, moving speed and other advanced features of the cursor on the screen.

To configure the touchpad, you can use the standard Microsoft or IBM PS/2 driver in your Windows operating system. The **Mouse Properties** in **Control Panel** allows you to change the configuration.

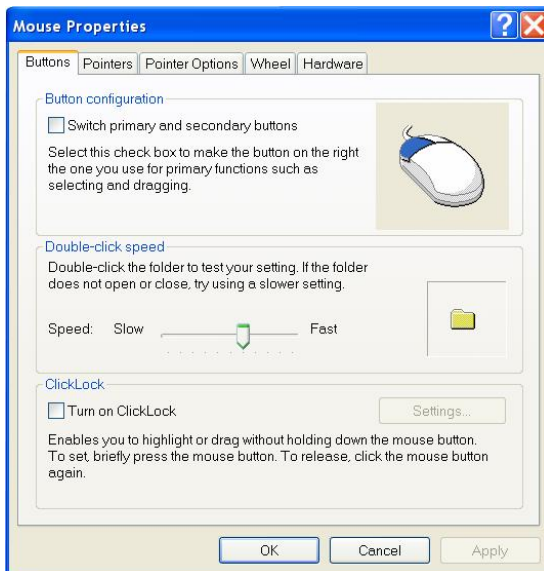

**Mouse Properties Window**