

**Panasonic**<sup>®</sup>

# OPERATING INSTRUCTIONS

Personal Computer

Model No. **FZ-M1** series

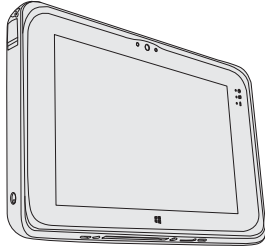

## Contents

### Read Me First

Safety Precautions .....	2
Regulatory Information .....	10

Read Me First

### Getting Started

Introduction.....	20
Description of Parts .....	23
First-time Operation.....	26
Turning On / Turning Off.....	31

Getting Started

### Useful Information

Handling and Maintenance.....	33
Installing Software .....	40

Useful Information

### Troubleshooting

Troubleshooting (Basic).....	46
------------------------------	----

Troubleshooting

### Appendix

LIMITED USE LICENSE AGREEMENT ...	55
Specifications .....	59
LIMITED WARRANTY .....	65

Appendix

Please read these instructions carefully before using this product, and save this manual for future use.

# Safety Precautions

To reduce the risk of injury, loss of life, electric shock, fire, malfunction, and damage to equipment or property, always observe the following safety precautions.

## Explanation of symbol word panels

The following symbol word panels are used to classify and describe the level of hazard, injury, and property damage caused when the denotation is disregarded and improper use is performed.

Read Me First

### **DANGER**

Denotes a potential hazard that will result in serious injury or death.

### **WARNING**

Denotes a potential hazard that could result in serious injury or death.

### **CAUTION**

Denotes a hazard that could result in minor injury.

### **NOTICE**

Denotes a hazard that could result in property damage.

The following symbols are used to classify and describe the type of instructions to be observed.



This symbol is used to alert users to a specific operating procedure that must not be performed.



This symbol is used to alert users to a specific operating procedure that must be followed in order to operate the unit safely.

### **DANGER**

#### Precautions on the Battery Pack

Electrolyte leakage, generation of heat, ignition or rupture of the Battery Pack may result.



- **Do Not Throw the Battery Pack into a Fire or Expose It to Excessive Heat**
- **Do Not Deform, Disassemble, or Modify the Battery Pack**
- **Do Not Short the Positive (+) and Negative (-) Contacts**
  - ⇒ Do not place the battery pack together with articles such as necklaces or hairpins when carrying or storing.



## DANGER

### Precautions on the Battery Pack



■ **Do Not Apply Shocks to the Product by Dropping It, Applying Strong Pressure to It, etc.**

⇒ If this product is subjected to a strong impact, damaged or deformed, stop using it immediately.

■ **Do Not Charge the Battery Using Methods Other Than Those Specified**

■ **Do Not Use the Battery Pack with Any Other Product**

• The battery pack is rechargeable and was intended for the specified product.

■ **Do Not Use This Product with a Battery Pack Other Than the One Specified**

⇒ Use only the specified battery pack with your product.



■ **When the Battery Pack Has Deteriorated, Replace It With a New One**

⇒ Do not continue to use a damaged battery pack.

■ **Avoid Extreme Heat (Near the Fire, in Direct Sunlight, for Example)**



## DANGER

### Precautions on the Built-in Bridge Battery (for disposal)

<Only for model with Built-in Bridge Battery>

When disposing the battery, generation of heat, ignition or rupture of the Built-in Bridge Battery may result. (→ page 37)



**Handling This Computer**

■ **Do Not Disassemble the Computer Except When Disposing**

**Handling the Built-in Bridge Battery**

■ **Do Not Short the Positive (+) and Negative (-) Contacts**

■ **Do Not Throw the Battery into a Fire or Expose It to Excessive Heat**

■ **Do Not Apply Shocks to the Built-in Bridge Battery by Dropping It, Applying Strong Pressure to It, etc.**

■ **Do Not Charge**

■ **Do Not Use**

■ **Do Not Deform, Disassemble, or Modify the Battery Pack**



■ **Avoid Extreme Heat (Near the Fire, in Direct Sunlight, for Example)**

Read Me First

## Safety Precautions



### WARNING

<Only for model with Built-in Bridge Battery>  
 Generation of heat, ignition or rupture of the Built-in Bridge Battery may result.



- Do Not Throw This Product Into a Fire or Expose It to Excessive Heat
- Do Not Insert Sharp Objects Into This Product, Disassemble, or Modify It
- Do Not Apply Shocks to the Product by Dropping It, Applying Strong Pressure to It, etc.
- Do Not Charge the Battery Using Methods Other Than Those Specified



- Avoid Extreme Heat (Near the Fire, In Direct Sunlight, for Example)
- When the Battery Has Deteriorated, Contact Your Technical Support Office to Replace the Battery

Read Me First



### WARNING

Fire or electric shock may result.



- Do Not Do Anything That May Damage the AC Cord, the AC Plug, or the AC Adaptor

Do not damage or modify the cord, place it near hot tools, bend, twist, or pull it forcefully, place heavy objects on it, or bundle it tightly.

⇒ Do not continue to use a damaged AC cord, AC plug and AC adaptor.  
 • Contact your technical support office for repair.

- Do Not Connect the AC Adaptor to a Power Source Other Than a Standard Household AC Outlet

⇒ Connecting to a DC/AC converter (inverter) may damage the AC adaptor. On an airplane, only connect the AC adaptor/charger to an AC outlet specifically approved for such use.

- Do Not Pull or Insert the AC Plug If Your Hands Are Wet

- Do Not Disassemble This Product

- Do Not Touch This Product In a Thunderstorm If Connected with the AC Cable or Any Other Cables



## WARNING



### ■ If a Malfunction or Trouble Occurs, Immediately Stop Use

If the Following Malfunction Occurs, Immediately Unplug the AC Plug and the Battery Pack

- This product is damaged
- Foreign object inside this product
- Smoke emitted
- Unusual smell emitted
- Unusually hot

⇒ After the above procedure, contact your technical support office for repair.

### ■ Clean Dust and Other Debris of the AC Plug Regularly

- If dust or other debris accumulates on the plug, humidity, etc. may cause a defect in the insulation.

### ■ Insert the AC Plug Completely

⇒ Do not use a damaged plug or loose AC outlet.

### ■ Close the Connector Cover Tightly When Using This Product Wherever There is a Lot of Water, Moisture, Steam, Dust, Oily Vapors, etc.

⇒ If foreign matter has found its way inside, immediately turn the power off and unplug the AC cord, and then remove the battery pack. Then contact your technical support office.



## WARNING

Burns or low-temperature burns may result.



### ■ Do Not Use This Product in Close Contact With Your Body For a Long Period of Time

⇒ Do not use this product with its heat-emitting parts in close contact with your body for long periods of time.

- Low-temperature burns may result.

### ■ Do Not Touch The Surface of The AC Adaptor Continuously While Using/Charging

- Burns may result.

Detrimental health effects on your body may result.



### ■ Do Not Turn the Volume Up To Loud When Using Headphones

- Listening at high volumes that overstimulate the ear for long periods of time may result in loss of hearing.

Read Me First

## Safety Precautions



### CAUTION

Fire or electric shock may result.

Read Me First



■ **Do Not Move This Product While the AC Plug Is Connected**

⇒ If the AC cord is damaged, unplug the AC plug immediately.

■ **Do Not Subject the AC Adaptor To Any Strong Impact**

⇒ Do not continue to use the AC adaptor after a strong impact such as being dropped.

⇒ Contact your technical support office for repair.

<Only for model with LAN>

■ **Do Not Connect a Telephone Line, or a Network Cable Other Than the One Specified, Into the LAN Port**

⇒ Do not connect to a network such as the ones listed below.

- Networks other than 100BASE-TX or 10BASE-T
- Phone lines (IP phone (Internet Protocol Telephone), Telephone lines, internal phone lines (on-premise switches), digital public phones, etc.)



■ **Do Not Leave This Product in High Temperature Environment for a Long Period of Time**

- Leaving this product where it will be exposed to extremely high temperatures such as near fire or in direct sunlight may deform the cabinet and/or cause trouble in the internal parts.



■ **Hold the Plug When Unplugging the AC Plug**

■ **Use Only the Specified AC Adaptor With This Product**

- ⇒ Do not use an AC adaptor other than the one supplied (supplied with the unit or one sold separately as an accessory).

This product may fall over or drop, resulting in an injury.



■ **Do Not Place This Product on Unstable Surfaces**



■ **Avoid Stacking**



## CAUTION

**Detrimental health effects on your body may result.**



■ **Take a Break Of 10-15 Minutes Every Hour**

- Using this product for long periods of time may have detrimental health effects on the eyes or hands.

**Burns, low-temperature burns, or frostbite may result.**



■ **Do Not Expose the Skin To This Product When Using the Product In A Hot Or Cold Environment**

- ⇒ When it is necessary to expose the skin to this product such as to scan a fingerprint, perform the operation in the shortest time possible.

## NOTICE

- Do not place the computer near a television or radio receiver.
- Keep the computer away from magnets. Data stored on the flash memory may be lost.
- This computer is not intended for the display of images for use in medical diagnosis.
- This computer is not intended for a use with connection of medical equipment for the purpose of medical diagnosis.
- Panasonic shall not be liable for loss of data or other incidental or consequential damages resulting from the use of this product.
- Do not touch the terminals on the battery pack. The battery pack may no longer function properly if the contacts are dirty or damaged.
- Do not expose the battery pack to water, or allow it to become wet.
- If the battery pack will not be used for a long period of time (a month or more), charge or discharge (use) the battery pack until the remaining battery level becomes 30% to 40% and store it in a cool, dry place.
- This computer prevents overcharging of the battery by recharging only when the remaining power is less than approx. 95% of capacity.
- The battery pack is not charged when the computer is first purchased. Be sure to charge it before using it for the first time. When the AC adaptor is connected to the computer, charging begins automatically.



Read Me First

## Safety Precautions

- Should the battery leak and the fluid get into your eyes, do not rub your eyes. Immediately flush your eyes with clear water and see a doctor for medical treatment as soon as possible.
- The battery pack is a consumable item. If the amount of time the computer can be run by using a particular battery pack becomes dramatically shorter and repeated recharging does not restore its performance, the battery pack should be replaced with a new one.

### NOTE

Read Me First

- The battery pack may become warm during recharging or normal use. This is completely normal.
- Recharging will not commence if internal temperature of the battery pack is outside of the allowable temperature range (0 °C to 50 °C {32 °F to 122 °F}). (→  *Reference Manual* "Battery Power") Once the allowable range requirement is satisfied, charging begins automatically. Note that the recharging time varies based on the usage conditions. (Recharging takes longer than usual when the temperature is 10 °C {50 °F} or below.)
- If the temperature is low, the operating time is shortened. Only use the computer within the allowable temperature range.
- This computer has a high temperature mode function that prevents the degradation of the battery in high temperature environments. (→  *Reference Manual* "Battery Power") A level corresponding to a 100% charge for high temperature mode is approximately equivalent to an 80% charge level for normal temperature mode.
- When transporting a spare battery inside a package, briefcase, etc., it is recommended that it be placed in a plastic bag so that its contacts are protected.
- Always power off the computer when it is not in use. Leaving the computer on when the AC adaptor is not connected will exhaust the remaining battery capacity.
- <Only for model with Built-in Bridge Battery>  
To minimize deterioration of the built-in bridge battery, connect the computer to the AC adaptor and recharge it for approximately 2 hours about once every year.



THIS PRODUCT IS NOT INTENDED FOR USE AS, OR AS PART OF, NUCLEAR EQUIPMENT/SYSTEMS, AIR TRAFFIC CONTROL EQUIPMENT/SYSTEMS, AIRCRAFT COCKPIT EQUIPMENT/SYSTEMS<sup>\*1</sup>, MEDICAL DEVICES OR ACCESSORIES<sup>\*2</sup>, LIFE SUPPORT SYSTEMS OR OTHER EQUIPMENTS/DEVICES/SYSTEMS THAT ARE INVOLVED WITH ENSURING HUMAN LIFE OR SAFETY. PANASONIC WILL NOT BE RESPONSIBLE FOR ANY LIABILITY RESULTING FROM THE USE OF THIS PRODUCT ARISING OUT OF THE FOREGOING USES.

<sup>\*1</sup> AIRCRAFT COCKPIT EQUIPMENT/SYSTEMS include Class2 Electronic Flight Bag (EFB) Systems and Class1 EFB Systems when used during critical phases of flight (e.g., during take-off and landing) and/or mounted on to the aircraft. Class1 EFB Systems and 2 EFB Systems are defined by FAA: AC (Advisory Circular) 120-76A or JAA: JAA TGL (Temporary Guidance Leaflets) No.36.

<sup>\*2</sup> As defined by the European Medical Device Directive (MDD) 93/42/EEC. Panasonic cannot guarantee any specifications, technologies, reliability, safety (e.g. Flammability/Smoke/Toxicity/Radio Frequency Emission, etc) requirements related to aviation standards that exceed the specifications of our COTS (Commercial-Off-The-Shelf) products.

This computer is not intended for use in medical equipment including life-support systems, air traffic control systems, or other equipment, devices or systems that are involved with ensuring human life or safety. Panasonic cannot be held responsible in any way for any damages or loss resulting from the use of this unit in these types of equipment, devices or systems, etc.

This computer has been designed so as to minimize shock to the LCD and flash memory drive, etc., but no warranty is provided against such trouble. Therefore, as a precision instrument, be extremely careful in the handling.

Read Me First

# Regulatory Information

## Information to the User / Informations destinées aux utilisateurs

Read Me First

<Only for model with wireless LAN/Bluetooth/wireless WAN>

### This product and your Health

This product, like other radio devices, emits radio frequency electromagnetic energy. The level of energy emitted by this product however is far much less than the electromagnetic energy emitted by wireless devices like for example mobile phones.

Because this product operates within the guidelines found in radio frequency safety standards and recommendations, we believe this product is safe for use by consumers. These standards and recommendations reflect the consensus of the scientific community and result from deliberations of panels and committees of scientists who continually review and interpret the extensive research literature.

In some situations or environments, the use of this product may be restricted by the proprietor of the building or responsible representatives of the organization. These situations may for example include:

- Using this product on board of airplanes, or
- In any other environment where the risk of interference to other devices or services is perceived or identified as harmful.

If you are uncertain of the policy that applies on the use of wireless devices in a specific organization or environment (e.g. airports), you are encouraged to ask for authorization to use this product prior to turning on the product.

### Regulatory Information

We are not responsible for any radio or television interference caused by unauthorized modification of this product. The correction of interference caused by such unauthorized modification will be the responsibility of the user. We

and its authorized resellers or distributors are not liable for damage or violation of government regulations that may arise from failing to comply with these guidelines.

26-M-1

<Uniquement pour les modèles avec réseau local sans fil et/ou Bluetooth>

### Ce produit et votre santé

Ce produit, comme tout autre appareil radio, émet de l'énergie radioélectrique. Toutefois, la quantité d'énergie émise par ce produit est beaucoup moins importante que l'énergie radioélectrique émise par des appareils sans fil tels que les téléphones portables. L'utilisation de ce produit ne comporte aucun risque pour le consommateur du fait que cet appareil opère dans les limites des directives concernant les normes et les recommandations de sécurité sur les fréquences radio. Ces normes et recommandations reflètent le consensus de la communauté scientifique et résultent de délibérations de jurys et comités de scientifiques qui examinent et interprètent continuellement les nouveautés de la vaste littérature sur les recherches effectuées. Dans certaines situations ou environnements, l'utilisation de ce produit peut être restreinte par le propriétaire du bâtiment ou par les représentants responsables de l'organisation. Ces situations peuvent être les suivantes par exemple :

- A bord d'un avion, ou
- Dans tout autre environnement où les risques d'interférence sur d'autres appareils ou services sont perçus ou identifiables comme dangereux.

Si vous n'êtes pas sûr de la réglementation applicable à l'utilisation d'appareils sans fil dans une organisation

ou un environnement spécifique, (par exemple dans un aéroport) nous vous invitons à demander l'autorisation d'utiliser ce produit avant sa mise en marche.

### Informations concernant la réglementation

Nous déclinons toute responsabilité pour toute interférence radio ou télévision causée par des modifications non

autorisées apportées à ce produit. La correction d'interférences causées par de telles modifications non autorisées sera la seule responsabilité de son utilisateur. Nous-mêmes, les revendeurs officiels et les distributeurs ne sommes pas responsables de tout dégât ou de toute violation des règlements de l'État pouvant découler du non-respect de ces directives.

26-F-1

## Lithium Battery / Pile au lithium

### Lithium Battery!

This computer contains a lithium battery to enable the date, time, and other data to be stored. The battery should only be exchanged by authorized service personnel.

#### Warning!

A risk of explosion from incorrect installation or misapplication may possibly occur.

15-E-1

### Pile au lithium!

Le micro-ordinateur renferme une pile au lithium qui permet de sauvegarder certaines données, notamment la date et l'heure. La pile ne doit être remplacée que par un technicien qualifié.

#### Danger!

Risque d'explosion en cas de non respect de cette mise en garde!

15-F-1

Read Me First

## Information for Users on Collection and Disposal of Old Equipment and used Batteries



These symbols are only valid in the European Union. If you wish to discard this product, please contact your local authorities or dealer and ask for the correct method of disposal.

53-M-1

# Regulatory Information

## Safety Precautions

<Only for model with wireless WAN>

The following safety precautions must be observed during all phases of the operation, usage, service or repair of any Personal Computer or Handheld Computer incorporating wireless WAN modem. Manufacturers of the cellular terminal are advised to convey the following safety information to users and operating personnel and to incorporate these guidelines into all manuals supplied with the product. Failure to comply with these precautions violates safety standards of design, manufacture and intended use of the product. Panasonic assumes no liability for customer failure to comply with these precautions.

Read Me First



When in a hospital or other health care facility, observe the restrictions on the use of mobiles. Switch Personal Computer or Handheld Computer incorporating wireless WAN modem off, if instructed to do so by the guidelines posted in sensitive areas. Medical equipment may be sensitive to RF energy.

The operation of cardiac pacemakers, other implanted medical equipment and hearing aids can be affected by interference from Personal Computer or Handheld Computer incorporating wireless WAN modem placed close to the device. If in doubt about potential danger, contact the physician or the manufacturer of the device to verify that the equipment is properly shielded. Pacemaker patients are advised to keep their Personal Computer or Handheld Computer incorporating wireless WAN modem away from the pacemaker, while it is on.



Switch off Personal Computer or Handheld Computer incorporating wireless WAN modem before boarding an aircraft. Make sure it cannot be switched on inadvertently. The operation of wireless appliances in an aircraft is forbidden to prevent interference with communications systems. Failure to observe these instructions may lead to the suspension or denial of cellular services to the offender, legal action, or both. For details on usage of this unit in aircrafts please consult and follow instruction provided by the airline.



Do not operate Personal Computer or Handheld Computer incorporating wireless WAN modem in the presence of flammable gases or fumes. Switch off the cellular terminal when you are near petrol stations, fuel depots, chemical plants or where blasting operations are in progress. Operation of any electrical equipment in potentially explosive atmospheres can constitute a safety hazard.



Your Personal Computer or Handheld Computer incorporating wireless WAN modem receives and transmits radio frequency energy while switched on. Remember that interference can occur if it is used close to TV sets, radios, computers or inadequately shielded equipment. Follow any special regulations and always switch off Personal Computer or Handheld Computer incorporating wireless WAN modem wherever forbidden, or when you suspect that it may cause interference or danger.



Road safety comes first! Do not use a Personal Computer or Handheld Computer incorporating wireless WAN modem while driving a vehicle. Do not place the computer with wireless WAN modem in an area where it could cause personal injury to the driver or passengers. It is recommended to stow the unit in the boot or secure stowage area while driving. Do not place the computer with wireless WAN modem in an area over an air bag or in the vicinity where an air bag may deploy. Air bags inflate with great force and if the computer with wireless WAN modem is placed in the air bag deployment area may be propelled with great force and cause serious injury to occupants of the vehicle.



**IMPORTANT!**  
Personal Computer or Handheld Computer incorporating wireless WAN modem operate using radio signals and cellular networks cannot be guaranteed to connect in all conditions. Therefore, you should never rely solely upon any wireless device for essential communications, for example emergency calls.  
Remember, in order to make or receive calls, Personal Computer or Handheld Computer incorporating wireless WAN modem must be switched on and in a service area with adequate cellular signal strength. Some networks do not allow for emergency calls if certain network services or phone features are in use (e.g. lock functions, fixed dialing etc.). You may need to deactivate those features before you can make an emergency call.  
Some networks require that a valid SIM card be properly inserted in Personal Computer or Handheld Computer incorporating wireless WAN modem.

Read Me First

**CAUTION:**  
Risk of Explosion if Battery is replaced by an Incorrect Type.  
Dispose of Used Batteries According to the Instructions. 58-E-1

**ATTENTION:**  
Il y a risque d'explosion si la batterie est remplacée par une batterie de type incorrect.  
Mettre au rebut les batteries usagées conformément aux instructions. 58-F-1

# Regulatory Information

## Camera Light

<For model with rear camera>

### CAUTION

- The light from the LED is strong and can injure human eyes. Do not look directly at the LEDs with naked eyes.

57-E-1

## For U.S.A.

Read Me First

### Federal Communications Commission Radio Frequency Interference Statement

Note: This equipment has been tested and found to comply with the limits for a Class B digital device, pursuant to Part 15 of the FCC Rules. These limits are designed to provide reasonable protection against harmful interference in a residential installation. This equipment generates, uses and can radiate radio frequency energy and, if not installed and used in accordance with the instructions, may cause harmful interference to radio communications. However, there is no guarantee that interference will not occur in a particular installation. If this equipment does cause harmful interference to radio or television reception, which can be determined by turning the equipment off and on, the user is encouraged to try to correct the interference by one or more of the following measures:

- Reorient or relocate the receiving antenna.
- Increase the separation between the equipment and receiver.
- Connect the equipment into an outlet on a circuit different from that to which the receiver is connected.
- Consult the Panasonic Service Center or an experienced radio/TV technician for help.

### Warning

To assure continued compliance, use only shielded interface cables when connecting to a computer or peripheral. Also, any changes or modifications not expressly approved by the party responsible for compliance could void the user's authority to operate this equipment.

### FCC RF Exposure Warning:

- This equipment is provided with PC Card slot that could be used with wireless transmitters, which will be specifically recommended when they become available. Other third-party wireless transmitters have not been RF exposure evaluated for use with this computer and may not comply with FCC RF exposure requirements.

<Only for model with wireless LAN/wireless WAN/Bluetooth>

- This equipment complies with FCC radiation exposure limits set forth for an uncontrolled environment.
- This equipment may not be co-located or operated with any other antenna or transmitter.

- This device meets the government's requirements for exposure to radio waves.

This device is designed and manufactured not to exceed the emission limits for exposure to radio frequency (RF) energy set by the Federal Communications Commission of the U.S. Government.

- The exposure standard for wireless device employs a unit of measurement known as the Specific Absorption Rate, or SAR. The SAR limit set by the FCC is 1.6 W/kg.

\* Tests for SAR are conducted using standard operating positions accepted by the FCC with the device transmitting at its highest certified power level in all tested frequency bands.

Although the SAR is determined at the highest certified power level, the actual SAR level of the device while operating can be well below the maximum value. This is because the device is designed to operate at multiple power levels so as to use only the power required to reach the network. In general, the closer you are to a wireless base station antenna, the lower the power output.

<Only for model with wireless LAN>

This product is restricted to indoor use due to its operation in the 5.15 to 5.25 GHz frequency range. FCC requires this product to be used indoors for the frequency range 5.15 to 5.25 GHz to reduce the potential for harmful interference to co-channel Mobile Satellite systems. High power radars are allocated as primary users of the 5.25 to 5.35 GHz and 5.65 to 5.85 GHz bands. These radar stations can cause interference with and/or damage this product.

25-M-W-1

This device complies with Part 15 of the FCC Rules. Operation is subject to the following two conditions:

- (1) This device may not cause harmful interference, and
- (2) This device must accept any interference received, including interference that may cause undesired operation.

Responsible Party:

Panasonic Corporation of North America  
Two Riverfront Plaza  
Newark, NJ 07102

Support Contact:

<http://www.panasonic.com/contactinfo>

6-M-1

Read Me First

## Regulatory Information

USA Only: Disposal may be regulated in your community due to environmental considerations. For disposal or recycling information, please visit Panasonic website: <http://www.panasonic.com/environmental> or call 1-888-769-0149

65-M-2

<For USA-California Only>

Read Me First

**This product contains a CR Coin Cell Lithium Battery which contains Perchlorate Material - special handling may apply.**

**See [www.dtsc.ca.gov/hazardouswaste/perchlorate/](http://www.dtsc.ca.gov/hazardouswaste/perchlorate/)**

38-M-1

<For USA and Canada>



A lithium ion battery that is recyclable powers the product you have purchased. Please call 1-800-8-BATTERY for information on how to recycle this battery.

L'appareil que vous vous êtes procuré est alimenté par une batterie au lithium-ion. Pour des renseignements sur le recyclage de la batterie, veuillez composer le 1-800-8-BATTERY.

48-M-1



## For Canada / Pour le Canada

### Canadian ICES-003

CAN ICES-003(B) / NMB-003(B)

7-M-3

<Only for model with wireless LAN/Bluetooth>

#### Industry Canada

This product complies with RSS210 Industry Canada.

Operation is subject to the following two conditions;

- (1) this device may not cause interference, and
- (2) this device must accept any interference, including interference that may cause undesired operation of the device.

<Ne s'applique qu'aux modèles avec technologie Bluetooth/LAN sans fil>

#### Industrie Canada

Cet équipement est conforme à la norme CNR-210 d'Industrie Canada. Son fonctionnement est soumis aux deux conditions suivantes :

- (1) ce dispositif ne peut produire de brouillage, et
- (2) ce dispositif doit accepter le brouillage, y compris le brouillage pouvant entraîner le fonctionnement non désiré de l'appareil.

30-Ca-1-1

<Only for model with wireless LAN>

This product (local network devices) for the band 5150-5250 MHz is only indoor usage to reduce potential for harmful interference to co-channel Mobile Satellite systems.

High power radars are allocated as primary users (meaning they have priority) of 5250-5350 MHz and 5650-5850 MHz and these radars could cause interference and/or damage to LELAN devices.

<Ne s'applique qu'aux modèles avec technologie LAN sans fil>

Cet appareil (pour réseaux locaux radioélectriques) dans les bandes de fréquences 5150-5250 MHz est réservé à une utilisation à l'intérieur afin de réduire le risque d'interférence avec les systèmes satellites mobiles bicanaux. Les radars forte puissance sont désignés comme étant les premiers utilisateurs (c'est-à-dire qu'ils ont la priorité) des bandes de fréquences 5250-5350 MHz et 5650-5850 MHz. Ces stations radars peuvent provoquer des interférences et/ou des dommages à ce périphérique.

30-Ca-2-1

<Only for model with wireless LAN/wireless WAN/Bluetooth>

- This computer complies with Industry Canada radiation exposure limits set forth for an uncontrolled environment.
- This PC with WLAN and/or Bluetooth transmitters installed, has been approved for portable operation and does not require any minimum spacing be provided between antennas and all person's body.

<Ne s'applique qu'aux modèles avec technologie Bluetooth/LAN sans fil/WAN sans fil>

- Cet équipement est conforme aux limites d'exposition aux rayonnements d'Industrie Canada établies pour un environnement non contrôlé.
- Ce PC avec émetteurs WLAN et/ou Bluetooth a été approuvé à des fins d'opération mobile; aucun espace minimum entre les antennes et le corps de l'utilisateur n'est requis.

Read Me First

## Regulatory Information

Read Me First

This device has been designed to operate with the WWAN antenna having a maximum gain of 4 dBi for the 850 MHz band, 3 dBi for the 1700 MHz band and 3 dBi for the 1900 MHz band. WWAN Antenna having a higher gain is strictly prohibited per regulations of Industry Canada. The Required antenna impedance is 50 ohms.

To reduce potential radio interference to other users, the antenna type and its gain should be so chosen that the equivalent isotropically radiated power (EIRP) is not more than that required for successful communication.

<Utilisation au Canada>

Ce dispositif a été conçu pour fonctionner avec l'antenne de réseau étendu sans fil (WWAN) avec un gain maximum de 4 dBi dans la bande de 850 MHz, 3 dBi dans la bande de

1 700 MHz et 3 dBi dans la bande de 1 900 MHz. Les règlements d'Industrie Canada interdisent l'utilisation d'une antenne WWAN dont le gain serait supérieur à cette limite. L'antenne doit avoir une impédance de 50 ohms.

Afin de réduire le risque d'interférence radioélectrique aux autres utilisateurs des bandes de fréquences, le type d'antenne et son gain doivent être tels que la puissance isotrope rayonnée équivalente (PIRE) n'est pas plus élevée que le niveau requis pour assurer la communication.

32-Ca-1-1

FOR USE WITH MODEL NO. :  
CF-AA6373A  
POUR UTILISER AVEC MODÈLE :  
CF-AA6373A

20-Ca-1

## For U.S.A and Canada

### For Used in Motor Vehicle /Pour L'utilisation Dans Un Véhicule Motorisé

Warning: Notebook Computer may be installed in a motor vehicle and visible to the driver only if used to support vehicle related functions such as vehicle information, system control, rear or side observation and navigation. If used for entertainment purpose, such as television reception or video play, it must be installed to the rear of the driver's seat where it will not be visible, directly or indirectly, to the operator of the motor vehicle. Check with individual state/provincial laws to determine lawful use of this product while operating within a motor vehicle.

Avertissement : L'ordinateur bloc-notes peut être installé dans un véhicule motorisé et dans le champ de vision du conducteur uniquement en tant que dispositif d'aide aux fonctions du véhicule, comme par exemple pour fournir des informations sur le véhicule, comme dispositif de contrôle de système, pour l'observation à l'arrière ou sur les côtés du véhicule, ainsi que pour fournir de l'information routière. Pour toute utilisation à fin de divertissement, comme par exemple pour regarder la télévision ou jouer à des jeux vidéo, il doit être installé à l'arrière du siège du conducteur, en un emplacement où il ne sera pas visible, ni directement ni indirectement, pour le conducteur du véhicule motorisé. Vérifiez les lois fédérales et nationales qui régissent l'utilisation légale de cet appareil à l'intérieur d'un véhicule motorisé.

35-M-1

## For India



For the purpose of recycling to facilitate effective utilization of resources, please return this product to a nearby authorized collection center, registered dismantler or recycler, or Panasonic service center when disposing of this product.

Please see the Panasonic website for further information on collection centers, etc.

<http://www.panasonic.co.in/wps/portal/home>

68-M-1

Read Me First

# Introduction







Thank you for purchasing this Panasonic product. For optimum performance and safety, please read these instructions carefully.

In these instructions, the names are referred as follows.

**Windows 8.1** indicates Windows® 8.1 Operating System.

**Windows 7** indicates Windows® 7 Operating System.

## ■ Terms and illustrations in these instructions

<b>CAUTION</b> :	Conditions that may result in minor or moderate injury.
<b>NOTE</b> :	Useful and helpful information.
<b>Enter</b> :	Press [Enter] key.
<b>Alt + Del</b> :	Press and hold [Alt] key, and then press [Del] key.
→ :	Page in these Operating Instructions or in the Reference Manual.
 :	Reference to the on-screen manuals.
<b>Windows 8.1</b> Display "Charm":	Align the cursor to the top right (or bottom right) corner of the screen to display Charm menu. Alternatively: Flick toward the center of the screen from the right edge.
 -  :	Touch  (Settings) and then touch  (Power).
<b>Windows 7</b>  (Start) - [All Programs] :	Touch  (Start), and then touch [All Programs].

- Some illustrations are simplified to help your understanding and may look different from the actual unit.
- If you do not log on as an administrator, you cannot use some functions or cannot display some screens.
- Refer for the latest information about optional products to the catalogs, etc.
- In these instructions, the names and terms are referred as follows.
  - "Windows® 8.1 Pro 64-bit" as "Windows" or "Windows 8.1"
  - "Windows® 7 Professional 32-bit Service Pack 1" and "Windows® 7 Professional 64-bit Service Pack 1" as "Windows" or "Windows 7"

---

- **Windows 8.1**

Screen messages are explained in [English (United States)].  
(Depending on the language preference, some screen messages in these instructions are different from the actual screen messages. For example, [Flight mode] may be displayed instead of [Airplane mode] in some language preference.)

- **Disclaimer**

Computer specifications and manuals are subject to change without notice. Panasonic Corporation assumes no liability for damage incurred directly or indirectly from errors, omissions or discrepancies between the computer and the manuals.

- **Trademarks**

Microsoft®, Windows®, and the Windows logo are registered trademarks of Microsoft Corporation of the United States and/or other countries.  
Intel, Core, Centrino and PROSet are either registered trademarks or trademarks of Intel Corporation.

microSDXC Logo is a trademark of SD-3C, LLC.



Adobe, the Adobe logo and Adobe Reader are either registered trademarks or trademarks of Adobe Systems Incorporated in the United States and/or other countries.

Bluetooth® is a registered trademark owned by Bluetooth SIG, Inc., U.S.A. and licensed to Panasonic Corporation.

HDMI, the HDMI Logo and High-Definition Multimedia Interface are trademarks or registered trademarks of HDMI Licensing LLC in the United States and other countries.

Names of products, brands, etc., appearing in this manual are trademarks or registered trademarks of their respective own companies.

# Introduction

---

## ■ On-screen Manual

For further information about the computer, you can refer to the on-screen manual.

### ● Reference Manual

The Reference Manual contains the practical information to help you fully enjoy the computer's performance.

### ● Important Battery Tips

The Important Battery Tips will provide you with the battery information so that you can use the battery in the optimum condition to obtain longer operation time.

To access the on-screen manuals, follow the steps below.

#### **Windows 8.1**

On the Start screen, touch the [Manual Selector] tile, and select the on-screen manual.

#### **Windows 7**

Double-touch [Manual Selector] on the desktop screen, and select the on-screen manual.

#### **NOTE**

- [Contents] tab or [Search] tab is displayed on the left side of the window. Select tab and display the desired item.

# Description of Parts

## Front side

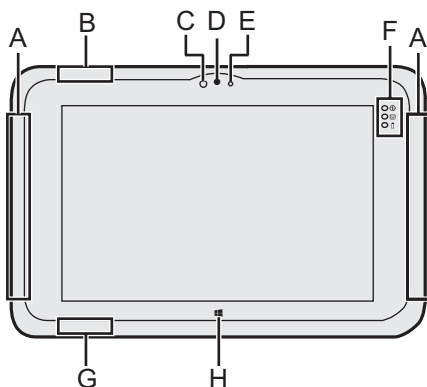

### A: Wireless WAN Antenna

<Only for model with wireless WAN>

→ *Reference Manual* "Wireless WAN"

### B: Wireless LAN Antenna

<Only for model with wireless LAN>

→ *Reference Manual* "Wireless LAN"

### C: Ambient Light Sensor

The ambient light sensor is equipped with an automatic brightness adjustment function that adjusts the display screen. (→ page 35)

### Front Camera

→ *Reference Manual* "Camera"

### D: Camera Lens

### E: Camera Indicator

### F: LED Indicators

: Power Indicator  
Off: Power off/Hibernation, Green: Power on, Blinking green: Sleep.

: Drive status

: Battery status  
→ page 34 "When the battery indicator does not light on"  
→ *Reference Manual* "Battery Power"

### G: Wireless LAN Antenna / Bluetooth Antenna

<Only for model with wireless LAN>

<Only for model with Bluetooth>

→ *Reference Manual* "Wireless LAN" "Bluetooth"

### H: Windows Button

→ *Reference Manual* "Tablet Buttons"

# Description of Parts

**Left side**

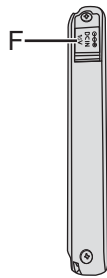

**Top**

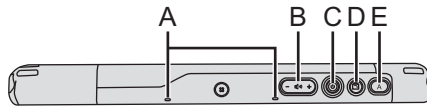

**Bottom**

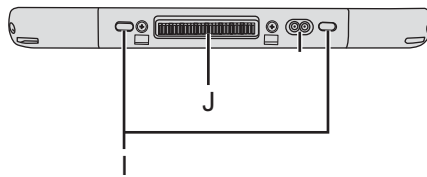

**Right side**

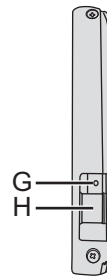

**Getting Started**

**A: Microphone**

**B: Volume Button**

→ *Reference Manual* "Tablet Buttons"

**C: Power Switch**

**D: Rotation Lock Button**

→ *Reference Manual* "Display Rotation"

**E: A Button**

→ *Reference Manual* "Tablet Buttons"

**F: DC-IN Jack**

**G: Headset Jack**

A headset or headphone can be connected.

**H: USB3.0 Port**

→ *Reference Manual* "USB Devices"

**I: Security Lock**

A Kensington cable can be connected.

For further information, read the manual that comes with the cable.

**J: Expansion Bus Connector**

→ *Reference Manual*



## Rear side

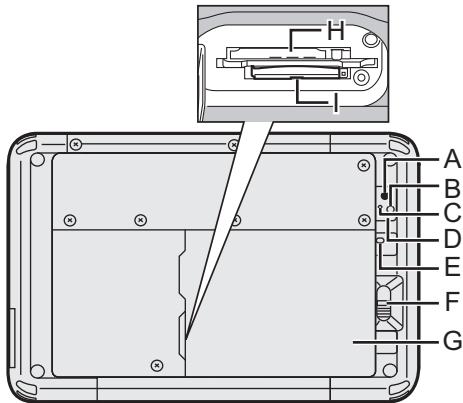

### Rear Camera

→ *Reference Manual* “Camera”

- A: Camera Lens**
- B: Camera Light**
- C: Camera Indicator**

### D: Speaker

### E: Battery Indicator

<Only for model with Built-in Bridge Battery>

### F: Battery Latch

→ *Reference Manual* “Battery Power”

### G: Battery Pack

### H: microSIM Card Slot

<Only for model with wireless WAN>

→ *Reference Manual* “Wireless WAN”

### I: microSD Memory Card Slot

→ *Reference Manual* “microSD Memory Card Slot”

### J: Barcode Reader / Serial Port / LAN Port

<Only for model with Barcode Reader>

→ *Reference Manual* “Barcode Reader”

## Top (optional)

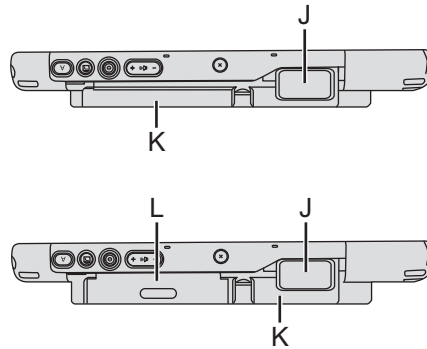

<Only for model with Serial Port>

→ *Reference Manual* “Serial Port”

<Only for model with LAN Port>

→ *Reference Manual* “LAN”

### K: Built-in Bridge Battery

<Only for model with Built-in Bridge Battery>

### L: Smart Card Reader / Magnetic Stripe Card Reader / NFC Reader / RFID Reader

<Only for model with Smart Card Reader>

→ *Reference Manual* “Smart Card Reader”

<Only for model with Magnetic Stripe Card Reader>

→ *Reference Manual* “Magnetic Stripe Card Reader”

<Only for model with NFC Reader>

→ *Reference Manual* “NFC Devices/RFID Reader”

<Only for model with RFID Reader>

→ *Reference Manual* “NFC Devices/RFID Reader”

# First-time Operation

## ■ Preparation

① Check and identify the supplied accessories.

If you do not find the described accessories, contact Panasonic Technical Support (→ page 65).

• **AC Adaptor** . . . . . 1 • **AC Cord** . . . . . 1 • **Battery Pack** . . . . . 1

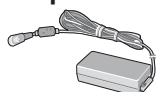

Model No: CF-AA6373A

Model No: FZ-VZSU94W

• **Soft Cloth** . . . . . 1

• **OPERATING INSTRUCTIONS (This book)**. . . . . 1

② Read the LIMITED USE LICENSE AGREEMENT before breaking the seal on the computer's packaging (→ page 55).

Getting Started

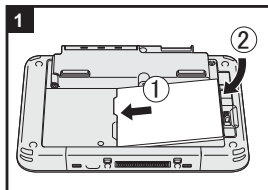

## 1 Inserting the Battery Pack.

Turn over the computer and insert the battery pack until it touch to the secured position.

- Make sure no foreign objects are under the computer.

### CAUTION

- Make sure the latch is securely locked. Otherwise the battery pack may fall when you carry the computer.
- Do not touch the terminals of the battery pack and the computer. Doing so can make the terminals dirty or damaged, and may cause malfunction of the battery pack and the computer.

### NOTE

- Note that the computer consumes electricity even when the computer power is off. If the battery pack is fully charged, the battery will fully discharge in the following period of time:

Status	FZ-VZSU94W	FZ-VZSU95W (optional)
When power is off	Approx. 8 weeks	Approx. 18 weeks
In sleep <sup>*1</sup>	Approx. 5 days	Approx. 11 days
In hibernation	Approx. 8 weeks	Approx. 18 week

<sup>\*1</sup> <Only for model with LAN>

If "Wake Up from wired LAN" is enabled, the period of time will be shorter.

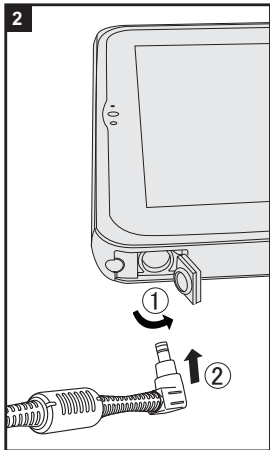



## 2 Connect your computer to a power outlet.

The battery charging starts automatically.

### CAUTION

- Do not disconnect the AC adaptor until the first-time operation procedure is completed.
- When using the computer for the first time, do not connect any peripheral device (including wired LAN cable) except the battery pack and AC adaptor.
- **Handling the AC adaptor**
  - Problems such as sudden voltage drops may arise during periods of thunder and lightning. Since this could adversely affect your computer, an uninterruptible power source (UPS) is highly recommended unless running from the battery pack alone.

## 3 Turn on the computer.

Press the power switch  (→ page 24) until the power indicator  (→ page 23) lights. (→ page 31)

### CAUTION

- Do not press the power switch repeatedly or do not hold the power switch for four seconds or longer.
- Any changes from the default setting of the Setup Utility must not be made until the First-time Operation is completed.

## 4 Setup Windows.

Follow the on-screen instructions.

- The computer restarts several times. Do not touch the screen or tablet buttons, and wait until the drive indicator  has turned off.
- After the computer is turned on, the screen remains black or unchanged for a while, but this is not a malfunction. Wait for a moment until the Windows setup screen appears.

## First-time Operation

---

- Setup of Windows will take approximately **Windows 8.1** 5 minutes / **Windows 7** 20 minutes. Go to the next step, confirming each message on the display.
- **Windows 7** Follow the steps below.
  - ① When “Enable sensors” is displayed, touch [Enable this sensor].
  - ② When the [User Account Control] screen is displayed, touch [Yes].
  - ③ At the [Display Rotation Tool] confirmation screen, touch [Yes].The computer restarts automatically, and the setting is enabled.
- You can set the Wireless Network after the setup of Windows is complete.
  - Windows 8.1** If “Get online” is displayed, you can select “Skip this step”.
  - Windows 7** “Join a wireless network” screen may not appear.

---

### CAUTION

- You can change the user name, password, image and security setting after setup of Windows.
  - Remember your password. If you forget the password, you cannot use Windows. Creating a password reset disk beforehand is recommended.
  - Do not use the following words for user name: CON, PRN, AUX, CLOCK\$, NUL, COM1 to COM9, LPT1 to LPT9, @, &, space. In particular, if you create a user name (account name) that includes the “@” mark, a password will be requested at the log-on screen, even if no password has been set. If you try to log on without entering a password, “The user name or password is incorrect.” may be displayed and you will not be able to **Windows 8.1** sign in / **Windows 7** log on to Windows (➔ page 51).
-

## 5 Create the recovery disc.

A recovery disc allows you to install OS and restore its factory default condition, in case, for example, the recovery partition of the flash memory is damaged. We recommend creating a recovery disc before you begin using the computer.

Refer to →  *Reference Manual* "Recovery Disc Creation Utility" about creating the disc.

### NOTE

#### ● PC Information Viewer

This computer periodically records the management information of the flash memory, etc. The maximum data volume for each record is 1024 bytes. This information is only used for estimating the cause when the flash memory goes down by any possibility. They are never sent to outside via network nor used for any other purpose except for the purpose described the above. To disable the function, add the check mark for [Disable the automatic save function for management information history] in [Hard Disk Status] of PC Information Viewer, and touch [OK]. Then follow the on-screen instructions. (→  *Reference Manual* "Checking the Computer's Usage Status")

#### ■ Before using wireless function

##### Windows 8.1

- ① Display "Charm", and touch  - [Change PC Settings] - [Network] - [Airplane mode].  
Set [Airplane mode] to [Off], and then;  
set [Wi-Fi] to [On] (for wireless LAN).  
set [Mobile broadband] to [On] (for wireless WAN).  
set [GPS] to [On] (for wireless WAN).  
set [Bluetooth] to [On] (for Bluetooth).

#### ■ To change the partition structure

You can shrink a part of an existing partition to create unallocated disk space, from which you can create a new partition. In the default setting, you can use a single partition.

##### ① Windows 8.1

1. Touch  on the Start screen, and then long touch [This PC] under "Windows System".
2. Touch [Manage] on app bar.

##### Windows 7

Touch  (Start) and long touch [Computer], then touch [Manage].

- A standard user needs to enter an administrator password.
- ② Touch [Disk Management].

## First-time Operation

---

- ③ Long touch the partition for Windows ("c" drive in the default setting), and touch [Shrink Volume].
  - The partition size depends on the computer specifications.
- ④ Input the size in [Enter the amount of space to shrink in MB] and touch [Shrink].
  - You cannot input a larger number than the displayed size.
  - To select [Reinstall to the OS related partitions.] in installing OS (→ page 42), **Windows 8.1** 70 GB / **Windows 7** 60 GB or more is necessary for [Total size after shrink in MB].
- ⑤ Long touch [Unallocated] (the shrunk space in the step ④) and touch [New Simple Volume].
- ⑥ Follow the on-screen instructions to make the settings, and touch [Finish]. Wait until formatting is completed.



---

### NOTE

- You can create an additional partition using remaining unallocated space or newly creating unallocated space.
  - To delete a partition, long touch the partition and touch [Delete Volume] in the step ③.
-

# Turning On / Turning Off

## Turning On

Press the power switch  (→ page 24) until the power indicator  (→ page 23) lights.

### NOTE

- Do not press the power switch repeatedly.
- The computer will forcibly be turned off if you press the power switch for four seconds or longer.
- Once you turn off the computer, wait for ten seconds or more before you turn on the computer again.
- Do not perform the following operation until the drive indicator  turns off.
  - Connecting or disconnecting the AC adaptor
  - Pressing the power switch
  - Touching tablet buttons, screen or external mouse

## Turning Off

- ① Shut down the computer.

### Windows 8.1

1. Display "Charm", and touch .
2. Touch [Power] - [Shut down].

### Windows 7

Touch  (Start) - [Shutdown].

### NOTE

- **Windows 8.1**  
To turn off the computer completely, proceed as follows.
  - ① Display "Charm", and touch  - [Change PC settings] - [Update and recovery] - [Recovery].
  - ② Touch [Restart now] under "Advanced startup".
  - ③ Touch [Turn off your PC].

## Turning On / Turning Off

### Precaution against Starting Up/Shutting Down

- Do not do the following
  - Connecting or disconnecting the AC adaptor
  - Pressing the power switch
  - Touching tablet buttons, screen or external mouse

#### NOTE

- To conserve power, the following power saving methods are set at the time of purchase.
    - The screen automatically turns off after :
      - 10 minutes (when AC adaptor is connected) of inactivity
      - 5 minutes (when operating on battery power) of inactivity
    - The computer automatically enters sleep<sup>\*1</sup> after :
      - 20 minutes (when AC adaptor is connected) of inactivity
      - 15 minutes (when operating on battery power) of inactivity
- <sup>\*1</sup> Refer to  *Reference Manual* "Sleep or Hibernation Functions" about re-summing from sleep.



# Handling and Maintenance

## Operation environment

- Place the computer on a flat stable surface not subject to shock, vibration, and danger of dropping. Do not place the computer upright or turn it over. If the computer is exposed to an extremely strong impact, it may become damaged.
  - Operating environment
    - Temperature: Operation : -10 °C to 50 °C {14 °F to 122 °F} (IEC60068-2-1, 2)<sup>\*1</sup>  
Storage : -20 °C to 60 °C {-4 °F to 140 °F}
    - Humidity: Operation : 30% to 80% RH (No condensation)  
Storage : 30% to 90% RH (No condensation)
- Even within the above temperature/humidity ranges, operation for a long time in extreme environments, smoking nearby, or operation in places where oil is used or where there is a lot of dust will result in the product deterioration and will shorten the product life.
- <sup>\*1</sup> Do not expose the skin to this product when using the product in a hot or cold environment. (→ page 7)
- If the computer is wet in temperatures of 0 °C {32 °F} or below, freeze damage may occur. Make sure to dry off the computer in such temperatures.
- Do not place the computer in the following areas, otherwise the computer may be damaged.
    - Near electronic equipment. Image distortion or noise may occur.
    - In extremely high or low temperature.
  - As the computer can become hot during operation, keep it away from items that are sensitive to heat.

## Handling cautions

This computer is designed to minimize shock to parts such as the LCD and the flash memory drive, but no warranty is provided against any trouble caused by shock. Be extremely careful when handling the computer.

- When carrying the computer:
  - Turn off the computer.
  - Remove all external devices, cables, Smart Cards and other protruding objects.
  - Do not drop or hit the computer against solid objects.
  - Do not grip the display part.
- When you board an airplane, take the computer with you and never put it in your checked luggage. When using the computer on airplane, follow the airline's instructions.
- When carrying a spare battery, put it in a plastic bag to protect its terminals.

## Handling and Maintenance

- The touchscreen is designed to be used by a finger tip. Do not place any object on its surface and do not press down strongly with sharp-pointed or hard objects that may leave marks (e.g., nails, pencils and ball point pens).
- Avoid any harmful substances such as oil from getting into the touchscreen. The pointer may not work correctly.
- Be careful not to get injured by dropping or getting hit when carrying the computer.
- Use only the dedicated pen (optional) to touch the screen. Do not place any object on its surface and do not press down strongly with sharp-pointed or hard objects that may leave marks (e.g., nails, pencils and ball point pens).
- Do not use the screen when dust or dirt (e.g., oil) is on the screen. Otherwise foreign particles on the screen/dedicated pen (optional) can scratch the screen surface or obstruct the dedicated pen (optional) operation.
- Use the dedicated pen (optional) only for touching the screen. Using it for any other purpose may damage the dedicated pen (optional) and result in scratches on the screen.

### ■ When the battery indicator does not light on

The battery indicator may not light on even if the AC adaptor and the battery pack are correctly connected to the computer, due to the following reasons.

- The AC adaptor's protection function may be working. In this case, pull out the AC cord and wait for more than 1 minute before reconnecting the AC cord.

### ■ When using peripheral devices

Follow these instructions and the *Reference Manual* to avoid any damage to the devices. Carefully read the instruction manuals of the peripheral devices.

- Use the peripheral devices conforming to the computer's specifications.
- Connect to the connectors in the correct direction.
- If it is hard to insert, do not try forcibly but check the connector's shape, direction, alignment of pins, etc.
- If screws are included, fasten them securely.
- Remove the cables when you carry the computer. Do not pull the cables forcibly.

---

## ■ Preventing your computer from unauthorized use via wireless LAN/Bluetooth/Wireless WAN

<Only for model with wireless LAN/Bluetooth/Wireless WAN>

- Before using wireless LAN/Bluetooth/Wireless WAN, make the appropriate security settings such as data encryption.

## ■ Battery Recalibration

- The battery recalibration may take a long time due to the large battery capacity. This is not a malfunction.

<When performing "Battery Recalibration" after shutting down Windows>

- Full charge: Approximately 2.5 hours (with FZ-VZSU94W) / Approximately 4.5 hours (with FZ-VZSU95W (optional))
- Complete discharge: Approximately 3.5 hours (with FZ-VZSU94W) / Approximately 7.5 hours (with FZ-VZSU95W (optional))

When performing "Battery Recalibration" without shutting down Windows, it may take more time to charge / discharge.

## ■ Sensors

This computer is equipped with four sensors (acceleration sensor, gyro sensor, magnetic sensor, ambient light sensor), and you can use these sensors with any software that is compatible.

As the accuracy of each sensor output is dependent on the operating environment and other conditions, the results should only be used as a reference.

The acceleration sensor, gyro sensor, and magnetic sensor are located at the bottom left of the LCD. The detection results of each sensor may vary depending on the display mode, how you are holding the computer, the application software you are using, and other factors.

Useful Information

## Handling and Maintenance

### ● Automatic brightness adjustment

The computer is equipped with an automatic brightness adjustment function that adjusts the display screen based on the ambient light sensor. You can configure the automatic adjustment function as follows.

#### Windows 8.1

- ① Display "Charm", and touch  - [Change PC Settings] - [PC and devices] - [Power and sleep], then set [Adjust my screen brightness automatically] to [On].

#### Windows 7

- ① Touch  (Start) - [Control Panel] - [Hardware and Sound] - [Power Option].
- ② Touch [Change plan settings] for the power plan currently used.
- ③ Touch [Change advanced power settings] and double-touch [Display].
- ④ Double-touch [Enable adaptive brightness], make necessary settings, and touch [OK].

Set each item to ON, and the brightness of the screen display will adjust automatically.

The ambient light sensor is located at the top of LCD.

The ambient light cannot be detected properly if this area is obstructed or dirty.

### ● Magnetic sensor

The magnetic sensor on the computer operates by detecting geomagnetism. Therefore, the magnetic sensor may not function properly and its readings may be inaccurate, especially in the following environments.

- Inside or near steel structures such as buildings or bridges
- Inside or near automobiles, or near train power lines
- Near metallic furniture or appliances
- When the AC adaptor or other peripheral devices are brought closer to the computer
- Near magnets, speakers, or other objects with strong magnetic fields

The magnetic directions indicated by the magnetic sensor may not be accurate immediately after purchase or in environments with poor magnetic fields.

In such cases, turn on the computer and move it as follows.

- ① Hold the computer so that its display side is facing the ground and level.
- ② While keeping the computer level, rotate it 90 degrees or more clockwise.
- ③ Return the computer to position ①, and rotate it 90 degrees or more counterclockwise.
- ④ Return the computer to position ①.
- ⑤ Tilt the computer 90 degrees or more to the left so that the left side of the computer tilts down.
- ⑥ Return the computer to position ①, and tilt it 90 degrees or more to the right so that the right side of the computer tilts down.

---

**CAUTION**

- Hold the computer firmly when moving it. Strong shocks from dropping the computer may result in damage.
- 

- **Tether for Stylus (Optional)**

When using the stylus with tether (optional), do not pull the tether with excessive force. The dedicated pen (optional) may hit the computer, person's body or other objects when released.

## Maintenance

If drops of water or other stains get on the surface of the LCD panel, wipe them off immediately. Failure to do so may result in staining.

**To clean the LCD panel**

Use the soft cloth. (For further information, refer to "Suggestions About Cleaning the LCD Surface" →  *Reference Manual* "Screen Input Operation".)

**To clean areas other than the LCD panel**

Wipe with a soft dry cloth such as gauze. When using detergent, dip a soft cloth in water-diluted detergent and wring it thoroughly.

---

**CAUTION**

- Do not use benzene, thinner, or rubbing alcohol since it may adversely affect the surface causing discoloration, etc. Do not use commercially-available household cleaners and cosmetics, as they may contain components harmful to the surface.
  - Do not apply water or detergent directly to the computer, since liquid may enter inside of the computer and cause malfunction or damage.
- 

Useful Information

## Dispose of Computer

<Only for model with Built-in Bridge Battery>

<For Europe and U.S.A./Canada>

**Attention Customers**

Don't remove the battery by yourself. The battery must be removed by qualified professionals. When disposing of this product, be sure to contact qualified professionals to remove the battery.

## Handling and Maintenance

### Attention Qualified professionals to remove the battery

Dispose of this product correctly in accordance with the local regulations after removing the battery as shown in the following procedure.

#### ■ Preparation

- Remove all peripherals (microSD memory card, etc.).
- Erase the stored data. (→  *Reference Manual* "Erasing Flash Memory Data")

#### CAUTION

- Never disassemble the computer except before disposal.
- Refer to page 3 for precautions when disposing of the computer.

1. Turn off the computer, and disconnect the AC adaptor.
2. Turn over the computer, remove the battery pack, and wait for about 3 minutes.
3. Remove the screws and the cover (A).

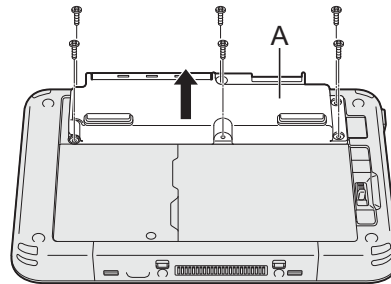

4. Pull out all cables from the connector on the cover side.

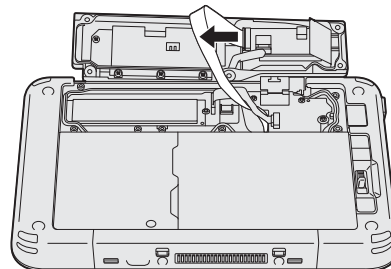

5. Pull out the battery cable and the plastic tab (B) to remove the battery.

<Model with Smart card reader/Magnetic stripe card reader/NFC reader/RFID reader>

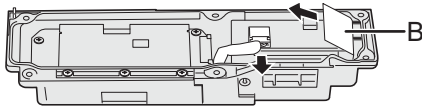

<Model without Smart card reader/Magnetic stripe card reader/NFC reader/RFID reader>

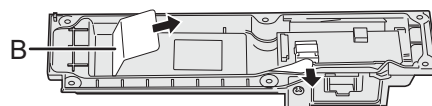

6. <Only for model with Smart card reader/Magnetic stripe card reader/NFC reader/RFID reader>

Pull out the plastic tab (C) to remove the circuit from the battery.

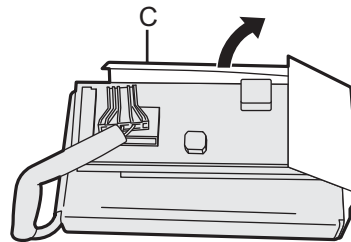

7. Insulate the connectors on the built-in battery by covering them with plastic tape, for example.

Useful Information

# Installing Software

Installing software will return the computer to the default condition. When you install the software, the flash memory data will be erased.

Back up important data to other media or an external hard disk before installation.

## CAUTION

- Do not delete the Recovery Partition on the flash memory. The disk space in the partition is not available to store data.  
To check the Recovery Partition, perform the following methods.

### ① Windows 8.1

1. Flick from the middle of the Start screen to the top, and then long touch [This PC] under “Windows System”.
2. Touch [Manage] on app bar.

### Windows 7

Touch  (Start) and long touch [Computer], then touch [Manage].

- A standard user needs to enter an administrator password.

- ② Touch [Disk Management].

## ■ Remove everything and reinstall Windows

### Preparation

- <Only for model with TPM> Connect the external keyboard.
- Remove all peripherals.
- Connect the AC adaptor and do not remove it until installation is complete.

### Windows 8.1

## 1 Perform “Remove everything and reinstall Windows”.

- ① Display “Charm”, and touch  - [Change PC settings] - [Update and recovery] - [Recovery].
- ② Touch [Get Started] under “Remove everything and reinstall Windows”.
- ③ Touch [Next].
- ④ Select the option.
  - Just remove my files  
Perform the reinstallation of the Windows in a few moments (Approximately 20 minutes).
  - Fully clean the drive  
By fully cleaning, the deleted files can not be recovered easily and the security level will be increased. The processing time will be longer (Approximately 140 minutes).

Follow the on-screen instructions.

After the reinstallation, the computer will restart.



- Do not interrupt installation, for example by turning off the computer or performing other operation.  
Otherwise installation may become unavailable as Windows may not start up or the data may be corrupted.

## 2 Perform the “First-time Operation” (→ page 27).

### NOTE

- The date and time, and the time zone may not be correct. Be sure to set them correctly.

## 3 Perform Windows Update.

### 4 <Only for model with TPM> Clear TPM.

- ① Flick from the middle of the Start screen to the top.
- ② Touch [Run] under “Windows System”, input [tpm.msc] and touch [OK].
- ③ Touch [Clear TPM...] under “Actions” on the right of the “TPM Manager on Local Computer” screen.
- ④ Touch [Restart] of the “Manage the TPM security hardware” screen.  
The computer will restart.
- ⑤ When “TPM configuration change was requested to ...” is displayed, press **F12**.
- ⑥ Touch the Desktop tile, and when “TPM is ready” appears, touch [Close].

### ■ Hard disk (Flash memory) recovery

#### Preparation

- Remove all peripherals.
- Connect the AC adaptor and do not remove it until installation is complete.

You can reinstall the OS that was pre-installed at the time of purchase (Windows 8.1 or Windows 7).

**Windows 8.1** If reinstallation using the method described in “Remove everything and reinstall Windows” above is not successful, follow the steps below.

### 1 Start the Setup Utility.

#### Windows 8.1

- ① Display “Charm”, and touch  - [Change PC settings] - [Update and recovery] - [Recovery].
- ② Touch [Restart now] under “Advanced startup”.
- ③ Touch [Troubleshoot] - [Advanced options] - [UEFI Firmware Settings] - [Restart].

#### Windows 7

Turn on the computer, and touch top left of the screen while [Panasonic] boot screen is displayed.

## Installing Software

- If the [Panasonic] boot screen is not displayed, turn on the computer while touching top left of the screen.
  - If the password is requested, enter the Supervisor Password.
- 2 Write down all of the contents of the Setup Utility and touch [Exit] and double-touch [Load Default Values].**  
At the confirmation message, touch [Yes].
  - 3 Check the [UEFI Boot] setting of the Setup Utility.**  
[UEFI Boot] should be set to as follows.  
When installing Windows 8.1 : [Enabled]  
When installing Windows 7 : [Disabled]
  - 4 Touch [Exit] and double-touch [Save Values and Reboot].**  
At the confirmation message, touch [Yes].  
Computer will restart.
  - 5 Touch top left of the screen while [Panasonic] boot screen is displayed.**  
The Setup Utility starts up.
    - If the password is requested, enter the Supervisor Password.
  - 6 Touch [Exit] and double-touch [Recovery Partition].**
  - 7**  
**Windows 8.1**  
Touch [Next] and touch [YES].  
**Windows 7**  
Touch [Reinstall Windows] and touch [Next].
  - 8 At the License Agreement screen, touch [Yes, I agree to the provisions above and wish to continue!] and touch [Next].**
  - 9 Touch [Next].**  
If the option is displayed, select the setting and touch [Next].
    - [Reinstall Windows to the System Disk to factory default.]  
Select this option when you want to install Windows to the factory default. After installation, you can create a new partition. For how to create a new partition, refer to "To change the partition structure" (→ page 29).
    - [Reinstall to the OS related partitions.]\*<sup>1</sup>  
Select this option when the flash memory has already been divided into several partitions and you want to keep the partition structure. For how to create a new partition, refer to "To change the partition structure" (→ page 29).

<sup>1</sup> This does not appear if Windows cannot be installed to the recovery partition and the area usable by Windows.
  - 10** **Windows 7** **At the confirmation message, touch [YES].**
  - 11** **Windows 7** **Select OS (32bit or 64bit) and touch [OK].**

---

**12 At the confirmation message, touch [YES].**

Installation starts according to the instructions on the screen. (It will take approximately 20 minutes.)

- Do not interrupt installation, for example by turning off the computer or performing other operation.  
Otherwise installation may become unavailable as Windows may not start up or the data may be corrupted.

**13 When Ending process screen is displayed, touch [OK] to turn off the computer.**

**14 Turn on the computer.**

- If the password is requested, enter the Supervisor Password.

**15 Perform the “First-time Operation” (→ page 27).**

---

**NOTE**

- **Windows 8.1** The date and time, and the time zone may not be correct. Be sure to set them correctly.
- 

**16 Start the Setup Utility and change the settings as necessary.**

**17 Perform Windows Update.**

**18 **Windows 8.1** <Only for model with TPM> Clear TPM (→ page 41).**

■ **Using Recovery Disc**

Use the Recovery Disc in the following conditions.

- You have forgotten the administrator password.
- Installation is not complete. The recovery partition in the flash memory may be broken.
- **Windows 7** <Only for Windows 7 downgrade model>  
To change OS from Windows 7 to Windows 8.1, or vice versa.

**NOTE**

- **Windows 7** To change OS from 32 bit to 64 bit, or vice versa, install OS using the recovery partition in the flash memory.
-

# Installing Software

## Preparation

- Prepare the following items:
  - Recovery Disc (→  *Reference Manual* “Recovery Disc Creation Utility”)
  - USB DVD drive (optional) (refer to recent catalogs and other sources for information about the products available)
- Remove all peripherals (except for the USB DVD drive).
- Connect the AC adaptor and do not remove it until installation is complete.

### 1 Connect the DVD drive to the USB port.

### 2 Start the Setup Utility.

#### Windows 8.1

- ① Display “Charm”, and touch  - [Change PC settings] - [Update and recovery] - [Recovery].
- ② Touch [Restart now] under “Advanced startup”.
- ③ Touch [Troubleshoot] - [Advanced options] - [UEFI Firmware Settings] - [Restart].

#### Windows 7

Turn on the computer, and touch top left of the screen while [Panasonic] boot screen is displayed.

- If the [Panasonic] boot screen is not displayed, turn on the computer while touching top left of the screen.
- If the password is requested, enter the Supervisor Password.

### 3 Write down all of the contents of the Setup Utility and touch [Exit] and double-touch [Load Default Values].

At the confirmation message, touch [Yes].

### 4 Check the [UEFI Boot] setting of the Setup Utility.

[UEFI Boot] should be set to as follows.

When the recovery disc for Windows 8.1 is used: [Enabled]

When the recovery disc for Windows 7 is used: [Disabled]

### 5 Set the Recovery Disc into the DVD drive.

### 6 Touch [Exit] and double-touch [Save Values and Reboot].

At the confirmation message, touch [Yes].

Computer will restart.

### 7 Touch top left of the screen while [Panasonic] boot screen is displayed.

The Setup Utility starts up.

- If the password is requested, enter the Supervisor Password.

**8 Touch [Exit] and double-touch your DVD drive in [Boot Override].**

The computer will restart.

**9 Touch [Reinstall Windows] and touch [Next].**

**10 **Windows 8.1** At the confirmation message, touch [YES].**

**11 At the License Agreement screen, touch [Yes, I agree to the provisions above and wish to continue!] and touch [Next].**

**12 Touch [Next].**

If the option is displayed, select the setting and touch [Next].

- [Reinstall Windows to the System Disk to factory default.]  
Select this option when you want to install Windows to the factory default. After installation, you can create a new partition. For how to create a new partition, refer to "To change the partition structure" (→ page 29).

- [Reinstall to the OS related partitions.]<sup>2</sup>  
Select this option when the hard disk has already been divided into several partitions and you want to keep the partition structure. For how to create a new partition, refer to "To change the partition structure" (→ page 29).

<sup>2</sup> This does not appear if Windows cannot be installed to the recovery partition and the area usable by Windows.

**13 At the confirmation message, touch [YES].**

Installation starts according to the instructions on the screen. (It will take approximately 30 - 45 minutes.)

- Do not interrupt installation, for example by turning off the computer. Otherwise installation may become unavailable as Windows may not start up or the data may be corrupted.

**14 When Ending process screen is displayed, remove the Recovery Disc and DVD Drive and then touch [OK].**

Follow the on-screen instructions.

Some models may take approximately 40 minutes.

**15 Perform the "First-time Operation" (→ page 27).**

**16 Start the Setup Utility and change the settings as necessary.**

**17 Perform Windows Update.**

**18 **Windows 8.1** <Only for model with TPM> Clear TPM (→ page 41).**

# Troubleshooting (Basic)

Follow the instructions below when a problem has occurred. There is also an advanced troubleshooting guide in the “Reference Manual”. For a software problem, refer to the software’s instruction manual. If the problem persists, contact Panasonic Technical Support (→ page 65). You can also check the computer’s status in the PC Information Viewer (→  Reference Manual “Troubleshooting (Advanced)”).

## ■ Starting Up

<p>Cannot start up. The power indicator or battery indicator is not lit.</p>	<ul style="list-style-type: none"> <li>● Connect the AC adaptor.</li> <li>● Insert a fully charged battery.</li> <li>● Remove the battery pack and the AC adaptor, then connect them again.</li> <li>● If a device is connected to the USB port, disconnect the device, or set [USB Port] or [Legacy USB Support] to [Disabled] in the [Advanced] menu of the Setup Utility.</li> <li>● Turn off the concealed mode (→  Reference Manual “Tablet Buttons”).</li> <li>● Check the [UEFI Boot] setting of the Setup Utility. [UEFI Boot] should be set to <b>Windows 8.1</b> [Enabled] / <b>Windows 7</b> [Disabled].</li> </ul>
<p>The power is turned on but “Warming up the system” appears.</p>	<ul style="list-style-type: none"> <li>● The computer is warming up before start up. Wait for the computer to start up (the maximum waiting time will be displayed on the screen). If, “Cannot warm up the system” is displayed, the computer failed to warm up and does not start. In this case, turn off the computer, leave it in an environment of 5 °C {41 °F} or higher temperature for about an hour, and then turn on the power again.</li> </ul>
<p>Cannot turn on the computer. The computer does not resume from sleep. (The battery indicator blinks green and orange alternately.)</p>	<ul style="list-style-type: none"> <li>● Leave it in an environment of 5 °C {41 °F} or higher temperature for about an hour, then turn on the power again.</li> </ul>

Troubleshooting

## ■ Starting Up

You have forgotten the password.	<ul style="list-style-type: none"><li>● Supervisor Password or User Password: Contact Panasonic Technical Support (→ page 65).</li><li>● Administrator password:<ul style="list-style-type: none"><li>• If you have a password reset disk, you can reset the administrator password. Set the disk and enter any wrong password, then follow the on-screen instructions and set a new password.</li><li>• If you do not have a password reset disk, reinstall (→ page 40) and set up Windows, and then set a new password.</li></ul></li></ul>
"Remove disks or other media. Press any key to restart" or a similar message appears.	<ul style="list-style-type: none"><li>● A floppy disk is in the drive and it does not contain system startup information. Remove the floppy disk and press any key.</li><li>● If a device is connected to the USB port, disconnect the device, or set [USB Port] or [Legacy USB Support] to [Disabled] in the [Advanced] menu of the Setup Utility.</li><li>● If the problem persists after removing the disk, it may be a flash memory failure. Contact Panasonic Technical Support (→ page 65).</li></ul>
Windows startup and operation is slow.	<ul style="list-style-type: none"><li>● Start the Setup Utility (→  <i>Reference Manual</i> "Setup Utility") to return the Setup Utility settings (excluding the passwords) to the default values. Start the Setup Utility and make the settings again. (Note that the processing speed depends on the application software, so this procedure may not make Windows faster.)</li><li>● If you installed a resident software after purchase, turn off the residence.</li></ul>



# Troubleshooting (Basic)

## ■ Starting Up

The date and time are incorrect.	<ul style="list-style-type: none"><li>● Make the correct settings.<ol style="list-style-type: none"><li>① Open the Control Panel.<ul style="list-style-type: none"><li><b>Windows 8.1</b> Flick from the middle of the Start screen to the top and touch [Control Panel] under “Windows System”.</li><li><b>Windows 7</b> Touch  (Start) - [Control Panel].</li></ul></li><li>② Touch [Clock, Language, and Region] - [Date and Time].</li></ol></li><li>● If the problem persists, the internal clock battery may need to be replaced. Contact Panasonic Technical Support (→ page 65).</li><li>● When the computer is connected to network, check the date and time of the server.</li><li>● The 2100 A.D. or later year will not be correctly recognized on this computer.</li></ul>
[Executing Battery Recalibration] screen appears.	<ul style="list-style-type: none"><li>● The Battery Recalibration was canceled before Windows was shut down last time. To start up Windows, turn off the computer by the power switch, and then turn on.</li></ul>





## ■ Starting Up

<p>[Enter Password] does not appear when resuming from sleep/hibernation.</p>	<ul style="list-style-type: none"> <li>● Select [Enabled] in [Password On Resume] in the [Security] menu of the Setup Utility (→  <i>Reference Manual</i> "Setup Utility").</li> <li>● The Windows password can be used instead of the password set in the Setup Utility.             <ol style="list-style-type: none"> <li>① Add a password.                 <ul style="list-style-type: none"> <li><b>Windows 8.1</b></li> <li>1. Display "Charm" and touch  - [Change PC settings] - [Accounts].</li> <li>2. Touch [Sign-in options], and touch [Add] under "Password".</li> <li><b>Windows 7</b></li> <li>1. Touch  (Start) - [Control Panel].</li> <li>2. Touch [User Accounts and Family Safety] - [Add or remove user accounts].</li> </ul> </li> <li>② Set up the following.                 <ul style="list-style-type: none"> <li><b>Windows 8.1</b></li> <li>1. Open the Control Panel, touch [System and Security] - [Power Options] - [Require a password on wakeup].</li> <li>2. Add a check mark for [Require a password].</li> <li><b>Windows 7</b></li> <li>1. Touch [Control Panel] - [System and Security] - [Power Option] - [Require a password when the computer wakes] and add a check mark for [Require a password].</li> </ul> </li> </ol> </li> </ul>
<p>Cannot resume.</p>	<ul style="list-style-type: none"> <li>● One of the following operations may have been carried out. Press the power switch to turn on the computer. Data not saved will be lost.             <ul style="list-style-type: none"> <li>• In sleep mode, the AC adaptor or battery pack was disconnected, or a peripheral was connected or disconnected.</li> <li>• The power switch was pressed for four seconds or longer to forcibly turn off the computer.</li> </ul> </li> <li>● An error may occur when the computer automatically enters the sleep or hibernation mode while the screensaver is active. In this case, turn off the screensaver or change the pattern of the screensaver.</li> </ul>

# Troubleshooting (Basic)

## ■ Starting Up

Other startup problems.

- Start the Setup Utility (→  *Reference Manual* “Setup Utility”) to return the Setup Utility settings (excluding the passwords) to the default values. Start the Setup Utility and make the settings again.
- Remove all peripheral devices.
- Check to see if there was a disk error.
  - ① Remove all peripheral devices including an external display.
  - ② **Windows 8.1**
    1. Flick from the middle of the Start screen to the top, and then long touch [This PC] under “Windows System”.
  - Windows 7**
    1. Touch  (Start) - [Computer].
  - ③ **Windows 8.1**

Long touch [Windows (C:)], and touch [Properties].
  - Windows 7**

Long touch [Local Disk (C:)], and touch [Properties].
  - ④ **Windows 8.1**

Touch [Tools] - [Check].
  - Windows 7**



Touch [Tools] - [Check Now...].

    - A standard user needs to enter an administrator password.
  - ⑤ Follow the on-screen instructions.
- **Windows 7**

Start the computer in Safe Mode and check the error details. When the [Panasonic] boot screen disappears<sup>\*1</sup> at startup, press and hold **F8** until the Windows Advanced Options Menu is displayed. Select the Safe Mode and press **Enter**.

<sup>\*1</sup> When [Password on boot] is set to [Enabled] in the [Security] menu of the Setup Utility, [Enter Password] appears after the [Panasonic] boot screen disappears. As soon as you enter the password and press **Enter**, press and hold **F8**.

## ■ Entering Password

<p>Even after entering the password, password input screen is displayed again.</p>	<p>&lt;Only if the external keyboard is connected&gt;</p> <ul style="list-style-type: none"> <li>● The computer may be in ten-key mode. If the NumLk indicator  lights, press <b>NumLk</b> to disable the ten-key mode, and then input.</li> <li>● The computer may be in Caps Lock mode. If the Caps Lock indicator  lights, press <b>Caps Lock</b> to disable the Caps Lock mode, and then input.</li> </ul>
<p>Cannot log on to Windows. ("The user name or password is incorrect." is displayed.)</p>	<ul style="list-style-type: none"> <li>● The user name (account name) includes an "@" mark. <ul style="list-style-type: none"> <li>- If another user account name exists: Log on to Windows using another user account name, and delete the account name that includes "@". Then create a new account name.</li> <li>- If no other account name exists: You need to reinstall Windows (→ page 40).</li> </ul> </li> </ul>

## ■ Shutting down

<p>Windows does not shut down.</p>	<ul style="list-style-type: none"> <li>● Remove the USB device.</li> <li>● Wait one or two minutes. It is not a malfunction.</li> </ul>
------------------------------------	-----------------------------------------------------------------------------------------------------------------------------------------

## ■ Display

<p>No display.</p>	<ul style="list-style-type: none"> <li>● The display is turned off by the power-saving function. Touch the screen.</li> <li>● The computer entered sleep or hibernation by the power-saving function. To resume, press the power switch.</li> <li>● When using an external display, <ul style="list-style-type: none"> <li>• Check the cable connection.</li> <li>• Turn on the display.</li> <li>• Check the settings of external display.</li> </ul> </li> </ul>
<p>The screen is dark.</p>	<ul style="list-style-type: none"> <li>● The screen is darker when the AC adaptor is not connected. Open the Dashboard for Panasonic PC and adjust the brightness. As you increase the brightness, battery consumption increases. You can separately set the brightness for when the AC adaptor is connected and when not connected.</li> <li>● Turn off the concealed mode (→  <i>Reference Manual</i> "Key Combination").</li> </ul>

# Troubleshooting (Basic)

## ■ Display

The screen is disordered.	<ul style="list-style-type: none"> <li>● Changing the number of display colors and resolution may affect the screen. Restart the computer.</li> <li>● Connecting/disconnecting an external display may affect the screen. Restart the computer. Under factory default settings, the brightness of the display screen will adjust automatically based on the ambient light detected by the ambient light sensor. You can adjust the settings for this sensor (→ page 35).</li> </ul>
There are red, green, or blue dots on the screen, or there is unevenness in colors and brightness on the screen.	<p>The following are not malfunctions.</p> <ul style="list-style-type: none"> <li>● Although advanced high-precision technologies are used in the production of color LCD screens, 0.002% or less of the picture elements may be dark or remain constantly lit (more than 99.998% of elements function properly).</li> <li>● Due to the natural characteristics of LCD screens, you may notice unevenness in colors and brightness depending on your angle of view. Hues may also vary by product.</li> </ul>
During Simultaneous display, one of the screens becomes disordered.	<ul style="list-style-type: none"> <li>● When using the Extended Desktop, use the same display colors for the external display as those used by the LCD. If you continue to experience problems, try changing the display. Long touch on the desktop, and touch [Graphics Properties...] - [Display].</li> <li>● Simultaneous display cannot be used until Windows startup is complete (during Setup Utility, etc.).</li> </ul>
The external display does not work normally.	<ul style="list-style-type: none"> <li>● If the external display does not support the power saving function, it may not work normally when the computer enters the power saving mode. Turn off the external display.</li> </ul>
Cannot rotate the display.	<ul style="list-style-type: none"> <li>● The application program currently running may not support the image rotation. Quit the program, and then try to rotate the image. This can ameliorate the status.</li> <li>● When the automatic rotation is off, screen display does not rotate automatically.</li> </ul>

Troubleshooting

## ■ Screen

The pointer does not work.	<ul style="list-style-type: none"> <li>● When using the external mouse, connect it correctly.</li> <li>● When using the external keyboard, restart the computer using the keyboard.</li> <li>● If the computer does not respond to keyboard commands, read "No response" (→ page 54).</li> </ul>
----------------------------	--------------------------------------------------------------------------------------------------------------------------------------------------------------------------------------------------------------------------------------------------------------------------------------------------

## ■ Screen

Cannot point the correct position using the dedicated pen (optional).

- Perform the screen calibration (→  *Reference Manual* “Screen Input Operation” ).
- Use the optional pen.
- On the Windows logon screen or the Welcome screen, you may not be able to point the correct position using the pen (optional). Use the external keyboard or the external mouse to log on.



## ■ On-screen Document

**Windows 7**  
The document of PDF format is not displayed.

- Install Adobe Reader.
  - ① Log on to Windows as an administrator.
  - ② Touch  (Start) and input “c:\util\reader\en\Pinstall.bat” in [Search Programs and files] then press **Enter**.
  - ③ Update Adobe Reader to its latest version.  
If your computer is connected to the internet, start up Adobe Reader and touch [Help] - [Check for Updates...].

# Troubleshooting (Basic)

## ■ Others

No response.	<ul style="list-style-type: none"><li>● Open Task Manager and close the software application that is not responding.</li><li>● An input screen (e.g., password input screen at startup) may be hidden behind another window. Touch the application icons at the bottom of the screen to check.</li><li>● Press the power switch for four seconds or longer to shut down the computer, and then press the power switch to turn it on. If the application program does not work normally, uninstall and reinstall the program. To uninstall,<ol style="list-style-type: none"><li>① Open the Control Panel. <b>Windows 8.1</b> Flick from the middle of the Start screen to the top and touch [Control Panel] under “Windows System”. <b>Windows 7</b> Touch  (Start) - [Control Panel].</li><li>② Touch [Program] - [Uninstall a program].</li></ol></li></ul>
Cannot connect to a network.	<ul style="list-style-type: none"><li>● Set the device ([Wireless LAN] / [Bluetooth] / [Wireless WAN] of [Wireless Configuration]) to [Enabled] in the [Advanced] menu of the Setup Utility (Wireless Configuration). <b>Windows 8.1</b></li><li>● Display “Charm”, and touch  - [Change PC Settings] - [Network]. Set [Airplane mode] to [Off], and then; set [Wi-Fi] to [On] (for wireless LAN). set [Mobile broadband] to [On] (for wireless WAN). set [GPS] to [On] (for wireless WAN). set [Bluetooth] to [On] (for Bluetooth).</li></ul>

# LIMITED USE LICENSE AGREEMENT

THE SOFTWARE PROGRAM(S) ("PROGRAMS") FURNISHED WITH THIS PANASONIC PRODUCT ("PRODUCT") ARE LICENSED ONLY TO THE END-USER ("YOU"), AND MAY BE USED BY YOU ONLY IN ACCORDANCE WITH THE LICENSE TERMS DESCRIBED BELOW. YOUR USE OF THE PROGRAMS SHALL BE CONCLUSIVELY DEEMED TO CONSTITUTE YOUR ACCEPTANCE OF THE TERMS OF THIS LICENSE.

Panasonic Corporation has developed or otherwise obtained the Programs and hereby licenses their use to you. You assume sole responsibility for the selection of the Product (including the associated Programs) to achieve your intended results, and for the installation, use and results obtained therefrom.

## LICENSE

- A. Panasonic Corporation hereby grants you a personal, non-transferable and non-exclusive right and license to use the Programs in accordance with the terms and conditions stated in this Agreement. You acknowledge that you are receiving only a LIMITED LICENSE TO USE the Programs and related documentation and that you shall obtain no title, ownership nor any other rights in or to the Programs and related documentation nor in or to the algorithms, concepts, designs and ideas represented by or incorporated in the Programs and related documentation, all of which title, ownership and rights shall remain with Panasonic Corporation or its suppliers.
- B. You may use the Programs only on the single Product which was accompanied by the Programs.
- C. You and your employees and agents are required to protect the confidentiality of the Programs. You may not distribute or otherwise make the Programs or related documentation available to any third party, by time-sharing or otherwise, without the prior written consent of Panasonic Corporation.
- D. You may not copy or reproduce, or permit to be copied or reproduced, the Programs or related documentation for any purpose, except that you may make one (1) copy of the Programs for backup purposes only in support of your use of the Programs on the single Product which was accompanied by the Programs. You shall not modify, or attempt to modify, the Programs.
- E. You may transfer the Programs and license them to another party only in connection with your transfer of the single Product which was accompanied by the Programs to such other party. At the time of such a transfer, you must also transfer all copies, whether in printed or machine readable form, of every Program, and the related documentation, to the same party or destroy any such copies not so transferred.

Appendix

# LIMITED USE LICENSE AGREEMENT

- F. You may not remove any copyright, trademark or other notice or product identification from the Programs and you must reproduce and include any such notice or product identification on any copy of any Program.

YOU MAY NOT REVERSE ASSEMBLE, REVERSE COMPILE, OR MECHANICALLY OR ELECTRONICALLY TRACE THE PROGRAMS, OR ANY COPY THEREOF, IN WHOLE OR IN PART.

YOU MAY NOT USE, COPY, MODIFY, ALTER, OR TRANSFER THE PROGRAMS OR ANY COPY THEREOF, IN WHOLE OR IN PART, EXCEPT AS EXPRESSLY PROVIDED IN THE LICENSE.

IF YOU TRANSFER POSSESSION OF ANY COPY OF ANY PROGRAM TO ANOTHER PARTY, EXCEPT AS PERMITTED IN PARAGRAPH E ABOVE, YOUR LICENSE IS AUTOMATICALLY TERMINATED.

## TERM

This license is effective only for so long as you own or lease the Product, unless earlier terminated. You may terminate this license at any time by destroying, at your expense, the Programs and related documentation together with all copies thereof in any form. This license will also terminate effective immediately upon occurrence of the conditions thereof set forth elsewhere in this Agreement, or if you fail to comply with any term or condition contained herein. Upon any such termination, you agree to destroy, at your expense, the Programs and related documentation together with all copies thereof in any form.

YOU ACKNOWLEDGE THAT YOU HAVE READ THIS AGREEMENT, UNDERSTAND IT AND AGREE TO BE BOUND BY ITS TERMS AND CONDITIONS. YOU FURTHER AGREE THAT IT IS THE COMPLETE AND EXCLUSIVE STATEMENT OF THE AGREEMENT BETWEEN US, WHICH SUPERSEDES ANY PROPOSAL OR PRIOR AGREEMENT, ORAL OR WRITTEN, AND ANY OTHER COMMUNICATIONS BETWEEN US, RELATING TO THE SUBJECT MATTER OF THIS AGREEMENT.

### Appendix

#### **GOVERNMENT RESTRICTED RIGHTS.**

The Software is provided with "RESTRICTED RIGHTS." Use duplication or disclosure by the government is subject to restrictions as set forth in FAR52.227-14 and DFAR252. 227-7013 et seq. or their successors.

Use of the Software by the government constitutes acknowledgement of Intel's proprietary rights therein.

Contractor or Manufacturer is Intel Corporation, 2200 Mission College Blvd., Santa Clara, CA 95052.



# Contrat de licence d'usage limité

Le(s) logiciel(s) (les "Logiciels") fournis avec ce produit Panasonic (le "Produit") sont exclusivement concédés en licence à l'utilisateur ultime ("vous"), et ils ne peuvent être utilisés que conformément aux clauses contractuelles cidessous. En utilisant les logiciels, vous vous engagez de manière définitive à respecter les termes, clauses et conditions des présentes.

Panasonic Corporation a mis au point ou obtenu les Logiciels et vous en concède l'utilisation par les présentes. Vous assumez l'entière responsabilité du choix de ce Produit (y compris des Logiciels associés) pour obtenir les résultats escomptés, ainsi que de l'installation, de l'utilisation et des résultats obtenus.

## Licence

- A. Panasonic Corporation vous octroie par les présentes le droit et la licence personnels, non cessibles et non exclusifs d'utiliser les Logiciels conformément aux termes, clauses et conditions de ce contrat. Vous reconnaissez ne recevoir qu'un droit limité d'utiliser les Logiciels et la documentation les accompagnant et vous vous engagez à n'obtenir aucun droit de titre, propriété ni aucun autre droit vis-à-vis des Logiciels et de la documentation les accompagnant ni vis-à-vis des algorithmes, concepts, dessins, configurations et idées représentés par ou incorporés dans les Logiciels et la documentation les accompagnant, dont les titres, propriété et droits resteront tous à Panasonic Corporation ou à leurs propriétaires.
- B. Vous ne pouvez utiliser les Logiciels que sur le Produit unique qui est accompagné par les Logiciels.
- C. Vous et vos employés ou agents êtes requis de protéger la confidentialité des Logiciels. Vous ne pouvez ni distribuer ni mettre les Logiciels et la documentation les accompagnant à la disposition d'un tiers, par partage de temps ou de quelque autre manière que ce soit, sans l'autorisation écrite préalable de Panasonic Corporation.
- D. Vous ne pouvez ni copier ni reproduire ni permettre la copie ni la reproduction des Logiciels ni de la documentation les accompagnant pour quelque fin que ce soit, à l'exception d'une (1) copie des Logiciels à des fins de sauvegarde uniquement pour soutenir votre utilisation des Logiciels sur le Produit unique qui est accompagné par les Logiciels. Vous ne pouvez ni modifier ni tenter de modifier les Logiciels.

Appendix

## Contrat de licence d'usage limité

- E. Vous ne pouvez céder les Logiciels et en octroyer la licence à une autre partie qu'en rapport avec votre cession du Produit unique qui est accompagné par les Logiciels à cette autre partie. Au moment de cette cession, vous devez céder également toutes les copies, que ce soit sous forme imprimée ou lisible par la machine, de tous les Logiciels ainsi que de la documentation les accompagnant, à la même partie ou détruire les copies non cédées.
- F. Vous ne pouvez retirer aucune marque de droits d'auteur, marque de commerce ou autre ni aucune identification de produit des Logiciels et vous devez reproduire et inclure toutes ces notices ou identifications de produit sur toutes les copies des Logiciels.

Vous ne pouvez assembler en sens inverse, compiler en sens inverse ni retracer les Logiciels ni aucune de leurs copies, de façon électronique ou mécanique, en tout ou en partie.

Vous ne pouvez utiliser, copier, modifier, altérer ni céder les Logiciels ni aucune de leurs copies, en tout ou en partie, à l'exception de ce qui est expressément stipulé dans ce contrat.

Si vous cédez la possession de toute copie ou de tout Logiciel à une autre partie, à l'exception de ce qui est autorisé au paragraphe E ci-dessus, votre licence est automatiquement résiliée.

### Termes, clauses et conditions

Cette licence n'est effective que pour la durée de possession ou de crédit-bail du Produit, à moins d'une résiliation antérieure. Vous pouvez résilier cette licence à tout moment en détruisant, à vos frais, les Logiciels et la documentation les accompagnant avec toutes leurs copies, sous quelque forme que ce soit. Cette licence sera également résiliée, avec application immédiate, si les conditions de résiliation définies ailleurs dans ce contrat se sont réalisées ou si vous ne respectez pas les termes, clauses et conditions qui y sont contenues. Au moment de la résiliation, vous acceptez de détruire, à vos frais, les Logiciels et la documentation les accompagnant avec toutes leurs copies, sous quelque forme que ce soit.

### Appendix

Vous reconnaissez avoir lu ce contrat, en avoir compris toute la substance et avoir accepté de respecter ses termes, clauses et conditions. Vous reconnaissez en outre qu'ils sont la description complète et exclusive du contrat conclu entre nous, contrat qui remplace et annule toute proposition ou contrat précédent, écrit ou oral, et toute autre communication entre nous, relativement à l'objet du présent contrat.

# Specifications

This page provides the specifications for the basic model.  
The model number is different according to the unit configuration.

- To check the model number:  
Check the bottom of the computer or the box the computer came in at the time of purchase.
- To check CPU speed, memory size and the flash memory drive size:  
Run the Setup Utility (→  *Reference Manual* "Setup Utility") and select [Information] menu.  
[Processor Speed]: CPU speed, [Memory Size]: Memory size, [Hard Disk]: Flash memory drive size

## ■ Main Specifications

Model No.	FZ-M1CCAAXBM / FZ-M1CCAAXCM
CPU	Intel® Core™ i5-4302Y Processor (3 MB <sup>*1</sup> cache, up to 2.30 GHz with Intel® Turbo Boost Technology)
Chipset	CPU embedded
Video controller	Intel® HD Graphics (CPU embedded)
Memory <sup>*1*2</sup>	4 GB
Video Memory <sup>*1*3</sup>	<p><b>Windows 8.1</b> UMA 1792 MB Max. (When memory is either 4 GB or 8 GB)</p> <p><b>Windows 7</b> UMA &lt;32-bit&gt; 1553 MB Max. &lt;64-bit&gt; 1696 MB Max. (When memory is either 4 GB or 8 GB)</p>
Storage <sup>*4</sup>	<p>Flash memory drive : 128 GB</p> <p><b>Windows 8.1</b> Approx. 14 GB is used as a partition with HDD recovery tools. (Users cannot use this partition.) Approx. 1 GB is used as a partition with system tools. (Users cannot use this partition.)</p> <p><b>Windows 7</b> &lt;Only for Windows 7 downgrade model&gt; Approx. 25 GB is used as a partition with HDD recovery tools. (Users cannot use this partition.) Approx. 300 MB is used as a partition with system tools. (Users cannot use this partition.)</p>
Display Method	7.0 WXGA type (1280 × 800 dots)
Internal LCD <sup>*5</sup>	Max. 16,777,216 colors (1280 × 800 dots)
Wireless LAN <sup>*6</sup>	Intel® Dual Band Wireless-AC 7260 (→ page 62)
Bluetooth <sup>*7</sup>	→ page 63
Wireless WAN <sup>*8</sup>	(Optional) Sierra™ Wireless High-speed module

# Specifications

## ■ Main Specifications

Model No.	FZ-M1CCAAXB / FZ-M1CCAAXCM	
LAN	(Optional) IEEE 802.3 10Base-T/IEEE 802.3u 100Base-TX	
Sound	WAVE and MIDI playback, Intel® High Definition Audio subsystem support, Monaural speaker	
Security Chip	TPM (TCG V 1.2 compliant) <sup>9</sup>	
Camera <sup>10</sup>	Front	1920 × 1080 dots, 30 fps (Video) / 1920 × 1080 dots (Still), Dual Microphone
	Rear	2048 × 1536 dots, 15 fps (Video) / 2592 × 1944 dots (Still) / With camera light
Sensor	Ambient light sensor	Equipped
	Magnetic sensor	
	Gyro sensor	
	Acceleration sensor	
Card Slot	microSD Memory Card <sup>11</sup>	microSDXC compatible
	microSIM Card Slot <sup>12</sup>	(Optional) × 1
Smart Card	(Optional) × 1	
Magnetic Stripe Card Reader	(Optional) × 1	
NFC Reader	(Optional) × 1	
Barcode Reader	(Optional) × 1	
Interface	USB port 3.0 × 1 <sup>13</sup> , Serial Port (Optional, Dsub 9-pin male) <sup>14</sup> , LAN port (Optional, RJ-45), Expansion Bus Connector, Headset Jack (Miniature jack, 3.5 DIA, CTIA standard / Headphone: Impedance 32 Ω, Output Power 4 mW × 2, Stereo / Microphone: Monaural Input)	
Touchscreen	10 Finger touch (Capacitive)	
Power Supply	AC adaptor or Battery pack	
AC Adaptor <sup>15</sup>	Input: 100 V to 240 V AC, 50 Hz/60 Hz, Output: 16 V DC, 3.75 A	
Battery Pack	Li-ion 7.2 V, 3220 mAh (typ.), 3050 mAh (min.) (with FZ-VZSU94W) Li-ion 7.2 V, 7100 mAh (typ.), 6800 mAh (min.) (with FZ-VZSU95W (Optional))	

## ■ Main Specifications

Model No.		FZ-M1CCAAXB / FZ-M1CCAAXCM	
Operating Time <sup>*16</sup>		Approx. 8 hours (with FZ-VZSU94W) Approx. 16 hours (with FZ-VZSU95W (Optional))	
Charging Time <sup>*17</sup>		Approx. 2.5 hours (with FZ-VZSU94W) Approx. 4.5 hours (with FZ-VZSU95W (Optional))	
Built-in bridge battery (not replaceable)		(Optional) Li-Polymer 7.4 V, 500 mAh (typ.), 490 mAh (min.)	
Power Consumption <sup>*18</sup>		Approx. 15 W <sup>*19</sup> / Approx. 60 W (maximum when recharging in the ON state)	
Physical Dimensions (W × D × H) (excluding projecting parts)		202.7 mm × 132 mm × 18 mm {8.0 " × 5.2 " × 0.7 "}	
Weight		Approx. 0.54 kg {Approx. 1.2 lb.} (with FZ-VZSU94W, excluding the optional devices)	
Environment	Operating	Temperature	-10 °C to 50 °C {14 °F to 122 °F} (IEC60068-2-1, 2) <sup>*20</sup>
		Humidity	30% to 80% RH (No condensation)
	Storage	Temperature	-20 °C to 60 °C {-4 °F to 140 °F}
		Humidity	30% to 90% RH (No condensation)

## ■ Software

Base OS	<b>Windows 8.1</b> Windows <sup>®</sup> 8.1 Pro 64-bit <b>Windows 7</b> Windows <sup>®</sup> 7 Professional 32-bit Service Pack 1 / Windows <sup>®</sup> 7 Professional 64-bit Service Pack 1
Installed OS <sup>*21</sup>	<b>Windows 8.1</b> Windows <sup>®</sup> 8.1 Pro 64-bit <b>Windows 7</b> <Only for Windows 7 downgrade model> Windows <sup>®</sup> 7 Professional 32-bit Service Pack 1 (downgraded to Windows <sup>®</sup> 7) <sup>*22</sup> / Windows <sup>®</sup> 7 Professional 64-bit Service Pack 1 (downgraded to Windows <sup>®</sup> 7) <sup>*22</sup>

# Specifications

## ■ Software

Pre-installed Software <sup>*21</sup>	<p>Adobe Reader, PC Information Viewer, Battery Recalibration Utility, Hand Writing Utility, Infineon TPM Professional Package<sup>*9 *23</sup>, Dashboard for Panasonic PC, Recovery Disc Creation Utility, Power Plan Extension Utility, Camera Utility, Intel® PROSet/Wireless Software, Intel® PROSet/Wireless Software for Bluetooth® Technology, Microsoft Office Trial<sup>*24</sup>, Wireless Manager 6.0<sup>*23 *25</sup>, Touch Operation Help Utility<sup>*23</sup>, Touch Screen Mode Setting Utility, Display Rotation Tool, Display Helper, Barcode Setting Utility<sup>*26</sup>, Barcode Configuration Utility<sup>*26</sup>, Barcode HID Language Setting Utility<sup>*26</sup>, Barcode HID Mode Setting Utility<sup>*26</sup>, GPS Viewer<sup>*27</sup></p> <p><b>Windows 8.1</b> Wireless Toolbox, Camera for Panasonic PC</p> <p><b>Windows 7</b> Wireless Switch Utility, Wireless Connection Disable Utility<sup>*23</sup>, Quick Boot Manager, Software Keyboard</p> <p>Aptio Setup Utility, PC-Diagnostic Utility, Hard Disk Data Erase Utility<sup>*28</sup></p>
---------------------------------------	-----------------------------------------------------------------------------------------------------------------------------------------------------------------------------------------------------------------------------------------------------------------------------------------------------------------------------------------------------------------------------------------------------------------------------------------------------------------------------------------------------------------------------------------------------------------------------------------------------------------------------------------------------------------------------------------------------------------------------------------------------------------------------------------------------------------------------------------------------------------------------------------------------------------------------------------------------------------------------------------------------------------------------------------------------------------------------------------------------

## ■ Wireless LAN

Data Transfer Rates <sup>*29</sup>	<p>IEEE802.11a : 54 Mbps          IEEE802.11b : 11 Mbps          IEEE802.11g : 54 Mbps          IEEE802.11n : HT20 : 150 Mbps                            HT40 : 300 Mbps          IEEE802.11ac : VHT80 : 866.7 Mbps                            VHT40 : 433.3 Mbps</p>
Standards Supported	IEEE802.11a / IEEE802.11b / IEEE802.11g / IEEE802.11n / IEEE802.11ac
Transmission method	OFDM system, DSSS system
Wireless Channels Used	<p>IEEE802.11ac / IEEE802.11a / IEEE802.11n :          Channels 36/40/44/48/52/56/60/64/100/104/108/          112/116/120/124/128/132/136/140/149/153/157/          161/165</p> <p>IEEE802.11b / IEEE802.11g / IEEE802.11n : Channels 1 to 11</p>
RF Frequency Band	<p>2.4 GHz Band : 2.412 GHz - 2.462 GHz          5 GHz Band : 5.18 GHz - 5.32 GHz, 5.5 GHz - 5.7 GHz,          5.745 GHz - 5.825 GHz</p>

## ■ Bluetooth<sup>\*7</sup>

Bluetooth Version	4.0
	Classic mode / Low Energy mode
Transmission method	FHSS system
Wireless Channels Used	Channels 1 to 79 / Channels 0 to 39
RF Frequency Band	2.402 GHz - 2.480 GHz

<sup>\*1</sup> 1 MB = 1,048,576 bytes/1 GB = 1,073,741,824 bytes

<sup>\*2</sup> Memory size of the factory default depends on the model.

You can physically expand the memory up to 8 GB, but the total amount of usable memory available will be less depending on the actual system configuration.

<sup>\*3</sup> A segment of the main memory is allotted automatically depending on the computer's operating status. The size of the Video Memory cannot be set by the user.

<sup>\*4</sup> 1 MB = 1,000,000 bytes / 1 GB = 1,000,000,000 bytes. Your operating system or some application software will report as fewer GB.

<sup>\*5</sup> Depending on the OS settings.

<sup>\*6</sup> Only for model with wireless LAN.

<sup>\*7</sup> Only for model with Bluetooth.

Does not guarantee operation of all Bluetooth peripherals.

<sup>\*8</sup> Only for model with wireless WAN.

The specifications may differ depending on the models.

<sup>\*9</sup> For information on TPM, **Windows 8.1** on the Start screen, touch the [Manual Selector] tile, and select "Installation Manual for Trusted Platform Module (TPM)" / **Windows 7** Double-touch [Manual Selector] on the desktop, and select "Installation Manual for Trusted Platform Module (TPM)".

<sup>\*10</sup> Only for model with camera. Depending on the specification of application software, the following cases may occur. In these cases, select a smaller resolution.

- Cannot select a large resolution.
- When selecting a large resolution, an error occurs.



<sup>\*11</sup> Operation has been tested and confirmed using Panasonic microSD Memory Card with a capacity of up to 2 GB and Panasonic microSDHC Memory Card with a capacity of up to 32 GB.

Operation on other microSD equipment is not guaranteed.

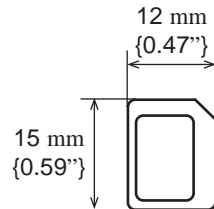
<sup>\*12</sup> Only for model with wireless WAN. The slot accepts microSIM Cards.



# Specifications

- <sup>\*13</sup> Does not guarantee operation of all USB-compatible peripherals.
- <sup>\*14</sup> Only for model with serial port. To connect the serial device, the serial conversion cable (included) is necessary.
- <sup>\*15</sup> <Only for North America>  
The AC adaptor is compatible with power sources up to 240 V AC adaptor.  
This computer is supplied with a 125 V AC compatible AC cord. 20-M-1-1
- <sup>\*16</sup> Measured at LCD brightness: 60 cd/m<sup>2</sup>  
Varies depending on the usage conditions, or when an optional device is attached.
- <sup>\*17</sup> Varies depending on the usage conditions.
- <sup>\*18</sup> Approx. 0.5 W when the battery pack is fully charged (or not being charged) and the computer is OFF.  
<When using with 115 V AC>  
Even when the AC adaptor is not connected to the computer, power is consumed (Max. 0.3 W) simply by having the AC adaptor plugged into an AC outlet.
- <sup>\*19</sup> Rated power consumption 23-E-1
- <sup>\*20</sup> Do not expose the skin to this product when using the product in a hot or cold environment. (→ page 7)  
When using in hot or cold environment, some peripherals and battery pack may fail to work properly. Check the operation environment of the peripherals.  
Using this product continuously in a hot environment will shorten the product life. Avoid use in these types of environments.  
When using in low temperature environment, startup may become slow or battery operation time may become short. The computer consumes power when the hard disk is warming up during startup. Therefore, if you are using battery power and the remaining power is low, the computer may not start up.
- <sup>\*21</sup> Operations of this computer are not guaranteed except for the pre-installed OS and the OS which is installed by using the hard disk recovery and the recovery disc.
- <sup>\*22</sup> This system is preinstalled with Windows<sup>®</sup> 7 Professional software and also comes with a license for Windows 8.1 Pro software. You may only use one version of the Windows software at a time. Switching between versions will require you to uninstall one version and install the other version.
- <sup>\*23</sup> Must be installed before use.
- <sup>\*24</sup> To continue using this software after the end of the trial, purchase a license by following the on-screen instructions.
- <sup>\*25</sup> For information on Wireless Manager, refer to the supplementary instructions by the following procedure.
- Windows 8.1**
- ① Touch  on the Start screen.
  - ② Touch [Run] under “Windows System”, input “c:\util\w\prjct\Supplementary Instructions.pdf” then touch [OK].
- Windows 7** Touch  (Start) and input “c:\util\w\prjct\Supplementary Instructions.pdf” in [Search programs and files] and press **Enter**.
- <sup>\*26</sup> Only for model with barcode reader.
- <sup>\*27</sup> Only for model with GPS or wireless WAN.
- <sup>\*28</sup> Perform on the recovery disc. **Windows 7** Alternatively perform on the Hard disk recovery.
- <sup>\*29</sup> Maximum data transfer rates of wireless LAN standards.  
Actual speeds may differ.



# LIMITED WARRANTY

## For U.S.A.

Panasonic System Communications Company of North America (PSCNA)  
Computer Products - Worldwide Warranties

### **Section 1: Limited Warranty - Hardware**

PSCNA, referred hereafter as "Panasonic" will repair the products listed below with new or rebuilt parts, free of charge in a Global Panasonic designated service location for the period specified below from the date of original purchase in the event of a defect in materials or workmanship. These warranties are extended solely to the original purchaser. A purchase receipt or other proof of date of original purchase will be required before warranty performance is rendered.

- Laptop PC (CF-##) – 3 Years
- Tablet PC (FZ-##) – 3 Years
- Ultra-Mobile (CF-U#/CF-H# Series) – 3 Years
- PDR - LCD & Keyboard Assembly – 3 Years

### **Battery Warranty**

Batteries supplied with the product are covered under the warranty for one (1) year from date of purchase, except as excluded in Section 3. Batteries purchased separately are covered under the warranty for one (1) year from the date of purchase. A replacement battery furnished under the product warranty is covered for the remaining period of the one year warranty on the original or purchased battery.

### **Optional: Panasonic "Protection Plus" Warranty**

Any unit for which the Panasonic "Protection Plus" warranty has been purchased will receive additional coverage for any failure that occurs due to accidental damage. All other terms and conditions of the standard warranty apply and this additional coverage will exist for the duration of the standard warranty period of the unit. If an extended Protection Plus warranty program is purchased, coverage is extended to the end of the last year of extended coverage purchased.

This warranty does not cover failures or defects that are caused by fire, intentional acts, loss, theft, improper maintenance, modification or service by anyone other than the Panasonic National Service Center or a Panasonic Authorized Service Provider, or damage that is attributable to acts of God. Cosmetic damage that does not affect functionality is not covered. Cosmetic damage on units with hardware failures will be repaired in accordance with the warranty terms. This warranty is extended solely to the original purchaser on the unit serial number for which it was purchased. Complete unit replacement fulfills the full obligation and is at the discretion of Panasonic and is limited to once during the coverage term. Maximum benefit is limited to one replacement per coverage year of the Motherboard, LCD, Storage Drive, and Keyboard.

Appendix

# LIMITED WARRANTY

## Wireless Module Warranty

Panasonic approved wireless modems installed in Panasonic brand computers and integrated by Panasonic or an Authorized Panasonic Wireless Integrator are covered under the warranty for the remaining warranty period of the device in which the modem is installed. For devices with less than three (3) months remaining on the unit warranty, the wireless modem will be covered for a period of three (3) months from the date of installation of the modem, covering only modem replacement or modem installation related issues.

All modems must be approved by the wireless carrier prior to use. Any use or attempted use of a wireless modem not approved and activated by the carrier for use on their network is strictly prohibited and is not sanctioned or warranted by Panasonic and may result in legal action. In addition, all modems must be approved by Panasonic as compatible with the device hardware before installation or use.

Panasonic's sole responsibility for the warranty or technical support of the software required to install or operate the modem is defined in Section 2 (Limited Software Warranty). Any attempted software installation by anyone other than a Panasonic Authorized Wireless Integrator is not covered under warranty and may result in service charges to re-image or replace the hard drive.

Installation or attempted installation by any party other than Panasonic or an Authorized Panasonic Wireless Integrator is strictly not covered under the warranty and may void the computer warranty if damage results.

## Options and Accessories Warranties

The below listed Panasonic brand or supplied options and accessories are covered under this limited warranty for the period specified from the date of purchase or as specifically stated:

- AC Adaptor / Power Cord – 3 Years
- Memory Expansion Card (Panasonic Brand) – 3 Years
- Antenna Pass-through Cable – 3 Years
- Backlit or Full-sized keyboard – 3 Years or assumes warranty of the unit in which it is installed
- Integrated Panasonic supplied options and kits including, but not limited to Wireless Modems, Media Bay Drives (Floppy, CD, DVD, Combo), Camera, GPS, Bluetooth, Smartcard Reader, Magnetic Card Reader, Barcode Scanner, and Fingerprint Reader - 3 Years or assumes warranty period of the unit in which it is installed provided the integration was performed by Panasonic or an Authorized Integrator.
- Hard Drive / Solid State Drive (Internal) – 3 Years
- Separately purchased 2nd Hard Drive – 1 Year
- External USB Drives (CD / DVD / Floppy / Hard Drive) – 1 Year
- Optional Battery – 1 Year
- Battery Charger / Multi-Bay Battery Charger – 1 Year
- Stylus Pens, Digitizer & Standard – 90 Days (physical damage excluded)

---

## **Section 2 - Limited Warranty - Software**

Panasonic warrants to you only that the disk(s) or other media on which the Programs are furnished will be free from defects in material and workmanship under normal use for a period of sixty (60) days from the date of delivery thereof to you, as evidenced by your purchase receipt.

This is the only warranty Panasonic makes to you. Panasonic does not warrant that the functions contained in the Programs will meet your requirements or that the operation of the Programs will be uninterrupted or error free. Panasonic shall have no obligation for any defects in the disk(s) or other media on which the Programs are furnished resulting from your storage thereof, or for defects that have been caused by operation of the disk(s) or other media

Panasonic's entire liability and your exclusive remedy under this warranty shall be limited to the replacement, in the United States or other Panasonic designated location, of any defective disk or other media which is returned to Panasonic's Authorized Service Center, together with a copy of the purchase receipt, within the aforesaid warranty period.

## **Section 3 - Limited Warranty Exclusions - Specifically excluded from the warranty are:**

- All consumable items; such as screen protection films, logo badges, labels, cleaning cloths, carry cases, manuals, cables, straps, belts, holsters, tethers, and harnesses and any other options and accessories not listed above or covered under a separate warranty.
- Failures related to the product operating system, hard drive or solid state drive image, software setup, software program, virus, other program(s) or file(s) on any drive or in any computer memory location.
- Failures due to BIOS settings or changes, as well as any cosmetic or physical damage to the unit.
- Any unit or device with a missing or altered model number or serial number label
- Cosmetic damage or any damage which occurs in shipment
- Failures which are caused by products not supplied by Panasonic
- Failures which result from alteration, accident, misuse, introduction of liquid or other foreign matter into the unit, abuse, neglect, installation, maladjustment of consumer controls, improper maintenance or modification, use not in accordance with product use instructions
- Failures due to service by anyone other than a Panasonic Authorized Service Provider
- Failures caused by improper installation of options or accessories or due to integration by any company other than Panasonic or a Panasonic Authorized Integrator
- Damage, failure, or loss due to the unit being stolen, lost, misplaced, or used by anyone other than the original purchaser
- Damage that is attributable to acts of God

## LIMITED WARRANTY

This limited warranty only covers failures due to defects in materials or workmanship which occur during normal use. If a unit is sent to a Panasonic Authorized Service Center and no hardware failure is found, the customer will be billed for labor to correct a software issue or reimage the hard drive plus shipping and applicable administrative fees at the current rates set by the service provider.

THIS PRODUCT IS NOT INTENDED FOR USE AS OR PART OF NUCLEAR EQUIPMENT/SYSTEMS, AIR TRAFFIC CONTROL EQUIPMENT/SYSTEMS, OR AIRCRAFT COCKPIT EQUIPMENT/SYSTEMS<sup>\*1</sup>. PANASONIC WILL NOT BE RESPONSIBLE FOR ANY LIABILITY RESULTING FROM THE USE OF THIS PRODUCT ARISING OUT OF THE FOREGOING USES.

<sup>\*1</sup> AIRCRAFT COCKPIT EQUIPMENT/SYSTEMS include class 2 Electronic Flight Bag (EFB) Systems and Class 1 EFB Systems when used during critical phases of flight (e.g., during take-off and landing) and/or mounted onto the aircraft. Class 1 EFB Systems and 2 EFB Systems are defined by FAA: AC (Advisory Circular) 120-76A or JAA: JAA TGL (Temporary Guidance Leaflets) No. 36.

**Other Limits and Exclusions: There are no other express warranties except as listed above.**

PANASONIC SHALL NOT BE LIABLE FOR LOSS OF DATA OR OTHER INCIDENTAL OR CONSEQUENTIAL DAMAGES RESULTING FROM THE USE OF THIS PRODUCT, OR ARISING OUT OF ANY BREACH OF THIS WARRANTY. ALL EXPRESS AND IMPLIED WARRANTIES, INCLUDING THE WARRANTIES OF MERCHANTABILITY AND FITNESS FOR A PARTICULAR PURPOSE ARE LIMITED TO THE APPLICABLE WARRANTY PERIOD SET FORTH ABOVE. Some states do not allow the exclusion or limitation of incidental or consequential damages, or limitations on how long an implied warranty lasts, so the above limitations or exclusions may not apply to you.

This limited warranty gives you specific legal rights, and you may also have other rights which vary from state to state.

For technical support or to arrange for service on your Panasonic computer product, call our toll-free hotline at 1-855-PSC-TECH (855-772-8324).

DIAL TOLL FREE: 1-855-PSC-TECH (855-772-8324)  
Web Site : [www.panasonic.com/toughbook](http://www.panasonic.com/toughbook)

# LIMITED WARRANTY (GARANTIE LIMITÉE)

## For Canada

### PANASONIC COMPUTER AND PERIPHERALS LIMITED WARRANTY

**Coverage** – Panasonic Canada Inc. (“PCI”) warrants to you, the first end user customer, this computer product (excluding software media), when purchased from PCI or from a PCI authorized reseller, to be free from defects in materials and workmanship under normal use, subject to the terms set forth below, during the period of warranty coverage specified.

Scope of Coverage	Period of Coverage	Type of Failure Coverage
<ul style="list-style-type: none"> <li>Laptop Computers (except Battery) and AC Adaptor</li> <li>Factory/PCI installed options including Wireless WAN, GPS, Bluetooth, Finger print reader, Backlit keyboard, Memory Card and Media Bay Drives (Floppy, CD/DVD)</li> <li>Mobile Wireless Display</li> <li>PDRC – LCD and Keyboard Assemblies</li> <li>Port Replicator</li> </ul>	Three (3) Years from Date of Original End User Customer Purchase	Defective Materials or Workmanship
<ul style="list-style-type: none"> <li>Hand-held Computers</li> <li>Battery</li> <li>Battery charger</li> <li>Auto Adaptor</li> <li>External USB Drives</li> </ul>	One (1) Year from Date of Original End User Customer Purchase	Defective Materials or Workmanship
<ul style="list-style-type: none"> <li>Digitizer pen or stylus</li> </ul>	Ninety (90) Days from Date of Original End User Customer Purchase	Defective Materials or Workmanship
<ul style="list-style-type: none"> <li>All consumable items including protection film, cleaning cloth, carry case, tether and harness</li> </ul>	No Coverage	

**Remedy** – In the event of a warranty claim, contact PCI’s representatives within the applicable warranty period, identifying the nature of the defect claimed, at 1-800-668-8386 between 9:00 A.M. and 5:00 P.M., Eastern Time Zone, Mon. – Fri. (excluding holidays) for instructions on how to obtain service. A purchase receipt or other proof of date of original purchase is required before warranty service is performed. Defective parts covered by this Limited Warranty will be repaired or replaced with new or comparable rebuilt parts on an exchange basis. Warranty replacement or repair is subject to the terms of this Limited Warranty for the balance of the original period of warranty coverage.

**No Coverage** – This Limited Warranty does not cover products purchased outside Canada. Neither does it cover damage to, failure of, or defects in a product or accessory through mishandling, improper installation, abnormal use, misuse, neglect, accident, introduction of liquid or other foreign matter into the product, alteration or servicing by anyone not authorized by PCI, or act of God.

THIS PRODUCT IS NOT INTENDED FOR USE AS, OR AS PART OF, NUCLEAR EQUIPMENT/SYSTEMS, AIR TRAFFIC CONTROL EQUIPMENT/SYSTEMS, OR AIRCRAFT COCKPIT EQUIPMENT/SYSTEMS<sup>2</sup>. PANASONIC WILL NOT BE RESPONSIBLE FOR ANY LIABILITY RESULTING FROM THE USE OF THIS PRODUCT ARISING OUT OF THE FOREGOING USES.

Appendix

# LIMITED WARRANTY (GARANTIE LIMITÉE)

<sup>2</sup> AIRCRAFT COCKPIT EQUIPMENT/SYSTEMS include Class2 Electrical Flight Bag (EFB) Systems and Class1 EFB Systems when used during critical phases of flight (e.g., during take-off and landing) and/or mounted on to the aircraft. Class1 EFB Systems and 2 EFB Systems are defined by FAA: AC (Advisory Circular) 120-76A or JAA: JAA TGL (Temporary Guidance Leaflets) No.36

## IF YOU SHIP THE PRODUCT FOR WARRANTY SERVICE

Carefully pack the product, preferably in the original carton. Include details of defect claimed and proof of date of original purchase. No liability is assumed for loss or damage to the product while in transit, if you chose your own transportation carrier.

## SOFTWARE MEDIA LIMITED WARRANTY

**Coverage** – PCI warrants to you, the first end user customer, that the disk(s) or other media on which software program(s) is/are supplied will be free from defects in materials and workmanship under normal use in Canada for a period of sixty (60) days from date of receipt as evidenced by your purchase receipt for your Panasonic Computer product. THIS IS THE ONLY WARRANTY THAT PCI MAKES RESPECTING THE SOFTWARE MEDIA. PCI does not warrant the software. Please refer to the software licensor's written warranty (accompanying the copy of the software) for any software warranty claim.

**Claim Procedure** – In the event of a defect in material or workmanship in the media during the sixty (60) day warranty period, and you return it, transportation costs prepaid, to Panasonic Canada Inc., Computer Products Marketing, 5770 Ambler Drive, Mississauga, Ontario L4W 2T3, within the warranty period, together with a copy of your purchase receipt, and an explanation of the suspected defect, PCI will replace in Canada the defective disk(s) or other media.

**Remedy** – PCI's entire liability, and your only remedy for any breach of this software media warranty is limited to replacement of the media only. It does not cover any other damages, including, but not limited to, loss of use or profit loss, or special, indirect or consequential damages, or other claims, whether or not of similar character.

**No Coverage** – This limited warranty does not apply if the disk(s) or other media has been used in other than a Panasonic product, or in environmental conditions other than those specified by PCI or the manufacturer, or if subjected to misuse, neglect, mishandling, modification or attempted modification of the program, or if damaged by accident or act of God. PCI is not responsible for damage to or loss of any program, data or removable storage media.

## GENERAL

**NO OTHER WARRANTIES** – PCI DISCLAIMS ALL OTHER WARRANTIES, EITHER EXPRESS OR IMPLIED, INCLUDING, BUT NOT LIMITED TO, IMPLIED WARRANTIES OF MERCHANTABILITY AND FITNESS FOR A PARTICULAR PURPOSE, WITH RESPECT TO THE SOFTWARE, SOFTWARE MEDIA, COMPUTER PRODUCT, OPTIONS AND ACCESSORIES.

**NO LIABILITY FOR CONSEQUENTIAL DAMAGES** – IN NO EVENT SHALL PCI BE LIABLE FOR ANY SPECIAL, INDIRECT OR CONSEQUENTIAL DAMAGES ARISING FROM ANY BREACH OF THE LIMITED WARRANTIES SET OUT IN THIS DOCUMENT, OR FROM THE USE OF THE COMPUTER PRODUCT, INCLUDING, WITHOUT LIMITATION, LOSS OF DATA, BUSINESS, PROFIT OR GOODWILL.

**IN ANY EVENT, PCI'S MAXIMUM LIABILITY FOR ANY BREACH SHALL NOT EXCEED THE AMOUNT ACTUALLY PAID BY YOU FOR THE COMPUTER PRODUCT.**

**NO ACTION, REGARDLESS OF ITS BASIS, MAY BE BEGUN AGAINST PCI MORE THAN TWO (2) YEARS AFTER THE CAUSE OF ACTION AROSE.**

**Statutory Warranties** – Some jurisdictions do not allow these limitations or exclusions, so they may not apply to you.

## Pour le Canada

### **GARANTIE LIMITÉE – ORDINATEURS ET PÉRIPHÉRIQUES PANASONIC**

**Couverture** – Panasonic Canada Inc. (« PCI ») garantit à l'acheteur original que ce produit informatique (à l'exclusion des supports des logiciels) est, au moment de sa vente par PCI ou d'un revendeur agréé par PCI, exempt de défauts de pièces et de fabrication dans les conditions normales d'utilisation, et ce, pendant la période de couverture de la garantie, sous réserve des modalités décrites ci-dessous.

Éléments couverts	Durée de couverture	Type de couverture
<ul style="list-style-type: none"><li>• Ordinateurs blocs-notes (sauf batteries) et adaptateur secteur</li><li>• Options installées en usine/par PCI incluant : WAN sans fil, GPS, Bluetooth, lecteur d'empreintes digitales, clavier rétroéclairé, carte mémoire et lecteurs (disquettes, CD/DVD)</li><li>• Écran mobile sans fil</li><li>• Ensembles PDRC – ACL et clavier</li><li>• Duplicateur de port</li></ul>	Trois (3) ans à partir de la date d'achat original.	Défauts de pièces et de fabrication
<ul style="list-style-type: none"><li>• Ordinateurs de poche</li><li>• Batterie</li><li>• Chargeur de batterie</li><li>• Adaptateur pour voiture</li><li>• Périphériques USB</li></ul>	Un (1) an à partir de la date d'achat original.	Défauts de pièces et de fabrication
<ul style="list-style-type: none"><li>• Stylo pointeur standard ou pour numériseur graphique</li></ul>	Quatre-vingt-dix (90) jours à partir de la date d'achat original.	Défauts de pièces et de fabrication
<ul style="list-style-type: none"><li>• Tous les articles consommables incluant les pellicules protectrices, chiffons de nettoyage, étuis de transport, longes et sangles</li></ul>	Aucune couverture	

**Recours** – Pour obtenir des informations sur la marche à suivre dans le cas où une réclamation en vertu de la garantie deviendrait nécessaire, communiquez par téléphone avec un représentant de PCI au 1-800-668-8386, entre 9h00 et 17h00 (heure de l'Est) du lundi au vendredi (sauf les jours fériés), avant l'échéance de la garantie applicable, en prenant soin d'identifier la nature de la défaillance.

Un reçu ou toute autre pièce justificative de la date d'achat original sera exigé avant toute réparation. Toute pièce défectueuse couverte par la présente garantie limitée sera réparée ou remplacée par une pièce neuve ou remise à neuf. Le remplacement ou la réparation sera fait conformément aux modalités de la présente garantie limitée pendant la durée restante de la période originale de la garantie.

**Produits non couverts** – La présente garantie limitée ne couvre pas les produits achetés à l'extérieur du Canada. Elle ne couvre pas non plus les dommages, la défaillance ou les défauts attribuables à une manutention inadéquate, une mauvaise installation, une utilisation anormale ou abusive, de la négligence, un accident, un déversement ou la pénétration d'un objet étranger, une modification, un cas fortuit ou une réparation effectuée par une personne non agréée par PCI.

## LIMITED WARRANTY (GARANTIE LIMITÉE)

CE PRODUIT N'EST PAS DESTINÉ À ÊTRE UTILISÉ, EN TOUT OU EN PARTIE, COMME SYSTÈME/ÉQUIPEMENT NUCLÉAIRE, SYSTÈME/ÉQUIPEMENT DE CONTRÔLE DU TRAFIC AÉRIEN OU SYSTÈME/ÉQUIPEMENT DE POSTE DE PILOTAGE D'AVION<sup>3</sup>. PANASONIC DÉCLINE TOUTE RESPONSABILITÉ CONCERNANT L'UTILISATION DE CE PRODUIT DANS LES CAS SUSMENTIONNÉS.

<sup>3</sup> Les SYSTÈMES/ÉQUIPEMENTS DE POSTE DE PILOTAGE D'AVION sont dotés de systèmes OEPP (organiseur électronique de poste de pilotage) de classe 2 et de classe 1 utilisés pendant des phases critiques de vol (par exemple, pendant le décollage et l'atterrissage) et(ou) montés sur l'avion. Les systèmes OEPP de classe 1 et de classe 2 sont définis par le circulaire d'information FAA: AC (Advisory Circular) 120-76A ou le feuillet n° 36 JAA: JAA TGL (Temporary Guidance Leaflets) No 36.

### EXPÉDITION DU PRODUIT POUR SERVICE SOUS GARANTIE

Emballez soigneusement le produit, de préférence dans son emballage d'origine. Joignez une description de la défaillance de même qu'une pièce justificative de la date d'achat. Panasonic Canada Inc. ne peut être tenue responsable pour tout dommage ou perte subi pendant le transport si vous avez choisi le transporteur.

### GARANTIE LIMITÉE – SUPPORTS DES LOGICIELS

**Couverture** – Panasonic Canada Inc. (« PCI ») garantit à l'acheteur original que la ou les disquettes ou tout autre support sur lequel le ou les programmes sont fournis sont exempts de défauts de pièces et de fabrication dans des conditions normales d'utilisation au Canada, et ce, pour une période de soixante (60) jours suivant la date de réception indiquée sur la preuve d'achat.

LA PRÉSENTE GARANTIE EST LA SEULE OFFERTE PAR PCI COUVRANT LES SUPPORTS DE LOGICIELS. PCI ne garantit pas les logiciels. Reportez-vous à la garantie écrite du concédant de licence d'utilisation du logiciel (qui accompagne la copie du logiciel) pour toute réclamation en vertu de la garantie.

**Réclamation – marche à suivre** – Panasonic Canada Inc. remplacera toute disquette ou support défectueux si l'article en question est retourné, port payé, à son service de Marketing – produits informatiques, 5770 Ambler Drive, Mississauga (Ontario) L4W 2T3, dans les soixante (60) jours suivant la date d'achat original. Joignez à votre envoi une pièce justificative de votre achat et une description du problème.

**Recours** – La responsabilité de PCI - et votre seul recours - dans le cas de toute défaillance couverte par la garantie sur ce support de logiciel est limitée au seul remplacement du support. Elle ne couvre aucun autre dommage, y compris, mais non exclusivement, la perte d'usage ou de profits, ni aucun dommage spécial, indirect ou consécutif, ni aucune autre réclamation de nature similaire ou autre.

**Produits non couverts** – La présente garantie limitée ne s'applique pas si la ou les disquettes ou autre support ont été utilisés dans un produit d'une marque autre que Panasonic ou dans des conditions environnementales autres que celles spécifiées par PCI ou le fabricant, ou soumis à une mauvaise utilisation, à la négligence, à une manutention inadéquate ou encore si le programme a été modifié ou subi une tentative de modification ou des dommages attribuables à un accident ou à un cas fortuit. De plus, PCI n'assume aucune responsabilité pour toute perte de, ou tout dommage à, un programme, des données ou un support de sauvegarde amovible.





---

## GÉNÉRALITÉS

PCI NE RECONNAÎT AUCUNE AUTRE GARANTIE, EXPLICITE OU IMPLICITE, Y COMPRIS, MAIS NON EXCLUSIVEMENT, LES GARANTIES IMPLICITES DE VALEUR COMMERCIALE ET D'UTILITÉ À UNE FIN QUELCONQUE, À L'ÉGARD DU LOGICIEL, SUPPORTS DE LOGICIELS, PRODUITS INFORMATIQUES, PÉRIPHÉRIQUES ET ACCESSOIRES.

SOUS AUCUNE CIRCONSTANCE PCI NE POURRA ÊTRE TENUE RESPONSABLE DES DOMMAGES SPÉCIAUX, INDIRECTS OU CONSÉCUTIFS ATTRIBUABLES À UN MANQUEMENT AUX GARANTIES LIMITÉES DÉCRITES DANS LE PRÉSENT DOCUMENT OU À L'UTILISATION DU PRODUIT INFORMATIQUE, Y COMPRIS, SANS RESTRICTION, LA PERTE DE DONNÉES, D'AFFAIRES, D'ACHALANDAGE OU DE PROFIT. DANS TOUS LES CAS, LA RESPONSABILITÉ MAXIMALE DE PCI POUR TOUT MANQUEMENT NE POURRA EXCÉDER LE PRIX DE VENTE DU PRODUIT INFORMATIQUE. AUCUNE RÉCLAMATION, SANS ÉGARD À SES MOTIFS, NE POURRA ÊTRE FAITE AUPRÈS DE PCI PLUS DE DEUX (2) ANS APRÈS LES FAITS INVOQUÉS À LA BASE D'UNE TELLE RÉCLAMATION.

**Garantie statutaires** – Certaines juridictions interdisent de telles limitations ou exclusions; aussi, pourraient-elles ne pas s'appliquer.

# LIMITED WARRANTY

## For Australia

### Personal / Notebook Computers - 36 Month Warranty from Date of Purchase

1. Subject to the conditions of this warranty Panasonic or its Authorised Service Centre will perform necessary service on the product without charge for parts or labour, if in the opinion of Panasonic, the product is found to be faulty within the warranty period.
2. This warranty only applies to Panasonic products purchased in Australia and sold by Panasonic Australia or its Authorised Distributors or Dealers and only where the products are used and serviced within Australia or its territories. Warranty cover only applies to service carried out by a Panasonic Authorised Service Centre and only if valid proof of purchase is presented when warranty service is requested.
3. This warranty only applies if the product has been installed and used in accordance with the manufacturer's recommendations (as noted in the operating instructions) under normal use and reasonable care (in the opinion of Panasonic). The warranty covers normal domestic use only and does not cover damage, malfunction or failure resulting from use of incorrect voltages, incorrect installation, accident, misuse, neglect, build-up of dirt or dust, abuse, maladjustment of customer controls, mains supply problems, thunderstorm activity, infestation by insects or vermin, tampering or repair by unauthorised persons (including unauthorised alterations), exposure to abnormally corrosive conditions or any foreign object or matter having entered the product.
4. This warranty does not cover the following items unless the fault or defect existed at the time of purchase: Software
5. Warranty on Toughbook accessories (stylus, pens, AC charger, combo drive, etc) is 12 Months from the date of purchase & 3 months for batteries.
6. To claim warranty service, when required, you should:  
Check the Panasonic web site for latest warranty contact <http://www.panasonic.com.au/toughbook>, use the Service Centre Locator and call the National Service Centre number indicated.  
Prepare purchase receipt as proof of purchase date and system serial number which will be required by the Authorised Service Centre.
7. The Warranty excludes 3 or less faulty pixels on screen.
8. The Warranty includes the repair or exchange of faulty parts within the product with items that are functionally equivalent to that as originally supplied or better – including new or refurbished parts or units – solely at Panasonic's discretion.
9. It is the customer's responsibility to backup all data from the hard disk drive before sending equipment for repair. If a problem is related to the hard disk drive, or the hard disk drive has to be replaced, Panasonic will only reload the factory pre-installed software for the product onto the replacement drive.
10. Panasonic will arrange free pick up and return for approved warranty repairs within 50 km of capital city locations. Please ensure your unit is properly packed for return to the service location.

11. The warranties hereby conferred do not extend to, and exclude, any costs associated with the installation, de-installation or re-installation of a product, including costs related to the mounting, demounting or remounting of any screen, (and any other ancillary activities), delivery, handling, freighting, transportation or insurance of the product or any part thereof or replacement of and do not extend to, and exclude, any damage or loss occurring by reason of, during, associated with, or related to such installation, de-installation, re-installation or transit.

In addition to your rights under this warranty, Panasonic products come with consumer guarantees that cannot be excluded under the Australian Consumer Law. If there is a major failure with the product, you can reject the product and elect to have a refund or to have the product replaced or if you wish you may elect to keep the goods and be compensated for the drop in value of the goods. You are also entitled to have the product repaired or replaced if the product fails to be of acceptable quality and the failure does not amount to a major failure.

If there is a major failure in regard to the product which cannot be remedied then you must notify us within a reasonable period by contacting the Panasonic Customer Care Centre. If the failure in the product is not a major failure then Panasonic may choose to repair or replace the product and will do so in a reasonable period of time from receiving notice from you.

THIS PRODUCT IS NOT INTENDED FOR USE AS OR AS PART OF NUCLEAR EQUIPMENT/SYSTEMS, AIR TRAFFIC CONTROL EQUIPMENT/SYSTEMS, OR AIRCRAFT COCKPIT EQUIPMENT/SYSTEMS<sup>4</sup>. PANASONIC WILL NOT BE RESPONSIBLE FOR ANY LIABILITY RESULTING FROM THE USE OF THIS PRODUCT ARISING OUT OF THE FOREGOING USES.

<sup>4</sup> AIRCRAFT COCKPIT EQUIPMENT/SYSTEMS include Class 2 Electronic Flight Bag (EFB) Systems and Class 1 EFB Systems when used during critical phases of flight (e.g., during take-off and landing) and/or mounted onto the aircraft. Class 1 EFB Systems and 2 EFB Systems are defined by FAA: AC (Advisory Circular) 120-76A or JAA: JAA TGL (Temporary Guidance Leaflets) No.36.

**THIS WARRANTY CARD AND THE PURCHASE DOCKET  
(OR SIMILAR PROOF OF PURCHASE)  
SHOULD BE RETAINED BY THE CUSTOMER AT ALL TIMES**

If you require assistance regarding warranty conditions or any other enquiries, please visit the Panasonic Australia website [www.panasonic.com.au/toughbook](http://www.panasonic.com.au/toughbook) or contact by phone on 1300 132 463

**Panasonic Australia Pty. Limited**

ACN 001 592 187 ABN 83 001 592 187

1 Innovation Road, Macquarie Park NSW 2113

[www.panasonic.com.au](http://www.panasonic.com.au)

PRO-031-F05 Issue: 4.0

11-11-2011

Appendix

---

**Panasonic Corporation**  
Osaka, Japan

**Panasonic System Communications Company of North America**  
Two Riverfront Plaza,  
Newark NJ 07102

**Panasonic Canada Inc.**  
5770 Ambler Drive, Mississauga,  
Ontario L4W 2T3

**Panasonic Australia Pty. Limited**  
ACN 001 592 187 ABN 83 001 592 187  
1 Innovation Road, Macquarie Park NSW 2113

Importer's name & address pursuant to the EU legislation

**Panasonic System Communications Company Europe, Panasonic  
Marketing Europe GmbH**  
Hagenauer Straße 43  
65203 Wiesbaden  
Germany

Web Site : <http://panasonic.net/>

© Panasonic Corporation 2014  
Printed in Taiwan

CD0114-1024  
DFQW5887ZBT

