

# Contents

---

1. Introduction	
1.0 Product Overview .....	1
1.1 Features .....	1
1.2 About this Manual .....	2
2. Initial Installation and Setup	
2.0 Unpacking and Inspection .....	3
2.1 Additional Requirements .....	3
2.2 Connectors and Indicators .....	4
2.3 Hardware Setup .....	4
2.4 Configuration .....	5
2.4.1 Quick Start Approach .....	5
A. Point-to-Point .....	5
B. Point-to-Multipoint .....	6
3. Configuration Options	
3.0 Changing Parameters in Configuration Menu .....	7
3.1 Operating Mode .....	7
3.2 Serial Baud Rate .....	9
3.3 Wireless Link Rate .....	9
3.4 Network Address .....	10
3.5 Unit Address .....	10
3.6 Hopping Pattern .....	10
3.7 Encryption Key .....	11
3.8 Output Power Level .....	11
3.9 Packet Parameters .....	12
3.10 Radio Statistics .....	13
3.11 Slave List .....	13
Appendices	
A. MRX-900 Configuration Menu Navigation Chart .....	15
B. Configuration Record .....	17
C. RS-232 Interface and Cables	
C.0 RS-232 Line Signals .....	19
C.1 DTE-to-DCE (Straight-Through) Cables .....	19
C.2 Crossover / Null Modem Cables .....	20
C.3 Loopback Plug .....	20
D. Surface or Wall Mounting .....	21
E. Troubleshooting .....	23
F. Technical Specifications .....	25
G. Glossary .....	27



# 1. Introduction

---

## 1.0 Product Overview

Congratulations on choosing the MRX-900 wireless modem! Your new MRX-900 is a state-of-the-art, 900 MHz frequency-hopping spread-spectrum communications transceiver. Equipped with the MRX-900, terminal devices (DTEs) up to 30 km (or more)<sup>1</sup> apart will be capable of establishing high-speed<sup>2</sup> communications wirelessly.

Once properly installed and configured, a pair of MRX-900s provides a practical and reliable alternative to using traditional analog phone-line modems or “null-modem” serial cable (RS-232) connections for data communications between terminal equipment. Moreover, wireless data communications using the MRX-900 means you will benefit from:

- greater flexibility and freedom to relocate terminal equipment,
- reduced cabling hassles,
- eliminated requirement for access to wire-based transfer media such as telephone lines,
- the ability to communicate through walls, floors, and many other obstacles.

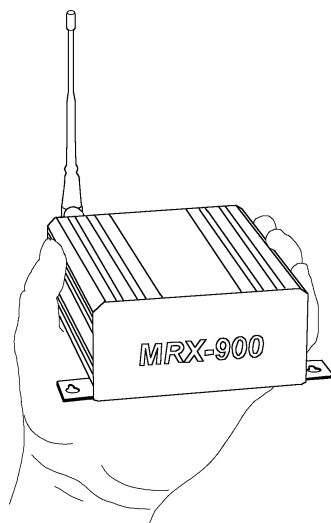

While the MRX-900 is handsomely sleek and compact in its design, it delivers power and convenience and offers quality and dependability.

The MRX-900's versatility makes it the ideal solution for applications ranging from office-productivity to industrial data control and acquisition. While a pair of MRX-900 modems can link two terminal devices (“point-to-point” operation), multiple MRX-900 units can be used together to create a network of various topologies (“point-to-multipoint” operation). Multiple independent networks can operate concurrently, so it is possible for unrelated communications operations to take place in the same or a nearby area without sacrificing privacy, functionality, or reliability.

## 1.1 Features

Key features of the MRX-900 include:

- transmission within a public, license-exempt band of the radio spectrum<sup>3</sup> – this means there are no conditions on usage of the MRX-900, and that it can be used without restrictions or access fees (such as those incurred by cellular airtime);
- a fully compliant RS-232 serial I/O data port with handshaking and hardware flow control, allowing the MRX-900 to interface with virtually any terminal device with an asynchronous RS-232 port, such as a computer;

---

<sup>1</sup> Ideal conditions with clear line-of-sight communications, using high-gain antennas.

<sup>2</sup> Up to 115,200 bits per second (bps).

<sup>3</sup> 902-928 MHz, which is license-free within North America; may need to be factory-configured differently for some countries.

- twenty different user-selectable pseudo-random hopping patterns to offer the possibility of separately operating multiple networks while providing security, reliability and high tolerance to interference;
- encryption key with 65536 user-selectable values to maximize security and privacy of communications;
- built-in CRC-16 error detection and auto re-transmit to provide 100% accuracy and reliability of data;
- ease of installation and use – the MRX-900 can be used as a drop-in replacement for most null-modem cable (DTE-to-DTE) operations, and as a modem replacement with minimal or no software changes.

While the typical application for the MRX-900 is to provide a mid- to long-range wireless communications link between DTEs, it can be adapted to almost any situation where an RS-232 asynchronous serial interface is used and data intercommunication is required.

## 1.2 About this Manual

This manual has been provided as a guide and reference for installing and using MRX-900 wireless modems. The manual contains instructions, suggestions, and information which will help you set up and achieve optimal performance from your equipment using the MRX-900.

Although the manual is intended for all MRX-900 users from the novice to the professional, it is recommended that new users of the MRX-900 thoroughly read Chapters 2 and 3, which describe the initial setup and configuration of the modems. Also, it may be noteworthy to review sections of Chapter 4 which are relevant to your application while providing helpful hints for optimizing your MRX-900 modems. The Appendices, including the Glossary of Terms, are provided as informational references which you may find useful throughout the use of this manual as well as during the operation of the wireless modem.

Throughout the manual, you will encounter not only illustrations that further elaborate on the accompanying text, but also several symbols which you should be attentive to:



**Caution or Warning:** Usually advises against some action which could result in undesired or detrimental consequences.



**Point to Remember:** Highlights a key feature, point, or step which is worth noting. Keeping these in mind will make using the MRX-900 more useful or easier to use.



**Tip:** An idea or suggestion is provided to improve efficiency or to make something more useful.

With that in mind, enjoy extending the boundaries of your communications with the MRX-900, and please remember to send in your warranty registration!

# 2. Initial Setup and Configuration

## 2.0 Unpacking and Inspection

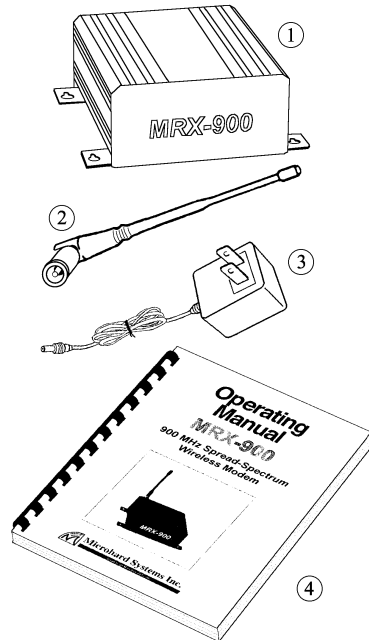

The following items should be found in the shipping carton. Inspect the modem and accessories for damage. Report damages or shortages to the distributor from which the unit was purchased. Keep all packing materials in the event that transportation is required in the future.

Package contents (normal distribution):

①	MRX-900 Wireless Modem	1
②	6" Rubber Ducky Antenna	1
③	9 VDC, 1 Amp Power Adapter	1
④	Operating Manual (this document)	1

The materials you received may vary from those depicted in the figures, which should be referred to only as a guideline.

## 2.1 Additional Requirements

Since the MRX-900 is a unique product in a class of its own, it will communicate only with another MRX-900 which has been compatibly configured. Thus, at least two MRX-900s will be required to establish a wireless communications link. Each MRX-900 will also require access to a 120 VAC power source.

Additionally, the following requirements should be taken into consideration when preparing to install your MRX-900 wireless modem. These represent "typical" requirements, but due to the large variation of user needs and applications, the items are *user-supplied* and are not accessories which normally ship with the MRX-900. However, most of these are readily available from any electronics or computer retailer, or they can be ordered through your distributor for Microhard Systems' products.

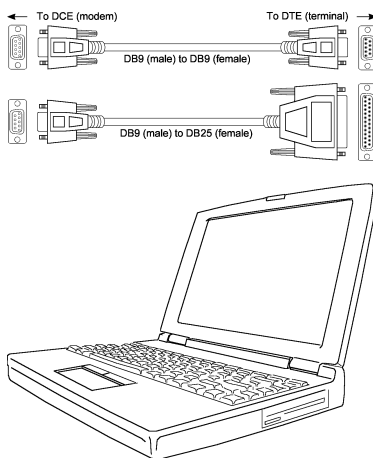

- Shielded "straight-through" RS-232 cable (typically DB9P-to-DB9S or DB9P-to-DB25S) for each MRX-900 to DTE connection\*.
- Connection adapters and converters, if necessary (*e.g.*, gender-changers, DB9-to-DB25 adapters, etc.)
- Terminal device (*e.g.*, PC or laptop) with functional RS-232 port and appropriate communications (terminal emulation) software.
- Mounting hardware (screws) if surface or wall mounting is desired (see Appendix D for mounting information)

\* Note: DB9P denotes a 9-position D-sub *male* connector (with *pins*), while DB9S denotes the mating connector of *female* gender (with *sockets*).

Although the physical space required for the MRX-900 is minimal, you should ensure that there is sufficient room for access to the unit's rear panel (where connectors and indicators are located), as well as for an antenna to be connected (typically oriented in an upright/vertical position).

## 2.2 Connectors and Indicators

Locate the rear panel of the MRX-900. The interface connectors and indicator lights are summarized below. This manual will refer to these items in the sections that follow.

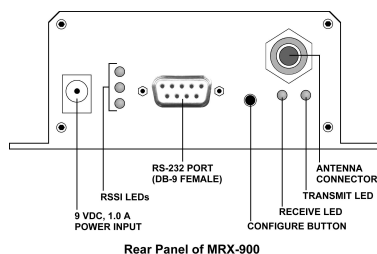

**9 VDC Input** - It is recommended that the provided power adapter be used to supply power to the MRX-900 via this connector, although any compatible DC power source which has an output of 9 volts and at least 1 amp may be used.

**Receive Signal Strength Indicator (RSSI) LEDs** - These LEDs show the quality/strength of the received signal. As the signal strength increases, the LEDs will illuminate incrementally from bottom to top.

**RS-232 Data Port (DCE)** - The socketed (female) D-sub connector is used to interface the MRX-900 to a DTE device and operates at 2400 to 115,200 bps. The same port is used to configure the modem by interfacing to a terminal (at 9600 bps). See Appendix C for details on the RS-232 interface and line signals.

**Configuration Button** - This button is used to configure the modem. When depressed for about 2-3 seconds, the configuration menu will be initiated and displayed on the connected terminal (DTE) screen. Subsequent interaction with the modem is performed using the terminal keyboard.

**Receive LED** - Lights up when the modem receives data over the wireless link, as well as during internal carrier search and synchronization operations.

**Transmit LED** - Lights to indicate that the modem is transmitting data wirelessly. This light flashes during initial startup and carrier synchronization.

**Antenna Connector** - Reverse-polarity TNC connector for connecting any compatible antenna, including the provided rubber-duffy antenna.

## 2.3 Hardware Setup

Prior to setting up and configuring the MRX-900, please observe the requirements outlined in Section 2.1. When you are ready for the initial setup:

1. Connect the modem to a terminal or personal computer (DTE) using a standard serial cable. Depending on the connector on your DTE device, you will typically need a DB9-to-DB9 or DB9-to-DB25 cable (see Appendix C for additional information). Connect the male DB9 end of the cable to the MRX-900 data port.
2. Apply power to the MRX-900 by plugging the provided adapter into the power input socket, and the other end into an active 120 VAC outlet. (You will see the Receive LED illuminate to indicate that it is operating normally.)
3. On your terminal or in your terminal program (*e.g.* HyperTerminal in Microsoft Windows or Procomm Plus from Datastorm Technologies), ensure that the correct port is selected and that it has been configured for a speed of 9600 baud and a data format of 8N1 (8 bits, No parity, 1 stop bit). Although no terminal emulation is necessary, TTY can be selected if desired.
4. You are now ready to configure the modem for operation. The following sections will walk you through the procedure.



**Caution:** Using any other power supply which does not provide the proper voltage or current could damage the MRX-900 and void your warranty. Doing so is at your own risk.

## 2.4 Configuration

Prior to establishing a wireless link, each MRX-900 that will participate in the link must be correctly configured for compatibility and for the desired mode of operation.

The two most common types of networks used are:

- **Point-to-point:** A *master* station communicates with a single *slave* station.
- **Point-to-multipoint:** A *master* station communicates with two or more *slave* stations.

Within any network, the master will communicate only with slave(s) assigned to the same network. Similarly, a slave will only communicate with the master of the network to which it is assigned.

The quick configuration procedure is outlined below for each of these modes.

### 2.4.1 Quick Start Approach

Assuming your hardware has been properly setup (as outlined in Section 2.3) for configuration, you are now ready to begin the process. Start by locating the Configuration Button at the rear of your MRX-900 and pressing it for two to three seconds. A menu similar to the following should appear on your terminal screen:

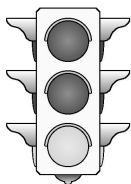
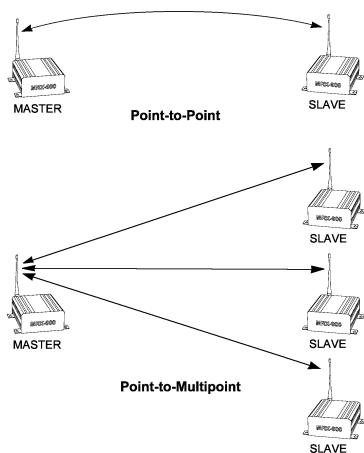

```
Microhard Systems Inc
MRX-900 Configuration
1) Operating Mode      Slave - Point to Point
2) Serial Baud Rate   115200
3) Wireless Link Rate Turbo
4) Network Address    1
5) Unit Address       1
6) Hopping Pattern    A
7) Encryption Key     0
8) Output Power Level 1 mW
9) Packet Parameters
A) Radio Stats
ESC to exit

Select an Item to Configure : _
```

The minimum configuration requirements for point-to-point and point-to-multipoint are summarized below. *These requirements will get you started and only ensure that a link can be established, but do not necessarily provide the best performance;* optimization of the communications link is discussed in later sections.

#### A. Point-to-Point

To establish a point-to-point communications link, the following requisites must be satisfied:

- The **Operating Mode** for one modem must be configured as a “**Master - Point-to-Point**”, and the other as a “**Slave - Point-to-Point**”.
- The **Serial Baud Rate** for each modem must be set to match the baud rate of the connected equipment (DCE and DTE rates must be equivalent).

- The **Wireless Link Rate** for both modems must be the same.
- The **Network Address** assigned for both modems must be the same.
- The **Unit Address** assigned for both modems must be the same.
- The same **Hopping Pattern** must be selected for both modems.
- Both modems must use the same **Encryption Key**.

## B. Point-to-Multipoint

To establish a point-to-multipoint network, the following requisites must be satisfied:

- The **Operating Mode** for one modem must be configured as a **Point-to-Multipoint Master**, and the others as **Point-to-Multipoint Slaves**.
- The **Serial Baud Rate** for each modem must be set to match the baud rate of the connected equipment (DCE and DTE rates must be equivalent).
- The **Wireless Link Rate** for all modems must be the same.
- The **Network Address** assigned to all modems must be the same.
- Each Slave must be assigned a unique **Unit Address**.
- The Master must have a list of all **Slave Unit Numbers** in its **Slave List**.
- The same **Hopping Pattern** must be selected for all modems.
- All modems must use the same **Encryption Key**.

Each of the parameters above are defined using the terminal to display the menu-driven configuration screens and setting the appropriate items. Settings are immediately stored in non-volatile memory upon selection, and are therefore retained even after powering down. Each item and the settable parameters within the modem configuration are described in detail in Chapter 3: Configuration Options. Once the configuration is complete, the modems can be restored to operation mode by either pressing ESC to exit the menu (“Running . . .” should then appear), or simply by power-cycling the unit (momentarily disrupting power to the unit, then restoring it).

## 2.5 Checking the Link

Once configured properly, a pair or set of communicating modems can be tested to ensure that a link can be successfully established. Attach the provided antenna to the antenna connector on each MRX-900 and screw the antenna in snugly. The modems should indicate the status of the wireless link via the RSSI LEDs on the rear panel: if the link is good, up to three LEDs should illuminate; and if the link is absent (due to a fault at one end or another, such as misconfiguration), the LEDs will be unlit. It is recommended that if MRX-900s will be deployed in a field where large distances separate DTEs, the modems be configured and tested in close proximity (*e.g.*, in the same room) first to ensure a good link can be established and settings are correct. This will facilitate troubleshooting, should problems arise.



**Warning:** Using an antenna other than one approved by Microhard Systems Inc. could result in undesired performance, and may damage the MRX-900. Failure to use an approved antenna may void your warranty. It is the user’s responsibility to ensure the antenna has adequate lightning protection.



# 3. Configuration Options

## 3.0 Configuration Parameters

The MRX-900 is easily configured to meet a wide range of needs and applications. Configuration is fully menu-driven and requires only a terminal with a 9600 baud RS-232 port. Configuration mode is initiated by depressing the Configuration Button on the back panel of the MRX-900 and holding it for at least two or three seconds. The main configuration menu is then displayed:

```
Microhard Systems Inc
MRX-900 Configuration
1) Operating Mode      Slave - Point to Point
2) Serial Baud Rate   115200
3) Wireless Link Rate Turbo
4) Network Address    1
5) Unit Address       1
6) Hopping Pattern    A
7) Encryption Key     0
8) Output Power Level 1 mW
9) Packet Parameters
A) Radio Stats
ESC to exit

Select an Item to Configure : _
```



In configuration mode, the default serial rate for the MRX-900 is 9600 baud.



Refer to Appendix A (page 15) for a menu navigation chart to facilitate use of the configuration menus.



Configuration options are immediately stored in non-volatile memory when selected and become active after exiting configuration or power-cycling the unit.

Note that 9600 baud is the default rate for configuration only, and that the actual data communications rate during operation is user-defined, with rates from 2400 to 115,200 bps. (With reference to the serial data port, *baud* and *bps* can correctly be used interchangeably since no modulation occurs to increase the bit rate over the baud rate. This may not always be the case with modulated signals transmitted between DCEs.) No terminal emulation is required, although a “TTY” setting can be used if mode selection is required by your communications software.

Most menu items are hot-key driven, requiring minimal keypresses to quickly navigate and set parameters. Current parameters are indicated to the right of each item in the main configuration menu (see above), and preceded by an asterisk (\*) for each chosen option in parameter submenus (shown on following pages). Configuration parameters are saved in non-volatile memory as soon as they are selected. This allows quick configuration of the modem and reactivation in operation mode by either pressing ESC on the terminal from the main configuration menu, or simply power-cycling the unit (momentarily disconnecting power to the MRX-900).

## 3.1 Operating Mode

The Operating Mode partly defines the “personality” of the MRX-900. When item 1 is chosen from the configuration menu, the following options are available:



Each unit must be either a Master, Slave, or Repeater. Only one Master can exist for each network.

```
Operating Mode
* 1) Master - Point to Point
  2) Slave - Point to Point
  3) Master - Point to Multipoint
  4) Slave - Point to Multipoint
  5) Repeater
ESC to exit
Select Operating Mode : _
```

Each unit should be configured as a Master or Slave, except when it is used as a Repeater. The user should decide, prior to deployment, whether a point-to-point or point-to-multipoint network is appropriate for the application, and how each unit will be assigned to terminals.

1) **Master - Point to Point** One unit in a point-to-point link should be set as the Master, obligating the other modem to be used as a Slave. During operation, it makes little difference which end is which, especially if data is generally transmitted unidirectionally at any given moment. In cases where both DTEs will generally transmit large amounts of data simultaneously, the Master should be assigned to the terminal whose transmit priority is higher. When both terminals have data to send, more bandwidth is dynamically allocated to the Master; otherwise, the transmitting end, whichever it is at the time, is given the full bandwidth.

2) **Slave - Point to Point** The terminal in a point-to-point network which is not set as the Master, is obligated to be the Slave. The Slave will communicate with the Master, either directly or through a repeater, whose network address, unit address, and hopping pattern matches its own.

3) **Master - Point to Multipoint** In a point-to-multipoint network, one unit should be set as the Master, obligating all other modems to be Slaves. The Master designation is generally given to the station which functions as a hub for all remote nodes, and it is the Master station's responsibility to control communications with Slaves. When this mode is selected, an additional option, "B) Slave List", will appear in the main menu. The Master, using its Slave List, will communicate with Slaves on the same network in a round-robin fashion. Setting up the Slave List will be described in more detail later.

4) **Slave - Point to Multipoint** Several Slaves exist in a point-to-multipoint network, all of which communicate with the common Master. Each slave may communicate with the Master directly, through a repeater of its own, or via a common repeater. Slaves cannot directly communicate with other Slaves.

5) **Repeater** The Repeater mode is chosen when the unit will function as neither a Master nor a Slave, but as an intermediary in a Master-Slave(s) relationship. The Repeater is useful when the direct Master-to-Slave transmission distance exceeds the maximum range or transmission is hindered due to environmental or geographical conditions. A repeater can serve one or more slaves much like the point-to-multipoint master. When this mode is selected, an additional option, "B) Slave List", will appear in the main menu. Setting up the Slave List will be described in more detail later.

## 3.2 Serial Baud Rate

The Serial Baud Rate is the speed that the DTE communications port will be set at during normal operation. This rate has no bearing on the serial rate during configuration, which is always performed at 9600 baud. The possible parameters after selecting item 2 from the configuration menu are:

```
Serial Baud Rate
* 1) 115200
  2)  57600
  3)  38400
  4)  28800
  5)  19200
  6)  14400
  7)   9600
  8)   7200
  9)   4800
  A)   3600
  B)   2400
ESC to exit
Select Serial Baud Rate : _
```

It is generally advisable to choose the highest rate that your terminal equipment will handle to maximize performance, unless a limitation on the available bandwidth is desired. If the DTE is a personal computer, the port can usually be used reliably at 115200. It is important that the rate specified in the MRX-900 configuration matches that of the DTE to which it is connected, or the DTE-DCE communication will fail.

## 3.3 Wireless Link Rate

The Wireless Link Rate is the speed and optimization method for which modems will communicate over the RF link. The possible settings are:

```
Wireless Link Rate
* 1) Turbo
  2) Fast
  3) Normal
ESC to exit
Select Wireless Link Rate : _
```

Depending on the application requirements, each mode will provide different throughputs and performance optimizations as follows:

Mode	Expected Performance (Maximum Throughput)	Primary Optimization
Turbo	115.2 kbps	Optimized for Speed
Fast	57.6 kbps	Optimized for Distance and Speed
Normal	28.8 kbps	Optimized for Distance

Generally, the lowest rate which provides sufficient bandwidth should be selected. For example, if DTEs are set to communicate at 19.2 kbps, then the wireless rate can be set to Normal (with the added advantage of slightly greater range). If DTEs will typically require nearly 115.2 kbps of sustained bandwidth, then the wireless rate should be set to Turbo (setting it lower would “bottleneck” data transmissions in the wireless link). Note that there is a slight compromise between speed performance and range.



Select a Network Address and assign it to all units which will be included in the network.

### 3.4 Network Address

The Network Address defines the membership to which individual units can be a part of. By establishing a network under a common Network Address, the network can be isolated from any other concurrently operating network using the same hardware. As well, the Network Address provides a measure of privacy and security. Only those units which are members of the network will participate in the communications interchange. Valid values for the Network Address range from 0 to 65535, inclusive. Choosing the option from the main menu (option 4) will yield something like the following, after which up to five digits can be entered, followed by Enter or Return:

```
Network Address = 39513
ESC to exit
Set Network Address : _
```

To enhance privacy and reliability of communications where multiple networks may operate concurrently in close proximity, it is suggested that an atypical value be chosen – perhaps something meaningful yet not easily selected by chance or coincidence.

### 3.5 Unit Address



Use the same Unit Address on all units for point-to-point mode. In multipoint mode, set all slaves to a unique Unit Address.

In point-to-point operation, the Unit Address on all units (Master, Slave, and Repeater, if applicable) must be the same. In a multipoint system, the Unit Address uniquely identifies each Slave from the others. This parameter, whose value can range from 0 to 65535 inclusive, is set in parallel with the Slave List (described later), so the Unit Address for each slave should be noted and subsequently added to the Slave List. The parameter is set by selecting item 5 in the configuration menu, and entering up to five digits followed by the Enter or Return key:

```
Unit Address = 23
ESC to exit
Set Unit Address : _
```

Remember that each Slave should have a Unit Address which is unique from any other Slave in the network.

### 3.6 Hopping Pattern



Ensure that all units within a network use the same hopping pattern, and that multiple concurrent networks each have different hopping patterns.

Since the MRX-900 is a frequency-hopping modem, the carrier frequency changes periodically according one of twenty pseudo-random patterns, selected by defining the Hopping Pattern. When this option (#6) is chosen from the configuration menu, something resembling the following appears:

```
Hopping Pattern = A
ESC to exit
Set Hopping Pattern [A..T] :
```

A letter from A to T, inclusive, can be used to select the pattern. It is important that all units which will participate in a network use the same hopping pattern, or the communication link will fail.

### 3.7 Encryption Key

The Encryption Key provides a measure of security and privacy of communications by rendering the transmitted data useless without the correct key on the receiver. By selecting option 7 from the configuration menu, you are prompted to enter a key (valid values range from 0 to 65535), followed by Return or Enter:

```
Encryption Key = 6109
ESC to exit
Set Encryption Key : _
```

Keep in mind that all units within the network must use the same key for communications to succeed.

### 3.8 Output Power Level

The Output Power Level determines at what power the MRX-900 transmits. The super-sensitive MRX-900 can operate with very low power levels, so it is recommended that the lowest power necessary is used; using excessive power contributes to unnecessary “RF pollution”. To set the power level, select option 8 from the configuration menu and select one of the following:

```
Power Output Level
1) 1 mW
2) 10 mW
3) 100 mW
* 4) 1000 mW
5) Adaptive
ESC to exit
Select Power Output Level : _
```



Test the communications link using a low power level and work upward. Avoid using a higher power than necessary since performance may actually degrade.

Ideally, you should test the communications performance between units starting from a low power level and working upward until the RSSI is sufficiently high and a reliable link is established. Although the conditions will vary widely between applications, typical uses for each setting are described below:

Power	Use
1 mW	For in-building use, typically provides a link up to 300 feet on the same floor or up/down a level. Outdoors, distances of 10 km can be achieved if high-gain (directional) antennas are placed high above ground level and are in direct line-of-sight.
10 mW	200-500 ft indoors, 8-15 km outdoors.
100 mW	400-800 ft indoors, 15-25 km outdoors.
1000 mW (1 W)	Typically provides communications up to a distance of 1000 feet or more in-building on the same floor or up/down a few levels, depending on building construction (wood, concrete, steel, etc.). In ideal outdoor conditions, up to 30 km or more can be achieved. Note that only an antenna with a gain of no more 6 dBi may be used. Any higher is a violation of FCC rules.
Adaptive	Used in noisy environments where interference may vary. Power may change over time. Note that only an antenna with a gain of no more 6 dBi may be used. Any higher is a violation of FCC rules.



**Warning:** When transmitting at the full power of 1W, FCC regulations prohibit using an antenna with a gain greater than 6 dBi (6 dB above isotropic gain).

---

**IMPORTANT:**

FCC Regulations allow up to 36 dBi effective radiated power (ERP). Therefore, the sum of the transmitted power (in dBm), the cabling loss and the antenna gain cannot exceed 36 dBi.

**1 mW = 0 dBm**

**10 mW = 10 dBm**

**100 mW = 20 dBm**

**1000 mW = 30 dBm**

For example, when transmitting 1 Watt (30 dBm), the antenna gain including cabling losses cannot exceed  $36 - 30 = 6$  dBi. If an antenna with a gain higher than 6 dBi were to be used, the power setting must be adjusted appropriately.

All MRX-900 products purchased with an antenna having a gain greater than 6 dBi will be factory-pre-configured to disable the 1W power setting, thereby making 100 mW the maximum transmitted power.

---



In an ideal situation where the communications link performs well and there is no interfering “noise” that can cause errors, set the Minimum Size to 0 and Maximum Size to 255.

### 3.9 Packet Parameters

Packet Parameters define the characteristics of the internal packets or frames which are transmitted. The settings should be set only by an expert since adequate care must be taken to maintain reliability and optimum performance. The parameters which can be set are displayed under option 9 in the main menu:

```
Packet Parameters
1) Minimum Size      0
2) Maximum Size     255
3) Retry Limit      255
4) CRC/Retransmit   Enabled
ESC to exit

Select a Parameter to Configure : _
```

1) **Minimum Size** This setting has a range of 0 to 255, and defines the number of bytes to accumulate from the DTE before transmitting a packet. Setting this value to 0 ensures that all characters sent by the DTE are immediately transmitted. The value may not exceed the maximum packet size.

2) **Maximum Size** This setting has a range of 1 to 255, and defines the maximum number of bytes from the DTE which should be encapsulated in a packet. This value should be greater than the minimum packet size, but not smaller than is necessary for reliable communications. If the wireless link is consistently good and solid, a maximum size of 255 is recommended. However, if the link is poor (e.g., experiencing excessive interference) and data is frequently retransmitted, the maximum packet size should be reduced. This decreases the probability of errors within packets, and reduces the amount of traffic in the event that retransmissions are required. Since a smaller packet size results in a proportionally higher overhead and lower overall throughput on a good connection, this should only be reduced if many errors are being detected by CRC (see Radio Statistics option of configuration).

3) **Retry Limit** This determines the number of attempts that will be made to retransmit data which failed the CRC checksum. Once the limit is reached, the modem will give up and discard the data. If the wireless connection is poor and data often needs to be retransmitted, a modem could be “tied up” trying to retransmit, thus holding up pending data. (XXX)

4) **CRC/Retransmit** This parameter is either Enabled or Disabled, and determines whether the MRX-900 will handle error-checking and manage retransmissions (to guarantee accuracy of data, possibly at the cost of throughput), or whether these functions will be handled by the software on each DTE. When this parameter is selected, the following submenu is displayed:

```
CRC/Retransmit
* 1) Enabled
  2) Disabled
ESC to exit

Select CRC usage : _
```

### 3.10 Radio Statistics

This option (selection A) displays a list of performance statistics for the unit since it was powered up. Note that this information is only available if configuration is *not* initiated immediately after a power-up cycle; loss of power will reset the statistics. The information report resembles the following:

```
Radio Statistics
Number of header packets transmitted: 4920
Number of data packets transmitted: 5933
Number of errors detected by CRC: 1
Average RSSI: 64
Press any key
```

**Number of header packets transmitted:** Gives an indication of the number of header packets transmitted since power-up and is used for troubleshooting. This value increases from 0 to 65535, at which point it “wraps around” to 0 again.

**Number of data packets transmitted:** Gives an indication of the number of data packets transmitted since power-up and is used for troubleshooting. This value increases from 0 to 65535, at which point it “wraps around” to 0 again.

**Number of errors detected by CRC:** Each packet transmitted by the MRX-900 includes a checksum against which the data on the receiving end is checked. If the CRC values do not match, an error event is added to the total error count since power-up. This statistic is only available if CRC error detection is enabled, and gives a measure of the quality of the wireless connection. Note that when errors are detected, the sending modem retransmits the packet so errors are never observed at the DTE.

Average RSSI: Indicates the average strength of the RF connection for the period since power-up. Values may have values in the following ranges:

RSSI	Meaning
< 50	Marginal link, may yield poor performance
50-60	Satisfactory link
60-70	Good link, should generally provide adequate performance
70-80	Strong link, typically very good performance
> 80	Very strong link

### 3.11 Slave List

This option (B) only appears if the unit has been set up as a Point-to-Multipoint Master or as a Repeater. When selected, the following submenu will become available:

```
Slave List
1) Add Slave
2) Delete Slave
3) Show List
4) Clear List
ESC to exit

Select an operation : _
```

1) Add Slave Selecting this option subsequently prompts for a slave address: “Add Slave Address : \_“. Enter a value from 0 to 65535 which corresponds to a Slave Unit Address, followed by Enter/Return. Use care to ensure the value is correctly entered since there is no way for the Master or Repeater to validate the entry. Up to 255 Slaves may be added to the Slave List.

2) Delete Slave This operation is used to reverse the action of option 1, removing a previously-entered slave from the Slave List. When selected, the prompt, “Delete Slave Address : \_” appears. A value from 0 to 65535 should be entered, followed by Enter/Return.

3) Show List This option displays the current list of slaves, each separated by a comma, similar to the following:

```
Select an operation : 3

List of Slaves
00001, 00002, 00020, 00032, 00050
```

4) Clear List This option removes all slaves from the Slave List, and should be used with caution. It is an alternative to repetitively using option 2 for each Slave in the list. When selected, you are prompted with the following: “Clear the entire slave list? (Y) \_”. Pressing “Y” will clear the entire list, while pressing any other key will exit and abort the command.



# A. The Configuration Menus

The following chart provides an “at-a-glance” overview of the menus available when configuring the MRX-900, as well as the valid parameters for each item.

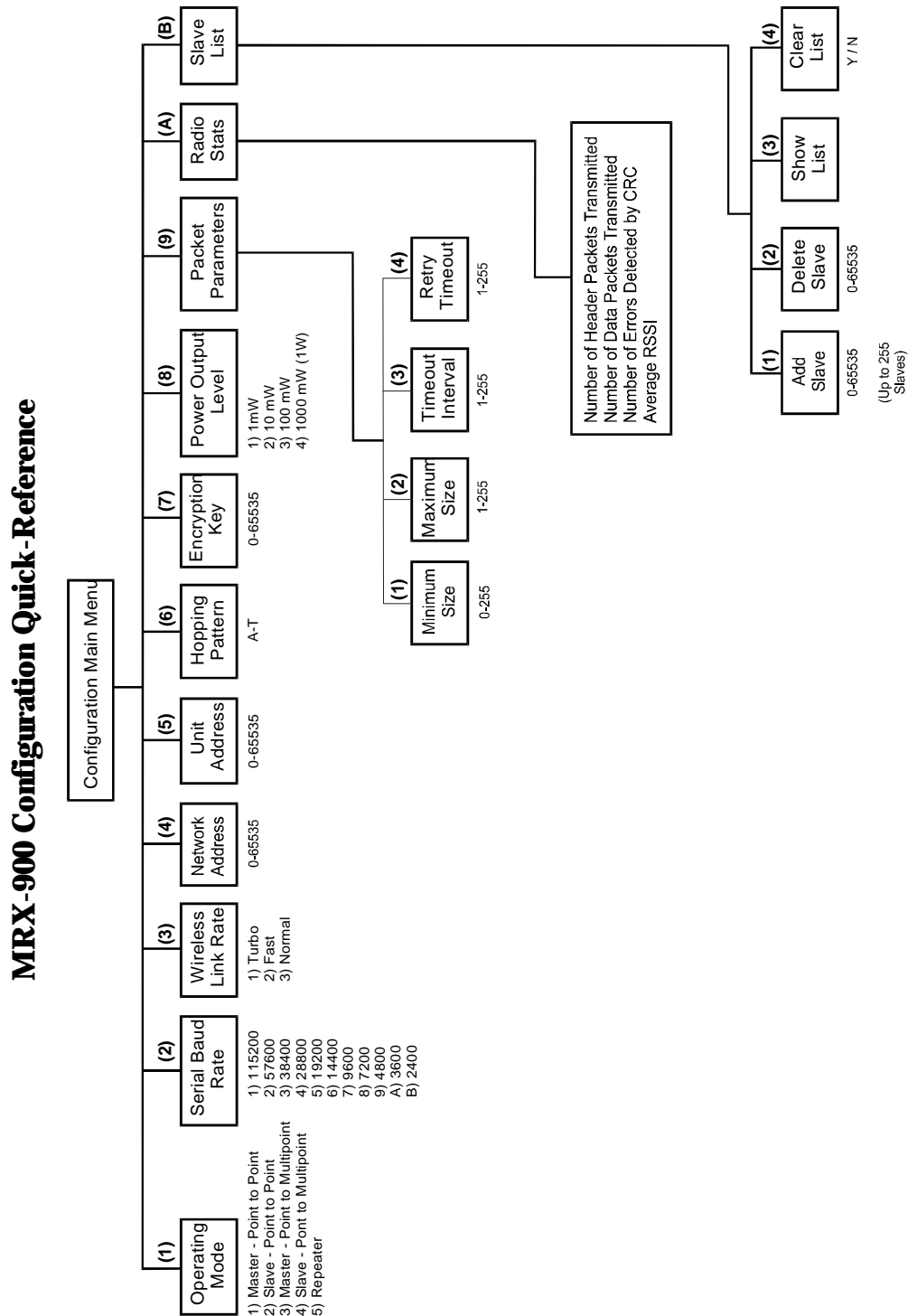



# B. Configuration Record

The following tables are provided as a convenient way to record the configuration of your MRX-900s for future reference. You may wish to copy or adapt it for your use.

## MRX-900 Record of Configuration

### Point-to-Point Operation

Unit Mode	Unit Address	Output Power Level	Serial Baud Rate	Wireless Link	Network Address (0 - 65535)	Hopping Pattern (A - T)	Encryption Key (0 - 65535)
<b>Master</b> S/N: _____	↑	<input type="checkbox"/> 1 mW <input type="checkbox"/> 10 mW <input type="checkbox"/> 100 mW <input type="checkbox"/> 1000 mW (1W)	<input type="checkbox"/> 115200 <input type="checkbox"/> 57600 <input type="checkbox"/> 38400 <input type="checkbox"/> 28800 <input type="checkbox"/> 19200 <input type="checkbox"/> 14400 <input type="checkbox"/> 9600 <input type="checkbox"/> 7200 <input type="checkbox"/> 4800 <input type="checkbox"/> 3600 <input type="checkbox"/> 2400	↑	↑	↑	↑
<b>Slave</b> S/N: _____	□	<input type="checkbox"/> 1 mW <input type="checkbox"/> 10 mW <input type="checkbox"/> 100 mW <input type="checkbox"/> 1000 mW (1W)	<input type="checkbox"/> 115200 <input type="checkbox"/> 57600 <input type="checkbox"/> 38400 <input type="checkbox"/> 28800 <input type="checkbox"/> 19200 <input type="checkbox"/> 14400 <input type="checkbox"/> 9600 <input type="checkbox"/> 7200 <input type="checkbox"/> 4800 <input type="checkbox"/> 3600 <input type="checkbox"/> 2400	<input type="checkbox"/> Turbo <input type="checkbox"/> Fast <input type="checkbox"/> Normal	□	□	□
<b>Repeater</b> S/N: _____	↓	<input type="checkbox"/> 1 mW <input type="checkbox"/> 10 mW <input type="checkbox"/> 100 mW <input type="checkbox"/> 1000 mW (1W)		↓	↓	↓	↓

Point-to-Multipoint Operation

Unit Mode	Address	Output Power Level	Serial Baud Rate	Wireless Link	Network Address (0 - 65535)	Hopping Pattern (A - T)	Encryption Key (0 - 65535)
<b>Master</b> S/N: _____	Slave List:	<input type="checkbox"/> 1 mW <input type="checkbox"/> 10 mW <input type="checkbox"/> 100 mW <input type="checkbox"/> 1000 mW (1W)	<input type="checkbox"/> 115200 <input type="checkbox"/> 57600 <input type="checkbox"/> 38400 <input type="checkbox"/> 28800 <input type="checkbox"/> 19200 <input type="checkbox"/> 14400 <input type="checkbox"/> 9600 <input type="checkbox"/> 7200 <input type="checkbox"/> 4800 <input type="checkbox"/> 3600 <input type="checkbox"/> 2400	<input type="checkbox"/> Turbo <input type="checkbox"/> Fast <input type="checkbox"/> Normal	<input type="text"/>	<input type="text"/>	<input type="text"/>
<b>Slave</b> S/N: _____	Unique Unit Address (0-65535):	<input type="checkbox"/> 1 mW <input type="checkbox"/> 10 mW <input type="checkbox"/> 100 mW <input type="checkbox"/> 1000 mW (1W)	<input type="checkbox"/> 115200 <input type="checkbox"/> 57600 <input type="checkbox"/> 38400 <input type="checkbox"/> 28800 <input type="checkbox"/> 19200 <input type="checkbox"/> 14400 <input type="checkbox"/> 9600 <input type="checkbox"/> 7200 <input type="checkbox"/> 4800 <input type="checkbox"/> 3600 <input type="checkbox"/> 2400				
<b>Slave</b> S/N: _____	Unique Unit Address (0-65535):	<input type="checkbox"/> 1 mW <input type="checkbox"/> 10 mW <input type="checkbox"/> 100 mW <input type="checkbox"/> 1000 mW (1W)	<input type="checkbox"/> 115200 <input type="checkbox"/> 57600 <input type="checkbox"/> 38400 <input type="checkbox"/> 28800 <input type="checkbox"/> 19200 <input type="checkbox"/> 14400 <input type="checkbox"/> 9600 <input type="checkbox"/> 7200 <input type="checkbox"/> 4800 <input type="checkbox"/> 3600 <input type="checkbox"/> 2400				
<b>Slave</b> S/N: _____	Unique Unit Address (0-65535):	<input type="checkbox"/> 1 mW <input type="checkbox"/> 10 mW <input type="checkbox"/> 100 mW <input type="checkbox"/> 1000 mW (1W)	<input type="checkbox"/> 115200 <input type="checkbox"/> 57600 <input type="checkbox"/> 38400 <input type="checkbox"/> 28800 <input type="checkbox"/> 19200 <input type="checkbox"/> 14400 <input type="checkbox"/> 9600 <input type="checkbox"/> 7200 <input type="checkbox"/> 4800 <input type="checkbox"/> 3600 <input type="checkbox"/> 2400				
<b>Slave</b> S/N: _____	Unique Unit Address (0-65535):	<input type="checkbox"/> 1 mW <input type="checkbox"/> 10 mW <input type="checkbox"/> 100 mW <input type="checkbox"/> 1000 mW (1W)	<input type="checkbox"/> 115200 <input type="checkbox"/> 57600 <input type="checkbox"/> 38400 <input type="checkbox"/> 28800 <input type="checkbox"/> 19200 <input type="checkbox"/> 14400 <input type="checkbox"/> 9600 <input type="checkbox"/> 7200 <input type="checkbox"/> 4800 <input type="checkbox"/> 3600 <input type="checkbox"/> 2400				
<b>Slave</b> S/N: _____	Unique Unit Address (0-65535):	<input type="checkbox"/> 1 mW <input type="checkbox"/> 10 mW <input type="checkbox"/> 100 mW <input type="checkbox"/> 1000 mW (1W)	<input type="checkbox"/> 115200 <input type="checkbox"/> 57600 <input type="checkbox"/> 38400 <input type="checkbox"/> 28800 <input type="checkbox"/> 19200 <input type="checkbox"/> 14400 <input type="checkbox"/> 9600 <input type="checkbox"/> 7200 <input type="checkbox"/> 4800 <input type="checkbox"/> 3600 <input type="checkbox"/> 2400				
<b>Slave</b> S/N: _____	Unique Unit Address (0-65535):	<input type="checkbox"/> 1 mW <input type="checkbox"/> 10 mW <input type="checkbox"/> 100 mW <input type="checkbox"/> 1000 mW (1W)	<input type="checkbox"/> 115200 <input type="checkbox"/> 57600 <input type="checkbox"/> 38400 <input type="checkbox"/> 28800 <input type="checkbox"/> 19200 <input type="checkbox"/> 14400 <input type="checkbox"/> 9600 <input type="checkbox"/> 7200 <input type="checkbox"/> 4800 <input type="checkbox"/> 3600 <input type="checkbox"/> 2400				
<b>Slave</b> S/N: _____	Unique Unit Address (0-65535):	<input type="checkbox"/> 1 mW <input type="checkbox"/> 10 mW <input type="checkbox"/> 100 mW <input type="checkbox"/> 1000 mW (1W)	<input type="checkbox"/> 115200 <input type="checkbox"/> 57600 <input type="checkbox"/> 38400 <input type="checkbox"/> 28800 <input type="checkbox"/> 19200 <input type="checkbox"/> 14400 <input type="checkbox"/> 9600 <input type="checkbox"/> 7200 <input type="checkbox"/> 4800 <input type="checkbox"/> 3600 <input type="checkbox"/> 2400				
<b>Slave</b> S/N: _____	Unique Unit Address (0-65535):	<input type="checkbox"/> 1 mW <input type="checkbox"/> 10 mW <input type="checkbox"/> 100 mW <input type="checkbox"/> 1000 mW (1W)	<input type="checkbox"/> 115200 <input type="checkbox"/> 57600 <input type="checkbox"/> 38400 <input type="checkbox"/> 28800 <input type="checkbox"/> 19200 <input type="checkbox"/> 14400 <input type="checkbox"/> 9600 <input type="checkbox"/> 7200 <input type="checkbox"/> 4800 <input type="checkbox"/> 3600 <input type="checkbox"/> 2400				
<b>Repeater</b> S/N: _____	Slave List:	<input type="checkbox"/> 1 mW <input type="checkbox"/> 10 mW <input type="checkbox"/> 100 mW <input type="checkbox"/> 1000 mW (1W)					
<b>Repeater</b> S/N: _____	Slave List:	<input type="checkbox"/> 1 mW <input type="checkbox"/> 10 mW <input type="checkbox"/> 100 mW <input type="checkbox"/> 1000 mW (1W)					
<b>Repeater</b> S/N: _____	Slave List:	<input type="checkbox"/> 1 mW <input type="checkbox"/> 10 mW <input type="checkbox"/> 100 mW <input type="checkbox"/> 1000 mW (1W)					

# C. RS-232 Interface and Cables

## C.0 RS-232 Line Signals

The MRX-900 uses a 9-pin D-sub connector for asynchronous serial I/O. The pin assignments conform to standard RS-232 signals, so a common serial cable can be used for interfacing the MRX-900 to most DTE devices.

Line signals in the RS-232 interface are described below:



### “Straight-through” DB9-to-DB9 RS-232 Cable

Modem (DCE) 9-pin male	Signal	Terminal (DTE) 9-pin
1	DCD	1
2	RX	2
3	TX	3
4	DTR	4
5	SG	5
6	DSR	6
7	RTS	7
8	CTS	8
9 (n/c)		(n/c) 9

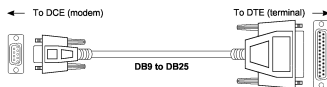

### “Straight-through” DB9-to-DB25 RS-232 Cable

Modem (DCE) 9-pin male	Signal	Terminal (DTE) 25-pin
1	DCD	8
2	RX	3
3	TX	2
4	DTR	20
5	SG	7
6	DSR	6
7	RTS	4
8	CTS	5
9 (n/c)		

Arrows denote the direction that signals are asserted (e.g., DCD originates at the DCE and tells the DTE that a carrier is present).

**DCD** *Data Carrier Detect* - When set high, DCD informs the DTE that a communications link has been established with another MRX-900.

**RX** *Receive Data* - Signals transferred from the MRX-900 are received by the DTE via RX.

**TX** *Transmit Data* - Signals are transmitted from the DTE via TX to the MRX-900

**DTR** *Data Terminal Ready* - Raised to an active level by the DTE to inform the modem that it is alive and ready for communications.

**SG** *Signal Ground* - Provides a ground reference for all signals transmitted by both DTE and DCE.

**DSR** *Data Set Ready* - Set high by the modem (DCE, or “data set” as it was formerly called) to inform the DTE that it is alive and ready for communications. DSR is the modem’s equivalent of the DTR signal.

**RTS** *Request to Send* - A “handshaking” signal which is asserted by the DTE when it is ready to transmit data. (Typically, the DCE responds by activating CTS.) Essentially, RTS is the DTE’s way of saying, “I am ready to send data whenever you are.”

**CTS** *Clear to Send* - A “handshaking” signal set active by the DCE when it has enabled communications and transmission from the DTE can commence. CTS is usually asserted after the DCE has detected a RTS signal from the DTE. It is the modem’s way of saying, “Go ahead, I am ready for your data.”

*Notes:* It is typical to refer to RX and TX from the perspective of the DTE. This should be kept in mind when looking at signals relative to the modem (DCE); the modem *transmits* data on the RX line, and *receives* on TX.

“DCE” and “modem” are often synonymous since a modem is typically a DCE device.

“DTE” is, in the most common application, is a device such as a computer.

## C.1 DTE-to-DCE (Straight-Through) Cables

Due to the variety of cabling requirements by each user of the MRX-900, interface cables required for DTE-to-DCE connection are user-supplied items. Unless the RS-232 port or connector on the DTE deviates from the common pin assignments, it is recommended that pre-fabricated shielded cables (and interface adapters, if necessary) be purchased for your application to ensure optimal performance and reliability. In cases where an RJ-45 DTE termination is required, the cable will need to be designed according to the DTE’s RJ-45 pinout; this 8-position connector has no standard assignment of signals and varies greatly between devices and manufacturers.

If cables must be fabricated, the wiring diagrams provided should be used. For best results, it is recommended that cables be no longer than necessary to interface the DTE and DCE (up to about 25 feet).

**“Crossover” / “Null”  
DB9-to-DB9  
RS-232 Cable**

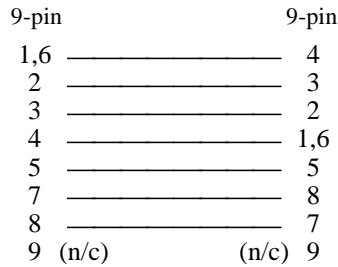

**“Crossover” / “Null”  
DB9-to-DB25  
RS-232 Cable**

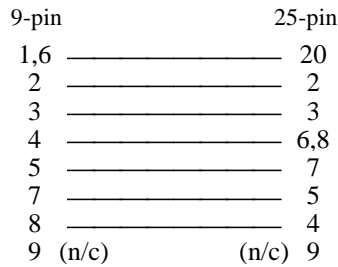

**“Crossover” / “Null”  
DB25-to-DB25  
RS-232 Cable**

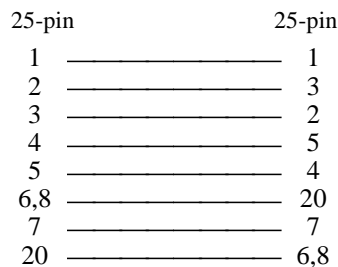

Note that in all cases, the DSR and DCD lines are tied together (lines 1 and 6 for DB9; 6 and 8 for DB25).

**DCE DB9 Loopback Plug**

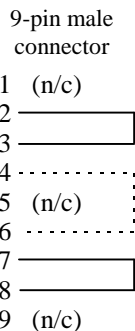

## C.2 Crossover / Null Modem Cables

Typically, establishing a DTE-to-DCE connection is achieved using a straight-through cable as described earlier. In some instances, generally when a direct DTE-to-DTE or DCE-to-DCE connection is desired, a crossover cable (also known as rollover, null-modem, or modem-eliminator cable) is used. Using a straight-through cable will not work

In a DTE-to-DTE connection, the crossover cable essentially functions by deceiving each DTE into “thinking” that it is connected to a modem. Similarly, a DCE connected to a DCE “believes” it is connected to a DTE. The data transmission is handled such that transmitted data (TX) from one device is driven to the receive data line (RX) of the other. RTS is associated with CTS. Since a DCE in a typical DTE-to-DCE connection usually must indicate its own online status (via DSR) as well as its connection to another DCE (via DCD), these are relayed together as a ready-state indicator from the DTE via DTR.

Wiring diagrams for the most common cables of this type are provided for your reference.

## C.3 Loopback Plug

Occasionally, you may wish to perform diagnostic or benchmark tests on the data transmission between two MRX-900s. A common test is the loopback, whereby an MRX-900, connected to a DTE, communicates with another MRX-900, whose serial port has been fitted with a DCE loopback plug. By so doing, all data sent by the DTE should be wirelessly transmitted to the remote MRX-900, which echoes back the data to the originator, namely the DTE. Essentially the same data is transmitted twice: once to the remote modem, and the second time as it is re-transmitted back from the remote modem. Such tests are useful for testing the performance of the wireless link, including throughput, bit error rate, packet loss, and a number of other measures.

The wiring for a basic 9-pin DCE loopback plug is provided, which can be constructed simply by tying together pins 2 and 3, as well as 7 and 8, on a male DB9 connector.

Testing that a DTE serial port is functional is often achieved easily by using a DTE loopback plug, which can be constructed similarly to the DCE loopback plug for a 9-pin connector. The gender is often different (use a female connector for use on a common PC), but the same pins are tied together: 2 with 3, and 7 with 8. Additionally, pins 4 and 6 should be tied together. (For a 25-pin DTE loopback plug, connect pins 2 with 3, 4 with 5, and 6 with 20.)

# D. Surface or Wall Mounting

The drill template and dimensional figure below has been provided to facilitate placement in case you wish to mount your MRX-900. Make a copy of the template at 100% scale and drill through the paper at each of the cross-hairs. Screw heads should be no larger than 5/16" diameter, with outer screw shaft of no more than 1/8". If mounted with the rubber footprint on bottom of unit, about 1/4" clearance should be left between surface and bottom of screw head; otherwise, unit can be mounted flush with surface. Ensure that there is adequate clearance around unit, including room for cables and antenna.

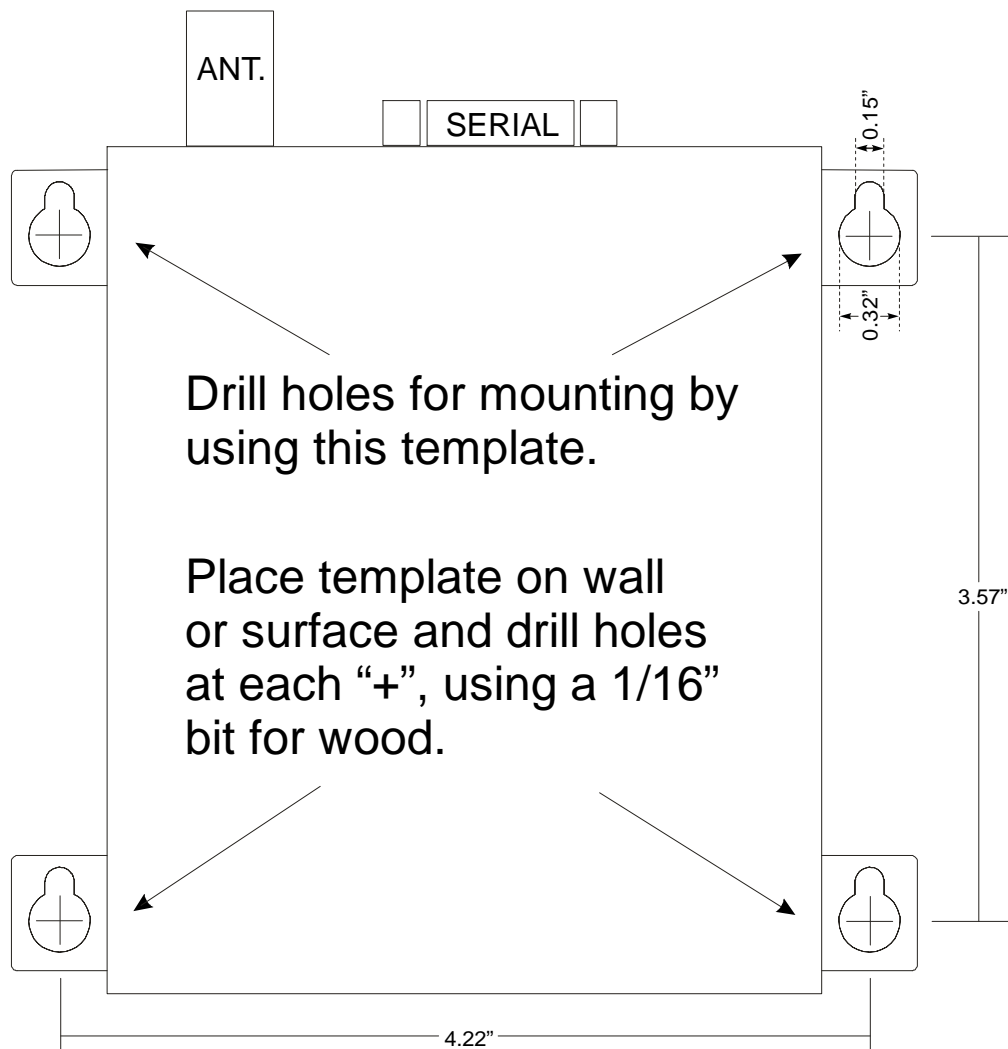
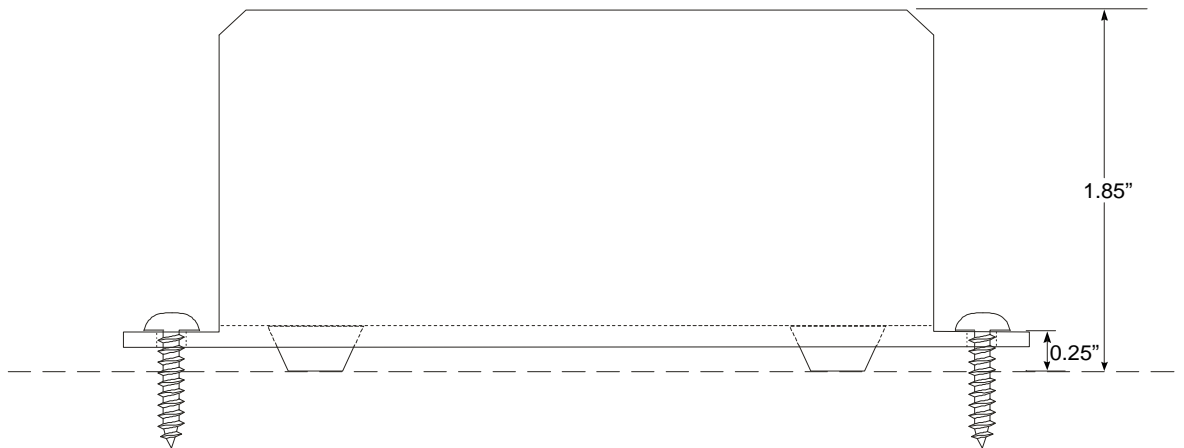





# E. Troubleshooting

---

Here are solutions to some of the common problems and symptoms that may be experienced.

---

**Problem:** *I am trying to set up the MRX-900 but I cannot get the configuration menu to appear.*

- Solutions:**
1. Make sure you are depressing the Configuration Button for at least 2 or 3 seconds. The Configuration Menu, by design, only shows up after the button has been held briefly to prevent unintentional triggering.
  2. Check that the power adapter is snugly inserted into the power input jack, and that the AC-outlet is live. You can verify that the MRX-900 is operational and that it is receiving power by the continuous illumination of the receive LED.
  3. Ensure that your RS-232 cable is the correct type – that it is a straight-through rather than a crossover or null-modem cable, and that it is the correct cable for your terminal. Also ensure that the mating connectors are seated properly.
  4. Verify that you are using the correct data port and that it is configured properly (this check may be aided by use of a DTE-loopback plug, as explained in section C.3). Ensure that the software has the correct communications settings for configuration: 9600 bps, 8 bits, no parity, 1 stop bit (8N1). If the serial communications between the MRX-900 and your terminal is working correctly, an initialization message should appear each time you power up the unit.

---

**Problem:** *I have configured my MRX-900s, but I cannot achieve a communications connection. The RSSI LEDs are **unlit**.*

- Solutions:**
1. Ensure that the Wireless Link Rate, Network Address, and Hopping Pattern are the same for all units. If using the modems in multipoint operation, ensure that each Slave has a unique Unit Address and they are included in the Slave List of Repeaters (if applicable) and of the Master. In point-to-point mode, ensure the Unit Address on both Master and Slave are the same. Once these settings are correct, the RSSI LEDs should illuminate when communicating units are powered up.
  2. The power level is too high or too low for the current arrangement of MRX-900s. First, ensure that antennas are properly and snugly connected. If the units are in very close proximity (within several feet) and the power level is too high, they will be saturated and may not operate efficiently. Conversely, if the modems are far away from each other or there are many obstacles between them, a higher level may be required for the modems to pick up each other's signal.

---

**Problem:** *I have configured my MRX-900s, but I cannot achieve a communications connection. The RSSI LEDs are **lit**.*

- Solutions:**
1. Verify that the serial baud rate between each MRX-900 and its connecting DTE are the same.
  2. Isolate the problem by directly connecting the DTEs using a crossover cable and setting the port speeds on both ends the same. If this fails, then the problem is most likely attributable to the DTE/software application, and use of the MRX-900 in this circumstance will also fail. If the hard wire connection is successful, then the problem may be a cabling issue. Ensure that all cables are straight-through RS-232 cables and that they are connected properly to all devices.

---

**Problem:** *I have the serial data ports on both my DTEs and MRX-900s set the same, but I cannot achieve a throughput near serial rate I've set up.*

- Solutions:**
1. Verify that the Wireless Link Rate on all modems are set to a rate which provides a wireless link higher than the serial links, since a lower wireless rate will “bottleneck” the communications link.

2. If you are using an MRX-900 as a Repeater, it will cut the effective throughput roughly in half because of its “store and forward” nature; the repeater spends half of its time receiving data and the other half transmitting the received data.
3. Although some high speed rates are achieved under ideal conditions, various factors may reduce the effective speed. This includes external RF (radio frequency) interference from sources such as cellular telephones and base stations. When the airwaves are “noisy”, errors can be introduced into the data stream which force the modems to retransmit (if CRC-16 error detection is turned on), consequently compromising effective throughput. Possible solutions include use of high-gain (directional) antennas or relocation of antennas if possible (higher, and possibly a few feet laterally).

---

**Problem:** *I seem to keep losing characters and/or received data is not the same as transmitted data over my MRX-900s*

- Solutions:**
1. By enabling CRC-16 error detection, the MRX-900s will automatically detect lost or corrupted data and will resend packets to ensure accuracy. Check to see that this option is enabled (recommended) and see if the situation improves.
  2. If CRC-16 error detection is enabled and this problem is occurring, it is likely due to the link between the MRX-900 and the DTE device, or the DTE device itself. Possible causes of this include:
    - a) unshielded and/or too long a serial cable - try replacing the cable with one that is shorter, and ensure it is shielded, particularly if the environment in which the equipment resides is subject to electromagnetic interference.
    - b) absence of a 16550 UART on the DTE serial port - if the equipment being used is older, it may have an 8250 or other UART which does not provide adequate buffering capabilities, especially at rates higher than 9600 baud. Try replacing the serial interface driver chip or serial card if possible and high-speed communications is necessary. Otherwise, a lower serial baud rate (on both the modem and DTE) may help cure the problem.
    - c) if operating in a multi-tasking environment, the processor may not be fast enough to handle multiple processes or threads while keeping up with the flow of serial data - if possible, reduce the number of concurrently-running processes, or retry the operation in a single-task environment. Alternatively, try lowering the serial baud rate (modem and DTE) to a speed that the DTE can keep up with.
-

# F. Technical Specifications

## Electrical/Physical

Data Interface	Asynchronous RS-232, 9-pin female D-sub
Signals	Sig. Gnd, TX, RX, DCD, DSR, DTR, RTS, CTS
Bandwidth / Data Rate	2,400 - 115,200 bps, uncompressed half-duplex, Approx. 100 kbps sustained in intelligent asymmetrical full-duplex transmission mode
Communications Range <sup>1</sup>	30 kilometres (19 miles)
Power Requirements	9.0 VDC, 1.0 Amp
Power Consumption	600 mA at 1 W transmit, 200 mA receive
Operating Frequency	902 - 928 MHz
System Gain	135 dB
Sensitivity	-105 dBm
Output Power	1mW, 10mW, 100mW, 1W (user-selectable or adaptive)
Spreading Code	Frequency Hopping
Hopping Patterns	20 pseudo-random, user-selectable
Error Detection	CRC-16 with auto re-transmit
Enclosure material	Milled aluminum, raven-black baked powder coat finish
Dimensions (WxDxH)	Encl: 3.72" x 4.25" x 1.72" (94.5 mm x 108.0 mm x 43.7 mm) With extrusions (mounting legs, rear connectors): 4.72" x 5.25" x 1.72" (119.9 mm x 133.4 mm x 43.7 mm)
Weight	420 grams (with included antenna)
Operating Environment	Temperature: -30 to +60°C Humidity: 5 to 95%, non-condensing
Storage Temperature	-40 to 90°C

1. Clear line-of-sight, elevated high-gain antennas.



# G. Glossary

## Terminology Used in the MRX-900 Operating Manual

**Asynchronous communications** A method of telecommunications in which units of single bytes of data are sent separately and at an arbitrary time (not periodically or referenced to a clock). Bytes are “padded” with start and stop bits to distinguish each as a unit for the receiving end, which need not be synchronized with the sending terminal.

**Attenuation** The loss of signal power through equipment, lines/cables, or other transmission devices. Measured in decibels (dB).

**Bandwidth** The information-carrying capacity of a data transmission medium or device, usually expressed in bits/second (bps).

**Baud** Unit of signaling speed equivalent to the number of discrete conditions or events per second. If each signal event represents only one bit condition, then baud rate equals bits per second (bps) – this is generally true of the serial data port, so *baud* and *bps* have been used interchangeably in this manual when referring to the serial port; this is not always the case during the DCE-to-DCE communications, where a number of modulation techniques are used to increase the bps rate over the baud rate.

**Bit** The smallest unit of information in a binary system, represented by either a 1 or 0. Abbreviated “b”.

**Bits per second** (b/s or bps) A measure of data transmission rate in serial communications. Also see *baud*.

**Byte** A group of bits, generally 8 bits in length. A byte typically represents a character of data. Abbreviated “B”.

**Characters per second** (cps) A measure of data transmission rate for common exchanges of data. A character is usually represented by 10 bits: an 8-bit byte plus two additional bits for marking the start and stop. Thus, in most cases (but not always), *cps* is related to *bits per second* (*bps*) by a 1:10 ratio.

**CRC** (Cyclic Redundancy Check) An error-detection scheme for transmitted data. Performed by using a polynomial algorithm on data, and appending a checksum to the end of the packet. At the

receiving end, a similar algorithm is performed and checked against the transmitted checksum.

**Crossover cable** (Also known as rollover, null-modem, or modem-eliminator cable) A cable which allows direct DTE-to-DTE connection without intermediate DCEs typically used to bridge the two communicating devices. Can also be used to make cabled DCE-to-DCE connections. The name is derived from “crossing” or “rolling” several lines, including the TX and RX lines so that transmitted data from one DTE is received on the RX pin of the other DTE and vice-versa.

**Data Communications Equipment** (DCE, also referred to as Data Circuit-Terminating Equipment, Data Set) A device which facilitates a communications connection between *Data Terminal Equipment* (DTEs). Often, two or more compatible DCE devices are used to “bridge” DTEs which need to exchange data. A DCE performs signal encoding, decoding, and conversion of data sent/received by the DTE, and transmits/receives data with another DCE. Common example is a modem.

**Data Terminal Equipment** (DTE) An end-device which sends/receives data to/from a DCE, often providing a user-interface for information exchange. Common examples are computers, terminals, and printers.

**dBm** Stands for “Decibels referenced to one milliwatt (1 mW)”. A standard unit of power level commonly used in RF and communications work.  $n$  dBm is equal to  $10^{(n/10)}$  milliwatt, so 0dBm = 1mW, -10dBm = 0.1mW, -20dBm = 0.01mW, etc.

**DCE** See *Data Communications Equipment*.

**DTE** See *Data Terminal Equipment*.

**Flow Control** A method of moderating the transmission of data so that all devices within the communications link (DTEs and DCEs) transmit and receive only as much data as they can handle at once. This prevents devices from sending data which cannot be received at the other end due to conditions such as a full buffer or hardware not in a ready state. This is ideally handled by hardware

using flow-control and handshaking signals, but can be controlled also by software using X-ON/X-OFF (transmitter on/off) commands.

**Frequency-hopping** A type of *spread spectrum* communication whereby the carrier frequency used between transmitter and receiver changes repeatedly in a synchronized fashion according to a specified algorithm or table. This minimizes unauthorized jamming (interference) and interception of telecommunications.

**Full-duplex** Where data can be transmitted, simultaneously and independently, bi-directionally.

**Half duplex** Exists when the communications medium supports bi-directional transmission, but data can only travel in one direction at the same time.

**Handshaking** A flow-control procedure for establishing data communications whereby devices indicate that data is to be sent and await appropriate signals that allow them to proceed.

**Line-of-sight** Condition in which a transmitted signal can reach its destination by travelling a straight path, without being absorbed and/or bounced by objects in its path.

**Master** The station which controls and/or polls one or more slave stations in a point-to-point or point-to-multipoint network. Often functions as a server or hub for the network.

**Non-volatile memory** Memory which retains information which is written to it.

**Null modem cable** See *Crossover cable*.

**Point-to-point** A simple communications network in which only two DTEs are participants.

**Point-to-multipoint** A communications network in which a *master* DTE communicates with two or more *slave* DTEs.

**Repeater** A device which automatically amplifies or restores signals to compensate for distortion and/or attenuation prior to retransmission. A repeater is typically used to extend the distance for which data can be reliably transmitted using a particular medium or communications device.

**RS-232** (Recommended Standard 232; more accurately, RS-232C or EIA/TIA-232E) Defined by the EIA, a widely known standard electrical and physical interface for linking DCEs and DTEs for serial data communications. Traditionally

specifies a 25-pin D-sub connector, although many newer devices use a compact 9-pin connector with only the essential signaling lines used in asynchronous serial communications. Lines have two possible states: “high” (on, active, asserted, carrying +3 to +25 V) or “low” (off, inactive, disasserted, carrying -3 to -25 V).

**RTU** (Remote Terminal Unit) A common term describing a DTE device which is part of a wide-area network. Often a RTU performs data I/O and transmits the data to a centralized station.

**Serial communications** A common mode of data transmission whereby character bits are sent sequentially, one at a time, using the same signaling line. Contrast with parallel communications where all bits of a byte are transmitted at once, usually requiring a signal line for each bit.

**Shielded cable** Interface medium which is internally shrouded by a protective sheath to minimize external electromagnetic interference (“noise”).

**Slave** A station which is controlled and/or polled by the master station for communications. Typically represents one end of a point-to-point connection, or one of the terminal nodes in a point-to-multipoint network. Often a RTU is linked by a slave DCE.

**Spread spectrum** A method of transmitting a signal over a wider bandwidth (using several frequencies) than the minimum necessary for the originally narrowband signal. A number of techniques are used to achieve spread spectrum telecommunications, including *frequency hopping*. Spread spectrum provides the possibility of sharing the same band amongst many users while increasing the tolerance to interference and noise, and enhancing privacy of communications.

**Throughput** A measure of the rate of data transmission passing through a data communication system, often expressed as bits or characters per second (bps or cps).