

MICROSCAN®

LVS® 7510 Integrated System
Operations Manual
Version 20.2.X

Copyright ©2018
Omron Microscan Systems, Inc.
Tel: +1.425.226.5700 / 800.762.1149
Fax: +1.425.226.8250

All rights reserved. The information contained herein is proprietary and is provided solely for the purpose of allowing customers to operate and/or service Omron Microscan-manufactured equipment and is not to be released, reproduced, or used for any other purpose without written permission of Omron Microscan.

Throughout this manual, trademarked names might be used. We state herein that we are using the names to the benefit of the trademark owner, with no intention of infringement.

GS1 Solution Partner



Disclaimer

The information and specifications described in this manual are subject to change without notice.

Latest Manual Version

For the latest version of this manual, see the Download Center on our web site at:

www.microscan.com.

Technical Support

For technical support, e-mail:

Americas_support@microscan.com

EMEA_support@microscan.com

APAC_support@microscan.com

China_support@microscan.com

Warranty

For current warranty information, see: www.microscan.com/warranty.

Omron Microscan Systems, Inc.

United States Corporate Headquarters

+1.425.226.5700 / 800.762.1149

United States Northeast Technology Center

+1.603.598.8400 / 800.468.9503

European Headquarters

+31.172.423360

Asia Pacific Headquarters

+65.6846.1214

Table of Contents

Safety Instructions	5
Important Information	5
Introduction.....	6
Software Modules	6
Functional Characteristics.....	8
Modes of Operation.....	11
Design Mode	14
Production Mode	17
Log In	20
Welcome Screen Overview	22
Settings	23
Administration.....	25
Language	34
Log In	34
About.....	34
Design Mode: Create a New Template	35
Create a Template Using Automatic Setup.....	36
Create a Template Using Manual Setup.....	39
Design Mode: Load an Existing Template	84
Design Mode: Retrieve a Template from Archive.....	85
Design Mode: Ready to Run.....	86
Make Ready Mode	88
Production Mode: Import a New Job.....	89
AutoExecute Functionality	90
Production Mode: Load an Existing Job.....	91
Production Mode: Ready to Run.....	92
Make Ready Mode	94
Design and Production Mode: Running.....	95
Error Display	97
Blemish Error Display.....	100
Reports / QC File Viewer	101
Sample Reports	102
Preventive Maintenance.....	108
Troubleshooting	108
Mechanical Diagrams.....	109
LVS-7510 Basic Wire Diagram	109

Appendix A: User Configurable Settings	110
Settings Configuration Editor	110
List of User Configurable Settings.....	112
Appendix B: Epedigree	149
Appendix C: ImageSaver Instructions	152
Saving Raw Images Without a Label Repeat	152
Saving Images WITH a Label Repeat.....	156
Appendix D: Upgrading Software	160
Appendix E: Automatic Login	165
Automatic Login Settings	165
Automatic Login Instructions	166
Appendix F: Managing Operator Permissions in Microsoft® Active Directory	168
Overview	168
Enable Active Directory.....	169
Active Directory User Permissions.....	177
Appendix G: TCP/IP Control	179
TCP/IP Configuration Settings	179
TCP/IP Commands and Output Data Summary	180
TCP/IP Commands Protocol.....	181
TCP/IP Output Data Protocol.....	187
Appendix H: LVS-7510 Printronix Integrated System	189
Printing Stopped Error Message.....	189
Foreground and Background Errors	190
Printing Timeout Error	190
Reset the Printer	191
Customizing the “Printing Stopped” and “Manual Intervention Required” Messages.....	192
Form Feed Button	193
Appendix I: Print Job Button	194
Appendix J: Windows® Lockdown	197
Shut Down the System.....	198
Unlock	198
Appendix K: Using the LVS-7510 Comparator Function	200
Installing ScanProof™ Software	200
Launching ScanProof™ Software.....	201

Safety Instructions

This unit has been carefully designed to provide years of safe, reliable performance. However, as with all electrical equipment, there are some basic precautions that you should follow to avoid personal injury or damage to the system:

- Before using the system, carefully read all the installation and operating instructions.
- Observe all warning instruction labels on the system.
- To protect your system from overheating, make sure no openings on the system are blocked.
- Never insert anything into the openings of the system.
- Do not use the system near water or spill liquid into it.
- All components used to create your system are UL and CE approved. All circuits were designed to incorporate maximum safety. However, any equipment using electrical voltages may cause personal injury if improperly handled.
- Do not attempt to work on the system with the main power lines connected.
- Ensure that the AC power source matches the ratings listed for the system. If unsure, check with your dealer or local utility provider.
- Do not place the AC power cord where it can be stepped on. If the AC power cord becomes damaged or frayed, replace it immediately.
- Avoid looking directly into any system lights. If you need to examine the lights, or look at any component near the lights, be sure to first turn off the lights. If the lights cannot be turned off, then wear polarized sunglasses while examining the lights.
- To avoid damaging the system, turn off and unplug the system before cleaning.
- If the system ever needs repair, consult Omron Microscan or your Omron Microscan Distributor.

Important Information

- Due to continual product improvements, the product you receive may differ from the content outlined in this guide. If you have questions about your product that are not covered in this guide, please contact your Omron Microscan representative or Omron Microscan headquarters at +1-800-762-1149 or
 - Americas_support@microscan.com
 - EMEA_support@microscan.com
 - APAC_support@microscan.com
 - China_support@microscan.com
- The LVS-7510 Integrated System arrives to your site packaged in specially designed shipping cartons. Do not discard the shipping cartons in case you must ship or store the system for any reason. Failure to use these cartons when returning your product to Omron Microscan will void warranty.
- The LVS-7510 Integrated System supports Windows® 7 Professional, Windows® 8.1 Professional, and Windows® 10 Professional.
- LVS-7510 includes technologies covered under United States Patent # 8,939,368 B2.

Introduction

Software Modules

The LVS-7510 offers 100% print quality inspection and barcode verification for Thermal and Thermal Transfer Printers. LVS-7510 features include:

- Barcode Validation (Reading of 1D and 2D codes)
- Barcode Verification (Grading of 1D and 2D codes to ISO/IEC Standards)
- Master-to-Label Comparison (Blemish Detection)
- Optical Character Recognition (OCR)
- Optical Character Verification (OCV)
- Number Validation
- Data and Code Matching

The LVS-7510 is a modular system, which means that you can check the print quality for *any* of the aforementioned areas, or for *all* of the areas. The features are listed below.

Important:

- The maximum system speed is 10 inches per second.
- The LVS-7510 uses a monochrome camera to capture images, which makes images appear in black and white. Some images in this guide were captured with a color camera, so you will notice some images with color.

Barcode Validation

The LVS-7510 decodes 1D (linear) and 2D (two-dimensional) codes (including ECC-200 Data Matrix, GS1 Data Matrix, Composite, QR Code, GS1 QR Code, PDF-417 and Micro PDF) and determines if the code is “readable.” No attempt is made to grade the codes according to any standard. A check is made for presence of a GS1 FNC1 character at the beginning of a GS1 type bar code.

Barcode Verification

The LVS-7510 verifies (decodes and grades) 1D (linear) and 2D (two-dimensional) codes including ECC-200 Data Matrix, Composite, QR Code, PDF-417 and Micro PDF symbologies according to the internationally accepted rules of the applicable symbology specifications and ISO 15415 and 15416.

The LVS-7510 displays a “real-time” graph indicating the overall ISO grade, which allows the operator to see trends in print quality for several hundred labels that were just inspected. When an error is detected, the “real-time” graph changes color. The system can also be programmed to “stop the press” when an error occurs (the appropriate hardware must be purchased for this feature).

Master-to-Label Comparison (Blemish Detection)

The Master-to-Label Comparison module, also referred to as blemish detection, identifies and tracks potential print errors such as die cut errors, broken letters, skews, smears, spots, voids, wrinkles, missing copy, and other print quality defects. The Master-to-Label Comparison module also includes an “ignore area” function which accounts for variable image data within a pattern-matching zone and does not report them as blemishes. All inspection is completed at thermal printer speeds up to 10 ips.

Note: The LVS-7510 uses red light (660 nm) to detect blemishes; thus, color blemishes in the red spectrum may not be properly detected.

IMPORTANT: The LVS-7510 is designed to inspect labels, record and display the results, and supply optional signals to the printer or other external system. The LVS-7510 cannot “stop”, “score out void” or “reprint” labels; these are functions that are the responsibility of the printer. Be sure your printer has these necessary capabilities and interface connections to utilize the output capabilities of the LVS-7510.

Optical Character Recognition (OCR)

Unlike the OCV Module, this module “reads” characters and reports the data content at font sizes as low as six points (one point is defined as approximately 1/72nd of an inch or .35 mm). This data is typically variable and the content remains unknown until it is read. It is important to note that the system can be trained to know what to expect for every character position. In other words, the software can be programmed on what characters to expect: alpha, numeric, or special characters. Many fonts are used in the printing industry. The LVS-7510 is designed to learn new fonts as necessary. Refer to the “OCR and OCV Guidelines” section below for more information.

Optical Character Verification (OCV)

The OCV module verifies human readable characters at font sizes as low as six points (one point is defined as approximately 1/72nd of an inch or .35 mm). The LVS-7510 OCV module ensures that a string of sequential alpha-numeric characters is verified against a known field or file. In other words, you program the software to detect what characters should appear and the software reports if the characters actually appeared. The software will also return a percentage score as to how well the character(s) matched to the trained character(s). Refer to the “OCR and OCV Guidelines” section below for more information.

OCR and OCV Guidelines

- Characters must not touch or overlap
- All uppercase letters in any font are allowed
- Lowercase letters, uppercase letters, and some special characters are allowed in OCR-B MT font (6 to 14 points). Shown to the right are the letters, numbers, and special characters supported by OCR-B MT font (6 to 14 points)
- Monospaced fonts, like OCR-B, are preferred and perform better in the LVS-7510
- Do not attempt to re-learn any of the supplied OCR-B MT fonts

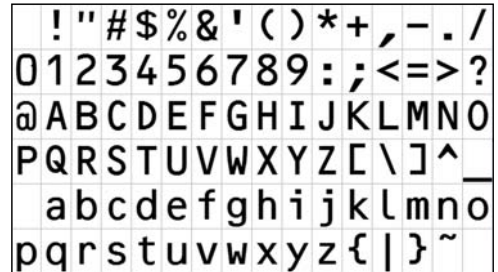

OCR-B font set

Number Validation

Verifies the expected order of any numerical series, detects duplicates and sequence errors, and matches variable numbers with external data files.

Data and Code Matching

Verifies encoded data that represents human readable information and ensures synchronicity of multiple fields within a label.

Functional Characteristics

The characteristics listed below apply to the LVS-7510 5.4" (137 mm) and 8.5" (216 mm) readheads.

Line Scan Camera:	400 DPI. Floating Sensor Head
Light Source:	Red Light. 660 nm
Inputs / Outputs:	USB 2.0 port. 5-Volt Power Supply
Maximum System Speed:	10 inches (254 mm) per second

ISO Verification

Verify:	Any combination of linear, matrix or stacked codes to ISO print quality standards including: <ul style="list-style-type: none"> Linear (1D) Verifier Conformance (ISO/IEC 15416) 2-Dimensional (2D) Verifier Conformance (ISO/IEC 15415)
Orientation & Number:	Ladder or Pickett fence orientation and any number of codes on a label.
Read and Analyze:	1D and 2D to published International specifications, with an overall ISO (ANSI) grade.
Minimum Linear (1D) Narrow Bar Width:	<ul style="list-style-type: none"> Read only: 6.3 Mils (.0063") (.160 mm) Verification: 8.8 Mils (.0088") (.223 mm)
Minimum 2D Cell Size:	<ul style="list-style-type: none"> Read only: 10.0 Mils (.0100") (.254 mm) Verification: 12.5 Mils (.0125") (.317 mm)
Reporting:	Detailed data to be reported is in .csv file format for extraction by the end user. Immediate reporting is available for viewing via the monitor.

Optical Character Verification (OCV)

Minimum Human Readable:	.083 inches / 2.12 mm / 6 Printer Points
Data:	Verifies variable and fixed data ascending, descending or from a file.
Read or Verify:	Sequential string of alphanumeric characters (numbers 0 to 9 and letters A to Z) against known field or database. Guidelines: <ul style="list-style-type: none"> Characters must not touch or overlap All uppercase letters in any font are allowed Lowercase letters, uppercase letters, and some special characters are allowed in OCR-B MT font (6 to 14 points). Shown to the right are the letters, numbers, and special characters supported by OCR-B MT font (6 to 14 points) Monospaced fonts, like OCR-B, are preferred and perform better in the LVS-7510 Do not attempt to re-learn any of the supplied OCR-B MT fonts

OCR-B font set	<table border="1"> <tr> <td>!</td><td>"</td><td>#</td><td>\$</td><td>%</td><td>&</td><td>'</td><td>(</td><td>)</td><td>*</td><td>+</td><td>,</td><td>-</td><td>.</td><td>/</td> </tr> <tr> <td>0</td><td>1</td><td>2</td><td>3</td><td>4</td><td>5</td><td>6</td><td>7</td><td>8</td><td>9</td><td>:</td><td>;</td><td><</td><td>=</td><td>></td><td>?</td> </tr> <tr> <td>@</td><td>A</td><td>B</td><td>C</td><td>D</td><td>E</td><td>F</td><td>G</td><td>H</td><td>I</td><td>J</td><td>K</td><td>L</td><td>M</td><td>N</td><td>O</td> </tr> <tr> <td>P</td><td>Q</td><td>R</td><td>S</td><td>T</td><td>U</td><td>V</td><td>W</td><td>X</td><td>Y</td><td>Z</td><td>[</td><td>\</td><td>]</td><td>^</td><td>_</td> </tr> <tr> <td>a</td><td>b</td><td>c</td><td>d</td><td>e</td><td>f</td><td>g</td><td>h</td><td>i</td><td>j</td><td>k</td><td>l</td><td>m</td><td>n</td><td>o</td><td></td> </tr> <tr> <td>p</td><td>q</td><td>r</td><td>s</td><td>t</td><td>u</td><td>v</td><td>w</td><td>x</td><td>y</td><td>z</td><td>{</td><td> </td><td>}</td><td>~</td><td></td> </tr> </table>	!	"	#	\$	%	&	'	()	*	+	,	-	.	/	0	1	2	3	4	5	6	7	8	9	:	;	<	=	>	?	@	A	B	C	D	E	F	G	H	I	J	K	L	M	N	O	P	Q	R	S	T	U	V	W	X	Y	Z	[\]	^	_	a	b	c	d	e	f	g	h	i	j	k	l	m	n	o		p	q	r	s	t	u	v	w	x	y	z	{		}	~	
!	"	#	\$	%	&	'	()	*	+	,	-	.	/																																																																																		
0	1	2	3	4	5	6	7	8	9	:	;	<	=	>	?																																																																																	
@	A	B	C	D	E	F	G	H	I	J	K	L	M	N	O																																																																																	
P	Q	R	S	T	U	V	W	X	Y	Z	[\]	^	_																																																																																	
a	b	c	d	e	f	g	h	i	j	k	l	m	n	o																																																																																		
p	q	r	s	t	u	v	w	x	y	z	{		}	~																																																																																		

Blemish Detection

Print faults	Detects skew, smear, print registration, die-cut errors, edge determination and missing information.
Variable Data	Allows user specified variable data within a pattern matching zone.
Red Light (660 nm)	The LVS-7510 uses red light (660 nm) to detect blemishes; thus, color blemishes in the red spectrum may not be properly detected.
Minimum point size	Blemish Inspection: 5 Mils / .005" / .126 mm Missing Period: 5 Mils / .005" / .126 mm

Number Validation

- Validates numerical order requirements (ascending, descending, or alpha numeric series) to ensure numbers are in the expected order
- Use external data file for the validation of random number sequence
- Detects duplicate numbers

Matching

- Matches decoded data from a barcode to human readable text of that barcode
- Matches multiple fields of data within the label area being inspected

Supported Symbologies

Below are a few of the symbologies supported by the LVS-7510. Contact Omron Microscan for a full list of supported symbologies.

Aztec	GS1 Databar-14
Codabar	GS1 Data Matrix
Code 128	Interleaved 2 of 5 (ITF)
Code 39	Laetus Pharmacode
Code 93	Micro QR Code
Data Matrix	PDF417
DataBar expanded	QR Code
EAN-13	UPC-A
EAN-13 (2-digit supplemental) Stacked	UPC-A (2-digit supplemental)
EAN-13 (5-digit supplemental)	UPC-A (5-digit supplemental)
EAN-8	UPC-E
ECC-200 Data Matrix	UPC-E (2-digit supplemental)
GS1-128	UPC-E (5-digit supplemental)
GS1 Databar Limited	All applicable GS1 composite components
GS1 Databar	

International Standards

- ISO/IEC 15415
- ISO/IEC 15416
- All supported ISO/IEC symbology specifications

Modes of Operation

The LVS-7510 Integrated System software has two modes of operation: **Design** and **Production** modes. The reason for the different modes is to support the segregation of duties and provide a productive and secure environment for label production and validation.

Design and Production mode units are usually separate physical systems; however, it is possible to configure one LVS-7510 system to operate in both modes and switch between Design and Production modes when needed. The LVS-7510 is purchased as a Dual mode system. The software license codes are to remain with the system hardware and are not transferable.

The primary differences between the two modes are that templates are created in *Design mode* only. Templates are then promoted to production and become jobs. *Production mode* is used to execute the promoted jobs. Highlights of each mode are listed below.

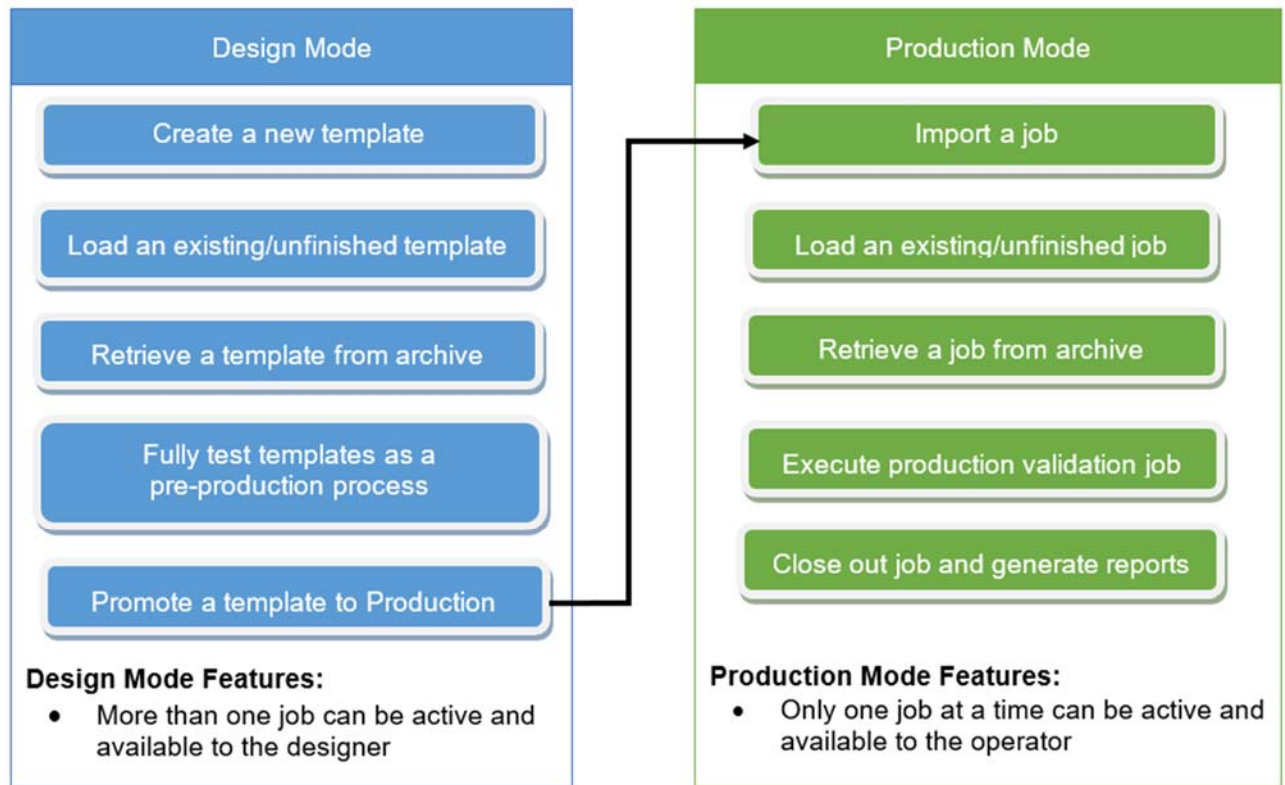

After user login, the Welcome screen displays the appropriate option buttons depending on the user's permissions and licensed modes of operation. The screen below shows a dual mode system that has specific radio button controls to switch between Design and Production modes. The ability to switch between modes is restricted to users who are assigned administrator permissions.

Design mode option buttons:

- Create a new template
- Load an existing template
- Retrieve template from archive

Production mode option buttons:

- Import a new job
- Load an existing job
- Retrieve job from archive

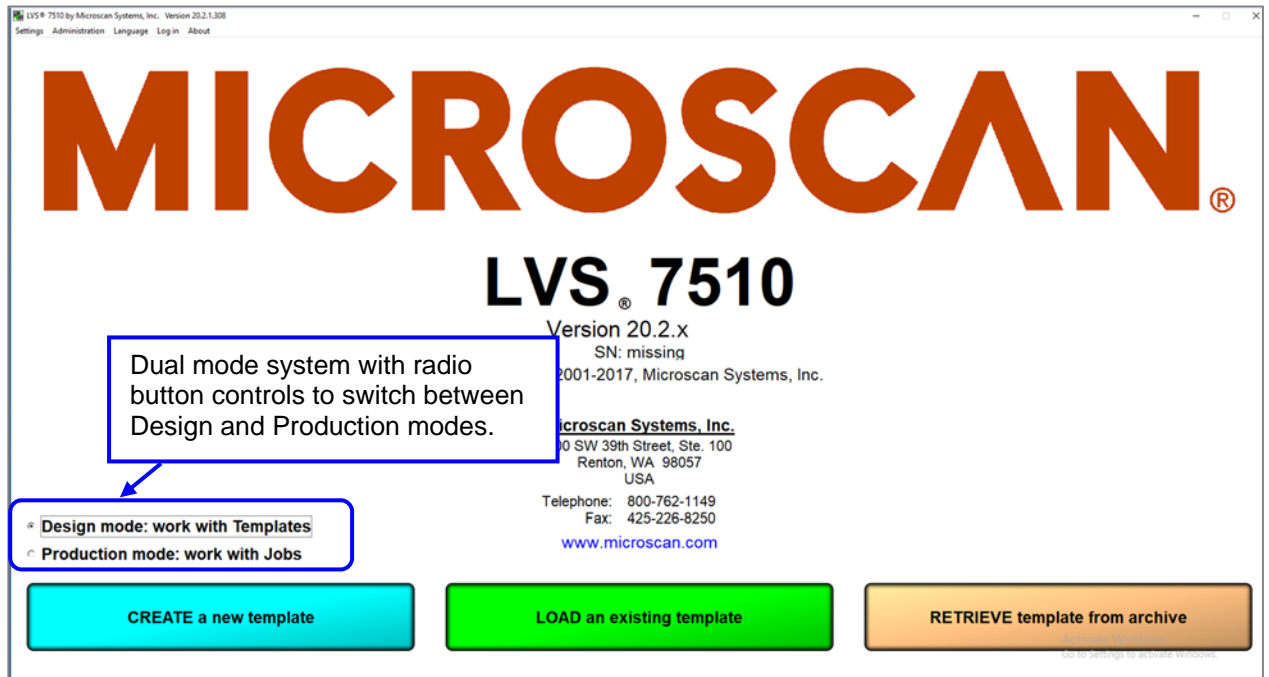

Example LVS-7510 Design and Production Mode Configuration

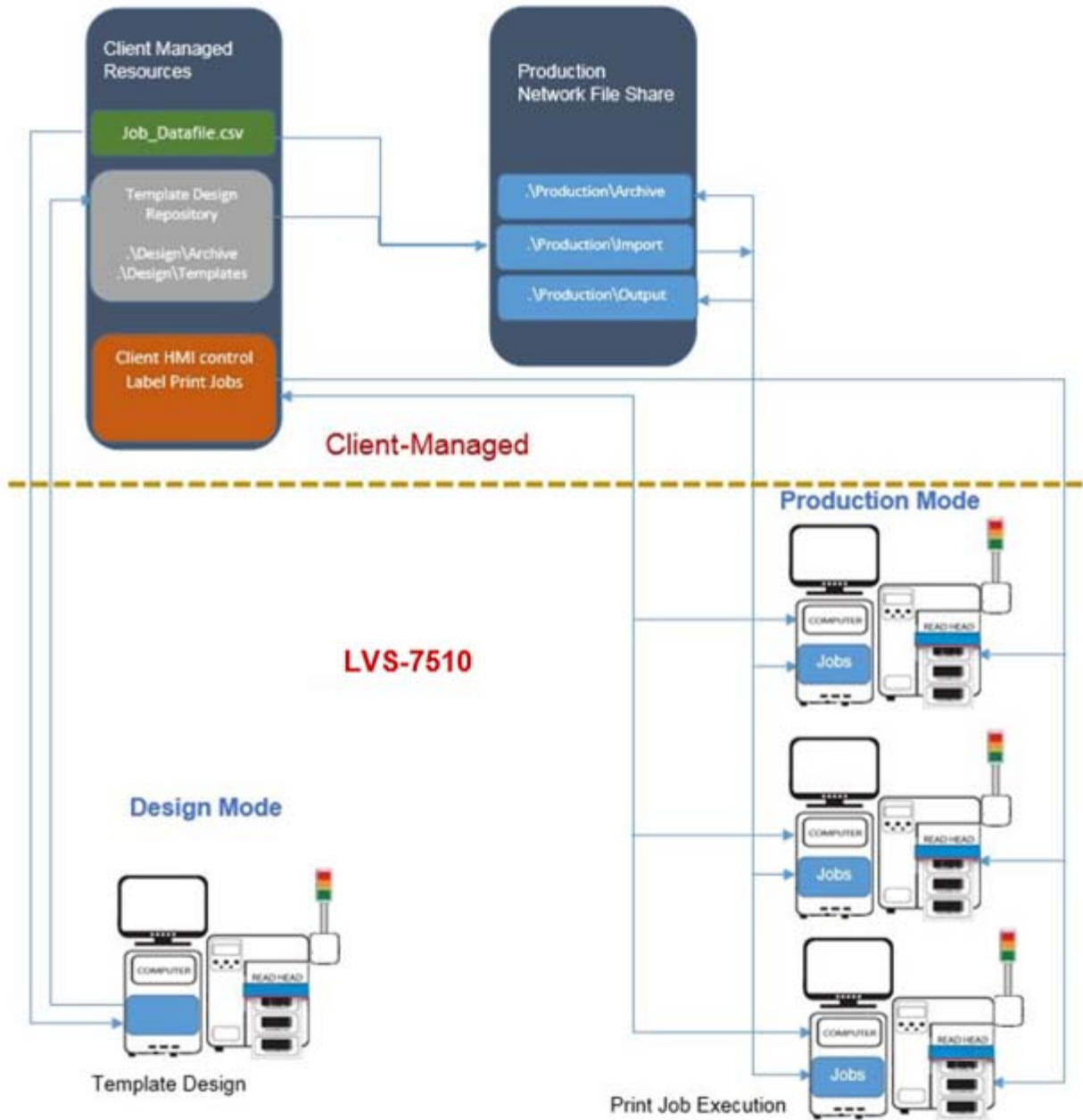

Design Mode

The Design mode system is a sophisticated software package with many inspection capabilities. It is best operated by a well-trained individual or group to ensure the final production process runs as automated as possible with as little operator interaction as possible. Design mode is intended to eliminate the set-up process on the production line.

The Design mode system is a complete system that includes the LVS-7510 inspection unit, computer and client printer. The system can be setup anywhere on the client's network allowing multiple designers to share template designs.

The process of capturing a Golden Image is through a physical printout of a mock production run of labels. The mock production labels are printed and variable data attributes are tested in the Design mode.

If the optional PDF compare feature is enabled, the Design operator can compare the golden image against an approved PDF using the supplied PDF comparison software. The comparison process is as simple as loading an approved PDF from a folder location on the network and clicking "Play" from within the template Design mode. The software runs a comparison against the captured golden image and highlights any differences for the operator to review. Once satisfied that the PDF and Golden image match, the operator clicks "Accept" and a report is stored with the job for any future reference. If any discrepancies are found, the operator simply reprints a new image on the LVS-7510 and runs the comparison again.

In Design mode, more than one template can be active and available to the operator, who is trained in the design and creation of the label inspection templates. A new template is created by clicking the "Create a new template" button. A message box appears requesting the new template name to be created.

The template name is given to the folder where the LVS-7510 will create and save all files involved in the execution of an actual production template. After design is complete, the designer will close out the template, which zips up all files and stores them as one .zip file in the Archived folder of the Design mode LVS-7510. Archived templates can be retrieved and activated allowing designers to update, copy and reuse previous designs.

In Design mode, the LVS-7510 utilizes two job-related file folders for a specific purpose. The default naming of the folders is based on their purpose, but can be changed to suit the client's requirements. All folders can be on a mapped network drive or local drive for each LVS-7510 system.

Define Template Path Locations in Design Mode

You must define where templates are located on a network drive or local folder. This section explains how to configure the LVS-7510 path locations for the following:

Template folder:

- In Design mode, this is where new templates are created and designed. Multiple templates under development are allowed.
- A new template is initiated by creating a new folder with the new job name in the Jobs folder.

Archived folder:

- In Design mode, templates that are complete and closed out are zipped up and removed from the Template folder to the Archived templates folder. The jobname.zip file is ready for execution in Production mode or recall back into Design mode for changes and/or updates.

Define Location of Templates and Archive folders:

IMPORTANT: You must have administrator rights to perform the steps in this section.

1. Log in to the LVS-7510 software.
2. Click “Settings” in the menu bar.

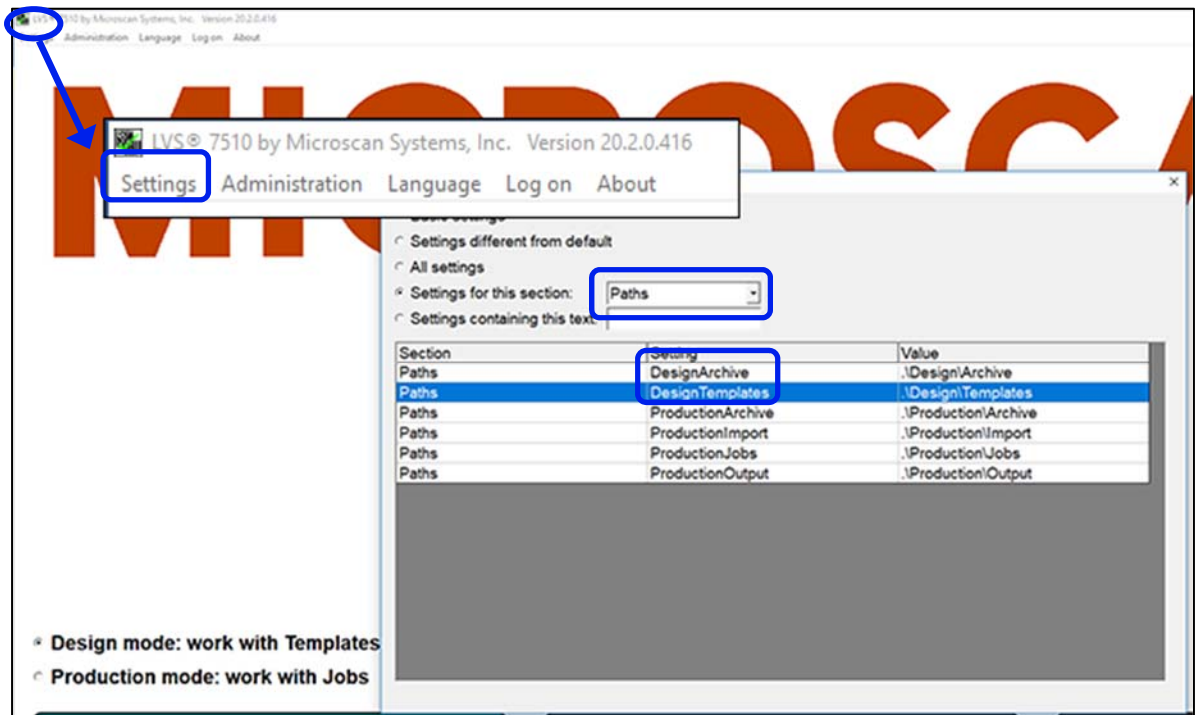

3. In “Settings for this section,” click the drop-down box and select “Paths.”
4. In the “Setting” column, double-click either “DesignTemplates” or “Design Archive.”
5. In the “Value” field, enter the path and then click “OK (save changes).” For example, by default the value \Design\Templates will store templates on the local LVS-7510 computer.
 - For installations of software version 20.2.X on Windows® 7 Professional, Windows® 8.1 and Windows 10 Professional operating systems: C:\LvsData\LVS 7500\Design\Templates.
 - Jobs created in earlier versions of the software are not supported. Manually backup any desired data and manually delete the C:\Users\[User Login Name]\AppData\Roaming\Label Vision Systems\LVS

7500 or C:\Users\[User Login Name]\AppData\Roaming\Microscan\LVS 7510. Then, install software release 20.2.X as a new installation.

LVS 7x00 Configuration Editor Individual Setting

Section	Paths
Setting	DesignTemplates
Default	.\Design\Templates
Value	.\Design\Templates

DesignTemplates is only to be used when requested by a qualified Label Vision Systems representative.

OK (save changes) Cancel (discard changes)

6. Click "OK (save changes)."
7. Repeat steps 4 and 5 to set the DesignArchive path setting.

Production Mode

In Production mode, the LVS-7510 can be configured based upon the PC network implementation and level of operator interaction desired.

Define Job Path Locations in Production Mode

In Production mode, the LVS-7510 utilizes the following folders:

- **Import folder**

In Production mode, new jobs waiting to be executed are dropped into the Import folder. When a designer executes a “Promote template to production,” the template is copied into the Production Import folder. Multiple jobs can reside in the Import folder waiting to be acted on by the production operator. This folder can be located on a network drive or local folder.
- **Jobs folder**

In Production mode, the operator will select a job from the Import folder to be executed. The job is unzipped and a folder is created in the Jobs folder with the job name. Only one job can reside in the Jobs folder. To clear the active job from the Jobs folder the production operator must execute “Close out job” which zips up the job along with run related data. The executed jobname.zip file is copied into the Production Archive folder. The job is deleted from the Jobs folder to make ready for the import of a new job. For Job Auto-Execute functionality, see page 90. This folder can be located on a network drive or local folder.
- **Output folder**

In Production mode, when a job is completed and closed out, the output reporting and summary file(s) are written to this folder path. This folder can be located on a network drive or local folder.
- **Archive folder**

This folder contains the detailed production data for a job that includes the inspection results for each label. Jobs that are complete and closed out are zipped up and moved from the Jobs folder to the Archive folder. This folder can be located on a network drive or local folder.

Define Location of Production folders

IMPORTANT: You must have administrator rights to perform the steps in this section.

1. Log into the LVS-7500 software.
2. Click “Settings” in the menu bar.

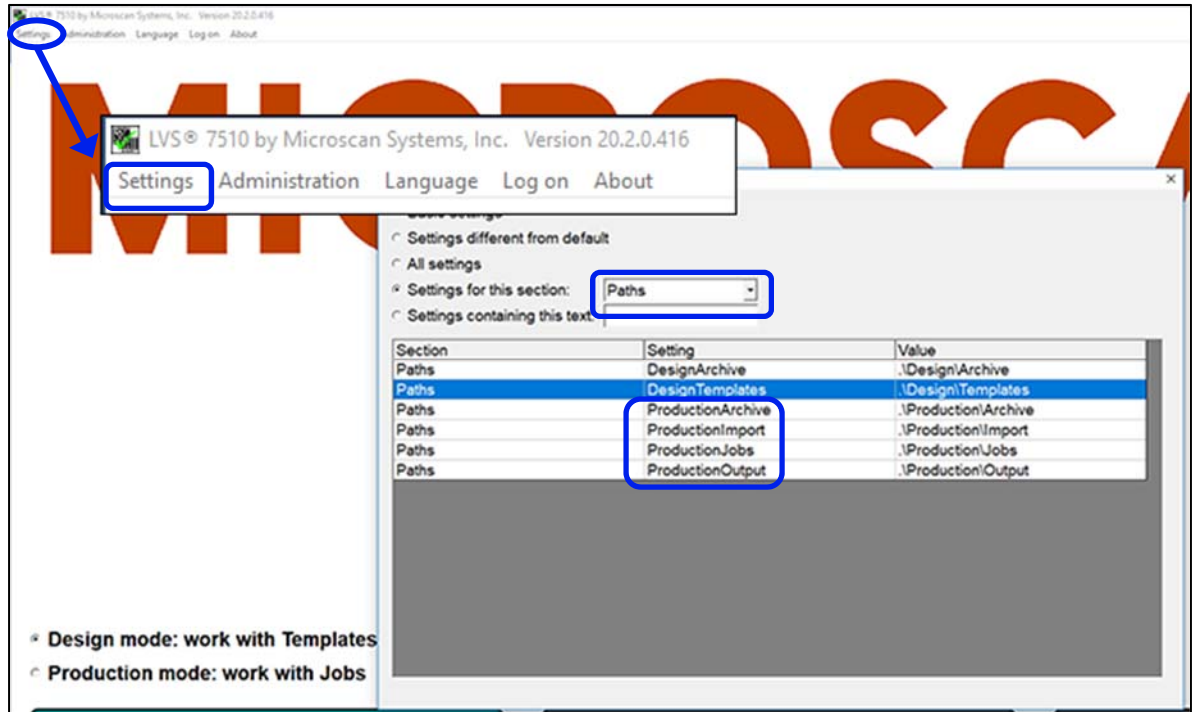

3. In “Settings for this section,” click the drop-down box and select “Paths.”
4. In the “Setting” column, double-click one of the production path settings (such as ProductionImport).
5. In the “Value” field, enter the path and then click “OK (save changes).” For example, by default the value \Production\Import will store templates on the local LVS-7510 computer.
 - For installations of software version 20.2.X on Windows® 7 Professional, Windows® 8.1 and Windows 10 Professional operating systems: C:\LvsData\LVS 7500\Production\Import
 - Jobs created in earlier versions of the software are not supported. Manually backup any desired data and manually delete the C:\Users\[User Login Name]\AppData\Roaming\Label Vision Systems\LVS 7500 or C:\Users\[User Login Name]\AppData\Roaming\Microscan\LVS 7510. Then, install software release 20.2.X as a new installation.

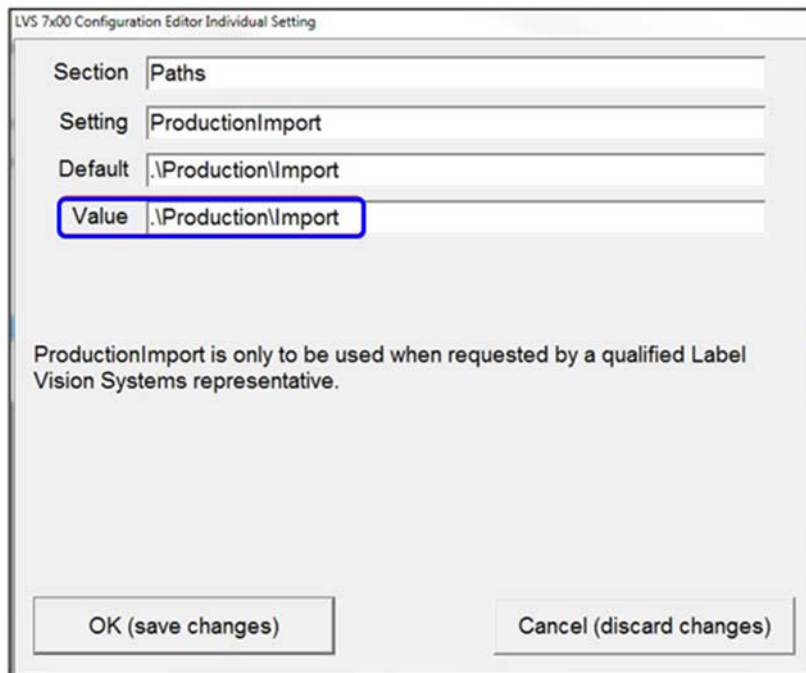

6. Click "OK (save changes)."
7. Repeat steps 4 through 6 to set the ProductionJobs, ProductionOutput and ProductionArchive path setting.

Log In

Follow the steps below to log in to the LVS-7510.

Note: Users with the “Automatic Login” feature enabled bypass the Welcome screen and automatically access the Welcome screen where they are able to work according to the system setup and their individual permissions (as shown in step 3 below showing the Design Mode Welcome Screen). Refer to “Appendix E: Automatic Login” for more information on using the “Automatic Login” feature.



1. Start the LVS-7510 software. The Welcome screen appears (see below).
2. Click the **Log In** button. The Login box appears. Enter the **Operator ID** and **Password**, and then click **OK**.

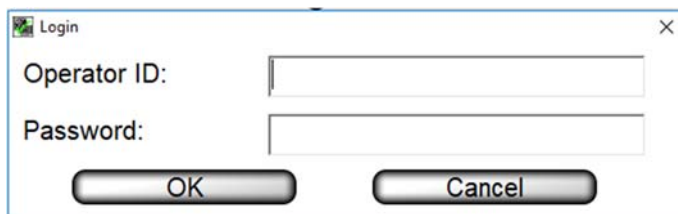

- When using the LVS-7510 for the first time, enter **Admin** in both fields (Operator ID field and Password field).
- Refer to the **Operators** section for detail instructions on creating operator IDs and password (Welcome Screen Overview → Administration → Operators)

3. After login, the operating mode option buttons are displayed. As explained previously in the “Modes of Operation” section, there are two operating modes: Design and Production. Refer to the following sections for more information:
- Design Mode: Create a New Template
 - Production Mode: Import a new Job



Welcome Screen Overview

When starting the LVS-7510 software, the Welcome screen appears (see below). This screen allows you to log in to the LVS-7510 (see “Log In” section below) and access the following menu bar functions:

- Settings
- Administration
- Language
- Log In
- About

Refer to the following sections for more information about each menu bar function.



Settings

The **Settings** menu bar feature opens the LVS-7510 Configuration Editor which allows you to configure the basic and advanced features and functionality of the LVS-7510. A user must be assigned administrator rights to access the “Settings” menu bar.

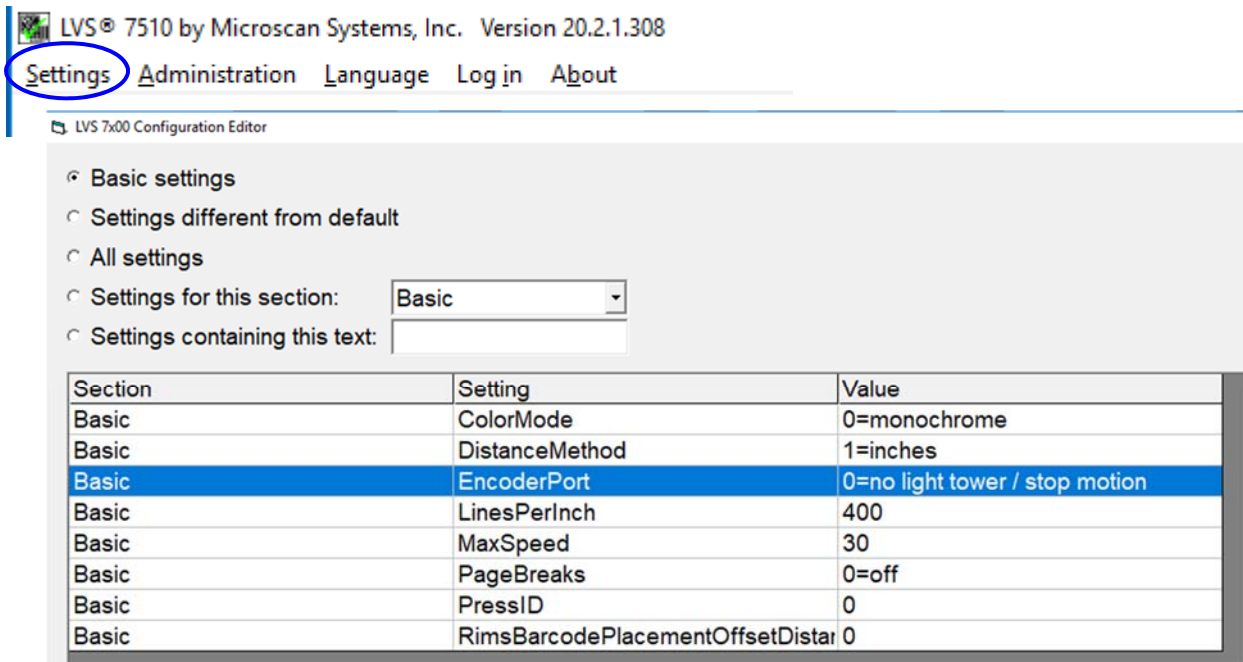

The LVS-7510 Configuration Editor offers the following options:

Option	Description
Basic settings	Select this option to display the settings considered to be basic to LVS-7510 configuration.
Settings different from default	Select this option to display any values that have been modified to a value other than the default value.
All settings	Select this option to display all settings listed alphabetically by “Section.”
Settings for this section	Click the drop-down box to display all settings for the selected section.
Settings containing this text	Enter a text string to search for settings containing the entered text. For example, typing “camera” in the text field will display all settings containing the word “camera.”

Each setting is grouped by “Section,” “Setting,” and “Value.”

Double-click a setting row. The “LVS-7510 Configuration Editor Individual Setting” window appears which provides the Section, Setting, Default, Value, and Setting Description.

The only editable field is the “Value” field. All other fields cannot be edited.

Click “OK (save changes)” to save your changes or “Cancel (discard changes)” to discard any changes made on the screen.

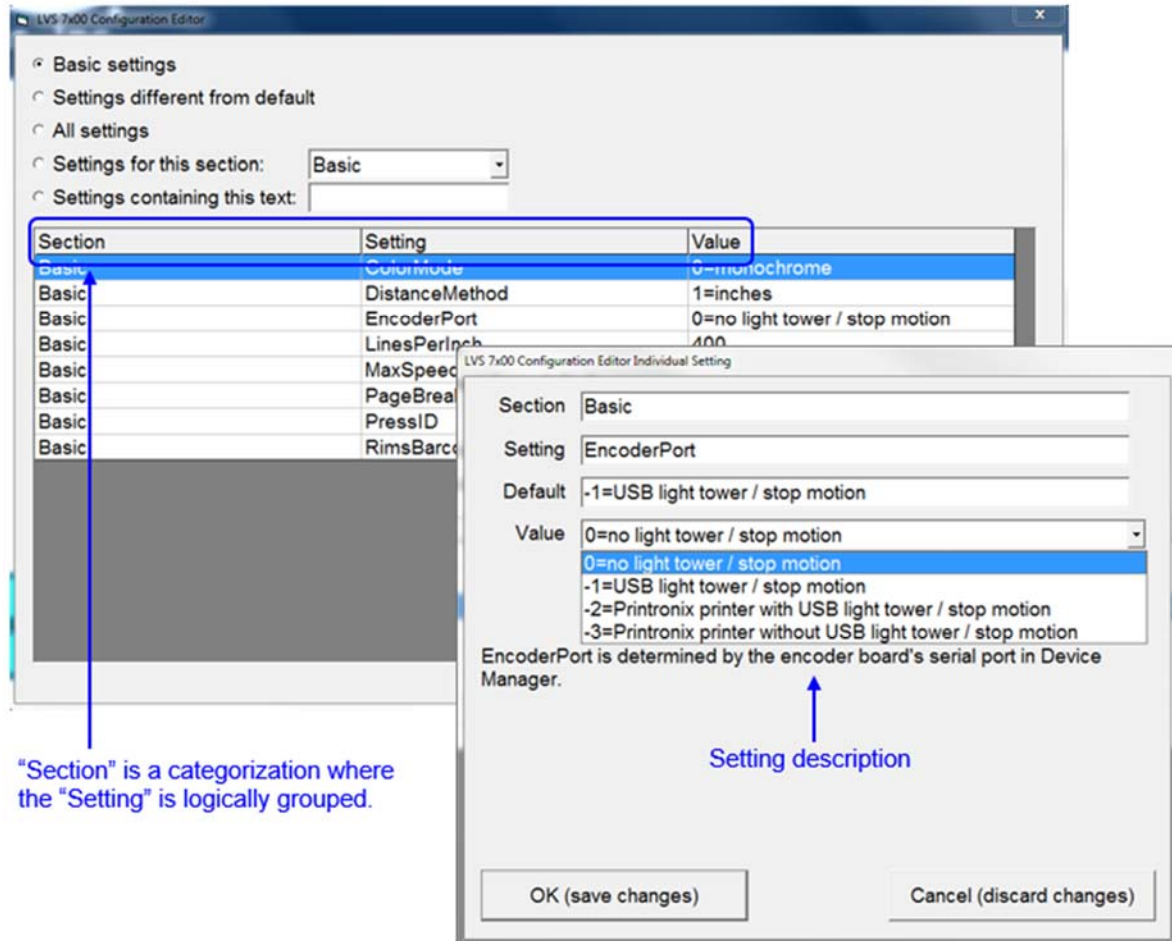

Administration

The **Administration** menu bar feature allows you to choose from the following options:

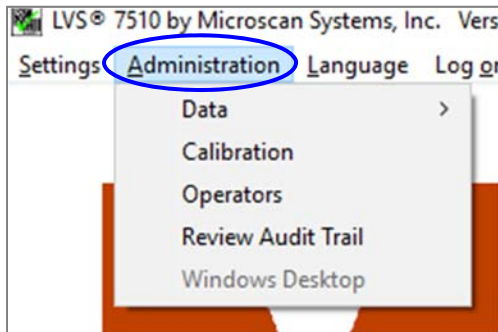

Option	Description
Data	Backup or restore jobs.
Calibration	Calibrate the LVS-7510.
Operators	Select operator permissions.
Review Audit Trail	Review an audit trail of all activity performed on the LVS-7510.
Windows® Desktop	Access the Windows® desktop (operator must have access rights to perform this feature).

Refer to the following sections for more information about each feature.

Data

The **Data** feature allows you to backup or restore templates and jobs.

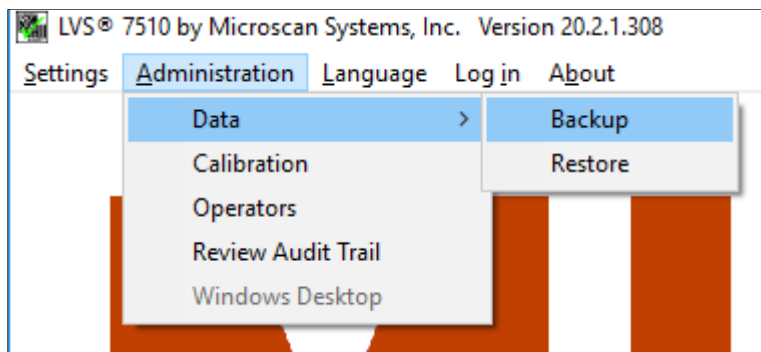

The location of data is dependent on the current mode of operation.

If in Design mode, templates are located in the following directories:

- For installations of software version 20.2.X on Windows® 7 Professional and Windows® 8.1 Professional operating systems: C:\LvsData\LVS 7500\Design\Templates
- Jobs created in earlier versions of the software are not supported. Manually backup any desired data and manually delete the C:\Users\[User Login Name]\AppData\Roaming\Label Vision Systems\LVS 7500 or C:\Users\[User Login Name]\AppData\Roaming\Microscan\LVS 7510. Then, install software release 20.2.X as a new installation.

If in Production mode, the job data is located in the following directories:

- For installations of software version 20.2.X on Windows® 7 Professional and Windows® 8.1 Professional operating systems: C:\LvsData\LVS 7500\Production

- Jobs created in earlier versions of the software are not supported. Manually backup any desired data and manually delete the C:\Users\[User Login Name]\AppData\Roaming\Label Vision Systems\LVS 7500 or C:\Users\[User Login Name]\AppData\Roaming\Microscan\LVS 7510. Then, install software release 20.2.X as a new installation.

Data Backup

To backup data from the source directory to a different folder, drive or network location, follow the steps below.

1. Select **Administration** → **Data** → **Backup**. The following screen appears.

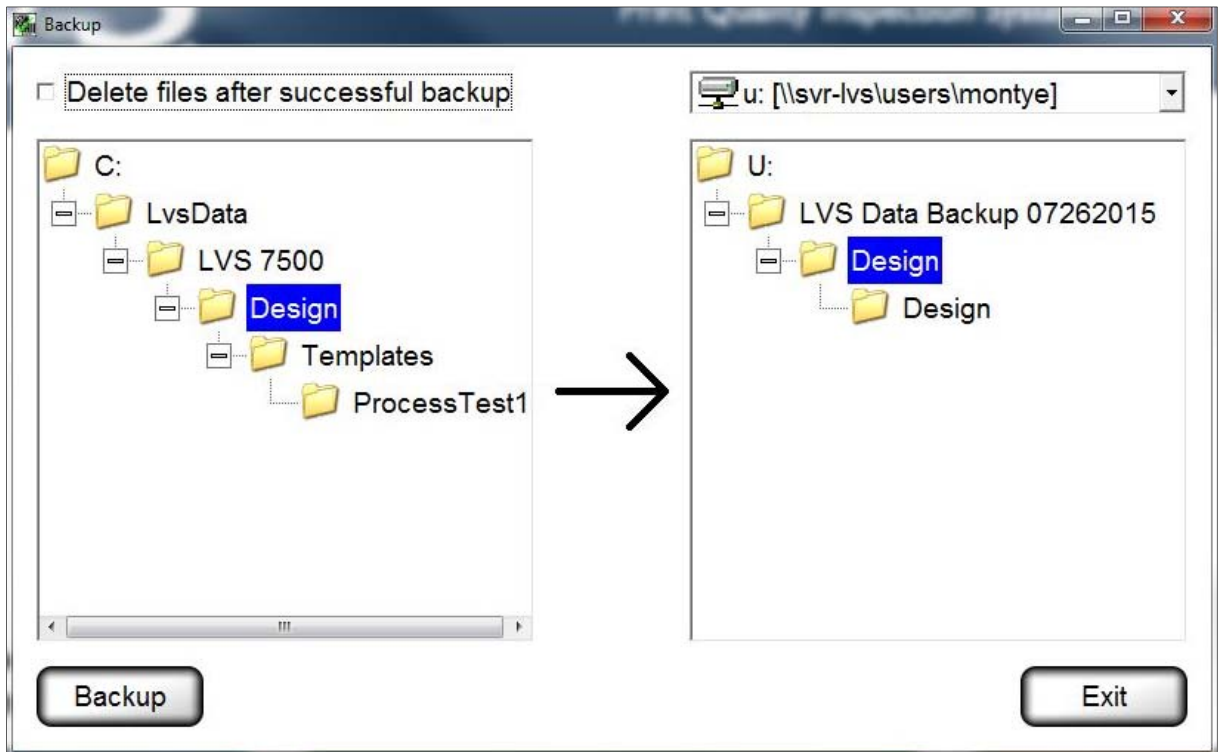

2. On the left side, select the data folders that you want to backup. Multiple folders can be selected at one time by pressing and holding the **CTRL** keyboard button, and then clicking each folder.
3. On the right side, select the folder where the files should be saved. The same drive letter cannot be used for source and destination drive selection.
4. If you want to delete the files after backup, click the **Delete files after successful backup** checkbox.
5. Click **Backup**.

Data Restore

To restore data from a folder, drive or network location to the Design or Production folders, follow the steps below.

1. Select **Administration** → **Data** → **Restore** from the menu bar. The following screen appears.

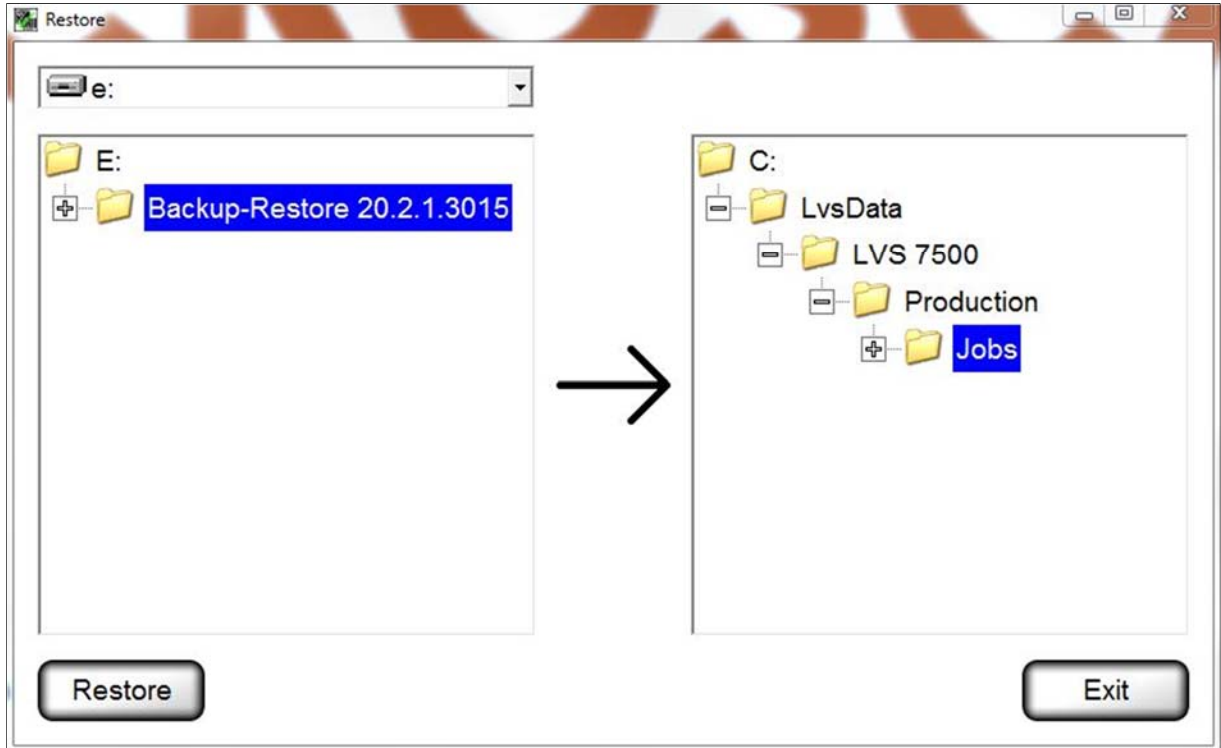

2. On the left side, select the folder(s) you want to restore. Multiple folders can be selected at one time by pressing and holding the **CTRL** keyboard button and then clicking each folder.
3. On the right side, select the "Jobs" directory.
4. Click **Restore**.

Calibration

The **Calibration** feature allows you to calibrate the LVS-7510. Calibration is required to keep the LVS-7510 in a standard imaging configuration. It is recommended that the system be recalibrated each time the printer ribbon is changed.

To calibrate the LVS-7510, you need an Omron Microscan Calibration Card in perfect condition with all of the calibration information filled out on the card. Only Omron Microscan calibration card part #98-CAL017 should be used to calibrate LVS-7510.

1. Select **Administration**, and then **Calibration** from the menu bar.

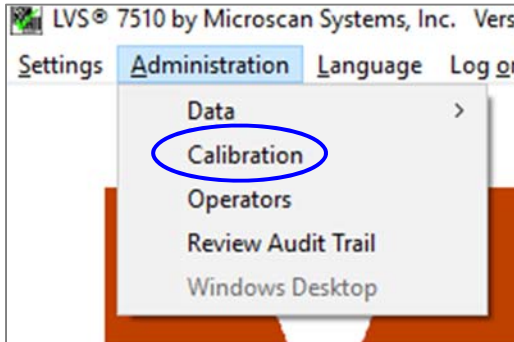

2. Click the **Start calibration procedure** button. The following screen appears.

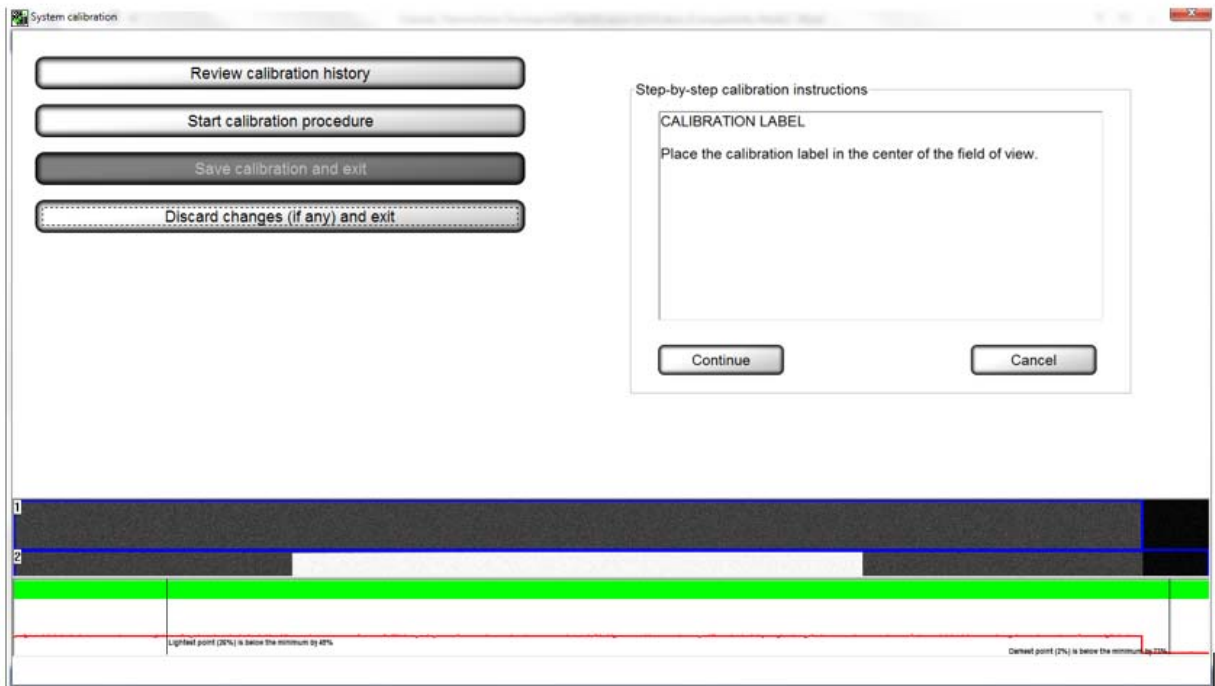

- Place the white portion of the calibration card in the field of view. The entire image should appear white. Click **Continue**. The following page appears. Make sure that the sensor head is closed in the **ALL BLACK** calibration step.

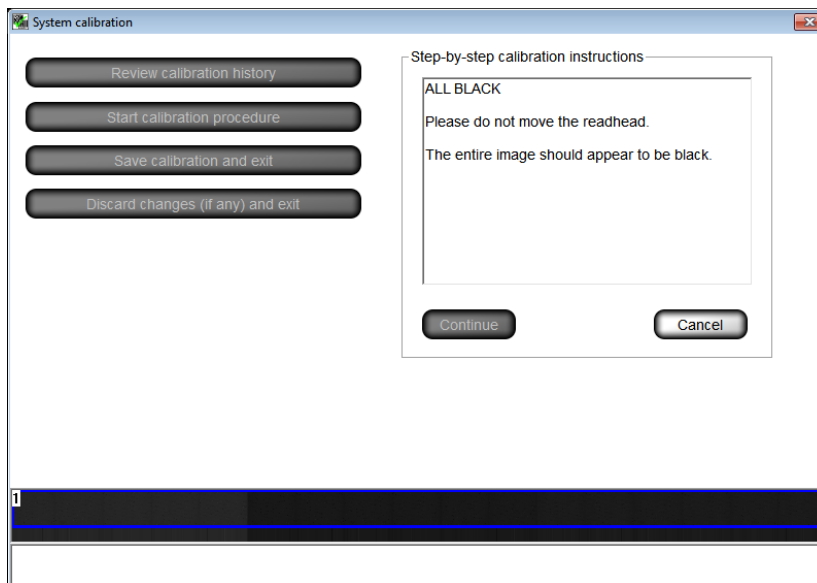

Tip: Step-by-step calibration instructions are also listed on the right side of the screen.

- Place the Omron Microscan calibration card under the camera so that as many barcodes are within the field of view as possible. If the calibration card does not fit under the sensor, flip up the sensor head and place the card on the sensor such that it sees the barcodes. The system displays the ISO/IEC 15416 parameters of all the decoded barcodes that the camera detects. Next, click **Continue** to calibrate.

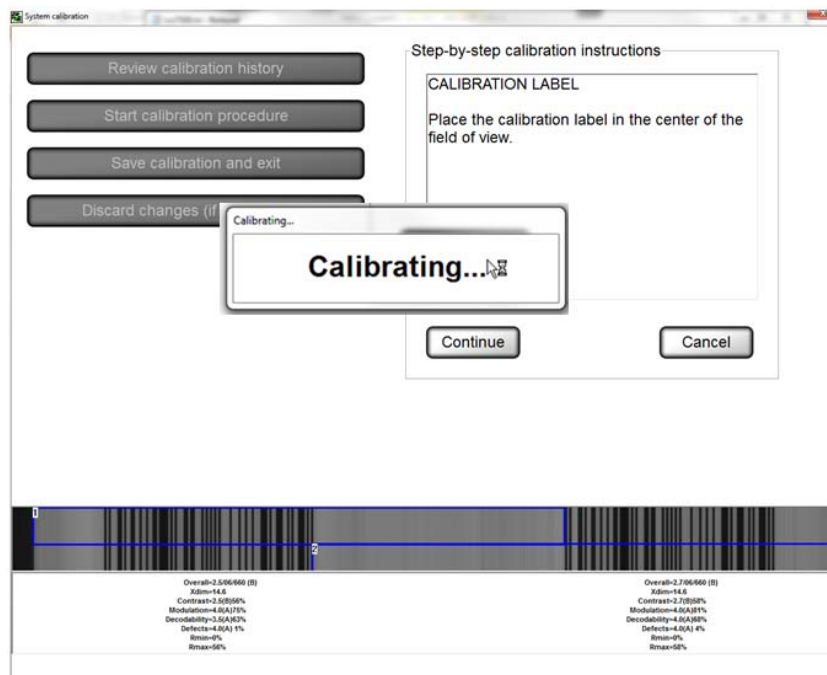

- Calibration is complete. If calibration fails, repeat the calibration process. Be sure to inspect the calibration card carefully for damages and impurities. If the problem still persists, contact Omron Microscan for technical assistance.

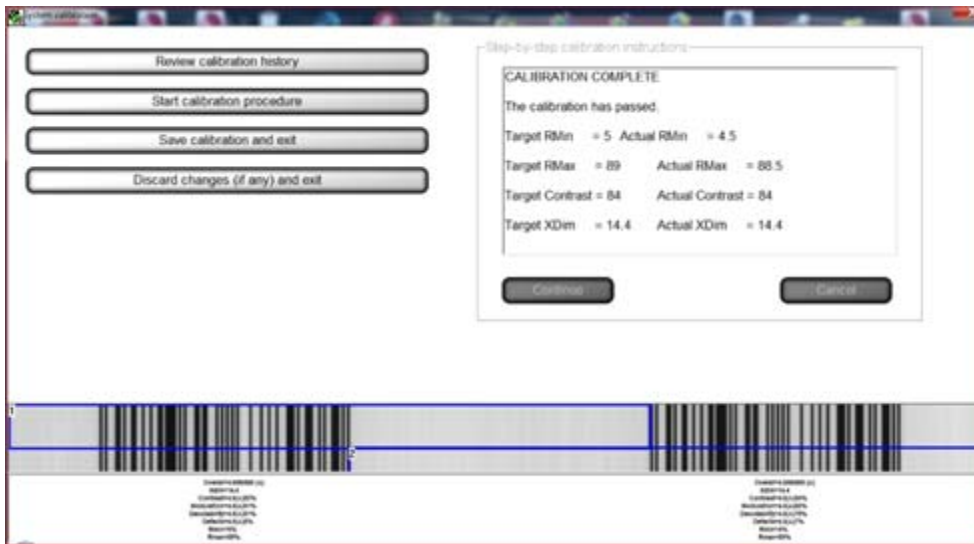

- Click the **Save calibration and exit** button to save the calibration results and return to the **Welcome** screen. After saving the calibration results, the system automatically saves the Operator ID in the calibration history log (see the next section entitled “Review Calibration History” for more information).
- Click the **Discard changes (if any) and exit** to discard the calibration results and return to the **Welcome** screen.

Review Calibration History

- Click **Review calibration history**.

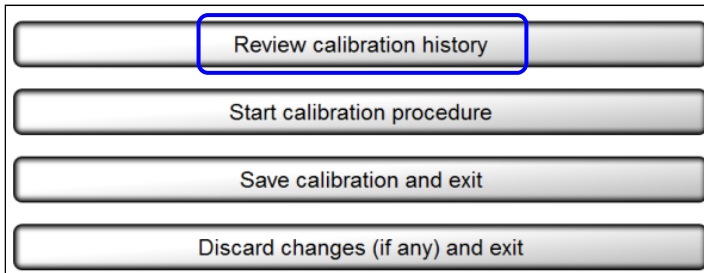

- The CSV file viewer page appears (see below), which is time stamped, provides the operator ID, and displays the “before” and “after” calibration image readings. The fields are not user editable in the viewer; they are printable if desired.

Time	Operator	Target Rmax	Target Rmin	Actual Rmax	Actual Rmin	Lowest Overall	Lightest Pixel	Darkest Pixel
21-Jul-2015 17:42:58	Raylon (Raylon)	89	5	89	5	3.7	26	20
28-Jul-2015 08:22:14	Raylon (Raylon)	89	5	89	6	3.7	100	80

Operators

Two options are available for managing operator permissions in the LVS-7510.

- **Manage operator permissions using Microsoft® Active Directory.** The LVS-7510 software integrates with Microsoft Active Directory. LVS-7510 users are granted user privileges based on Microsoft authentication and LVS-7510 permissions are assigned based on group membership in Omron Microscan-specific Active Directory groups.

To manage operator permissions using Microsoft® Active Directory, refer to “Appendix F: Managing Operator Permissions in Microsoft® Active Directory.”

- **Manage operator permissions within the LVS-7510 software.** Users with LVS-7510 administrator access can create and manage permissions of other operators completely within each LVS-7510 system. User passwords are encrypted and stored in the local Operator.dat file. Each user has a password expiration date and failed password count, which are also stored in the same local file. To manage operator permissions within the LVS-7510 software, refer to the steps below.

Manage Operator Permissions within the LVS-7510 Software

The **Operators** feature allows you to establish operator permissions.

1. Select **Administration**, and then **Operators** from the menu bar.

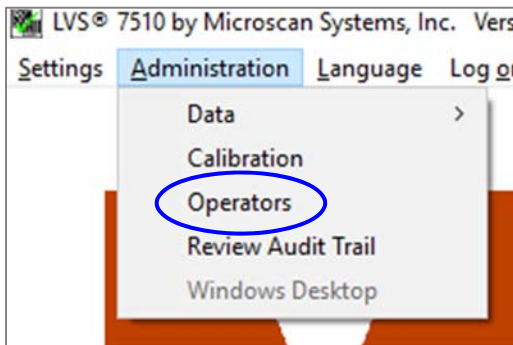

2. The following screen allows you to setup operators and operator permissions.

Operator Administration

Operators	Operator ID (short name)	Permissions
Admin	<input type="text"/>	<input type="checkbox"/> Allow Create NEW Job / Edit
Operator 1	<input type="text"/>	<input type="checkbox"/> Allow Load EXISTING Job
Operator 2	<input type="text"/>	<input type="checkbox"/> Allow Calibration
Operator 3	<input type="text"/>	<input type="checkbox"/> Allow Administration
Operator 4	<input type="text"/>	<input type="checkbox"/> Allow Accept / Replace Errors
	<input type="text"/>	<input type="checkbox"/> Allow Bypass / MakeReady
	<input type="text"/>	<input type="checkbox"/> Allow Abort
	<input type="text"/>	<input type="checkbox"/> Allow Ignore
	<input type="text"/>	<input type="checkbox"/> Allow Reset Printer

Buttons: Add new operator, Change this operator, Delete this operator, Discard changes, Save changes, Done

The buttons at the bottom of the screen are described below:

Option	Description
Add new operator	Click the Add new operator button to add a new operator, and then complete the following fields: <ul style="list-style-type: none"> • Operator ID (short name) • Operator name (full name) • Password. Each password must consist of the following: <ul style="list-style-type: none"> ○ At least 8 characters ○ At least 1 letter from A to Z ○ At least 1 number from 0 to 9 • Select the desired permissions • Click Save changes to save your changes or Discard changes to discard and not save your changes
Change this operator	Allows you to make changes to an operator's permissions. <ul style="list-style-type: none"> • Select the operator's name from the Operators list • Click the Change this operator button • Make any necessary changes • Click the Save Changes button to save your changes or the Discard Changes button to not save your changes
Delete this operator	Select the operator's name from the Operators list, and then click the Delete this operator button.
Discard changes	Click this button to discard any changes made to any operator details.
Save changes	Click this button to save changes made to any operator details.
Done	Click this button after all changes are complete.

Permissions

Operator permissions are described in the table below.

Permission	Description
Allow Create NEW Job / Edit	Allows the operator to create, edit and delete a job.
Allow Load EXISTING Job	Allows the operator to load and execute existing jobs. Existing jobs cannot be edited.
Allow Calibration	Allows the operator to perform calibration.
Allow Administration	Allows the operator access to the "Administration" menu bar feature where operators and operator permissions are set up. See "Welcome Screen Overview" → "Administration" → "Operators" for more information.
Allow Accept / Replace Errors	Allows the operator to accept or replace errors.
Allow Bypass / MakeReady	Allows the operator to use the "Bypass" and "MakeReady" buttons on the "Design and Production Mode: Running" screen.
Allow Abort	Allows the operator to stop running the job after three consecutive errors of the same type are detected (except Foreground and Background errors). For more information, refer to Appendix H: LVS-7510 Printronix Integrated System" → Printing Stopped Error Message.

Permission	Description
	The "Allow Abort" permission is applicable only when the LVS-7510 is in Design or Production mode (see the "Modes of Operation" section for more information on Design and Production modes).
Allow Ignore	Allows the operator to ignore a failed label and continue printing the next label in the job after three consecutive errors of the same type are detected (except Foreground and Background errors). For more information, refer to Appendix H: LVS-7510 Printronix Integrated System" → Printing Stopped Error Message. The "Allow Ignore" permission is applicable only when the LVS-7510 is in Design or Production mode (see the "Modes of Operation" section for more information on Design and Production modes).
Allow Reset Printer	Allows the operator to reset the printer. For more information, refer to Appendix H: LVS-7510 Printronix Integrated System" → Reset the Printer. The "Allow Reset Printer" permission is applicable only when the LVS-7510 is in Design or Production mode (see the "Modes of Operation" section for more information on Design and Production modes).

Review Audit Trail

The **Review Audit Trail** feature allows you to monitor user activity.

- Click **Print all** to print the audit trail report.
- Click **Exit** to exit the audit trail report and return to the Welcome screen.

Note: The audit trail is saved as a .txt file in the Production/Output folder and can be exported into external applications such as MS Excel.

Date	Time	Operator	Action
25-May-2017	10:25:55		Program started
25-May-2017	11:42:40		Program started
25-May-2017	11:49:16		Program started
25-May-2017	11:52:47		Program started
25-May-2017	11:53:23	Admin (Administrator)	Logged in
25-May-2017	11:53:29	Admin (Administrator)	Program stopped
25-May-2017	11:53:49		Program started
25-May-2017	11:54:03	Admin (Administrator)	Logged in
25-May-2017	12:02:17	Admin (Administrator)	Program stopped
30-May-2017	14:04:39		Program started
30-May-2017	14:05:03	Admin (Administrator)	Logged in
30-May-2017	14:18:05	Admin (Administrator)	Program stopped
30-May-2017	14:18:17		Program started
30-May-2017	14:18:30	Admin (Administrator)	Logged in
30-May-2017	14:23:48	Admin (Administrator)	Recent setting changes were canceled
30-May-2017	14:23:59	Admin (Administrator)	Recent setting changes were canceled
30-May-2017	14:24:55	Admin (Administrator)	Recent setting changes were canceled
30-May-2017	14:26:39	Admin (Administrator)	Program stopped
30-May-2017	14:26:46		Program started
30-May-2017	14:28:51	Admin (Administrator)	Logged in
30-May-2017	14:51:00	Admin (Administrator)	Operators selected
30-May-2017	14:52:15	Admin (Administrator)	Added new operator Operator1
30-May-2017	14:52:49	Admin (Administrator)	Added new operator Operator2
30-May-2017	14:53:09	Admin (Administrator)	Added new operator Operator3
30-May-2017	14:53:30	Admin (Administrator)	Added new operator Operator4
30-May-2017	15:15:19	Admin (Administrator)	System switched to Design Mode by Admin (Administrator)
30-May-2017	15:15:20	Admin (Administrator)	System switched to Production Mode by Admin (Administrator)
30-May-2017	15:15:22	Admin (Administrator)	System switched to Design Mode by Admin (Administrator)
30-May-2017	15:15:39	Admin (Administrator)	CREATE a new template selected
30-May-2017	15:15:39	Admin (Administrator)	New template name is May 31
30-May-2017	15:16:13	Admin (Administrator)	Saved configuration for job May 31
30-May-2017	15:16:21	Admin (Administrator)	Starting MakeReady
30-May-2017	15:16:24		Remote system Stopping MakeReady
30-May-2017	15:16:24	Admin (Administrator)	MakeReady processed 0 labels
30-May-2017	15:16:24	Admin (Administrator)	Starting run 1 of job May 31
30-May-2017	15:16:39	Admin (Administrator)	Stopping run
30-May-2017	15:16:39	Admin (Administrator)	Run 1 stopped -- printed 10 labels with 0 reprints
30-May-2017	15:17:18	Admin (Administrator)	Saved configuration for job May 31
30-May-2017	15:17:22	Admin (Administrator)	Starting MakeReady
30-May-2017	15:17:26		Remote system Stopping MakeReady
30-May-2017	15:17:26	Admin (Administrator)	MakeReady processed 0 labels
30-May-2017	15:17:26	Admin (Administrator)	Starting run 2 of job May 31

Print all

Exit

Windows Desktop

When enabled, Windows® desktop allows a user who has been granted permission rights to access the Windows® desktop from the LVS-7510 system.

Accessing the Windows® desktop from the LVS-7510 is normally disabled to comply with CFR-21 part 11 requirements.

Language

The **Language** menu bar feature allows you to change the language for available translated text.

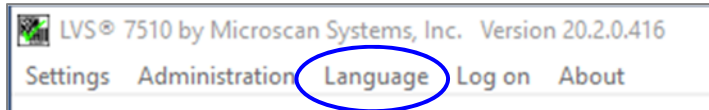

Log In

The **Log In** menu bar feature allows you to log in or log out of the LVS-7510.

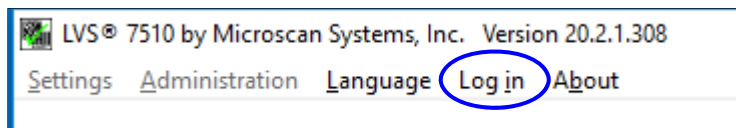

About

The **About** menu bar feature allows you to view the LVS-7510 software version and Omron Microscan contact information.



Design Mode: Create a New Template

To create a new template in Design mode, follow the steps below.

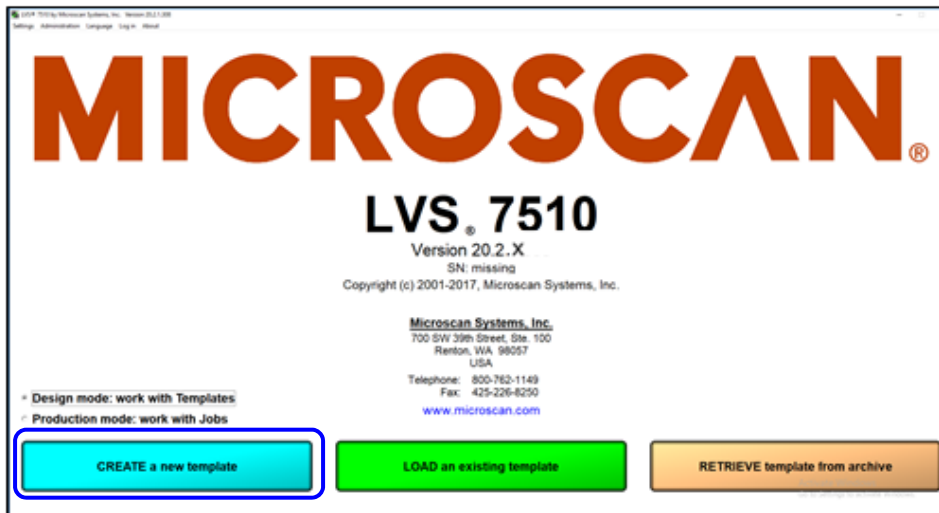

1. Click the “Create a new template” button. The “Enter Template Name” message box appears requesting a new template name.
2. Enter a name for the template being created and click “OK.”



3. At the “Use Automatic Setup” message box, choose “Yes” to use the Automatic Setup feature or “No” to use the Manual Setup feature. A description of each setup feature is described below.

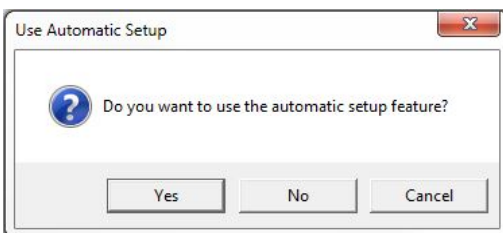

- **Automatic Setup** – Utilizing a box drawn around one label, the LVS-7510 finds all labels across the roll (if multiple labels across the width of the web are present) and automatically draws blemish and barcode sectors with the default setting stored for the corresponding sector types. After this automated process is complete, the system will be at the “Step 7: Save Job to Disk” screen where the user is able to change the template name and description if desired.
- **Manual Setup** – Guides the user through each step in creating a new template. The user must manually create sectors around blemishes and barcode sectors.

For instructions on creating a new template using the Automatic Setup feature, see the next section: “Create a Template Using Automatic Setup.” For instructions on creating a new template using the Manual Setup feature, see the section: “Create a Template Using Manual Setup.”

Create a Template Using Automatic Setup

1. Follow steps 1, 2, and 3 above (making sure to select “Yes” at the “Use Automatic Setup” message box.)
2. Print several labels. Stop when the screen from top to bottom is filled with labels. Click the “Show more” button until you can see a complete label with at least a quarter label either above or below the label. If necessary, print several more labels until the screen is again filled with labels from top to bottom.

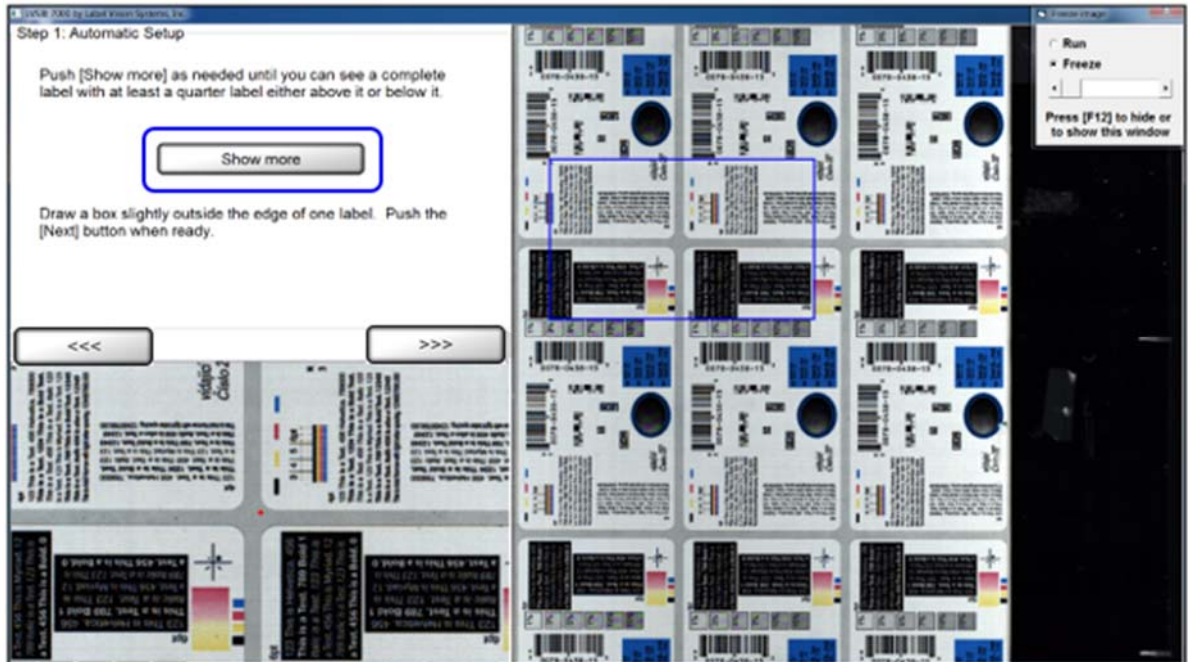

3. Draw a sector around an entire label (starting in the lower right corner moving to the top left corner) and then click the **right arrow** button. A “Working” message appears indicating the system is analyzing the label. The “Step 7: Save Job to Disk” screen appears.

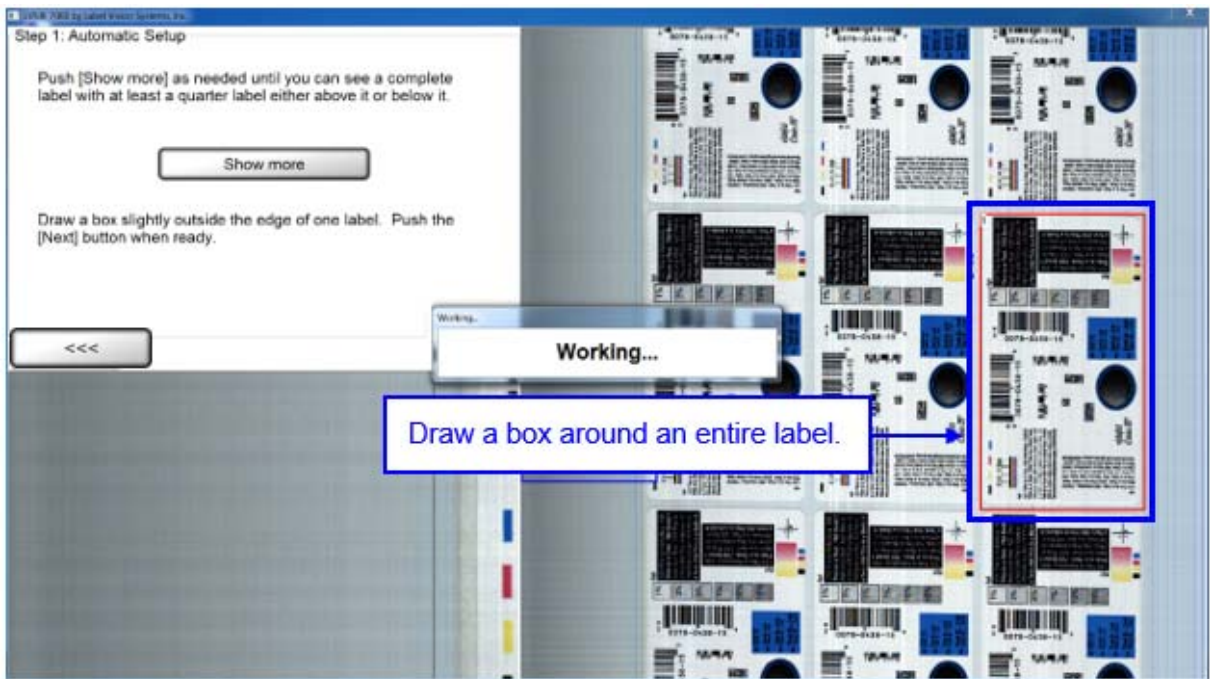

Note: Automatic Setup moves from the Step 1 screen directly to the Step 7 screen of the template creation process. Steps 2 through 6 are accessible if needed. For details about steps 2 through 6, refer to the section: “Create a Template Using Manual Setup.”

- The LVS-7510 automatically detects and creates blemish sectors around any other labels across the roll, and also detects and creates sectors around any 1D or 2D barcodes in each label.

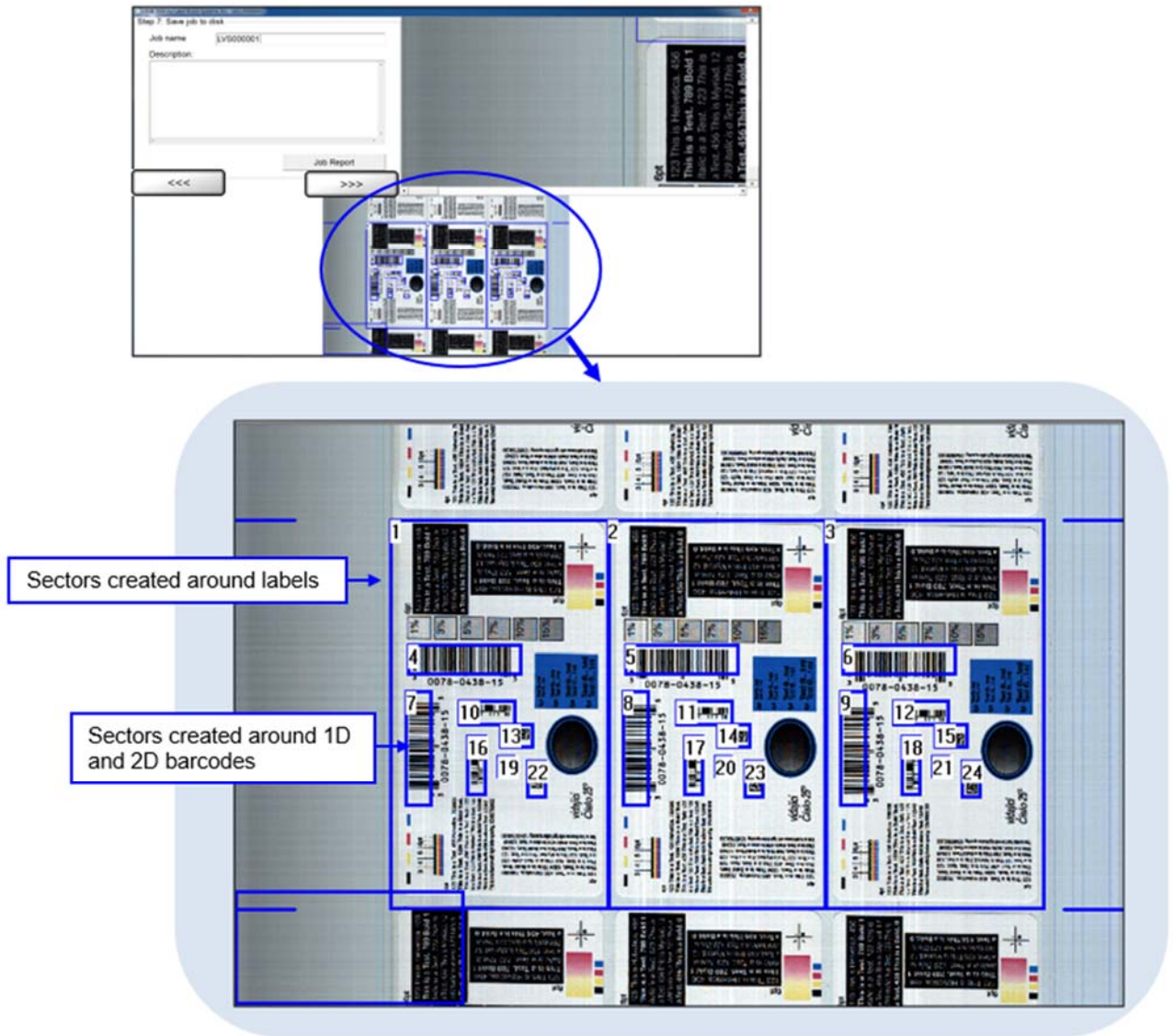

- Enter the name of the template in the **Job name** field.
- Optional:* Enter a template description in the **Description** field.
- Click **Job Report** to view, print or save the Job Report, which shows the settings for all created sectors. See the section entitled "LVS-7510 Job Report" for more information.
- Click the **right arrow** button; this saves the current template configuration.

Create a Template Using Manual Setup

As directed in steps 1, 2, and 3 in the “Design Mode: Create a New Template” section:

1. Click the “Create a new template” button on the “Welcome” screen.
2. In the “Enter Template Name” message box, enter a name for the template being created and then click “OK.”
3. At the “Use Automatic Setup” message box, select “No.” The “Step 1: Set label repeat” screen appears. Refer to the section below for further instructions.

Step 1: Set Label Repeat

Step 1: Set label repeat
Enter the distance from the top of one label to the top of the next label.

Current	Desired		Display size
5	<input style="width: 50px;" type="text" value="5"/>	inches	<input checked="" type="radio"/> + 0%
127	<input style="width: 50px;" type="text" value="127"/>	mm	<input type="radio"/> + 20%
			<input type="radio"/> + 50%

Labels per repeat

1. In the **Desired** column, enter the desired value into the inches or millimeter (mm) fields.
2. Click the **Apply** button, or click the **Undo** button to clear the values entered into the **Desired** column.
3. You may choose to change the **Display Size**. Options include:
 - 0% (Normal) – **This setting must be used for Integrated Printronix and Zebra models.**
 - 20% (Normal + 20%)
 - 50% (Normal + 50%) (Default size)
4. In the **Labels per repeat** field, enter the amount of labels across the width of the web. This field is critical for allowing Global Copy capability in Manual setup. See the **Global Copy** section for more information.
5. Click the **right arrow** button.

Step 2: Synchronize

Synchronization Overview

The LVS-7510's synchronization takes the image and electronically creates a repeating pattern for locking. This process emulates the effect generated by a traditional Photo Optic trigger. The principal is simple enough to understand with some pictorial illustrations. The LVS-7510 takes the image and averages all pixels going across in rows, then performs the same averaging for all pixels going down in columns (see example below).

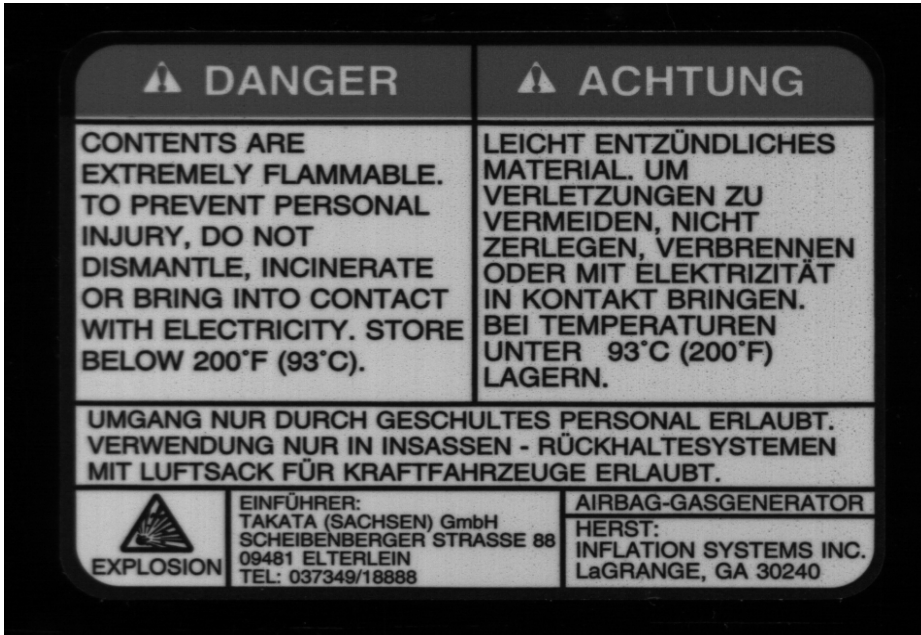

If we were to average all the pixels going across in rows, it would look like a strip added to the right of the picture below.

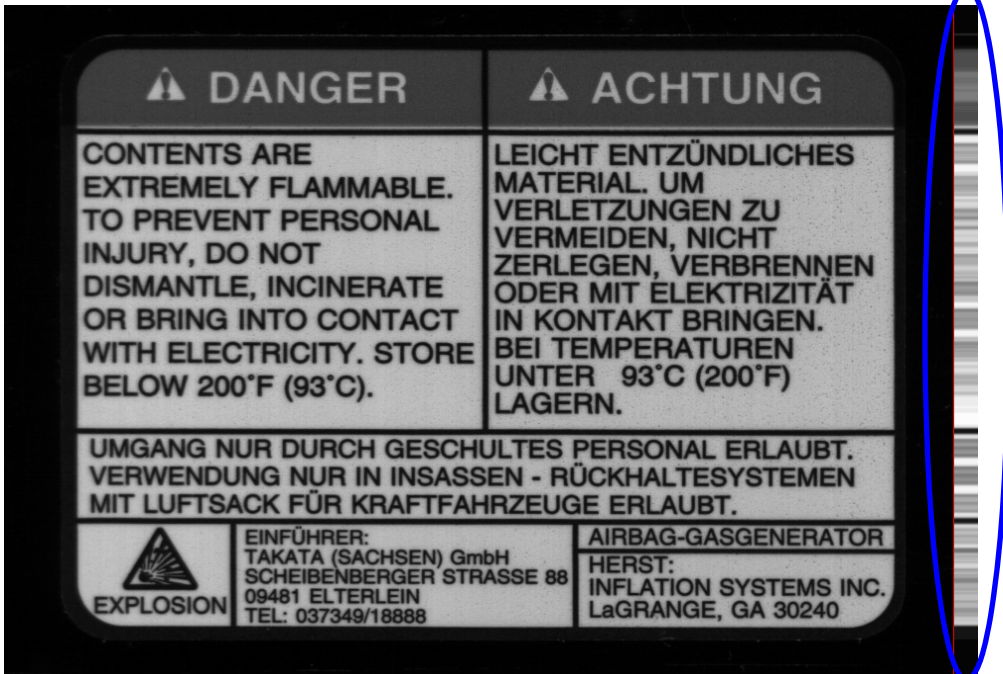

As you can see there are portions of this image attached to the right of the thin, red, vertical line that look similar. These portions are where the text goes across the label. The part we are most interested in seeing are the portions that had the black lines going across the image. The image above shows three definite sharp black lines that are unequally spaced apart. This is good as they cannot be mistaken for one another. The black line closest to the top also has a large darker portion above it since the label had a darker border around the words "Danger" and "Achtung". Solid lines are good to utilize, especially when unevenly spaced. Now following the same principal going down in columns from top to bottom we get a picture that looks like this (see below).

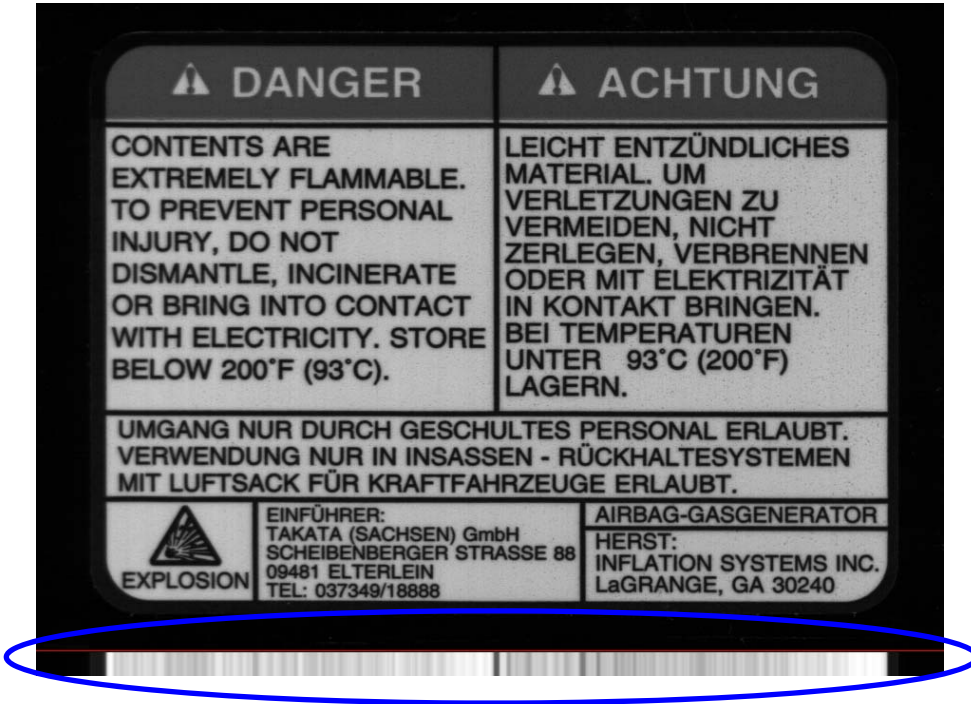

This example has much less definition through the whole image when looking at the average across the bottom of the label (below the red line). The large vertical black line that was through the center has made itself the most obviously defined dark line on the lighter background. Also, the spaces between the print through the center of the label have made the average to the left of the center black line very light in contrast.

Since the smaller the synchronization portion of an image is, the faster it is to process, we can make a guess at the best area to use as a synchronization slice, which is the smallest portion of the image possible to hold good image registration. Below is the image of where we would want to designate as our "sync slice".

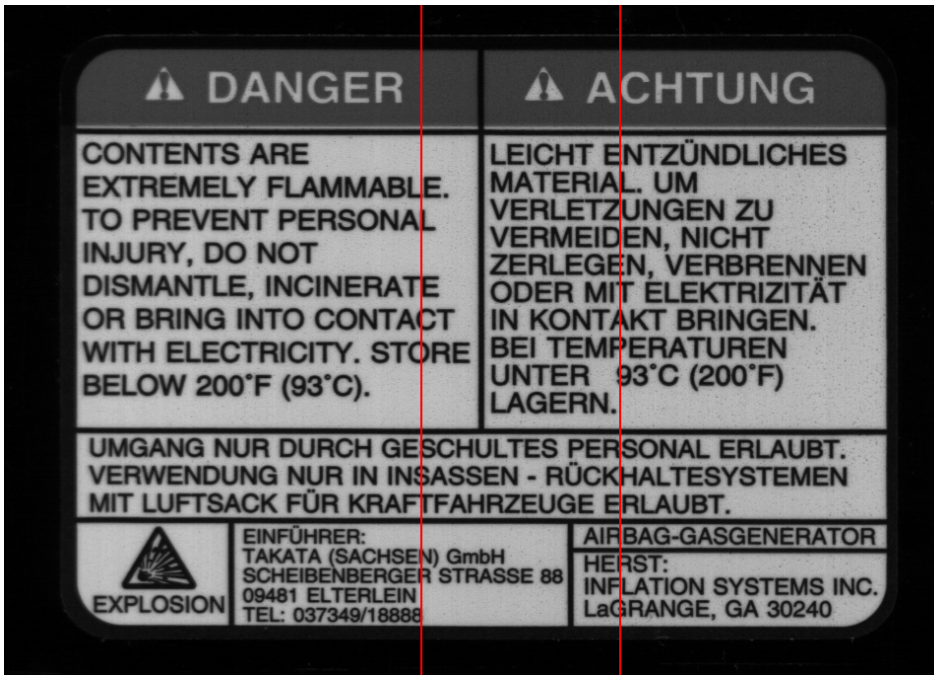

When we average just the portions between the lines, we can process and lock in the repeat much faster than doing the entire image. Keeping it as small as possible is the best rule of thumb, though sometimes it may need to be large to accomplish the goal.

As another rule of thumb, if your label has variable data on it, that area should be avoided if possible. If it cannot be avoided you will need to do the inverse, and make the slice as wide as possible to distribute the variation into the average.

Synchronization Steps

Screen Overview:

The top right image is the full resolution image. The slide bar to the right and below the image allows the operator to view different areas of the image. Right-click on the image to zoom in. Zoom options include 1X, 2X, 4X and 8X.

The bottom image is an altered resolution image that has been shrunk in order to show the camera's entire field of view.

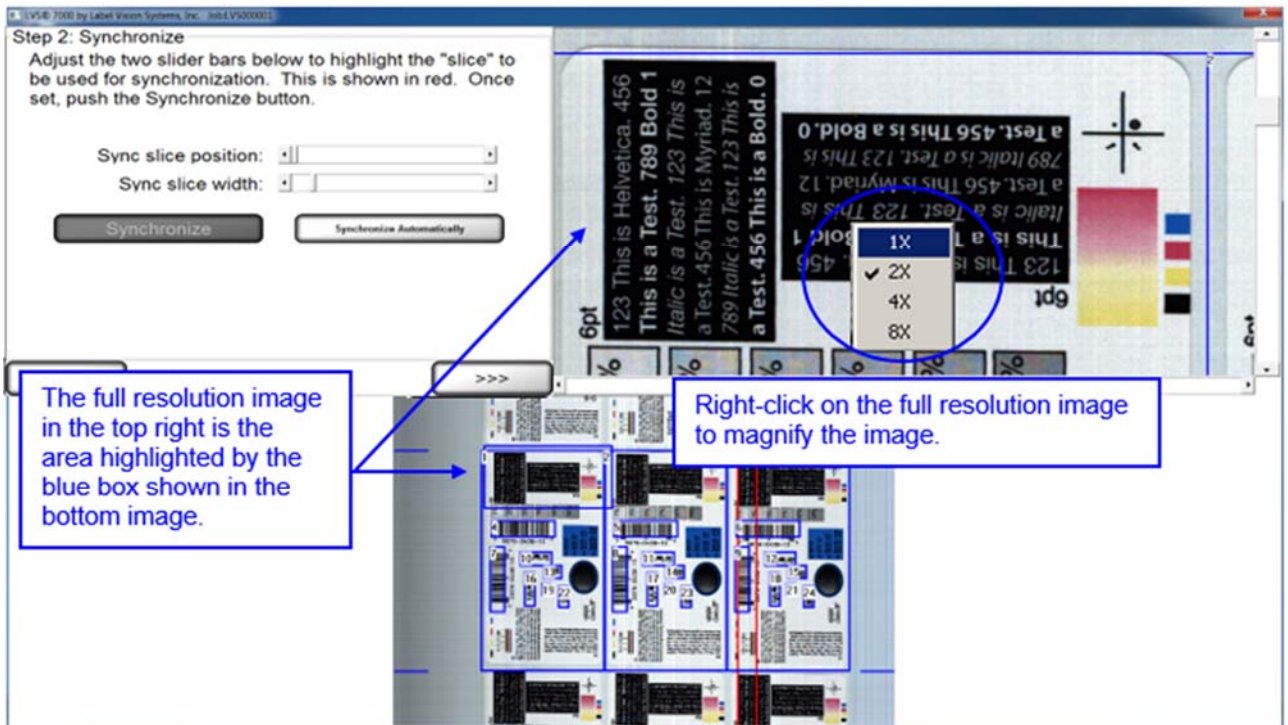

Steps:

1. In order to manually synchronize the system, the operator must adjust the two slide bars. The “slice” is a portion of the label that has the best representation of the labels static (unchanging) portion. To change the Width of the “slice” use the “Sync slice width” slide bar. The minimum size is 128 pixels, and the max is ¼ of the cameras field of view. Next move the “Sync slice position” slide bar to the desired location. Then, press “Synchronize.”

The system can also perform the above steps automatically to find the best sync position and width. Click the “Synchronize Automatically” button. The sync slice will be automatically positioned and sized. Note: The system cannot tell dynamic data from static data on the label. Synchronizing Automatically can lead to syncing on dynamic data which could lead to poor or inadequate syncing.

There is no limit to the number of times that manual and automatic sync can be performed.

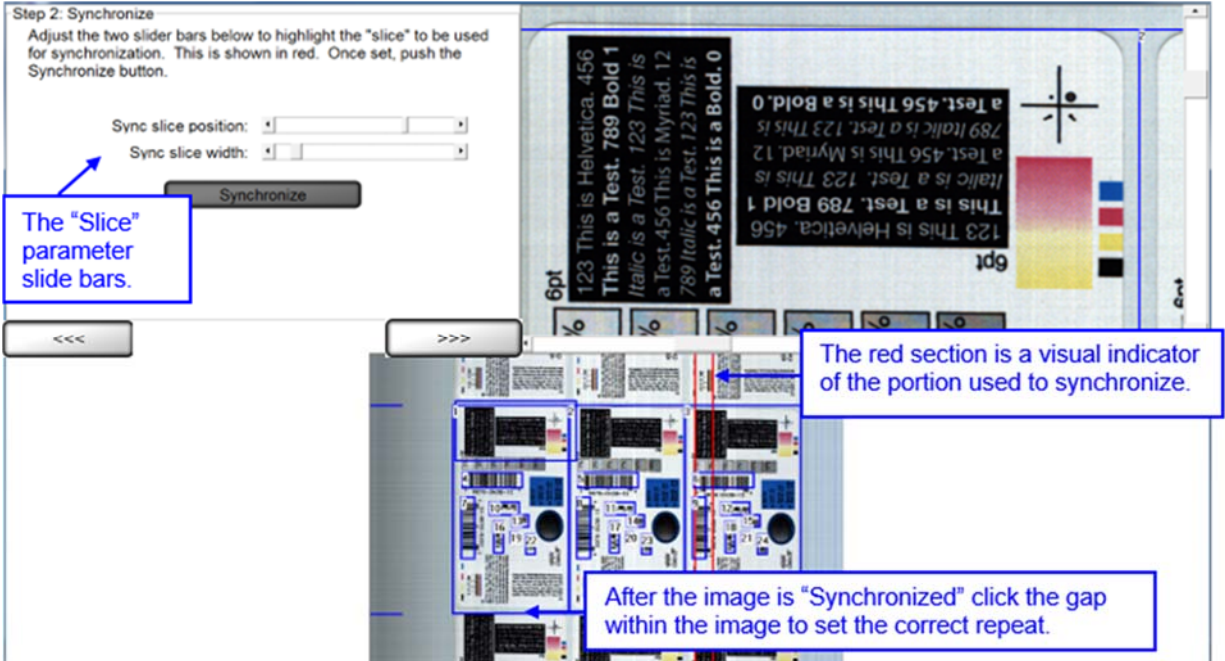
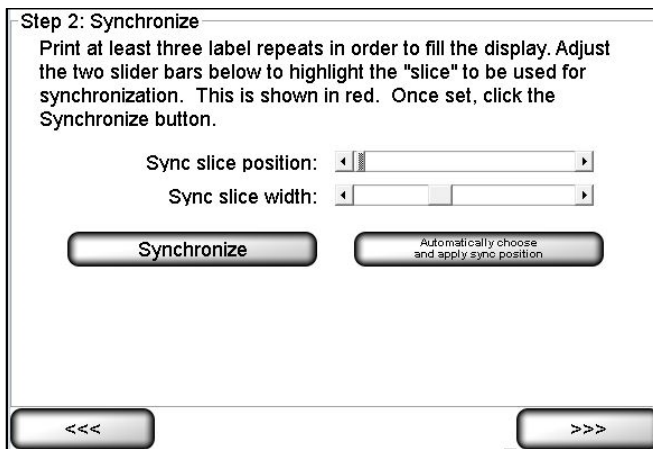

2. To perfectly center the label in the display, point and left-click the mouse in the center of the label gap shown on the display. The large (full resolution) or the small (full field of view) image can be used. For very small repeats, the larger image is easier to pinpoint the gap location. Blue hash marks on the side on the image in 20% and 50% display size must fall in the gaps above and below the label.
3. Click the **right arrow** button.

Step 3: Create Sectors

A sector is defined as an area or region of interest that is to be analyzed. This step prompts the operator to establish a sector. The software will not process anything located outside the sector.

An image must be present to draw a sector. Print several labels and allow them to pass under the camera to obtain an image. Once an image is acquired, the operator may stop printing and work with the still image.

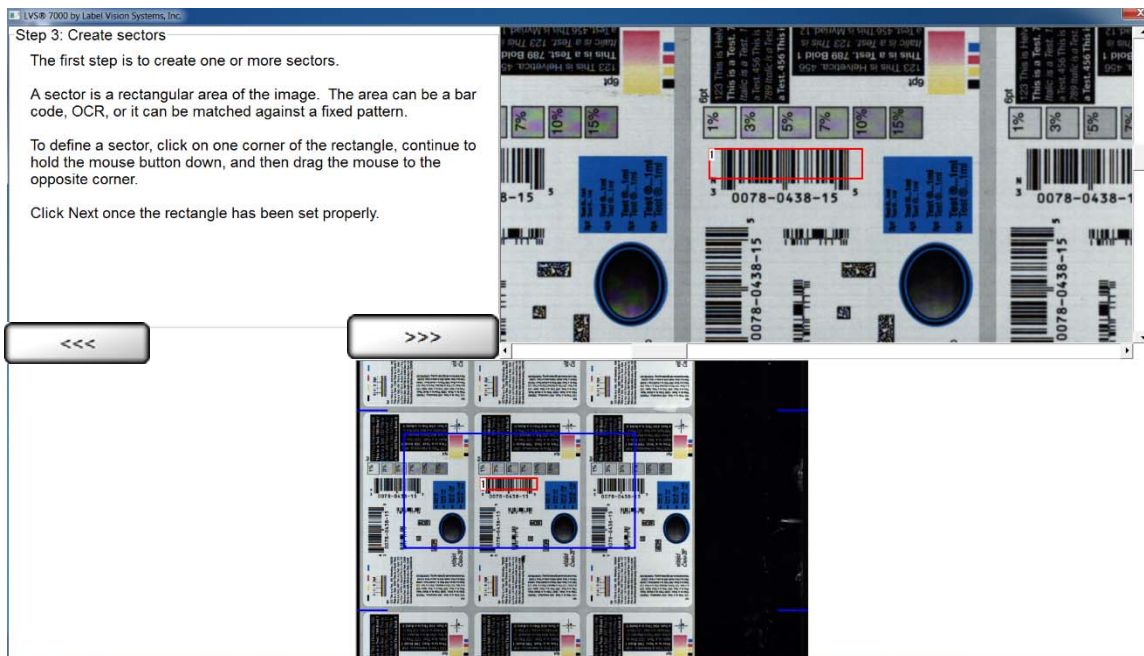

The above image is an example of a sector being drawn around a barcode. The image shown is in color; however, the LVS-7510 camera is a grayscale camera only.

Draw a Sector

1. Click on one corner of the area you wish to inspect and drag the mouse while holding down the left-click button. This action will cause the software to draw a “red” box.
2. After you are satisfied with the sector position and size, click the **right arrow** button shown on the display. (Note that a right mouse click does not perform this function.) The box location will not be stored until the **right arrow** button has been selected.

Note: The operator may draw a sector in either image.

Edit a Sector

1. Using your mouse, click within the desired sector that is located within a blue box; the sector bounding box then turns red.
2. Click the **right arrow** button to edit the sector.
3. You will be directed to Step 4 where you define the sector type.
4. After you are satisfied with the sector, click the **right arrow** button. The box location will not be stored until the **right arrow** button has been selected.

Copy an Entire Sector

This option is used to quickly duplicate sector settings for multiple objects of interest within the same label, or to another label in the same row across the width of the web.

1. Using your mouse, click within the desired sector that is located within a blue box; the sector bounding box then turns red.
2. Right-click inside the desired sector; the sector bounding box turns green.
3. Drag and drop the selected sector to the desired location; this copies the parameters of the selected sector.
4. After you are satisfied with the sector, click the **right arrow** button. The sector location will not be stored until the **right arrow** button has been selected.

Note: If you decide not to copy a sector and would like to exit the copying function, simply move the cursor back to the original sector.

Copy Multiple Sectors

1. Using your mouse, click within the desired sector that is located within a blue box; the sector bounding box then turns red.
2. Press the **Ctrl** button on your keyboard while using your mouse to select the additional sectors. Each selected sector is highlighted in a red box.
3. Right-click on any sector; this causes a green box to appear around each sector.
4. Drag and drop the selected sectors to the desired location.
5. After you are satisfied with the sector, click the **right arrow** button. The sector location will not be stored until the **right arrow** button has been selected.

Note: If you decide not to copy a sector and would like to exit the copying function, simply move the cursor back to the original sector.

Tip: Use the smallest sector when precisely aligning copied sectors. This allows you to view the sector's location more precisely in the full resolution image screen.

Shortcuts for Highlighting Multiple Sectors

- [Ctrl] + G: Selects all sectors
- [Ctrl] + Left-Click: Individually selects multiple sectors
- [Shift] + Left-Click: Highlights a range of sectors

Moving Sector(s) with Arrow Keys

Highlight the desired sectors and use one of the actions below.

- Arrow keys only: Moves sector(s) by 1 pixel
- [Alt] + Arrow Keys: Moves sector(s) by 5 pixels
- [Shift] + Arrow Keys: Moves sector(s) by 25 pixels
- [Ctrl] + Arrow Keys: Resizes sector(s) in arrow direction

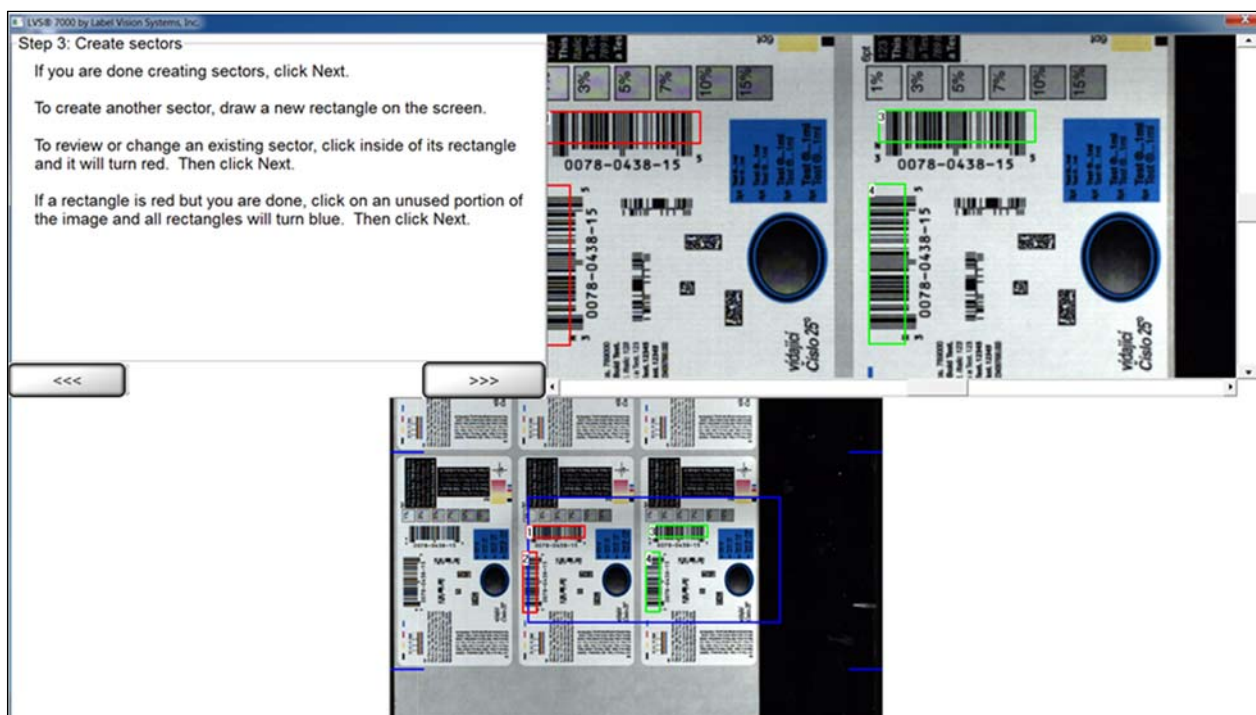

Multiple sectors can be copied and moved to other labels. This is helpful when an operator has to check the same information on different labels within a repeat. The image shown is in color; however, the LVS-7510 camera is a grayscale camera only.

Step 4: Define Sector Type

This step allows you to select the desired sector type that your software is capable of analyzing.

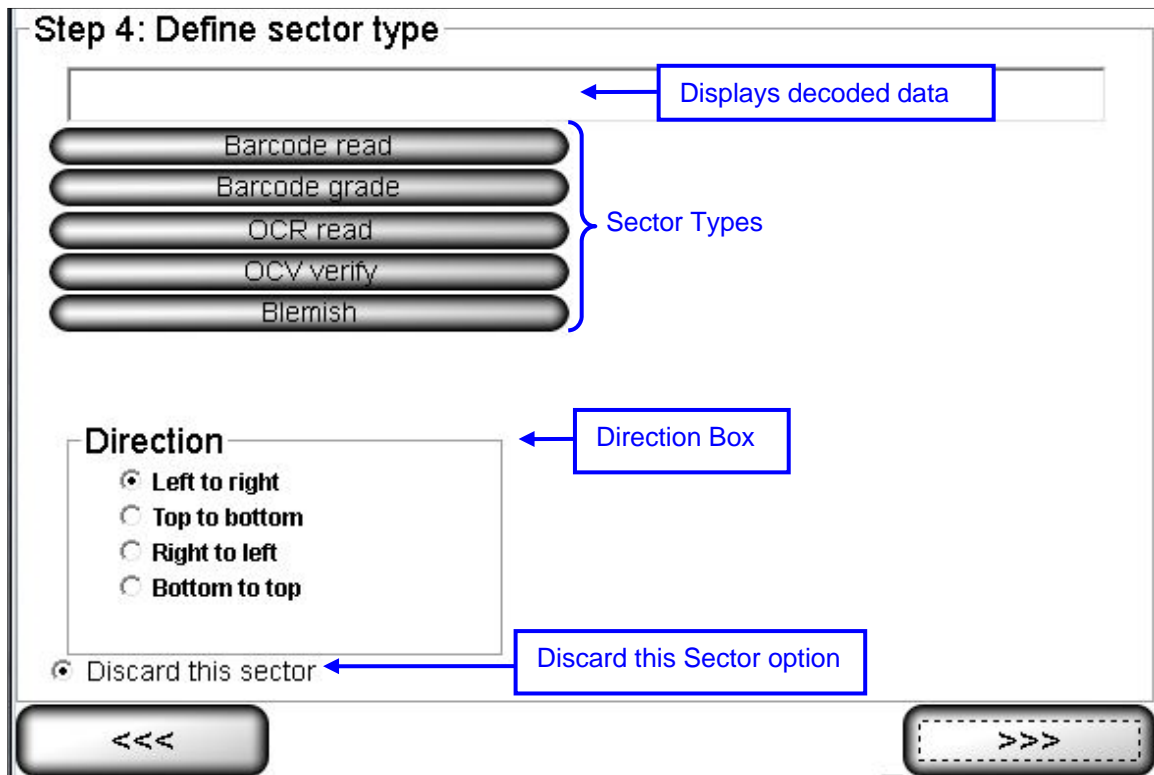

The following sector types are available:

- Barcode read
- Barcode grade
- OCR read
- OCV verify
- Blemish

Note: The field located above the sector type list pre-populates with the string that the system is returning for the sector type. For example, if selecting the **Barcode read** sector type, the field populates with the decoded string.

Direction Box

The “Direction” box allows the user to select the orientation in which to read the characters across the screen. The feature is applicable when using the OCR or OCV modules. Options include:

Direction	Description
Left to right	Reads characters from left to right. Typically, this is the desired direction.
Top to bottom	Reads characters from top to bottom.
Right to left	Reads characters from right to left.
Bottom to Top	Reads characters from bottom to top.

Examples:



Top-to-Bottom



Bottom-to-Top

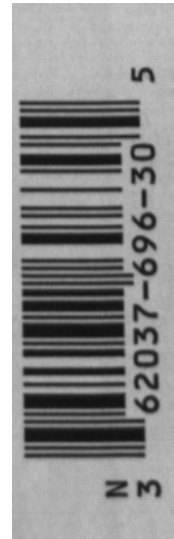

Left-to-Right



Right-to-Left

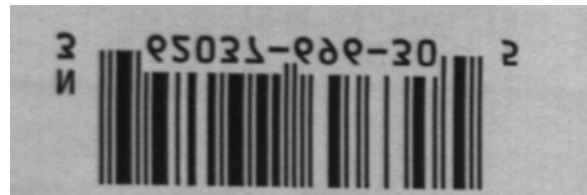

Discard This Sector

If you have incorrectly drawn a sector, click the **Discard this Sector** button and then select the **right arrow** button. The sector is deleted. Sectors can also be removed by hitting the delete key while a sector(s) is active.

Sector Types

The following is a list of sector types with a description on how to set up a template using that specific sector type.

Sector Type 1: Barcode read

This sector is used to validate a 1D or 2D barcode label. The LVS-7510 inspects the barcode image to determine if it is “readable” by a scanner.

1. Select Barcode read.

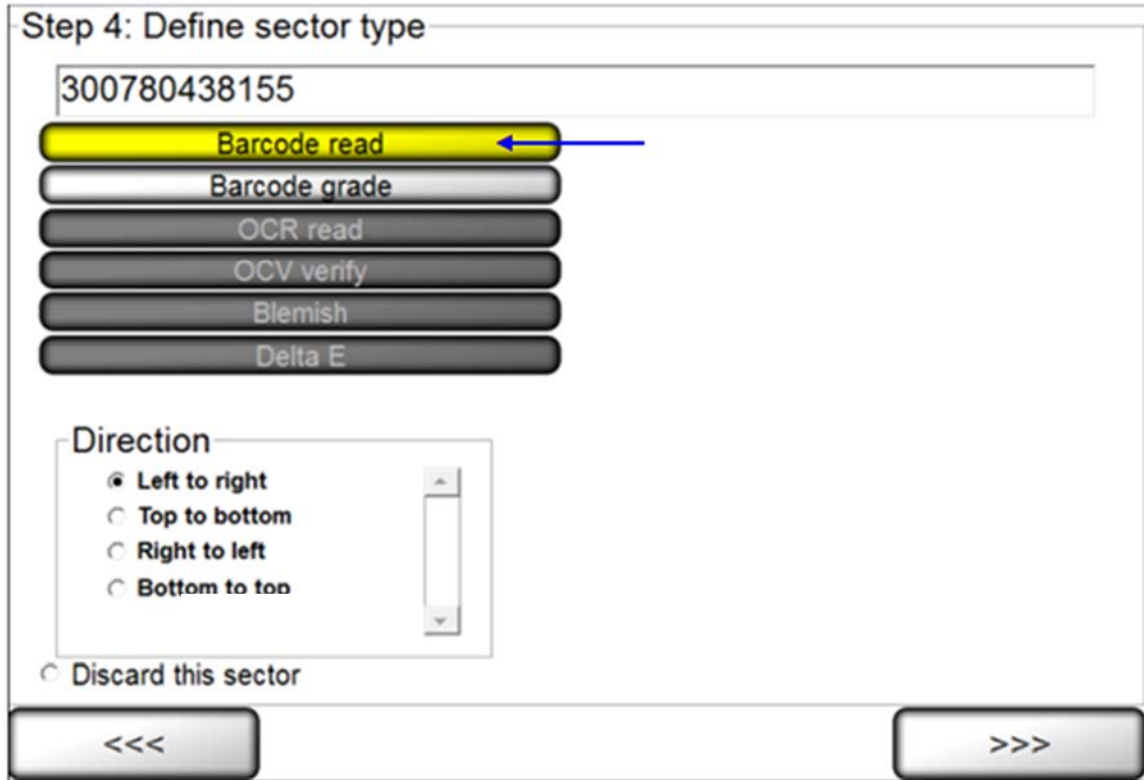

2. Select the desired direction. The encoded data is shown in the top left corner of the screen.
3. Click the **right arrow** button.

Sector Type 2: Barcode grade

This sector is used when you want to grade the 1D or 2D barcode image according to ISO/IEC standards.

1. Select Barcode grade.

Step 4: Define sector type

300780438155

Barcode read
Barcode grade
 OCR read
 OCV verify
 Blemish
 Delta E

Bar code parameters

Xdim	10.5
Quiet zone	FAIL
Contrast	4.0(A)96%
Modulation	1.2(D)47%
Decodability	2.6(B)52%
Defects	4.0(A) 5%
Rmin	0%
Rmax	97%

Direction

Left to right
 Top to bottom
 Right to left
 Bottom to top

Discard this sector

Scoring

A: 3.5 - 4.0	Warning	2.5
B: 2.5 - 3.4	Passing	1.5
C: 1.5 - 2.4	Actual	0.0
D: 0.5 - 1.4		
F: 0.0 - 0.4		

<<< >>>

2. Select the desired direction.
3. Choose an acceptable grade in the **Scoring** box (see below).
4. Click the **right arrow** button.

Scoring Box

The Scoring box allows you to choose an acceptable grade from 0.0 to 4.0.

Scoring

A: 3.5 - 4.0	Warning	3.5
B: 2.5 - 3.4	Passing	1.5
C: 1.5 - 2.4	Actual	3.9
D: 0.5 - 1.4		
F: 0.0 - 0.4		

Warning	Indicates an early warning of diminishing quality in the barcode image. The operator must take action to improve the grade score quality.
Passing	Represents what ISO/IEC grade is considered to “pass” and is user-defined to one decimal place.
Actual	Represents what grade is being detected using the setup barcode label.

Sector Type 3: OCR Read

This sector type is used to “read” the human readable characters located within the drawn sector.

OCR and OCV Guidelines:

- Characters must not touch or overlap
- All uppercase letters in any font are allowed
- Lowercase letters, uppercase letters, and some special characters are allowed in OCR-B MT font (6 to 14 points). Shown to the right are the letters, numbers, and special characters supported by OCR-B MT font (6 to 14 points)
- Monospaced fonts, like OCR-B, are preferred and perform better in the LVS-7510
- Do not attempt to re-learn any of the supplied OCR-B MT fonts

!	"	#	\$	%	&	'	()	*	+	,	-	.	/	
0	1	2	3	4	5	6	7	8	9	:	;	<	=	>	?
@	A	B	C	D	E	F	G	H	I	J	K	L	M	N	O
P	Q	R	S	T	U	V	W	X	Y	Z	[\]	^	_
a	b	c	d	e	f	g	h	i	j	k	l	m	n	o	
p	q	r	s	t	u	v	w	x	y	z	{		}	~	

Steps:

1. Select OCR (read).

Step 4: Define sector type

Barcode read
Barcode grade
OCR read
OCV verify
Blemish
Delta E
Streak Void

Font information

Select font: OCR_B_MT_8.bmp

Create / Learn / Edit

Invert (white chars on black)
 Preprocess (for noise)
 Dilate (for breaks)
 Variable background
 Compare (font file to actual)

Direction

Left to right
 Top to bottom
 Right to left
 Bottom to top

Discard this sector

<<< >>>

2. Select the desired direction.
3. Follow the steps below:
 - a. Select the desired font by choosing one of the options below:
 - To choose a specific font, click the **Select font** button and select the desired font.
 - To create, train and edit fonts, click the **Create/Learn/Edit** button. See the “Create/Learn/Edit Fonts” section below for more information.
 - b. Additional options include:
 - **Invert (white chars on black)** tells the sector to look for white characters on a dark background.
 - **PreProcess (for noise)** reduces noise and background contrast variances.

- **Dilate (for breaks)** joins characters using a blurring and joining technique; it makes the characters bold and darker. This option is useful for Dot Matrix-type printing.
- **Variable background** attempts to compensate for text printed on backgrounds that have a gradient or change from one color to another.
- **Compare (font file to actual)** displays an Actual vs. Font File image in the lower half of the screen. The image shows the font file across the top of the image and the actual characters within the sector down the left side. Differences between a font file and an actual character are highlighted in white over black in the center of the screen. Each character is matched against the font file and given a score. The character with the highest score is then used as the result.

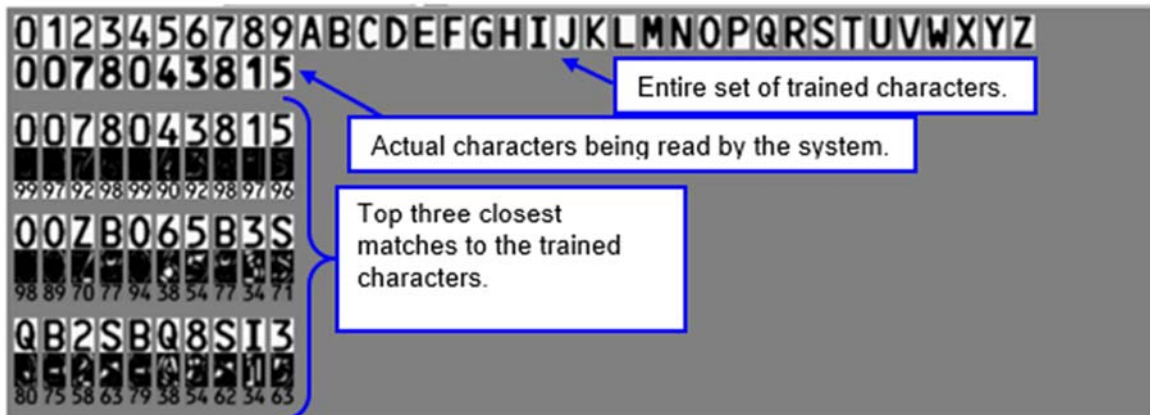

4. Click the **right arrow** button.

Create/Learn/Edit Fonts:

1. Click the “Create/Learn/Edit” button. The Font Editor page appears (see below).

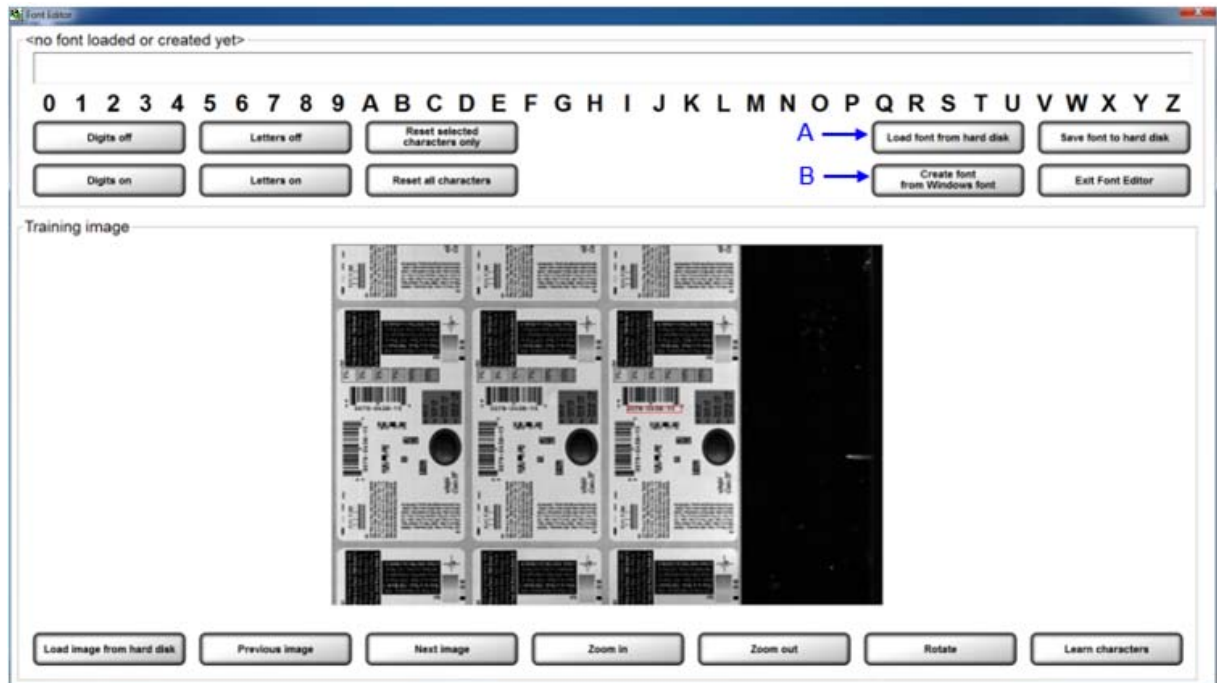

2. The desired font must be loaded or created. **DO NOT** attempt to re-learn any of the supplied OCR-B MT fonts.
 - To load a font from a specific location, click the “Load font from hard disk” button (see “A” in the above screenshot). Locate the desired font, and then click “Open”.
 - To create a font using a Windows font, click the “Create font from Windows font” button (see “B” in the above screenshot). Select the desired font and then click “Ok”.

- The selected font appears in the top text field.

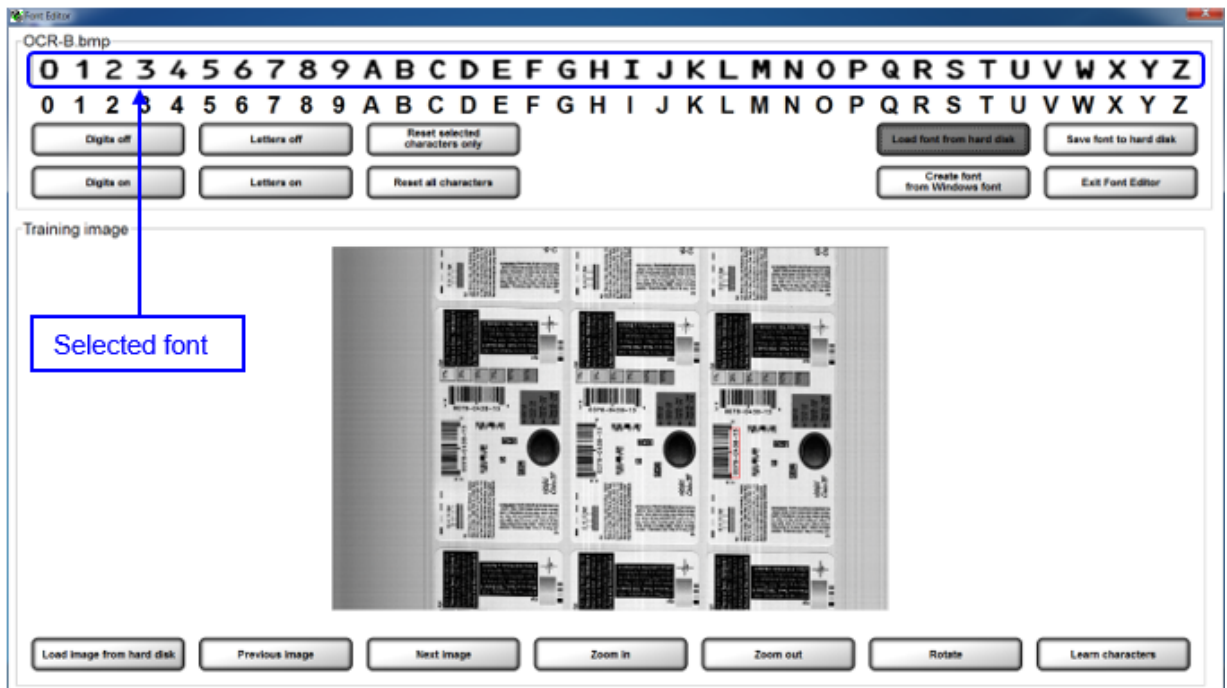

- Use the buttons at the bottom of the screen to capture the desired image view. Buttons include:

Button	Description
Load image from hard disk	Click to load an image stored on a hard disk.
Previous Image	Click to view the previous image.
Next Image	Click to view the next image.
Zoom In	Click to view a magnified image of the label.
Zoom Out	Click to return to the original image view.
Rotate	Click to rotate the image. The image rotates each time the button is clicked.
Learn Characters	Used when training letters or numbers. This button is described in more detail in the following sections. Important: An image must be in normal orientation (from left to right, and right side up) to be used for training (see example below). Use the Rotate button to rotate the image to the desired view.



Note: Click the “Exit Font Editor” button in the top right corner of the screen to discard changes.

- An entire alphanumeric string (0-9 and A-Z), or specific digits or letters, can be trained. Read the sections below for further information.

Train an Entire Alphanumeric String:

- a. An image comprised of an entire alphanumeric string (0-9 and A-Z) must be present in the training image view.
- b. Use the left click button on your mouse to draw a box around the alphanumeric string in the training image view.
- c. Click the “Learn characters” button. The trained alphanumeric string appears in the top field.
- d. When all changes are complete, click the “Save font to hard disk” button. In the window, save the font to the desired folder.

Train Specific Digits or Letters:

- a. All digits and letters must be shaded in gray. Do this by selecting the “Digits off” button and “Letters off” button; this shades all digits and letters.

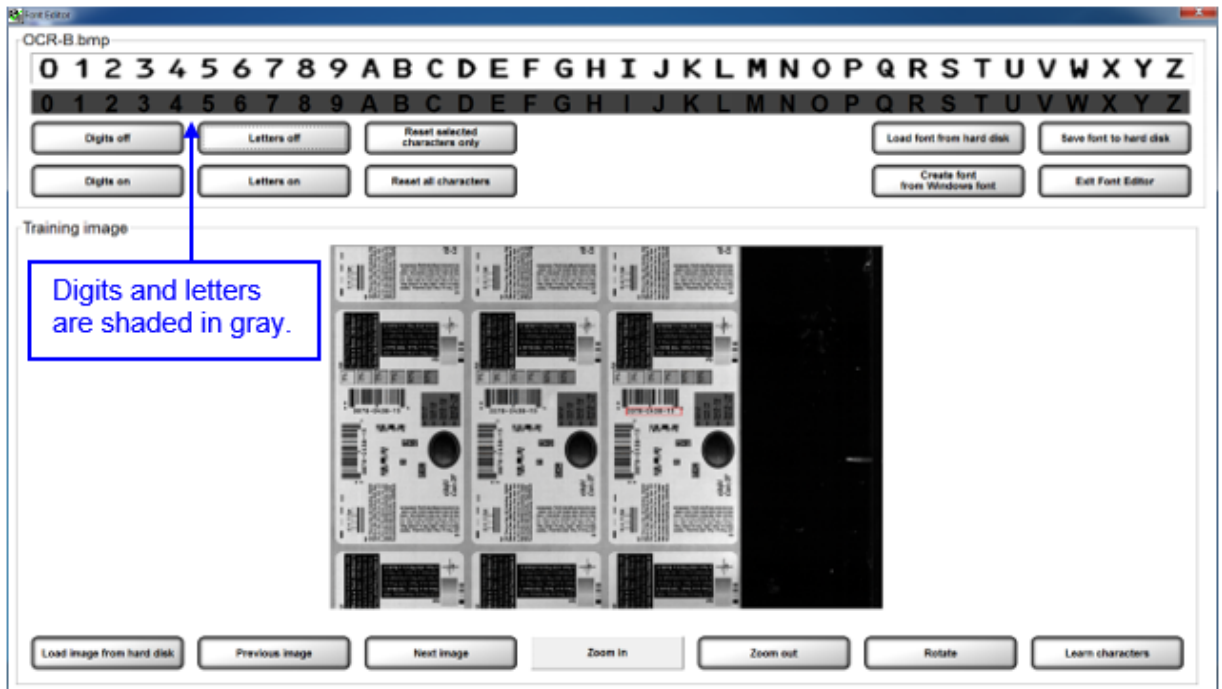

- b. Click on the desired digit or letter; the gray shade is removed from the selected digit or letter. See example below.

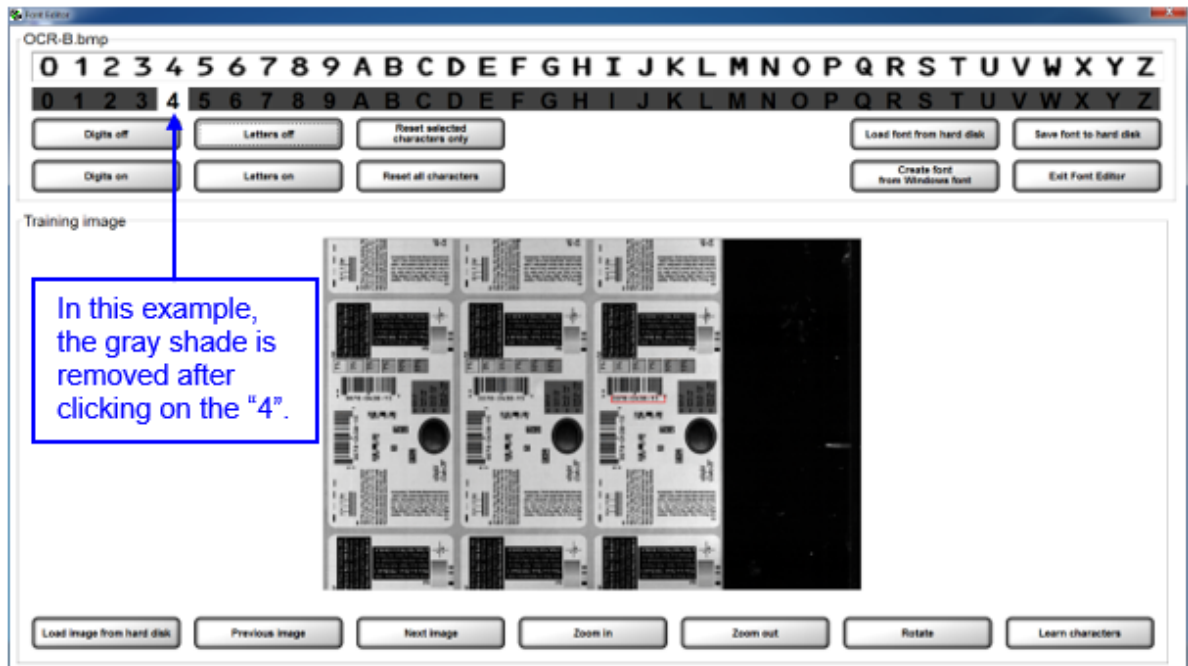

- c. Click the "Reset selected characters only" button. The character disappears (see below).

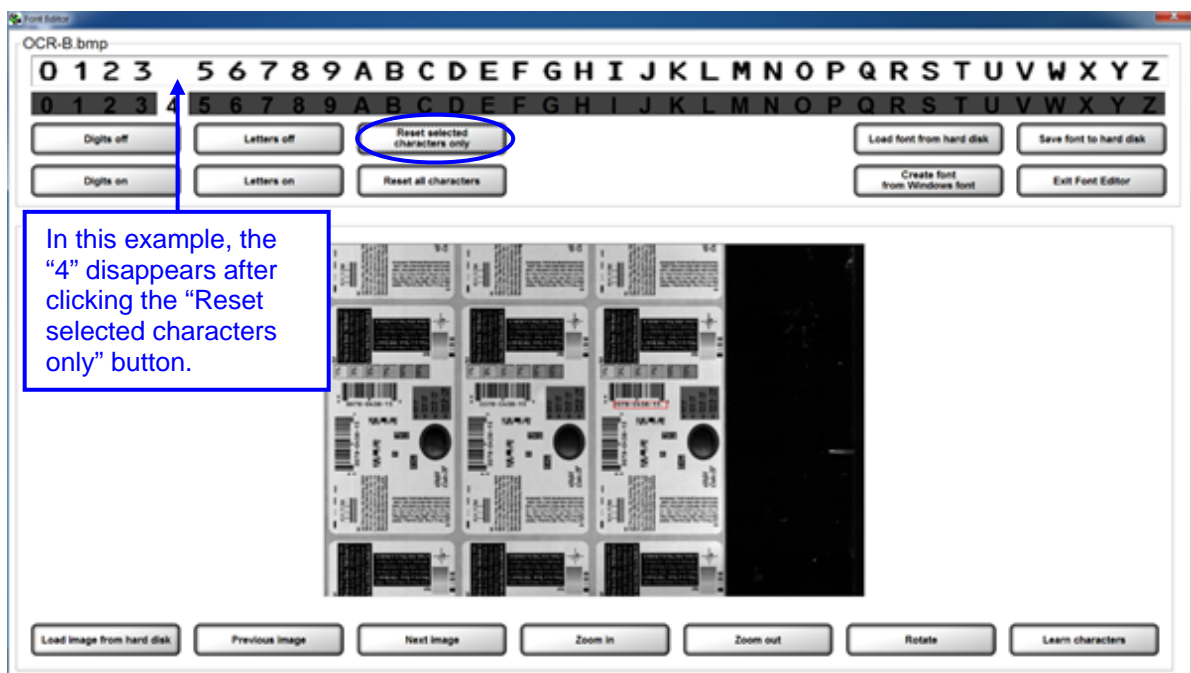

Note: If you do not select this button, the software averages the character in the top text field with the character in the training image.

- d. Use the left click button on your mouse to draw a box around the letter or digit in the training image view (see below). Note that the training image in the screenshot below appears larger after clicking the "Zoom In" button.



- e. Click the "Learn characters" button. The trained character appears in the top field (see below).



- f. When all changes are complete, click the “Save font to hard disk” button. In the window, save the font to the desired folder (see below).

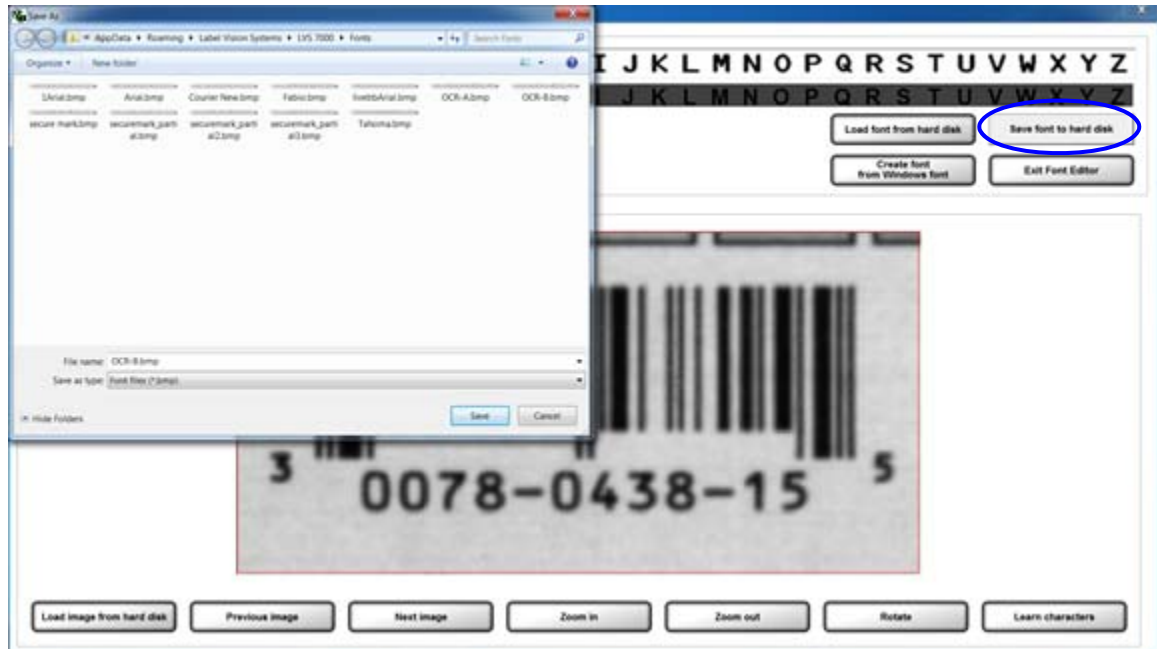

Sector Type 4: OCV Verify

The OCV (Optical Character Verification) sector type is used to score the print quality of the human readable characters within a drawn sector.

Step 4: Define sector type

Barcode read
Barcode grade
OCR read
OCV verify
Blemish
Delta E
Streak Void

Font information

Select font: OCR_B_MT_8.bmp

Create / Learn / Edit

Invert (white chars on black)
 Preprocess (for noise)
 Dilate (for breaks)
 Variable background
 Compare (font file to actual)

Direction

Left to right
 Top to bottom
 Right to left
 Bottom to top

Discard this sector

Scoring

Warning: 60
Passing: 40
Actual:

<<< >>>

1. Select OCV verify.
2. Select the desired direction.
3. Follow the steps below:
 - a. Select the desired font by choosing one of the options below:
 - To choose a specific font, click the **Select font** button and select the desired font.
 - To create, train and edit fonts, click the **Create/Learn/Edit** button. See the section above entitled "Create/Learn/Edit Fonts" for more information.
 - b. Additional options include:
 - **Invert (white chars on black)** tells the sector to look for white characters on a dark background.
 - **PreProcess (for noise)** reduces noise and background contrast variances.
 - **Dilate (for breaks)** joins characters using a blurring and joining technique; it makes the characters bold and darker. This option is useful for Dot Matrix-type printing.
 - **Variable background** attempts to compensate for text printed on backgrounds that have a gradient or change from one color to another.

- **Compare (font file to actual)** displays an Actual vs. Font File image in the lower half of the screen. The image shows the font file across the top of the image and the actual characters within the sector down the left side. Differences between a font file and an actual character are highlighted in white over black in the center of the screen. Each character is matched against the font file and given a score. The character with the highest score is then used as the result.

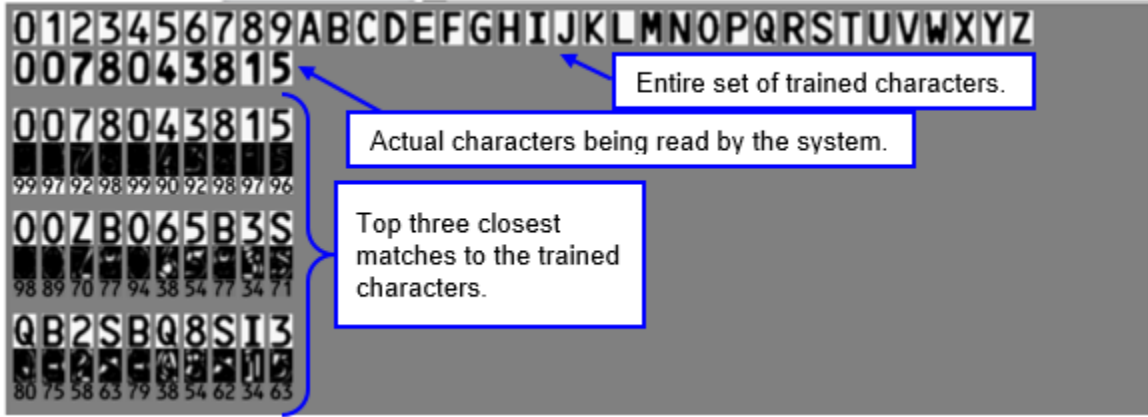

4. Determine a score (see **Scoring Box** below for additional information) and then click the **right arrow** button.

Scoring Box

The OCV Scoring box allows you to choose an acceptable score ranging from 0 to 99.

Scoring

Warning

Passing

Actual

Warning	Indicates an early warning of diminishing print quality. The operator must take action to improve the grade score quality.
Passing	The Passing number is a threshold setting. All "Actual" scores greater than the "Passing" score is said to pass inspection (and vice versa). If the "Actual" score is less than the "Passing" score, then the inspection has failed and alarms can be set to alert the operator.
Actual	The Actual number represents a percentage of confidence. A 95 would indicate that there is a good chance that the characters within the drawn sector are correct. A 20 would indicate that there is a better chance that the characters do not match what was intended.

Sector Type 5: Blemish

To use the Blemish sector type, follow the steps below.

1. Select **Blemish** on the **Step 4: Define Sector Type** screen; the following screen appears.

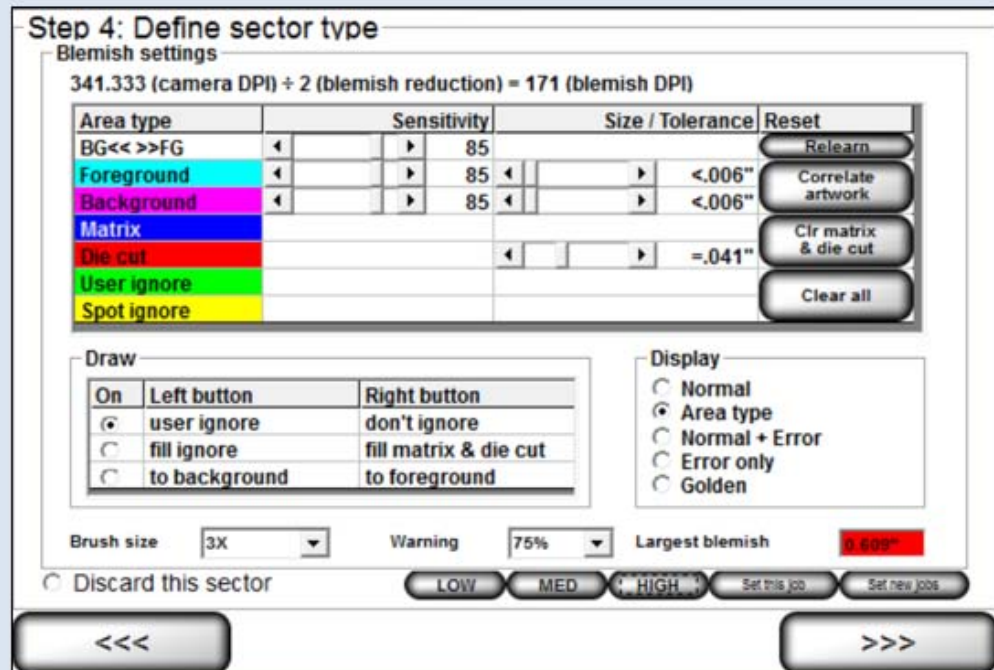

2. The software automatically learns the first image it sees after the first sector has been drawn. If the image is not the correct one, or you would like to put a different image into the field of view, click the **Relearn** button and the software will accept the next image it sees within that sector. This saved image is called the "Golden image". The entire process of understanding blemishes is done by comparing the "Golden image" to the Job image.

Note: **Ctrl+L** is a keyboard shortcut for the **Relearn** button. After pressing **Ctrl+L**, the system will accept the next image it sees within each Blemish sector and saves the image as the Golden image. This shortcut is available only when the system is in Run mode.

IMPORTANT: After pressing Ctrl+L, a popup message will appear for users without administrative rights. The user must enter an administrator user name and password for the command to take effect. The golden image that is recorded is the image after the authorized user name and password is entered.

3. Within the Blemish Settings box (see above), adjust the following fields as needed:

Field	Description
BG<< >>FG << Background >> Foreground	Separates the Foreground from the Background. Increasing this number will define more print as Foreground and less as Background. Decreasing this number will define more of the label as Background and less as Foreground. A sensitivity of 0 will call everything Background and 100 will call everything Foreground.
Foreground Sensitivity	The Foreground Sensitivity setting is the system's allowable deviation in print color contrast after converting to gray scale. A sensitivity of 0 will accept all variations from the original pixels gray scale value, while 100 will allow no variation of the gray scale values. In other words, a setting of 0 will pass everything that is defined as Foreground print and a setting of 100 will pass nothing. The operator will need to adjust this setting to find an acceptable value that does not cause false errors in the print. Foreground is shown in the color Cyan when the Display is set to Area type. Label sections can be sent to the background or foreground through the Draw tool.
Background Sensitivity	The Background Sensitivity works the same way as Foreground but it is meant to find contrast differences in the label's background. Background is shown in the color Magenta when the Display is set to Area type.
Size/Tolerance	These settings allow the user to increase or decrease the size of detected Blemishes. It is important to test the software so that a user understands what size Blemishes are acceptable.
Preset Configuration Settings	The Preset Configuration Settings buttons allow a user to adjust the following six blemish settings and to apply the settings to a particular job or to all new jobs created (based on administrator rights). See the "Preset Configuration Settings" section for more information on using the Preset Configuration Settings buttons. <ul style="list-style-type: none"> • BG<< >>FG sensitivity • Foreground sensitivity • Background sensitivity • Foreground Size/Tolerance • Background Size/Tolerance • Die Cut Size Tolerance 
Matrix	Matrix detects the roll section between labels to ensure the waste material is removed. Matrix is shown in Blue when the Display is set to Area type and is not needed for most label stock.
Die cut tolerance	This setting changes the size of the Red line that wraps around each label when using "fill here" under the Draw section. This area measures the movement of the outside edge of the label compared to the printing within for die movement.

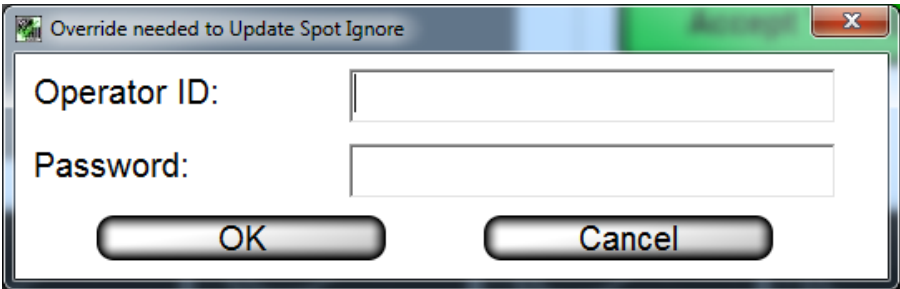
Field	Description
User ignore	This option is enabled in the Draw section and allows the user to draw green ignore areas within the Blemish sector. This tool is useful when there is incrementing data or differences between each label.
Spot ignore	<p>Ignore areas appear in yellow when the "Update Spot Ignore" button is used. This feature is useful for areas of the label that may have frequent deviations from the reference golden image, where deviations are less critical and the operator should be given discretion to accept the label. Only operators granted the Allow Accept / Replace Errors permission are allowed to use the Spot ignore feature.</p> <p>When an operator without Administrator permissions clicks the "Update Spot Ignore" button, the following message appears:</p>  <p>The operator must enter an Administrator's Operator ID and Password to continue, or the Spot ignore feature cannot be used. For more information on permissions, refer to: Welcome Screen Overview → Administration → Operators → Manage Operator Permissions within the LVS-7510 Software.</p>
Brush Size	Allows the user to change how large or small the brush stroke will be when ignoring an area.
Warning	<p>Select the warning percentage. If the current blemish is less than the Blemish Size / Tolerance setting and if the ratio of the current blemish size to the Blemish Size / Tolerance setting is greater than the warning percentage, then the inspection passes but a warning is flagged.</p> <p>For example, suppose you decide that a .25" blemish is considered an error. If the warning percentage is 75%, then a blemish of $.25" \times 75\% = .1875"$ or larger is a warning. Blemish sizes less than .1875" is acceptable and passes the inspection. Blemish sizes .25" and greater will flag an error.</p>
Largest blemish	Shows the largest blemish in inches
Discard this sector	Click this button to delete the sector. After this button is clicked, the "Step 4: Define Sector Type" screen appears allowing you to select another sector. Sectors can also be removed by pressing the "Delete" keyboard button while a sector(s) is active.
Relearn Button	<p>The Relearn Button will re-train the Golden image with the image that is present.</p> <p>Tip: Ctrl+L is a keyboard shortcut for the Relearn button. After pressing Ctrl+L, the system will accept the next image it sees within each Blemish sector and saves the image as the Golden image. This shortcut is available only when the system is in Run mode.</p> <p>IMPORTANT: After pressing Ctrl+L, a popup message will appear for users without administrative rights. The user must enter an administrator user name</p>

Field	Description
	and password for the command to take effect. The golden image that is recorded is the image after the authorized user name and password is entered.
Correlate artwork	Click this button to begin the optional PDF Comparator process, which allows the comparison of PDF artwork to the Omron Microscan golden image for the actual print job. See Design Mode on page 14 for more details on comparing PDFs.
Clr matrix & die cut	Click this button to clear all matrix and die cut filled sections.
Clear all	Click this button to Clear all ignored and auto filled sections within a chosen sector.

4. The options in the **Display** box are shown below:

Field	Description
Normal	Shows the Actual image only.
Area Type	This view shows the label using the color codes for each blemish feature.
Normal + Error	This view allows the user to see errors as they occur. The user usually uses this screen to find the errors, and then goes to the Normal+Ignore screen to draw the ignore sections.
Error Only	This is a tool for the operator to use in order to understand what the software views as a difference between the Golden image and the Actual image. When this option is selected, the image will turn black and errors will be highlighted in white.
Golden	Shows an overlay of the Golden Image over the Actual Image.

5. Click the **Global copy** button to replicate the setting changes in the same sector across all labels. See the "Global Copy" section for more information.
6. Click the **right arrow** button.

Preset Configuration Settings

The preset configuration settings allow a user to adjust the following six blemish settings on the “Step 4: Define sector type (Blemish settings)” screen:

1. BG<< >>FG sensitivity
2. Foreground sensitivity
3. Background sensitivity
4. Foreground Size/Tolerance
5. Background Size/Tolerance
6. Die Cut Size Tolerance

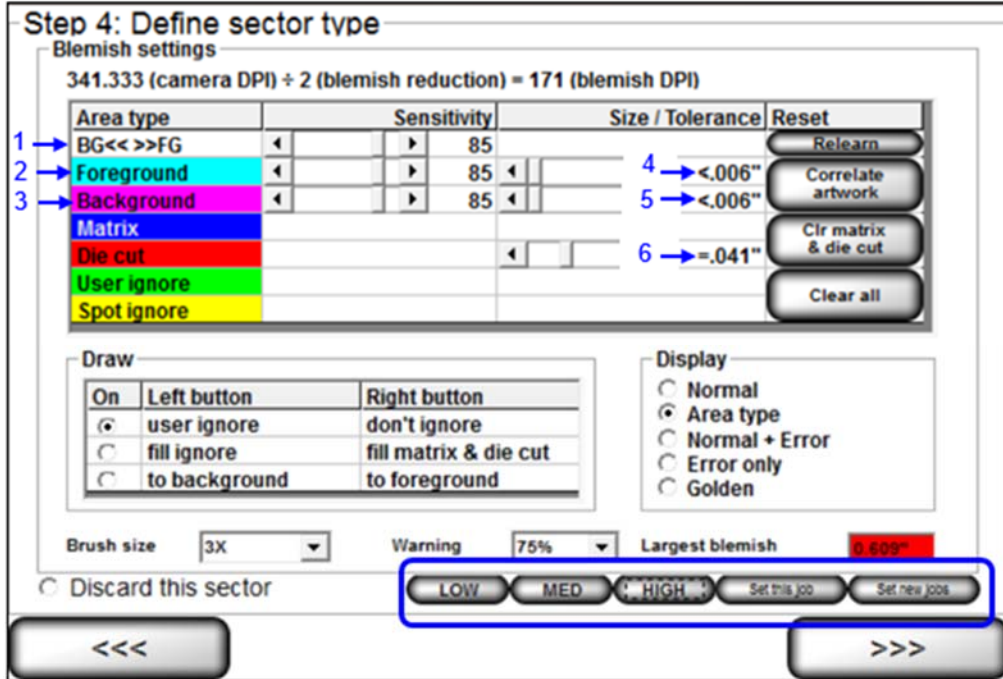

The functionality of the preset configuration settings vary based on user permissions.

- Users with administrator rights can configure the preset configuration settings and apply the settings to a particular job or to all new jobs created. For more information on permissions, refer to: Welcome Screen Overview → Administration → Operators → Manage Operator Permissions within the LVS-7510 Software.
- Users without administrator rights cannot configure preset configuration settings and can only select the “Low,” “Medium,” and “High” preset buttons to adjust the blemish settings on the “Step 4: Define sector type (Blemish settings)” screen.

See the sections below for more information on configuring and using the preset configuration settings.

Note: The preset configuration settings buttons are enabled in the “Settings” menu > [Preset] section > UseFeature setting:

Section	Setting	Value
Preset	UseFeature	0

- **UseFeature=0** (default) – Disables the preset configuration settings buttons
- **UseFeature=1** – Enables the preset configuration settings buttons

Configure the Preset Settings:

Follow the steps below to configure the blemish settings for the low, medium and high preset configuration settings. **Only users with administrator rights can configure the preset configuration settings.**

1. Use the slider bar to adjust the sensitivity or size/tolerance settings for the foreground, background, and die cut settings.

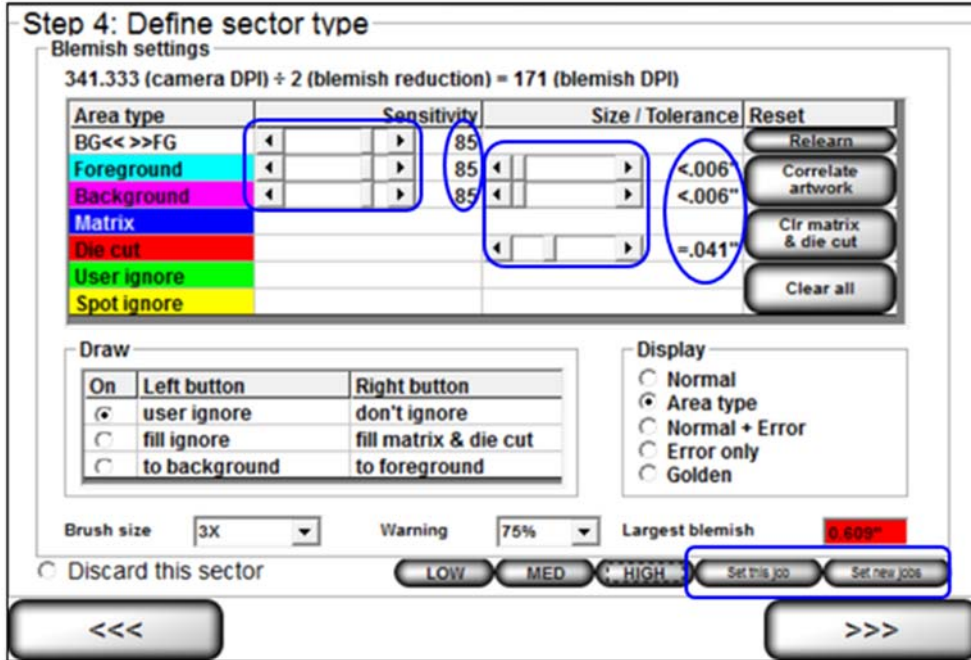

2. When settings are complete, click either the "Set this job" button to apply the settings to only that job, or click the "Set new jobs" button to apply the settings to all new jobs created. These buttons appear only to users with administrator rights.
3. The preset buttons (Low, Medium, High) turn red.

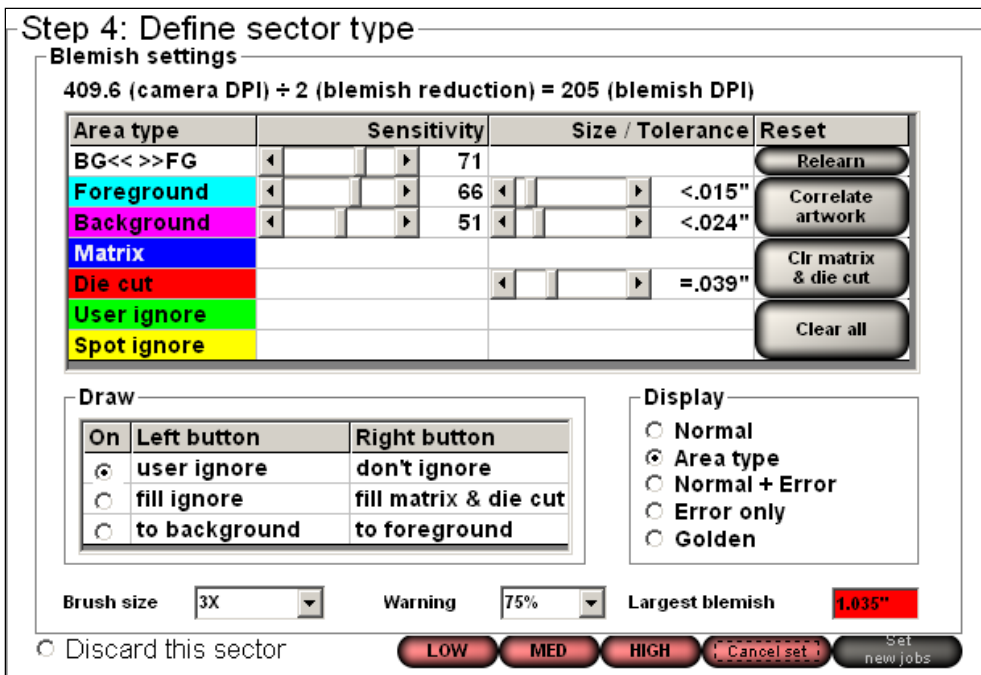

- Click “Low” to apply the blemish settings to the low preset configuration setting.
 - Click “Med” to apply the blemish settings to the medium preset configuration setting.
 - Click “High” to apply the blemish settings to the high preset configuration setting.
 - Click the “Cancel set” button to cancel the blemish configuration settings.
4. Follow the above steps to set the configuration settings for each of the present configuration buttons (Low, Medium and High).

Use the Preset Settings:

Users without administrator rights can select the “Low,” “Medium,” and “High” preset buttons to view the image(s) on the “Step 4: Define sector type (Blemish settings)” screen.

- Click “Low” to adjust the blemish settings to the “Low” configuration settings as defined by a user with administrator rights.
- Click “Med” to adjust the blemish settings to the “Medium” configuration settings as defined by a user with administrator rights.
- Click “High” to adjust the blemish settings to the “High” configuration settings as defined by a user with administrator rights.

Step 4: Define sector type

Blemish settings

409.6 (camera DPI) ÷ 2 (blemish reduction) = 205 (blemish DPI)

Area type	Sensitivity	Size / Tolerance	Reset
BG<< >>FG	75		Relearn
Foreground	75	<.015"	Correlate artwork
Background	75	<.015"	Clr matrix & die cut
Matrix			Clear all
Die cut		=.039"	
User ignore			
Spot ignore			

Draw

On	Left button	Right button
<input checked="" type="radio"/>	user ignore	don't ignore
<input type="radio"/>	fill ignore	fill matrix & die cut
<input type="radio"/>	to background	to foreground

Display

- Normal
- Area type
- Normal + Error
- Error only
- Golden

Brush size: 3X Warning: 75% Largest blemish: 0"

Discard this sector **LOW** **MED** **HIGH**

<<< >>>

Step 5: Setup Matching

Step 5: Setup Matching is used to set up sequential, matching or incremental information checking. This step does not apply to Blemish modules.

Complete the applicable fields and then click the **right arrow** button. Each field description is listed in the table below. The software reverts back to STEP 3 prompting you to set up another sector if desired. If another sector is not required, click the **right arrow** button and proceed with the next step.

Field	Description
Number of characters	Ensure the number of characters is correct for the string length or a "Wrong Length" error will constantly be encountered.
Field Mask	<p>Teaches the sector what type of character to expect for each position within a string. There are three possibilities for each character: numeric (#), alphabetic (@), and alpha/numeric (*). Special characters can also be used by typing the exact character in the position where it will be present.</p> <p>The following informational format is to be used: Sample: = (AB)8C23 = (@@)*@## @ means 'A' to 'Z' * means 'A' to 'Z' or '0' to '9' # means '0' to '9' () means ' (' and ') ' - Any characters that are not @ * # are assumed to be special characters.</p> <p>IMPORTANT! Do not include a space inside the mask. Also, OCR/OCV can handle up to 39 characters and an error will occur if there are more than 39 characters in the field mask box.</p>
Accept everything (do not match)	If sequential or matching checking is not required, click the Accept everything (do not match) option and leave all other options on this page alone. This option will be grayed out when using OCV.

Field	Description
Match this text	To match a static (unchanging) number, select Match this text and enter the desired string into the text box.
Match data in sector	<p>If you are using multiple sectors, you may wish to match the data in one sector to the data in another sector. To accomplish this, select Match data in sector and choose the desired sector from the drop-down list of previously trained sectors.</p> <p>The Majority feature looks at all sectors that are set to majority, takes the most popular result, and then matches the sectors to that popular result.</p> <p>The At Position feature tells the software where to start reading data within a sector.</p> <p>Take the string A1234 as an example, if you change at position to 3 then the software will only read 234.</p> <p>The Global copy feature will copy the logically located sector as compared to the original “From” and “To” sectors’ positional relationship.</p> <p>Refer to the diagram below in the “Global Copy Diagram” section.</p>
Ascending or Descending	<p>When checking sequential data, you must select Ascending or Descending.</p> <ul style="list-style-type: none"> • If the numbers are incrementing by a different amount, you can select the amount to increment in the Step list box. • If the sequence is a combination of alpha and numeric, then select the Base numbering system.
Prompt When Run is Started	<p>When selected, this feature allows a “Match this text” string to be entered by the operator at the time of starting a run, allowing the “Match To” text to be changed without allowing job editing to that operator’s permissions.</p> <p>When this option is selected the system will prompt at run time for the “Match to” string. Enter the string in the available text field. Note that each sector is labeled accordingly. Data can be entered either using a qwerty keyboard or a bar code scanner with data input mapped to that field using a “keyboard wedge.”</p>
Match to File	<p>This feature compares the data decoded within a sector to the data on a file created by the user. Options include:</p> <ul style="list-style-type: none"> • Duplicates allowed – The system allows for repeated data within the same sector and/or file. • Unique per sector – The system does not allow any repeated data within the same sector and/or column within a file. • Unique per job – The system does not allow any repeated data within the same sector and/or file. <p>See the Match to File section below for additional details about this feature. Click Enter Location to select the location of the file being matched.</p>
Check for Duplicates	<p>Checks data for any duplicates.</p> <p>Options include:</p> <ul style="list-style-type: none"> • Unique per sector – The system does not allow any repeated data within the same sector. • Unique per job – The system does not allow any repeated data within the same sector or job.
Report Label	<p>Use this field to enter a report label, such as a name for the sector. The name entered in this field appears on the Summary Report and acts as a unique user-defined identifier of that particular sector. This field is not available for Blemish sectors.</p>

Field	Description
Global Copy	Click the Global copy button to replicate the setting changes in the same sector across all labels.

Global Copy diagram

Labels BEFORE Global Copy

- In Label 1 below, sector 3 is matched to sector 1.
- In Label 2 below, there are no sectors matched to sector 2.

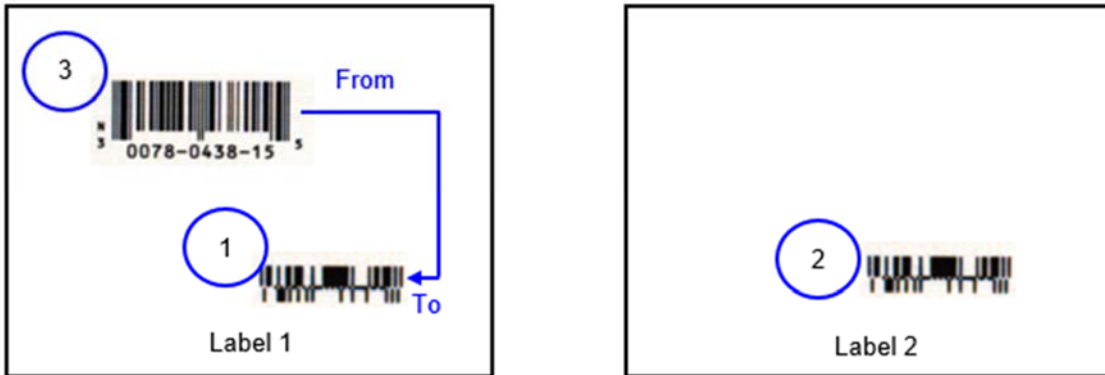

Labels AFTER Global Copy

- After sector 3 is copied to Label 2, sector 4 is created and matched to sector 2, which is the logically located sector as compared to the “From” and “To” sectors’ relationship in Label 1.

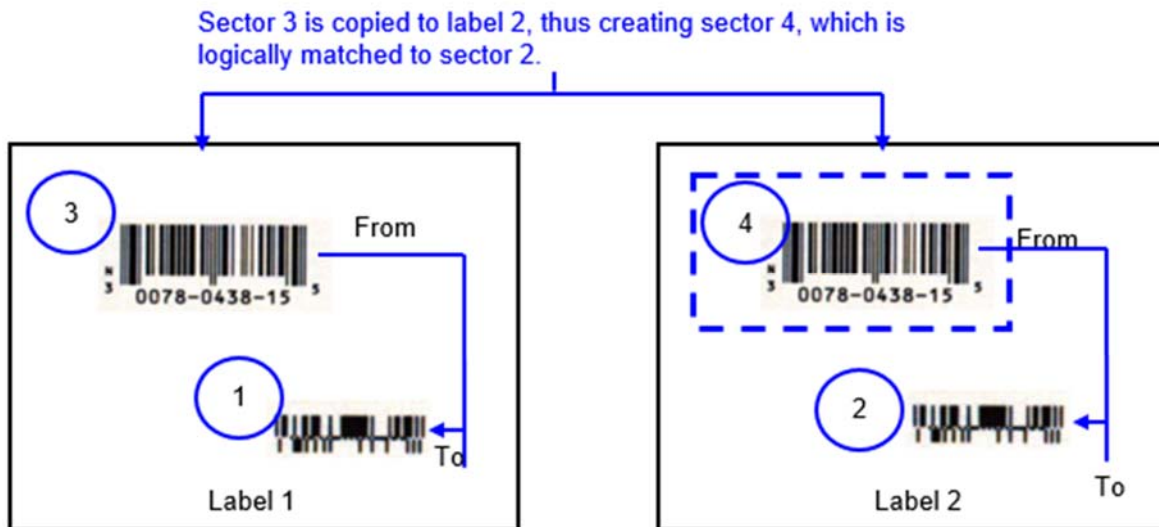

Match to File

This feature compares the data decoded within a sector to the data on a file created by the user. Note that the format of the file must be a comma-separated values (CSV) file.

Any number of sectors can be set to use “match to file”. If all “Match to file” sectors are marked as “Duplicates allowed,” the system will not be able to relocate within the data file if stopped during a run. This means the LVS-7510 is not able to automatically find its place within a run on a job if stopped and restarted. If this occurs, you must access your file and make the first number in the file be the first expected number in the camera’s field of view after pressing the run button. The associated hash files within the job heading must be deleted so they can be recompiled at run time.

IMPORTANT: The “Match to file” feature has associated processing overhead; thus, it is recommended to review all your options and use the “Match to file” feature as a last resort.

Note: You must create the file to “Match To” on a **per job basis**. Tools are not provided in the LVS-7510 software to accomplish this.

The format of the file must be as follows:

- The format of the file must be a comma-separated values (CSV) file.
- The order in which the data is stored is matched to the sector number in lowest to highest order that has been selected to “Match to file”.
- Headers are not allowed.

Example 1:

In the sample below, the LVS-7510 would expect to have two sectors per repeat that are “Matching to File”. The file would show that it expects only 11 repeats of the label. Neither sector is expected to have duplicates. Due to the processing overhead of “Matching to File”, the second sector could be set to perform a sequential check instead of “Matching to File”.

```
01111110, 11111110
01111117, 11111111
01111120, 11111112
01111142, 11111113
01111137, 11111114
01111101, 11111115
01111129, 11111116
01111138, 11111117
01111199, 11111118
01111172, 11111119
01111122, 11111120
```

Example 2:

In this sample, the LVS-7510 would expect to have two sectors per label repeat that are “Matching to File”. As with the above sector, only 11 repeats of the label are expected; however, the second sector has duplicates. The LVS-7510 has processing penalties for “Matching to File”. Thus, with this example, it would be more cost effective to match only the first sector to a file, as the second sector can be set to a fixed match string without the extra processing required.

```
01111110, 11111110
01111117, 11111110
```

01111120, 11111110
01111142, 11111110
01111137, 11111110
01111101, 11111110
01111129, 11111110
01111138, 11111110
01111199, 11111110
01111172, 11111110
01111122, 11111110

Step 6: Alarm Matrix

The Alarm Matrix displays error-specific I/O information. After all sectors have been established, you are prompted to determine an error condition.

Step 6: Alarm matrix

Condition	Code	Trigger	Dwell	Stop motion
Good read		I/O line 3	100ms	
Stop motion		I/O line 4	100ms	
Grade warning		I/O line 2	100ms	
Background	!BG	I/O line 3	200ms	after 2 in a row
Bypass mode	!BP	I/O line 3	100ms	immediately
Check digit	!CD	I/O line 3	100ms	immediately
Database engine	!DB	I/O line 3	100ms	immediately
Delta E	!DE	I/O line 3	100ms	immediately
Die cut	!DC	I/O line 3	100ms	immediately
Duplicate	!DU	I/O line 3	100ms	immediately
Foreground	!FG	I/O line 3	100ms	immediately
Missing ENC1	!E1	I/O line 3	100ms	immediately

Click on a setting to cycle through all possible values.

Depending on the supplied hardware, the following relay outputs can be triggered by any of the listed error conditions:

- Line 1** Connected to the green light indicating a “good read.” It is not connected to a relay
- Line 2** Connected to the yellow light. It is not connected to a relay
- Line 3** Connected to the red light and a relay
- Line 4** Connected to the Stop Motion relay

The 5 columns on this screen are listed below:

Column	Description
Condition	Lists the various error conditions that the system can detect.
Code	Lists the abbreviation of the error conditions detected by the system and used throughout the final reports. See the section below entitled “Error Code Definitions” for more information.
Trigger	Lists any of the four Input/Output lines. Any listed error condition can be trained to activate any I/O line by clicking on the appropriate row box; this will change the path to another line. You can also choose “None”.
Dwell	Lists the duration of the output signal. You can choose from “10 ms” to “hold”.
Stop Motion	States when to activate the “Stop Motion” error condition. You can choose to stop immediately or to not stop at all. Or, you can choose to stop after a certain number of errors occur contiguously (from 1 to 10 errors in a row).
Stop Motion Delay in Inches	This is a set distance that the LVS-7510 will output the stop motion signal. It has a minimum of 4” beyond where the readhead is looking. This is used for precision placement of found errors and may increase if a high processing workload is present.

Error Code Definitions

With the exception of “Good Read” and “Grade Warning,” all error conditions listed below can be made to trigger the Stop Motion Relay immediately, or after a predetermined number of consecutive errors.

Error Code		Definition
N/A	Good Read	When the system is triggered, the camera takes a picture of the label. The system reads all sectors within the image and compares to the associated sector data in the data file. Any sectors that match are a Good Read. The system logs to the report the data read from each sector with no error codes attached.
N/A	Stop Motion	This output is used as a special output that is sent at a fixed distance beyond the located error.
N/A	Grade Warning	This output is used most commonly for the yellow light. It is triggered in conjunction with !QU (quality errors). When something fall into the quality warning zone this output is activated.
!BG	Background	This is a blemish error. The background is defined in the blemish sector setup. This means it is in the background portion of the sector.
!DC	Die Cut	Die Cut checks the print as compared to the outside edge of the label to track how much it moves.
!DU	Duplicate	!DU appears when the character string has been read before in the job that you are running. The Check for Duplicates option in the Matching screen will enable this error.
!FG	Foreground	This is a blemish error. The foreground (!FG) is defined in the blemish sector setup. This means it is in the foreground portion of the sector.
!GP	Gap	When the system is triggered, the camera takes a picture of the label. The system does not read any of the sectors within that image. The system does not continue to increment the next expected record within the data file. The system logs to the report the !GP error code to the associated data.
!MX	Matrix	Matrix searches the areas between labels for unstripped waste.
MM!	Mismatch	When the system is triggered, the camera takes a picture of the label. The system reads all sectors within the image and compares to the associated Job/Sector data in the data file. One or more sectors do not match to what the Job/Sector settings dictate that it should be. The system logs to the report the data read from each sector attaching the MM! error code to the associated sector's data. Mismatch only applies when comparing the data to a match source. If running a Sequential type match, then a Mismatch error will be reported as a Sequence error.
!F1	Missing FNC1	Checks barcode sectors for the presence of FNC1, the Unique GS1 Identifier in the first position.
!NA	Not Assessed	The incoming data is not being assessed due to a separate error.
!NS	Not Synced	The system has lost synchronization, and is therefore not processing any data outside of looking for a re-sync lock. It will auto log this run portion as “requested to splice”
!NR	No Read	When the system is triggered, the camera takes a picture of the label. The system does not read/decode one or more sectors within the image. The

Error Code		Definition
		system compares to the associated Job/Sector data in the data file. The system logs to the report the data read from each sector attaching the !NR error code to the associated sectors' data.
!QU	Quality	When the system is triggered, the camera takes a picture of the label. The system reads all sectors within the image. The system compares to the associated Job/Sector settings in the data file. If one or more characters/barcodes within a sector are found to be outside the pre-determined acceptable quality threshold, then the repeat is marked as an error and displayed in red in the log file. The actual score is appended to the end of the read data.
!RG	Range	The associated data file is loaded the system then reads the first and last record in the sequential data file. The system stores these values. When the system is triggered the camera takes a picture of the label. The system reads all sectors within the image. The system compares to the associated record in the data file. Not only did the record not match the data file, but it was also out of the range of numbers that the data file contains. The system logs to the report the data read from each sector attaching the !RG error code to the associated sector's data.
!CD	Check Digit	On 1D barcode sectors only, a MOD 10 check digit algorithm can be activated. The MOD 10 algorithm uses a simple checksum formula to validate numbers encoded in a variety of 1D barcode symbologies. MOD 10 is intended to protect against mistyping errors and scanning errors.
!SQ	Sequence	When the system is triggered, the camera takes a picture of the label. The system reads all sectors within the image. The system compares to the associated Job/Sector in the data file. One or more sectors are found to be out of numerical sequence as compared to the associated record in the data file. The system logs to the report the data read from each sector attaching the !SQ error code to the associated sector's data. Sequence only applies when comparing the data to a known sequence of numbers. If running a Mismatch type match, then an error in Sequence will be reported as a Mismatch error.
!WL	Wrong Length	When the system is triggered, the camera takes a picture of the label. The system reads all sectors within the image. The system compares to the associated Job/Sector data in the data file. One or more sectors do not match to the specified length of the character string that the Job/Sector settings dictate that it should be. The system logs to the report the data read from each sector attaching the !WL error code to the associated sector's data.

Common Causes for Error Conditions

Error Condition	Possible Cause
Mismatch	The data read did not match to what was expected to be read. This can be caused by poor quality of print causing the system to identify one or more characters as good quality, yet still incorrect. It could also be caused by a character being gone. Either not printed, or somehow has gone outside the sector borders within the image.
No Read	The data within a sector was not read at all. This can be caused by missing print, poor contrast of print, or the expected data was outside of the sector borders within the image.
Quality	The character(s) within a string do not qualify to the standard entered into the OCV Threshold, or the barcode grade is not above the minimal passing score allowed. This can be caused by missing character portions, bad line definition of characters, or stretched/skewed characters, or any of the ISO/ANSI barcode grading parameters being below the acceptable level entered in the "PASS if ACTUAL >=" sector setting parameters.
Sequence	The data does not match to the previous number +/- one. This is most often caused by a miscommunication that causes one or more numbers within a sequence to be skipped or repeated, an unconnected RS-232 cable, or user error on starting number.
Range	The read number is larger or smaller than the file covers. This is usually caused by the incorrect data file being loaded to compare to.
GAP	No data was discernible in any sector. Most common causes are blank media coming through the line, or an erroneous triggering mechanism.
Wrong Length	For barcode reading the code has too many/few characters encoded. This could be from the incorrect code being printed, or the trained in length for the job was incorrectly set. For OCR/OCV characters the same conditions apply, with the addition of the possibility of characters being broken or touching. If a broken character is seen, then one character will become two. If two characters are touching, they will become one combined character. Also be sure that no characters are touching the sector box. The system will ignore any characters that touch the sector box.
Not Assessed	Printer is going faster than what the Camera and PC can handle. LinesperInch or Camera MaxSpeed may be incorrectly set in the "Settings" menu (these settings must be changed by an Omron Microscan representative only).
Duplicate	Character string has previously been seen in this job.

Step 7: Save Job To Disk

1. Enter a template name in the **Job Name** field.

Step 7: Save job to disk

Job name

Description:

Job Report

<<< >>>

2. If desired, enter a description or additional job details in the **Description** field.
3. If desired, click the **Job Report** button to generate an LVS-7510 Job Report which shows the settings for all created sectors. See the next section entitled "LVS-7510 Job Report" for more information on the Job Report.
4. Click **Next**; this saves the current setup.
5. When a new template is saved the first time and Step 5: Setup matching includes a Match to file, the designer will be prompted with the following message: Design Mode – Template Match to File Selection.

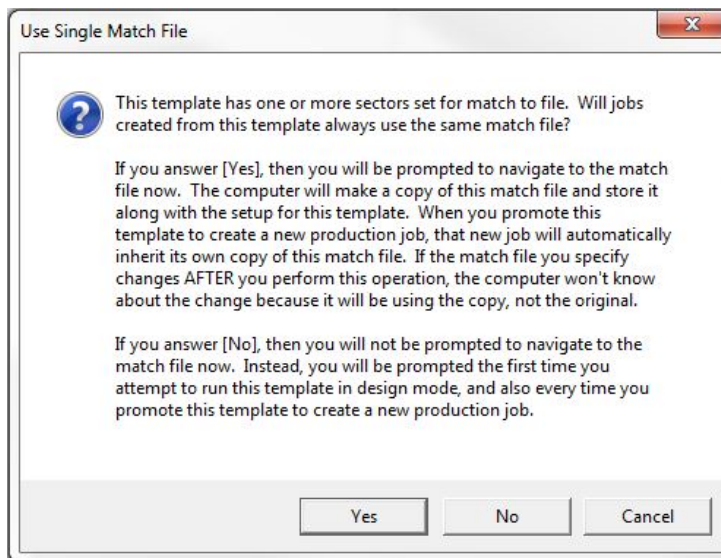

6. The **Ready to Run** screen appears. See the "Design and Production Mode: Running" section for more information on this step.

LVS-7510 Job Report

The LVS-7510 Job Report shows the settings for all created sectors.

The LVS-7510 Job Report appears when configured for HMTL only in Internet Explorer, Firefox or Chrome web browsers; no other web browser is supported. Alternately, the Job Report can be configured to create a .pdf report.



LVS 7510 Job Report
 T8304_UPJ2
 22-Mar-2017 16:47:58



Sector 2	Bar code 1D grading
Minimum passing score	1.5
Warning score	1.5
Number of Characters	
Field Mask	None
Require FNC1	False
Matching Type	DoNot Match



Sector 3	Bar code 2D grading
Minimum passing score	1.5
Warning score	1.5
Number of Characters	
Field Mask	None
Require FNC1	False
Matching Type	DoNot Match



Sector 4	Bar code 1D grading
Minimum passing score	1.5
Warning score	1.5
Number of Characters	
Field Mask	None
Require FNC1	False
Matching Type	DoNot Match



Sector 1	Blemish
Reduction	2
Separation	80%
Foreground sensitivity	75%
Foreground size	0.01"
Background sensitivity	70%
Background size	0.02"

Global Copy

The Global Copy feature allows you to replicate the setting changes in the same sector across all labels. Global copy works with Automatic or Manual setup.

Location of Global Copy button

The “Global Copy” button is visible on the following screens:

- When using the **Blemish** sector type, the **Global copy** button is visible on the “Step 4: Define Sector Type” screen (see below).

Step 4: Define sector type

Blemish settings

400 (camera DPI) ÷ 4 (blemish reduction) = 100 (blemish DPI)

Area type	Sensitivity	Size / Tolerance	Reset
BG<< >>FG	79		Relearn
Foreground	65	<.020"	Correlate artwork
Background	50	<.020"	Clr matrix & die cut
Matrix			Clear all
Die cut		=.040"	
User ignore			
Spot ignore			

Draw

On	Left button	Right button
<input checked="" type="radio"/>	user ignore	don't ignore
<input type="radio"/>	fill ignore	fill matrix & die cut
<input type="radio"/>	to background	to foreground

Display

Normal
 Area type
 Normal + Error
 Error only
 Golden

Brush size: 3X Warning: 75% Largest blemish: 0"

Discard this sector

<<<
Global copy
>>>

Global copy button when using the Blemish sector type.

- For all sector types other than **Blemish**, the **Global copy** button is visible on the “Step 5: Setup Matching” screen (see below).

The screenshot shows the 'Step 5: Setup matching' dialog box. It contains several configuration options:

- Number of characters: 12 (with a 'Variable' checkbox).
- Field mask: (empty text box).
- Radio buttons for matching criteria:
 - Accept everything (do not match)
 - Match this text: (empty text box)
 - Match data in sector: Majority (dropdown) at position 1 (text box)
 - Ascending base: Numeric (dropdown)
 - Descending step: 1 (dropdown)
 - Prompt when run is started: (empty text box)
 - Match to file: Enter location (button) Unique per sector (dropdown)
 - Check for duplicates: Unique per sector (dropdown)
- Report label: (empty text box)
- Navigation buttons: <<< (left), **Global copy** (center, circled in blue), >>> (right, dashed border).

Global Copy Requirements

The Global copy button appears only if:

- There is more than one label per repeat.
- There are at least two sectors.
- There is at least one pair of comparable sectors (same sectors in different lanes)
- The user is on the final step of setting up the sector type.

To define comparable sectors (the same sectors in different lanes), the sectors must:

- Have the same sector type (such as Barcode Read, etc)
- Have the same width (within 20 pixels)
- Have the same height (within 20 pixels)
- Have the same distance from the top of the label (within 20 pixels).

IMPORTANT: A simple solution to meet the above requirements is to copy and paste the first sector to the second sector. For steps on copying sectors, see section “Copy an Entire Sector” (**Design Mode: Create a New Template → Create a Template Using Manual Setup → Step 3: Create Sectors → Copy an Entire Sector**).

Use Global Copy to Add Sectors to All Labels Across the Screen:

1. Create a sector in the left-most lane.
2. Click the **Global Copy** button.
3. A new sector is created with matching parameters of the first sector.

Note: The LVS-7510 only creates the number of labels defined in the “Labels per repeat” field on the “Step 1: Set label repeat” screen (see below).

Step 1: Set label repeat
Enter the distance from the top of one label to the top of the next label.

Current	Desired	Display size
4.36	<input type="text" value="4.36"/>	<input type="radio"/> + 0%
	inches	<input type="radio"/> + 20%
110.7	<input type="text" value="110.7"/>	<input checked="" type="radio"/> + 50%
	mm	
<input type="button" value="Undo"/>	<input type="button" value="Apply"/>	
<input type="text" value="Labels per repeat"/>		
<input type="text" value="3"/>		

Use Global Copy to Edit Sectors:

The example below displays three blemish sectors (1, 2 and 3). The Global copy feature allows you to make the same change to all three sectors without making the changes to each sector individually,

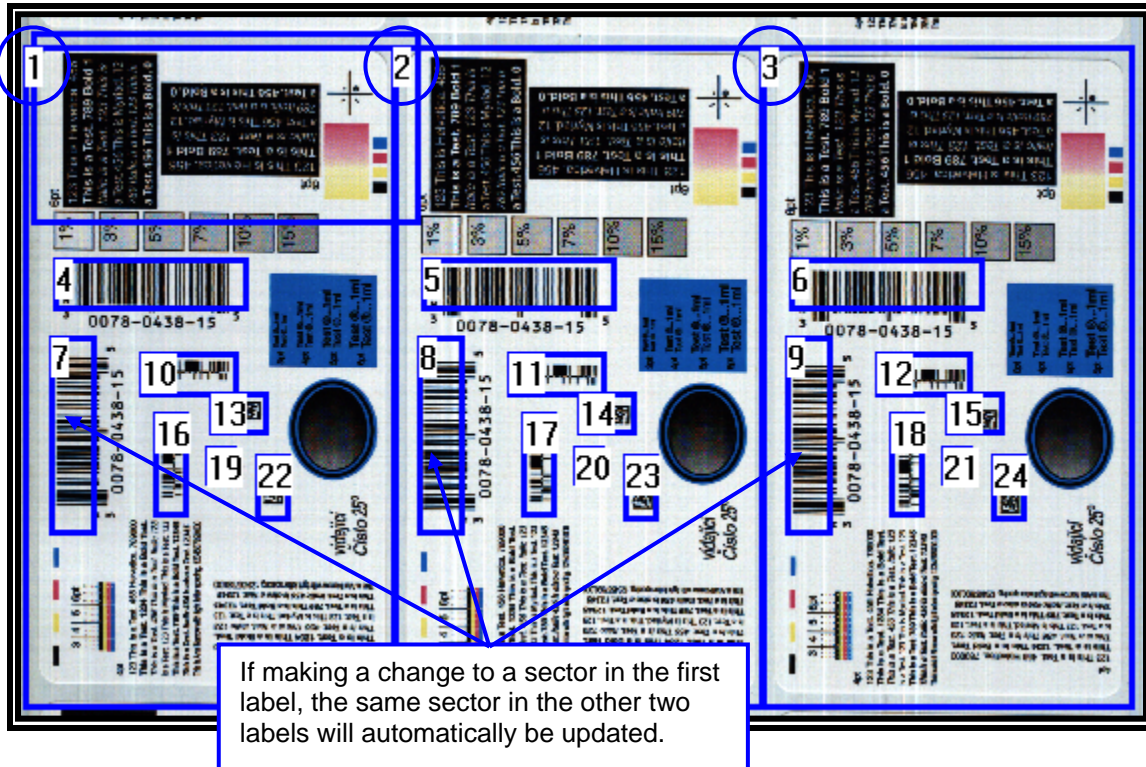

Design Mode: Load an Existing Template

1. To load an existing template, click the “Load an existing template” button on the Welcome screen.



2. A list of existing templates appears. Each column is described in the table below.

Job file	Description	Job file date	Last run file	Last run file date
Barcodes only, 1D and 2D		31-May-2017 13:52:55		
Blemish with OCR		31-May-2017 13:51:03		
OCV with matchfile		31-May-2017 13:56:51		

Column	Description
Job file	List of the job file names.
Description	Description of each job file.
Job file date	The date the job file was created.
Last run file	Highest run number in the existing job.
Last run file date	Last run file date for the job.

3. Choose the job you want by double-clicking the job name.
4. You can sort by any column by clicking on the column header.
5. The “Ready to Run” screen appears with the same job parameters that were originally set for that job. For further instructions, see the section: “Design Mode: Ready to Run.”

Design Mode: Retrieve a Template from Archive

1. To retrieve an archived template, click the “Retrieve template from Archive” button on the Welcome screen. The “Enter Job Name” message box appears.



2. Enter the template name to retrieve or scan in a value.

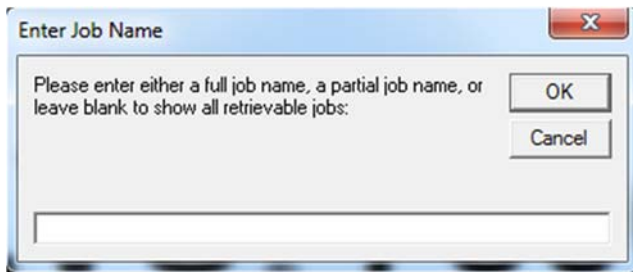

- Entry Methods:
 - Scan a barcode containing the job name to retrieve the job.
 - Enter the job name or part of the job name to filter jobs by the entered characters.
 - If no entry is entered and the “OK” button is clicked, a list of archived templates appears. Double-click the desired template.zip file. The file will unzip and open in the Ready to run state (see section “Design Mode: Ready to Run” for more details).
- If the template is already open and exists in the Design\Templates folder, a “Confirm Overwrite Changes” warning message is displayed stating that this will overwrite changes made since last retrieved.

Design Mode: Ready to Run

Each button on the Design Mode “Ready to run” screen is described in the table below. In Design mode, the “Ready to run” menu has a light blue (cyan) background.



Button	Description
Delete this template	Clicking the “Delete this template” button is used to remove the currently loaded template from the Design environment. A warning message is displayed to confirm the desired deletion. You are also prompted to delete the template from the Design\Archive folder making the template no longer be available from the “Retrieve template from archive” process (deleted forever). Only operators who are granted the Allow Create NEW Job / Edit permission are allowed to delete a template. For more information on permissions, refer to: Welcome Screen Overview → Administration → Operators → Manage Operator Permissions within the LVS-7510 Software.
View Logs	A Report Log is created for every job. Click this button to view all previous reports. For more information on reports, see: Error Display → Reports / QC File Viewer.
Edit this template	Clicking the “Edit this template” button will open the template editor and allow the designer to make modifications to an existing template. Modifying the template name will create a new copy of the existing template under a new name. Only operators who are granted the Allow Create NEW Job / Edit permission is allowed to edit a job. For more information on permissions, refer to: Welcome Screen Overview → Administration → Operators → Manage Operator Permissions within the LVS-7510 Software.
Exit to Main	Click to return to the Welcome screen.
Close out template	Click when changes to current template are completed. All files for the active template will be zipped up and removed from the Design\Templates folder and the zip file moved to the Design\Archive folder. All run data collected during the design process is deleted prior to zipping and is not preserved.

Button	Description
	After close out is complete, the template can be accessed by clicking the "Retrieve template from archive" button on the Welcome screen.
Promote to production	Clicking the "Promote to production" button allows a template designer to prepare a template for execution in the production environment. The designer is prompted with the option to rename the template to a new job name to be used in production. The designer is also be prompted to specify the location of the match-to file if a match-to file was used in the template design and the option was selected to assign a match-to file each time the template is promoted. Job files are zipped and the new <jobname>.zip file is moved to the Production\Import folder. If the job name exists in production, a warning message is displayed.
Make Ready	Make Ready operates exactly as if the system were running normally with the exception that I/O signals to the stop motion/light tower are disabled. See the section below titled "Make Ready Mode" for more information.
Continue Last Run	Select this option if you desire to append to the most recent run's CSV file. You cannot continue a previous run after starting a new run. Only the current run can continue.
Start New Run	Click to begin a new run and new CSV file.

Make Ready Mode

Clicking the “MakeReady” button allows an operator to:

- Simulate how inspections will perform
- Simulate how the template created will work when the live job is run
- Test any changes made
- Test the system without triggering any output signals that might affect the thermal printer

After clicking the “MakeReady” button and when activated in the settings (ShowStatusAlert =1), the screen flashes between red and white (see below) and the words “NOT RUNNING / Make Ready” scroll across the top, left corner of the screen indicating the system is in MakeReady mode. Activating ShowStatusAlert prevents accidental running in MakeReady mode by flashing red.

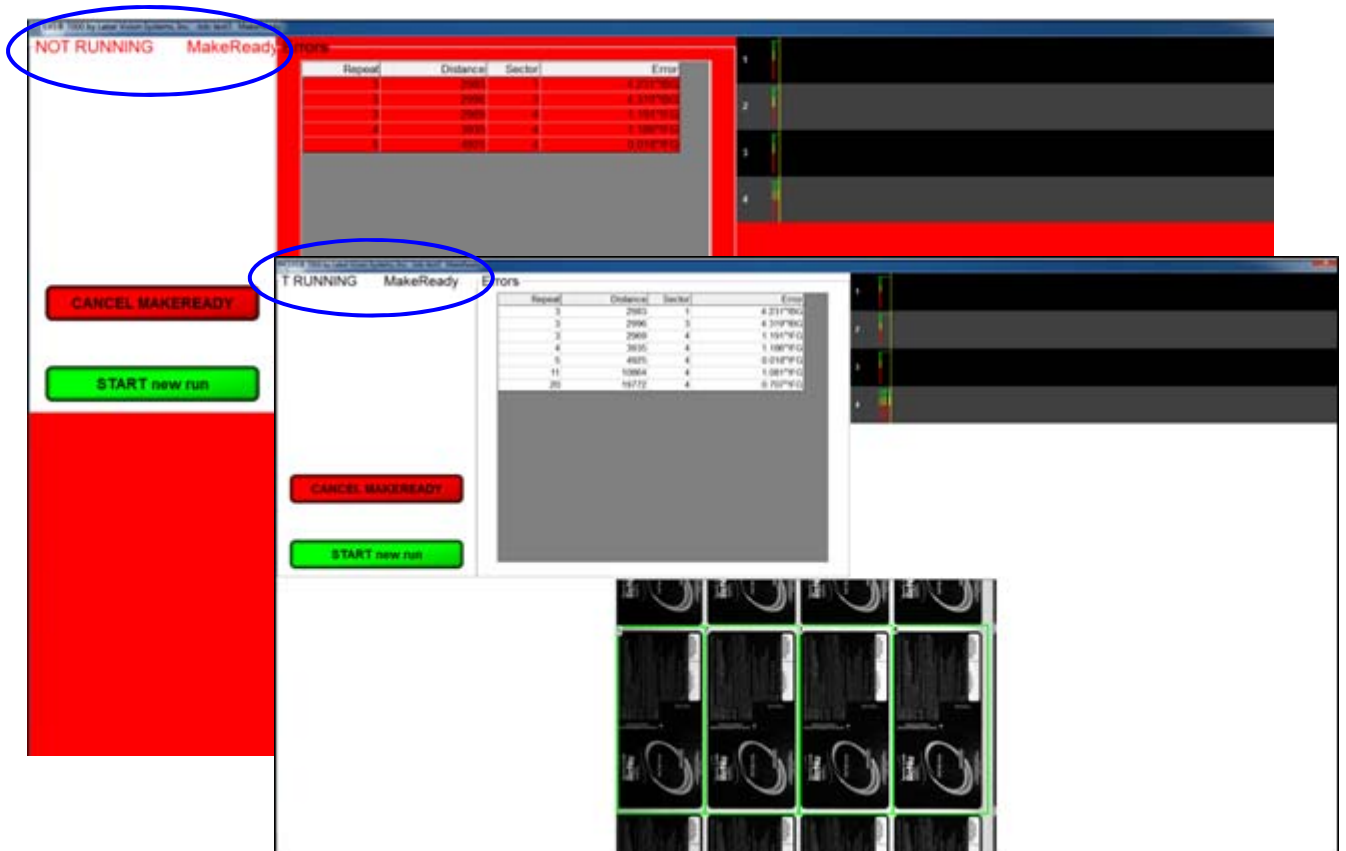

Production Mode: Import a New Job

1. To import a new job in Production mode, click the “IMPORT a new job” button on the Welcome screen. Only one job can be loaded at a time. If an existing job is already loaded this button will be grayed out and disabled.



2. An “Enter Job Name” message box appears. You can type the job name or partial name (to filter jobs) or scan a barcode to input the job name or simply click “OK.”
3. A list of available jobs appears. Only the “Job file” column value is populated because the information for the other columns is not available until the job is unzipped. Choose the job you want by double-clicking the job name.

Job file	Description	Job file date	Last run file	Last run file date
NT0012.2.zip				
NT0012.3.zip				
NT0012.4.zip				
NT0012.5.zip				
NT0012.6.zip				
prod_test1.zip				

4. The “Ready to Run” screen appears with the same job parameters that were originally set for that job. For further instructions, see the section: “Production Mode: Ready to Run.”

AutoExecute Functionality

LVS-7510 monitors the contents of a specified folder and, when a zipped LVS job is copied to that file location, the LVS-7510 automatically imports the job and loads it. The system also offers the option of immediately running the job once it is loaded or allowing the operator to start the job. This functionality is available only in Production mode.

Configuration

The user must specify the folder that will be monitored by the LVS-7510 by setting a CFG (configuration) file specifying the path of the folder on the PC. The user is also required to activate AutoExecute via a configuration setting change. Optionally, the user can configure the system to determine whether or not the LVS-7510 will automatically start the job once imported or await input from the operator. Below is a table outlining the CFG file settings for AutoExecute functionality.

[AutoExecute] CFG config settings	Setting Format	Functionality
AutoExecuteStatus	On or Off	Reports the current runtime status of the AutoExecute functionality.
Path	String	Specifies the folder location that will be monitored
StartRunOnceImported	On or Off	Determines if the job will be automatically started once it is imported
UseAutoExecute	On or Off	Activates the AutoExecute functionality

Run Time Functionality

Once the CFG is set to use AutoExecute, the software runs in production mode and will monitor the contents of the specified folder, which, henceforth, is referred to as the "AutoExecute folder". Once a zipped job is copied to the AutoExecute folder, LVS-7510 automatically unzips and imports the job, stores it in the Production Jobs folder, loads the job and deletes the zip file from the AutoExecute folder.

If the setup has StartRunOnceImported activated, then LVS-7510 automatically starts a new run; otherwise, LVS-7510 remains on the ready screen until the operator starts the new run manually. The operator does not have the ability to manually load or import a job while AutoExecute mode is active. These buttons are grayed-out.

There is an option on the Welcome screen to activate and deactivate the AutoExecute mode via a radio button. There is also a radio button that allows LVS-7510 to be switched from automatically running upon job import, to await instructions from the operator after the job is loaded and ready to run.

Operating Considerations

It is recommended that the AutoExecute folder be populated one job at a time and that the previous job be fully completed and closed out prior to another job being copied to the AutoExecute folder. This is to minimize any mistakes in the production process flow so that the correct labels are printed for the job loaded.

If multiple jobs are added to the AutoExecute folder in quick succession, AutoExecute functionality imports the jobs on a first-in-first-out basis. Once the first job copied to the AutoExecute folder is closed out, the job that was copied into the AutoExecute folder second is imported. The jobs queued to the printer are sent in the same order as the LVS jobs that are stored in the AutoExecute folder.

Production Mode: Load an Existing Job

1. To load an existing job, click the “LOAD an existing job” button on the Welcome screen. In Production mode, only one active job is allowed. If there is no active job loaded, then the “LOAD an existing job button” is grayed out and disabled.

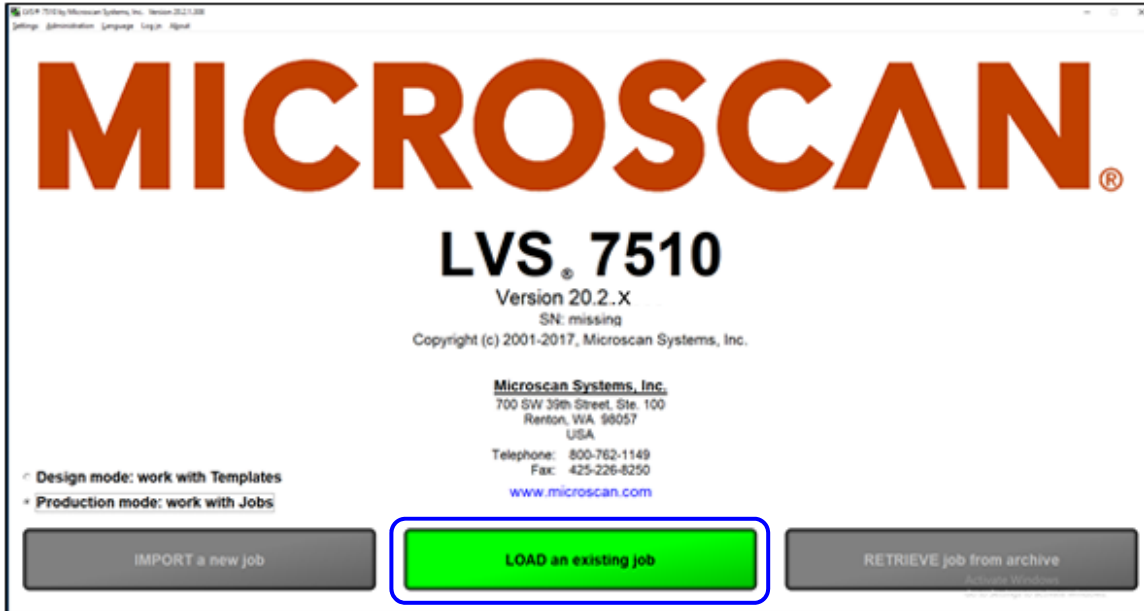

2. A list view opens showing the currently active job available for selection. Each column is described in the table below. In Production mode, only one active job is allowed so there will always be one job in the list.

Column	Description
Job file	List of the job file names.
Description	Description of each job file.
Job file date	The date the job file was created.
Last run file	Highest run number in the existing job.
Last run file date	Last run file date for the job.

3. Choose the job by double-clicking the job name.
4. The “Ready to Run” screen appears with the same job parameters that were originally set for that job. For further instructions, see the next section: “Production Mode: Ready to Run.”

Production Mode: Ready to Run

Each button on the Production Mode “Ready to run” screen is described in the table below. In Production mode, the “Ready to run” menu has a white background.

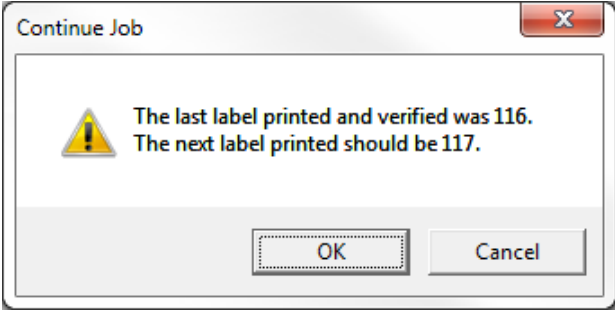

Button	Description
Delete this job	Clicking the “Delete this job” button is used to remove the currently loaded job from the Production environment. A warning message is displayed to confirm the desired deletion. You are also prompted to permanently delete the job from the Production\Archive folder. Only operators who are granted the Allow Create NEW Job / Edit permission are allowed to delete a job. For more information on permissions, refer to: Welcome Screen Overview → Administration → Operators → Manage Operator Permissions within the LVS-7510 Software.
View Logs	A Report Log is created for every job. Click this button to view all previous reports. For more information on reports, see: Error Display → Reports / QC File Viewer.
Edit this job	Click to change the current job settings. Clicking this button opens the job editor and allows the operator to make modifications to the existing job. Only operators who are granted the Allow Create NEW Job / Edit permission are allowed to edit a job. NOTE: Editing a production job does NOT edit the Design Template. Changes in Production Mode should be avoided as they only affect the current job and revision control may be harder to control. Operators with this permission are allowed to change job settings but modifying the job name is not allowed in Production mode. If the operator does not have the Allow Create NEW Job / Edit permission, a “Not Authorized” message appears. For more information on permissions, refer to: Welcome Screen Overview → Administration → Operators → Manage Operator Permissions within the LVS-7510 Software.
Exit to Main	Click to change to a previously set up job. Clicking this button will take you back to the Welcome Screen where you may select other Production mode options.
Close out job	Click when the job is completed and/or a new or archived job needs to be loaded. All files in the active <jobname> folder are zipped to <jobname>.zip and moved to the Production\Archive folder. All run data collected during the job execution is stored in <jobname>.zip. The close out process creates a report file that is located in the Production\Output folder.

Button	Description
Make Ready	Make Ready operates exactly as if the system were running normally with the exception that no data is stored and no I/O is triggered. See the section below titled "Make Ready Mode" for more information.
Continue Last Run	<p>Clicking this button will allow the active job to be continued beginning after the last evaluated label. If the template or job is using a match-to file, the number of labels in a complete job is known. The "Continue Job" message (see below) is displayed with the number of the next label to be printed. Click "OK" to open Running mode. The LVS-7510 will wait on the printer to start printing the next label to be validated. The validation results will be appended to the previous Report/Audit Log file. Refer to the "Design and Production Mode: Running" section for further details.</p> 
Start New Run	Click to begin a new run and new CSV file. Clicking this button will begin a new run log for the current job. If the job has a match-to file, then the operator is prompted to select a new match-to file. The system will be put into Running mode, where the LVS-7510 is waiting for the printer to begin printing labels. Refer to the "Design and Production Mode: Running" section for further details.

Make Ready Mode

Clicking the “MakeReady” button allows an operator to:

- Simulate how inspections will perform
- Simulate how the template created will work when the live job is run
- Test any changes made
- Test the system without triggering any output signals that might affect the thermal printer

After clicking the “MakeReady” button and when activated in the settings (ShowStatusAlert =1), the screen flashes between red and white (see below) and the words “NOT RUNNING / Make Ready” scroll across the top, left corner of the screen indicating the system is in MakeReady mode. Activating ShowStatusAlert prevents accidental running in MakeReady mode by flashing red.

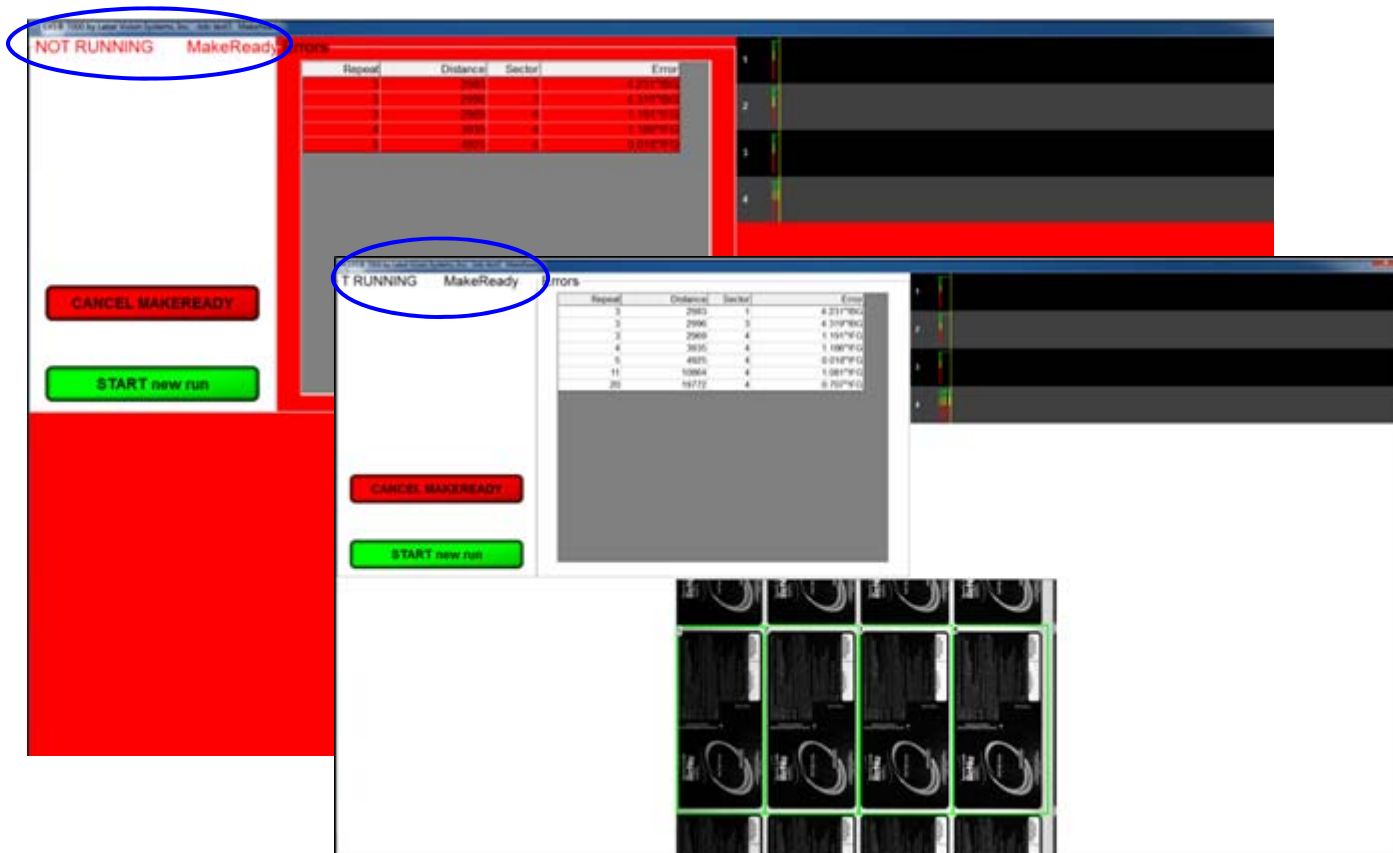

Design and Production Mode: Running

The Design and Production mode Running functionality (running the job) are the same for Design and Production modes. The Running screen is typically what you monitor at all times in a production environment. The features on this screen are described in the table below:

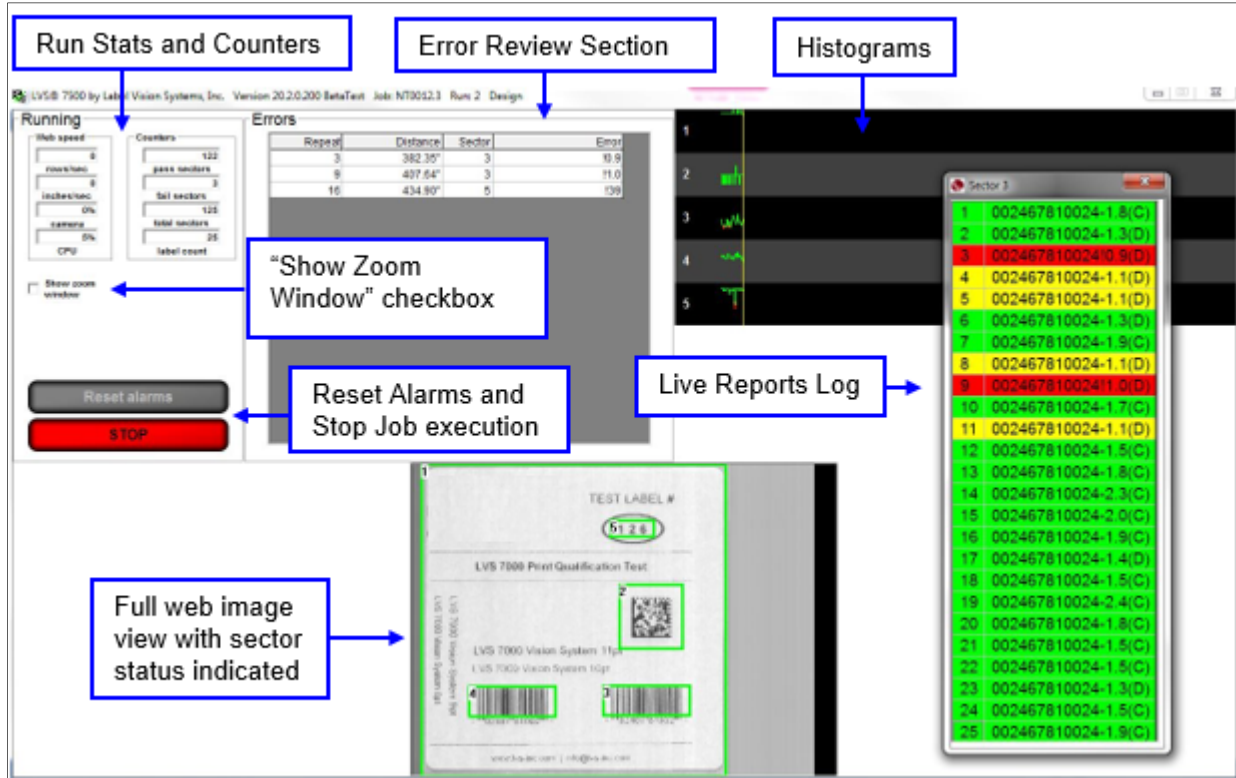

Field	Description
Web Speed	This gives the operator how many rows per second are being analyzed, as well as how many inches per second the printer is traveling. This calculation is based upon the Label Repeat data entered in Step 1.
Counters	There are two conditions being counted: All "passed" sectors and all "failed" sectors. These two conditions are totaled at the bottom of this column.
Camera	Shows a percentage of the Camera Speed. A warning message will appear and Stop Motion trigger if the speed is too high.
CPU	Shows the CPU Usage. A warning message appears if the CPU usage is too high. CPU overrun can cause Not Assessed !NA errors.
Reset Alarms	On the Alarm matrix, there is a "hold" function if/when an error occurs; this is indicated by the term "Hold" appearing in the "Dwell" column on the Alarm matrix. The Reset Alarms button releases the error condition and is visible only when the "Hold" function is activated in the Alarm matrix.
Stop	Press the Stop button to stop the inspection.
Error Display	This is a very helpful feature for the operator to analyze only the errors as they happen. Or, the operator may choose to study one error condition at a time. This feature is activated by clicking on the error. This causes the software to show an image of the error as superimposed thumbnail images (Blemish). The process of showing this error image can be performed while the system is in the Running condition. A series of error images are stored in the log file of each job. Thumbnails of the actual errors can be viewed "offline". See the Error Display section below for more information.

Field	Description
Full Web Image	The image at the bottom of the Running Screen is the entire field of view and will update up to 10 images per second as the printer is running.
Live Reports Log	<p>A log will appear overlaid onto the Running Screen when the operator clicks inside a sector or on the sector number in the histogram. This log represents what the software sees inside this sector.</p> <ul style="list-style-type: none"> • A green box indicates a good read. • A red box indicates an error condition has occurred. • A yellow box indicates a good read below the warning threshold. <p>This log can be moved to any position on the Running Screen by left click and hold at the very top of the log screen. To get a <i>freeze frame</i> of this box click on any other non-sector part of the full web image. This will cause the box to stop updating. To resume the update, just click in the desired sector. Close by clicking the red X (Close) box in the top right corner.</p>
Histograms	<p>At the top of the Running Screen is a section for displaying a histogram for every error condition the software is trained to analyze. It is color coded.</p> <ul style="list-style-type: none"> • Green is “good” • Red is “bad” • Yellow is “good” but below the warning threshold <p>Each sector “Type” will have its own graph. All sectors of a given type will be displayed within the graph designated for that “Type”.</p>

Show Zoom Window

Check the “Show Zoom Window” box to view a magnified image of the label. After checking this box, a blue box appears in the full web image view. Use your mouse to move the blue box over any portion of the label, and then a magnified image appears in the top right corner of the screen (see below).

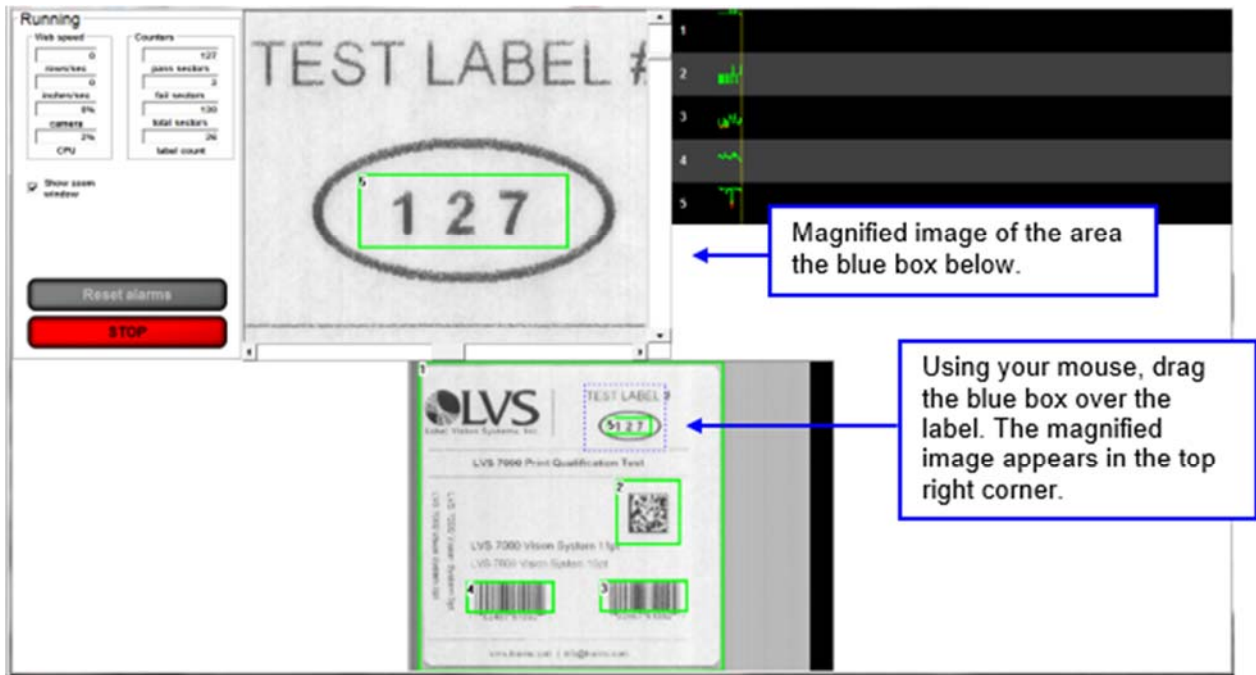

Error Display

The Error Display log can be accessed on the Running screen while you are running the job or after you stop the job. Click on an error to view the barcode image and barcode parameters.

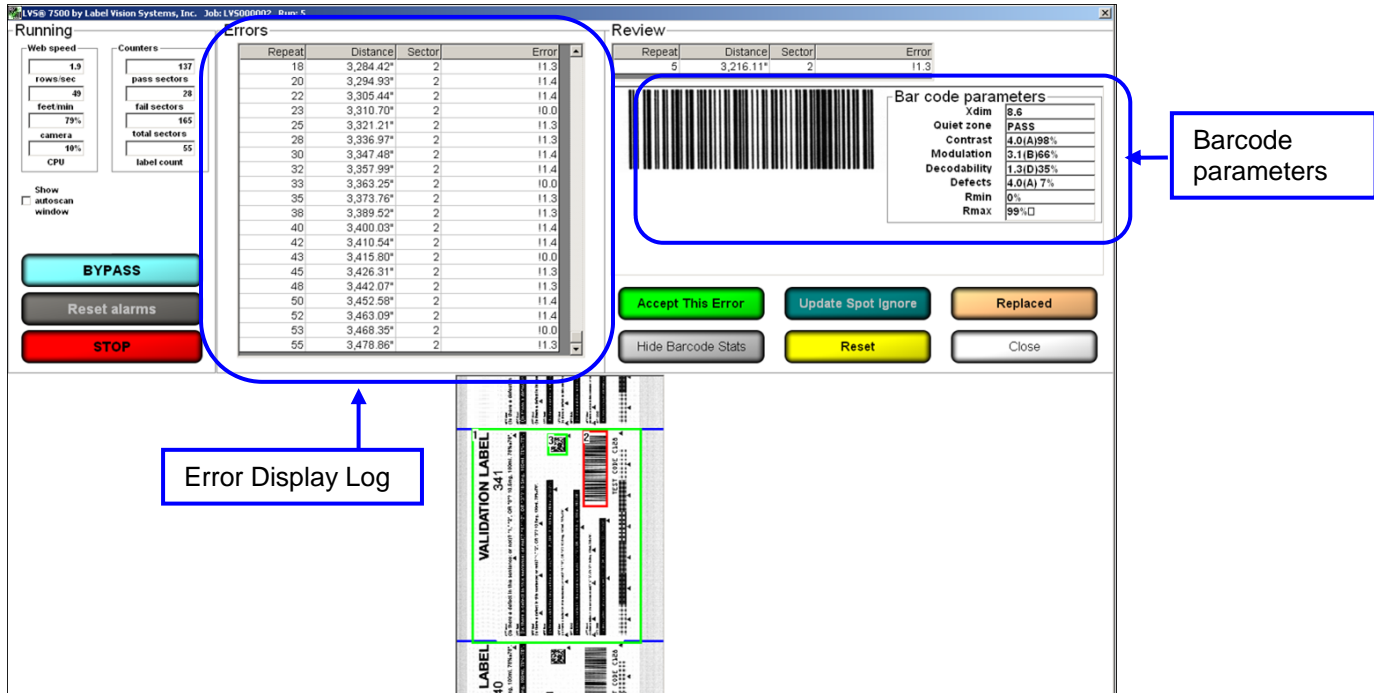

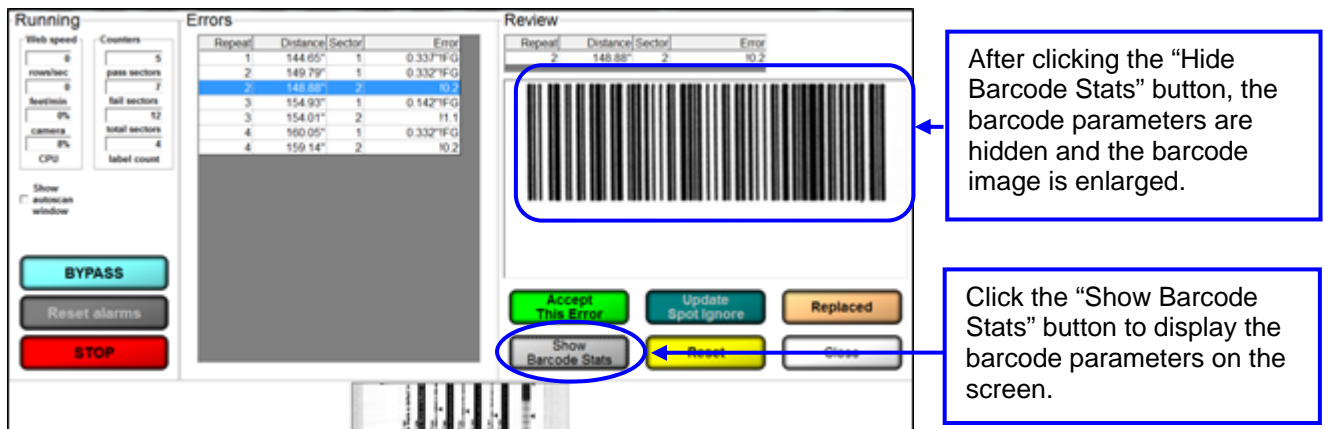

To hide the barcode parameters, click the "Hide Barcode Stats" button; this removes the barcode parameters from the screen and enlarges the barcode image.

Note: After clicking the "Hide Barcode Stats" button, the name changes to "Show Barcode Stats." Click this button to display the barcode parameters on the screen.

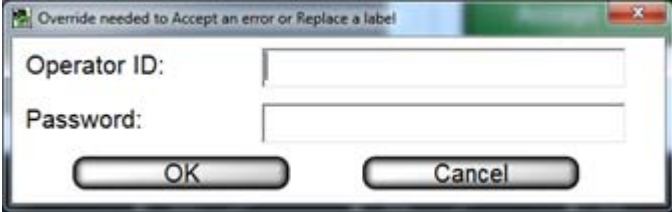

Additional error display options include:

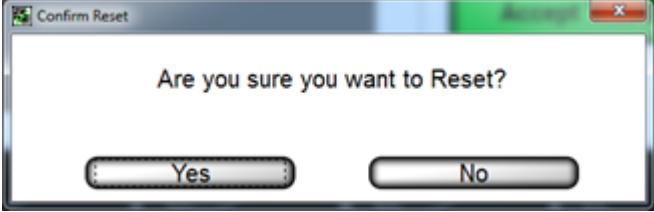
Button	Description
<p>Accept This Error</p>	<p>Click this button to approve the error; the error is marked as OK in the error log file and removed from the errors list. The button is active when the job is in run mode. Only operators granted the Allow Accept / Replace Errors permission are allowed to accept the error. The following message appears for operators without permission to accept the error (see screenshot below). An authorized Operator ID and Password must be entered or the operator will not be allowed to approve the error. For more information on permissions, refer to: Welcome Screen Overview → Administration → Operators → Manage Operator Permissions within the LVS-7510 software.</p> 
<p>Update Spot Ignore</p>	<p>Draws an ignore box around the error so that it will not appear again and every instance of the error will be removed from the errors list. The log file will also show an OK for every instance of this error.</p> <p>The ignore area is yellow if you edit the blemish sector.</p> <p>In the “Settings” menu, when RelearnAuthorization=0, any operator granted the “Allow Accept/Replace Errors” permission can use this feature.</p> <p>When RelearnAuthorization=1, the operator must have “Allow Administration” rights to use this feature.</p> <p>The following message appears for operators without permission to use the “Update Spot Ignore” feature (see screenshot below). An administrator’s Operator ID and Password must be entered or the operator will not be allowed to ignore the areas. For more information on permissions, refer to: Welcome Screen Overview → Administration → Operators → Manage Operator Permissions within the LVS-7510 software.</p> 
<p>Reset</p>	<p>Places previously accepted and replaced errors back into the errors list and restores their original error codes in the log file. This feature also removes all spot ignore updates. The button is active when the job is in run mode.</p> <p>After clicking the “Reset” button, the following message appears. Click Yes to reset or No to cancel.</p> 

Button	Description
Hide Barcode Stats	<p>Click this button to hide the barcode parameters on the screen and enlarge the barcode image.</p> <p>After clicking this button, the button name changes to “Show Barcode Stats.” Click this button for the barcode parameters to appear on the screen.</p> <p>The settings for this button are controlled in the “Settings” menu > [System] section > ShowRuntimeGradeStats.</p> <ul style="list-style-type: none"> • ShowRuntimeGradeStats=0 (default) – Disables the “Hide Barcode Stats” button. • ShowRuntimeGradeStats=1 – Enables the “Hide Barcode Stats” button.
Close	<p>Click the “Close” button to close the error display window and return to the “Running the Job” screen.</p>

Blemish Error Display

When viewing a blemish error, three views are available on the screen:

- **Golden** – Displays the golden image
- **Toggle** – Toggles between the golden image and actual image
- **Actual** – Displays the actual blemish image

Only a single image of the error is displayed when viewing other types of errors. For example, a No Read error on a barcode would only show an image of the barcode so that you can examine the problem.

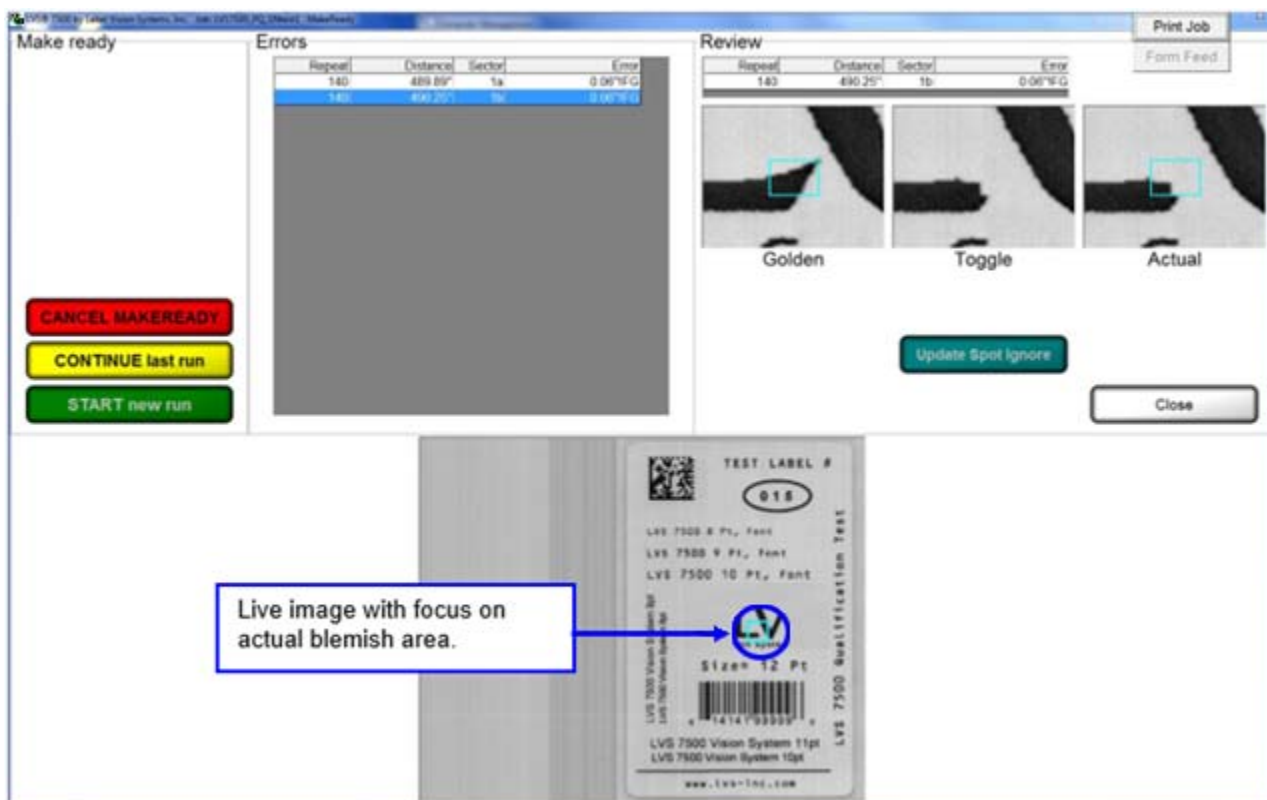

Reports / QC File Viewer

The Reports Screen is used to view the report logs created for each job.

Each line of data starts with the run number followed by a date/time stamp, decoded string, error code (if any), and other data associated with the image being inspected. For a full list of error codes, see: Step 6: Alarm Matrix → Error Code Definitions on page 76.

Run number	Date and time	Run log	Errors only	1D grading	DM grading
2	30-May-2017 15:18:13	9,796	256	31,629	15,174

The report type is displayed in the column header (such as Errors only, 1D grade details, etc.). To view a particular report, click on the desired run located under the corresponding header.

The “Run log” column allows you to view data for all sectors for that particular run. All ANSI/ISO parameters are reported under 1D, 2D grade details.

The data is stored in a .csv (comma separated values) format. This format is a text file where fields are delimited by commas and records are delimited by a <CR><LF> pair. By default these files are stored in the following directories:

- For installations of software version 20.2.X on Windows® 7 Professional and Windows® 8.1 Professional operating systems: C:\LvsData\LVS 7500\Production\Jobs
- Jobs created in earlier versions of the software are not supported. Manually backup any desired data and manually delete the C:\Users\[User Login Name]\AppData\Roaming\Label Vision Systems\LVS 7500. Then, install software release 20.2.X as a new installation.

The operator may choose to print a report for an entire run or print a report of errors only.

Sample Reports

Errors Only Report

Previous error		Repeat	Time	Distance	Sector 1	Sector 2	Sector 3	Sector 4	Sector 5	Sector 6	Sector 7	Sector 8
Next error		10	30-Mar-2012 16:02:47	47.84"	0"	0.234"-OK	2.238"-OK	0.3	0.5	0.9	300780438155	300780438155
Previous warning		11	30-Mar-2012 16:02:47	55.02"	0.078"-OK	0"	0"	0.5	1.0	1.7	300780438155	300780438155
Next warning		16	30-Mar-2012 16:02:48	77.13"	0"	0"-OK 66"-OK	0.9	1.7	2.2	300780438155	300780438155	300780438155
Summary report		17	30-Mar-2012 16:02:48	81.52"	0"	0.004"	2.238"UN	0.3	0.3	0.1	300780438155	300780438155
Print errors		18	30-Mar-2012 16:02:48	85.95"	0"	0.176"IBG	2.238"IBG	0.1	0.5	1.2	300780438155	300780438155
Print all		19	30-Mar-2012 16:02:49	93.13"	0.07"IBG	0"	0"	0.8	1.3	1.8	300780438155	300780438155
Exit		24	30-Mar-2012 16:02:50	115.22"	0"	0.074"IBG	2.238"IFG	0.8	1.6	2.0	300780438155	300780438155
Key		25	30-Mar-2012 16:02:50	119.63"	0"	0"	2.238"IBG	0.1	0.3	0.3	300780438155	300780438155
Sector error		26	30-Mar-2012 16:02:50	124.04"	0"	0.031"IBG	2.238"IBG	0.2	0.6	0.6	300780438155	300780438155
Sector warning		27	30-Mar-2012 16:02:59	131.23"	0"	0"	0"	0.0IDE	0.0IDE	0.0IDE	300780438155	300780438155
Splice requested		28	30-Mar-2012 16:03:00	135.66"	0.039"IFG	0"	0"	1.7	1.4	0.8	300780438155	300780438155
Splice performed		29	30-Mar-2012 16:03:00	140.09"	0.137"IFG	0"	0"	1.1	0.6	0.3	300780438155	300780438155
Replaced		30	30-Mar-2012 16:03:00	144.51"	0.031"IFG	0"	0"	0.6	0.5	0.6	300780438155	300780438155
		31	30-Mar-2012 16:03:00	148.93"	0.043"IFG	0"	0"	0.8	0.1	1.1	300780438155	300780438155
		32	30-Mar-2012 16:03:00	153.33"	0.059"IFG	0"	0.246"IFG	0.2	0.3	0.5	300780438155	300780438155
		33	30-Mar-2012 16:03:00	157.73"	0.023"IFG	0"	0.438"IBG	0.7	1.6	1.7	300780438155	300780438155
		34	30-Mar-2012 16:03:00	162.15"	0.055"IFG	0.141"IBG	2.242"IFG	0.5	0.9	1.2	300780438155	300780438155
		36	30-Mar-2012 16:03:01	173.76"	0.051"IFG	0"	0"	1.7	1.4	0.8	300780438155	300780438155
		37	30-Mar-2012 16:03:01	178.19"	0.074"IFG	0"	0"	1.2	0.6	0.3	300780438155	300780438155
		38	30-Mar-2012 16:03:01	182.61"	0.027"IFG	0"	0"	0.5	0.4	0.7	300780438155	300780438155
		39	30-Mar-2012 16:03:01	187.04"	0.051"IFG	0"	0"	0.8	0.2	1.1	300780438155	300780438155
		40	30-Mar-2012 16:03:02	191.43"	0.055"IFG	0"	0.344"IBG	0.5	0.2	0.5	300780438155	300780438155
		41	30-Mar-2012 16:03:02	195.83"	0.027"IFG	0"	2.242"IFG	0.6	1.6	2.0	300780438155	300780438155
		42	30-Mar-2012 16:03:02	200.25"	0.047"IFG	0.141"IBG	2.242"IFG	0.5	0.9	1.1	300780438155	300780438155
		44	30-Mar-2012 16:03:02	211.86"	0.035"IFG	0"	0"	1.7	1.2	0.8	300780438155	300780438155
		45	30-Mar-2012 16:03:03	216.29"	0.098"IFG	0"	0"	0.9	0.6	0.3	300780438155	300780438155
		46	30-Mar-2012 16:03:03	220.71"	0.023"IFG	0"	0"	0.6	0.5	0.6	300780438155	300780438155
		47	30-Mar-2012 16:03:03	225.14"	0.055"IFG	0"	0"	0.9	0.1	0.8	300780438155	300780438155
		48	30-Mar-2012 16:03:03	229.54"	0.047"IFG	0"	0.145"IBG	0.2	0.3	0.3	300780438155	300780438155
		49	30-Mar-2012 16:03:04	233.93"	0.039"IFG	0"	2.242"IFG	0.3	1.3	1.7	300780438155	300780438155
		50	30-Mar-2012 16:03:04	238.35"	0.039"IFG	0.078"IBG	2.242"IFG	0.5	0.8	0.8	300780438155	300780438155
		52	30-Mar-2012 16:03:05	249.96"	0"	0"	0"	0.0IDE	0.0IDE	0.0IDE	300780438155	300780438155
		57	30-Mar-2012 16:03:06	272.03"	0"	0"	2.238"IBG	1.5	0.5	0.9	300780438155	300780438155
		58	30-Mar-2012 16:03:06	276.45"	0"	0"	2.238"IBG	1.1	0.4	0.0	300780438155	300780438155
		59	30-Mar-2012 16:03:06	283.63"	0.082"IBG	0"	0"	1.8	0.9	0.8	300780438155	300780438155
		65	30-Mar-2012 16:03:07	310.13"	0"	0.004"	0.309"IFG	1.5	0.4	0.8	300780438155	300780438155
		66	30-Mar-2012 16:03:07	314.55"	0"	0.555"IBG	2.238"IBG	1.3	0.5	1.3	300780438155	300780438155
		67	30-Mar-2012 16:03:07	321.73"	0.086"IBG	0"	0"	1.7	0.8	0.5	300780438155	300780438155
		73	30-Mar-2012 16:03:09	348.23"	0"	0"	0.309"IFG	1.2	0.3	1.1	300780438155	300780438155
		74	30-Mar-2012 16:03:09	352.65"	0"	0.484"IBG	2.238"IBG	1.1	0.4	1.9	300780438155	300780438155
		75	30-Mar-2012 16:03:09	359.84"	0.07"IBG	0"	0"	1.7	1.0	0.8	300780438155	300780438155

Run Log

Repeat	Time	Distance	Sector 1	Sector 2	Sector 3	Sector 4	Sector 5	Sector 6	Sector 7
37	30-Mar-2012 16:03:01	178.19"	0.074"IFG	0"	0"	1.2	0.6	0.3	300780438155
38	30-Mar-2012 16:03:01	182.61"	0.027"IFG	0"	0"	0.5	0.4	0.7	300780438155
39	30-Mar-2012 16:03:01	187.04"	0.051"IFG	0"	0"	0.8	0.2	1.1	300780438155
40	30-Mar-2012 16:03:02	191.43"	0.055"IFG	0"	0.344"IBG	0.5	0.2	0.5	300780438155
41	30-Mar-2012 16:03:02	195.83"	0.027"IFG	0"	2.242"IFG	0.6	1.6	2.0	300780438155
42	30-Mar-2012 16:03:02	200.25"	0.047"IFG	0.141"IBG	2.242"IFG	0.5	0.9	1.1	300780438155
43	30-Mar-2012 16:03:02	207.43"	0"	0"	0"	0.1	0.4	0.4	300780438155
44	30-Mar-2012 16:03:02	211.86"	0.035"IFG	0"	0"	1.7	1.2	0.8	300780438155
45	30-Mar-2012 16:03:03	216.29"	0.098"IFG	0"	0"	0.9	0.6	0.3	300780438155
46	30-Mar-2012 16:03:03	220.71"	0.023"IFG	0"	0"	0.6	0.5	0.6	300780438155
47	30-Mar-2012 16:03:03	225.14"	0.055"IFG	0"	0"	0.9	0.1	0.8	300780438155
48	30-Mar-2012 16:03:03	229.54"	0.047"IFG	0"	0.145"IBG	0.2	0.3	0.3	300780438155
49	30-Mar-2012 16:03:04	233.93"	0.039"IFG	0"	2.242"IFG	0.3	1.3	1.7	300780438155
50	30-Mar-2012 16:03:04	238.35"	0.039"IFG	0.078"IBG	2.242"IFG	0.5	0.8	0.8	300780438155
51	30-Mar-2012 16:03:04	245.53"	0"	0"	0"	0.0	0.4	0.1	300780438155
52	30-Mar-2012 16:03:05	249.96"	0"	0"	0"	0.0IDE	0.0IDE	0.0IDE	300780438155
53	30-Mar-2012 16:03:05	254.39"	0"	0"	0"	0.6	0.8	1.1	300780438155
54	30-Mar-2012 16:03:05	258.82"	0"	0"	0"	1.3	0.6	1.4	300780438155
55	30-Mar-2012 16:03:05	263.24"	0"	0"	0"	1.0	1.2	0.3	300780438155
56	30-Mar-2012 16:03:05	267.64"	0"	0"	0"	1.9	1.5	1.0	300780438155
57	30-Mar-2012 16:03:06	272.03"	0"	0"	2.238"IBG	1.5	0.5	0.9	300780438155
58	30-Mar-2012 16:03:06	276.45"	0"	0"	2.238"IBG	1.1	0.4	0.0	300780438155
59	30-Mar-2012 16:03:06	283.63"	0.082"IBG	0"	0"	1.8	0.9	0.8	300780438155
60	30-Mar-2012 16:03:06	288.06"	0"	0"	0"	0.4	0.3	0.3	300780438155
61	30-Mar-2012 16:03:06	292.49"	0"	0"	0"	0.9	0.8	1.1	300780438155
62	30-Mar-2012 16:03:06	296.92"	0"	0"	0"	1.3	0.6	1.1	300780438155
63	30-Mar-2012 16:03:07	301.34"	0"	0"	0"	0.9	1.2	0.3	300780438155
64	30-Mar-2012 16:03:07	305.74"	0"	0"	0"	1.9	1.5	1.0	300780438155
65	30-Mar-2012 16:03:07	310.13"	0"	0.004"	0.309"IFG	1.5	0.4	0.8	300780438155
66	30-Mar-2012 16:03:07	314.55"	0"	0.555"IBG	2.238"IBG	1.3	0.5	1.3	300780438155
67	30-Mar-2012 16:03:07	321.73"	0.086"IBG	0"	0"	1.7	0.8	0.5	300780438155
68	30-Mar-2012 16:03:08	326.16"	0"	0"	0"	0.4	0.4	0.3	300780438155
69	30-Mar-2012 16:03:08	330.59"	0"	0"	0"	0.8	0.8	1.3	300780438155
70	30-Mar-2012 16:03:08	335.02"	0"	0"	0"	1.3	0.9	1.5	300780438155
71	30-Mar-2012 16:03:08	339.43"	0"	0"	0"	0.9	1.2	0.3	300780438155
72	30-Mar-2012 16:03:09	343.84"	0"	0"	0"	1.9	1.4	1.0	300780438155
73	30-Mar-2012 16:03:09	348.23"	0"	0"	0.309"IFG	1.2	0.3	1.1	300780438155
74	30-Mar-2012 16:03:09	352.65"	0"	0.484"IBG	2.238"IBG	1.1	0.4	1.9	300780438155
75	30-Mar-2012 16:03:09	359.84"	0.07"IBG	0"	0"	1.7	1.0	0.8	300780438155
76	30-Mar-2012 16:03:09	364.27"	0"	0"	0"	0.3	0.3	0.1	300780438155
77	30-Mar-2012 16:03:10	368.70"	0"	0"	0"	0.6	0.8	1.1	300780438155

Previous error

Next error

Previous warning

Next warning

Summary report

Print errors

Print all

Exit

Key

Sector error
Sector warning
Splice requested
Splice performed
Replaced

1D Grade Details

View 1D grade details by double-clicking on a job in the 1D grading column.

Repeat	Time	Distance	Sector ID	DecodedText	Overall	Symbology	Xdim	EdgeDeterm	MinReflect	MinEC	QuietZone	Contrast	Modulation	Decodability	Defec
1	02-Apr-2012 11:01:04	2.81"	1	300780438155	3.5/06/660 (A)	UPC-A	8.5	PASS	PASS	PASS	PASS	3.5(A)71%	4.0(A)90%	4.0(A)68%	4.0(A)
2	02-Apr-2012 11:01:05	6.98"	1	300780438155	3.6/06/660 (A)	UPC-A	8.6	PASS	PASS	PASS	PASS	3.6(A)72%	4.0(A)95%	4.0(A)71%	4.0(A)
3	02-Apr-2012 11:01:05	11.34"	1	300780438155	3.6/06/660 (A)	UPC-A	8.6	PASS	PASS	PASS	PASS	3.6(A)72%	4.0(A)89%	4.0(A)70%	4.0(A)
4	02-Apr-2012 11:01:05	15.72"	1		NR										
5	02-Apr-2012 11:01:05	20.07"	1	300780438155	3.5/06/660 (A)	UPC-A	8.6	PASS	PASS	PASS	PASS	3.5(A)71%	4.0(A)95%	4.0(A)70%	4.0(A)
6	02-Apr-2012 11:01:06	24.44"	1	300780438155	3.5/06/660 (A)	UPC-A	8.6	PASS	PASS	PASS	PASS	3.5(A)71%	4.0(A)91%	4.0(A)70%	4.0(A)
7	02-Apr-2012 11:01:06	28.81"	1	300780438155	3.6/06/660 (A)	UPC-A	8.6	PASS	PASS	PASS	PASS	3.6(A)72%	4.0(A)91%	3.6(A)64%	4.0(A)
8	02-Apr-2012 11:01:07	33.15"	1	300780438155	3.6/06/660 (A)	UPC-A	8.6	PASS	PASS	PASS	PASS	3.6(A)72%	4.0(A)93%	4.0(A)73%	4.0(A)
9	02-Apr-2012 11:01:07	37.52"	1	300780438155	3.6/06/660 (A)	UPC-A	8.6	PASS	PASS	PASS	PASS	3.6(A)71%	4.0(A)90%	4.0(A)68%	4.0(A)
10	02-Apr-2012 11:01:08	41.89"	1	300780438155	3.6/06/660 (A)	UPC-A	8.6	PASS	PASS	PASS	PASS	3.6(A)72%	4.0(A)95%	4.0(A)71%	4.0(A)
11	02-Apr-2012 11:01:08	46.25"	1	300780438155	3.6/06/660 (A)	UPC-A	8.6	PASS	PASS	PASS	PASS	3.6(A)72%	4.0(A)89%	4.0(A)70%	4.0(A)
12	02-Apr-2012 11:01:08	50.63"	1		NR										
13	02-Apr-2012 11:01:09	54.98"	1	300780438155	3.5/06/660 (A)	UPC-A	8.6	PASS	PASS	PASS	PASS	3.5(A)71%	4.0(A)95%	4.0(A)70%	4.0(A)

Previous error

Next error

Previous warning

Next warning

Summary report

Print errors

Print all

Exit

Key

- Sector error
- Sector warning
- Splice requested
- Splice performed
- Replaced

Run Log with Images

Blemish, barcode, and OCR/OCV error images can be viewed by double clicking on the red blemish cell in the log file. An error display screen will then appear. If the error is a blemish, the Golden Image will show on the Left; a Toggle between Golden and Actual in the center; and the Actual Blemish image is on the right.

Toggle screens of Golden as compared to the actual.

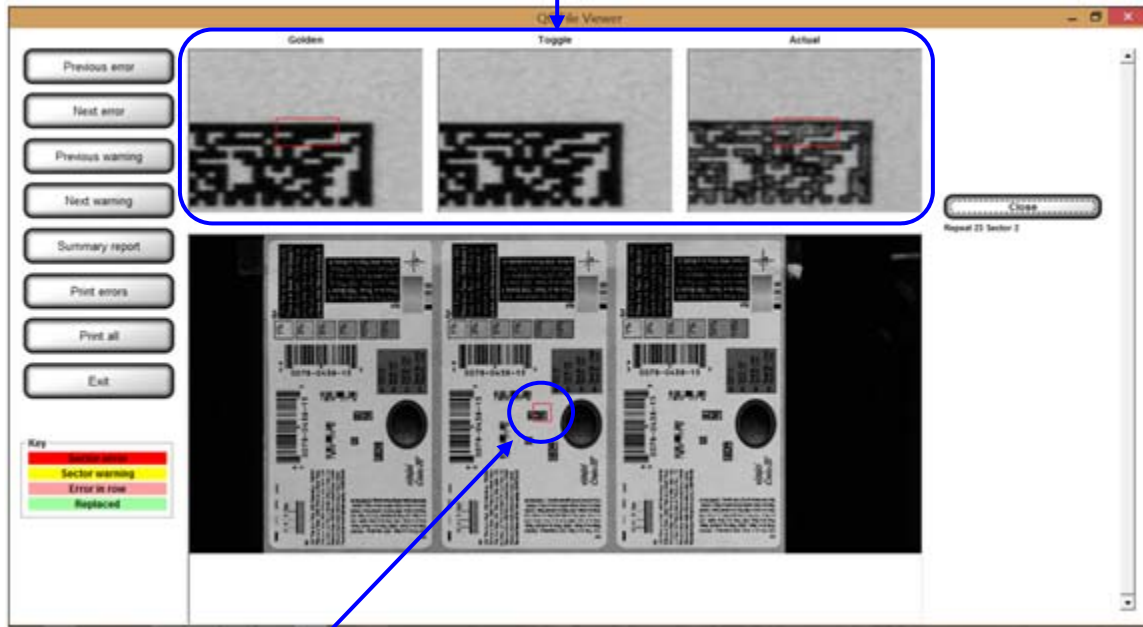

Blemish location on label

Button Definitions:

Button	Description
Previous Error	Moves upward from the current file location to the next error.
Next Error	Moves downward from the current file location to the next error.
Previous Warning	Moves upward from the current file location to the next warning.
Next Warning	Moves downward from the current file location to the next warning.
Summary Report	Click to view the Summary Report.
Print errors	Click to print the errors only.
Print All	Click to print all information for the run.
Exit	Click to close the QC File Viewer and return to the LVS-7510.

Summary Report

The LVS-7510 Summary Report can be accessed by clicking on the “Summary Report” button when viewing a log file. The LVS-7510 Summary Report gives a summation of the entire job and each sector’s settings and parameters. The report also shows example images where sectors were drawn. See a sample LVS-7510 Summary Report below.

The LVS-7510 Summary Report appears when configured for HTML only in Internet Explorer, Firefox or Chrome web browsers; no other web browser is supported. Alternately, the Summary Report can be configured to create a .pdf report.

LVS 7510 Summary Report

30-May-2017 15:18:13

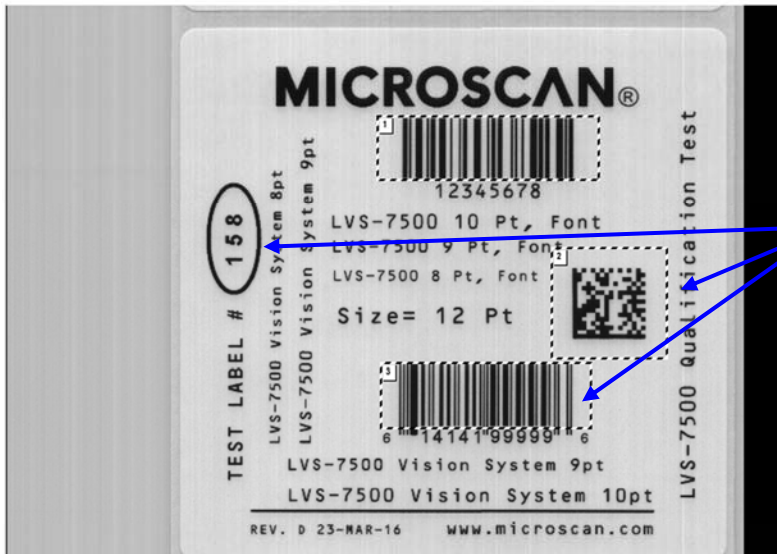

A detailed analysis of each sector is displayed in the following report sections.

Job name	May 31
Run number	2
Operator	Admin (Administrator)
Start time	30-May-2017 15:17:29
End time	30-May-2017 15:18:13
Start repeat	1
End repeat	108
Repeats inspected	108
Repeats replaced	0

Displays the job name, operator, and date and time when the job began and ended.



Sector1	Bar code 1D grade
Minimum passing score	1.5
okay	108 / 108 = 100%
DecodedText	12345678
Overall	B:108 (100%)
Symbology	Code 128
Xdim	15.8 to 15.9; average was 15.8
EdgeDeterm	108 / 108 = 100% PASS
MinReflect	108 / 108 = 100% PASS
MinEC	108 / 108 = 100% PASS
QuietZone	108 / 108 = 100% PASS
Contrast	A:108 (100%)
Modulation	A:108 (100%)
Decodability	B:108 (100%)
Defects	A:108 (100%)
Rmin	2% to 4%; average was 3
Rmax	86% to 88%; average was 87

Detailed analysis is provided for each sector on the label. This example shows the barcode grade sector and summary results.

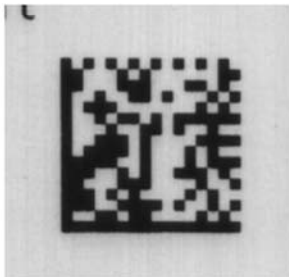

Sector2	Bar code 2D grade
Minimum passing score	1.5
okay	108 / 108 = 100%
DecodedText	LVS INTEGRA 7500
Overall	A:107 (99%), C:1 (1%)
Symbology	Data Matrix
Xdim	32.7 to 33.2; average was 33
Contrast	A:108 (100%)
Modulation	A:107 (99%), C:1 (1%)
AxisNonUniform	A:108 (100%)
GridNonUniform	A:108 (100%)
UnusedEC	A:107 (99%), C:1 (1%)
FixedPat	A:108 (100%)

Operator Log:

03-Sep-2015 11:14:12 to 03-Sep-2015 11:15:15: Admin (Administrator) Run 4 stopped -- printed 19 labels with 0 reprints

Preventive Maintenance

Sensor Instructions

Weekly cleaning of the sensor is recommended to maintain optimum performance. To maintain a clean and clear appearance, spray a soft, lint-free, non-abrasive towel or cloth with a commercially available household glass cleaner, such as Windex®, Glassex®, VISS®, and Mr. Muscle® and gently clean the outside of the sensor glass.

DO NOT directly spray the sensor glass with glass cleaner; always spray a towel or cloth with glass cleaner and then gently wipe the sensor glass.

DO NOT use an industrial-strength glass cleaner.

Calibration Card Instructions

Replace the Calibrated Conformance Standard Test Card every two years.

If you have any questions or concerns about the performance of the LVS-7510, please call Omron Microscan or your Omron Microscan distributor.

Troubleshooting

Problem Description	Possible Causes
System will not acquire images	<ul style="list-style-type: none"> • The readhead has lost power. • The readhead to LVS-7510 interface cables are not plugged in or are damaged.
System is acquiring every other label	The label repeat is set too large.
Image has uneven lighting	<ul style="list-style-type: none"> • An LED may have burned out in the sensor. • The sensor may have a label stuck to it

Mechanical Diagrams

All technical drawings are copyrighted in respect to their manufacturer. All respected trademark rights are reserved.

LVS-7510 Basic Wire Diagram

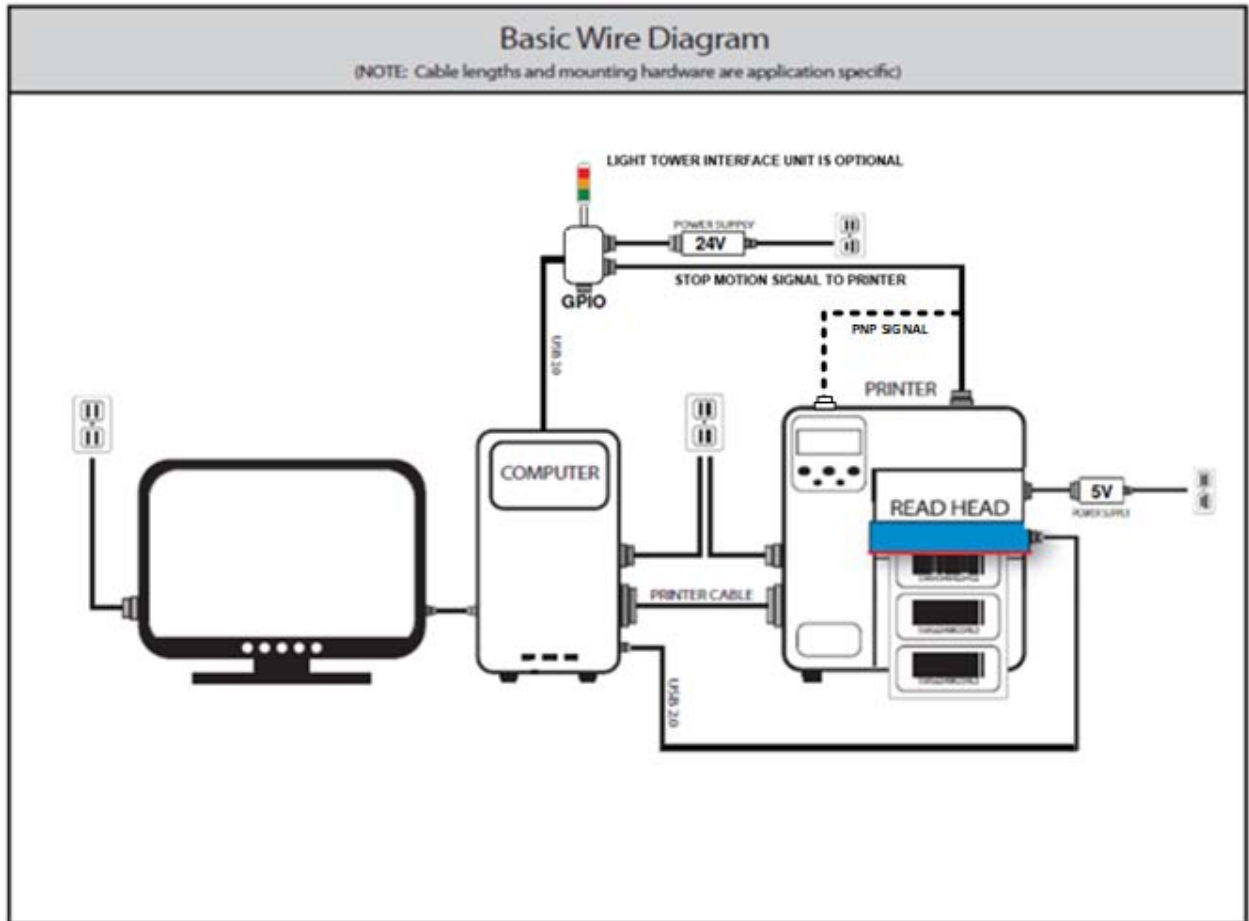

Appendix A: User Configurable Settings

Settings Configuration Editor

The LVS-7510 software is configurable through options that are user configurable. The “Settings” menu bar feature opens the LVS-7510 Configuration Editor which allows you to configure the basic and advanced features and functionality of the LVS-7510. A user must be assigned administrator rights to access the “Settings” menu bar. Refer to the “List of User Configurable Settings” section below for a description of the available settings and options.

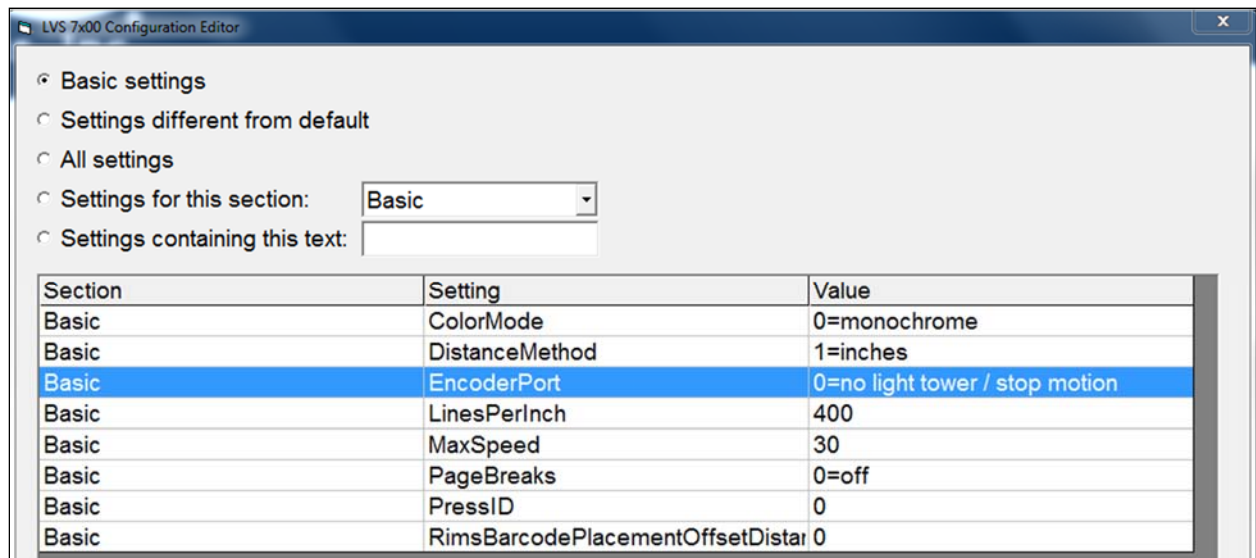
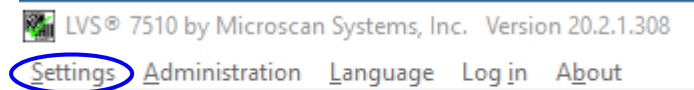

The LVS-7510 Configuration Editor offers the following options:

Option	Description
Basic settings	Select this option to display the settings considered to be basic to LVS-7510 configuration.
Settings different from default	Select this option to display any values that have been modified to a value other than the default value.
All settings	Select this option to display all settings listed alphabetically by “Section.”
Settings for this section	Click the drop-down box to display all settings for the selected section.
Settings containing this text	Enter a text string to search for settings containing the entered text. For example, typing “camera” in the text field will display all settings containing the word “camera.”

Each setting is grouped by “Section,” “Setting,” and “Value” (see screenshot below).

Double-click a setting row. The “LVS-7510 Configuration Editor Individual Setting” window appears providing the Section, Setting, Default, Value, and Setting Description.

The only editable field is the “Value” field. All other fields cannot be edited.

Click “OK (save changes)” to save your changes or “Cancel (discard changes)” to discard any changes.

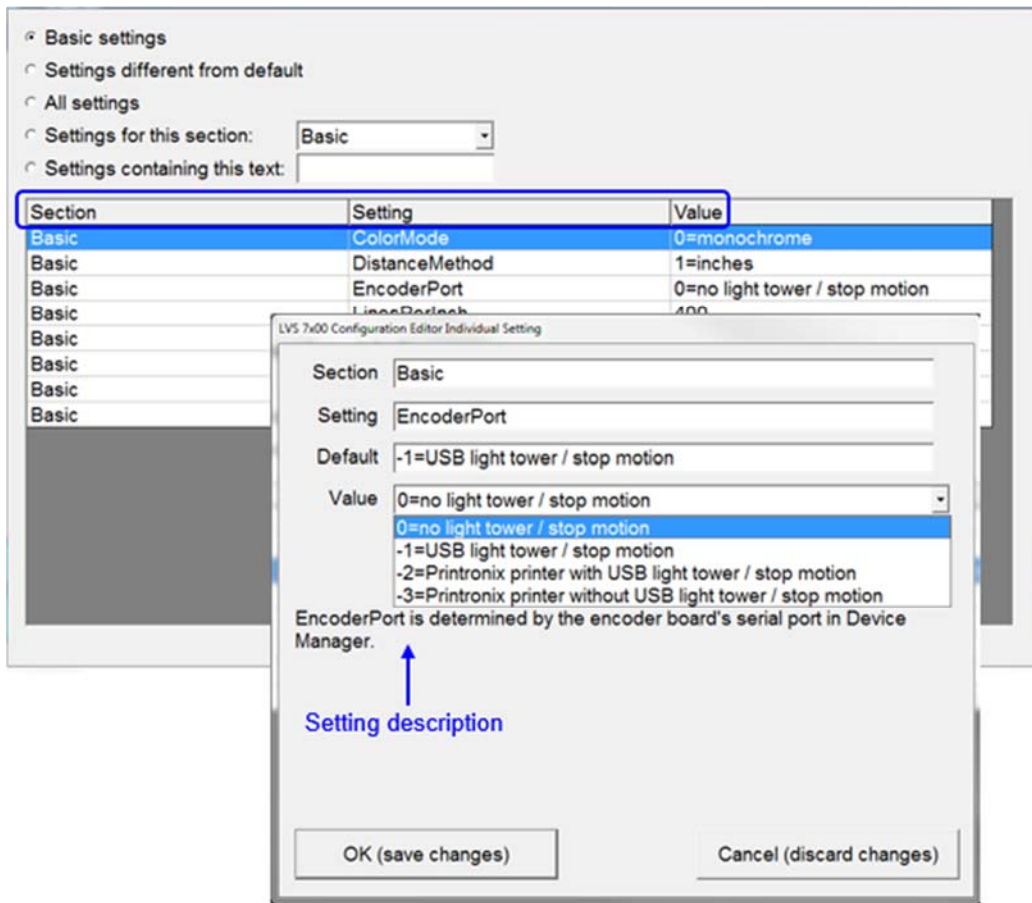

List of User Configurable Settings

Active Directory

Setting: ActiveDirectoryAuthentication Options: 0=off 1=ON Default: 0=off	When ActiveDirectoryAuthentication is enabled the LVS-7510 software will attempt to use Microsoft Server Active Directory for User Administration.
Setting: ActiveDirectoryDomain Options: Text string Default: None	Microsoft Server Active Directory Domain name. Example: your-company.com.
Setting: ActiveDirectoryLVSAAllowAbort Options: Text string Default: None	When ActiveDirectoryAuthentication is enabled, this is the Active Directory group that gives LVS-7510 users the Allow Abort permission.
Setting: ActiveDirectoryLVSAAllowAcceptReplace Options: Text string Default: None	When ActiveDirectoryAuthentication is enabled, this is the Active Directory group that gives LVS-7510 users the Allow Accept Replace permission.
Setting: ActiveDirectoryLVSAAllowAdministration Options: Text string Default: None	When ActiveDirectoryAuthentication is enabled, this is the Active Directory group that gives LVS-7510 users the Allow Administration permission.
Setting: ActiveDirectoryLVSAAllowBypassMakeReady Options: Text string Default: None	When ActiveDirectoryAuthentication is enabled, this is the Active Directory group that gives LVS-7510 users the Allow Bypass MakeReady permission.
Setting: ActiveDirectoryLVSAAllowCalibration Options: Text string Default: None	When ActiveDirectoryAuthentication is enabled, this is the Active Directory group that gives LVS-7510 users the Allow Calibration permission.
Setting: ActiveDirectoryLVSAAllowCreateEdit Options: Text string Default: None	When ActiveDirectoryAuthentication is enabled, this is the Active Directory group that gives LVS-7510 users the Allow Create Edit permission.
Setting: ActiveDirectoryLVSAAllowIgnore Options: Text string Default: None	When ActiveDirectoryAuthentication is enabled, this is the Active Directory group that gives LVS-7510 users the Allow Ignore permission.
Setting: ActiveDirectoryLVSAAllowLoadExisting Options: Text string Default: None	When ActiveDirectoryAuthentication is enabled, this is the Active Directory group that gives LVS-7510 users the Allow Load Existing permission.
Setting: ActiveDirectoryLVSAAllowResetPrinter Options: Text string Default: None	When ActiveDirectoryAuthentication is enabled, this is the Active Directory group that gives LVS-7510 users the Allow Reset Printer permission.

Setting: ActiveDirectoryLVSAIUsers Options: Text string Default: None	When ActiveDirectoryAuthentication is enabled, this is the Active Directory group that contains the list of all Active Directory users that will be integrated into the Omron Microscan Operator permissions.
Setting: ActiveDirectoryLVSOrgUnit Options: Text string Default: None	When ActiveDirectoryAuthentication is enabled, this is the Active Directory Organizational Unit that contains Active Directory Groups that control access to the LVS-7510 system.

Background - !BG

Setting: Signal Duration Options: 10ms, 20ms, 100ms, 200ms, 500ms, 1 second, 5 seconds, hold Default: 100ms	Specifies the signal duration.
Setting: Signal Output Line Options: I/O line 1 I/O line 2 I/O line 3 I/O line 4 Default: I/O line 3	Sets the I/O line to activate for this error condition. The default value is I/O line 3, which corresponds to the red light.
Setting: StopMotion Options: do not stop immediately after 2 in a row after 3 in a row after 4 in a row after 5 in a row after 6 in a row after 7 in a row after 8 in a row after 9 in a row after 10 in a row Default: immediately	Specifies if this error condition should also trigger activation of the stop motion signal.

Checkdigit - !CD

Setting: Signal Duration Options: 10ms 20ms 100ms 200ms 500ms 1 second 5 seconds hold Default: 100ms	Specifies the signal duration.
---	--------------------------------

<p>Setting: Signal Output Line Options: I/O line 1 I/O line 2 I/O line 3 I/O line 4 Default: I/O line 3</p>	<p>Sets the I/O line to activate for this error condition. The default value is I/O line 3, which corresponds to the red light.</p>
<p>Setting: StopMotion Options: do not stop immediately after 2 in a row after 3 in a row after 4 in a row after 5 in a row after 6 in a row after 7 in a row after 8 in a row after 9 in a row after 10 in a row Default: immediately</p>	<p>Specifies if this error condition should also trigger activation of the stop motion signal.</p>

Die Cut) - IDC

<p>Setting: Signal Duration Options: 10ms 20ms 100ms 200ms 500ms 1 second 5 seconds hold Default: 100ms</p>	<p>Specifies the signal duration.</p>
<p>Setting: Signal Output Line Options: I/O line 1 I/O line 2 I/O line 3 I/O line 4 Default: I/O line 3</p>	<p>Sets the I/O line to activate for this error condition. The default value is I/O line 3, which corresponds to the red light.</p>
<p>Setting: StopMotion Options: do not stop immediately after 2 in a row after 3 in a row after 4 in a row after 5 in a row after 6 in a row after 7 in a row after 8 in a row after 9 in a row after 10 in a row Default: immediately</p>	<p>Specifies if this error condition should also trigger activation of the stop motion signal.</p>

Alarm (Duplicate)

Setting: Signal Duration Options: 10ms 20ms 100ms 200ms 500ms 1 second 5 seconds hold Default: 100ms	Specifies the signal duration.
Setting: Signal Output Line Options: I/O line 1 I/O line 2 I/O line 3 I/O line 4 Default: I/O line 3	Sets the I/O line to activate for this error condition. The default value is I/O line 3, which corresponds to the red light.
Setting: StopMotion Options: do not stop immediately after 2 in a row after 3 in a row after 4 in a row after 5 in a row after 6 in a row after 7 in a row after 8 in a row after 9 in a row after 10 in a row Default: immediately	Specifies if this error condition should also trigger activation of the stop motion signal.

Alarm (Foreground)

Setting: Signal Duration Options: 10ms 20ms 100ms 200ms 500ms 1 second 5 seconds hold Default: 100ms	Specifies the signal duration.
Setting: Signal Output Line Options: I/O line 1 I/O line 2 I/O line 3 I/O line 4 Default: I/O line 3	Sets the I/O line to activate for this error condition. The default value is I/O line 3, which corresponds to the red light.

<p>Setting: StopMotion Options: do not stop immediately after 2 in a row after 3 in a row after 4 in a row after 5 in a row after 6 in a row after 7 in a row after 8 in a row after 9 in a row after 10 in a row Default: immediately</p>	<p>Specifies if this error condition should also trigger activation of the stop motion signal.</p>
---	--

Alarm (Gap)

<p>Setting: Signal Duration Options: 10ms 20ms 100ms 200ms 500ms 1 second 5 seconds hold Default: 100ms</p>	<p>This specifies the signal duration.</p>
<p>Setting: Signal Output Line Options: I/O line 1 I/O line 2 I/O line 3 I/O line 4 Default: I/O line 3</p>	<p>This sets the I/O line to activate for this error condition. The default value is I/O line 3, which corresponds to the red light.</p>
<p>Setting: StopMotion Options: do not stop immediately after 2 in a row after 3 in a row after 4 in a row after 5 in a row after 6 in a row after 7 in a row after 8 in a row after 9 in a row after 10 in a row Default: immediately</p>	<p>This specifies if this error condition should also trigger activation of the stop motion signal.</p>

Alarm (Good Read)

<p>Setting: Signal Duration Options: 10ms 20ms 100ms 200ms 500ms 1 second 5 seconds hold Default: 100ms</p>	<p>This specifies the signal duration.</p>
<p>Setting: Signal Output Line Options: I/O line 1 I/O line 2 I/O line 3 I/O line 4 Default: I/O line 3</p>	<p>This sets the I/O line to activate for this error condition. The default value is I/O line 3, which corresponds to the red light.</p>
<p>Setting: StopMotion Options: do not stop immediately after 2 in a row after 3 in a row after 4 in a row after 5 in a row after 6 in a row after 7 in a row after 8 in a row after 9 in a row after 10 in a row Default: immediately</p>	<p>This specifies if this error condition should also trigger activation of the stop motion signal.</p>

Alarm (Grade Warning)

<p>Setting: Signal Duration Options: 10ms 20ms 100ms 200ms 500ms 1 second 5 seconds hold Default: 100ms</p>	<p>This specifies the signal duration.</p>
<p>Setting: Signal Output Line Options: I/O line 1 I/O line 2 I/O line 3 I/O line 4 Default: I/O line 3</p>	<p>This sets the I/O line to activate for this error condition. The default value is I/O line 3, which corresponds to the red light.</p>

<p>Setting: StopMotion Options: do not stop immediately after 2 in a row after 3 in a row after 4 in a row after 5 in a row after 6 in a row after 7 in a row after 8 in a row after 9 in a row after 10 in a row Default: immediately</p>	<p>This specifies if this error condition should also trigger activation of the stop motion signal.</p>
---	---

Alarm (Matrix)

<p>Setting: Signal Duration Options: 10ms 20ms 100ms 200ms 500ms 1 second 5 seconds hold Default: 100ms</p>	<p>This specifies the signal duration.</p>
<p>Setting: Signal Output Line Options: I/O line 1 I/O line 2 I/O line 3 I/O line 4 Default: I/O line 3</p>	<p>This sets the I/O line to activate for this error condition. The default value is I/O line 3, which corresponds to the red light.</p>
<p>Setting: StopMotion Options: do not stop immediately after 2 in a row after 3 in a row after 4 in a row after 5 in a row after 6 in a row after 7 in a row after 8 in a row after 9 in a row after 10 in a row Default: immediately</p>	<p>This specifies if this error condition should also trigger activation of the stop motion signal.</p>

Alarm (Mismatch)

Setting: Signal Duration Options: 10ms 20ms 100ms 200ms 500ms 1 second 5 seconds hold Default: 100ms	This specifies the signal duration.
Setting: Signal Output Line Options: I/O line 1 I/O line 2 I/O line 3 I/O line 4 Default: I/O line 3	This sets the I/O line to activate for this error condition. The default value is I/O line 3, which corresponds to the red light.
Setting: StopMotion Options: do not stop immediately after 2 in a row after 3 in a row after 4 in a row after 5 in a row after 6 in a row after 7 in a row after 8 in a row after 9 in a row after 10 in a row Default: immediately	This specifies if this error condition should also trigger activation of the stop motion signal.

Alarm (Missing FNC1)

Setting: Signal Duration Options: 10ms 20ms 100ms 200ms 500ms 1 second 5 seconds hold Default: 100ms	This specifies the signal duration.
Setting: Signal Output Line Options: I/O line 1 I/O line 2 I/O line 3 I/O line 4 Default: I/O line 3	This sets the I/O line to activate for this error condition. The default value is I/O line 3, which corresponds to the red light.

<p>Setting: StopMotion Options: do not stop immediately after 2 in a row after 3 in a row after 4 in a row after 5 in a row after 6 in a row after 7 in a row after 8 in a row after 9 in a row after 10 in a row Default: immediately</p>	<p>This specifies if this error condition should also trigger activation of the stop motion signal.</p>
---	---

Alarm (No Read)

<p>Setting: Signal Duration Options: 10ms 20ms 100ms 200ms 500ms 1 second 5 seconds hold Default: 100ms</p>	<p>This specifies the signal duration.</p>
<p>Setting: Signal Output Line Options: I/O line 1 I/O line 2 I/O line 3 I/O line 4 Default: I/O line 3</p>	<p>This sets the I/O line to activate for this error condition. The default value is I/O line 3, which corresponds to the red light.</p>
<p>Setting: StopMotion Options: do not stop immediately after 2 in a row after 3 in a row after 4 in a row after 5 in a row after 6 in a row after 7 in a row after 8 in a row after 9 in a row after 10 in a row Default: immediately</p>	<p>This specifies if this error condition should also trigger activation of the stop motion signal.</p>

Alarm (Not Assessed)

Setting: Signal Duration Options: 10ms 20ms 100ms 200ms 500ms 1 second 5 seconds hold Default: 100ms	This specifies the signal duration.
Setting: Signal Output Line Options: I/O line 1 I/O line 2 I/O line 3 I/O line 4 Default: I/O line 3	This sets the I/O line to activate for this error condition. The default value is I/O line 3, which corresponds to the red light.
Setting: StopMotion Options: do not stop immediately after 2 in a row after 3 in a row after 4 in a row after 5 in a row after 6 in a row after 7 in a row after 8 in a row after 9 in a row after 10 in a row Default: immediately	This specifies if this error condition should also trigger activation of the stop motion signal.

Alarm (Not Synced)

Setting: Signal Duration Options: 10ms 20ms 100ms 200ms 500ms 1 second 5 seconds hold Default: 100ms	This specifies the signal duration.
Setting: Signal Output Line Options: I/O line 1 I/O line 2 I/O line 3 I/O line 4 Default: I/O line 3	This sets the I/O line to activate for this error condition. The default value is I/O line 3, which corresponds to the red light.

<p>Setting: StopMotion Options: do not stop immediately after 2 in a row after 3 in a row after 4 in a row after 5 in a row after 6 in a row after 7 in a row after 8 in a row after 9 in a row after 10 in a row Default: immediately</p>	<p>This specifies if this error condition should also trigger activation of the stop motion signal.</p>
---	---

Alarm (Quality)

<p>Setting: Signal Duration Options: 10ms 20ms 100ms 200ms 500ms 1 second 5 seconds hold Default: 100ms</p>	<p>This specifies the signal duration.</p>
<p>Setting: Signal Output Line Options: I/O line 1 I/O line 2 I/O line 3 I/O line 4 Default: I/O line 3</p>	<p>This sets the I/O line to activate for this error condition. The default value is I/O line 3, which corresponds to the red light.</p>
<p>Setting: StopMotion Options: do not stop immediately after 2 in a row after 3 in a row after 4 in a row after 5 in a row after 6 in a row after 7 in a row after 8 in a row after 9 in a row after 10 in a row Default: immediately</p>	<p>This specifies if this error condition should also trigger activation of the stop motion signal.</p>

Alarm (Range)

Setting: Signal Duration Options: 10ms 20ms 100ms 200ms 500ms 1 second 5 seconds hold Default: 100ms	This specifies the signal duration.
Setting: Signal Output Line Options: I/O line 1 I/O line 2 I/O line 3 I/O line 4 Default: I/O line 3	This sets the I/O line to activate for this error condition. The default value is I/O line 3, which corresponds to the red light.
Setting: StopMotion Options: do not stop immediately after 2 in a row after 3 in a row after 4 in a row after 5 in a row after 6 in a row after 7 in a row after 8 in a row after 9 in a row after 10 in a row Default: immediately	This specifies if this error condition should also trigger activation of the stop motion signal.

Alarm (Sequence)

Setting: Signal Duration Options: 10ms 20ms 100ms 200ms 500ms 1 second 5 seconds hold Default: 100ms	This specifies the signal duration.
Setting: Signal Output Line Options: I/O line 1 I/O line 2 I/O line 3 I/O line 4 Default: I/O line 3	This sets the I/O line to activate for this error condition. The default value is I/O line 3, which corresponds to the red light.

<p>Setting: StopMotion Options: do not stop immediately after 2 in a row after 3 in a row after 4 in a row after 5 in a row after 6 in a row after 7 in a row after 8 in a row after 9 in a row after 10 in a row Default: immediately</p>	<p>This specifies if this error condition should also trigger activation of the stop motion signal.</p>
---	---

Alarm (Stop Motion)

<p>Setting: Signal Duration Options: 10ms 20ms 100ms 200ms 500ms 1 second 5 seconds hold Default: 100ms</p>	<p>This specifies the signal duration.</p>
<p>Setting: Signal Output Line Options: I/O line 1 I/O line 2 I/O line 3 I/O line 4 Default: I/O line 3</p>	<p>This sets the I/O line to activate for this error condition. The default value is I/O line 3, which corresponds to the red light.</p>
<p>Setting: StopMotion Options: do not stop immediately after 2 in a row after 3 in a row after 4 in a row after 5 in a row after 6 in a row after 7 in a row after 8 in a row after 9 in a row after 10 in a row Default: immediately</p>	<p>This specifies if this error condition should also trigger activation of the stop motion signal.</p>

Alarm (Wrong Length)

Setting: Signal Duration Options: 10ms 20ms 100ms 200ms 500ms 1 second 5 seconds hold Default: 100ms	This specifies the signal duration.
Setting: Signal Output Line Options: I/O line 1 I/O line 2 I/O line 3 I/O line 4 Default: I/O line 3	This sets the I/O line to activate for this error condition. The default value is I/O line 3, which corresponds to the red light.
Setting: StopMotion Options: do not stop immediately after 2 in a row after 3 in a row after 4 in a row after 5 in a row after 6 in a row after 7 in a row after 8 in a row after 9 in a row after 10 in a row Default: immediately	This specifies if this error condition should also trigger activation of the stop motion signal.

ApertureGrading

Setting: ApertureScaling1D Options: none Default: 0.8	The aperture settings are used to calculate barcode grading and should not be changed unless requested by a qualified Omron Microscan representative.
Setting: ApertureScaling2D Options: none Default: 1.0	The aperture settings are used to calculate barcode grading and should not be changed unless requested by a qualified Omron Microscan representative.
Setting: IgnoreGS1Rules Options: 0=off 1=ON Default: 0=off	The aperture settings are used to calculate barcode grading and should not be changed unless requested by a qualified Omron Microscan representative.
Setting: SharpenMatrixSize Options: none Default: 9	The aperture settings are used to calculate barcode grading and should not be changed unless requested by a qualified Omron Microscan representative.
Setting: SharpenValue Options: none Default: 35	The aperture settings are used to calculate barcode grading and should not be changed unless requested by a qualified Omron Microscan representative.

ApertureReading

Setting: ApertureScaling1D Options: none Default: 0.8	The aperture settings are used to calculate barcode grading and should not be changed unless requested by a qualified Omron Microscan representative.
Setting: ApertureScaling2D Options: none Default: 1.0	The aperture settings are used to calculate barcode grading and should not be changed unless requested by a qualified Omron Microscan representative.
Setting: IgnoreGS1Rules Options: 0=off 1=ON Default: 0=off	The aperture settings are used to calculate barcode grading and should not be changed unless requested by a qualified Omron Microscan representative.
Setting: SharpenMatrixSize Options: none Default: 9	The aperture settings are used to calculate barcode grading and should not be changed unless requested by a qualified Omron Microscan representative.
Setting: SharpenValue Options: none Default: 35	The aperture settings are used to calculate barcode grading and should not be changed unless requested by a qualified Omron Microscan representative.

Basic

Setting: ColorMode Options: 0=monochrome Default: 0=monochrome	This setting must match the installed camera technology type.
Setting: DistanceMethod Options: 0=encoder ticks 1=inches 12=feet Default: 1=inches	Reports show distances using the units selected here.
Setting: EncoderPort Options: <ul style="list-style-type: none"> • -0=no light tower / stop motion • -1=USB light tower / stop motion • -2=Printronix printer with USB light tower/stop motion • -3=Printronix printer without USB light tower/stop motion • - 4 = Printronix printer in continuous mode Default: -1=USB light tower/stop motion	EncoderPort is SMU/Light tower output signals.
Setting: LinesPerInch Options: none Default: 400	This setting must match the field of view of the installed camera.

Blemish

Setting: BlemishDebug Options: 0=off 1=save failed images 2=save all images Default: 0=off	BlemishDebug is only to be used when requested by a qualified Omron Microscan representative.
Setting: FloodDiff Options: none Default: 2.0	FloodDiff is only to be used when requested by a qualified Omron Microscan representative.
Setting: FloodSize Options: none Default: 2	FloodSize is only to be used when requested by a qualified Omron Microscan representative.
Setting: MaxThumbnailsPerSector Options: none Default: 4	MaxThumbnailsPerSector limits how many thumbnails are used for a single Blemish sector's errors.
Setting: ScrollMax Options: none Default: 0.125	ScrollMax controls the maximum size range of the blemish Value is in inches.
Setting: ShowDieCutCrossHatch Options: 0=off 1=ON Default: 0=off	ShowDieCutCrossHatch is only to be used when requested by a qualified Omron Microscan representative.
Setting: ShowMatrixDieCutControls Options: 0 1 Default: 0	ShowMatrixDieCutControls is used to make the sensitivity controls for Matrix and Die Cut available during setup.
Setting: TargetDPI Options: none Default: 204.8	TargetDPI is used for Blemish quality. Lower settings help the system to run faster but fewer errors are found. Higher settings slow the system but more errors will be found. It is advised to leave this setting as is unless instructed by an Omron Microscan representative.
Setting: UseAreas Options: 0=off 1=ON Default: 0=off	When the UseAreas feature is turned on, you can define separate rules for each blemish area within a single blemish sector.
Setting: UseSpots Options: 0=off 1=ON Default: 0=off	When the UseSpots feature is turned on, you can define a number of "violations" of the blemish size to allow. Regardless of the setting, any single error that is larger than double the allowed size will cause a failure.
Setting: WanderX Options: none Default: 6	Wander is used to align pixels within the Blemish sector FOREGROUND only. It will hunt for the best matching pixel values in an array size equal to the WanderX,Y value. WanderX controls horizontal motion.
Setting: WanderY Options: none Default: 6	Wander is used to align pixels within the Blemish sector FOREGROUND only. It will hunt for the best matching pixel values in an array size equal to the WanderX,Y value WanderY controls vertical motion.

Blemish Area Rule 1

Setting: AllowedSpots Options: 0 - 9 Default: 0	AllowSpots is only to be used when requested by a qualified Omron Microscan representative.
Setting: BackgroundSensitivity Options: none Default: 70	This is the default value for a Blemish setting in the LVS-7510 software.
Setting: BackgroundSize Options: none Default: 0.020	This is the default value for a Blemish setting in the LVS-7510 software.
Setting: DieCutSensitivity Options: none Default: 50	This is the default value for a Blemish setting in the LVS-7510 software.
Setting: DieCutTolerance Options: none Default: 0.060	This is the default value for a Blemish setting in the LVS-7510 software.
Setting: ForegroundSensitivity Options: none Default: 75	This is the default value for a Blemish setting in the LVS-7510 software.
Setting: ForegroundSize Options: none Default: 0.015	This is the default value for a Blemish setting in the LVS-7510 software.
Setting: MatrixSensitivity Options: none Default: 25	This is the default value for a Blemish setting in the LVS-7510 software.
Setting: MatrixSize Options: none Default: 0.06	This is the default value for a Blemish setting in the LVS-7510 software.
Setting: Separation Options: none Default: 80	Separation is used to differentiate the Foreground from the Background. Increasing this number will define more print as Foreground and less as Background. Decreasing this number will define more of the label as Background and less as Foreground. A sensitivity of 0 will call everything Background and 100 will call everything Foreground.

Blemish Area Rule 2

Setting: AllowedSpots Options: 0 - 9 Default: 0	AllowSpots is only to be used when requested by a qualified Omron Microscan representative.
---	---

Setting: BackgroundSensitivity Options: none Default: 50	This is the default value for a Blemish setting in the LVS-7510 software.
Setting: BackgroundSize Options: none Default: 0.024	This is the default value for a Blemish setting in the LVS-7510 software.
Setting: DieCutSensitivity Options: none Default: 50	This is the default value for a Blemish setting in the LVS-7510 software.
Setting: DieCutTolerance Options: none Default: 0.039	This is the default value for a Blemish setting in the LVS-7510 software.
Setting: ForegroundSensitivity Options: none Default: 65	This is the default value for a Blemish setting in the LVS-7510 software.
Setting: ForegroundSize Options: none Default: 0.015	This is the default value for a Blemish setting in the LVS-7510 software.
Setting: MatrixSensitivity Options: none Default: 25	This is the default value for a Blemish setting in the LVS-7510 software.
Setting: MatrixSize Options: none Default: 0.06	This is the default value for a Blemish setting in the LVS-7510 software.
Setting: Separation Options: none Default: 80	Separation is used to differentiate the Foreground from the Background. Increasing this number will define more print as Foreground and less as Background. Decreasing this number will define more of the label as Background and less as Foreground. A sensitivity of 0 will call everything Background and 100 will call everything Foreground.

Blemish Area Rule 3

Setting: AllowedSpots Options: 0 - 9 Default: 0	AllowSpots is only to be used when requested by a qualified Omron Microscan representative.
Setting: BackgroundSensitivity Options: none Default: 50	This is the default value for a Blemish setting in the LVS-7510 software.

Setting: BackgroundSize Options: none Default: 0.024	This is the default value for a Blemish setting in the LVS-7510 software.
Setting: DieCutSensitivity Options: none Default: 50	This is the default value for a Blemish setting in the LVS-7510 software.
Setting: DieCutTolerance Options: none Default: 0.039	This is the default value for a Blemish setting in the LVS-7510 software.
Setting: ForegroundSensitivity Options: none Default: 65	This is the default value for a Blemish setting in the LVS-7510 software.
Setting: ForegroundSize Options: none Default: 0.015	This is the default value for a Blemish setting in the LVS-7510 software.
Setting: MatrixSensitivity Options: none Default: 25	This is the default value for a Blemish setting in the LVS-7510 software.
Setting: MatrixSize Options: none Default: 0.00	This is the default value for a Blemish setting in the LVS-7510 software.
Setting: Separation Options: none Default: 80	Separation is used to differentiate the Foreground from the Background. Increasing this number will define more print as Foreground and less as Background. Decreasing this number will define more of the label as Background and less as Foreground. A sensitivity of 0 will call everything Background and 100 will call everything Foreground.

Blemish Area Rule 4

Setting: AllowedSpots Options: 0 - 9 Default: 0	AllowSpots is only to be used when requested by a qualified Omron Microscan representative.
Setting: BackgroundSensitivity Options: none Default: 50	This is the default value for a Blemish setting in the LVS-7510 software.
Setting: BackgroundSize Options: none Default: 0.024	This is the default value for a Blemish setting in the LVS-7510 software.

Setting: DieCutSensitivity Options: none Default: 50	This is the default value for a Blemish setting in the LVS-7510 software.
Setting: DieCutTolerance Options: none Default: 0.039	This is the default value for a Blemish setting in the LVS-7510 software.
Setting: ForegroundSensitivity Options: none Default: 65	This is the default value for a Blemish setting in the LVS-7510 software.
Setting: ForegroundSize Options: none Default: 0.015	This is the default value for a Blemish setting in the LVS-7510 software.
Setting: MatrixSensitivity Options: none Default: 25	This is the default value for a Blemish setting in the LVS-7510 software.
Setting: MatrixSize Options: none Default: 0.06	This is the default value for a Blemish setting in the LVS-7510 software.
Setting: Separation Options: none Default: 80	Separation is used to differentiate the Foreground from the Background. Increasing this number will define more print as Foreground and less as Background. Decreasing this number will define more of the label as Background and less as Foreground. A sensitivity of 0 will call everything Background and 100 will call everything Foreground.

Blemish Area Rule 5

Setting: AllowedSpots Options: 0 - 9 Default: 0	AllowSpots is only to be used when requested by a qualified Omron Microscan representative.
Setting: BackgroundSensitivity Options: none Default: 50	This is the default value for a Blemish setting in the LVS-7510 software.
Setting: BackgroundSize Options: none Default: 0.024	This is the default value for a Blemish setting in the LVS-7510 software.
Setting: DieCutSensitivity Options: none Default: 50	This is the default value for a Blemish setting in the LVS-7510 software.

Setting: DieCutTolerance Options: none Default: 0.039	This is the default value for a Blemish setting in the LVS-7510 software.
Setting: ForegroundSensitivity Options: none Default: 65	This is the default value for a Blemish setting in the LVS-7510 software.
Setting: ForegroundSize Options: none Default: 0.015	This is the default value for a Blemish setting in the LVS-7510 software.
Setting: MatrixSensitivity Options: none Default: 25	This is the default value for a Blemish setting in the LVS-7510 software.
Setting: MatrixSize Options: none Default: 0.06	This is the default value for a Blemish setting in the LVS-7510 software.
Setting: Separation Options: none Default: 80	Separation is used to differentiate the Foreground from the Background. Increasing this number will define more print as Foreground and less as Background. Decreasing this number will define more of the label as Background and less as Foreground. A sensitivity of 0 will call everything Background and 100 will call everything Foreground.

Calibration

Setting: Barcodes Options: none Default: 0	Barcodes is the minimum number of barcodes that must be present on the Calibration screen to complete calibration.
Setting: Data Options: none Default: 012345678905	This should match the value on the calibration card.
Setting: LastDate Options: none Default:	Last date which a calibration was completed. This value is set by the computer during the calibration process.
Setting: MaxDaysBeforeRequired Options: none Default: 0	Number of days from last date for a required calibration.
Setting: MilsPerPixel Options: none Default: 2	This value is set by the computer during the calibration process.

Setting: MinOverall Options: none Default: 0.0	This is the minimum overall grade of any barcode used to calibrate.
Setting: Rmax Options: none Default: 89	This should match the value on the calibration card.
Setting: Rmin Options: none Default: 5	This should match the value on the calibration card.
Setting: SmoothGraininess Options: none Default: 40	SmoothGraininess is only to be used when requested by a qualified Omron Microscan representative.
Setting: Xdim Options: none Default: 14.4	This should match the value on the calibration card.

Camera

Setting: Flip Options: 0=off 1=ON Default: 1=ON	Flip is only to be used when requested by a qualified Omron Microscan representative.
--	---

CartonTracking

Setting: CloseEnoughAngle Options: none Default: 0.05	CloseEnoughAngle is only to be used when requested by a qualified Omron Microscan representative.
Setting: CollectDevImages Options: 0=off 1=ON Default: 0=off	CollectDevImages is only to be used when requested by a qualified Omron Microscan representative.
Setting: MaxAngle Options: none Default: 3	MaxAngle is only to be used when requested by a qualified Omron Microscan representative.
Setting: RamPath Options: none Default: none	RamPath is only to be used when requested by a qualified Omron Microscan representative.
Setting: SolidTriangleSize Options: none Default: 0.25	SolidTriangleSize is only to be used when requested by a qualified Omron Microscan representative.

CharSet

Setting: AlphaNumeric Options: none Default: ABCDEFGHIJKLMNOPQRSTUVWXYZ0123456789	The CharSet parameters are for OCR/OCV and are customer configurable. They dictate which characters are to be used or omitted within a sequential number system.
Setting: Numeric Options: none Default: 0123456789	The CharSet parameters are for OCR/OCV and are customer configurable. They dictate which characters are to be used or omitted within a sequential number system.
Setting: NumericAlpha Options: none Default: 0123456789ABCDEFGHIJKLMNOPQRSTUVWXYZ	The CharSet parameters are for OCR/OCV and are customer configurable. They dictate which characters are to be used or omitted within a sequential number system.

Display

Setting: Rotate Options: none Default: 0	Rotate setting should only be configured by a qualified Omron Microscan representative.
--	---

Encoder

Setting: ArrowOffset Options: none Default: 0	ArrowOffset should not be altered as this is a result of changing the arrow's position when using the ShowRollerOnReverse feature.
Setting: AutoRejectDistance Options: none Default: 0	AutoRejectDistance setting should only be configured by a qualified Omron Microscan representative.
Setting: CameraToInspection Options: none Default: 100	CameraToInspection is the distance from the camera to the downstream inspection table.
Setting: CommandLine Options: none Default:	CommandLine setting should only be configured by a qualified Omron Microscan representative.
Setting: CyclesPerRevolution Options: none Default: 360	CyclesPerRevolution setting should only be configured by a qualified Omron Microscan representative.
Setting: EnableRunStatusOnMakeReady Options: 0=off 1=ON Default: 0=off	EnableRunStatusOnMakeReady setting should only be configured by a qualified Omron Microscan representative.

Setting: EncoderDirection Options: 0=forward 1=reverse Default: 0=forward	EncoderDirection setting should only be configured by a qualified Omron Microscan representative.
Setting: OverwriteOnReverse Options: None Default: 0=Off	Adjust this value in lines (0.0025" each) to force seams between labels to occur on the gap.
Setting: PeelAndPresentMode Options: 0=Off 1=On Default: 0=Off	Setting of 1=ON is used to turn on the Peel and Present sensor for printers with the Peel and Present capability.
Setting: RegradeOnReverse Options: <ul style="list-style-type: none"> • 0=do not regrade previously inspected labels • 1=regrade any previously inspected labels that were Replaced • 2=regrade all previously inspected labels • 3=regrade all previously inspected labels that were not Accepted • 4=supports Mode 1 and Mode 2 reversal Default: 0=do not regrade previously inspected labels	RegradeOnReverse tells the software if labels needs to be regraded when a Rewinder winds the labels back to a point then forward again.
Setting: SetRunStatusOnSetup Options: none Default: 0	SetRunStatusOnSetup setting should only be configured by a qualified Omron Microscan representative.
Setting: SetRunStatusOutput Options: none Default: 1	SetRunStatusOutput setting should only be configured by a qualified Omron Microscan representative.
Setting: ShaftDiameter Options: none Default: 1.146	ShaftDiameter setting should only be configured by a qualified Omron Microscan representative.
Setting: ShowRollerOnReverse Options: 0=off 1=ON Default: 0=off	ShowRollerOnReverse determines if a Roll-to-Roll will be displayed when running in reverse. 0 means show the actual image when running. 1 means show the Roll-to-Roll image when running in reverse.
Setting: SimulateStopMotion Options: 0=off 1=ON Default: 0=off	SimulateStopMotion setting should only be configured by a qualified Omron Microscan representative.
Setting: StopMotionDelay Options: none Default: 40	This is the minimum allowed distance that Omron Microscan has determined that the stop motion output signal can be sent without missing any outputs. This should not be changed unless instructed by a qualified Omron Microscan representative.
Setting: StopTimeout Options: none Default:	StopTimeout sets a delay timer before stopping the inspection when the Stop button is clicked when running. It allows the printer to finish printing a label before terminating the inspection.

Grading

Setting: AutoSetupGrade1D Options: 0=read 1D barcodes 1=grade 1D barcodes Default: 1=grade 1D barcodes	AutoSetupGrade1D setting should only be configured by a qualified Omron Microscan representative.
Setting: AutoSetupGrade2D Options: 0=read 2D barcodes 1=grade 2D barcodes Default: 1=grade 2D barcodes	AutoSetupGrade2D setting should only be configured by a qualified Omron Microscan representative.
Setting: DeductForBlemish Options: 0=off 1=ON Default: 0=off	Lowens the ISO overall grade based on the severity of a barcode blemish.
Setting: LightFrequency Options: 0=red light (660nm) 1=white light Default: 0=red light (660nm)	LightFrequency setting should only be configured by a qualified Omron Microscan representative.
Setting: MaxDecodesToGrade Options: none Default: 10	MaxDecodesToGrade is the amount of decodable scan lines it takes to grade a barcode. ANSI standards require at least 10 lines.
Setting: MinimumPassScore Options: none Default: 1.5	MinimumPassScore activates an error signal and logs an error in the log.
Setting: MinimumWarningScore Options: none Default: 0	MinimumWarningScore activates a warning that alerts an operator without generating an error in the log. This value is user configurable.
Setting: Override1DAperture Options: none Default: 0	Override1DAperture setting should only be configured by a qualified Omron Microscan representative.
Setting: Override2DAperture Options: none Default: 0	Enter the desired 2D aperture settings in mils

ImageSaver

Setting: DumpColorSlabPath Options: none Default: none	DumpColorSlabPath setting should only be configured by a qualified Omron Microscan representative.
Setting: Path Options: none Default: none	This is a path to be specified to store images to. A target folder must be made and the path to that target folder is to be put directly after the path=. As an example, Path=C:\Images would need a folder called "Images" under the C:\ drive. It will store all incoming images to that directory. This will show a pop up window reminding the operator that it was set as it will

	consume massive processing power and HDD space if left with a path specified.
Setting: Range Options: none Default: none	Range setting should only be configured by a qualified Omron Microscan representative.
Setting: SaveLabelRepeat Options: none Default: 0	0 means save every unsynchronized label. 1 means save every synchronized label. 2,3,4,5 mean save every label multiple of (example 2 every other, 3 every third, etc) synchronized.

Lumenera

Setting: Brightness Options: none Default: 1.5	Brightness setting should only be configured by a qualified Omron Microscan representative.
Setting: Exposure Options: none Default: 0.3	Exposure is the exposure setting of a Lumenera USB camera.
Setting: FixedSpeed Options: none Default: 0	FixedSpeed is the speed of an external belt or conveyor in feet per minute.
Setting: Gain Options: none Default: 1.0	Gain is used on certain Lumenera cameras.
Setting: Gain0 Options: none Default: 1.0	Gain0, Gain1, Gain2 and Gain3 are the four gain values for the line-scan camera sensors.
Setting: Gain1 Options: none Default: 1.0	Gain0, Gain1, Gain2 and Gain3 are the four gain values for the line-scan camera sensors.
Setting: Gain2 Options: none Default: 1.0	Gain0, Gain1, Gain2 and Gain3 are the four gain values for the line-scan camera sensors.
Setting: Gain3 Options: none Default: 1.0	Gain0, Gain1, Gain2 and Gain3 are the four gain values for the line-scan camera sensors.
Setting: MaxLumeneraSpeed Options: none Default: 60	MaxLumeneraSpeed is the maximum frames that a Lumenera USB camera can run at per second.

OCR

Setting: MaxHorizontalShift Options: none Default: 0	MaxHorizontalShift follows the movement of printed characters.
Setting: OCRDebug Options: 0=off 1=save only OCR error images with scores 2=save all OCR images with scores -1=save OCR images as cropped images without scores Default: 0=off	OCRDebug setting should only be configured by a qualified Omron Microscan representative.
Setting: RatioMethod Options: 0=normal 1=DontForceRatio2to3 2=Learn and use ratio from font Default: 0=off	RatioMethod setting should only be configured by a qualified Omron Microscan representative.
Setting: TouchMode Options: 0=off 1=compensate for slight gaps 2=compensate for large gaps 3=use customer-specific features Default: 0=off	TouchMode setting should only be configured by a qualified Omron Microscan representative.

OCV

Setting: MinimumPassScore Options: none Default: 40	MinimumPassScore sets the default minimum pass score for OCV.
Setting: MinimumWarningScore Options: none Default: 60	MinimumWarningScore sets the default minimum warning score for OCV.

Paths

Setting: DesignArchive Options: none Default: .\Design\Archive	Archive folder path for Design mode templates.
Setting: DesignTemplates Options: none Default: .\Design\Templates	Templates folder path for Design mode templates.
Setting: ProductionArchive Options: none Default: .\Production\Archive	Archive folder path for Production mode jobs.

Setting: ProductionImport Options: none Default: .\Production\Import	Import folder path for Production mode jobs.
Setting: ProductionJobs Options: none Default: .\Production\Jobs	Jobs folder path for Production mode jobs.
Setting: ProductionOutput Options: none Default: .\Production\Output	Output folder path for Production mode jobs.

PopUp

Setting: ShowCameraWarning Options: 0=off 1=ON Default: 1=ON	ShowCameraWarning allows the software to show a popup message when the number specified in the CpuUtilizationWarning is reached.
Setting: ShowNotAssessedWarning Options: 0=off 1=ON Default: 0=off	ShowNotAssessedWarning allows the software to show a popup message when labels are not being inspected.
Setting: ShowNotSyncedWarning Options: 0=off 1=ON Default: 0=off	ShowNotSyncedWarning setting should only be configured by a qualified Omron Microscan representative.

Preset

Setting: Default Options: none Default: Med	Default setting should only be configured by a qualified Omron Microscan representative.
Setting: High Options: none Default: 85,85,5,85,5,25,59,50,39,0	High setting should only be configured by a qualified Omron Microscan representative.
Setting: Low Options: none Default: 65,65,15,65,24,25,59,50,39,0	Low setting should only be configured by a qualified Omron Microscan representative.
Setting: Med Options: none Default: 75,75,15,75,15,25,59,50,39,0	Med setting should only be configured by a qualified Omron Microscan representative.
Setting: UseFeature Options: none Default: 0	UseFeature setting should only be configured by a qualified Omron Microscan representative.

Printronic

Setting: Increment Options: none Default: 3	Increment setting should only be configured by a qualified Omron Microscan representative.
Setting: MinimumStep Options: none Default: 32	MinimumStep setting should only be configured by a qualified Omron Microscan representative.
Setting: ReprintTimeout Options: none Default: 10	ReprintTimeout setting should only be configured by a qualified Omron Microscan representative.
Setting: SystemType Options: 0=Normal 1=Design 2=Production Default: 0= Normal	SystemType setting should only be configured by a qualified Omron Microscan representative.

ProcessFlow

Setting: MaxFilesToImport Options: none Default: 0	Enter the maximum number of zip files allowed to be present in the IMPORT folder at one time. A value of 0 indicates that there is no limit to the number of zip files in the IMPORT folder.
Setting: UseCleanupMode Options: 0=off 1=ON Default: 0=off	In Production mode, setting UseCleanupMode to 1 will delete the zip file from the IMPORT folder once loaded.

Simulation

Setting: HealthCheck Options: 0=off 1=ON Default: 0=off	HealthCheck setting should only be configured by a qualified Omron Microscan representative.
Setting: Path Options: none Default: none	This is the path to a directory of stored images.
Setting: ProcessPath Options: none Default: none	This is the path to a directory of stored images.
Setting: Speed Options: none Default: 50	Speed is how fast the system will simulate web motion. A positive value indicates feet/minute. A negative value specifies the maximum CPU percentage to use.

Sync

Setting: AutoSyncSpanFactor Options: none Default: 6	AutoSyncSpanFactor sets the width of the sync span in automatic setup. The Sync span is set to AutoSyncSpanFactor * HopX.
Setting: FastSync Options: 0=off 1=ON Default: 0=off	FastSync tells the system to not resync when the "Start" button is pushed. This is needed on LVS-7510 systems to not miss the first label.
Setting: HopX Options: none Default: 0.125	HopX tracks the movement of the labels in the horizontal direction.
Setting: HopY Options: none Default: 0.125	HopY tracks the movement of the labels in the vertical direction.
Setting: Log Options: none Default: none	Log setting should only be configured by a qualified Omron Microscan representative.

System

Setting: AcceptReplaceInputTimer Options: 0=off 1=ON Default: 0=off	AcceptReplaceInputTimer setting should only be configured by a qualified Omron Microscan representative.
Setting: ApplyStopMotionWhenNotRunning Options: 0=off 1=ON Default: 0=off	Sends the stop motion signal to the light tower when not on the Running Screen, MakeReady Screen, or Edit screen.
Setting: Audible Alarm Options: none Default: 34	Tells the software what I/O line the system should use to trigger a beep.
Setting: AutoLogin Options: 0=off 1=ON Default: 0=off	The Automatic Login feature allows a user to automatically log in to the LVS-7510 software without entering an Operator ID and Password.
Setting: AutoMakeReady Options: none Default: 0	AutoMakeReady setting should only be configured by a qualified Omron Microscan representative.
Setting: AutoSetup Options: 0=do not use AutoSetup 1=ask if AutoSetup should be used 2=always use AutoSetup without asking 3=carton mode Default: 0=do not use AutoSetup	AutoSetup tells the software when to use the LVS-7510 automated process when creating a new job.

Setting: AutoSetup3Margin Options: none Default: 0.5	AutoSetup3Margin setting should only be configured by a qualified Omron Microscan representative.
Setting: AutoSetupSideMatch Options: none Default: 32	AutoSetupSideMatch setting should only be configured by a qualified Omron Microscan representative.
Setting: AutoStop Options: none Default: 0	AutoStop turns on autostop for stopping after a specified label count.
Setting: Base64Trailer Options: none Default: 0	Base64Trailer setting should only be configured by a qualified Omron Microscan representative.
Setting: BuzzerDuration Options: 10ms 20ms 100ms 200ms 500ms 1 second 2 seconds 3 seconds 4 seconds 5 seconds 6 seconds 7 seconds 8 seconds 9 seconds 10 seconds hold Default: 1 second	This specifies the buzzer duration. Use "hold" to require a manual reset.
Setting: BuzzerIOLine Options: 3=follow error 4=follow stop motion Default: 3=follow error	BuzzerIOLine setting should only be configured by a qualified Omron Microscan representative.
Setting: CameraSpeedWarning Options: none Default: 90	CameraSpeedWarning tells the software when to show a warning message if the camera gets to the specified speed.
Setting: CameraToError Options: none Default: 54	CameraToError is a special function used as of version 5.
Setting: ClearPrompts Options: 0=off 1=ON Default: 0=off	If set to zero (default), the system will re-use the most recently entered data for prompts. If set to non-zero, the computer will start with blanks and the operator must fill in all data.

Setting: ConsecutiveReadLines Options: none Default: 5	ConsecutiveReadLines is how large a gap must be between two adjacent barcodes during autoseup to separate them into two separate sectors.
Setting: CpuUtilizationWarning Options: none Default: 75	CpuUtilizationWarning tells the software when to show a warning message if the CPU usage gets to the specified value.
Setting: Gap Options: off ON Default: off	The Gap=OFF/ON is a specialized reporting ability that if turned on, any jump in a sequential number in a positive direction is called a GAP and is allowed. If the GAP is turned off then this same condition would result in a Sequence error.
Setting: HideAlarmMatrix Options: 0=off 1=ON Default: 0=off	Hides the Alarm Matrix, preventing the adjustment of the Alarm Matrix parameters.
Setting: IgnoreHealthCheck Options: 0=performs HealthCheck on 1D and 2D codes 1=performs HealthCheck on 2D codes and grading on 1D codes 2=performs HealthCheck on 1D codes and grading on 2D codes 3=ignores the HealthCheck code Default: 0	IgnoreHealthCheck setting should only be configured by a qualified Omron Microscan representative.
Setting: InactivityTimeout Options: none Default: 0	Inactivity Timeout automatically logs out any user if the system is left idle for the defined amount of time. This value is defined in minutes.
Setting: LastSystemType Options: Design Production Default: Design	Records last active mode when dual mode functionality is active. Setting should not be changed.
Setting: JobReportFileType Options: 0=PDF 1=HTML Default: 1=HTML	Select the type of output report files generated by the Job Report and Summary Report
Setting: JobreportIncludeDescriptionText Options: 0= No 1=Yes Default: 1=Yes	Select Yes to include the job description test in the job report and summary report footer
Setting: JobReportKeepFiles Options: 0-xxx Default: 0	Select the number of job reports to keep in the jobreports folder. 1 will keep the latest job report only, xxxx will keep the last xxxx reports. 0 value will retain all reports(no upper limit)
Setting: JobReportSignatureType Options: 0= None 1=Wet Signature 2 = e-signature Default: 0= None	Select the type signature to include on report files generated by the Job Report and Summary Report

Setting: LvsContactSensor Options: 0=not installed 5=5" sensor installed 8=8" sensor installed Default: 0=not installed	LvsContactSensor is for Omron Microscan technician use only. It designates the type of contact sensor used with LVS-7510 systems.
Setting: LvsContactSizeY Options: none Default: 96	LvsContactSizeY setting should only be configured by a qualified Omron Microscan representative.
Setting: MajorityDelta Options: none Default: 0	MajorityDelta setting should only be configured by a qualified Omron Microscan representative.
Setting: MakeReady Options: none Default: none	MakeReady is used when the operator needs to ignore a specified string in a sector at the beginning of a job. For instance, type in the word VOID and the software will ignore that word at the beginning of the job only.
Setting: MaxCpuBusyPercent Options: none Default: 100	MaxCpuBusyPercent is the maximum allowable CPU usage as a percentage. If the CPU usage exceeds this value, sectors will be Not Assessed (NA) until the CPU utilization drops to a point equal to this value. Default is 100.
Setting: MaxErrPerSec Options: none Default: 30	MaxErrPerSec prevents the software from failing when inundated with errors. It will not create more than 30 thumbnails of errors per second. After 30 errors, no more thumbnails will be collected until the next second.
Setting: MaxThumbnails Options: none Default: 1000	MaxThumbnails is the amount of thumbnail images that can be reviewed while the system is running.
Setting: MinimumPreserveLength Options: none Default: 10	MinimumPreserveLength setting should only be configured by a qualified Omron Microscan representative.
Setting: MinimumScrapPerRun Options: none Default: 0	MinimumScrapPerRun setting should only be configured by a qualified Omron Microscan representative.
Setting: MonitorInterval Options: none Default: 1000	MonitorInterval setting should only be configured by a qualified Omron Microscan representative.
Setting: MonthsBeforePasswordChange Options: none Default: 0	MonthsBeforePasswordChange prompts users for passwords to be changed after the number of months entered.
Setting: NumColorWBThreads Options: none Default: 5	NumColorWBThreads setting should only be configured by a qualified Omron Microscan representative.

Setting: NumGrabImages Options: none Default: 0	NumGrabImages setting should only be configured by a qualified Omron Microscan representative.
Setting: NumPacketThreads Options: none Default: 8	NumPacketThreads is the number of threads. It is set by how many processing CORES are available per PC.
Setting: OneBigBlemishSector Options: 0=off 1=ON Default: 0=off	OneBigBlemishSector makes the autoseup feature not separate label lanes.
Setting: PDF417UEC Options: none Default: 0	PDF417UEC stops PDF from using ISO.
Setting: Pharmacode Options: 0=off 1=ON Default: 0=off	Pharmacode indicates whether pharmacode is included in the automatic 1D barcode reading/discrimination. Pharmacode=0 means pharmacode is not included in the automatic 1D barcode reading/discrimination. Pharmacode=1 indicates pharmacode is included in the automatic 1D barcode reading/discrimination.
Setting: RelearnAuthorization Options: none Default: 0	RelearnAuthorization setting should only be configured by a qualified Omron Microscan representative.
Setting: ReportUnusedCodes Options: 0=off 1=ON Default: 0=off	If enabled, a button entitled "Report unused codes" appears. This is used to generate a report of codes that were in the match file, but never seen by the system.
Setting: ResyncMatchFileOnMismatch Options: 0=off 1=ON Default: 0=off	If enabled, whenever a mismatch error occurs, the system will assume it is possibly not in the right location in the match file and try to find where it is again. This allows the system to recover instead of generating non-stop mismatch errors after an inserted or deleted label.
Setting: SerialNumber Options: none Default: missing	SerialNumber is the LVS-7510 serial number and should never be changed.
Setting: ShowAdditionalCounters Options: 0=off 1=ON Default: 0=off	ShowAdditionalCounters setting should only be configured by a qualified Omron Microscan representative.
Setting: ShowBlemishMotion Options: 0=off 1=ON Default: 0=off	ShowBlemishMotion setting should only be configured by a qualified Omron Microscan representative.

Setting: ShowElapsedTime Options: 0=off 1=ON Default: 0=off	ShowElapsedTime setting should only be configured by a qualified Omron Microscan representative.
Setting: ShowJobReportButton Options: 0=off 1=ON Default: 0=off	When ShowJobReportButton setting is on the Job Report button is enabled on the edit mode Step 7 Save job to disk screen.
Setting: ShowMod10CheckBox Options: 0=off 1=ON Default: 0=off	ShowMod10CheckBox setting should only be configured by a qualified Omron Microscan representative.
Setting: ShowPrintJobButton Options: 0=off 1=ON Default: 0=off	When ShowPrintJobButton setting is ON the Print Job button is enabled on the Ready to run screen.
Setting: ShowReportLabel Options: 0=off 1=ON Default: 0=off	ShowReportLabel setting should only be configured by a qualified Omron Microscan representative.
Setting: ShowRuntimeGradeStats Options: 0=off 1=ON Default: 0=off	ShowRuntimeGradeStats setting should only be configured by a qualified Omron Microscan representative.
Setting: ShowSnapshotButton Options: 0=off 1=ON Default: 0=off	ShowSnapshotButton setting should only be configured by a qualified Omron Microscan representative.
Setting: ShowSpeed Options: 0=off 1=ON Default: 0=off	ShowSpeed setting should only be configured by a qualified Omron Microscan representative.
Setting: ShowStatusAlert Options: 0=off 1=ON Default: 0=off	ShowStatusAlert setting should only be configured by a qualified Omron Microscan representative.
Setting: SkipAutoSetupShrink Options: none Default: 0	SkipAutoSetupShrink setting should only be configured by a qualified Omron Microscan representative.
Setting: Splash Options: none Default: none	Splash setting should only be configured by a qualified Omron Microscan representative.
Setting: SpotVoidCheck Options: 0=off 1=ON Default: 0=off	SpotVoidCheck will error any spot anywhere within a barcode. Do not use unless instructed by Omron Microscan technician.

Setting: Stagger Options: 0=off 1=ON Default: 0=off	Stagger setting should only be configured by a qualified Omron Microscan representative.
Setting: StripParentheses Options: 0=off 1=ON Default: 0=off	StripParentheses takes parentheses off decoded data strings from symbologies such as GS1 Databar or Data Matrix.
Setting: Strobe Options: 0=Normal mode 1=Strobe mode 2=Advanced strobe mode Default: 0= Normal mode	Strobe allows the system to be used in viewing mode like a strobe light. There must be a consistent sync mark on the web to use this feature. Only use this setting if advised by an Omron Microscan Technician.
Setting: TakeSecondPicture Options: 0=off 1=ON Default: 0=off	TakeSecondPicture setting should only be configured by a qualified Omron Microscan representative.
Setting: ThreadLockTimeout Options: none Default: 0	ThreadLockTimeout setting should only be configured by a qualified Omron Microscan representative.
Setting: TiltedRead Options: 0=off 1=ON Default: 0=off	TiltedRead attempts to read a short in height barcode by applying a slight rotation.
Setting: TitleBar Options: none Default: none	TitleBar setting should only be configured by a qualified Omron Microscan representative.
Setting: UsePhotoeyeSignal Options: none Default: 0	UsePhotoeyeSignal turns on the monitoring of the Photo optic signal Input line. Activated on LOW signal. This is special as it can use any available port via the integer used. Also, the polarity can be switched by making the integer a negative number. For example, UsePhotoeyeSignal=-3 makes it respond to an active HIGH signal on input #3.
Setting: UseSectorTags Options: none Default: 0	UseSectorTags setting should only be configured by a qualified Omron Microscan representative.
Setting: UseTrackingSignal Options: 0=off 1=ON Default: 0=off	UseTrackingSignal setting should only be configured by a qualified Omron Microscan representative.

TCP/IP

Setting: Host Options: none Default: 0.0.0.0	Host setting should only be configured by a qualified Omron Microscan representative. Leave as default value.
--	---

<p>Setting: Mode Options: off Remote XML Default: off</p>	<p>Mode indicates if the LVS-7510 is connecting to another system. Use off if the LVS-7510 is not connecting to another system. Use remote if the LVS-7510 is connecting with a remote computer, such as the Omron Microscan HMI Command Center or a non-Omron Microscan system. Note that all remaining settings (such as Host, Port1, Port2, etc.) do not apply if the LVS-7510 is not connecting to another system.</p>
<p>Setting: Port1 Options: none Default: 0</p>	<p>Enter the port where the first external system will be listening for Omron Microscan data.</p>
<p>Setting: Port1Filter Options: none Default: none</p>	<p>Specifies the type of information that the LVS-7510 system will broadcast on the port specified by Port1. This filter is for output from the LVS-7510 only. Leave this blank to receive all information from the LVS-7510 system. Enter a comma separated list of Binary Command Byte ID#'s to receive only the feedback information desired.</p>
<p>Setting: Port2 Options: none Default: 0</p>	<p>Enter the port where the second external system will be listening for Omron Microscan data.</p>
<p>Setting: Port2Filter Options: none Default: none</p>	<p>Specifies the type of information that the LVS-7510 system will broadcast on the port specified by Port2. This filter is for output from the LVS-7510 only. Leave this blank to receive all information from the LVS-7510 system. Enter a comma separated list of Binary Command Byte ID#'s to receive only the feedback information desired.</p>

Appendix B: Epedigree

Systems with ePedigree enabled are using the normal LVS-7510 software with enhanced tracking features. Below are a couple of steps that highlight the LVS-7510 ePedigree process.

1. When drawing a sector over a 2D Data Matrix code, make sure that the center of the X within the sector is close to the center of the 2D code. This helps the software to determine the position of the barcode.

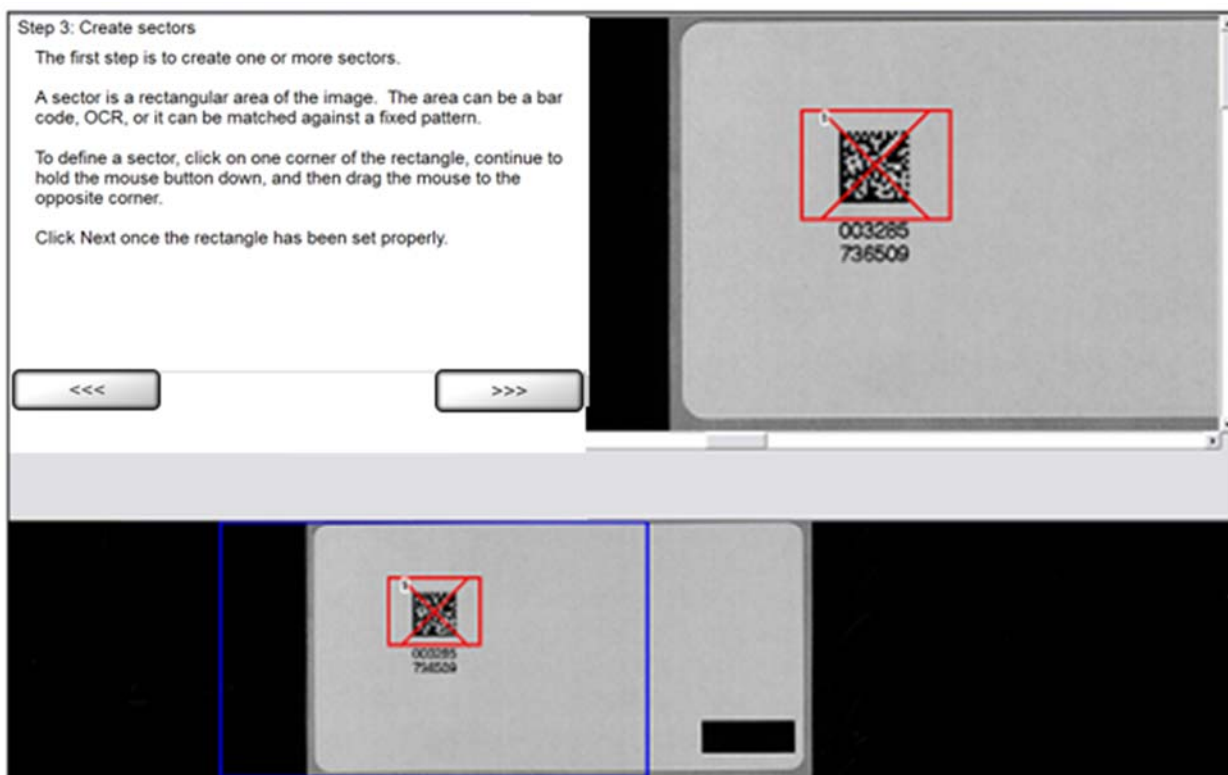

2. Choose the Check for Duplicates option to make sure that the barcode's encoded data is unique for this job or the sect. When running the job, a !DU error will show up if the software finds a duplicate of the barcode.



3. Draw an OCR sector around the human readable characters and let it match its corresponding barcode. In this example, we have to start matching OCR at position 17 of the barcode, because the barcode is 28 characters long and the human readable characters match the last 12 characters of the barcode.



Appendix C: ImageSaver Instructions

Saving Raw Images Without a Label Repeat

1. Create and name a target folder where images can be saved (see below).

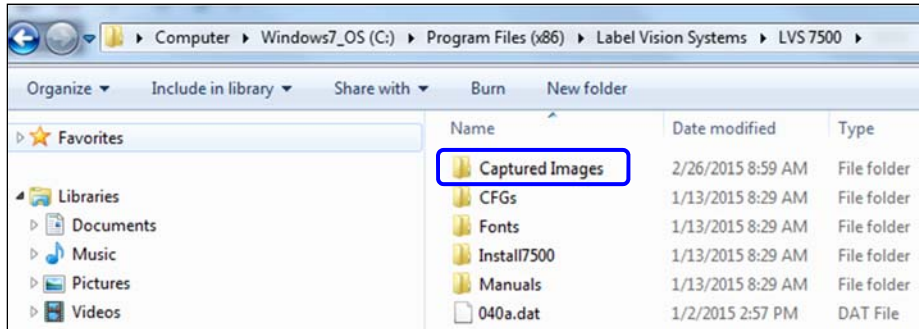

2. Open the LVS-7510 software and click “Settings” in the menu bar.
 - a. Select the “Settings for this section” radio button and select “ImageSaver” from the dropdown list (see below).
 - b. Double-click “Path” located in the “Setting” column (see below).

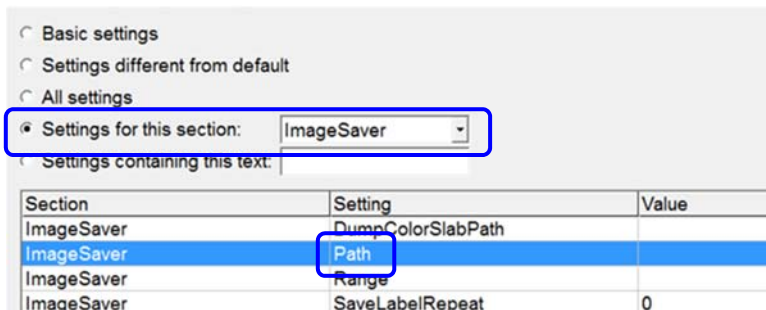

- c. In the “Value” field, enter the path of the folder that was created to store images. Then, click “OK (save changes).”

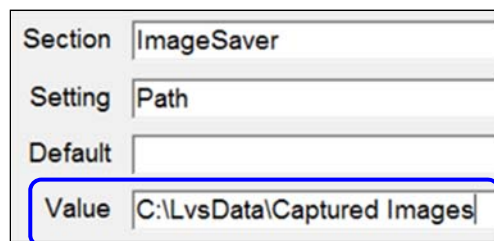

d. Double-click "SaveLabelRepeat."

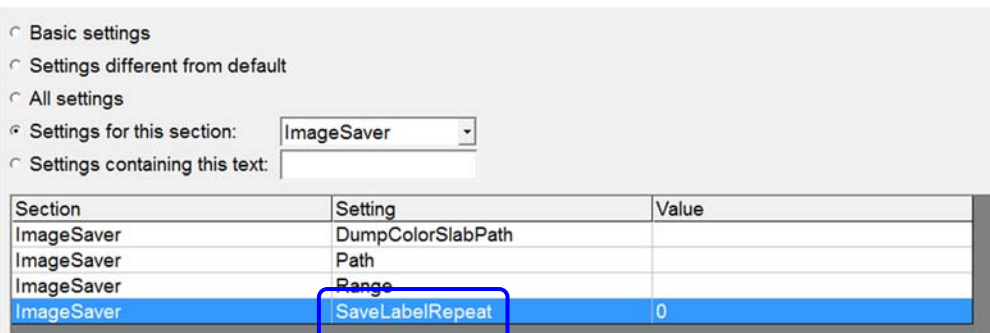

e. Type "1" in the "Value" field and click "OK (save changes)."



f. Close the "Settings" menu by clicking the red "X" in the top, right corner of the Configuration Editor screen.

3. Click "Yes" to the "Save Changes" confirmation.

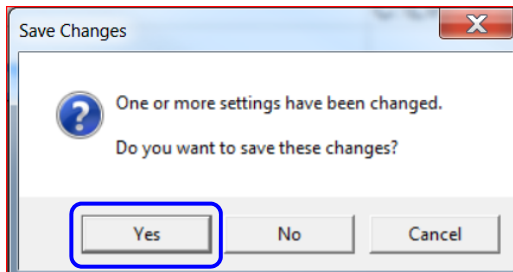

4. Close and then restart the LVS-7510 software.

5. Click "OK" at the ImageSaver warning.

Clearing the ImageSaver after capturing the desired images is important as it will continue to save images causing the hard drive to fill up.

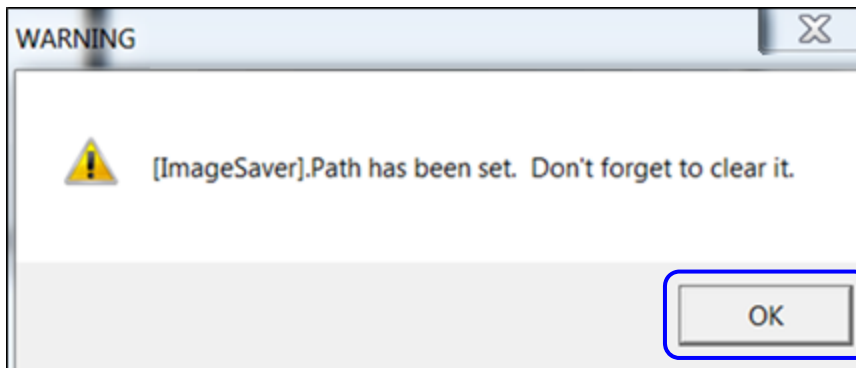

- Click the “Create a New Job” button.



- Select “No” when asked, “Do you want to use the automatic setup feature?”

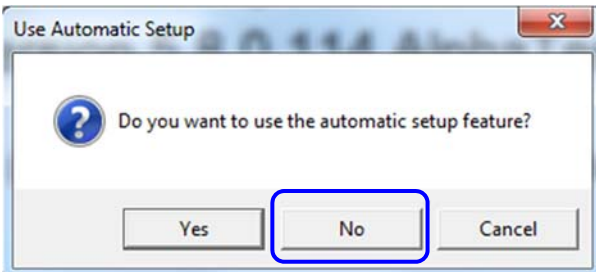

- Stay at the “Step 1: Set label repeat” screen (your settings may appear differently than the settings in the image below).

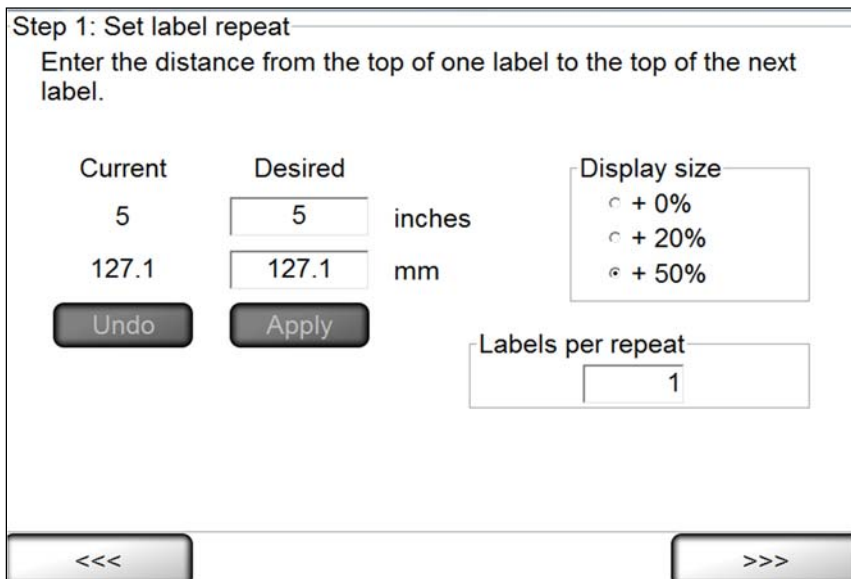

- Run the printer to obtain a desired amount of images. The system is capturing images although the onscreen images may not immediately update.
- Stop the job and close the LVS-7510 software; then, stop the printer.

11. Navigate to the “captured images” folder (your folder may be named differently) that was created in Step 1 and the images should appear from the last job.
12. When image capturing is complete, click “Settings” in the menu bar.
 - a. Select the “Settings for this section” radio button and select “ImageSaver” from the dropdown list.
 - b. Double-click “Path” in the “Setting” column.

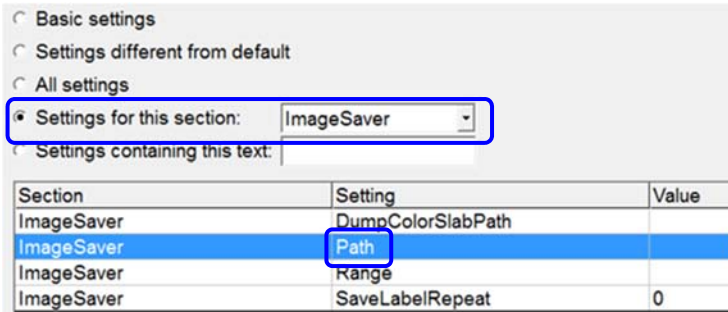

- c. Delete the path in the “Value” field and save your changes.

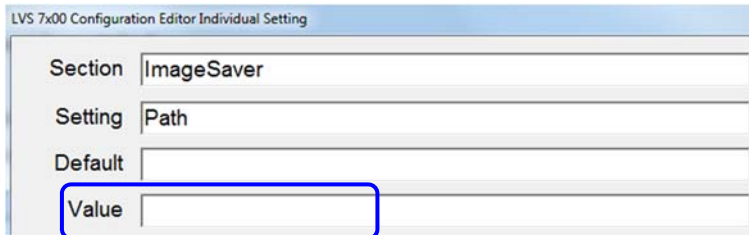

- d. Double-click “SaveLabelRepeat.”

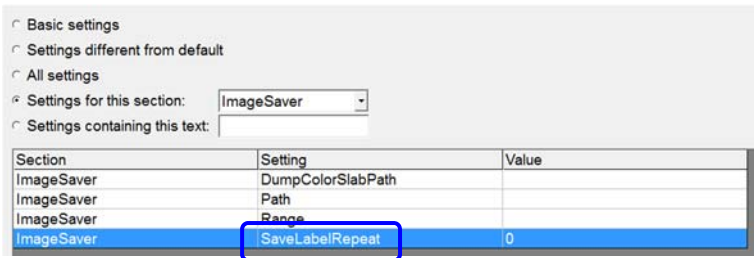

- e. Enter 0 (zero) in the “Value” field and then save your changes.

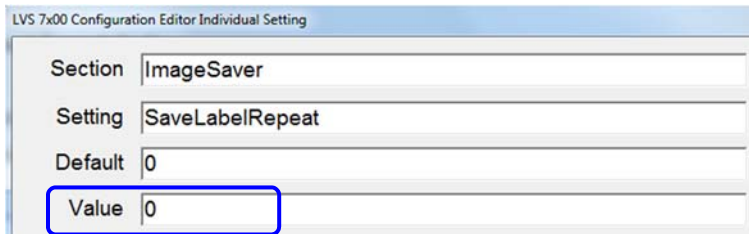

Saving Images WITH a Label Repeat

1. Open the LVS-7510 software and create a new job with the labels that you would like to capture.
2. Correctly synchronize the labels, define any sector, and save the job.
3. After the job is created, close the LVS-7510 software and stop the printer.
4. Open Windows Explorer and navigate to the LVS-7510 folder:
 - For installations of software version 20.2.X on Windows® 7 Professional and Windows® 8.1 Professional operating systems: C:\LvsData\LVS 7500
 - Jobs created in earlier versions of the software are not supported. Manually backup any desired data and manually delete the C:\Users\[User Login Name]\AppData\Roaming\Label Vision Systems\LVS 7500. Then, install software release 20.2.X as a new installation.
5. Create and name a target folder where images can be saved (see below).

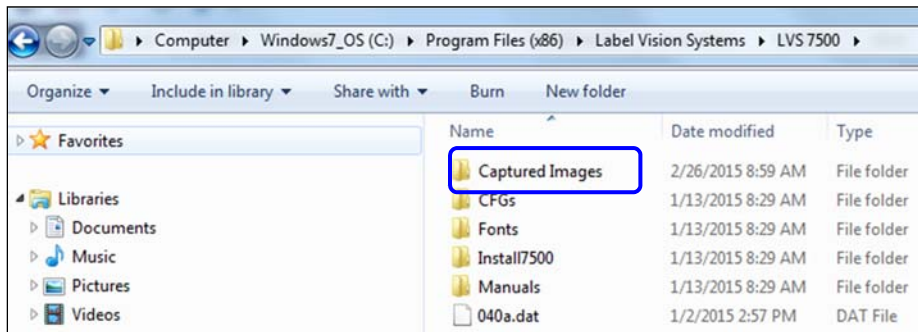

6. Open the LVS-7510 software and click “Settings” in the menu bar.
 - a. Select the “Settings for this section” radio button and select “ImageSaver” from the dropdown list.
 - b. Double-click “Path” located in the “Setting” column (see below).

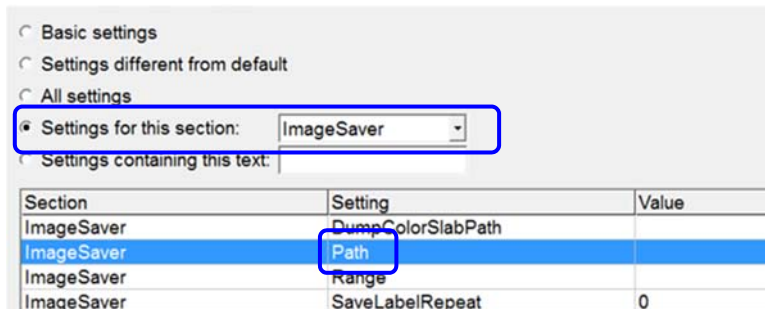

- c. In the “Value” field, enter the path of the folder that was created to store images. Then, click “OK (save changes).”

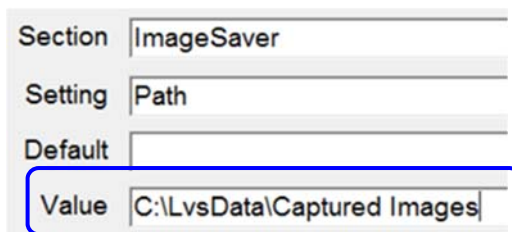

d. Double-click "SaveLabelRepeat."

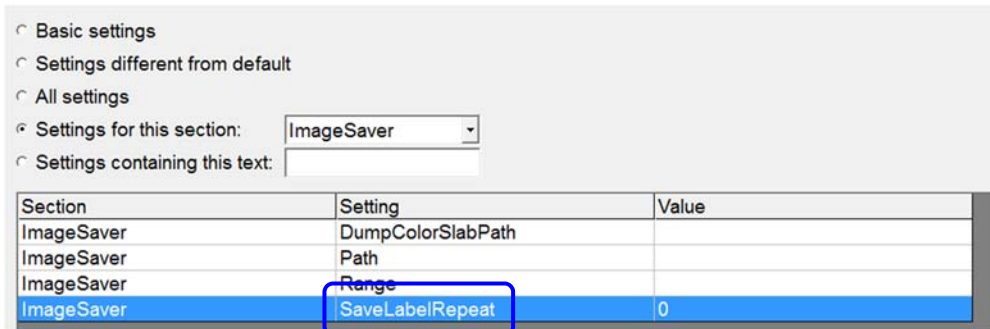

e. Type "1" in the "Value" field and then click "OK (save changes)."

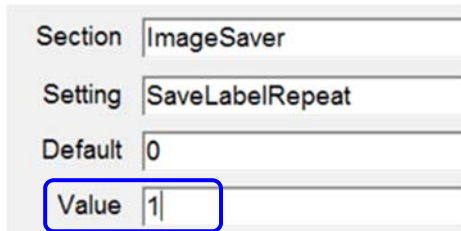

f. Close the "Settings" menu by clicking the red "X" in the top, right corner of the Configuration Editor screen.

7. Click "Yes" to the "Save Changes" confirmation.

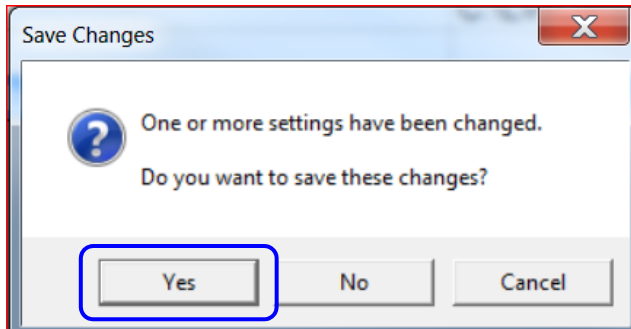

8. Close and then restart the LVS-7510 software.

9. Click "OK" at the ImageSaver warning.

Clearing the ImageSaver after capturing the desired images is important as it will continue to save images causing the hard drive to fill up.

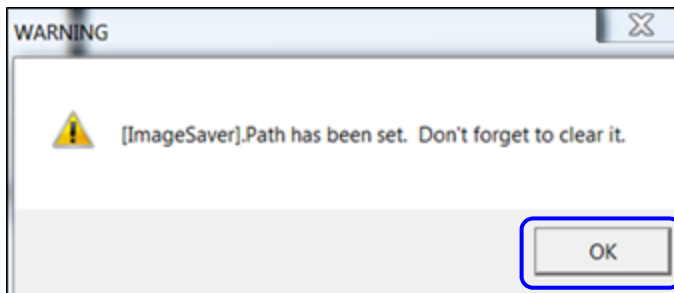

- Click the “Load an Existing template” button and choose the template that was created for image capturing.

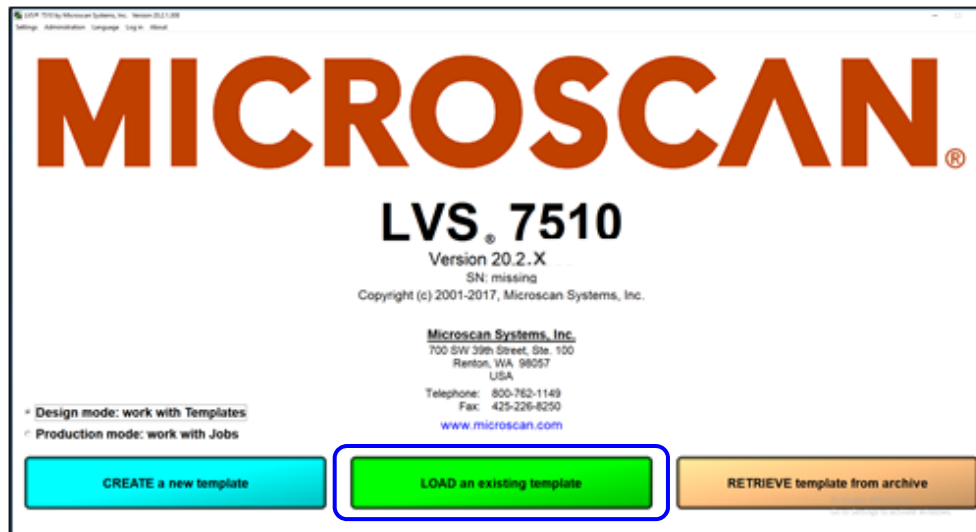

- After the template is loaded, click the “Start new run” button and jog the printer for a desired amount of images. Each label repeat should be a full image.



- Stop the printer.
- Stop the job and close the LVS-7510 software.
- Navigate to the “captured images” folder (your folder may be named differently) that was created in Step 1 and the images should appear from the last job.
- When image capturing is complete, click “Settings” in the menu bar.
 - Select the “Settings for this section” radio button and select “ImageSaver” from the dropdown list.
 - Double-click “Path” in the “Setting” column.

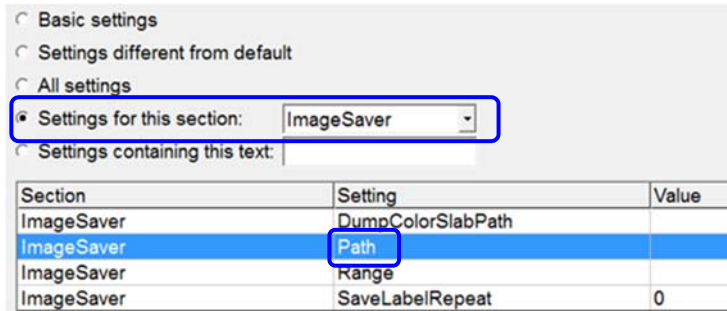

- c. Delete the path in the “Value” field and save your changes.

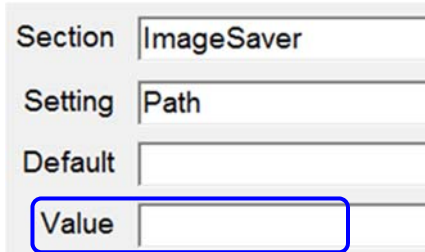

- d. Double-click “SaveLabelRepeat.”

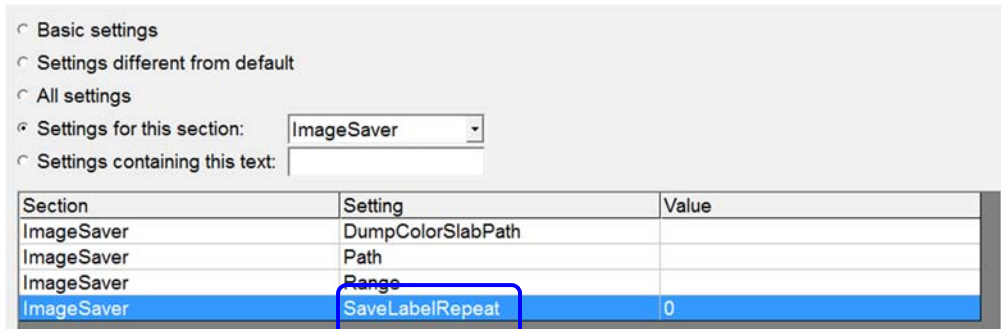

- e. Enter 0 (zero) in the “Value” field and then save your changes.

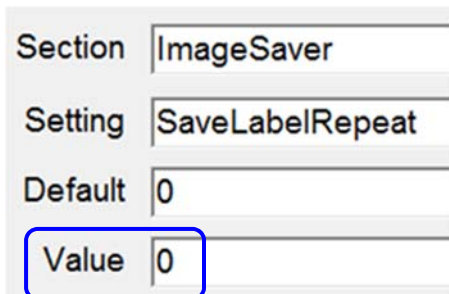

16. Remember to remove all excess images as they will quickly take up space on the hard drive.

Appendix D: Upgrading Software

1. After receiving the LVS-7510 software files to download, open the .zip folder and double-click “Setup.exe.”

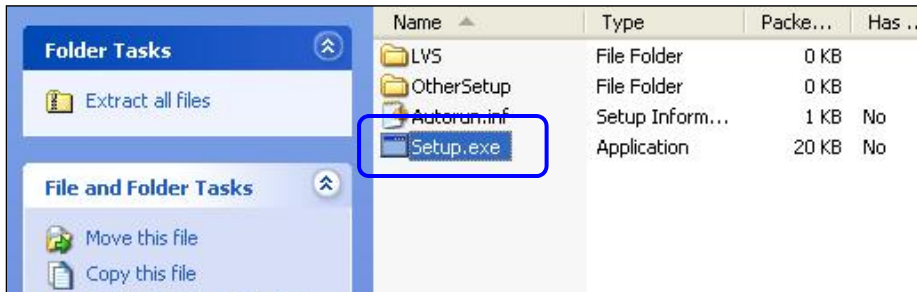

2. Click “Next” to begin installation.

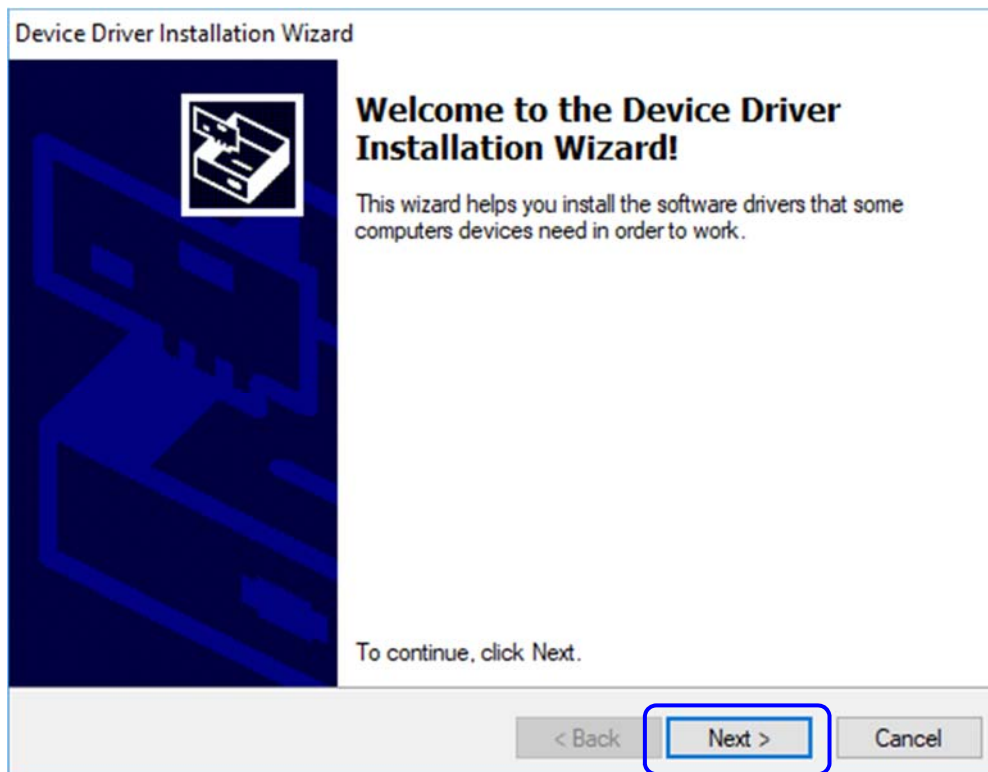

3. Click "Next" on the "LVS-7510 InstallShield Wizard" screen.

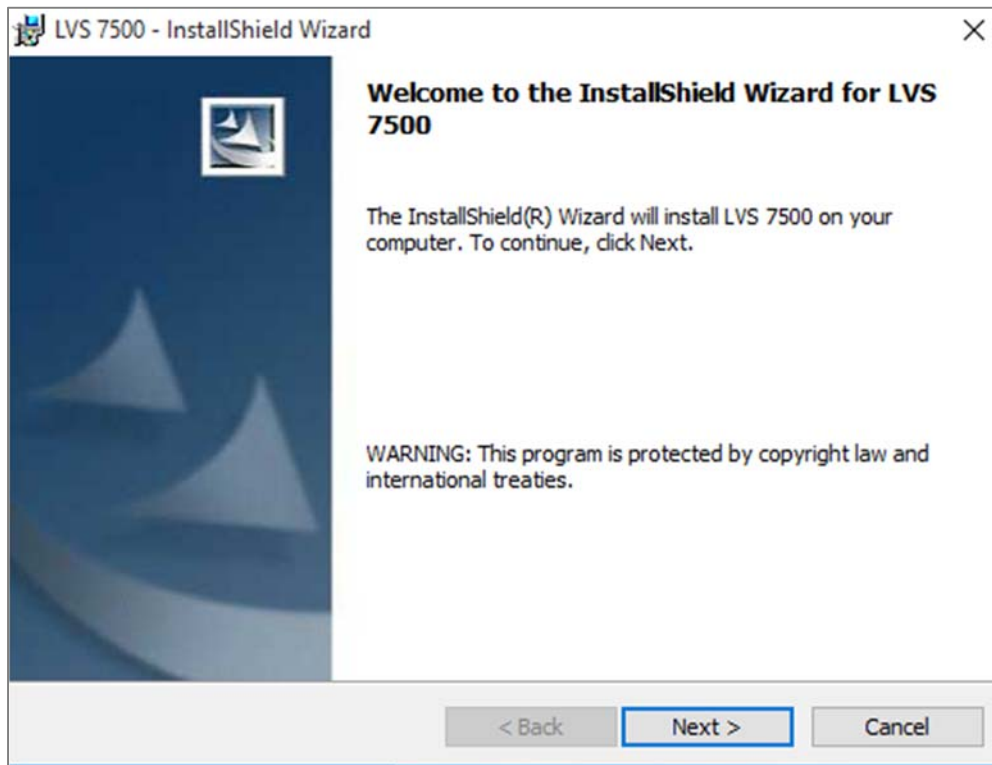

4. Click Finish to continue.

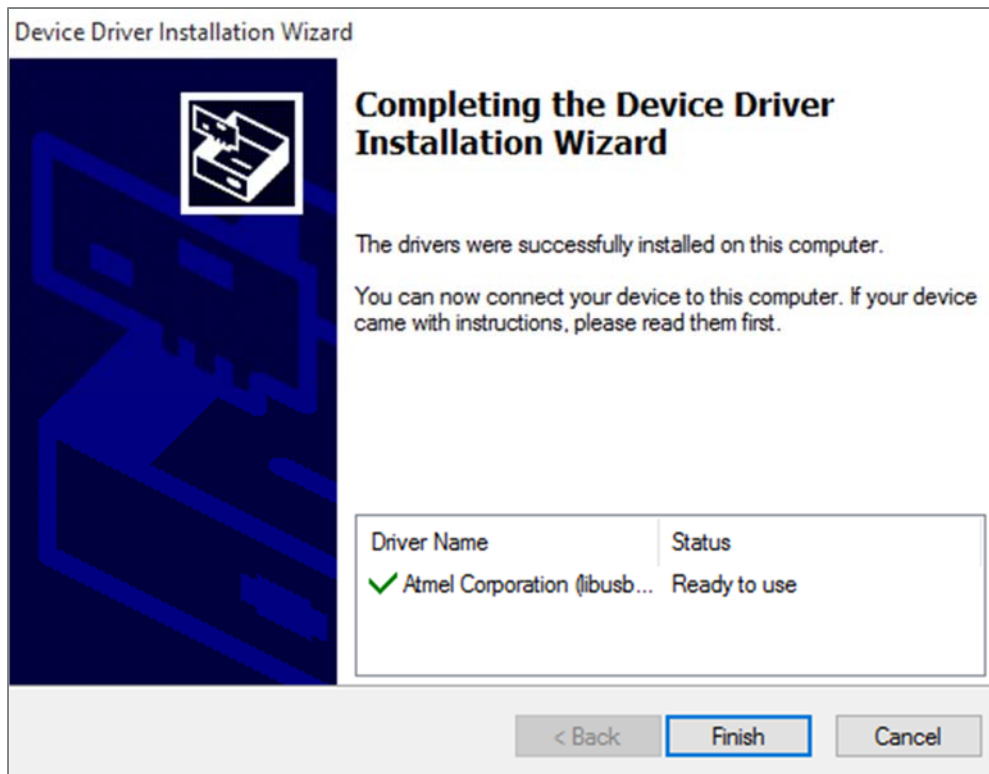

- Click Finish again to continue.

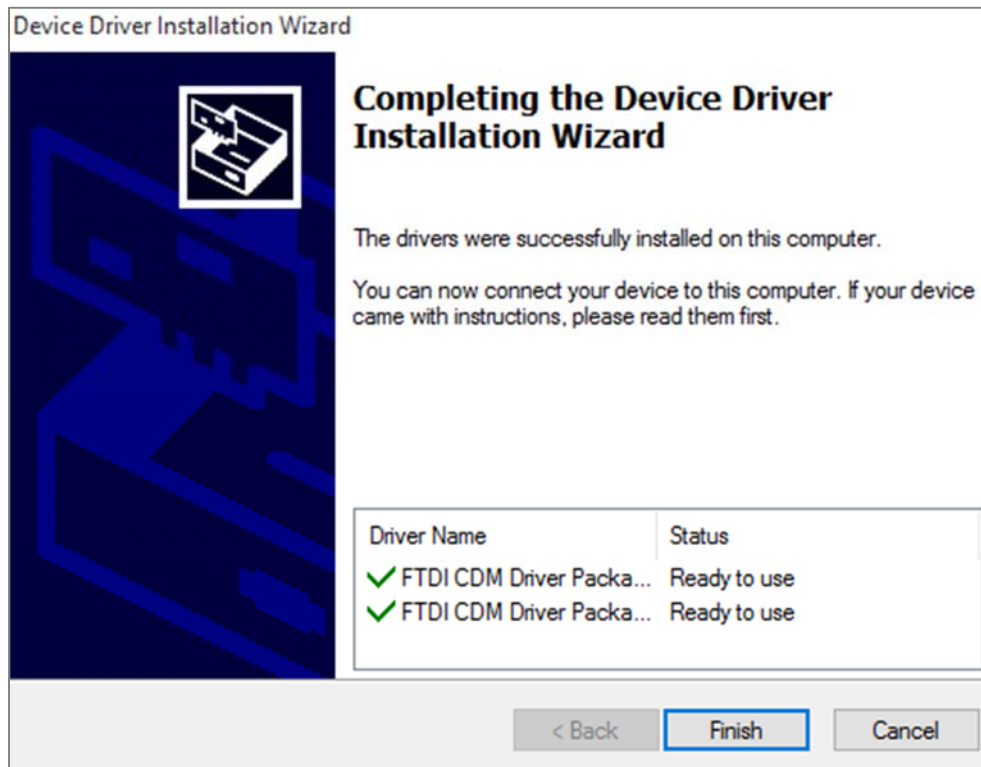

- Click Finish again to continue.

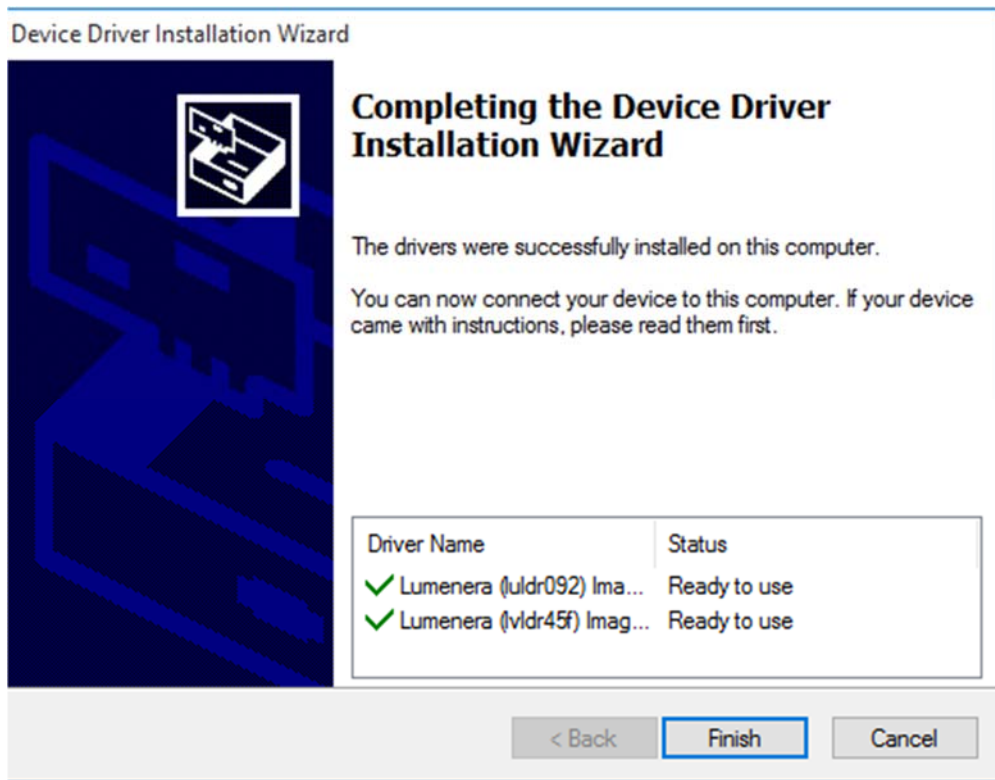

7. Installation begins, which may take several minutes to complete.

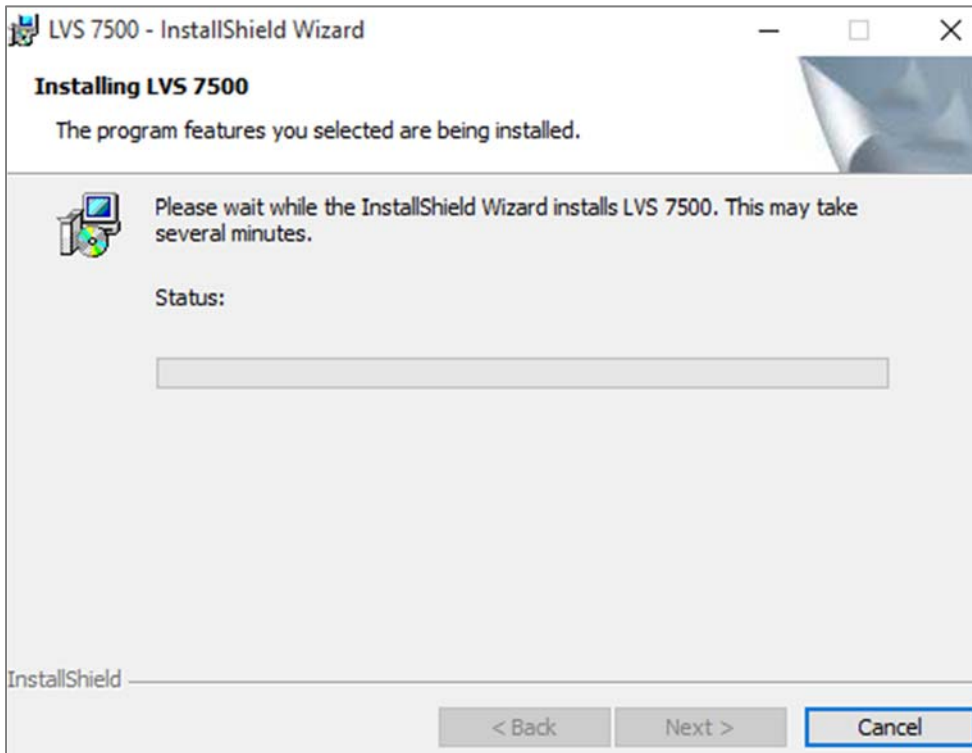

8. The "InstallShield Wizard Completed" window appears when installation is complete. Click "Finish."

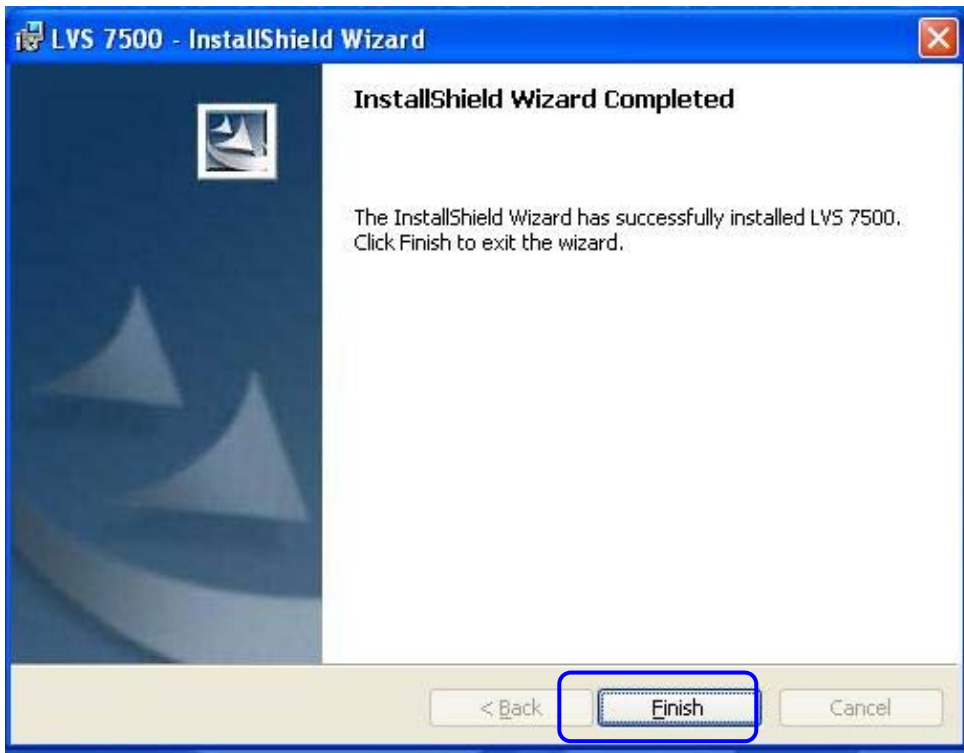

Appendix E: Automatic Login

The Automatic Login feature allows a user to automatically log in to the LVS-7510 software without entering an Operator ID and Password.

Automatic Login Settings

Automatic Login settings are controlled in the “Settings” menu file:

1. Click “Settings” in the menu bar.
2. Type “autologin” (uppercase or lowercase letters) in the “Settings containing this text” field (see below).
3. Double-click “AutoLogin” in the “Setting” column.

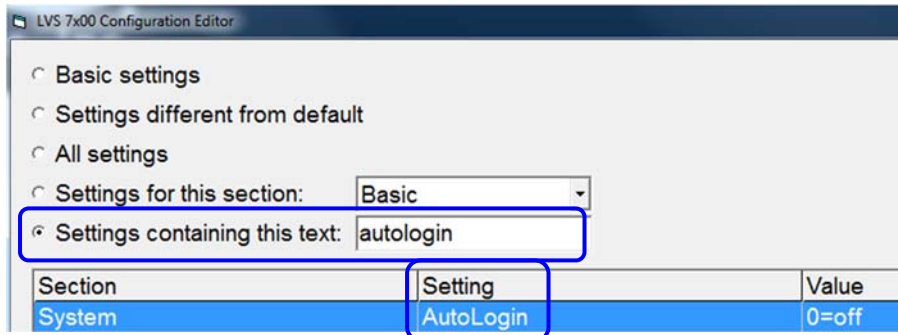

4. In the “Value” field, select one of the following:
 - **0=off** – disables Automatic Login
 - **1=On** – enables Automatic Login

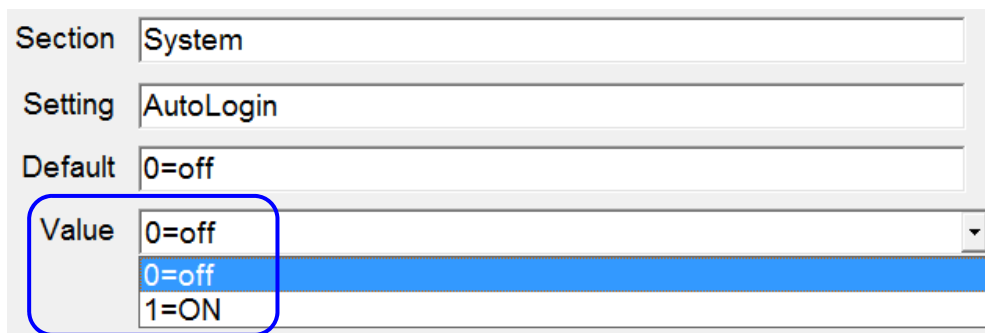

5. Click “OK (save changes).”
6. Click the red “X” in the top, right corner of the Configuration Editor screen.

Automatic Login Instructions

When enabled, the LVS-7510 compares the current Windows user name to the list of LVS-7510 operator names. If there is a match, and if the operator's LVS-7510 password is set to "AUTO," then the user will automatically be logged in to the LVS-7510 software.

Automatic Login is attempted only when the LVS-7510 is first opened. If a user logs out of the LVS-7510, then the next user is required to log in manually. If the operator closes the LVS-7510 entirely, then Automatic Login will be attempted the next time the LVS-7510 software is launched.

To enable an operator to use Automatic Login, follow the steps below.

1. Click "Administration" > "Operators" from the menu bar.

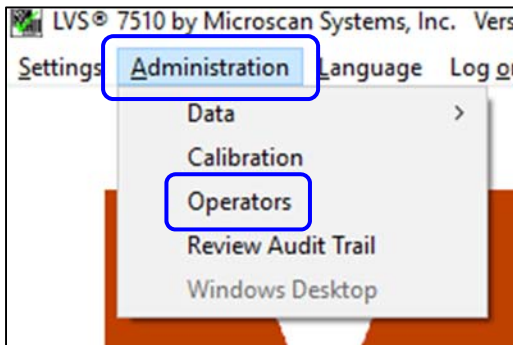

2. On the "Operator Administration" screen, click the "Add new operator" button.

 A screenshot of the "Operator Administration" screen. The window title is "Operator Administration" with a close button (X) in the top right corner. The screen is divided into three main sections:

- Operators:** A list box containing "Admin", "Operator 1", "Operator 2", "Operator 3", and "Operator 4".
- Operator ID (short name):** A text input field.
- Operator name (full):** A text input field.
- Password (enter twice):** Two text input fields for password confirmation.
- Permissions:** A list of checkboxes:
 - Allow Create NEW Job / Edit
 - Allow Load EXISTING Job
 - Allow Calibration
 - Allow Administration
 - Allow Accept / Replace Errors
 - Allow Bypass / MakeReady
 - Allow Abort
 - Allow Ignore
 - Allow Reset Printer

 At the bottom, there are six buttons: "Add new operator" (highlighted with a blue dashed border), "Change this operator", "Delete this operator", "Discard changes", "Save changes", and "Done".

3. Enter the operator name in the "Operator ID (short name)" field and "Operator name (full)" field. **The Operator name must match the Windows user name.**
4. Enter "AUTO" (all uppercase letters) in the "Password" field. Enter this password in each of the two "Password" fields.
5. Select the desired operator permissions in the "Permissions" section.
6. Click the "Save Changes" button, and then click the "Done" button.
7. Close the LVS-7510 software by clicking the X in the top, right corner of the screen.
8. Log in to Windows as the user you just setup in the LVS-7510 software.
9. Open the LVS-7510 software. The user should automatically be logged in and the "Create a New Job" or "Load an Existing Job" screen is visible. The user is not prompted to enter a user name or password.
10. See the "Create a New Job" section in this manual for detailed instructions on creating a new job. See the "Load an Existing Job" section for detailed instructions on loading an existing job.
11. Close the LVS-7510 when work is complete.

12. Log off of Windows.

IMPORTANT: Automatic Login is only attempted when the LVS-7510 is first opened. If the operator logs out of the LVS-7510, then the next user must log in manually. If the operator closes the LVS-7510 entirely, then Automatic Login will be attempted the next time the LVS-7510 software is launched.

In practice, an operator would follow the steps below:

- a. Log in to Windows.
- b. Launch the LVS-7510. Automatic Login executes for that Windows user name.
- c. Run the LVS-7510 as needed.
- d. Close the LVS-7510.
- e. Log off of Windows.
- f. The next operator repeats the above steps.

Appendix F: Managing Operator Permissions in Microsoft® Active Directory

Overview

The LVS-7510 software integrates with Microsoft Active Directory to manage operator permissions. LVS-7510 users are granted user privileges based on Microsoft authentication and LVS-7510 permissions are assigned based on group membership in Omron Microscan specific Active Directory groups. All systems using Active Directory must have a network of Microsoft® 2003 or later.

Active Directory control of LVS-7510 users provides a single, secure record of authentication and authorization. Control of all Active Directory changes is managed through Active Directory Group policy and ownership located on the Microsoft Server.

LVS-7510 operators can have a combination of permissions. Operator permissions are the same regardless of how the user IDs, passwords and permissions are managed.

When Active Directory is enabled on each start of the LVS-7510 software, the system will connect over the network to the specified Microsoft Active Directory domain controller. The LVS-7510 will create a local Operators.dat file containing all of the LVS-7510 users and their permissions. All of the users created are in the Active Directory Group specified in the LVS-7510 configuration setting "ActiveDirectoryLVSAIUsers." When Active Directory is enabled, user passwords, password expiration dates and failed password counts are not stored locally in the Operator.dat file. Microsoft Active Directory policies will manage user password restrictions and policies. When a user enters their user name and password into the LVS-7510, the credentials are verified with the current user name and password in the Active Directory. The Operator Administration window in the LVS-7510 can be used to view the current users and their permissions. When users are disabled or deleted from Active Directory, their access to LVS-7510 login is immediately disabled even if the LVS-7510 has not been restarted.

The login for "admin" is not managed in Active Directory and remains in the local Operator.dat file. All new installations create a default administrator user with the User Name and Password set to "admin." The "admin" user password is stored locally to allow access to the system in case of network outages. This provides the option of operating the LVS-7510 without Active Directory user authentication. With Active Directory enabled, the admin user is the only user that can be modified using the LVS-7510 Operator Administration interface. The admin user name and password can be changed and deleted if desired; however, if the admin user name is changed or deleted and the system loses connection to the Active Directory Server or Active Directory is disabled, then no user will exist that has access to enable Active Directory or manage users in a standalone mode.

Enable Active Directory

1. Log in to the LVS-7510 software. You must have administrator rights to enable Active Directory.
2. Click Settings in the menu bar.



- In the **Settings containing this text** field, type **active**. All Active Directory settings appear in the “Setting” column and are preceded by “ActiveDirectory.”

IMPORTANT: ALL Active Directory settings must be configured for Active Directory to work correctly. Refer to the “Active Directory Configuration Settings” section below for descriptions of each setting.

The screenshot shows the 'LVS 7x00 Configuration Editor' window. Under the 'Settings for this section:' dropdown, 'ActiveDirectory' is selected. Below this, a table displays the following settings:

Section	Setting	Value
ActiveDirectory	ActiveDirectoryAuthentication	1=ON
ActiveDirectory	ActiveDirectoryDomain	ENGINEERING.local
ActiveDirectory	ActiveDirectoryLVSAAllowAbort	LVSAllowAbort
ActiveDirectory	ActiveDirectoryLVSAAllowAcceptRep	LVSAllowAcceptReplace
ActiveDirectory	ActiveDirectoryLVSAAllowAdministrati	LVSAllowAdministration
ActiveDirectory	ActiveDirectoryLVSAAllowBypassMak	LVSAllowBypassMakeReady
ActiveDirectory	ActiveDirectoryLVSAAllowCalibration	LVSAllowCalibration
ActiveDirectory	ActiveDirectoryLVSAAllowCreateEdit	LVSAllowCreateEdit
ActiveDirectory	ActiveDirectoryLVSAAllowIgnore	LVSAllowIgnore
ActiveDirectory	ActiveDirectoryLVSAAllowLoadExistin	LVSAllowLoadExisting
ActiveDirectory	ActiveDirectoryLVSAAllowResetPrinte	LVSAllowResetPrinter
ActiveDirectory	ActiveDirectoryLVSAAllUsers	cn=LVS7500Users,ou=ValidationUsr
ActiveDirectory	ActiveDirectoryLVSAOrgUnit	ou=LVS7500Permissions,ou=LVS P

- Double-click ActiveDirectoryAuthentication in the Setting column.

Section	Setting	Value
System	ActiveDirectoryAuthentication	1=ON

- Click the **Value** drop-down box and select **1=ON**.

Note: To disable Active Directory, select **0=off**. When Active Directory is disabled, user permissions are managed in the LVS-7510 software (for more information, refer to Welcome Screen Overview → Administration → Operators).

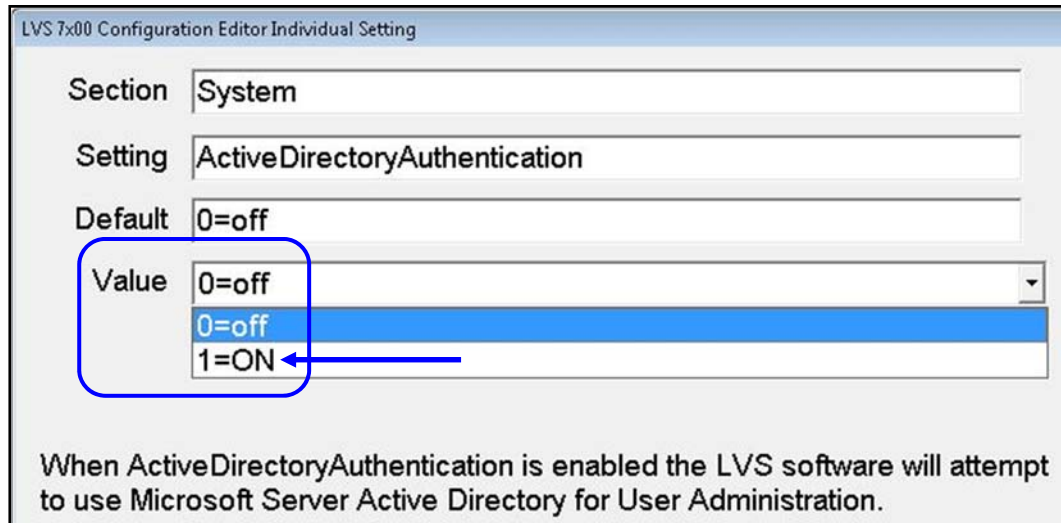

LVS 7x00 Configuration Editor Individual Setting

Section: System

Setting: ActiveDirectoryAuthentication

Default: 0=off

Value: 0=off (selected), 1=ON (highlighted with blue arrow)

When ActiveDirectoryAuthentication is enabled the LVS software will attempt to use Microsoft Server Active Directory for User Administration.

- Click the “OK (save changes)” button.
- Click the “X” in the top right corner of the “LVS-7510 Configuration Editor” screen.
- Click “Yes” to save changes in the “Save Changes” window.
- Shut down and then restart the LVS-7510 software. Upon restart, Active Directory will be enabled.

Active Directory Configuration Settings

Refer to the table below for a description of each Active Directory configuration setting.

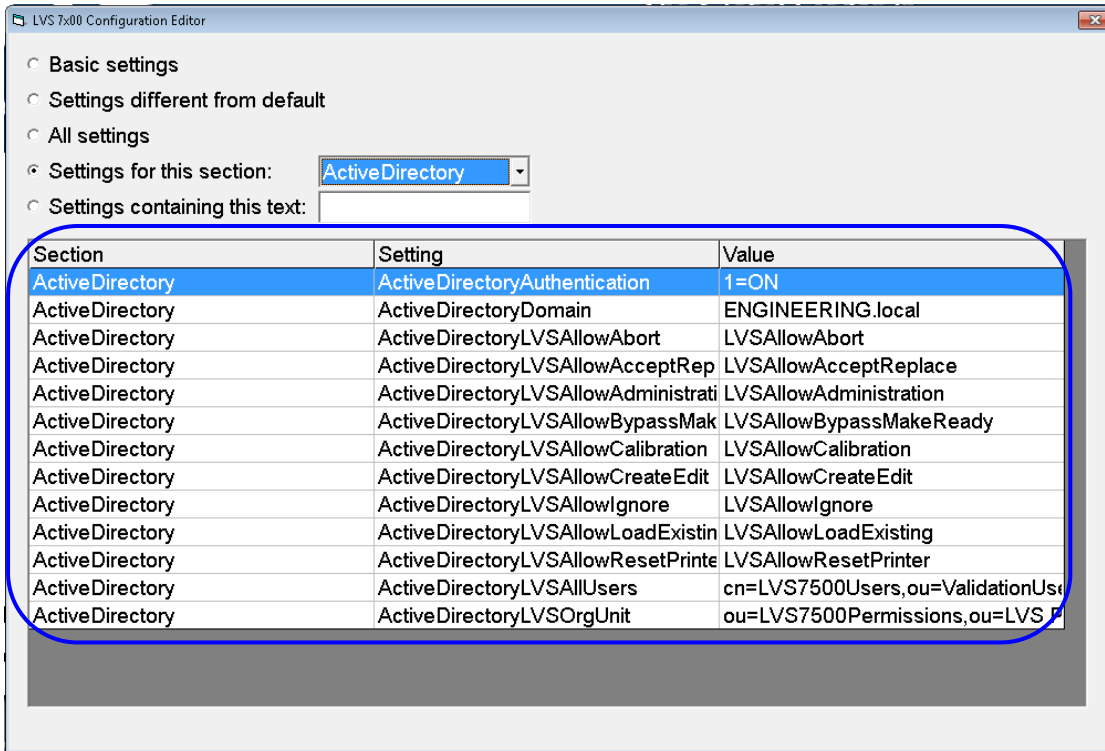

Setting	Description	Options/Values/Examples
ActiveDirectoryAuthentication	Enables Active Directory control of users and user permissions.	1=ON, 0=OFF
ActiveDirectoryDomain	Name of the Microsoft® Active Directory Domain	Example value: lvs-inc.com
ActiveDirectoryLVSAAllowAbort	Allows the operator the ability to abort the execution of a job after a validation error is detected and the "Printing Stopped Error Message" is displayed.	Active Directory Security Group containing all users or groups of users to be granted "Allow Abort" permission on the LVS-7510 system. Example: LVSAAllowAllowAbort
ActiveDirectoryLVSAAllowAcceptReplace	Allows the operator to accept or replace errors.	Active Directory Security Group containing all users or groups of users to be granted "Allow Accept / Replace Errors" permission on the LVS-7510 system. Example: LVSAAllowAcceptReplace

Setting	Description	Options/Values/Examples
ActiveDirectoryLVSAAllowAdministration	Allows the operator access to the "Administration" menu bar feature where operators and operator permissions are setup.	Active Directory Security Group containing all users or groups of users to be granted "Allow Administration" permission on the LVS-7510 system. Example: LVSAAllowAdministration
ActiveDirectoryLVSAAllowBypassMakeReady	Allows the operator the ability to use the "Bypass" and "MakeReady" buttons on the Running screen.	Active Directory Security Group containing all users or groups of users to be granted "Allow Bypass / MakeReady" permission on the LVS-7510 system. Example: LVSAAllowMakeReady
ActiveDirectoryLVSAAllowCalibration	Allows the operator to perform calibration.	Active Directory Security Group containing all users or groups of users to be granted "Allow Calibration" permission on the LVS-7510 system. Example: LVSAAllowCalibration
ActiveDirectoryLVSAAllowCreateEdit	Allows the operator to create, edit and delete a job.	Active Directory Security Group containing all users or groups of users to be granted "Allow Create NEW Job / Edit" permission on the LVS-7510 system. Example: LVSAAllowCreateEdit The value entered should be a member of the value entered for ActiveDirectoryLVSOrgUnit.
ActiveDirectoryLVSAAllowIgnore	Allow the operator the ability to ignore a label validation error after the "Printing Stopped Error Message" is displayed. Printing will continue with the next label in the job.	Active Directory Security Group containing all users or groups of users to be granted "Allow Ignore" permission on the LVS-7510 system. Example: LVSAAllowIgnore
ActiveDirectoryLVSAAllowLoadExisting	Allows the operator to load and execute existing jobs. This permission does not allowed to user to edit existing jobs.	Active Directory Security Group containing all users or groups of users to be granted "Allow Load

Setting	Description	Options/Values/Examples
		<p>EXISTING Job” permission on the LVS-7510 system.</p> <p>Example: LVSAAllowLoadExisting</p> <p>The value entered should be a member of the value entered for ActiveDirectoryLVSOrgUnit.</p>
ActiveDirectoryLVSAAllowResetPrinter	Allows the operator to send a reset printer signal from the LVS-7510 to the connected printer.	<p>Active Directory Security Group containing all users or groups of users to be granted “Allow Reset Printer” permission on the LVS-7510 system.</p> <p>Example: LVSAAllowResetPrinter</p>
ActiveDirectoryLVSAAllUsers	Group containing all domain users to be granted permissions on the LVS-7510.	<p>Active Directory Security Group containing all users to be created on the LVS-7510 system.</p> <p>Example: LVS7500Users</p> <p>The value entered can be located outside of the Omron Microscan Organizational Unit object if desired. The full path should be provided using standard Active Directory object naming syntax. See “Example 1” below for more information.</p> <p>Example: cn=LVS7500Users,ou=ValidationUsers.</p>
ActiveDirectoryLVSOrgUnit	Logical Organizational Unit that contains all of the Omron Microscan Permission Groups.	<p>Active Directory Organizational Unit containing all of the other LVS-7510 Permission Groups. The full path should be provided using standard Active Directory object naming syntax. See “Example 2” below for more information.</p> <p>Example: ou=LVS7500Permissions,ou=LVS Permissions,ou=LVS Systems</p>

Example 1:

The entry for **ActiveDirectoryLVSAIIUsers** must be formatted using standard Active Directory syntax. For example:

- **LVS7500Users** is a Group and begins with **cn=**
- **ValidationUsers** is an Organizational Unit and begins with **ou=**
- **cn=LVS7500Users,ou=ValidationUsers**

The above example is correct given the objects displayed in the following Active Directory window:

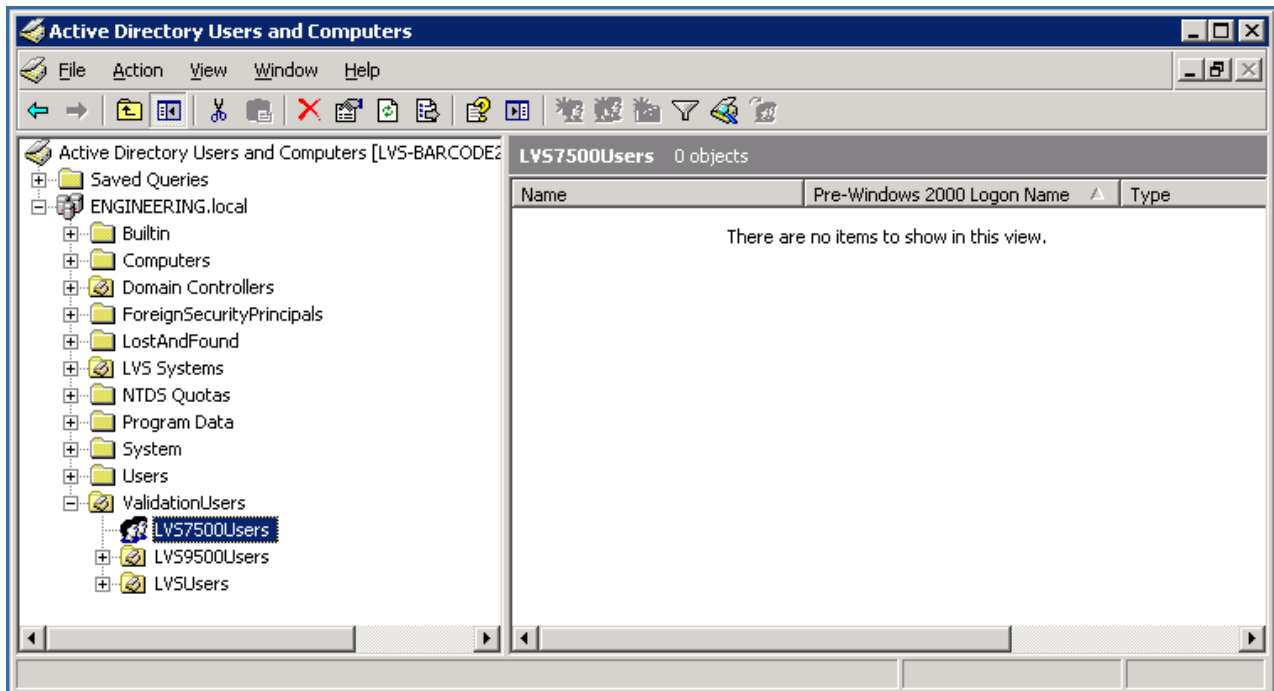

Example 2:

The entry for **ActiveDirectoryLVSOrgUnit** must be formatted using standard Active Directory syntax. The example below is correct given the objects displayed in the Active Directory window below.

- ou=LVS7500Permissions,ou=LVS Permissions,ou=LVS Systems

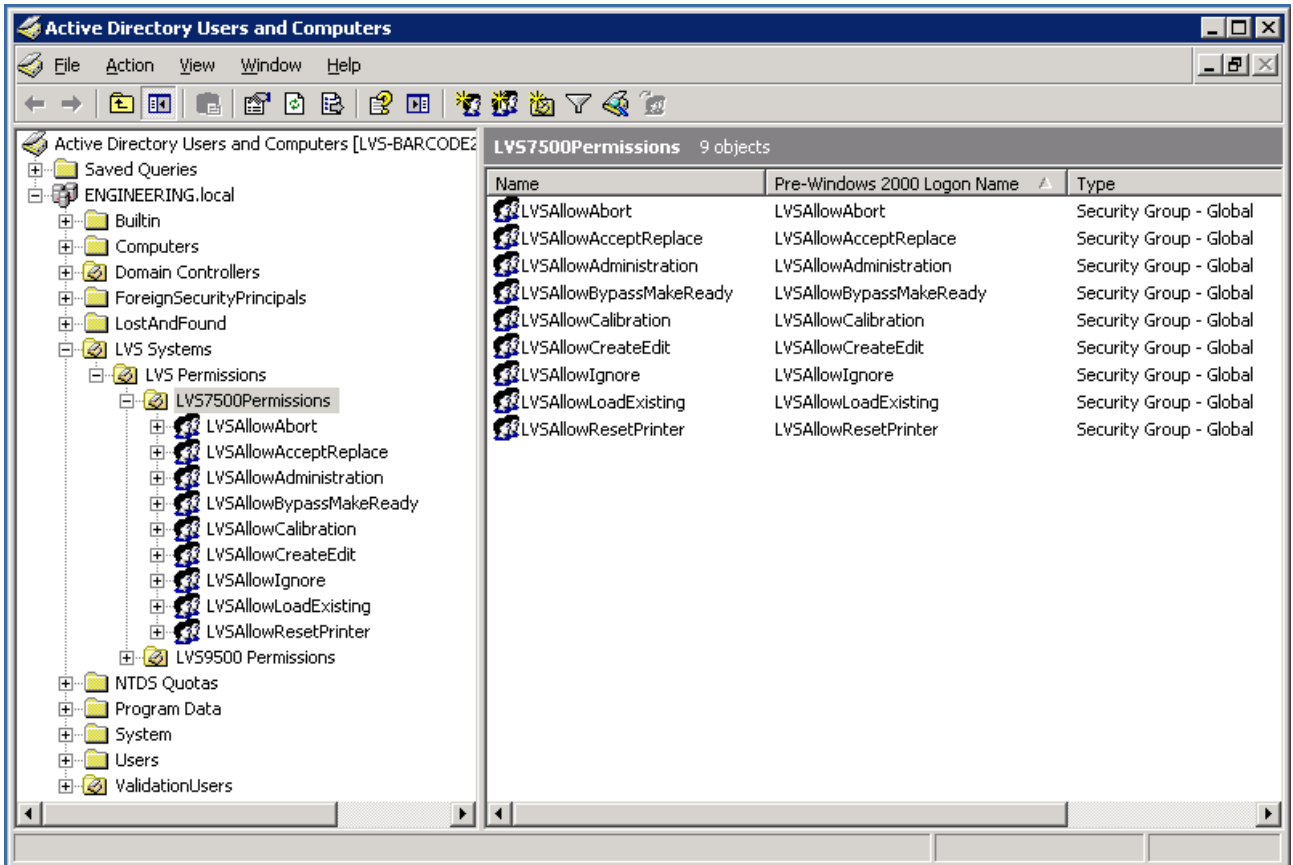

Active Directory User Permissions

When Microsoft® Active Directory (AD) is enabled the LVS-7510 user permissions are managed in AD. Also, user passwords, password expiration dates, and failed password counts are managed in AD.

The default administrator account (admin) is a special, unique login. It is not managed in AD and remains in the local LVS-7510 system database. All new installations create a default administrator user with the User Name and Password set to **admin**. The admin user password is stored in the local LVS-7510 system database to allow access to the system in case there is a network outage. This provides the option of operating the system without AD user authentication. With AD enabled, the admin user is the only user that can be modified using the LVS-7510 system Operator Administration interface. The admin user name and password can be changed and deleted if desired; however, if the admin user name is changed or deleted and the system loses connection to the Active Directory Server or Active Directory is disabled, then no user will exist who has access to enable Active Directory or manage users in a standalone mode.

When AD is enabled the **Operator Administration** screen allows you to only view the operators and operator permissions which were created from Microsoft® Active Directory settings. Operator names, permissions and passwords cannot be changed from the LVS-7510 Operator Administration interface.

1. Select **Administration** → **Operators** from the menu bar.

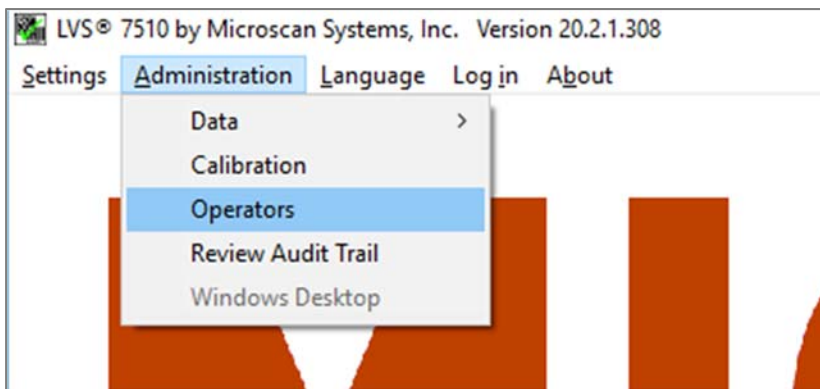

2. When Active Directory is enabled, the **Operator Administration** screen allows you to view the operators and operator permissions which were created from Active Directory settings.

Active Directory Enabled appears at the top of the screen to let you know that Active Directory is enabled; this message does not appear when Active Directory is disabled.

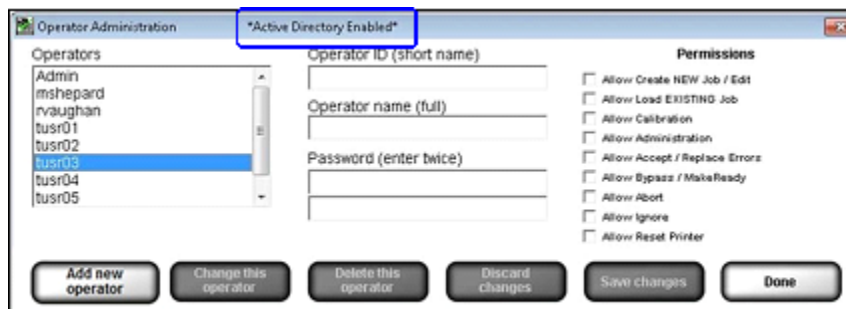

3. The buttons at the bottom of the Operator Administration screen are grayed out and disabled to prevent changes to users from the LVS-7510 software. The exception is the Admin user account, it can be modified using the Operator Administration screen.

4. The buttons available at the bottom of the screen are described below.

Option	Description
Add new operator	Click this button to add a new operator. Complete the following fields: <ul style="list-style-type: none"> • Operator ID (short name) • Operator name (full name) • Password (enter twice). Each password must consist of the following: <ul style="list-style-type: none"> ○ At least 8 characters ○ At least 1 letter from A to Z ○ At least 1 number from 0 to 9 • Select the desired permissions • Click Save changes to save your changes or Discard changes to discard and not save your changes
Done	Click this button after all changes are complete.

5. User permissions are described below:

Permission	Description
Allow Create / Edit NEW Job	Allows the operator to create, edit, and delete a job.
Allow Load EXISTING Job	Allows the operator to load and execute existing jobs. This permission does not allow the user to edit existing jobs.
Allow Calibration	Allows the operator to perform calibration.
Allow Administration	Allows the operator access to the “Administration” menu bar feature where operators and operator permissions are set up. See the “Administration” section for more information (Welcome Screen Overview > Administration)
Allow Accept / Replace Errors	Allows the operator to accept or replace errors.
Allow Bypass / MakeReady	Allows the operator the ability to use the “Bypass” and “MakeReady” buttons on the Running screen.
Allow Abort	Allows the operator the ability to abort the execution of a job after a validation error is detected and the “Printing Stopped Error Message” is displayed.
Allow Ignore	Allows the operator the ability to ignore a label validation error after the “Printing Stopped Error Message” is displayed. Printing will continue with the next label in the job.
Allow Reset Printer	Allows the operator to send a reset printer signal from the LVS-7510 to the connected printer.

Appendix G: TCP/IP Control

Basic Production mode functionality of the LVS-7510 can be controlled using a TCP/IP command set. This provides customers and third party integrators a mechanism for developing custom HMI interfaces using TCP/IP bi-directional communication with the LVS-7510 system to automate production job execution. To prepare the LVS-7510 system to accept TCP/IP commands, there are user configurable software settings; refer to the following section for details on implementing the required settings: Appendix A: User Configurable Settings → List of User Configurable Settings → TCP/IP.

TCP/IP Configuration Settings

Setting: Options: Default:	Host none 0.0.0.0	Leave as default value.
Setting: Options: Default:	Mode off Remote XML off	Mode indicates if the LVS-7510 is connecting to another system. Use "off" if the LVS-7510 is not connecting to another system. Use "Remote" if the LVS-7510 is connecting with a remote computer, such as the Omron Microscan HMI Command Center or a non-Omron Microscan system. All remaining settings (such as Host, Port1, Port2, etc.) do not apply if the LVS-7510 is not connecting to another system.
Setting: Options: Default:	Port1 none 0	Enter the port where the first external system will be listening for Omron Microscan data.
Setting: Options: Default:	Port1Filter none none	Specifies the type of information that the LVS-7510 system will broadcast on the port specified by Port1. This filter is for output from the LVS-7510 only. Leave this blank to receive all information from the LVS-7510 system. Enter a comma separated list of Binary Command Byte ID#'s to receive only the feedback information desired.
Setting: Options: Default:	Port2 none 0	Enter the port where the second external system will be listening for Omron Microscan data.
Setting: Options: Default:	Port2Filter none none	Specifies the type of information that the LVS-7510 system will broadcast on the port specified by Port2. This filter is for output from the LVS-7510 only. Leave this blank to receive all information from the LVS-7510 system. Enter a comma separated list of Binary Command Byte ID#'s to receive only the feedback information desired.

Below is an example of the setting to configure an LVS-7510 to accept TCP/IP commands:

```
Mode=remote
Host=0.0.0.0
Port1=8001
Port1Filter=1,2,3,4,5,7,8,11,12,13,14,28,29
```

The example for Port1Filter will tell the LVS-7510 to broadcast all outputs and input command responses except the IP Status (31).

TCP/IP Commands and Output Data Summary

Name	Binary Command Byte ID#	Description	External Command	Data Output
Load Job	1	Load the currently loaded job.	X	
Start Run	2	Start running the currently loaded job.	X	
Stop Run	3	Stop running.	X	
Start Bypass	4	Enter Bypass mode if the system is currently running.	X	
End Bypass	5	Exit from Bypass mode.	X	
Sector Error	7	Data output from the LVS-7510 system with this command byte ID# will include information about a failed sector inspection. If multiple sectors fail during a given repeat, there will be a unique sector error output message for each individual sector.		X
Log Line	8	Data output from the LVS-7510 system with this command byte ID# will include all inspection information from every sector for the given repeat.		X
Continue Run	11	Continue the last run of the currently loaded job.	X	
Make Ready	12	Enter Make Ready mode.	X	
Reset Alarms	13	Reset the alarms.	X	
Exit To Main	14	Exit from the currently loaded job to the main screen.	X	
Close out job	15	Close out the currently loaded job.	X	
Import Job	16	Import the job from the Import folder.	X	
Load Job from Archive	17	Load job from the Archive folder.	X	
Set Match to File Path	18	Set the match to file path when a match to file is in use	X	
Set MatchTo	28	Enter the current match-to strings to replace the given field designator.	X	
Reset Available	29	Query the LVS-7510 system to discover if the Reset Alarms button is active (used prior to a Reset Alarms command).		X
IP Status	31	Continuous status data updates from the LVS-7510 system.		X

TCP/IP Commands Protocol

The TCP/IP Commands sent to an LVS-7510 have the following format:

<Binary Command Byte ID#><ASCII String>

Where:

- **<Binary Command Byte ID#>** is the unique command ID associated with the desired operation. Refer to the following sections for the binary command byte IDs for each support LVS-7510 command. The commands are sent as binary bytes **not ASCII**. An example of a binary command to import a job would be a byte value 0x16 hex. The production command to import a job is: 0x16 "Jobname0221."
- **<ASCII String>** consists of command-specific data, if applicable. An example of command-specific data in the previous example would be the job name. The text string "Jobname0221" is the job name and would be loaded if it existed in the Import folder.

The response from the LVS-7510 system will have the following format if the operation is successful:

<Binary Command Byte ID#>

Where <Binary Command Byte ID#> will be identical to the command ID that the LVS-7510 received. For example, if the command to import a job named "Jobname0221" was sent.

0x16 "Jobname0221"

If the job was successfully imported the response from the LVS-7510 would be the command byte that was sent: 0x16

The response from the LVS-7510 will have the following format if the operation fails:

<Binary Command Byte ID#><ASCII String>

<Binary Command Byte ID#> will be identical to the command ID that the LVS-7510 received.

<ASCII String> is an ASCII string describing the error. If the job name did not exist in the Import folder, the response from the LVS-7510 would be:

0x16 ERROR: Job not found in import folder

Load Job

The “Load Job” command will load the desired job on all connected LVS-7510 systems. The command format is:

<Binary Command Byte ID#><ASCII String>

For the “Load Job” command, the <Binary Command Byte ID#> is equal to a binary 1 (0x01 hex), and the <ASCII String> designates the name of an existing job. The command format is then:

<0x01 hex><Existing Job Name>

The LVS-7510 response when the command completes successfully would be:

<0x01 hex>

The LVS-7510 response when the command fails would be:

<0x01 hex><ASCII Error Message>

Start Running

The “Start Running” command will start the currently loaded job on the LVS-7510 system. The command format is:

<Binary Command Byte ID#><ASCII String>

For the “Start Job” command, the <Binary Command Byte ID#> is equal to a binary 2 (0x02 hex), and the <ASCII String> is blank. The command format is then:

<0x02 hex>

The LVS-7510 response when the command completes successfully would be:

<0x02 hex>

The LVS-7510 response when the command fails would be:

<0x02 hex><ASCII Error Message>

Stop Running

The “Stop Running” command will stop the desired job on the LVS-7510 system. The command format is:

<Binary Command Byte ID#><ASCII String>

For the “Stop Running” command, the <Binary Command Byte ID#> is equal to a binary 3 (0x03 hex), and the <ASCII String> is blank. The command format is then:

<0x03 hex>

The LVS-7510 response when the command completes successfully would be:

<0x03 hex>

The LVS-7510 response when the command fails would be:

<0x03 hex><ASCII Error Message>

Continue Last Run

The “Continue Last Run” command is valid only after a job has been loaded. Sending this command will initiate inspections and the results will be appended to the most recent run file (CSV file) instead of creating a new run. The command format is:

<Binary Command Byte ID#>

For the “Continue Last Run” command, the <Binary Command Byte ID#> is equal to a binary 11 (0x0b hex), and the <ASCII String> is blank. The command format is then:

<0x0b hex>

The LVS-7510 response when the command completes successfully would be:

<0x02 hex>

The LVS-7510 response when the command fails would be:

<0x0b hex><ASCII Error Message>

Make Ready

The “Make Ready” command is valid only after a job has been loaded. Sending this command will load initiate Make Ready mode for the currently loaded job. The command format is:

<Binary Command Byte ID#>

For the “Make Ready” command, the <Binary Command Byte ID#> is equal to a binary 12 (0x0c hex), and the <ASCII String> is blank. The command format is then:

<0x0c hex>

The LVS-7510 response when the command completes successfully would be:

<0x0c hex>

The LVS-7510 response when the command fails would be:

<0x0c hex><ASCII Error Message>

Start Bypass

The “Start Bypass” command is valid only after a job has been loaded and is currently running. Sending this command will put the LVS-7510 system into Bypass mode. The command format is:

<Binary Command Byte ID#><ASCII String>

For the “Start Bypass” command, the <Binary Command Byte ID#> is equal to a binary 4 (0x04 hex), and the <ASCII String> is blank. The command format is then:

<0x04 hex>

The LVS-7510 response when the command completes successfully would be:

<0x04 hex>

The LVS-7510 response when the command fails would be:

<0x04 hex><ASCII Error Message>

End Bypass

The “End Bypass” command is valid only after a job has been loaded and is currently running in Bypass mode. Sending this command will take the LVS-7510 system out of Bypass mode and back into normal run mode. The command format is:

<Binary Command Byte ID#><ASCII String>

For the “End Bypass” command, the <Binary Command Byte ID#> is equal to a binary 5 (0x05 hex), and the <ASCII String> is blank. The command format is then:

<0x05 hex>

The LVS-7510 response when the command completes successfully would be:

<0x05 hex>

The LVS-7510 response when the command fails would be:

<0x05 hex><ASCII Error Message>

Reset Alarms

The “Reset Alarms” command is the equivalent of clicking the “Reset alarms” button on the LVS-7510 system. The command format is:

<Binary Command Byte ID#><ASCII String>

For the “Reset Alarms” command, the <Binary Command Byte ID#> is equal to a binary 13 (0x0d hex), and the <ASCII String> is blank. The command format is then:

<0x0d hex>

The LVS-7510 response when the command completes successfully would be:

<0x0d hex>

The LVS-7510 response when the command fails would be:

<0x0d hex><ASCII Error Message>

Note: The LVS-7510 system will send a TCP/IP packet containing the “Reset Available” binary command byte whenever the Reset button is available to the user. This occurs when an error is detected and the alarm is triggered. The “Reset Available” binary command byte ID is a binary 29 (0x1d hex). The “Reset Alarms” command will be ignored until the LVS-7510 sends the “Reset Available” message via TCP/IP.

Exit To Main

The “Exit To Main” command is valid only after a job has been loaded and is not currently running nor in Bypass or MakeReady mode. Sending this command will return the LVS-7510 system to the main Welcome window. The command format is:

<Binary Command Byte ID#><ASCII String>

For the “Exit To Main” command, the <Binary Command Byte ID#> is equal to a binary 14 (0x0e hex), and the <ASCII String> is blank. The command format is then:

<0x0e hex>

The LVS-7510 response when the command completes successfully would be:

<0x0e hex>

The LVS-7510 response when the command fails would be:

<0x0e hex><ASCII Error Message>

Close Out Job

The “Close Out Job” command will close the currently loaded job on all connected LVS-7510 systems. All job-related files are zipped up, removed from the Jobs folder and the jobname.zip file is move to the Archive folder. The command format is:

<Binary Command Byte ID#><ASCII String>

For the “Close Out Job” command, the <Binary Command Byte ID#> is equal to a binary 1 (0x0f hex), and the <ASCII String> is blank. The command format is then:

<0x0f hex>

The LVS-7510 response when the command completes successfully would be:

<0x0f hex>

The LVS-7510 response when the command fails would be:

<0x0f hex><ASCII Error Message>

Import Job

The “Import Job” command will import the desired job on all connected LVS-7510 systems. The command format is:

<Binary Command Byte ID#><ASCII String>

For the “Import Job” command, the <Binary Command Byte ID#> is equal to a binary 16 (0x10 hex), and the <ASCII String> designates the name of an existing job. The command format is then:

<0x10 hex><Job Name to import>

The LVS-7510 response when the command completes successfully would be:

<0x10 hex>

The LVS-7510 response when the command fails would be:

<0x10 hex><ASCII Error Message>

Load Job From Archive

The “Load Job from Archive” command will recall the desired job from the Archive folder onto all connected LVS-7510 systems. The command format is:

<Binary Command Byte ID#><ASCII String>

For the “Load Job from Archive” command, the <Binary Command Byte ID#> is equal to a binary 17 (0x11 hex), and the <ASCII String> designates the name of a job in the Archive folder. The command format is then:

<0x11 hex><Job Name from Archive>

The LVS-7510 response when the command completes successfully would be:

<0x11 hex>

The LVS-7510 response when the command fails would be:

<0x11 hex><ASCII Error Message>

Set Match To

The “Set Match To” command sets the “Match this text” string of OCR, OCV, barcode grade or barcode read sectors. To use this feature, a field designator text string is entered into the “Match this text” setting in each sector. The field designator is a unique string identifier that is replaced at runtime when the “Set Match To” command is sent to the LVS-7510 system. Multiple sectors may have the same field designator entered in the “Match this text” field. The command format is:

<Binary Command Byte ID#><ASCII String>

For the “Set Match To” command, the <Binary Command Byte ID#> is equal to a binary 28 (0x1c hex), and the <ASCII String> indicates the name of the field designator and the desired match to string separated by the vertical bar character “|”. The command format is then:

<0x1c hex><Field Designator Name>|<Match To String>

The LVS-7510 response when the command completes successfully would be:

<0x1c hex>

The LVS-7510 response when the command fails would be:

<0x1c hex><ASCII Error Message>

Example: The field designator “REF_NBR” has already been entered in the “Match this text” field for the desired sectors in the job.

Step 5: Setup matching

Number of characters: Variable

Field mask:

Accept everything (do not match)

Match this text:

Match data in sector: Majority at position

Ascending base:

Descending step:

Prompt when run is started:

Match to file

Check for duplicates

To replace the field designator “REF_NBR” with “ABC123” at run time send the following “Set Match To” command:

```
<0x01c hex><"REF_NBR|ABC123">
```

The field designator can be any string up to 25 characters as long as the Match To command contains the exact same string as the Field Designator Name.

Set the Match to file path

The “Set Match to File Path” command will set the match to file path when a match to file is in use. Send the full path including directory path. The command format is:

```
<Binary Command Byte ID#><ASCII String>
```

For the “Set Match to File Path” command, the <Binary Command Byte ID#> is equal to a binary 18 (0x12 hex), and the <ASCII String> designates the full path to an existing match to file including file name and extension. The command format is then:

```
<0x12 hex><Match to file path>
```

The LVS® 7X00 response when the command completes successfully would be:

```
<0x12 hex><ASCII NULL (0x00 hex)>
```

The LVS® 7X00 response when the command fails would be:

```
<0x12 hex><ASCII Error Message><ASCII NULL (0x00 hex)>
```

TCP/IP Output Data Protocol

Output data from the LVS-7510 is broadcast upon the occurrence of an event, such as an error in a sector inspection. The connected system can choose to use the data as it sees fit.

The TCP/IP data output from the LVS-7510 have the following general format:

<Binary Command Byte ID#><ASCII String>

<Binary Command Byte ID#> is the unique command ID associated with the particular data contained in the output – and – **<ASCII String>** consists of command-specific data (if any).

Sector Error

The “Sector Error” data output occurs for each sector that fails an inspection. The repeat number, timestamp and distance are sent along with the sector ID number, the special error marker character (ASCII 161) and error code, and any other sector-specific data. The command format is:

<Binary Command Byte ID#><ASCII String>

For the “Sector Error” command, the **<Binary Command Byte ID#>** is equal to a binary 7 (0x07 hex), and the **<ASCII String>** is given below. The data output format is then:

<0x07 hex><ASCII String>

Where the comma separated ASCII String =

<RepeatNumber>,<Timestamp>,<Distance>,<SectorID>,<ErrorMarker><SectorResultData>

Note: There is no comma between the special error marker character (ASCII 161) and the sector results data.

Log Line

The “Log Line” data output occurs once for each repeat and includes all of the data stored in the run file for that repeat, including all sector inspection results. The repeat number, timestamp and distance are sent along with the inspection results for each sector starting with sector #1 and continuing through the last sector present. The special error marker character (ASCII 161) is inserted immediately prior to the sector result data for any sector that fails an inspection. The command format is:

<Binary Command Byte ID#><ASCII String>

For the “Log Line” command, the **<Binary Command Byte ID#>** is equal to a binary 8 (0x08 hex), and the **<ASCII String>** is given below. The data output format is then:

<0x08 hex><ASCII String>

Where the comma separated ASCII String =

<RepeatNumber>,<Timestamp>,<Distance>,<Sector 1 ResultData>,<Sector 1 ResultData>, , <Sector X ResultData>

Note: If one of the sectors failed an inspection, then the special error marker character (ASCII 161) is placed immediately prior to the sector results data and there is no comma between the special error marker character (ASCII 161) and the sector results data. The special warning marker (ASCII 191) is present in lieu of the error marker in the event that an inspection triggers a warning rather than a failure.

Reset Available

The “Reset Available” data output occurs every time the “Reset Alarms” button becomes active. This happens when an inspection triggers an error for which the LVS-7510 is configured to output an alarm. A connected system would know that when this message is received that the Reset Alarm command may now be sent to the LVS-7510. The command format is:

<Binary Command Byte ID#>

For the "Reset Available" command, the <Binary Command Byte ID#> is equal to a binary 29 (0x1d hex). The data output format is then:

<0x1d hex>

IP Status

The "IP Status" output occurs 20 times a second while the LVS-7510 is running a job. This information is usually unnecessary to remote systems. The information included under this binary command byte ID# is the current lines per second, feet per minute, camera speed, CPU usage, pass sector counter, fail sector count, total sector count, label repeat count, and display color. Each of these items is separated by the vertical bar character "|". The command format is:

<Binary Command Byte ID#><ASCII String>

For the "IP Status" command, the <Binary Command Byte ID#> is equal to a binary 31 (0x1f hex). The data output format is then:

<0x1f hex><ASCII String>

Where the ASCII String is:

<LinesPerSecond>|<FeetPerMinute>|<CameraSpeed>|<CPU>|<PassSectorCount>|<FailSectorCount>|<TotalSectorCount>|<LabelRepeatCount>|<DisplayColor>

Appendix H: LVS-7510 Printronix Integrated System

The information in this appendix is intended for users of the LVS-7510 Printronix Integrated system used in conjunction with the Printronix T8000r thermal barcode printer.

Printing Stopped Error Message

As the LVS-7510 is validating labels, a failed label will be overstruck and reprinted. If the label fails a second time, the label will be overstruck and reprinted again. After three consecutive errors of the same type are detected (except Foreground and Background errors), the printer stops printing labels and the “Printing Stopped” message appears (see below).

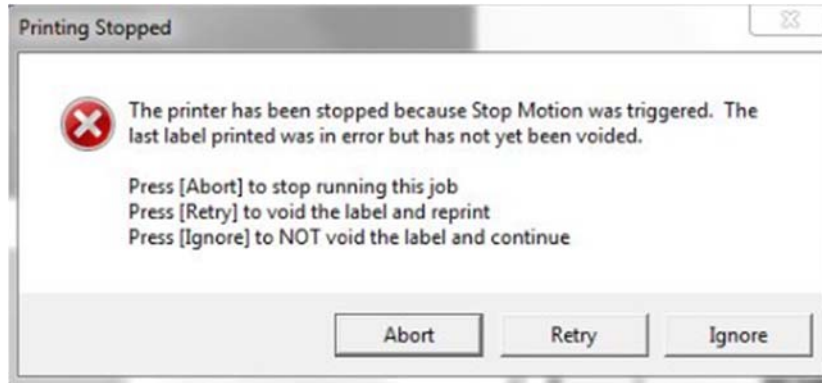

Note: The text appearing in the “Printing Stopped” message can be edited in the “BeforeAbort.txt” file. See the section further in this appendix entitled “Customizing the *Printing Stopped* and *Manual Intervention Required* Messages” for instructions.

Options include:

- **Abort** – Stops running the job. After clicking this button, Production mode users are prompted to login. After logging in, the “Manual Intervention Required” message appears (see below). The user must be granted the “Allow Abort” permission to allow the LVS-7510 to stop running the job.



“Manual Intervention Required” message

Note: The text appearing in the “Manual Intervention Required” message can be edited in the “AfterAbort.txt” file. See the section entitled “Customizing Error Messages” for instructions.

IMPORTANT: After aborting a print job, there may be print data remaining in the printer's memory buffer. If granted the "Allow Reset Printer" permission, a user can reset the printer to accept new print data. For detailed instructions, refer to the "Reset the Printer" section further in this appendix.

- **Ignore** – Ignores the failed label and continues printing the next label in the job. After clicking this button, Production mode users are prompted to log in. The user must be granted the "Allow Ignore" permission to allow the LVS-7510 to ignore the failed label and continue printing the next label in the job.
- **Retry** – Voids the label and reprints the label. If the label fails, the "Printing Stopped" message appears. There is no user permission associated with the "Retry" option.

Foreground and Background Errors

The three consecutive errors works differently for Foreground and Background errors. When a Foreground and Background error occur on the same label, a single counter is set by the larger of the two errors. Whichever of the Foreground or Background errors for that label repeat is larger will set/index the counter. This means that if there are both a Foreground and a Background error(s) on the same label, the bigger error (Foreground or Background) sets/indexes the counter. All errors are recorded but only the largest Foreground or Background error affects the counter. The result is three Foreground errors are allowed (i.e. will not stop the process) if a Background error accompanies any of the Foreground errors and the Background error is larger than the corresponding label's Foreground error. Additionally, three Background errors are allowed (i.e. will not stop the process) if a Foreground error accompanies any of the Background errors and the Foreground error is larger than the corresponding label's Background error.

Printing Timeout Error

The following message appears when a printing timeout has occurred: "Queue up more labels to resume printing and the message will automatically go away. Or, push the "Stop" button to stop the run."



Reset the Printer

Sometimes the printer will stop printing for no apparent reason (like after aborting a print job) and there may be print data remaining in the printer's memory buffer. To reset the printer back to a state where it is ready to accept new print data, follow the steps below. A user must be granted the "Allow Reset Printer" permission to reset the printer.

1. Using the Printronix printer's console buttons, take the printer offline, clear the printer's buffer, and place the printer back online.
2. The LVS-7510 software must be at the "Ready to run" screen.
3. Hold down the [Alt] keyboard button and click the "Print Job" button in the top, right corner of the "Ready to run" screen. When the "Print Job" button is not active, ALT + R performs this function also.
4. Enter your login credentials. The "Confirm Reset Printer" message appears.



5. Click the "OK" button. The printer will reset and form feed a few label.

Customizing the “Printing Stopped” and “Manual Intervention Required” Messages

To change the text appearing in the “Printing Stopped” and “Manual Intervention Required” error messages, follow the steps below. Windows Administrator access is required.

1. Open Windows Explorer and access the following path:
C:\Program Files (x86)\LVS 7510.
2. Copy the file(s) “AfterAbort.txt” or “BeforeAbort.txt” to your desktop (or another preferred location). The “AfterAbort.txt” file contains the text appearing in the “Manual Intervention Required” message. The “BeforeAbort.txt” file contains the text appearing in the “Printing Stopped” message.

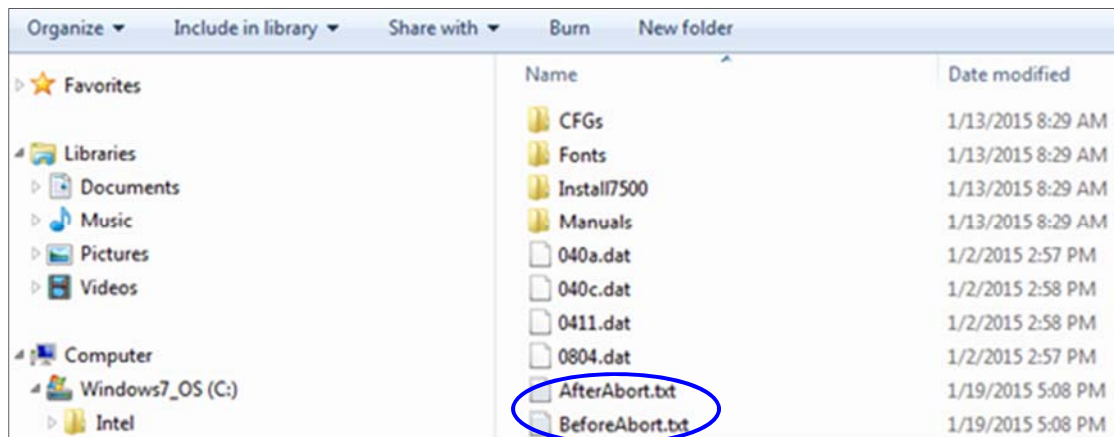

3. Open the file in Notepad or another text editor program and make your changes. When changes are complete, save and then close the file.
4. Copy the files (“AfterAbort.txt” and/or “BeforeAbort.txt”) back to C:\Program Files (x86)\LVS 7510.
5. Shut down and then restart the LVS-7510 software for the error message changes to appear.

Form Feed Button

The “Form Feed” button advances all labels under the LVS-7510 readhead when printing is complete. ALT + F also performs this function.

Labels fed from the printer after the “Form Feed” button is pressed are not inspected by the LVS-7510.

The ability to form feed labels is available only after the LVS-7510 stops inspection (by pressing the “Stop” button). Form feeding labels is not available when a job is running or in MAKEReady mode.

To form feed labels:

1. Click the “Stop” button to stop label inspection.
2. Click the “Form Feed” button. The LVS-7510 readhead advances all remaining labels.



Appendix I: Print Job Button

The “Print Job” button allows you to view and print a PDF file of each job.

1. Click the “Print Job” button.



2. Select the job PDF file.

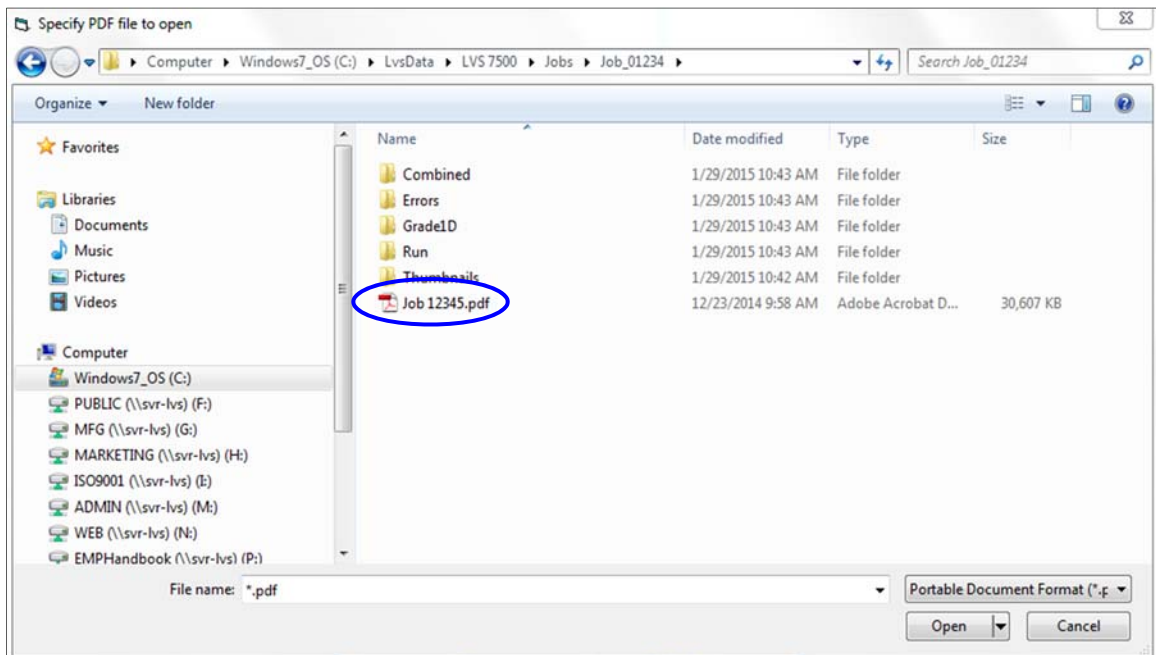

- The job opens in Adobe Acrobat. From the menu bar, select **File > Print**.

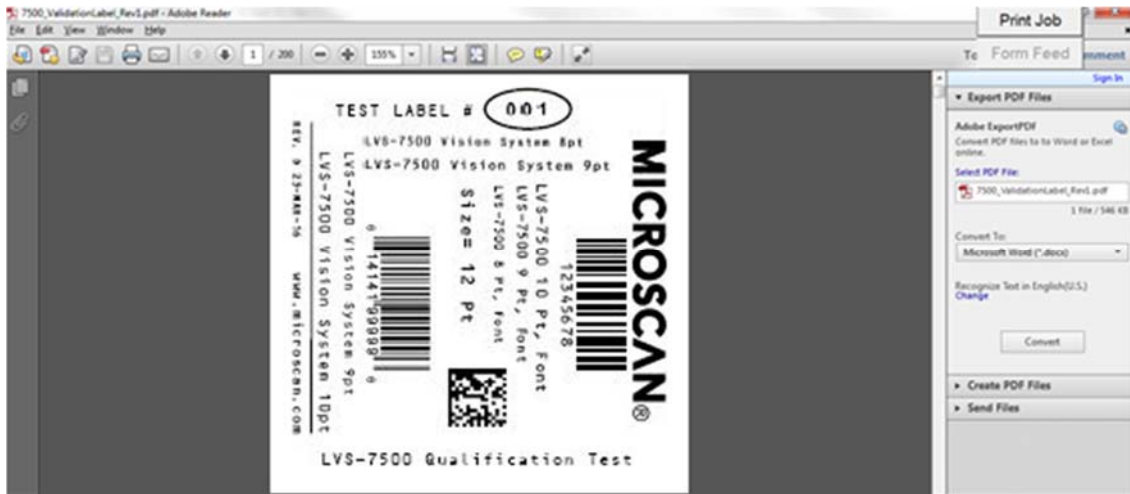

- You can print all the pages (labels) in the file or print selected pages. Select "All" to print all the pages in the file, or enter the desired page numbers to print in the "Pages" field.
 - You can specify a group of non-sequential pages by separating them by commas (example: 4, 8, 19)
 - You can specify a sequential range of pages by putting a dash between them (example: entering 4-7 will print pages 4 through 7)

Your version of Adobe Acrobat may appear differently than the image below.

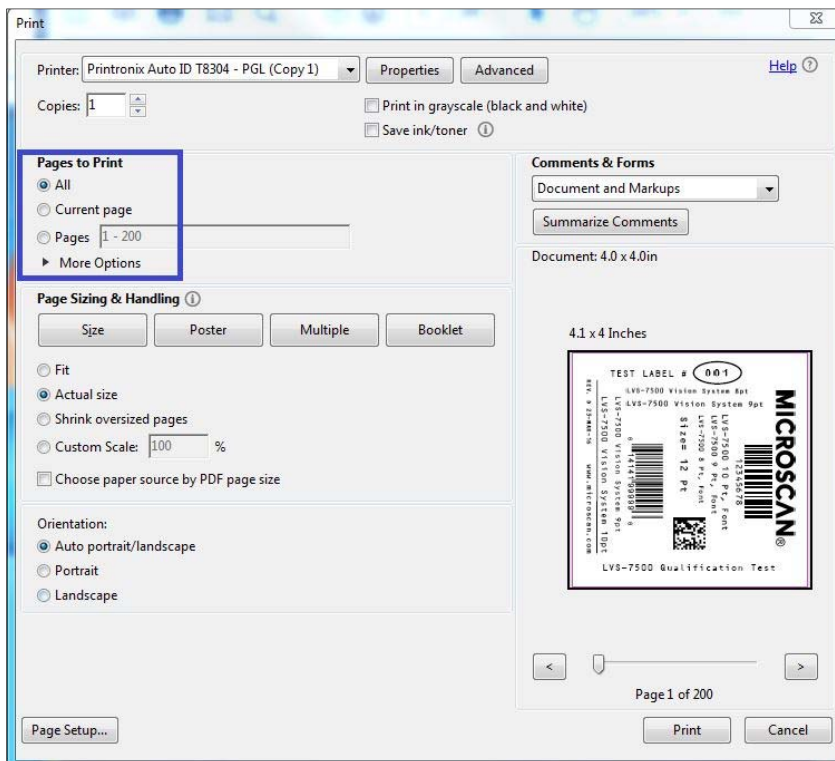

- Label templates are created in Design mode. To ensure the labels print as designed in Production mode, follow the steps below:
 - Click "Advanced."

- b. On the “Page Setup” tab, click “Advanced Options.”

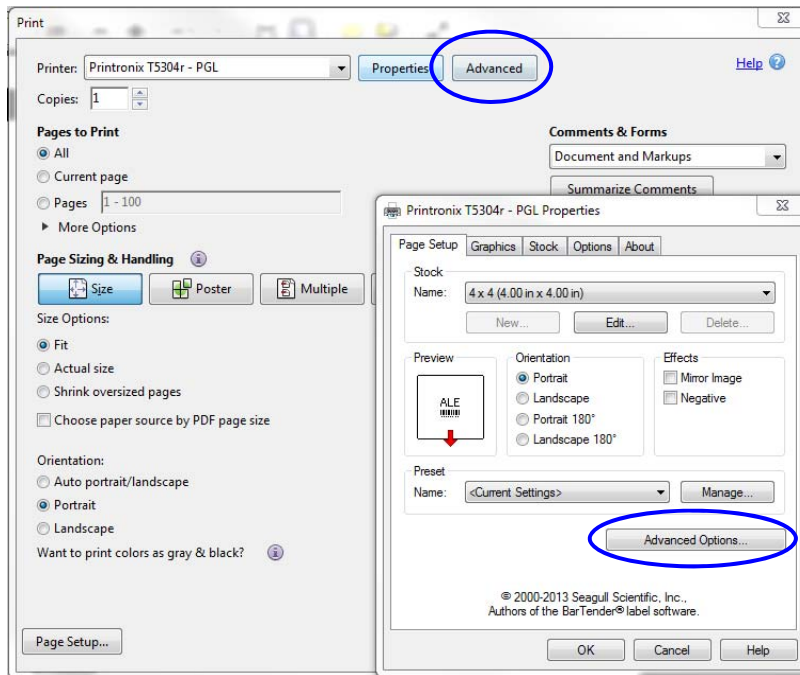

- c. Verify the “Horizontal Offset” and “Vertical Offset” settings in Production mode match the settings in Design mode. Click “OK.”

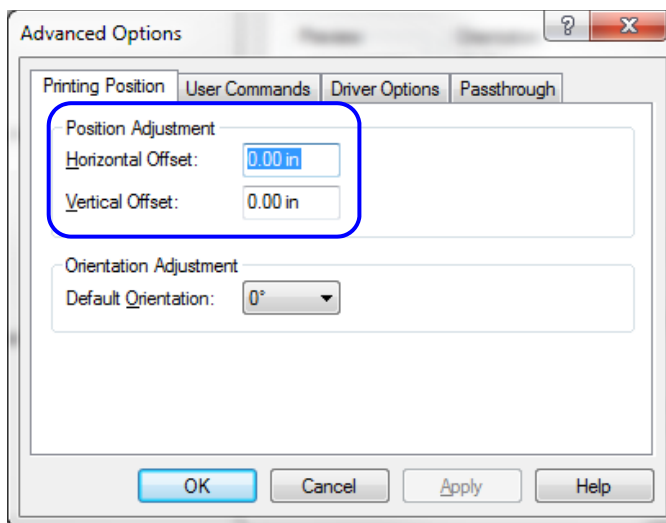

6. Click “Ok” on the remaining windows. The labels begin printing. When complete, close Adobe Acrobat.

Appendix J: Windows® Lockdown

The Windows Lockdown feature locks down a Windows operating system, thus keeping the system secure and preventing users from changing system settings. The Windows Lockdown feature supports Windows 7 Professional, and Windows 8.1 Professional and Windows 10 Professional,. Windows Vista is not supported.

To lockdown a Windows operating system, follow the steps below.

1. Open the LVS-7510 software and click login button. Enter Operator ID and password. NOTE: You must log in as a user who has "Allow Administration" permissions
2. In the main menu click **Administration** and then click **Operators**; the **Operator Administration** window appears.

3. Click the **Add new operator** button.
4. Type **windows** in the **Operator ID (short name)** field; letters are not case sensitive.
5. Type **windows** in the **Operator name (full)** field; letters are not case sensitive.
6. Type a user-defined password in the **Password** field. Do not lose or forget your password. Valid passwords contain at least eight (8) characters; at least one (1) letter from A to Z; and at least one (1) digit from 0 to 9.
7. The **Allow Administration** permission will automatically be selected.
8. Click the **Save changes** button.
9. The **Confirm Windows Lock Down** message appears (see below). Click **Yes**.

10. The **Reboot Required** message appears. Click **OK**.

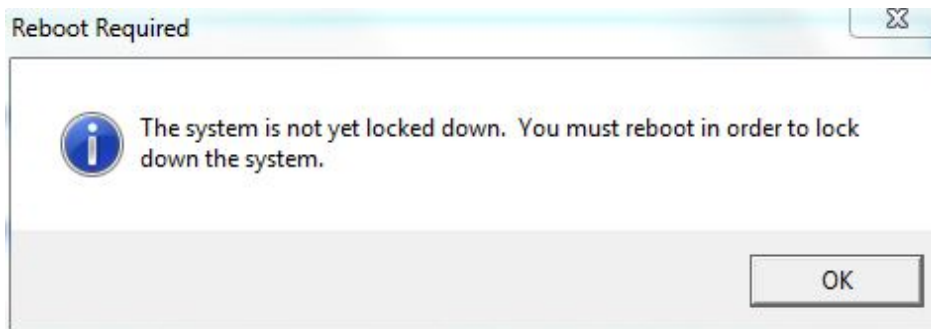

11. Click the **Done** button.
12. Close the LVS-7510 software and then restart the computer.
13. The computer is in lockdown mode. The LVS-7510 software will automatically run and open to the Welcome screen. All Windows® desktop functionality is disabled.

Shut Down the System

To shut down the system while Windows® is locked down:

1. Click the red X located in the top, right corner of the screen. The LVS-7510 software shuts down.
2. Press the computer's power button to shut down the system.

Unlock

To unlock a Windows® operating system, follow the steps below:

1. Log out of the LVS-7510 software by selecting "Log on" and "Log out" on the main menu.
2. Click the "Log in" button and login with the Windows lock down account.
 - Enter Windows as your Operator ID.
 - Enter your user-defined password.
 - Click the Ok button.
3. In the main menu click **Administration** and then click **Operators**; the **Operator Administration** window appears.
4. Select **Windows** from the Operator list and then click the **Delete this operator** button.

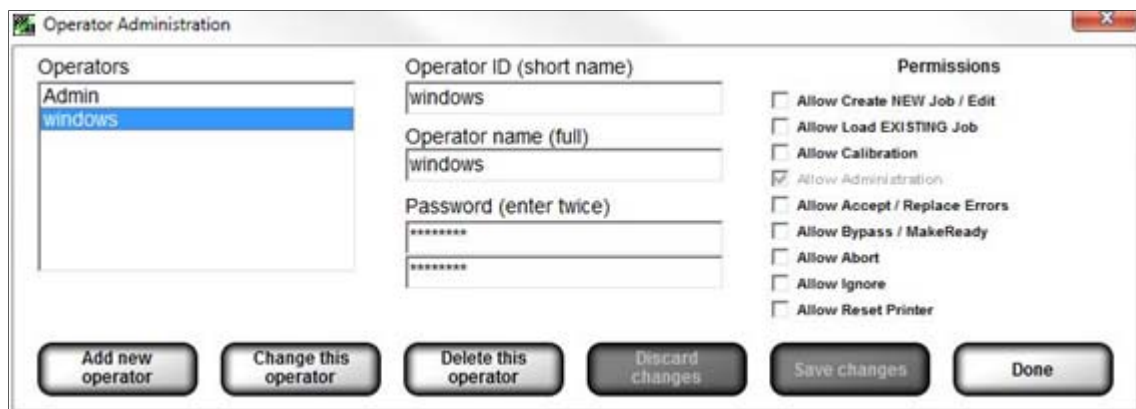

5. Click **Yes** when the **Confirm Windows Lock Down** message appears.
6. Click **OK** when the **Reboot Required** message appears.
7. Follow any other onscreen prompts.

8. Close the LVS-7510 software by clicking the red X located in the top, right corner of the screen; the screen turns blank.
9. Reboot the computer by pressing the computer's power button to shut down the system. After the system shuts down, press the computer's power button to turn on the system. When prompted, enter your desired Operator ID and Name to log on to the system.
10. The Windows® desktop is now unlocked and has returned to normal mode.

Appendix K: Using LVS-7510 PDF Comparator Function

Prior to using the PDF Comparator function, the 8-digit activation code for LVS-7510 must be entered. The 8-digit activation code is provided in printed and electronic form when ordering 98-9000079-01. To enter the code, open the LVS-7510 home screen and click CTRL + A to open the code activation screen. After entry of the 8-digit activation code for Feature Code 7014 (PDF Comparator), the LVS-7510 is ready to be used with the ScanProof software. Contact Omron Microscan Technical Support if further assistance is needed:

- Americas: Americas_support@microscan.com
- Europe: EMEA_support@microscan.com
- China: China_support@microscan.com
- Other Asia-Pacific Areas: APAC_support@microscan.com

Installing ScanProof™ Software

Step 1 — Install Software

NOTE: Windows **Administrator Access is mandatory** to perform this installation. See the ArtProof-ScanProof Installation Guide included on the USB drive shipped with this product (98-9000079-01).

1. Turn off User Access Control (UAC) settings in Windows. Click the Windows button. Type UAC in the search field and click enter.
2. Select Control Panel, then select User Accounts Control Settings.
3. Select Never Notify and click OK.
4. Reboot the computer.
5. Copy the zip file ("ScanProof.zip") from the supplied USB drive to the PC running LVS-7510 software.
6. Decompress the zip file and right click on the installation file, as described on page 29 of the ScanProof Installation Guide.
7. While installing Microsoft .NET Framework 4.5, a message will appear requesting a reboot. Click Restart Later.

See the ScanProof Installation Guide for details on the sequence of screens that are shown during a typical installation and required installation steps.

Step 2 — Initial Configuration

To create a configuration setup for Omron Microscan LVS-7510, locate the "Microscan.ini" file on the USB drive and copy it to: C:\Users\Public\ScanProof\Setups. NOTE: The ScanProof software must be installed (see Step 1 above) before this path is valid. Follow the adjustment instructions in the ScanProof Software User's Manual.

Launching ScanProof™ Software

Step 1 — Save Job

Create a NEW job in LVS software. In the Step 7 screen, enter a name for the new job. A description can also be entered. Click the “>>>” button to save the job.

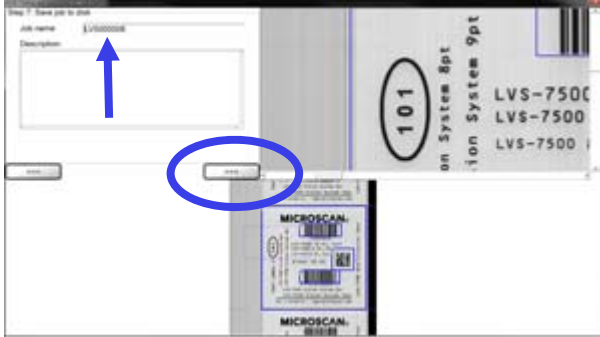

Click Yes when you see the dialog box shown at right:

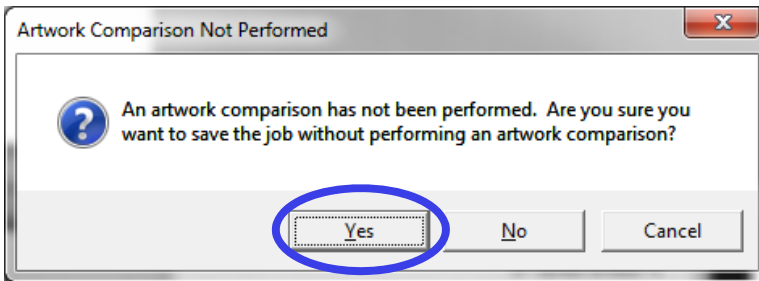

Step 2 — Edit Job

The Ready to run screen will appear. Click the upper right button of the Warning dialog box to close it. Then click Edit Job.

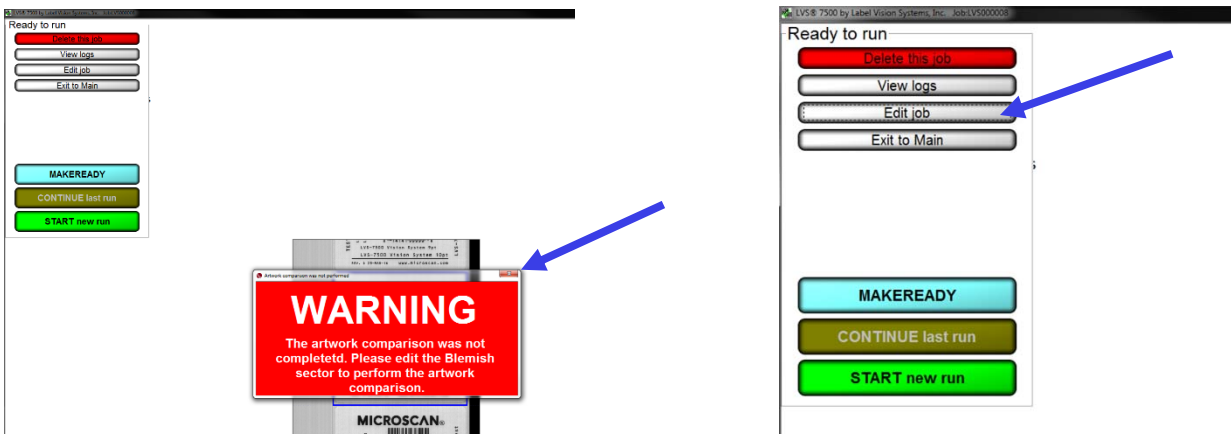

This will reopen the screen to create sectors. Click the “>>>” button to advance to the next screen.



Step 3 — Select the Master PDF

In the Step 4 screen, “Blemish settings”, click the **Correlate artwork** button.

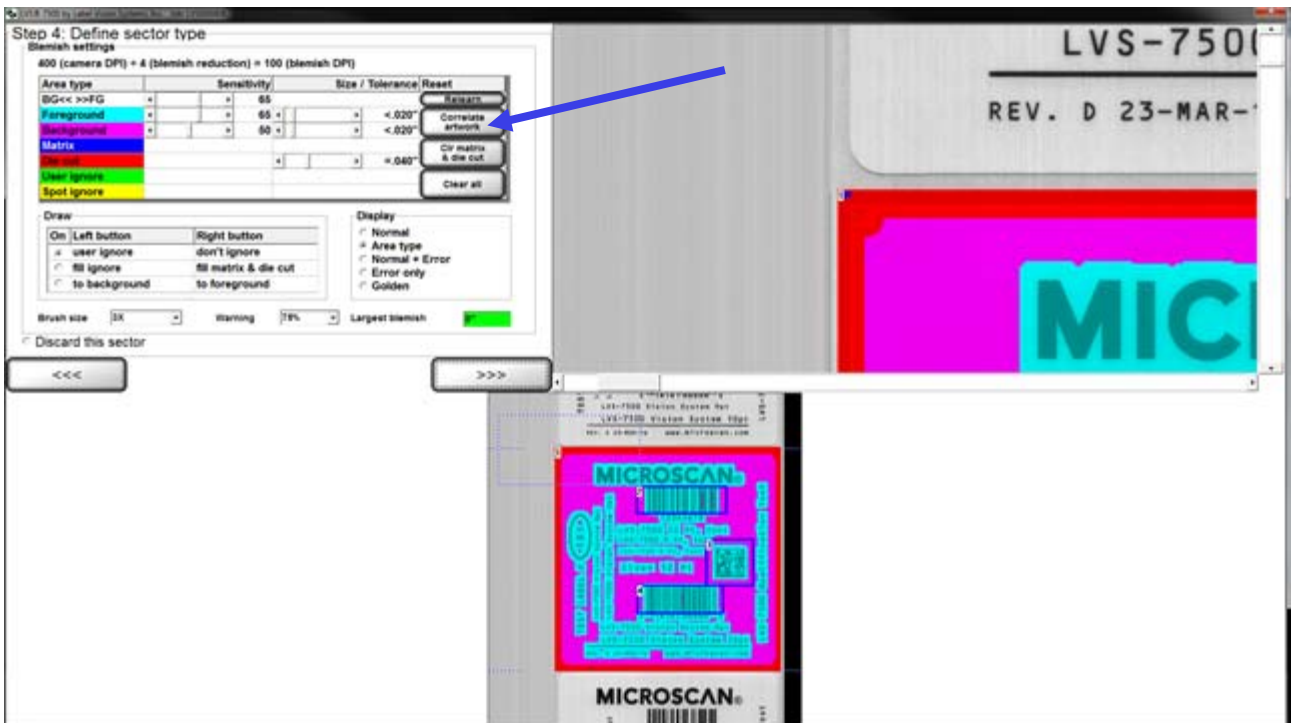

A browser window will open for you to select the Master PDF artwork file. Browse to the location of your Master PDF, select the file, and click Open.

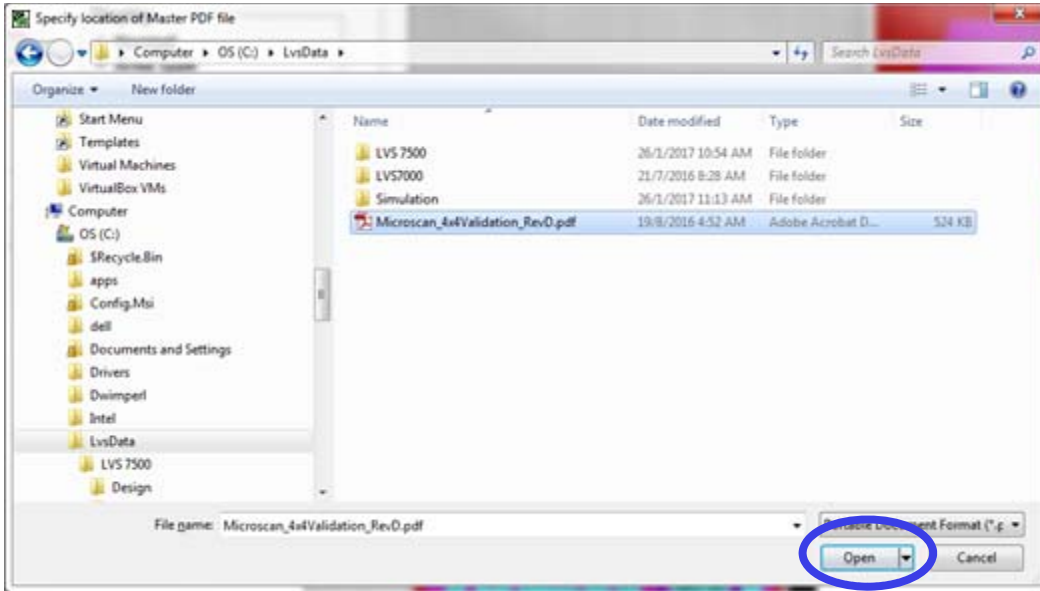

Step 4 — Open Master PDF in ScanProof

The LVS-7510 software becomes hidden. The ScanProof™ application will open and display the Master PDF artwork. If needed, use the Rotate buttons to orient the image.

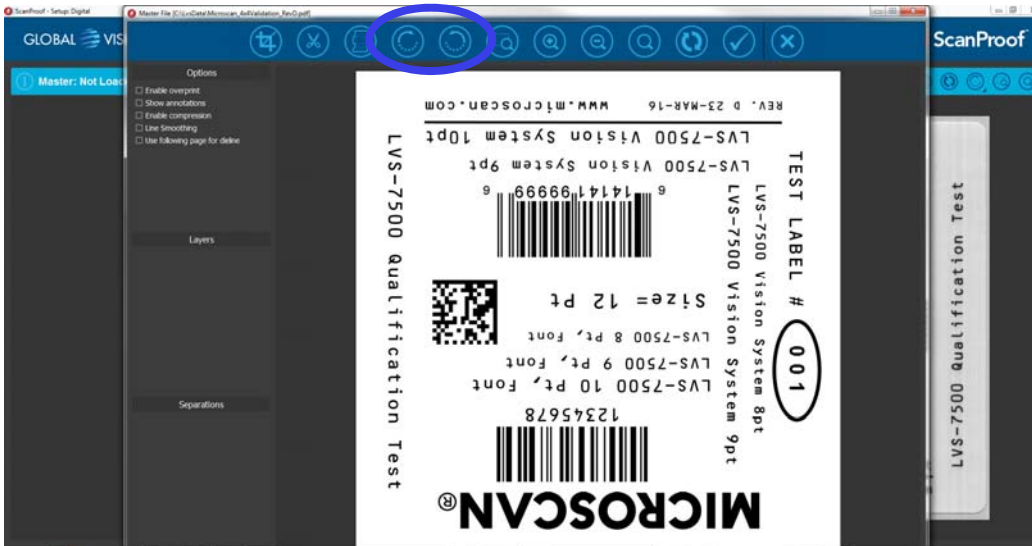

Click the Check Mark icon to confirm the Master PDF.

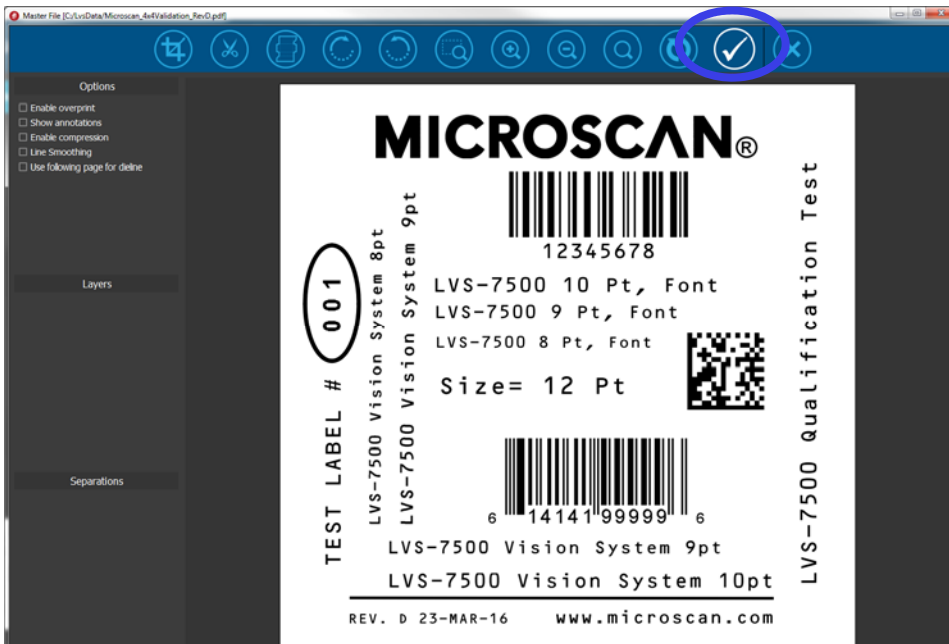

Step 5 — Run Comparison

Under the File Folder icon, select Setup, then Microscan.

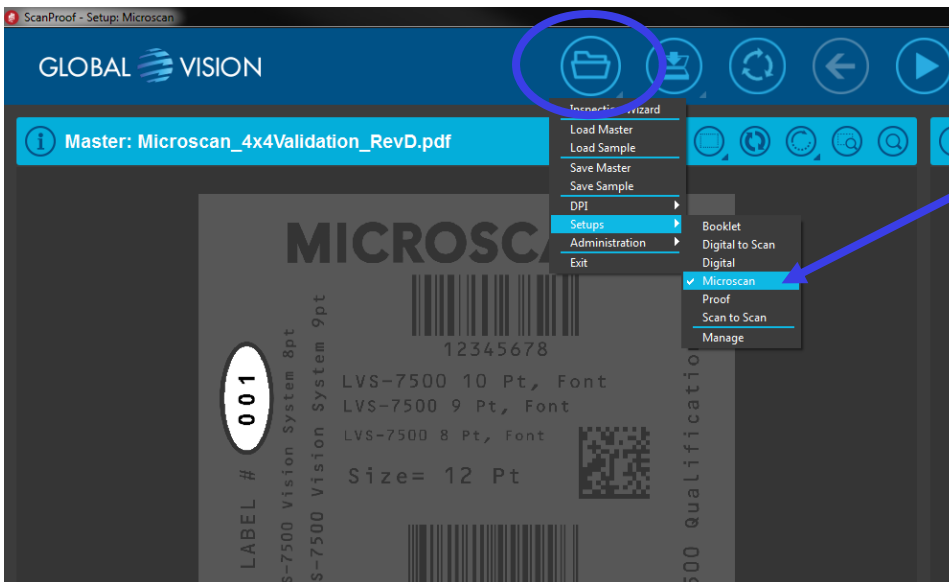

Click the Run icon to run the comparison between the Master PDF and the .BMP image of the sector created earlier.

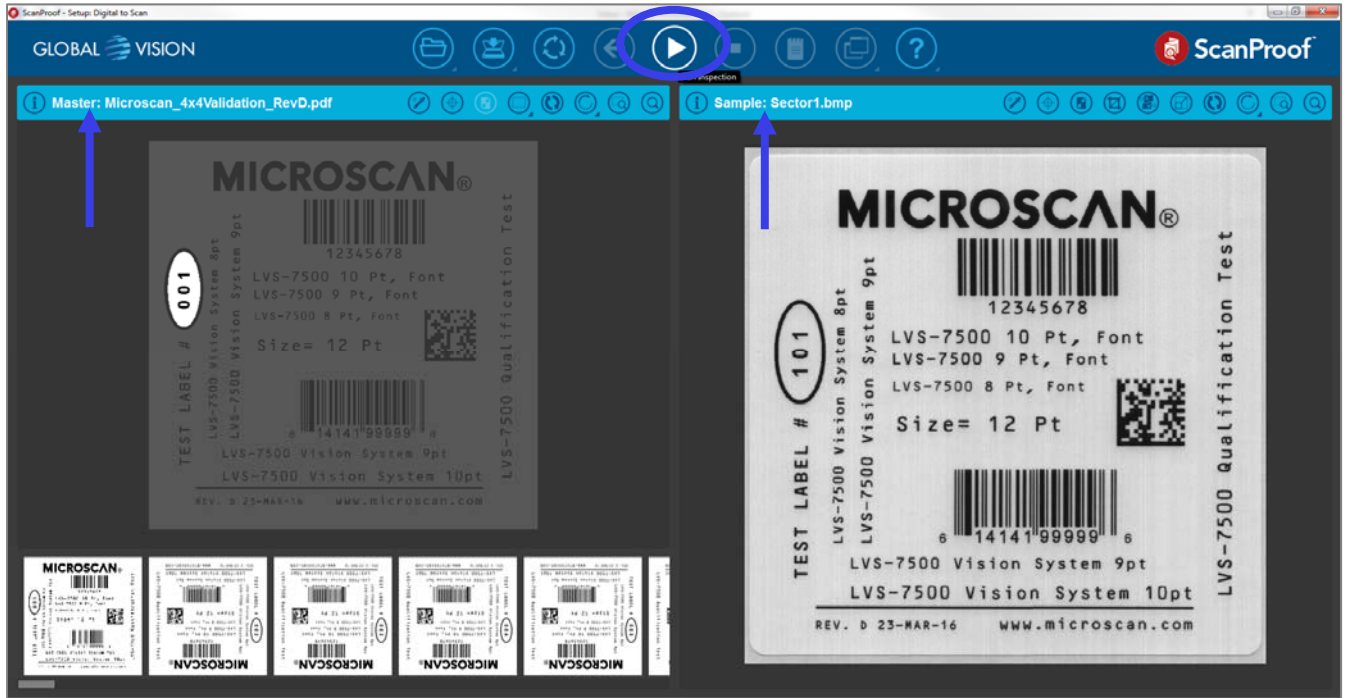

Step 6 — Review Differences

A list of differences between the labels, if any are found, will appear. You can review the details of each difference and enter a classification.

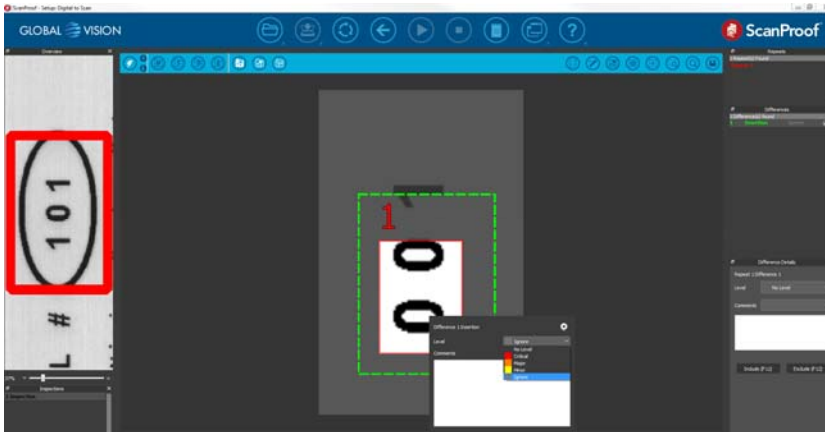

There are 4 classification levels: Critical, Major, Minor, and Ignore.

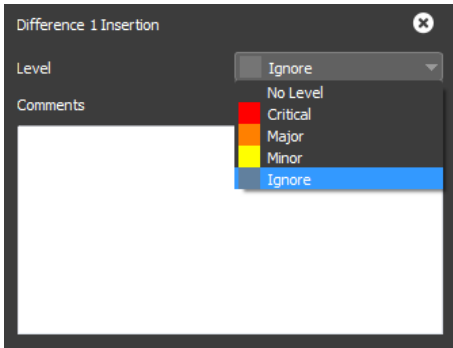

Step 7 — Set Status and Generate Report

Once you have completed the review, click the Generate Report icon.

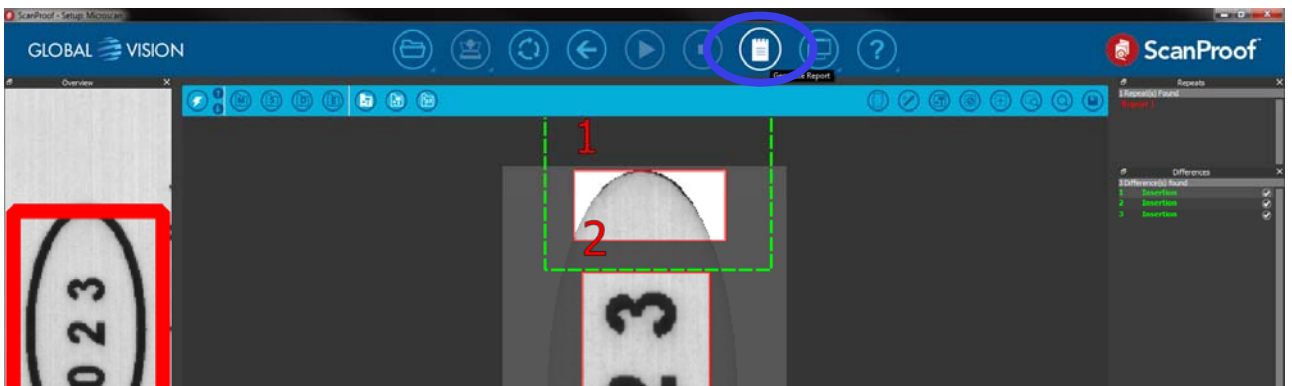

In the open dialog box, select a status of PASS or FAIL for the comparison.

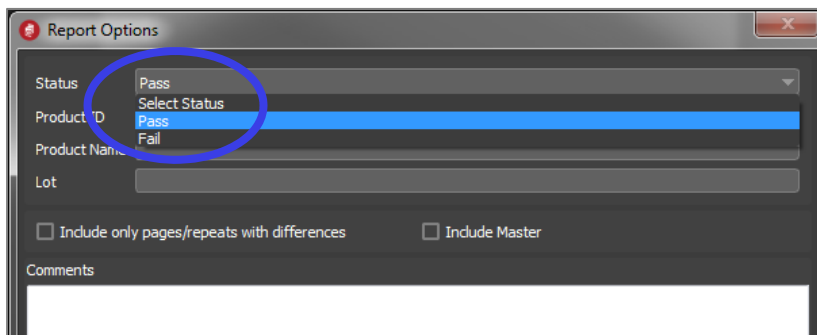

You may also complete additional fields such as Product ID, Product Name and Lot. Check the box to include an image of the Master PDF in the report. Click Save.

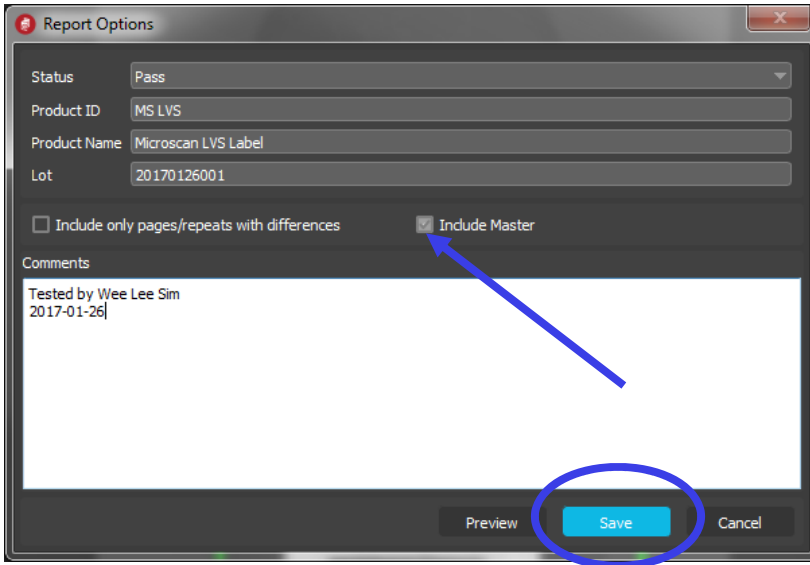

A browser window will open to select the folder location and file name of the report. The report should be saved in the job folder: C:\LvsData\LVS 7500\Jobs\LVS000007A\ArtworkComparison. Keep the report with the inspection job to ensure the LVS-7510 software is able to locate the report. Click Save to save the report.

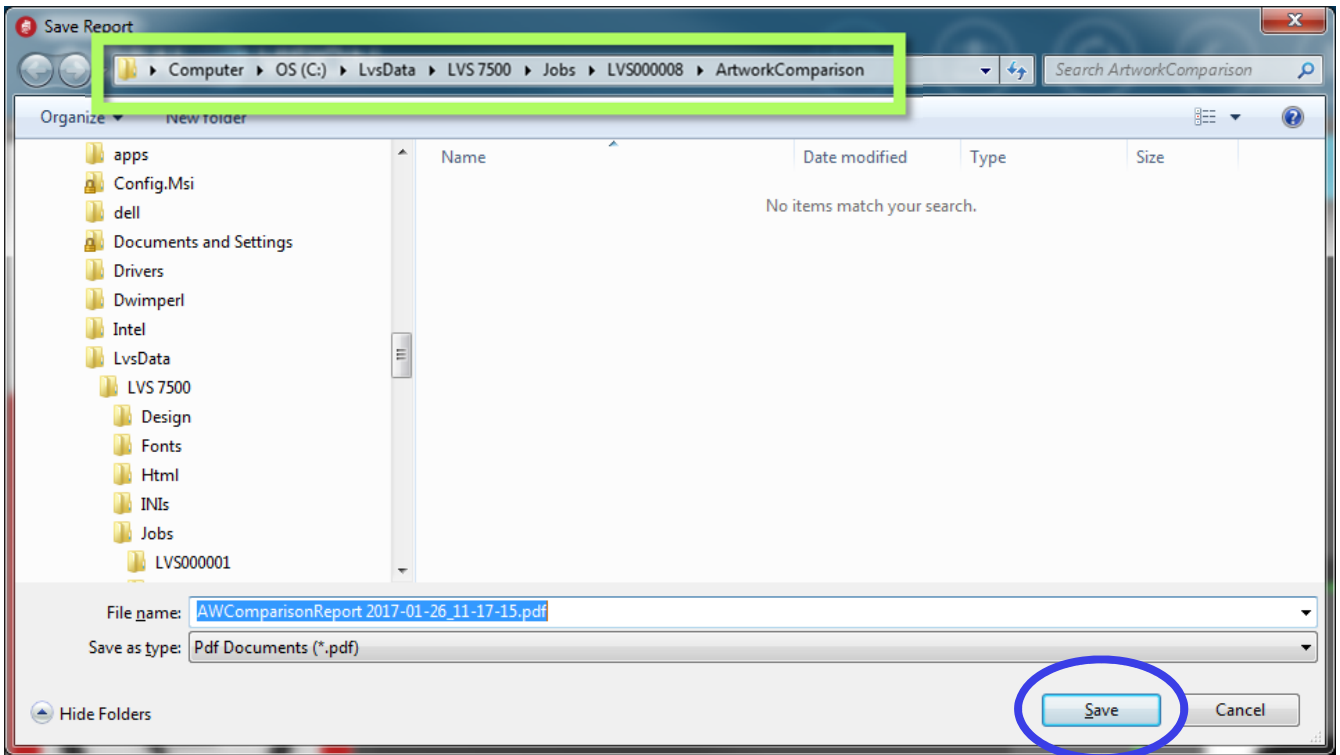

See an example of a ScanProof report below (pages 1-2 of a 5-page report):

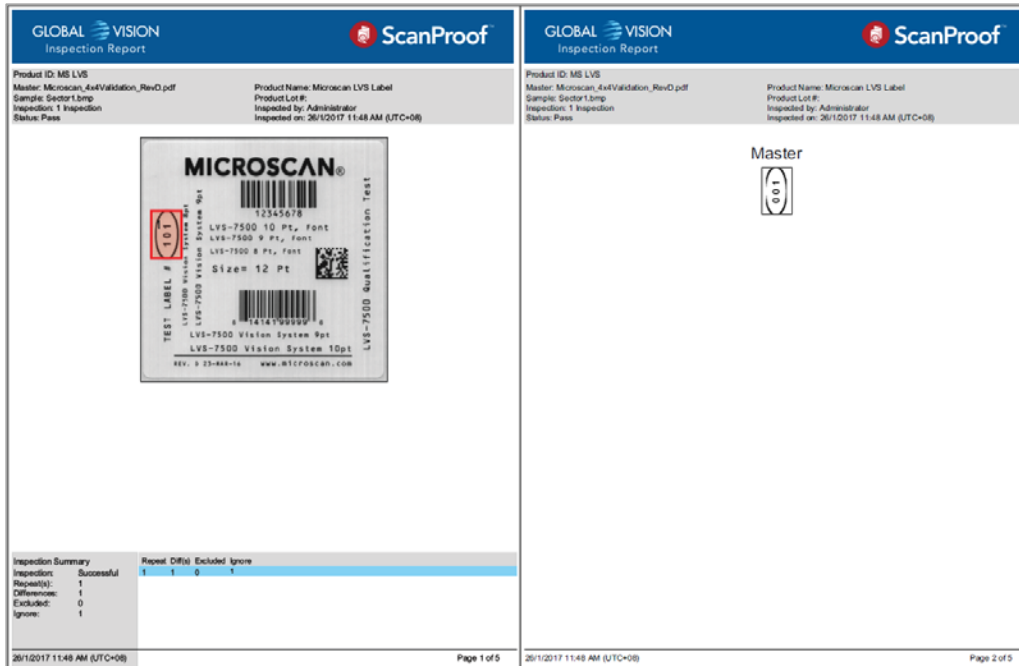

Step 8 — Return to LVS-7510 Software

Click the upper right button of the ScanProof application to close it. Click Yes to confirm.

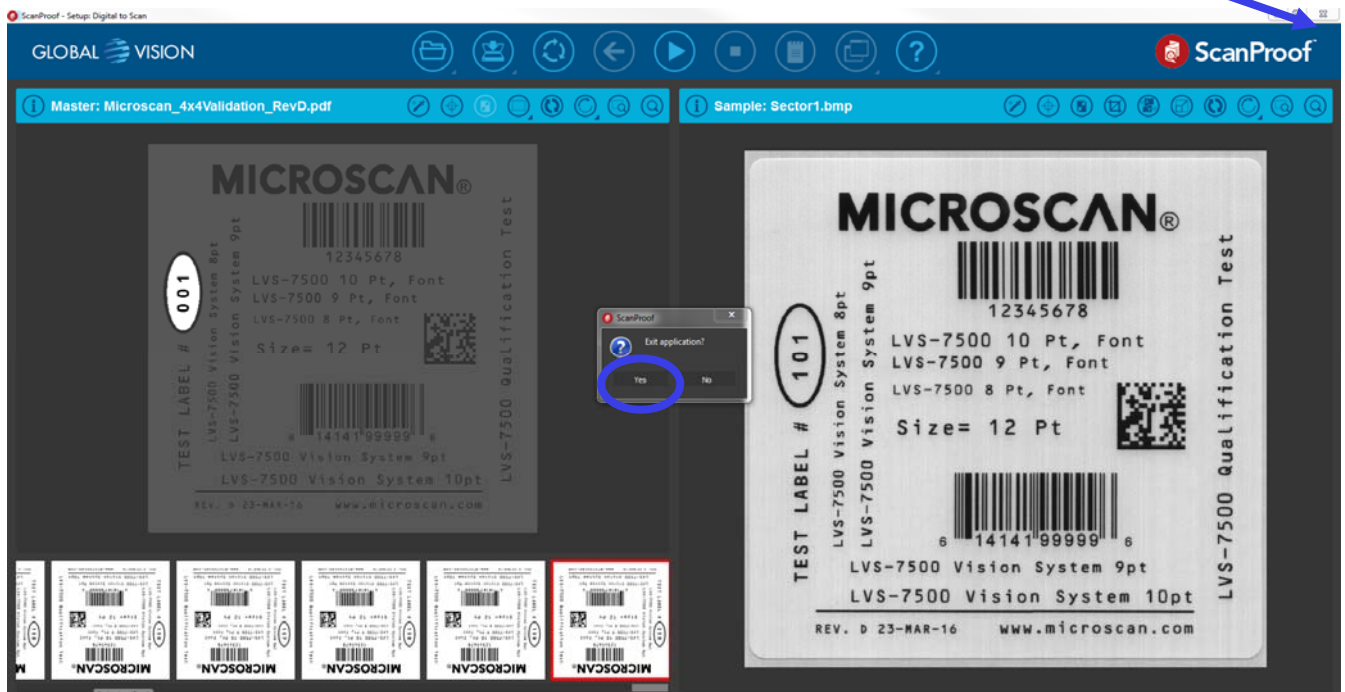

LVS-7510 software and Blemish settings screen will reappear once ScanProof closes.

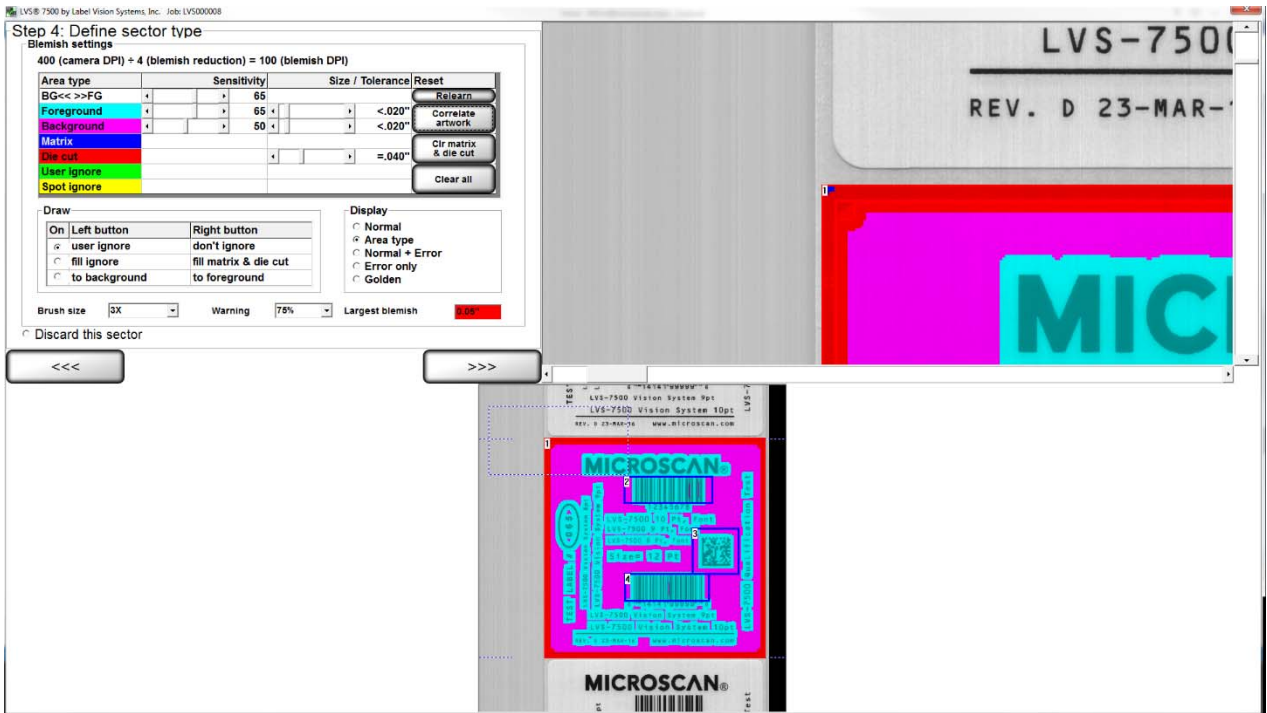

Step 9 — PASS or FAIL

LVS-7510 software will automatically access the ScanProof report saved into the job folder. If the report status is set to PASS, you will continue to complete the Blemish Tool setup and save the job.

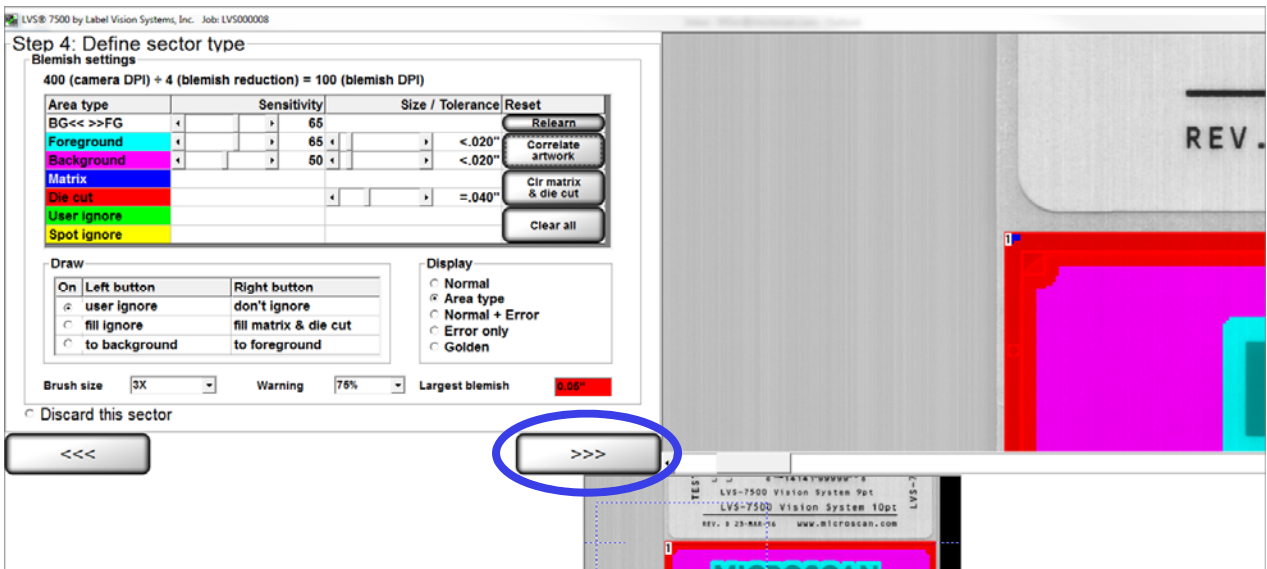

If the report status is set to FAIL, a warning message will appear to request creation of a new Blemish sector. Select Discard this sector. Click the ">>>" button to continue to a screen to re-train the sector.

