

MICROSCAN®

*MS-860 Industrial
Raster Reader
User's Manual*



Copyright © 2007

by Microscan Systems, Inc.,
1201 S.W. 7th Street, Renton, WA, U.S.A. 98057
(425) 226-5700 FAX: (425) 226-8682

ISO 9001:2000 Certification No. 06-1080

All rights reserved. The information contained herein is proprietary and is provided solely for the purpose of allowing customers to operate and/or service Microscan manufactured equipment and is not to be released, reproduced, or used for any other purpose without written permission of Microscan.

Throughout this manual, trademarked names might be used. Rather than put a trademark (™) symbol in every occurrence of a trademarked name, we state herein that we are using the names only in an editorial fashion, and to the benefit of the trademark owner, with no intention of infringement.

Disclaimer

The information and specifications described in this manual are subject to change without notice.

Latest Manual Version

For the latest version of this manual, see the Download page on our web site at www.microscan.com/downloadcenter/

For technical support e-mail helpdesk@microscan.com

Microscan Systems, Inc.
1201 S.W. 7th Street
Renton, WA 98057
U.S.A.
Tel: 425 226 5700
Fax: 425 226 8250
helpdesk@microscan.com

Microscan Europe
Tel: 31 172 423360
Fax: 31 172 423366

Microscan Asia Pacific R.O.
Tel: 65 6846 1214
Fax: 65 6846 4641

Table of Contents

Chapter 1	Quick Start	
	Step 1 Connect the System	1-2
	Step 2 Install ESP	1-3
	Step 3 Select Reader Model	1-4
	Step 4 Autoconnect	1-5
	Step 5 Position Symbol and Reader	1-6
	Step 6 Test for Read Rate	1-7
	Step 7 Calibrate the Reader	1-8
	Step 8 Configure the Reader	1-9
Chapter 2	Using ESP	
	EZ Mode	2-2
	Application Mode	2-3
	Pulldown Menus	2-4
	Connect Menu	2-9
	View	2-11
	Navigating in ESP	2-12
	Send/Receive Options	2-12
Chapter 3	EZ Button	
	EZ Button by ESP	3-2
	EZ Button by Serial Command	3-2
	EZ Button Operation	3-3
	EZ Button Modes	3-4
	EZ Button Options	3-6
Chapter 4	Calibration	
	Calibration by ESP	4-2
	Calibration by Serial Command	4-2
	Calibration Overview	4-3
	Calibrating a Symbol	4-4
	Calibration Dialog	4-5
	Calibration Options	4-6
Chapter 5	Configuration Database	
	Configuration by ESP	5-2
	Configuration by Serial Command	5-2
	Overview of Configuration Database	5-2
	Setup for Configuration Database	5-3
	Operation of Database	5-4
	Save Current Settings to Database	5-7
	Load Current Settings to Database	5-7

Table of Contents

Chapter 6	Communications	
	Communications by ESP	6-2
	Communications by Serial Command	6-2
	RS-232/422 Host Port	6-3
	RS-232 Auxiliary Port	6-8
	Auxiliary Port System Data	6-18
	Preamble	6-19
	Postamble	6-20
	LRC Status	6-21
	Response Timeout	6-22
Chapter 7	Read Cycle	
	Read Cycle by ESP	7-2
	Read Cycle by Serial Command	7-3
	Multisymbol	7-4
	Trigger	7-6
	Serial Trigger	7-12
	End of Read Cycle	7-14
	Decodes Before Output	7-16
	Reader Setup	7-17
	Laser Setup	7-22
	Raster Setup	7-22
Chapter 8	Raster/Laser	
	Raster/Laser Setup by ESP	8-2
	Raster/Laser Setup by Serial Command	8-2
	Raster Setup	8-3
	Laser Setup	8-6
Chapter 9	Symbologies	
	Symbologies by ESP	9-2
	Symbologies by Serial Command	9-3
	1D Symbologies	9-4
	Stacked Symbologies	9-26
	Narrow Margins	9-29
	Symbology ID	9-30
	Background Color	9-31
	Autodiscriminate	9-31
Chapter 10	I/O Parameters	
	I/O Parameters by ESP	10-2
	I/O Parameters by Serial Command	10-3
	Symbol Data Output	10-4
	Noread Message	10-7
	Bad Symbol Message	10-8
	No Symbol Message	10-9
	Output Indicators	10-10

Serial Verification.....	10-12
EZ Button.....	10-14
Input.....	10-15
Output 1.....	10-16
Output 2.....	10-23
Output 3.....	10-24
Quality Output.....	10-25
Database Number Output.....	10-26
Symbol Position Output.....	10-27
Read Duration Output.....	10-30
Chapter 11 Matchcode	
Matchcode by ESP.....	11-2
Matchcode by Serial Command.....	11-2
Overview of Matchcode.....	11-3
Using Master Symbols.....	11-3
Matchcode Type.....	11-4
Sequential Matching.....	11-5
Match Start Position.....	11-6
Match Length.....	11-7
Wild Card Character.....	11-8
Sequence on Noread.....	11-9
Sequence on Mismatch.....	11-10
Sequence Step.....	11-11
New Master Pin.....	11-11
Match Replace.....	11-12
Mismatch Replace.....	11-13
Chapter 12 Diagnostics	
Diagnostics by ESP.....	12-2
Diagnostics by Serial Command.....	12-2
Diagnostic Messages Overview.....	12-3
Counts.....	12-4
Hours Since Last Reset.....	12-6
Laser High.....	12-7
Laser Low.....	12-8
High Temperature.....	12-9
Low Temperature.....	12-9
Service Message.....	12-10
Chapter 13 Output Format	
Output Format by ESP.....	13-2
Output Format by Serial Command.....	13-2
Output Format Overview.....	13-3
Extraction Mode.....	13-4
Insertion Mode.....	13-6
Multisymbol Output Format Status.....	13-8
Ordered Output.....	13-10

Table of Contents

Chapter 14	Terminal Mode	
	Terminal Window	14-2
	Find Function.....	14-3
	Macros.....	14-4
	Terminal Window Functions	14-5
Chapter 15	Utilities	
	Utilities by ESP	15-2
	Read Rate	15-3
	Counters.....	15-4
	Device Control.....	15-6
	Master Symbol Database	15-8
	Digital Bar Code	15-12
	Firmware	15-13
	Symbol Type	15-15
	Defaulting/Saving/Resetting	15-16
Appendices		
	Appendix A General Specifications	A-2
	Appendix B Electrical Specifications	A-4
	Appendix C Serial Configuration Commands.....	A-8
	Appendix D Serial Command Format.....	A-12
	Appendix E ASCII Table.....	A-14
	Appendix F Defaulting/Saving/Resetting.....	A-16
	Appendix G Symbol Configuration	A-18
	Appendix H Formulas for Number of Decodes.....	A-20
	Appendix I Operational Tips	A-23
	Appendix J Embedded Menus	A-24
	Appendix K Interface Standards.....	A-25
	Appendix L Multidrop Communications	A-26
	Appendix M Glossary of Terms	A-31

Index

Microscan Limited Warranty Statement and Exclusions

What Is Covered?

Microscan Systems Inc. warrants to the original purchaser that products manufactured by it will be free from defects in material and workmanship under normal use and service for a period of one year from the date of shipment. This warranty is specifically limited to, at Microscan's sole option, repair or replacement with a functionally equivalent unit and return without charge for service or return freight.

What Is Excluded?

This limited warranty specifically excludes the following: (1) Any products or parts that have been subject to misuse, neglect, accident, unauthorized repair, improper installation, or abnormal conditions or operations; (2) Any products or parts that have been transferred by the original purchaser; (3) Customer mis-adjustment of settings contrary to the procedure described in the Microscan Systems Inc. owners manual; (4) Upgrading software versions at customer request unless required to meet specifications in effect at the time of purchase; (5) Units returned and found to have no failure will be excluded; (6) Claims for damage in transit are to be directed to the freight carrier upon receipt. Any use of the product is at purchaser's own risk. This limited warranty is the only warranty provided by Microscan Systems Inc. regarding the product. Except for the limited warranty above, the product is provided "as is." To the maximum extent permitted by law, this express warranty excludes all other warranties, express or implied, including but not limited to, implied warranties of merchantability and. Technical support questions may be directed to: helpdesk@microscan.com Register your product with Microscan: www.microscan.com/register fitness for a particular purpose. Microscan Systems Inc. does not warrant that the functions contained in the product will meet any requirements or needs purchaser may have, or that the product will operate error free, or in an uninterrupted fashion, or that any defects or errors in the product will be corrected, or that the product is compatible with any particular machinery.

Limitation of Liability

In no event shall Microscan Systems Inc. be liable to you or any third party for any special, incidental, or consequential damages (including, without limitation, indirect, special, punitive, or exemplary damages for loss of business, loss of profits, business interruption, or loss of business information), whether in contract, tort, or otherwise, even if Microscan Systems Inc. has been advised of the possibility of such damages. Microscan Systems Inc.'s aggregate liability with respect to its obligations under this warranty or otherwise with respect to the product and documentation or otherwise shall not exceed the amount paid by you for the product and documentation. Some jurisdictions do not allow the exclusion or limitation of incidental or consequential damages or limitations on an implied warranty, so the above limitation or exclusion may not apply to you. This warranty gives you specific legal rights, and you may also have other rights which may vary from state to state.

Tel: 425.226.5700 | Fax: 425.226.8250 | helpdesk@microscan.com

About the MS-860 Industrial Raster Reader

Programmable firmware allows considerable control of multiple features, including 3 programmable relay outputs and new master and trigger inputs.

A user interface program, **ESP (Easy Setup Program)**, downloadable from our web site (www.microscan.com), runs on Microsoft's Windows 98, Windows NT, Windows 2000, or Windows XP operating systems.

Important: The MS-860 is different from the MS-850 in trigger polarity and the calculation of raster sweeps.

About This Manual

This manual provides complete information on setting up, installing, and configuring the reader. The chapters are presented in the order in which a reader might be setup and made ready for industrial operation. Host serial commands are presented side-by-side with **ESP** menus and wherever possible follow the order presented in **ESP**.

Chapter 1, "**Quick Start**", provides overall step-by-step instructions for getting your reader operational with specific "go to" references to other chapters and appendices.

Host Communications

There are four ways the reader can be programmed:

1. Windows-based **ESP**, the preferred method, which offers point-and-click ease of use and visual responses to user adjustments.
2. Serial commands such as **<K100,1>** can be sent from a terminal program. They can also be sent from the **Terminal** window within **ESP**.

Note: You can learn the current setting of any parameter by inserting a question mark after the number, as in **<K100?>** To see all "**K**" commands, send **<K?>**.

3. Embedded menus. See "**Embedded Menus**" on page A-24.
4. Bar code symbol configuration. See "**Symbol Configuration**" on page A-18.

Highlighting

Serial commands, selections inside instructions, and menu defaults are highlighted in **rust bold**.¹

Cross-references are highlighted in **blue**. Web links and outside references are highlighted in **blue bold italics**.

References to menu topics are highlighted in **Bold Initial Caps**. References to topic headings within this manual or other documents are enclosed in quotation marks.

1. Colors are presented in the online PDF version found in Microscan Tools CD, 37-000001-01.

Warning and Caution Summary

This equipment has been tested and found to comply with the limits for a Class A digital device, pursuant to part 15 of the FCC Rules. These limits are designed to provide reasonable protection against harmful interference in a residential installation. This equipment generates, uses, and can radiate radio frequency energy, and, if not installed and used in accordance with the instructions, may cause harmful interference to radio communications. However, there is no guarantee that interference will not occur in a particular installation. If this equipment does cause harmful interference to radio or television reception, which can be determined by turning the equipment off and on, the user is encouraged to try to correct the interference by one or more of the following measures:

- Reorient or relocate the receiving antenna.
- Increase the separation between the equipment and receiver.
- Connect the equipment into an outlet on a circuit different from that to which the receiver is connected.
- Consult the dealer or an experienced radio/TV technician for help.

European models must use a similarly rated Class I or Class II power supply that is certified to comply with standard for safety EN 60950.



Use of controls, adjustments, or performance of procedures other than those specified herein may result in hazardous laser light radiation exposure.



There are no user serviceable parts in the reader. Opening the reader voids the Microscan Systems warranty and could expose the user to laser diode power of up to 7mW.



The laser beam can be harmful to eyesight. Avoid eye contact with the laser beam. Never point the beam at other people, or in a direction where people may be passing.

Chapter

1

Quick Start

Chapter Contents

Step 1 Connect the System.....	1-2
Step 2 Install ESP	1-3
Step 3 Select Reader Model	1-4
Step 4 Autoconnect	1-5
Step 5 Position Symbol and Reader	1-6
Step 6 Test for Read Rate.....	1-7
Step 7 Calibrate the Reader.....	1-8
Step 8 Configure the Reader.....	1-9

This section is designed to get the reader up and running quickly so the user can get a sense of its capabilities and test sample symbols. Detailed setup information for configuring the reader for your specific application can be obtained in the subsequent chapters.

Step 1 — Connect the System

Caution: If using your own power supply (see **"Safety Labels"** on page ix), be certain that it is wired correctly and supply voltage is 10 to 28 VDC. Incorrect wiring or voltage can cause equipment failures.

When setting up the system, you will need the following:

Item ^a	Part Number	Description
1	FIS-0860-1XXXG	MS-860 Reader
2	N/A	Host computer
3	61-000034-02	Null modem configuration cable
4	97-100004-15	US Power supply and
	(90-264 VAC, 24VDC)	EU Power supply
5	99-000017-01	Object detector

a. See the illustration for diagram of system.

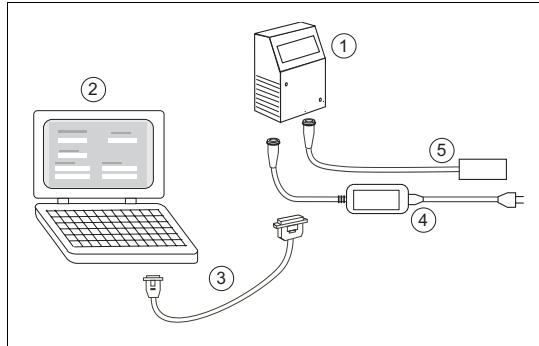

Hardware Required

Caution:

- Be sure all cables are connected **BEFORE** applying power.
- Always power down **BEFORE** disconnecting any cables.

To connect the system, do the following:

1. Connect the reader (1) to the Host (2) with the null modem cable (3).
2. Connect the power supply cable (4) to the reader's power connector.
3. If used, connect the object detector cable (5) to the trigger connector.
4. Apply power to the system.

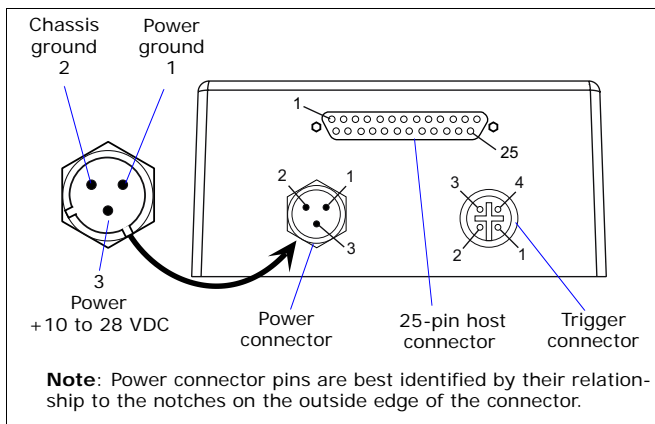

Connectors on MS-860

Step 2 — Install ESP

(**ESP** stands for *Easy Setup Program*.)

ESP is Microscan's proprietary reader setup and testing software. It is *not* meant to be a tool for a real-time production environment; the purpose of **ESP** is to provide a quick and easy way to set up and configure your reader.

With your Imager connected to a host computer (Windows 98 or higher), you can use **ESP** for configuration and Imager control.

If downloading from your "Microscan Tools" CD:

1. Insert your "Microscan Tools" CD in your computer's CD drive.
2. Choose **ESP Software** from the main menu.
3. Launch **Setup.exe** under **ESP** and follow the prompts.

If downloading from the web:

1. Go to <http://www.microscan.com/downloadcenter/>
2. Create a new "myMicroscan" member account or, if you are already a member, enter your user name and password.
3. Click the **Download Software** link and extract the latest version of **ESP** to a directory of your choice. *Note where your **ESP.exe** file is stored on your hard drive.*
4. At the end of the install process, the following icon should appear on your desktop:



5. Click the **ESP** icon to start the program.

Step 3 — Select Reader Model

When you start the program, the following menu will appear:

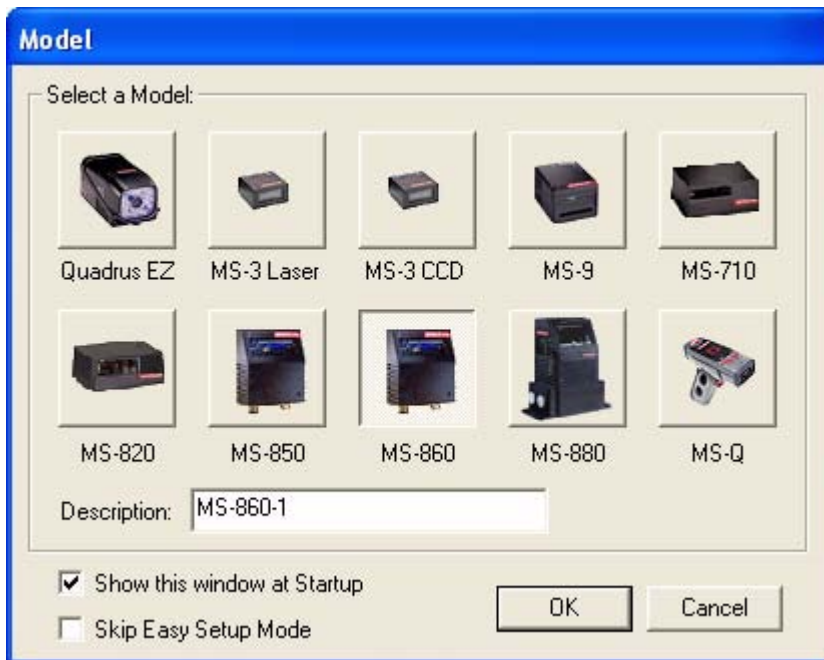

Note: If you need to select another model later, click the **Switch Model** button.

1. Select **MS-860** from the menu and click **OK**.

If you do not want to make this selection every time you load **ESP**, uncheck "Show this window at Startup".

2. Click **Yes** when the **connect to the reader** dialog appears.

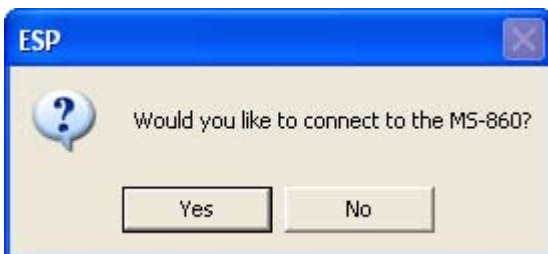

Step 4 — Autoconnect

1. In the **Connecting to...** dialog, if your communications port is not the default **COM1**, use the pull down arrow to change your communications port.



2. Click the **Start** button.

When connected, the **CONNECTED** message will appear in a green box in the status bar on the bottom right of the dialog.

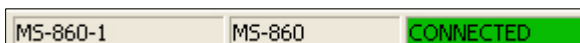

3. If the connection attempt fails, enable a different Com port, check connections, and try again.

Tip: If you do not see either the **CONNECTED** or **DISCONNECTED** message at the bottom of your dialog, try expanding the **ESP** window horizontally.

Important: When you connect to the reader, the reader's settings will be loaded into **ESP**.

Step 5 — Position Symbol and Reader

Note: **Code 39** is the default code type enabled. If you are uncertain as to your symbology type, enable all codes by selecting the **Autodiscriminate** macro in **EZ Mode**.

1. Set up a symbol at the scanning distance you are using in your application.
(See "**Read Ranges**" on page A-3.)
2. Avoid bright light or IR light from other sources, including other readers.
3. Pitch symbol or reader slightly to avoid specular reflection, the return of direct non-diffused light.

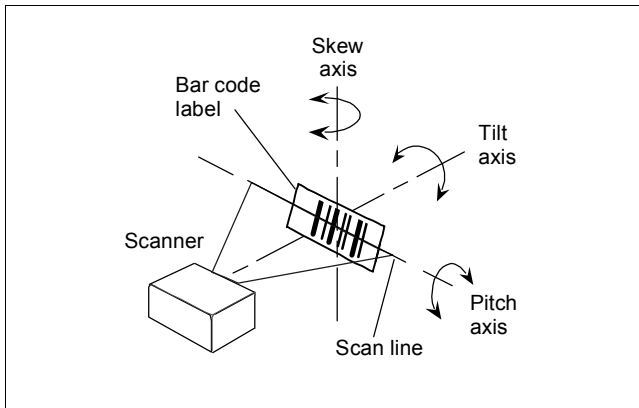

Symbol/Reader Position

4. Place symbol in the middle of a rastering pattern.

Note: If using an I 2/5 symbol, verify that the number of characters in the symbol being scanned matches the symbol length enabled for the I 2/5 symbol type. (Default is 10 and 6.)

See "**Interleaved 2 of 5**" on page 9-11.

Step 6 — Test for Read Rate

If you don't have a test symbol, print out this page and use the symbol here for testing.

Note: To the extent that the sweeping raster pattern extends above and below the symbol, read rates will be diminished. To adjust raster pattern, see "[Raster Setup](#)" on page 8-3.



20 mil Code 39 Test Symbol

"20 mil" refers to the width of the narrowest bar (e.g., 7.5 mil = .0075" or .1905 mm).

By EZ Button

Press and hold the **EZ** button until one beep along with a single green flash is emitted from the reader and the 20% LED turns ON.

Note: This assumes the **EZ** button is in its default mode of operation.



By ESP

After connecting to the reader, **ESP** will open in **EZ Mode**.

1. Click the **Test** button in EZ Mode to begin the read rate test.

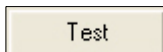

2. Follow the instructions in **Easy Setup Mode** screen.
3. To end the **Read Rate** test, click the **Stop** button.

Note: If the reader is in the default **Continuous Read** mode and not in read rate or calibration, it will read and beep repeatedly as long as a readable symbol remains in the read range and the read cycle configuration has not changed.

By Serial Commands

From a terminal window,

Send an **<C>** to begin the read rate test.

Send a **<J>** to end the read rate test.

Step 7 — Calibrate the Reader

If, after doing the read rate test, the results are not satisfactory, try the calibration routine.

During the calibration routine, the reader attempts various settings to determine the optimum decode rate for the given conditions. In this process it might do the following:

- Adjust laser power
- Adjust AGC gain and tracking
- Adjust scan motor speed
- Enable Autodiscrimination (read several symbol types)

The test will end automatically when the optimum combination of settings has been achieved.

See "[Calibration Overview](#)" on page 4-3 for fuller explanation.

By EZ Button

Press and hold the **EZ** button until you hear two short beeps and see two green flashes and the 40% LED turn ON.

Note: This assumes the **EZ** button is in its default mode of operation.



By ESP

Click the **Calibrate** button in **Easy Setup Mode** to begin the read rate test.

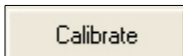

You can observe the progress of the calibration routine on the Calibration popup. After calibrating the reader, you can save your new settings to be available on power-on.

By Serial Command

From a terminal window, sending an **<@CAL>** command will start the calibration procedure.

By Embedded Menus

From a terminal window, sending an **<@>** command to access the calibration menu. See "[Embedded Menus](#)" on page A-24 for more information.

Step 8 — Configure the Reader

See the succeeding chapters and Appendixes to see specific configuration command explanations for both **ESP** and serial commands.

See Chapter 2, "**Using ESP**", for a detailed explanation of **ESP** features.

By EZ Button

See Chapter 3, "**EZ Button**", for configuration options and modes.

By ESP

To make change reader settings, or to access the utilities or terminal window, click on the **App Mode** button.



See Chapter 2, "**Using ESP**".

By Serial Commands

From your terminal program or the terminal screen in **ESP**, you can enter serial string commands configuration and utility commands as described herein.

Note: You can learn the current setting of any parameter by inserting a question mark after the number, as in **<K100?>**. To see all "K" commands, send **<K?>**.

By Embedded Menu

From your terminal program you can send a **<D>** command to access the embedded menus.

See "**Embedded Menus**" on page A-24.

Chapter

2

Using ESP

Chapter Contents

EZ Mode.....	2-2
Application Mode.....	2-3
Pulldown Menus.....	2-4
Connect Menu.....	2-9
View.....	2-11
Navigating in ESP.....	2-12
Send/Receive Options.....	2-13

This section is designed to help you understand the structure, elements, and application of the **ESP** (Easy Setup Program).

When you start up **ESP**, unless otherwise specified, you will enter the **EZ Mode** for initial setup. From there, you move easily into the **App Mode** (application mode) where you can access several configuration and utilities menus.

EZ Mode

In **EZ Mode** you are presented with the **Test** option and, if appropriate for your application, **Calibration**. After connecting to your reader (or reader) the **Setup Mode** will first appear. This will provide you with instructions specific to your model that will help you in positioning, testing, and if appropriate, calibrating.

Test

Click the **Test** button to start the read rate test for a quick indication of the read capabilities and the limits of your application. When **Decodes per Second** is unchecked, the test will count the percentage of decodes relative to the number of actual scans. Click **Stop** to end the test.

Calibrate

Some models include a calibration routine that will optimize reads by comparing read rates at various settings in focal lengths, scan speeds, and gain settings.

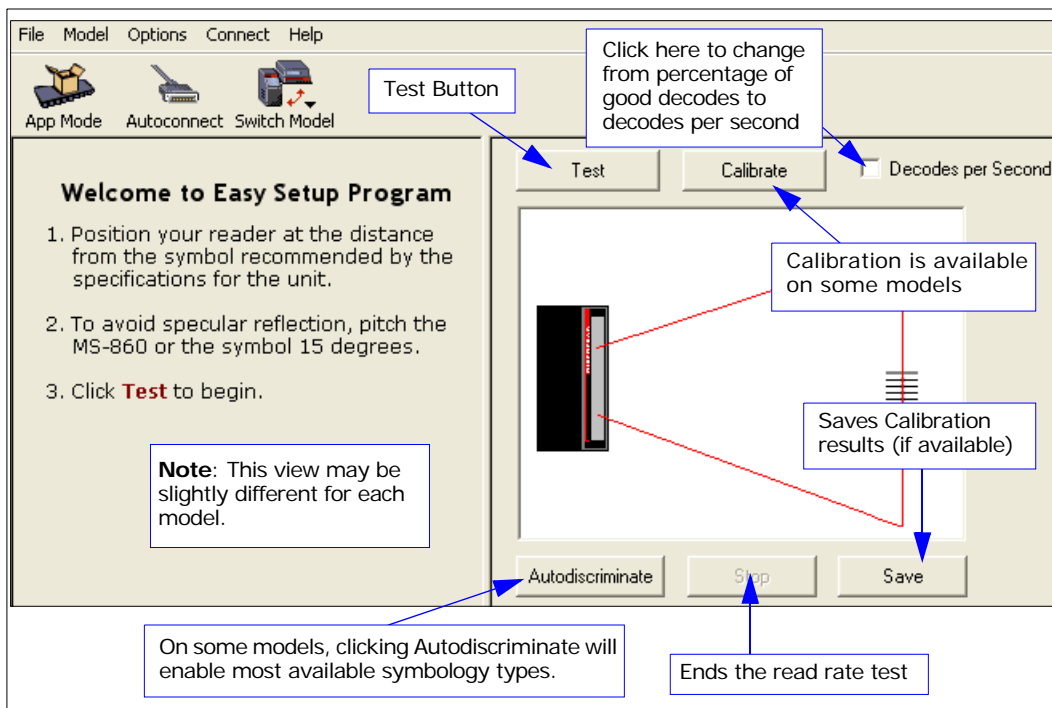

Application Mode

From **EZ Mode**, you can click on the **App Mode** button to access specific configuration menus, utilities, and a terminal window where serial commands can be entered.



Note that the **App Mode** and **EZ Mode** buttons appear in the same position to allow easy switching between these primary modes.

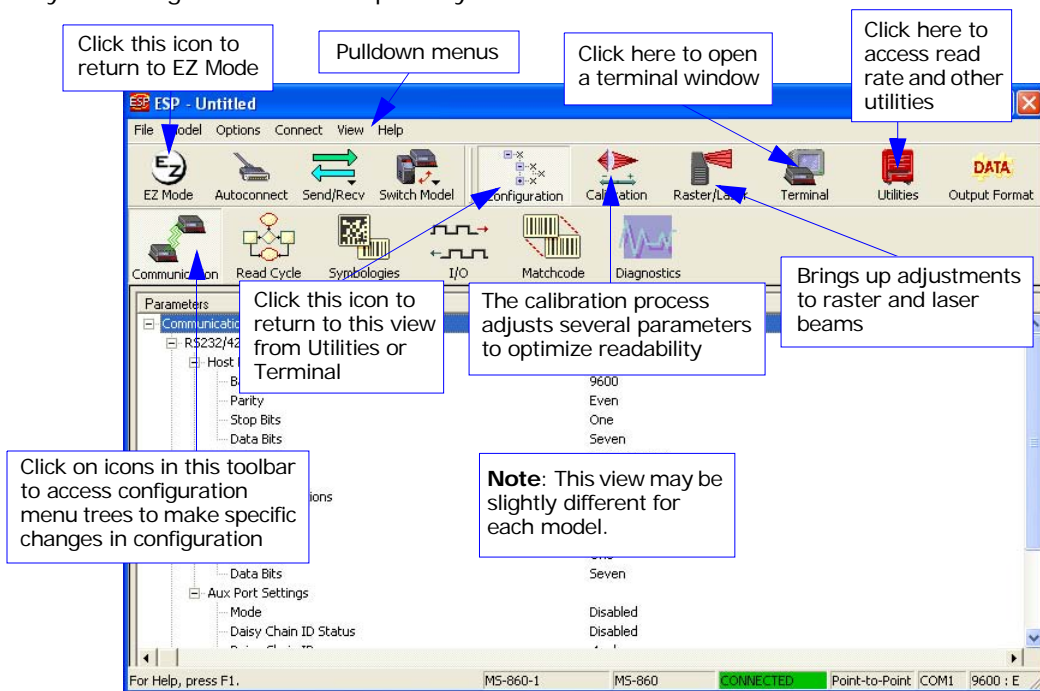

Note: For specific information on any of the icons shown above in the operations bar or configuration bar, see specific chapters in this document.

Pulldown Menus

File

New

Whenever **New** is selected, the default configuration of **ESP** is loaded.

Open/Save

When **Save** or **Save As** is selected, the **ESP** configuration is saved to the host computer's hard drive and available whenever the same file is selected under **Open**.

Important: When you save menu changes to your hard drive, these changes are not saved to your reader. The illustration shows how settings can be saved and received between **ESP** and the reader and **ESP** and the host hard drive.

File	Model	Options
New		Ctrl+N
Open...		Ctrl+O
Save		Ctrl+S
Save As...		
Print...		Ctrl+P
Import...		
Export...		
1 Untitled.esp		
Exit		

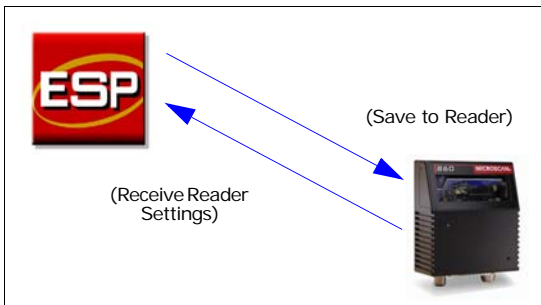

Import/Export

Import converts the ASCII settings from a text file to **ESP** configuration settings.

Export converts the active **ESP** configuration settings to an ASCII text file.

Model

In **Model** you can select between models. When you choose another model, your current connection with your present model will be terminated.

To connect to another model, select **New Model**, choose a new model and click **OK**.

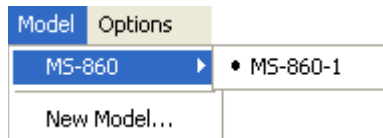

Note that all the models you have enabled by selecting will continue to appear in the Model menu and that the same menu is repeated when clicking the **Switch Model** icon.



When you save your **ESP** file, you will be saving the settings of all the models defined in a single **ESP** file.

Options

You can use the **Options** menu save memos and set up **ESP Preferences**.

Note: Preferences will be saved and be loaded into **ESP** when **ESP** is opened next, whether or not you save the **ESP** file to the computer.

Preferences

General tab

Reload Last File

At startup, reloads the last file saved to the computer.

Show Model Prompt

At startup, remembers the last connected model and displays it in the **Connecting...** dialog whenever you attempt to connect.

Skip Easy Mode

At startup, Skips the **Easy Mode** and opens directly in the application mode.

Show Connect Prompt

At startup, displays the **Would you like to connect...** prompt.

Receive After Connect

At startup, loads the reader's settings into **ESP**. (This is not recommended if you want to preserve your **ESP** settings for future use.)

Enable 'Send and Save as Factory Settings'

At startup, enables the **Send and Save as Factory** option in the **Send/Recv** command.

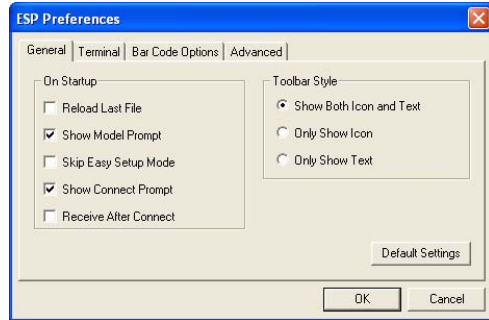

Terminal tab

When **Show Non-Printable Characters** is checked, characters such as CRLF will be displayed in the terminal window. When **Enhanced Format** is checked, the characters are displayed with more detailed formatting.

Change Keyboard Macros

In this dialog you can first select the function key and then enter your macro keystrokes in the associated key map. For example, to make Ctrl-F5 the keystroke to enable send a trigger character, select **F5**, then in the Ctrl row, enter **<trigger character>** and click **OK**. Then whenever the Ctrl-F5 keystroke is pressed, the trigger character will start the read cycle.

Change Font

Sets the font characteristics for the commands that you type in the terminal window.

Change Echo Font

Sets the font characteristics for text that is echoed back to the screen from the reader.

Toolbar Style

By user selection, displays toolbar buttons as icons, text only, or both (default).

Note: See also Chapter 14, "**Terminal Mode**".

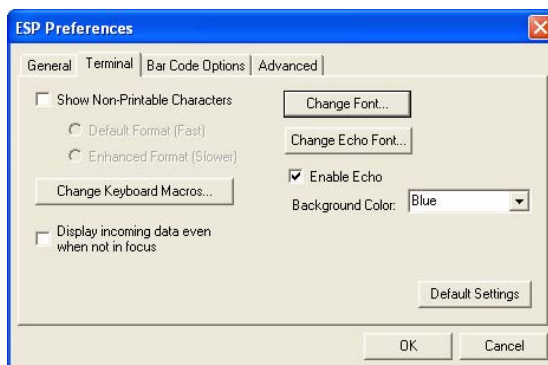

Pulldown Menus

Bar Code Options tab

Sets up the sizing, font, and caption parameters for the bar codes that you can create and print from the **Bar Code Options Dialog** under **View**.

Sizing Information

Sets the bar height (in inches) and bar widths (in thousands of an inch) of the symbols. A bar width of 13 is 0.013 inches.

Caption

Sets the characteristics of caption font and its placement in relation to the symbol.

Advanced tab

As indicated.

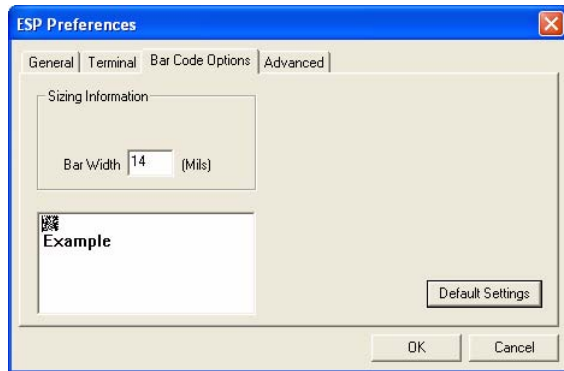

Document Memo

Whatever you type into the Document Memo will appear in a text box whenever your cursor hovers over the Document Memo option.

Model Memo

Memos created in **Model Memo** are specific to the model enabled when the message was created.

Connect Menu

Autoconnect

Generally **Autoconnect** will be the quickest way that **ESP** can get connected to a reader. **Autoconnect** will try connecting at the most common communications settings and step through the various settings until they match up with the host's settings.

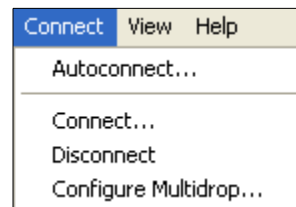

Connect

When you select **Connect**, you will need to manually select the communications settings from a popup dialog.

Configure Multidrop

To connect to the reader by Multidrop, you will need a multidrop concentrator such as the MS-5000 and the required power supplies and cabling to communicate with your scanner(s).

1. From the **Communications** drop down menu in **ESP**, select **Configure Multidrop** to bring up the **Multidrop Settings** dialog.
2. If necessary, change the default address to match the address of your multidropped scanner and click **OK**.

If the host serial port is not connected in **ESP**, you will see the following popup message:

“**ESP** is not currently connected to the multidrop concentrator. Do you wish to establish a connection now?”

3. Click **Yes**.
You will see a **Connection Settings** dialog as shown on the next page.

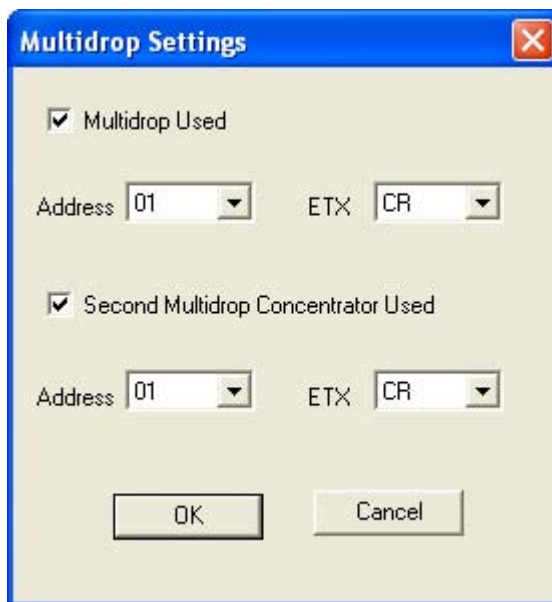

Connect Menu

4. Select the concentrator's host port communications settings.

When you click **Connect**, you will be connecting to your concentrator, which can then relay commands to the scanner whose address was set in the **Multidrop Settings** dialog.

5. Click **Connect**.
6. You should see the **CONNECTED** message in green at the bottom of the window along with the scanner's **Multidrop** address.
7. **Retrieve Scanner Settings** to upload scanner's configuration. If upload fails, return to the **Connection Settings** dialog and make the corrections.
8. Follow the same procedure for connecting other scanners to your multidrop network.

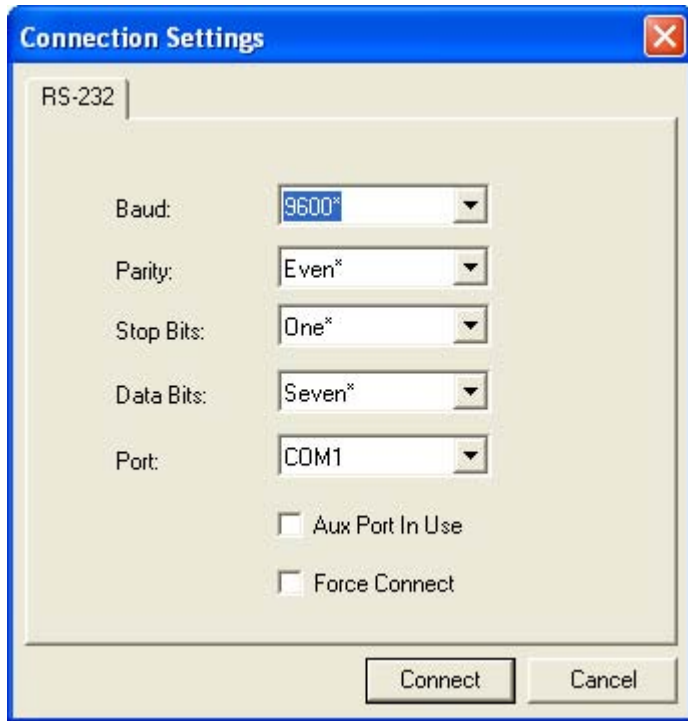

View

View indicates the current view (with a dot before the item) and allows you to quickly move to other views which are also accessed by clicking the icons on the toolbars.

It also allows you to access the Barcode Dialog.

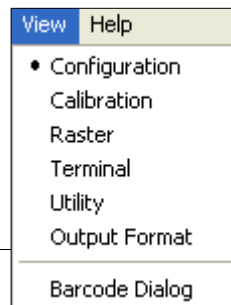

Barcode Dialog

In the Barcode Dialog you can create bar code symbols by directly typing in the text bar code text you want to appear in Code 128 bar code symbols. This is a very useful tool for creating configuration symbols which allows you to configure your reader by reading the bar code symbols you print out. To configure the size, text and caption parameters, see "[Bar Code Options tab](#)" on page 2-8.

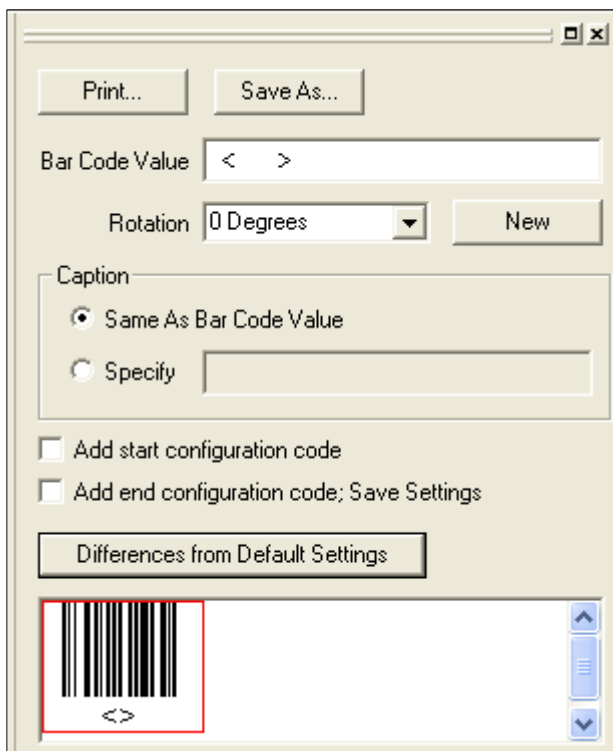

Navigating in ESP

To change reader settings, or to access the utilities or terminal window, click on the **App Mode** button.



To return to the **Easy Mode**, click on the **EZ Mode** button.



To make changes to a configuration setting in the menu trees:

1. **Left click** on the + to expand tree
2. **Double click** on parameter and click once in selection box to view options.
3. Place your cursor in the selection box, scroll down to the setting you want to change and **click** once on the setting.

Parameters	ESP Values
[-] Read Cycle	
[-] Default Continuous Event	Off
Read Cycle Timeout	375
Target Time before Decode	25
Button Stay-Down Time	1.250
Ignore Duplicate Symbol Timeout	0

4. **Left click** again on the open screen to complete the selection.
5. **Right click** on the open screen and select **Save to Reader** to implement the command in the reader.

Send/Receive Options

To access **Receive**, **Save** and **Default** options, click the **Send/Recv** button: You can also access this selector by right-clicking in any of the configuration views.



Receiving

From the **Send/Recv** selector, select **Receive Reader Settings**.

Caution: Do not select this option if you do not want to upload the reader's settings. For example, if your **ESP** file has a number of custom settings that you want to maintain and download into the reader, these settings would be lost by choosing **Yes**.

This is useful if you want to receive (upload) the reader's settings and save them as a computer file for later retrieval. For example, if your reader has settings that you do not want to change, choosing **Yes** would allow you to load those settings to **ESP** and save as an **ESP** file for later retrieval.

Receiving the reader's settings will also assure that you will not be subsequently saving any unwanted changes that you or someone else previously made in **ESP**.

Saving

1. **Send, No Save.**
(same as **<A>**)

This saves **ESP** settings to current memory.

2. **Send and Save.**
(same as **<Z>**)

This activates all changes in current memory *and* saves to the reader for power-on.

3. **Send and Save as Customer Defaults.**
(same as **<Zc>**)

(This option will be visible only if you had checked **Enable 'Send and Save as Customer Defaults'** in **ESP Preferences** in the **Options** menu.)

Use this to save your own set of default settings that you can quickly retrieve with a **<Zrc>** command.

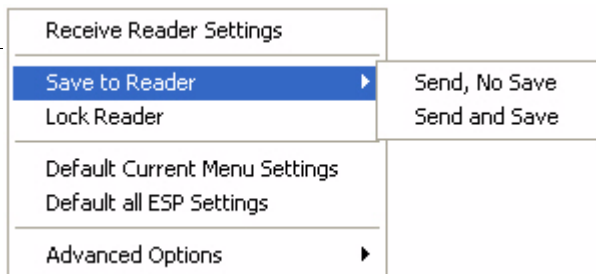

For more on defaulting and saving settings, see "**Defaulting/Saving/Resetting**" on page A-16.

Defaulting

When you select **Default Current...** or **Default all ESP...** you are only defaulting the **ESP** settings.

Advanced Options

Send Current View

This is the same as **Save to Reader, Send No Save** except that only the commands in the current menu tree are sent.

Send Current Command

This is the same as **Send Current View** above, but only saves the command that is currently selected.

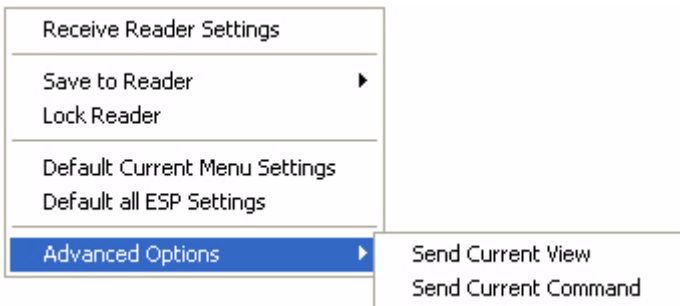

Add Exceptions

After you perform a **Receive from Reader** command¹ and you click on the **Add Exception** option you may see a list of serial commands. These are serial commands that may be in your reader's firmware, but not included or different from your current **ESP** software.

You can edit these commands by double-clicking on them and changing as needed.

When exceptions are present, you can also access them from an **Exceptions** button that will appear on the Applications button bar.



It is important to note that these commands will be saved to your reader whenever you send a **Save to Reader** command or send an **<A>** or a **<Z>** command.

Also, if there is a corresponding **ESP** menu item, the **ESP Value** column for that item will be blank following a **Receive from Reader** command.

1. From the Send/Recv button or right-clicking from within the tree menus.

Chapter

3

EZ Button

Chapter Contents

EZ Button by ESP	3-2
EZ Button by Serial Command	3-2
EZ Button Operation.....	3-3
EZ Button Modes.....	3-4
EZ Button Options	3-6

This section includes instructions for setting up and using the **EZ Button**.

EZ Button by ESP

Click the button shown above to bring up the **I/O Parameters** menu

Parameters	ESP Values
I/O Parameters	
Symbol Data Output	Good Read
Noread Message	Enabled
Symbol Message	Disabled
Output Indicators	Disabled
Serial Verification	Disabled
EZ Button	Enabled
Input 1	Disabled
Output 1 Parameters	
Output 2 Parameters	
Output 3 Parameters	
Quality Output	
Database Number Output	Disabled
Symbol Position Output	

EZ Button by Serial Command

EZ Button	
EZ Button Modes	< K771 ,position 1 mode[0...9],position 2 mode[0...9],position 3 mode[0...9]>
EZ Button Options	< K770 ,global status,default on power-on>
EZ Button Auto Framing	< K773 ,raster status,laser status>

EZ Button Operation

The MS-860 EZ Button provides a quick and easy way to perform routine tasks such as Read Rate test and Calibration.

Defaults

In the default positions the following operations occur:

- Single Beep and green flash:
Starts a **Read Rate** test
- Two Beeps and green flashes:
Starts a **Calibration**
- Three Beeps and green flashes:
Save for Power-on

Using the EZ Button

The EZ Button has three positions, selectable by the length of time that the button is held down as indicated by one, two, and three beeps and percentage LEDs in succession.

For example, for three beeps, press and hold the EZ Button. You will first hear a single beep and see the 20% LED turn ON. Continue to hold and you will hear two quick beeps and see the 40% LED turn ON. Do not release until you hear three quick beeps or see the 60% LED turn ON.

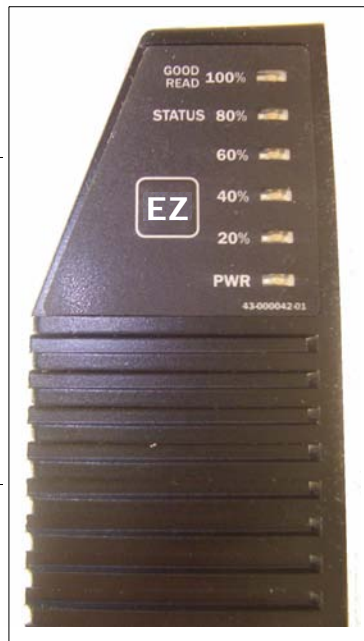

Programmable Beeps

Each beep condition (1, 2 or 3) can be programmed for any of 8 options as presented in "[EZ Button Modes](#)" on page 3-4.

Programmable Options

The EZ Button can also be programmed for alternative operations including restore factory defaults as well as a quick save feature for calibration results. (See "[EZ Button Options](#)" on page 3-6.)

EZ Button Modes

- Usage:** Useful for performing multiple, repetitive tasks at the work site.
- Definition:** Provides six user-selectable functions for each of the three EZ Button positions.
- Serial Cmd:** `<K771,position 1 mode[0...9],position 2 mode[0...9],position 3 mode[0...9]>`
- Defaults:** `<K771,1,2,3>` as highlighted in the table.
- Options:** 0 through 9 for each position, as shown in the table.

The positions are selected by the length of time the button is held. When you want to select position one, you press and hold the button until one beep along with a single green flash is emitted from the reader and the 20% LED turns ON. To select position two, you continue to hold until you hear two short beeps and see two green flashes and the 40% LED turn ON. Finally, to select position three, you continue to hold the button until you hear three short beeps and see three green flashes and the 60% LED turn ON. For example, if you want to select the function for position three, you will hear one short beep, then two short beeps, and finally three short beeps and the 20%, 40%, and 60% LEDs turn ON in progression. The following table lists the options for the three positions with the default positions highlighted:

EZ Button Options

Position 1 (1 beep and green flash)	Position 2 (2 beeps and 3 green flashes)	Position 3 (3 beeps and 3 green flashes)
0 = Disabled	0 = Disabled	0 = Disabled
1 = Read Rate	1 = Read Rate	1 = Read Rate
2 = Calibration	2 = Calibration	2 = Calibration
3 = Save for Power-on	3 = Save for Power-on	3 = Save for Power-on
4 = Auto Framing	4 = Auto Framing	4 = Auto Framing
5 = Load New Master	5 = Load New Master	5 = Load New Master
6 = Sleep Mode	6 = Sleep Mode	6 = Sleep Mode
7, 8 = Unused	7, 8 = Unused	7, 8 = Unused
9 = Symbol Configuration	9 = Symbol Configuration	9 = Symbol Configuration

Disabled: When set to **Disabled**, the button position will have no function associated with it. The reader will still respond when the button position is reached.

Read Rate: Read rate will perform decodes/second and is the same as sending a `<C>` from the terminal. (See "**Read Rate**" on page 15-3.) To exit read rate mode, tap the EZ Button once quickly.

Calibration: The calibration routine will be initiated (see "[Calibration Options](#)" on page 4-6). To abort calibration, tap the EZ Button once quickly.

Save for Power-on: When this button position is selected, all reader settings will be saved to non-volatile memory to be recalled when reader is powered-on the next time. This is the same as sending the **<Z>** in the terminal.

Auto Frame: Auto Framing will be initiated when this button position is selected. To abort auto-framing, press the EZ Button once quickly. Auto framing is a background routine that automatically adjusts the scan width to the length of a symbol. This procedure can also be accessed in a terminal view by the **<@>** command. (See "[EZ Button Auto Framing](#)" on page 3-7 for options).

Load New Master: This allows the button to function the same as the New Master Pin command. The new master pin's consecutive decode requirement holds true for this button position when this mode is selected. (See "[Sequence Step](#)" on page 11-11.)

Sleep Mode: If sleep mode is enabled, the EZ Button will shut off the mirror motor and laser. To exit sleep mode, tap the EZ Button once quickly.

Label Configuration: Enables label configuration mode when this button position is selected. To disable, simply tap the Configuration Button once quickly. In normal reading modes, it is required to read a special Code 128 label with a special codeword used by AIM to signify reader programming. When entering label configuration by the EZ Button, the special Code 128 label is not required.

EZ Button Options

The EZ Button provides a convenient way to perform programmable operations both globally and for each of the three programmable button positions.

The EZ Button has three positions, each of which can be user-programmed to perform a variety of functions.

Global Status of EZ Button

Definition: Determines the basic function of the EZ Button.

Serial Cmd: <K770,global status,default on power-on>

Default: **Enabled**

Options: 0 = Disabled 2 = Trigger 4 = Parameter Switch
 1 = Enabled 3 = Unlatch Output

Disabled

When selected, the EZ Button is disabled.

Enabled

When selected, the function of each button position can be determined by the **EZ Button Mode <K771>** command.

Trigger

When selected, the EZ Button will act as a trigger for the reader. All other button operations will not be active. The trigger will operate the same way as an external trigger.

Trigger mode	Operation
External Level	The read cycle endures for as long as the EZ Button is pressed, unless a timeout occurs and Timeout is enabled for End Of Read Cycle .
External Edge	As with Level , Edge allows a read cycle to be initiated by pressing the EZ Button, but unlike Level mode, the read cycle ends with a good read output, a timeout, or a new trigger.

Unlatch Output. When selected, will unlatch any outputs that have been latched via "**Latch Mode 1 (Unlatch on Input #1)**" on page 10-18.

Unlatch Outputs

Unlatch any outputs that have been latched via latch mode #1. See <K81n> commands.

Parameter Switch

Toggles between custom defaults and power on settings, as if **<Arc>** and **<Arp>** are received, respectively. Note that the button must be configured for “parameter switch” in both custom and power on settings in order to be able to toggle between the two.

Default on Power-on

Definition: When enabled, if the EZ Button is held down during power-on, the reader will default to customer defaults and save for power-on. This is the same as sending a **<Zrc>** command.

Serial Cmd: **<K770,global status,default on power-on>**

Default: **Enabled**

Options: 0 = Disabled 1 = Enabled

EZ Button Auto Framing

Definition: Configures the reader's **Auto Framing** process as initiated from the EZ Button. Raster framing is performed first, followed by laser framing, as enabled. During the raster framing process, the scan line used depends on the “laser status”.

Raster Status

Definition: When enabled, **Raster Framing** will be performed whenever a framing process is ordered.

Serial Cmd: **<K773,raster status,laser status>**

Default: **Disabled**

Options: 0 = Disabled 1 = Enabled

Laser Status

Definition: When enabled, **Laser Framing** will be performed whenever a framing process is ordered.

Serial Cmd: **<K773,raster status,laser status>**

Default: **Enabled**

Options: 0 = Disabled 1 = Enabled

Chapter

4

Calibration

Chapter Contents

Calibration by ESP	4-2
Calibration by Serial Command.....	4-2
Calibration Overview	4-3
Calibrating a Symbol	4-4
Calibration Dialog	4-5
Calibration Options	4-6

The purpose of calibration is to optimize certain reader settings to obtain the highest read rates in one or several symbol positions as required by the user's application. This section includes the overall steps in calibration and specific steps for calibration by **ESP**, serial command, and embedded menus. For most applications, calibration is the only optical setup required. This section also includes an explanation of **Auto Frame** commands, the routine for constraining the width of the scan beam.

Calibration by ESP



Click this Button to bring up the **Calibration** menu

Calibration by Serial Command

Calibration Options	
Calibration Options	<K521,raster options,video status,scan speed status,laser power status,laser framing status,symbology detect>

Calibration Overview

When a **Calibrate** command is sent, all symbologies are enabled except PDF417¹ and Pharmacode.² The reader looks for readable bar code symbols, and records the highest read rates it encounters while stepping through various settings. Any new symbologies decoded during calibration are enabled at the end of calibration. However, no previously enabled symbologies are disabled.

The settings that the calibration routine uses can be pre-set by the user and include the following:

Calibrates for:	Default Status
Symbol position in the raster pattern	Searches for symbol but does NOT save to NOVRAM
Video (gain and tracking)	Enabled
Scan speed (scans per second)	Enabled
Laser power (attempt minimum power)	Enabled
Laser framing (shortens scan line to fit symbol)	Disabled

The calibration settings can be changed by application requirements. See "**Calibration Options**" on page 4-6 for details.

Calibration Methods

There are four ways to start calibration:

- The **EZ** Button.
- **ESP Calibration** menu.
- Serial command **<@CAL>**.
- From embedded calibration menu **<@>** (see "**Embedded Menus**" on page A-24).

Configuration Database

When a symbol is calibrated, the resulting settings are automatically loaded into the **Current** index of the configuration database. From here it can be copied into any of the active database indexes and the indexes are compiled in the configuration database are applied in real time operations. See Chapter 5, "**Configuration Database**".

1. Calibration does not function with PDF417 symbols. However, you can substitute a Code 128 symbol with the same mil size as your PDF417. When you do this, enable Code 128 and after calibration, switch back to PDF417.
2. **Note:** If using an I 2 of 5 symbol, verify that the number of characters in the symbol being scanned matches the code length enabled for the I 2 of 5 code type (default is 10 and 6). See "**Interleaved 2 of 5**" on page 9-11.

Calibrating a Symbol

1. Position symbol so that the raster scan lines are evenly spread above and below the symbol and will be parallel with the symbol length as shown in the illustration.
2. Enable those settings required for your specific application.
3. Start the calibration procedure.
(See "**Calibration Methods**" on page 4-3.)

If in the default **Search** mode ("**Raster Options**" on page 4-6), the raster pattern will change to a single line, move to its top-most position, and sweep slowly down until it finds a symbol. If no symbol is found, the raster will go to a straight line, centered on its raster sweep.

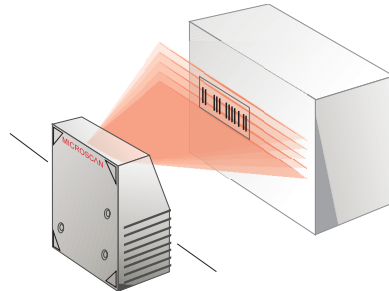

Calibration Setup

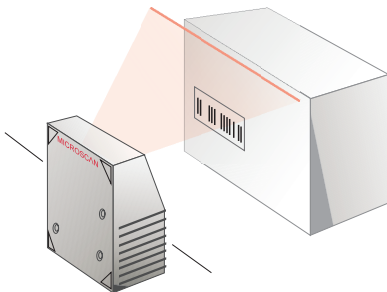

Calibration Start

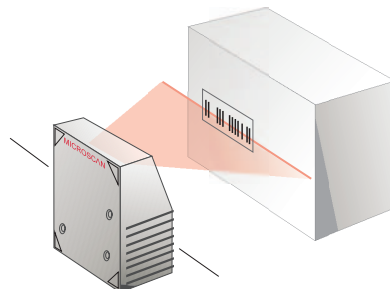

Symbol Found

Calibration Dialog

1. In **App Mode**, click the **Calibration** button on the icon bar at the top of **ESP** to open the calibration menu.
2. In the **Fixed Parameter Calibration** area you can select one or more parameters that you do NOT want to change.
3. Wait for the calibration to cycle through the various settings looking for the best combination. A "Calibration Successful" message should eventually appear.
4. Click **Save** to save for power-on (same as a **<Z>** command).



Use the **Test** button to start a read rate test

Start the calibration procedure by clicking the **Calibrate** button

Choose between Raster Framing and Laser Framing

These are the parameters that can be adjusted during the calibration procedure

If checked, the associated parameter(s) will not change during calibration

See "**Raster Options**" on page 4-6.

Reset parameters in this group

Click **Save** to save for power-on

Click **Stop** to end Test or Calibration

Calibration Display

Calibration Options

Before starting the calibration routine, you can make changes to the parameters that will be included in the process. If you make no changes, calibration will use the default parameters as described in this section.

Note: The changes made in this section will only apply to EZ Button, **<@>**, and **<@CAL>** defaults.

Raster Options

Definition: Configures the raster position that will be used during the calibration process and determines whether raster framing is performed.

Serial Cmd: **<K521,raster options,video status,scan speed status,laser power status,laser framing status,symbology detect>**

Default: **Search**

Options:

0 = As Is	2 = Search
1 = Frame	3 = Straight

As Is

Usage: Useful when the raster pattern has already been aligned to the symbol.

Definition: Raster position does not change during calibration. Raster will continue to operate as per the raster command **<K506>**.

Frame

Definition: Similar to "Search" setting, except at the end of calibration, the raster is swept through its full range of motion again, and the top and bottom location of the first symbol found are used to update the raster's top and bottom offset novram configuration. Also, the resulting configuration parameters are saved to the raster novram.

Search

Definition: At the beginning of calibration, the raster sweeps through its entire range of motion in an attempt to find a symbol. When found, the scan line is placed in the middle of the symbol and held as a straight line for the remainder of the calibration process. If no symbol is found, the scan line will be placed straight line and centered straight out of the window for the remainder of the calibration process.

Straight

Definition: The scan line is set as a centered straight line during calibration. This is equivalent to Top Position = Bottom Position = 127 in the raster command **<K506,,127,127>**.

No permanent change is made to the raster novram configuration parameters.

Video Status

Definition: Video status includes both **Gain** and **Tracking**.

When checked, **Gain** and **Tracking** settings are fixed and is not calibrated.

When unchecked, they become part of the calibration procedure.

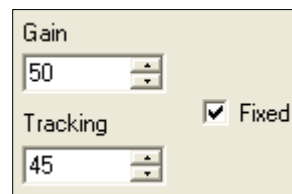

Serial Cmd: **<K521,raster options,video status,scan speed status,laser power status,laser framing status,symbology detect>**

Default: **Enabled**

Options: 0 = Disabled 1 = Enabled

Scan Speed Status

Definition: When checked, **Scan Speed** is fixed and is not calibrated.

When unchecked, it becomes part of the calibration procedure.

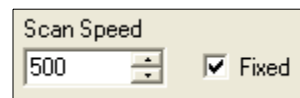

Serial Cmd: **<K521,raster options,video status,scan speed status,laser power status,laser framing status,symbology detect>**

Default: **Enabled**

Options: 0 = Disabled 1 = Enabled

Note: Do not calibrate motor speed if using the calibration database.

Laser Power Status

Definition: When checked, **Laser Power** is not changed by calibration.

Laser power is minimized during the calibration process.

When not checked, laser power becomes part of the calibration process.

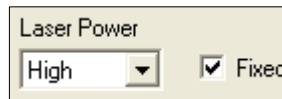

Serial Cmd: <K521,raster options,video status,scan speed status,**laser power status**,laser framing status,symbology detect>

Default: **Enabled**

Options: 0 = Disabled 1 = Enabled

Laser Framing Status

Note: See "**Laser Setup**" on page 8-6 for the current laser settings.

Definition: When enabled, laser framing is performed during calibration.

Serial Cmd: <K521,raster options,video status,scan speed status,**laser power status**,**laser framing status**,symbology detect>

Default: **Disabled**

Options: 0 = Disabled 1 = Enabled

Disabled

If Laser Framing Status is disabled, the laser scan line is not changed and will continue to operate per the **Laser Setup** <K700> settings ("**Laser Setup**" on page 7-22).

Enabled

If **Laser Framing Status** is enabled and the beginning and end of the symbol are located during calibration, the <K700> **Laser Setup** parameters are changed as follows:

1. The **On Position** and **Off Position** parameters for the beginning and end of the symbol are updated.
2. **Laser Framing** is set to **Enabled**.

If a symbol is not located, the <K700> **Laser Setup** parameters will not be changed.

Symbology Detect

Definition: When enabled, autodiscrimination is in effect during the calibration process.

When disabled, only the current symbologies enabled will be considered during the calibration process.

Serial Cmd: <**K521**,*raster options,video status,scan speed status,laser power status,laser framing status,symbology detect*>

Default: **Enabled**

Options: 0 = Disable 1 = Enabled

When enabled, all symbologies readable by the MS-860 except PDF417 and Pharmacode will be attempted during calibration. Any new symbologies successfully decoded during calibration will remain enabled at the end of the process. All enabled symbologies will remain enabled. For example, assume that only Code 39 is enabled at the beginning of calibration and **Symbology Detect** is enabled. If a Code 128 symbol is read during calibration, then Code 128 as well as Code 39 will thereafter be enabled.

Chapter 5

Configuration Database

Chapter Contents

Configuration by ESP	5-2
Configuration by Serial Command.....	5-2
Overview of Configuration Database.....	5-2
Setup for Configuration Database	5-3
Operation of Database	5-4
Save Current Settings to Database	5-7
Load Current Settings from Database	5-7

This section explains how to set up and use database indexes.

Configuration by ESP



Click this Button to bring up the **Calibration** menu. Then Click on the **Configuration Database** tab.

Index	Gain	AGC Mode	Tracking	Raster Top	Raster Bottom	Raster Speed	Framing Status	Laser On Position	Laser Off Position	Laser Power	Background Color
Current	50	Continuous	45	88	167	10	Disabled	10	95	High	White
1	50	Continuous	45	88	167	10	Disabled	10	95	High	White
2	50	Continuous	45	88	167	10	Disabled	10	95	High	White
3	50	Continuous	45	88	167	10	Disabled	10	95	High	White

Configuration by Serial Command

Configuration Database Control	
Database Setup	< K253 , <i>index,gain,AGC mode,tracking,raster top,raster bottom,raster speed,laser framing status,laser on position,laser off position,laser power,background color</i> >
Database Operation	< K252 , <i>number of active indexes,database cycles</i> >
Database Mode	< K254 , <i>mode,count/time</i> >
Save Current to Database	< K253+ , <i>database index</i> >
Load Current from Database	< K253- , <i>database index</i> >

Overview of Configuration Database

Definition: Up to 10 configuration database indexes can be set up either manually or derived in part from calibration results as explained in Chapter 4, "**Calibration**". When enabled, these settings will be applied sequentially and repeatedly during the read cycle.

Usage: Useful in applications in which a variety of symbol conditions require different settings that can be applied in real time. For example, a package with a Code 39 and Code 128 symbol appearing consistently in different locations as they move through the scan range during a read cycle can be read by the reader if the proper settings are in the active configuration database.

Setup for Configuration Database

Definition: When setting up the configuration database, for each index number (1 to 10) the values for 11 parameters can be defined applied during the read cycle as enabled by "**Number of Active Indexes**" on page 5-4.

Serial Cmd: <**K253,index,gain,AGC mode,tracking,raster top,raster bottom,raster speed,laser framing status,laser on position,laser off position,laser power,background color**>

Default: 0 (Index)

Options: 1 to 10 indexes, 0 = disabled

When setting up the database, the following parameters can be changed:

Parameter	Also in Calibration? ^a	Reference
Gain	Yes	See < K504 >, " Gain Level " on page 7-17
AGC mode	No	See < K504 >, " Automatic Gain Control (AGC) " on page 7-19
Tracking	Yes	See < K520 >, " Tracking " on page 7-17
Raster Top	Yes	See < K506 >, " Top Offset " on page 8-4
Raster Bottom	Yes	See < K506 >, " Bottom Offset " on page 8-4
Raster Speed	Yes	See < K506 >, " Raster Sweep Rate " on page 8-5
Laser Framing Status	No	See < K700 >, " Laser Framing " on page 8-7
Laser On Position	Yes	See < K700 >, " Laser On Position " on page 8-8
Laser Off Position	Yes	See < K700 >, " Laser Off Position " on page 8-8
Laser Power	Yes	See < K700 >, " Laser Power " on page 8-8
Background Color	No	See < K451 >, " Background Color " on page 9-31

a. It is important to note that the above settings are not identical to the settings changed by the calibration routine described in Chapter 4, "Calibration."

Operation of Database

Once **Configuration Database** is enabled (by setting the **Number of Active Indexes** to any number other than 0) the reader's current settings for **Gain**, **AGC Mode**, **Tracking**, **Raster Top**, **Raster Bottom**, **Raster Speed**, **Laser Framing Status**, **Laser On Position**, **Laser Off Position**, **Laser Power** and **Background Color** will no longer impact reader operation. For those parameters, only settings that are in the database and enabled will be used during the normal read cycle.

Number of Active Indexes

Definition: Number of data base records (groups of settings) that will be used automatically during the read cycle. If set to 0, the reader only uses the current settings, not database entry settings.

Serial Cmd: <**K252,number of active indexes,database cycles**>

Default: **0** (0 = disabled)

Options: 0 to 10 indexes

Database Cycles

Definition: The number of times the database will be repeated (cycled).

Serial Cmd: <**K252,number of active indexes,database cycles**>

Default: **0**

Options: 0 to 255

When set to 0, the reader will repeatedly cycle through all active database indexes until the read cycle ends. When set to any number greater than 0, the reader will only cycle the active database entries the defined number of times before adopting the settings from the last active index for the remainder of the read cycle.

Note: It is possible for the read cycle to end before the reader is able to cycle through all data base entries.

Note: When the reader is in **Continuous Read** and **Continuous Read 1** and not in **Read Rate**, it will only use current settings, not database entry settings. However, the user may still send the <**K253-,n**> command to load current settings from the database.

Configuration Database Window

In **ESP**, when you click on the **Database** tab you will see the following:

The screenshot shows the 'Configuration Database' window with a table of parameters and a 'Database #5' dialog box. Callouts provide detailed instructions for each part of the interface.

Configuration parameters (all)

Index	Gain	AGC Mode	Tracking	Raster Top	Raster Bottom	Raster Speed	Framing Status	Laser On Position	Laser Off Position	Laser Power	Background Color
Current	50	Continuous	45	88	167	10	Disabled	10	95	High	White
1	50	Continuous	45	88	167	10	Disabled	10	95	High	White
2	50	Continuous	45	88	167	10	Disabled	10	95	High	White
3	50	Continuous	45	88	167	10	Disabled	10	95	High	White
4	50	Continuous	45	88	167	10	Disabled	10	95	High	White
5	50	Continuous	45	88	167	10	Disabled	10	95	High	White
6	50	Continuous	45	88	167	10	Disabled	10	95	High	White
7	50	Continuous	45	88	167	10	Disabled	10	95	High	White
8	50	Continuous	45	88	167	10	Disabled	10	95	High	White
9	50	Continuous	45	88	167	10	Disabled	10	95	High	White
10	50	Continuous	45	88	167	10	Disabled	10	95	High	White

Database #5

Gain	50 (0 - 255)	AGC Mode	Continuous	Tracking	45 (10 - 127)
Raster Top	88 (0 - 255)	Raster Bottom	167 (0 - 255)	Raster Speed	10 (0 - 80)
Framing Status	Disabled*	Laser On Position	10 (10 - 90)	Laser Off Position	95 (15 - 95)
Laser Power	High*	Background Color	White*		

Callouts:

- Click once to select the index row; Double-click on any row to make specific changes in popup dialog
- Changes to settings in the **Current** row are dynamically updated in the reader and **ESP** settings
- Setting to any number other than zero will enable (same as <K252>)
- Number of times all indexes in the database are attempted before accepting the last index
- Loads the selected index to current
- Loads the Current settings to selected index
- Time or number of raster sweeps before switching to the next index
- Saves database to reader memory
- Time or number of raster sweeps to sequence indexes
- Receives database settings from the reader

From **ESP**, you enable **Database** by setting **Number of Active Database Indexes** to any number other than zero. The number chosen will cause that number of indexes in the database above to turn blue.

You can make changes to any setting in any row simply by double-clicking and changing the resulting popup dialog.

Save Current Settings to Database

You can change current settings in **ESP** by making changes in the **Current** row of the database or by making changes in the tree commands to the left of the database.

Saves settings currently enabled to the designated database index.

Serial Cmd: <**K253+**,database index>

Load Current Settings from Database

Loads selected database index settings into current reader settings.

Serial Cmd: <**K253-**,database index>

Example: <**K253-**,5> loads settings from database index # 5.

Chapter

6

Communications

Chapter Contents

Communications by ESP	6-2
Communications by Serial Command	6-2
RS-232/422 Host Port	6-3
RS-232 Auxiliary Port	6-8
Auxiliary Port System Data	6-18
Preamble	6-19
Postamble	6-20
LRC Status	6-21
Response Timeout	6-22

With Microscan's **ESP™** (Easy Setup Program), configuration changes can be made in the **ESP** menus, then sent and saved to your reader. The user can also send serial commands to the reader via the **ESP's Terminal** window.

This section includes connecting parameters and options for communicating by the auxiliary port and various interfaces.

Note: When assigning characters in user-defined fields, the characters **NULL**, **<**, **>**, and **,** can only be entered through embedded menus, not through **ESP** or serial commands.

Note: Default settings for establishing communications are:

Baud =	9600
Parity =	Even
Stop Bits =	One
Data Bits =	Seven
Flow Control =	None

Communications by ESP



Click this button to bring up the **Communications** menu.

To open nested options, **single-click** the +.

To change a setting, **double-click** the setting and use your cursor to scroll through the options.

Parameters	ESP Values
[-] Communications	
[-] RS232/422 Host Port	
+ Host Port Connections	
Host Protocol	Point-to-Point
+ RS232 Auxiliary Port	
[-] Preamble	Disabled
Preamble Characters	CR
+ Postamble	Enabled
Response Timeout	2
LRC Status	Disabled
Aux Port System Data Status	Disabled*
	Disabled*
	Enabled

Communications by Serial Command

Communications	
Host Port Connections	< K100 ,baud rate,parity,stop bits,data bits>
Host Protocol	< K140 ,protocol>
Auxiliary Port	< K101 ,aux port mode,baud rate,parity,stop bits,data bits,daisy chain status,daisy chain ID>
Daisy Chain Auto Configure	< K150DAISY >
Daisy Chain Scanner ID	< K151 ,daisy chain scanner,daisy chain scanner ID>
Auxiliary Port System Status	< K146 ,aux status>
Preamble	< K141 ,status,preamble>
Postamble	< K142 ,status,postamble>
LRC	< K145 ,status>
Response Timeout	< K143 ,timeout>

RS-232/422 Host Port

Includes host port connections and host protocols.

Host Port Connections

Baud Rate, Host Port

Usage: Can be used to transfer data faster or to match host port settings.

Definition: The rate at which the reader and host transfer data back and forth.

Serial Cmd: <**K100**,*baud rate*,*parity*,*stop bits*,*data bits*>

Default: **9600**

<i>Options:</i>	0 = 600	3 = 4800	6 = 38.4K
	1 = 1200	4 = 9600	7 = 57.6K
	2 = 2400	5 = 19.2K	8 = 115.2K

Parity, Host Port

Usage: Only changed if necessary to match host setting.

Definition: An error detection routine in which one data bit in each character is set to 1 or 0 so that the total number of 1 bits in the data field is even or odd.

Serial Cmd: <**K100**,*baud rate*,*parity*,*stop bits*,*data bits*>

Default: **Even**

<i>Options:</i>	0 = None	1 = Even	2 = Odd
-----------------	----------	----------	---------

Stop Bits, Host Port

Usage: Only changed if necessary to match host setting.

Definition: One or two bits added to the end of each character to indicate the end of the character.

Serial Cmd: <**K100**,*baud rate*,*parity*,*stop bits*,*data bits*>

Default: **One**

<i>Options:</i>	0 = One	1 = Two
-----------------	---------	---------

Point-to-Point with RTS/CTS

Usage: A reader initiates a data transfer with an RTS (request-to-send) transmission. The host, when ready, responds with a CTS (clear-to-send) and the data is transmitted. CTS and RTS signals are transmitted over two dedicated wires as defined in the RS-232 standard.

Used only with RS-232.

Definition: **Point-to-Point with RTS/CTS** (request-to-send/clear-to-send) is a simple hardware handshaking protocol that allows a reader to initiate data transfers to the host.

Serial Cmd: <K140,1>

Point-to-Point with XON/XOFF

Usage: If an XOFF has been received from the host, data will not be sent to the host until the host sends an XON. During the XOFF phase, the host is free to carry on other chores and accept data from other devices.

Used only with RS-232.

Definition: This option enables the host to send the XON and XOFF command as a single byte transmission command of start (^Q) or stop (^S).

Serial Cmd: <K140,2>

Point-to-Point with RTS/CTS & XON/XOFF

Usage: Used only with RS-232.

Definition: This option is a combination of **Point-to-Point with RTS/CTS** and **Point-to-Point with XON/XOFF**.

Serial Cmd: <K140,3>

Polling Mode D

Usage: When in **Polling Mode D**, an address of 1 is automatically displayed on the configuration screen. However, during transmission, a 1C hex poll address (FS) and a 1D hex select address (GS) are substituted for the 1.

Definition: Like **Point-to-Point**, **Polling Mode D** requires a dedicated connection to the host; but unlike **Point-to-Point**, it requires an address and must wait for a poll from the host before sending data.

Serial Cmd: <K140,4>

Multidrop

See also MS-860 Quick Start Help for Multidrop setup.

See also "**Multidrop Communications**" on page A-26.

Usage: The MS-5000 can be used as a concentrator to a single host port connection.

Definition: **Multidrop** allows up to 50 devices to be connected to a single RS-485 host, with the reader assigned a unique address (from 01 to 50). When **Multidrop** is selected, the protocol characters for RES, REQ, etc. are assigned automatically.

Multidrop Addresses: Each address has its own separate poll and select address (from 1C to 7F hex).

Serial Cmd: If selecting **Multidrop <K140,5>** an address must be defined and appended to the command string.

Format: **<K140,5,address[01 to 50]>**

Options: 01 through 50

Note: Readers linking up to a Microscan MS-5000 multidrop concentrator must be configured in standard multidrop protocol.

User Defined Point-to-Point

Usage: Used for developing custom protocols in polled or unpolled mode.

Definition: **User Defined Point-to-Point** allows the user to customize the point-to-point protocol.

Serial Cmd: **<K140,6,RES,address,REQ,EOT,STX,ETX,ACK,NAK>**

User Defined Address

Definition: **User Defined** is considered to be in a polled mode only if an address has been assigned.

Serial Cmd: **<K140,6,RES,address,REQ,EOT,STX,ETX,ACK,NAK>**

Default: No address

Options: Any ASCII character except a null.

User Defined Example

Example: An ACK/NAK protocol can be configured using **User Defined**. The reader will transmit data to the host when an **ACK** is received. If a **NAK** or response timeout occurs, the reader will re-send the data to the host up to 3 more times before aborting.

Tip: To use **User Defined Point-to-Point**, first select **Point-to-Point <K140,0>** and then **User Defined <K140,6>**.

Example: To select an unpolled ACK/NAK **User Defined** protocol with LRC disabled, send **<K140,0><K140,6,,,,,,^F,^U><K145,0>**. ACK and NAK will be displayed in the menu.

Tip: To use **User Defined Point-to-Point**, first select **Point-to-Point <K140,0>** and then **User Defined <K140,6>**.

Serial Cmd: **<K140,6,RES,address,REQ,EOT,STX,ETX,ACK,NAK>**

Default: **No assignment**

Options: Any ASCII character except a null. Control characters can be used to define RES through NAK in serial commands.

User Defined Multidrop

Note: Any ASCII character except a null (00) and a ^A (01) can be assigned as an address. Control characters can be used to define RES through NAK in serial commands. (See "**Communication Protocol Commands**" on page A-15.)

Usage: Used when connecting to a concentrator or other device that does not match standard multidrop protocol.

Definition: **User Defined Multidrop** allows the user to customize the polling protocol. If selecting **User Defined Multidrop** (7), complete the format by either choosing new parameters or place commas where unchanged data fields occur.

Serial Cmd: **<K140,7,RES,address,REQ,EOT,STX,ETX,ACK,NAK>**

For **User Defined Multidrop**, first select **Multidrop <K140,F140,5>**, then **User Defined Multidrop <K140,140,F7...>**.

Address: Any single character (02 hex to 7E hex) in the ASCII table can be assigned as the address character. The character chosen is used as the poll character and the subsequent ASCII character becomes the select character. For example, if a **^B** (02 hex) is selected as the address, **^C** (03 hex) becomes the select address that the host will use in sending host select commands.

Note: Definitions of commands in **User Defined** and **User Defined Multidrop** must be duplicated in host applications to enable poll and select sequences to execute correctly during transmission.

Note: Typically, parameters in **User Defined Multidrop** are defined by first enabling **Multidrop**, then enabling **User Defined Multidrop**. This pre-loads multidrop characters into the parameters. Then changes are made to individual characters to match the host or other requirements.

RS-232 Auxiliary Port

Note: The aux port cannot be used with RTS/CTS.

As with the host port parameters, the auxiliary terminal's settings (baud rate, parity, stop bits, and data bits) must be identical with those of the auxiliary device.

Usage: These commands set the communication parameters with the auxiliary port which can be used to configure menus, send data to the host, display data transmissions originating from the host of the reader, and relay data from other readers set in tandem (daisy chained). If the reader's host port needs to be dedicated to the host, but configuration must be done on the fly, the auxiliary port can be set to accept configuration changes by **Command Processing Mode** (see "**Command Processing Mode**" on page 6-14).

Definition: An auxiliary port connects the reader to a remote display or to other readers that can display or transfer data.

Aux Port Connections

As with the host port parameters, the auxiliary terminal's settings (baud rate, parity, stop bits, and data bits) must be identical with those of the auxiliary device.

Baud Rate, Aux Port

Usage: Can be used to transfer data faster or match an auxiliary device.

Definition: The rate at which the reader and host transfer data back and forth.

Serial Cmd: **<K101,aux port mode,baud rate,parity,stop bits,data bits,daisy chain ID status,daisy chain ID>**

Default: **9600**

<i>Options:</i>	0 = 600	3 = 4800	6 = 38.4K
	1 = 1200	4 = 9600	7 = 57.6K
	2 = 2400	5 = 19.2K	8 = 115.2K

Parity, Aux Port

Usage: Only changed if necessary to match host setting.

Definition: An error detection routine in which one data bit in each character is set to 1 or 0 so that the total number of 1 bits in the data field is even or odd.

Serial Cmd: **<K101,aux port mode,baud rate,parity,stop bits,data bits,daisy chain ID status,daisy chain ID>**

Default: **Even**

<i>Options:</i>	0 = None	1 = Even	2 = Odd
-----------------	----------	----------	---------

Transparent Mode

Usage: Often used in conjunction with handheld readers. Employs an auxiliary readout to detect mis-applied bar code symbols.

Definition: In **Transparent** mode data is passed between the auxiliary port and the host. The reader buffers data from the auxiliary port and echoes the keyed data on the auxiliary port. |

Data initiated from the Auxiliary Port

- Auxiliary port data is passed through to the host whenever a return key is pressed at the auxiliary port or symbol data is sent.
- Whenever aux port data is sent with symbol data, the aux port data will appear between the preamble and the symbol data.
- Auxiliary port data to the host is always sent with a preamble and a postamble.
- If the reader is in a polled mode to the host, auxiliary port data will still pass through.

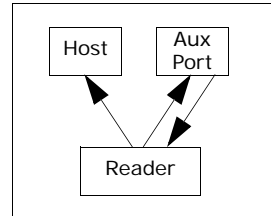

Data initiated from the Reader

- Transmission to the auxiliary port occurs immediately upon a good read.
- Scan data to the auxiliary port does not include a preamble or a postamble.
- Communications with the auxiliary port is always in Point-to-Point protocol, even if the host is in a polled protocol mode.

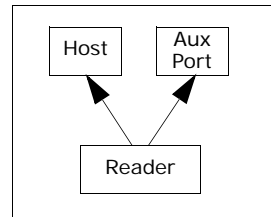

Data initiated from the Host

- All host data is echoed to the auxiliary port in unpolled and polled mode.

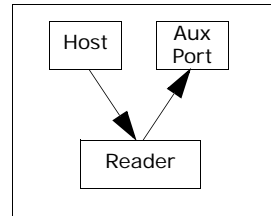

Serial Cmd: <**K101,aux port mode**,baud rate,parity,stop bits,data bits,daisy chain ID status,daisy chain ID>

1 = Transparent

Half Duplex Mode

Usage:

Used to display symbol data on an auxiliary screen close to the reader.

Definition:

In **Half Duplex** mode all auxiliary port data and symbol data is sent directly to the host. Symbol data is displayed on the auxiliary port screen at the same time the data is sent to the host.

Data initiated from the Auxiliary Port

- Auxiliary port data to the host is ignored if the reader is in a polled mode.
- Auxiliary port data or scanned data is sent to the host whenever it is received.
- Auxiliary port data is not echoed.
- Auxiliary port data to the host is always sent without a preamble or a postamble.

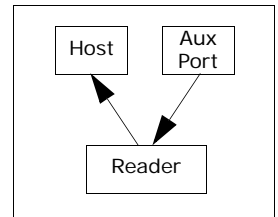

Data initiated from the Reader

- Scan data is transmitted to the auxiliary port at the same time it is transmitted to the host.
- Data transmission conforms with all parameters specified in the configuration menu (e.g., **Preamble**, **Postamble**, **End of Read Cycle**).

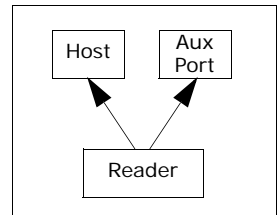

Data initiated from the Host

- All host data is echoed to the auxiliary port in unpolled mode.

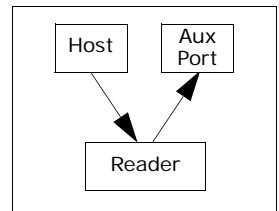

Serial Cmd: <**K101**, **aux port mode**, baud rate, parity, stop bits, data bits, daisy chain ID status, daisy chain ID>

2 = Half Duplex

Full Duplex Mode

Usage: Used when communication to and from the auxiliary port is required.

Definition: In **Full Duplex** mode all auxiliary port data and symbol data is sent directly to the host. Symbol data is not displayed on the auxiliary port screen.

Data initiated from the Auxiliary Port

- Auxiliary port data to the host is ignored if the reader is in a polled mode.
- Auxiliary port data or scanned data is sent to the host whenever it is received.
- Auxiliary port data is not echoed.
- Auxiliary port data to the host is always sent without a preamble or a postamble.

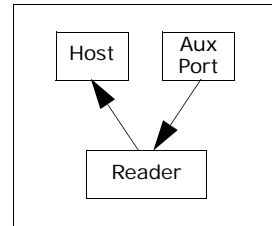

Data initiated from the Reader

- Scan data is not sent to the auxiliary port.

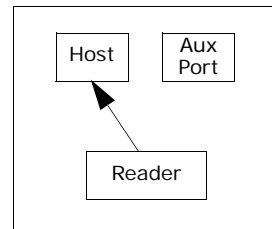

Data initiated from the Host

All host data is echoed to the auxiliary port in unpolled mode.

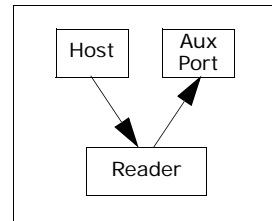

Serial Cmd: <**K101,aux port mode**,baud rate,parity,stop bits,data bits,daisy chain ID status,daisy chain ID>

3 = Full duplex

Daisy Chain Mode

Usage: Used in applications where:

- A symbol might be scanned in both ladder and picket fence directions.
- A bar code symbol may be present on multiple sides of a package.
- Bar code symbols are presented at different depths.

Definition: In a daisy chain application, readers are connected in tandem or “daisy chain” and decoded data is relayed from one reader to another on up to the host.

A master reader has its host port linked to the host computer and its auxiliary port linked to the host port of the first secondary reader in the chain. Thereafter, each secondary’s auxiliary port is linked to the host port of the secondary that is further from the host in the daisy chain.

Each reader in the daisy chain can be assigned an ID that accompanies any data that it sends.

Serial Cmd: <**K101,aux port mode**,baud rate,parity,stop bits,data bits,daisy chain ID status,daisy chain ID>

Options: **4 = Daisy chain**

Function: Before the master reader times out, it checks its auxiliary port for data. It should be set to wait at least **20mS** for each secondary in the daisy chain. (See **"Read Cycle Timeout"** on page 7-15.) If no data is received within the read cycle timeout, the master sends a noread message to the host. Otherwise the complete data is sent.

If for example the master reader is set to timeout in 120mS, the first secondary reader downstream might be set to 100mS, the next to 80mS, and so forth, thus assuring that at least 20mS elapses between transmissions.^a

Daisy-chained readers can send a series of symbols by enabling **Multi-symbol** and a common multisymbol separator. If the master reader does not receive the expected number of symbols, noread messages are appended to the data string to make up the difference between the number of symbols enabled in **Multisymbol** and the number of symbols read.

For example, a master and two secondary readers have **Number of Symbols** set to 3 and **Multisymbol Separator** defined as %. If the master and the first secondary reader do not find symbols, but the next secondary reader registers a good read, the transmitted results would be: symbol data % noread % noread.

a. The above example is based on the best case. Other factors such as baud rate, dynamic focus timing, number of characters in a given symbol, and the number of secondaries in the daisy chain can affect timing and may need to be included in your calculations for complete accuracy.

Conditions: The conditions for a daisy chain application are as follows:

1. The master reader's trigger must be **Serial** or **External**; the secondary readers' triggers are configured for **Serial**.
2. All readers are enabled to **Daisy Chain** mode.
3. Each reader's auxiliary port must be connected to the Host port of its secondary reader.
4. Each secondary reader in the daisy chain must be set to send its data no less than **20mS** before its preceding reader.
5. All but the master reader must have **Postamble** enabled and set to **CR (^M)** only.
6. All but the master reader must have their noread messages disabled.
7. If **Multisymbol** is enabled, **Multisymbol Separator** characters must match in all readers and **Number of Symbols** must be set to number large enough to include all the symbols it may itself read plus the number of symbols that it will be expected to relay to the host or the next reader up the line.
8. **Symbology ID** enable/disable must be the same in all readers.
9. All but the master reader must have their diagnostic warning messages disabled.
10. **Daisy Chain ID Status** enable/disable and the number of characters in **Daisy Chain ID** must be the same in all readers.

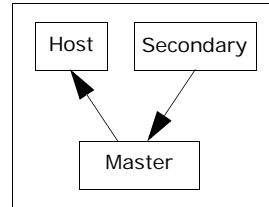

Command Processing Mode

Usage: Allows user to send configuration from the Host port or the AUX port.

Definition: When enabled, **Command Processing** allows commands to be entered via the aux port. The following rules apply:

1. Bar code data, including the serial trigger if used, will be transmitted to the last port from which a command was sent.
2. If a reset occurs, all data will be transmitted to the host port.

Serial Cmd: **<K101,aux port mode,baud rate,parity,stop bits,data bits,daisy chain ID status,daisy chain ID>**

Options: **5 = Command Processing**

Daisy Chain ID Status

Note: Enable/disable and length must be the same in all readers.

Usage: Used in a daisy chain setup in cases where the host needs to know which reader in a daisy chain setup sent the data.

Definition: Each reader in a daisy chain can be assigned a one or two character ID that will appear in front of decoded data and identify its source.

Serial Cmd: <**K101**,aux port mode,baud rate,parity,stop bits,data bits,**daisy chain ID status**,daisy chain ID>

Default: **Disabled**

Options: 0 = Disabled 1 = Enabled

Daisy Chain ID

Note: All secondary readers must be set to **Serial** for **Daisy Chain** to function.

See "**Trigger**" on page 7-6.

Usage: Used in a daisy chain setup in cases where the host needs to know which reader sent the data.

Definition: A one or two character prefix which identifies the particular daisy chain reader from which the data is being sent.

Serial Cmd: <**K101**,aux port mode,baud rate,parity,stop bits,data bits,**daisy chain ID status**,**daisy chain ID**>

Default: **1/**

Options: Any one or two ASCII characters.

Daisy Chain Autoconfigure

Note: Not in **ESP**.

Usage: For quick setup and configuration of the daisy chain network.

Definition: **Daisy Chain Autoconfigure** is issued to the master reader in the daisy chain and the software responds as follows:

- Counts the number of secondary readers in the daisy chain.
- Assigns an internal ID number (1...n) to each secondary reader, where the first secondary reader is number 1 (and it's own ID being a 0).
- Propagates the communications settings and the relevant operating modes of the master reader to the host and auxiliary ports of each secondary reader.
- Resets each secondary reader.
- Verifies that each secondary reader has acquired the new settings.

Serial Cmd: <**K150DAISY**>

Note: All secondary readers must be set to **Serial** for **Daisy Chain** to function.

See "**Trigger**" on page 7-6.

When setting up a daisy chain operation, do the following:

1. Set the master (the reader connected to the host) reader to **Serial**.

This sets all the readers in the daisy chain to **Serial** when the command is carried out.

Before **Autoconfigure** you must set the master reader to **Serial (S)**:



2. Send <**K150DAISY**> command.
3. If necessary, set the master reader to **Edge**.

After **Autoconfigure** you may set the master reader to **Edge (E)** but the other readers must remain in **Serial (S)**:



Daisy Chain Remote Secondary ID

Note: Not in **ESP**.

Usage: This command provides a handy way to assign custom daisy chain IDs to specific readers that were assigned during the daisy chain autoconfigure process.

Definition: Assigns a new daisy chain ID to a daisy chain secondary reader. The command is sent to the master reader to configure the other secondary readers.

Daisy Chain Reader Number

Definition: Specifies the target reader (by sequential number) which will be receiving the new Daisy Chain ID. The master reader is always 0 (zero). All secondary readers are numbered 1...n in the order that they are connected.

Note: These numbers are for assigning IDs only and are not changeable.

Serial Cmd: <**K151**,*daisy chain reader #*,*daisy chain reader ID*>

Options: 1...n (0 for the master reader)

Daisy Chain Reader ID

Definition: A two-character user-defined ASCII message identifying a reader in the daisy chain.

Serial Cmd: <**K151**,*daisy chain reader #*,*daisy chain reader ID*>

Default: Sequential numbering of reader units resulting from the Daisy Chain Auto-configure <**K150DAISY**> command; for example: ID Master = **1/**; ID Reader 1 = **2/**; ID Reader 2 = **3/**; etc.

Options: Any two characters except **NULL** <, or >.

Note: After a secondary reader accepts a new ID, it automatically invokes a reset-with-save command.

Auxiliary Port System Data

Note: Do not use this with **Daisy Chain** operation.

Auxiliary Port System Status

Note: This command only applies if **Aux Mode** is set to **Command Processing**.

See "**Command Processing Mode**" on page 6-14.

Usage: To check symbol data and error messages via the aux port.

Definition: When enabled, system data, including decoded data and diagnostic warning messages, will be routed to the aux port.

Serial Cmd: <**K146,aux status**>

Default: **Disabled**

Options: 0 = Disabled 1 = Enabled

Preamble

Preamble Status

Usage: Used for identifying and controlling incoming data. For example, defining the **preamble** as a carriage return and a line feed causes each decoded message to be displayed on its own line.

Definition: Defines a one to four character data string that can be added to the front of the decoded data.

Serial Cmd: <**K141**,*status*,*preamble character(s)*>

Default: **Disabled**

Options: 0 = Disabled 1 = Enabled (within any protocol)

Preamble Character(s)

Serial Cmd: <**K141**,*status*,*preamble character(s)*>

Default: **CR** (^M) corresponds to: **carriage return/null/null/null**.

Options: Up to four user-defined ASCII characters, including control characters.

Within a Serial Command

To enter control characters within a serial command, hold down the control key while typing the desired character.

Example: <**K141**,**1**,**CTRL-m**> to enter **^M**

Within an Embedded Menu

Control characters entered on the command line are displayed in the menu as mnemonic characters, such as: <**CR**><**NUL**><**NUL**><**NUL**>.

To enter a control character from within an embedded menu, first type in a space (with the space key). This has the effect of allowing the control key to be recognized as a part of the control character. Next hold down the control key while typing the desired character.

Example: **Space CTRL-m** to enter **^M**.

Postamble

Postamble Status

Usage: Used for identifying and controlling incoming data. For example, defining the postamble as a carriage return and a line feed causes each decoded message to be displayed on its own line.

Definition: Defines a one to four character data string that can be added to the end of the decoded data.

Serial Cmd: <**K142,status,postamble character(s)**>

Default: **Enabled**

Options: 0 = Disabled 1 = Enabled (within any protocol)

Postamble Character(s)

Serial Cmd: <**K142,status,postamble character(s)**>

Default: **CR LF** (^M^J) Corresponds to carriage return/line feed/null/null, as displayed in the menu.

Options: Up to four user-defined ASCII characters, including control characters.

Within a Serial Command

To enter control characters within a serial command, hold down the control key while typing the desired character.

Example: <**K142,1,CTRL-m CTRL-j**> to enter ^M^J.

Within an Embedded Menu

Control characters entered on the command line are displayed in the menu as mnemonic characters, such as: <**CR**><**LF**><**NUL**><**NUL**>

To enter a control character from within an embedded menu, first type in a space (with the space key). This has the effect of allowing the control key to be recognized as a part of the control character. Next hold down the control key while typing the desired character.

Example: **Space CTRL-m Space CTRL-j** to enter ^M^J.

LRC Status

(Longitudinal Redundancy Check)

Usage: Used when extra data integrity is required.

Definition: An error-checking routine that verifies the accuracy of transmissions. It is the exclusive OR of all characters following the **STX** (start of text) up to and including the **ETX** (end of text). What this means is that the binary representation of all the characters in a transmissions are cumulatively added in a column and each resulting odd integer is assigned a 1 and each even integer a 0 (two 1s = 0, two 0s = 0, a 1 and a 0 = 1). The extra **LRC** character is then appended to the transmission and the receiver connected to the host port performs the same addition and compares the results.

Serial Cmd: <**K145,status**>

Default: **Disabled**

Options: 0 = Disabled 1 = Enabled

Response Timeout

Usage: Used only when a response is required from the host. While in **Multi-drop**, if the reader does not receive an **ACK** or **NAK** from the host after sending polled data, it will act on a fault. The reader can be set to wait indefinitely by setting **Response Timeout** to zero.

Definition: Time the reader will wait before timing out if **ACK**, **NAK**, and **ETX** are enabled, and a host response is expected.

Serial Cmd: **<K143,response timeout>**

Default: **2** (x 10 = 20 mS)

Options: 0 to 255 in 10mS increments (0 to 2.55 seconds)
(A zero (0) setting causes an indefinite wait.)

Chapter

7

Read Cycle

Chapter Contents

Read Cycle by ESP	7-2
Read Cycle by Serial Command	7-3
Multisymbol	7-4
Trigger	7-6
Serial Trigger.....	7-12
End of Read Cycle	7-14
Decodes Before Output	7-16
Reader Setup	7-17
Laser Setup	7-22
Raster Setup	7-22

After you've established communications and completed basic read rate testing, you will need to address the spatial and timing parameters associated with your application. In a typical operation a bar coded item moves along a line past a reader. A trigger or timer activates a read cycle during which the reader actively searches for symbols. You will need to decide how to initiate the read cycle and how and when to end it.

Note: When assigning characters in user-defined fields, the characters **NULL**, **<**, **>**, and **,** can only be entered through embedded menus, not through **ESP** or serial commands.

Note: You can learn the current setting of any parameter by inserting a question mark after the number, as in **<K100?>**. To see all "K" commands, send **<K?>**.

Note on Serial Commands: To preserve continuity with other Microscan products, some serial configuration commands may include 0s (zeros) or 1s as placeholders. In order for a these commands to be implemented, the parameter values or a comma must be included.

Read Cycle by ESP

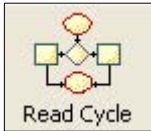

Click this button to bring up the **Read Cycle/Triggering** menu

To open nested options, **single-click** the +.

To change a setting, **double-click** the setting and use your cursor to scroll through the options.

Parameters	ESP Values
[-] Read Cycle	
[+] Multisymbol	
[-] Trigger	
... Mode	Continuous Read
... Trigger Filter Duration	10
... External Trigger State	Active Closed
[+] Serial Trigger	
[-] End of Read Cycle	
... Mode	Timeout
... Read Cycle Timeout	100
[+] Decodes Before Output	
[+] Database Control	
[+] Reader Setup	
[+] Laser Setup	
[-] Raster Setup	
Status	Enabled*
... Top Offset	Disabled
... Bottom Offset	Enabled*
... Sweep Rate	10
... Read Cycle On/Off	Disabled

Read Cycle by Serial Command

Read Cycle	
Multisymbol	< K222 , number of symbols, multisymbol separator>
Trigger Mode	< K200 , trigger mode, trigger filter duration>
External Trigger State	< K202 , external trigger state>
Serial Trigger Character	< K201 , serial trigger character>
Start Serial Trigger Character	< K229 , start trigger character>
Stop Serial Trigger Character	< K230 , stop trigger character>
End of Read Cycle	< K220 , end of read cycle mode, read cycle timeout>
Decodes Before Output	< K221 , number before output, decodes before output mode>
Configuration Database Control	
Database Setup	< K253 , index, gain, AGC mode, tracking, raster top, raster bottom, raster speed, laser framing status, laser on position, laser off position, laser power, background color>
Database Operation	< K252 , number of active indexes, database cycles>
Database Mode	< K254 , mode, count/time>
Save Current to Database	< K253+ , database index>
Load Current from Database	< K253- , database index>
Reader Setup	
Tracking	< K520 , tracking>
Scan Speed	< K500 , scan speed>
Automatic Gain Control	< K504 , gain level, AGC sampling, AGC min, AGC max>
Symbol Detect Status	< K505 , symbol detect status, transition counter>
Maximum Element	< K502 , maximum element>

Multisymbol

- Usage:* Commonly used in shipping applications where a shipping symbol contains individual bar codes for part number, quantity, etc. This feature allows one trigger to pick up all the symbols. AIAG and UCC/EAN-128 are two application standards that address this need.
- Definition:* Allows the user to set up conditions that will allow more than one symbol to be decoded and output.
- Conditions* The following conditions apply:
1. All noread messages are posted at the end of the data string.
 2. If more than one symbol is within the scan beam at the same time, symbol data may not be displayed in the order of appearance.
 3. If **Matchcode Type** is set to **Sequential** or if **Trigger** is set to **Continuous Read 1 Output**, **Number of Symbols** will default to **1** (if set to any number greater than 1).
 4. The maximum number of characters in any one linear symbol is **128**.
 5. The maximum number of output characters for all symbols is **3072**, including separators, and optimal formatting.

Number of Symbols

- Usage:* Commonly used where a shipping symbol contains individual symbols for part number, quantity, etc. UCC/EAN-128 is an example of a symbology that address this need.
- Definition:* **Number of Symbols** allows the user to define up to 12 bar code symbols that can be read in a single read cycle.
- Conditions:* The following conditions apply:
1. When **Number of Symbols** is set to **Single**, the read cycle ends when one symbol is decoded and output.
 2. When **Number of Symbols** is set to **Multiple**, all decoded symbol data (for both the same and different symbols) are output while the read cycle is active and/or no timeout has occurred.
- Serial Cmd:* <**K222,number of symbols,multisymbol separator**>
- Default:* **1**
- Options* 1 to 12

Multisymbol Separator

Usage: Used to separate decoded data from more than one symbol.

Definition: A user-defined character that's inserted between each symbol scanned when **Multisymbol** is set to any number greater than 1.

ESP: To select a new multisymbol separator, double-click on **Separator** and select a character in the popup window.

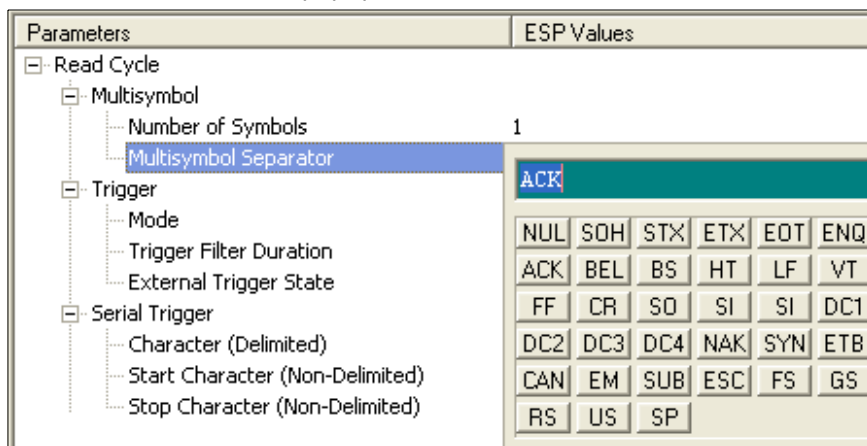

Serial Cmd: <**K222**, number of symbols, **multisymbol separator**>

Note: If **Multisymbol Separator** has been changed to any character other than the default comma and you wish to re-define the separator as a comma, use **ESP** or the embedded menu.

Default: , (comma)

Options: Any available ASCII character, except <, >, and **NUL**.

Trigger

Trigger Mode

Definition: The type of trigger event that will initiate the read cycle.

Serial Cmd: <**K200**,*trigger mode*,*trigger filter duration*>

Default: **Continuous Read**

Options:

0 = Continuous Read	3 = External Edge
1 = Continuous Read 1 Output	4 = Serial Data
2 = External Level	5 = Serial Data & External Edge

Continuous Read

Usage: **Continuous Read** is useful in testing symbol readability or reader functions. It is not recommended for normal operations.

Definition: In **Continuous Read**, trigger input options are disabled, the reader is always in the read cycle, and it will attempt to decode and output every scan crossing a symbol. **When To Output** and **Noread** options have no effect on **Continuous Read**.

Serial Cmd: <**K200**,**0**>

Continuous Read 1 Output

Usage: **Continuous Read 1 Output** can be useful in applications where it is not feasible to use a trigger and all succeeding symbols contain different information. It is also effective in applications where the objects are hand-presented.

Definition: In **Continuous Read 1 Output** the reader self-triggers whenever it decodes a new symbol or a timeout occurs.

If **End Of Read Cycle** is set to **Timeout** and the symbol doesn't change, the reader will repeat the output at the end of each timeout period. For example, if **Timeout** is set to one second, the reader sends the symbol data immediately and repeats the output at intervals of one second for as long as the symbol continues to be scanned.

If **End Of Read Cycle** is set to **New Trigger**, the reader will send the current symbol data immediately, but send it only once. A new symbol appearing in the reader's range will be read and sent immediately provided it is not identical to the previous symbol read.

Serial Cmd: <**K200,1**>

Caution: In automated environments, **Continuous Read 1 Output** is not recommended because there is no one to verify that a symbol was missed.

Note: If **Trigger** is set to **Continuous Read 1 Output**, **Number of Symbols** will default back to **1** (if set to any number greater than 1).

External Level

Usage: This mode is effective in an application where the speeds of the conveying apparatus are variable and the time the reader spends scanning each object is not predictable. It also allows the user to determine if a noread has occurred.

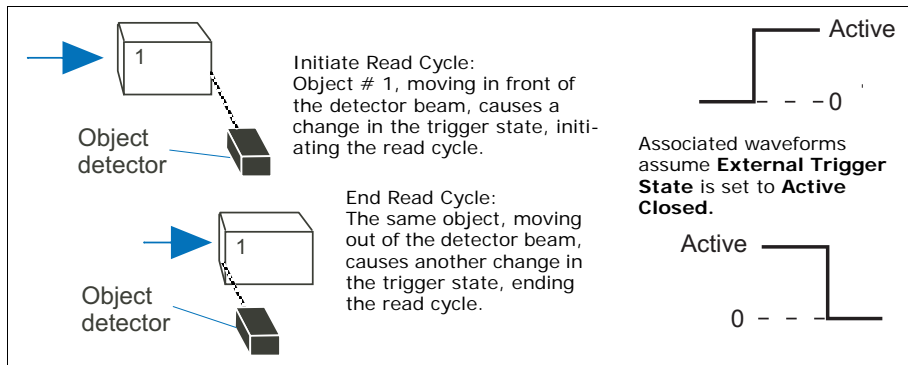

External Level Trigger

Definition: **External Level** allows the read cycle to begin when a trigger (change of state) from an external sensing device is received. The read cycle endures until the object moves out of the sensor range and the active trigger state changes again.

Serial Cmd: <K200,2>

Important: **Level** and **Edge** apply to the active logic state (**Open** or **Closed**) that exists while the object is in a read cycle, between the rising edge and falling edge. *Rising edge* is the trigger signal associated with the appearance of an object. *Falling edge* is the trigger signal associated with the subsequent disappearance of the object.

External Edge

Usage: This mode is highly recommended in any application where conveying speed is constant or if spacing, object size, or timeouts are consistent.

Definition: **External Trigger Edge**, as with **Level**, allows the read cycle to begin when a trigger (change of state) from an external sensing device is received. However, the passing of an object out of sensor range does not end the read cycle. The read cycle ends with a good read output or, depending on **End of Read Cycle** setting, a timeout or new trigger occurs. **External Trigger Edge**, as with **Level**, allows the read cycle to begin when a trigger (change of state) from an external sensing device is received. However, the passing of an object out of sensor range does not end the read cycle. The read cycle ends with a good read or with a noread when a **No Decode Timeout** occurs.

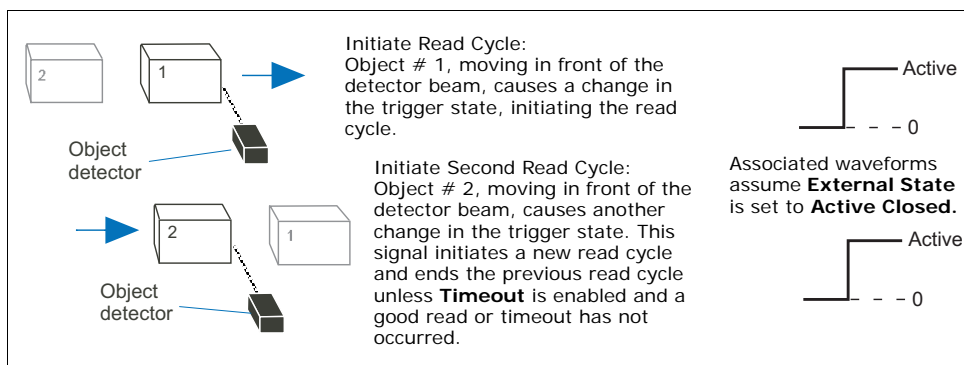

External Edge Trigger

Serial Cmd: <K200,3>

Important: **Level** and **Edge** apply to the active logic state (**Open** or **Closed**) that exists while the object is in a read cycle, between the rising edge and falling edge. *Rising edge* is the trigger signal associated with the appearance of an object. *Falling edge* is the trigger signal associated with the subsequent disappearance of the object.

Serial Data

Usage: Highly recommended in any application where conveying speed is constant or if spacing, object size, or timeouts are consistent.

Definition: In **Serial Data**, the reader accepts an ASCII character from the host or controlling device as a trigger to start a read cycle. A **Serial Data** trigger behaves the same as an **External Edge** trigger.

Serial Cmd: <K200,4>

Trigger

Serial Data or External Edge

Usage: **Serial Data or External Edge** is seldom used but can be useful in an application that primarily uses an external sensing device but occasionally needs to be manually triggered. An auxiliary terminal can be connected to the aux port so the user can send the serial trigger character through the reader to the host.

Definition: In this mode the reader accepts either a serial ASCII character or an external trigger pulse to start the read cycle.

Serial Cmd: <**K200,5**>

Trigger Filter Duration

- Usage:* **Trigger Filter Duration** is useful where trigger bounce or noise pulses could cause false triggers.
- Definition:* **Trigger Filter Duration** is the minimum time that must elapse before a trigger pulse is considered valid.
- Serial Cmd:* <**K200**,*trigger mode*,**trigger filter duration**>
- Default:* **10** (1 mS)
- Options:* 0.1 mS to 500 mS (in 0.1 mS increments)

External Trigger State

Note: **External Level**, **External Edge**, or **Serial Data or Edge** trigger mode must be enabled for **External Trigger** to take effect.

- Usage:* Users can select the trigger state that will operate with their systems. (If using the Microscan object detector, use **Active Closed**.)
- Definition:* Determines whether a positive or negative transition will initiate the read cycle.
- Serial Cmd:* <**K202**,*external trigger state*>
- Default:* **Active closed**
- Options:* 0 = Active open 1 = Active closed

Important: The MS-860 is physically different from the MS-850 in trigger polarity and the calculation of raster sweeps.

Serial Trigger

- Usage:* Defines the trigger character that initiates the read cycle.
- Definition:* An on-line host command composed of a single ASCII host serial trigger character that initiates or ends the read cycle.
- Trigger characters are of two types: delimited and non-delimited. A delimited character is enclosed within angle bracket delimiters `< >`.
- A non-delimited trigger character is one that either starts or ends the read cycle and is NOT enclosed by delimiters such as `< >`.

Serial Trigger Character

- Usage:* Useful in applications where a single serial character enclosed in angle brackets initiates the read cycle.
- Definition:* A trigger character is one that starts the read cycle, is enclosed by delimiters `< >` and can only be sent when the trigger mode is set to **Serial Data** or **Serial Data & Edge**.
- Serial Cmd:* `<K201,serial trigger character>`
- Default:* `^J` (corresponds to `<GS>`)
- Options:* Any single 7-bit ASCII character, including control characters, except NUL (00H), an existing host command character, or an on-line protocol character.

Note: **Serial Data** or **Serial Data & Edge** triggering mode must be enabled for Serial Trigger Character to take effect.

Non-delimited Start and Stop Characters

Note: If the serial trigger character that you assign is already assigned as an operational command—for example a “Z” character that is used in the **<Z>** command—the command will no longer function as intended.

Both **Start** and **Stop** non-delimited characters can be defined and will function according to the trigger event, as follows:

When defining **Start** and **Stop** trigger characters, the following rules apply:

- In **External Edge** the reader looks only for the start trigger character and ignores any stop trigger character that may be defined.
- In **External Level**, the start trigger character begins the read cycle and stop trigger character ends it. Note that even after a symbol has been decoded and the symbol data transmitted, the reader remains in **External Level** trigger read cycle until a **Stop** character is received.
- In **Serial Data & Edge** trigger mode, command, either a **Start Trigger Character** or a hardware trigger can start an **Edge** trigger read cycle.

Start Character (non-delimited)

Usage: Useful in applications where different characters are required to start and end a read cycle.

Definition: A single ASCII host serial trigger character that starts the read cycle and is not enclosed by delimiters such as **<** and **>**.

Serial Cmd: **<K229,start trigger character>**

Default: **Null** (disabled)

Options: Two hex digits representing an ASCII character except **<**, **>**, **XON** and **XOFF**.

Stop Character (non-delimited)

Usage: Useful in applications where different characters are required to start and end a read cycle.

Definition: A single ASCII host serial trigger character that ends the read cycle and is not enclosed by delimiters such as **<** and **>**.

Serial Cmd: **<K230,stop trigger character>**

Default: **Null** (disabled)

Options: Two hex digits representing an ASCII character except **<**, **>**, **XON** and **XOFF**.

See Appendix E, "**ASCII Table**", for ASCII character information.

End of Read Cycle

Note: **When to Output** must be set to **End of Read Cycle** before this command can be active.

Definition: The read cycle is the time during which the reader will attempt to read and decode a symbol. At the end of a read cycle the reader stops reading symbols and sends the symbol data or noread message to the host.

End of Read Cycle Mode

Definition: A read cycle can be terminated by a new trigger, a timeout, or a combination of both.

Serial Cmd: **<K220,end of read cycle,read cycle timeout>**

Default: **Timeout**

Options: 0 = Timeout 1 = New Trigger 2 = Timeout & New Trigger

Note: When operating in **Continuous Read** or **Continuous Read 1 Output**, the reader is always in the read cycle.

Timeout

Usage: Typically used with **Serial** or **Edge** and **Continuous One**.

It is effective in highly controlled applications when the maximum length of time between objects can be predicted. It assures that a read cycle ends before the next bar coded object appears, giving the system extra time to decode and transmit the data to the host.

Definition: **Timeout** ends the read cycle when the time set in **Read Cycle Timeout** elapses or "times out."

If in **Continuous Read 1 Output**, a timeout initiates a new read cycle and allows the same symbol to be read again.

With either **External Edge**, **Serial Data**, or **Serial Data & Edge** enabled, a timeout ends the read cycle and symbol data or a noread message is sent to the host.

With **External Level** enabled, the read cycle does not end until the falling edge trigger or a timeout occurs. The next read cycle does not begin until the next rising edge trigger.

New Trigger

Usage: **New Trigger** is an effective way to end a read cycle when objects move past the reader at irregular intervals (not timing dependent).

Definition: **New Trigger** ends the current read cycle and initiates a new one when a new trigger occurs. **New Trigger** refers only to a “rising edge” trigger. With either **External Edge**, **Serial**, or **Serial or Edge** enabled, an edge or serial trigger ends a read cycle and initiates the next read cycle. In the case of **External Level**, a falling edge trigger ends the read cycle but the next read cycle does not begin until the occurrence of the next rising edge trigger.

Note: When **New Trigger** is enabled and if not in **External Level** mode, **Laser On/Off** will have no effect. When noreads occur, the laser will remain on.

Timeout or New Trigger

Usage: Useful in applications that require an alternative way to end the read cycle. For example, if an assembly line should stop completely or the intervals between objects are highly irregular.

Definition: **Timeout or New Trigger** is identical to **Timeout**, except that a timeout or a new trigger (whichever occurs first) ends the read cycle.

Read Cycle Timeout

Usage: Useful in many tightly controlled applications which require a read cycle to end before the next object appears and therefore need the flexibility of a timeout adjustment.

Definition: **Read Cycle Timeout** is the time span of the read cycle and is represented in 10 mS increments. It is used in conjunction with **External Edge** or **Serial Trigger**.

Serial Cmd: <**K220**, end of read cycle, *read cycle timeout*>

Default: **100** (Corresponds to one second or 1000 mS.)

Options: 1 to 65535. (Divide any positive number entered by 100 to determine the time in seconds.)

Timeout does not function when in **Continuous** or **Level** read cycle modes.

Continuous 1: The reader will only read a given symbol once until a timeout occurs or a different symbol is presented.

Note: A minimum setting of **2** is recommended.

Note: **Timeout** or **Timeout or New Trigger** under **End of Read Cycle** must be enabled for **Read Cycle Timeout** to take effect.

Decodes Before Output

Note: When setting up, determine if the reader's scan speed is capable of scanning your longest symbol the required number of times.

Decodes Before Output Mode

Usage: Useful when the highest level of reliability is required.

Definition: When consecutive is enabled, the number set in **Decodes Before Output** must be achieved consecutively before decoded data is sent. For example, if **Number Before Output** is set to 5, then the data will be output whenever five decodes occur in succession.

When the default non-consecutive is set, whenever a cumulative number of decodes is achieved, decoded data is sent. For example, if non-consecutive is enabled and **Decodes Before Output** is set to 10, then data will be sent when the total number of decodes reaches 10 regardless of the number of bad reads between decodes.

Serial Cmd: <**K221**,number before output,**decodes before output mode**>

Default: **Non-consecutive**

Options: 0 = Non-consecutive 1 = Consecutive

Number Before Output

Usage: This is a very useful feature to increase reliability of reads for symbologies that do not have internal error checking such as Pharmacode.

Definition: The number of decodes required per symbol before a symbol's decoded data is sent. It requires the reader to successfully decode a symbol a designated number of times before it is sent. If it doesn't achieve the number of good reads during the read cycle, then a no-read will be sent.

Note: Higher settings will decrease throughput speed.

Serial Cmd: <**K221**,number before output,**decodes before output mode**>

Default: **1**

Options: 1 to 255

Reader Setup

Gain Level

Usage: Can be useful for fine-tuning gain or when portions of analog signals spike, as in the case of specular reflection or extraneous noise.

Definition: Sets a voltage amplitude value for the analog circuitry.

Serial Cmd: <**K504,gain level**,AGC sampling,AGC min,AGC max>

Default: **50** (low or medium density reader)

Note: **Gain Level** is optimized at the factory before shipment; the default value may not be 50.

Options: 0 to 255

Tracking

Usage: Useful in fine-tuning tracking or when conditions of poor contrast or blurred bar edges exist.

Caution: Changes to **Tracking** are typically done in **Calibration**. See Chapter 4, "**Calibration**".

Definition: Tracks peak signals and selects an amplitude reference point to sample the analog signals for converting to digital.

Serial Cmd: <**K520,tracking**>

Default: **45** (low or medium density reader)

Tracking is optimized at the factory before shipment; the default value may not be **45**.

Options: 10 to 127

Scan Speed

Usage: To ensure a minimum number of scans, faster scan speeds are typically used for fast moving symbols and/or longer symbols with larger bar widths. See "**Formulas for Number of Decodes**" on page A-27.

Note: Scan beams move faster across symbols further out in the scan range since the moving beam is being projected from a spinning mirror.

Definition: Allows the user to set the number of scans per second by controlling the spinning mirror motor speed.

Serial Cmd: <**K500,scan speed**>

Default: **50** (x 10) low or medium density reader

Options: 30 to 120

Automatic Gain Control (AGC)

AGC Sampling Mode

Usage: **AGC Sampling** allows you to specify how automatic gain control sampling will be done.

Definition: AGC is the acronym for Automatic Gain Control. AGC increases the depth of field by attempting to maintain signal strength at a constant level regardless of the range of the bar code symbol.

Serial Cmd: <**K504**,gain level,**AGC sampling mode**,AGC min,AGC max>

Default: **Continuous**

Options: 0 = Disabled 1 = Leading Edge 2 = Continuous

Disabled

Usage: **Disabled** is not recommended, but can be useful in certain applications in which symbols do not require a large depth of field.

Definition: When **AGC Sampling** is set to **Disabled**, gain levels can only be manually controlled by the **Gain** command.

Leading Edge

Usage: **Leading Edge** is rarely used, but in some cases can improve scan rates when symbols are skewed and the leading edge of a symbol is difficult to locate.

Definition: Finds the leading edge of a symbol by looking for a 40 μ S quiet zone followed by the number of transitions set in "**Transition Counter**" on page 7-21, stores the highest value of the samples, and adjusts the AGC accordingly at the end of the scan.

Continuous

Usage: **Continuous** is the default and the preferred mode for sampling analog signal amplitude.

Definition: Samples AGC throughout the scan at the rate set in "**Transition Counter**" on page 7-21, averages the sample values, and adjusts the AGC value at the end of the scan.

AGC Minimum Gain

Definition: Limits the minimum range of the available gain.

Serial Cmd: <K504,gain level,AGC sampling mode,AGC min,AGC max>
Send <K504?> for a readout.

Default: 0 (low or medium density reader)

Options 0 to 255

AGC Maximum Gain

Definition: Limits the maximum range of the available gain.

Serial Cmd: <K504,gain level,AGC sampling mode,AGC min,AGC max>
Send <K504?> for a readout.

Default: 255 (low or medium density reader)

Options 0 to 255

Symbol Detect Status

Definition: During the read cycle, the reader counts the number of bar and space transitions defined in the **Transition Counter**. If the count matches or exceeds the threshold, the reader will perform AGC routines. When enabled, a bad symbol or no symbol message can be output rather than a noread message, depending on the number of transition counts.

Serial Cmd: <K505,symbol detect status,transition counter>

Default: **Disabled**

Options: 0 = Disabled 1 = Enabled

Note: **Symbol Detect** can only be used when "**AGC Sampling Mode**" on page 7-19 <K504> is set to **Fixed Gain** and "**No Symbol Message**" on page 10-9 <K716> output is enabled.

Transition Counter

Usage: Can be useful in certain application where extraneous objects in the field of view might require a higher threshold.

Definition: Determines the number of bar/space transitions that are sampled before AGC can be resolved.

Definition: Determines the number of bar/space transitions that must be read before a symbol is considered present and AGC can be resolved.

Serial Cmd: <**K505**,symbol detect status,**transition counter**>

Default: **16** (low or medium density reader)

Options: 1 to 255

Note: **Transition Counter** is used for both AGC and symbol detection routines (see "**No Symbol Message**" on page 10-9).

Maximum Element

Usage: **Caution:** Do not change this parameter unless instructed by a your technical representative.

Definition: Maximum Element represents the maximum bar element width that's allowed before a video reset occurs (defaults to white), as measured in the percentage of the reader's full scan width (NOT the framed scan width).

Serial Cmd: <**K502**,**maximum element**>

Default: **400** (low or medium density reader)

Options: 50 to 5000 (in increments of 0.01% of scan)

Note: Values represent the reader's full scan width, NOT the framed area.

Laser Setup

See "[Laser Setup](#)" on page 8-6 for details on laser setup.

Raster Setup

See "[Raster Setup](#)" on page 8-3 for details on raster setup.

Chapter

8

Raster/Laser

Chapter Contents

Raster/Laser Setup by ESP	8-2
Raster/Laser Setup by Serial Command	8-2
Raster Setup	8-3
Laser Setup	8-6

This section explains the setup and adjustments for the raster and the laser setups.

Note: The characters **NULL**, **<**, **>**, and **,** can only be entered through embedded menus, not through **ESP** or serial commands.

Raster/Laser Setup by ESP



Click on this button to bring up the Raster/Laser menu.

To open nested options, single-click the +.

Parameters	ESP Values
[-] Raster / Laser Settings	
[-] Raster Setup	
[-] Laser Setup	
Laser On/Off	Disabled
Laser Framing	Disabled
Laser On Position	10
Laser Off Position	95
Laser Power	High*
	Low
	Medium
	High*

To change a setting, double-click on the setting and use your cursor to scroll through the options.

Note: Raster setup commands in the ESP are accessed from the Read Cycle/Triggering menu or from the Raster/Laser or Calibration menus on the ESP toolbar.

Raster/Laser Setup by Serial Command

Raster/Laser	
Raster Setup	<K506,raster status,top offset,bottom offset,raster sweep rate,read cycle on/off>
Laser Setup	<K700,laser on/off status,laser framing status,laser on position,laser off position,laser power>

Raster Setup

You can setup and make changes to the reader's raster parameters in **ESP** in the **Read Cycle** menu, the **Calibration** menu, or the **Raster/Laser** menu (preferred).

Usage: Raster scanning is useful when symbols vary in placement and a single scan line cannot be counted on to cross the symbol, and for reading stacked symbologies such as PDF417.

Definition: The user can enable raster scanning and adjust the raster sweep limits and the sweep rate.

Raster Status

Definition: When disabled, the raster mirror will park at the top of the raster sweep.

Serial Cmd: <**K506,raster status**,top offset,bottom offset,raster sweep rate,read cycle on/off>

Default: **Enabled**

Options: 0 = Disabled 1 = Enabled

Note: Raster sweeps are only counted during a read cycle (continuous, triggered, and read rate). Raster sweeps are NOT counted when the raster motor is parked, disabled, set to straight line operation (top and bottom are equal), or when performing a self-calibration.

Raster Setup

Top Offset

Definition: Decreasing the **Top Offset** value causes the top of the raster pattern to move up.

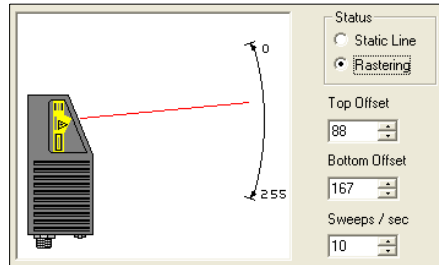

Serial Cmd: <K506,raster status,**top offset**,bottom offset,raster sweep rate,read cycle on/off>

Default: 88

Options: 0 to 255

Bottom Offset

Definition: Increasing the **Bottom Offset** value causes the bottom of the raster pattern to move down.

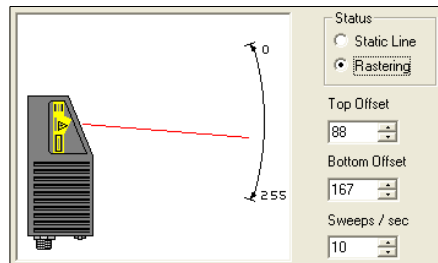

Serial Cmd: <K506,raster status,top offset,**bottom offset**,raster sweep rate,read cycle on/off>

Default: 167

Options: 0 to 255

Note: For single scan line operation, set **Top Offset** equal to **Bottom Offset** or click on the **Static Line** option.

Note: Assigning a larger value to **Top Offset** than **Bottom Offset** will park the raster mirror in its "home" (default) position.

Raster Sweep Rate

- Usage:** If your application allows it, a slower sweep rate can produce more scans per second and higher read rates. To determine the minimum read rate for your application, see "**Raster Picket Fence Calculation**" on page A-21.
- Definition:** The raster sweep rate is the number of sweeps per second the raster mirror completes. A sweep is one pass of the raster, up or down. The maximum sweep rate is limited by the size of the arc the raster must move through.
- Serial Cmd:** <**K506**,*raster status,top offset,bottom offset,raster sweep rate,read cycle on/off*>
- Default:** **10**
- Options:** 0 to 80.
To maximize the number of scans per symbol, use the lowest effective sweep rate required for the application.

Important: The MS-860 is physically different from the MS-850 in trigger polarity and the calculation of raster sweeps.

Read Cycle On/Off

- Usage:** This feature should only be used when the raster sweep rate is at least twice the required trigger rate (decoded outputs per second).
- Definition:** When **Read Cycle On/Off** is enabled and **Laser On/Off** is also enabled, the raster mirror stops at top offset at the end of triggered read cycle.
- Serial Cmd:** <**K506**,*raster status,top offset,bottom offset,raster sweep rate,read cycle on/off*>
- Default:** **Disabled**
- Options:** 0 = Disabled 1 = Enabled

Laser Setup

To access the **Laser Framing** menu, click the **Raster/Laser** button and the **Laser Framing** tab.

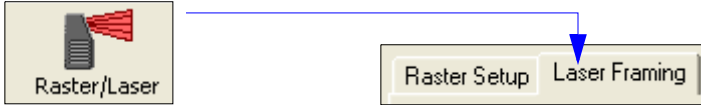

Laser On/Off

Usage: **Laser On/Off** extends the life of the laser. It is useful where there are significant time gaps between symbols. It also provides visual confirmation of a read cycle timeout and minimizes laser exposure to people.

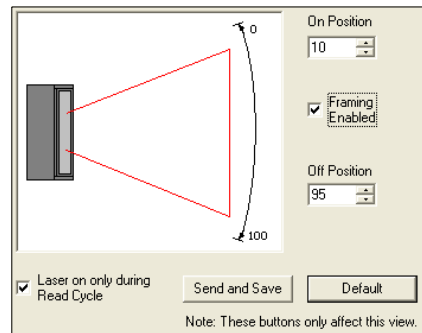

Definition: When enabled, the laser is ON only during the read cycle. When disabled, the laser operates continuously.

Serial Cmd: **<K700,laser on/off status,laser framing status,laser on position,laser off position,laser power>**

Default: **Disabled**

Options: 0 = Disabled 1 = Enabled

To enable **Laser On/Off**, check the **Laser on only during Read Cycle** checkbox and click **Send and Save**.

Laser Framing

Usage: Useful in avoiding highly reflective objects, for filtering out unwanted signals, or avoiding the wrong symbols.

Definition: When **Laser Framing** is disabled, the laser is ON for 100 percent of the full scan. When enabled, the extent of the laser arc is determined by the **Laser On Position** and **Laser Off Position** settings.

Serial Cmd: <**K700**,laser on/off status,**laser framing status**,laser on position,laser off position,laser power>

Default: **Disabled**

Options: 0 = Disabled 1 = Enabled

Manual Adjustment

To adjust laser framing, check the **Laser Framing** box as shown in the illustration and click the **Send and Save** button.

After saving, handles will appear at the upper and lower ends of the laser frame when the cursor enters the **Laser Framing** pane. When it touches either handle, the cursor becomes a double arrow. Left click and you can drag the handle to another position as shown dynamically in the **On Position** and **Off Position** selector boxes.

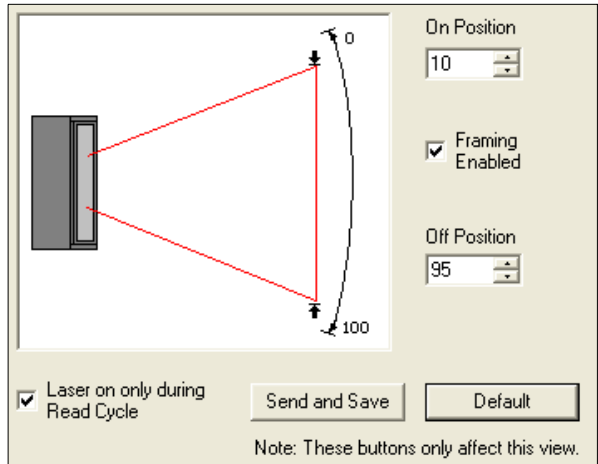

Laser Framing

Automatic Adjustment

To adjust laser framing automatically, click the **Calibration** button and click the **Auto Frame** button. If a symbol is in the raster/laser pattern, the reader will shorten the laser **On Position** and **Off Position** determining the full width of the symbol.

Chapter

9

Symbologies

Chapter Contents

Symbologies by ESP	9-2
Symbologies by Serial Command	9-3
1D Symbologies	9-4
Stacked Symbologies	9-26
Narrow Margins	9-29
Symbology ID	9-30
Background Color	9-31
Autodiscriminate	9-31

Code 39 is enabled by default. To enable most symbologies, send a **<P>** serial command to the reader from the Terminal window.¹ This enables: Code 39, Code 128, Codabar, I-2/5, UPC, and Code 93. PDF417 and Pharmacode are disabled. Micro PDF417, RSS, and Composite are unchanged.

Note: When assigning characters in user-defined fields, the characters **NULL**, **<**, **>**, and **,** can only be entered through embedded menus, not through **ESP** or serial commands.

1. If using an I 2/5 symbol, verify that the number of characters in the symbol being scanned matches the code length enabled for the I 2/5 symbol type (default is 10 and 6).

Symbologies by ESP



Click this Button to bring up the **Symbologies** menu

To open nested options, **single-click** the +.

To change a setting, **double-click** the setting and use your cursor to scroll through the options.

Parameters	ESP Values
[-] Symbologies	
[-] 1D Symbologies	
+ Code 39	Enabled
+ Code 128	Enabled
+ Interleaved 2 of 5	Enabled
+ Codabar	Enabled
+ UPC/EAN	Enabled
+ Code 93	Enabled
+ RSS Expanded	Enabled
RSS Limited	Enabled
RSS 14	Enabled
+ Pharmacode	Enabled
+ Stacked Symbologies	
Narrow Margin Status	Enabled
Symbology Identifier	Enabled
Background Color	Disabled*
	Enabled

Symbologies by Serial Command

Symbologies	
Code 39	<K470, status, check digit status, check digit output status, large intercharacter gap, fixed symbol length status, fixed symbol length, full ASCII set>
Code 128/EAN-128	<K474, status, fixed symbol length status, fixed symbol length, EAN-128 status, output format, application record separator status, application record separator character, application record brackets, application record padding>
Interleaved 2 of 5	<K472, status, check digit status, check digit output status, symbol length #1, symbol length #2, guard bar status, range mode>
Codabar	<K471, status, start & stop match status, start & stop output status, large intercharacter gap, fixed symbol length status, symbol length, check digit type, check digit output status>
UPC/EAN	<K473, UPC status, EAN status, supplementals status, separator status, separator character, supplementals type, UPC-E output as UPC-A>
Code 93	<K475, status, fixed symbol length status, fixed symbol length>
RSS Expanded	<K484, status, fixed symbol length status, fixed symbol length>
RSS Limited	<K483, status>
RSS-14	<K482, status>
Pharmacode	<K477, status, fixed bar length status, fixed bar length, min. no. of bars, bar widths, direction, fixed threshold value>
PDF417	<K476, status, [unused], fixed symbol length status, fixed symbol length, decode at end of read>
Micro PDF417	<K485, status, [unused], fixed symbol length status, fixed symbol length>
Composite	<K453, mode, separator status, separator>
Narrow Margins/Symbology ID	<K450, narrow margins status, symbology identifier>
Background Color	<K451, background color>

1D Symbologies

Code 39

Usage: **Code 39** is considered the standard for non-retail bar code applications.

Definition: An alphanumeric symbol with unique start/stop symbol patterns, composed of 9 black and white elements per character, of which 3 are wide.

Code 39 Status

Serial Cmd: <**K470,status**,*check digit status,check digit output,large intercharacter gap,fixed symbol length status,symbol length,full ASCII set*>

Default: **Enabled**

Note: This is the only symbol type enabled by default.

Options: 0 = Disabled 1 = Enabled

Check Digit Status

Serial Cmd: <**K470,status,check digit status**,*check digit output,large intercharacter gap,fixed symbol length status,symbol length,full ASCII set*>

Default: **Disabled**

Options: 0 = Disabled 1 = Enabled

Check Digit Output

Usage: **Check Digit Output Status**, added to the symbol, provides additional security.

Definition: When enabled, the check digit character is read and sent along with the symbol data. When disabled, symbol data is sent without the check digit.

Note: With **Check Digit Output Status** and an **External** or **Serial** trigger option enabled, an invalid check digit calculation will cause a noread message to be transmitted at the end of the read cycle.

Serial Cmd: <**K470,status,check digit status,check digit output**,*large intercharacter gap,fixed symbol length status,symbol length,full ASCII set*>

Default: **Disabled**

Options: 0 = Disabled 1 = Enabled

Large Intercharacter Gap

Usage: **Large Intercharacter Gap** is helpful for reading symbols that are printed out of specification.

Caution: Do not use **Large Intercharacter Gap** with **Narrow Margins** enabled since a large intercharacter gap (over 3x) could cause a narrow margins (5x) to be interpreted as an intercharacter gap.

Definition: When enabled, the reader can read symbols with gaps between symbol characters that exceed three times (3x) the narrow element width.

Serial Cmd: <**K470**,status,check digit status,check digit output,**large intercharacter gap**,fixed symbol length status,symbol length,full ASCII set>

Default: **Disabled**

Options: 0 = Disabled 1 = Enabled

Fixed Symbol Length Status

Usage: Helps prevent truncations and increases data integrity by ensuring that only a fixed symbol length will be accepted.

Definition: When enabled, the reader will check the symbol length against the symbol length field. If disabled, any length is considered a valid symbol.

Serial Cmd: <**K470**,status,check digit status,check digit output status,large intercharacter gap,**fixed symbol length status**,symbol length,full ASCII set>

Default: **Disabled**

Options: 0 = Disabled 1 = Enabled

Symbol Length

Definition: Specifies the exact number of characters that the reader will recognize (this does not include start and stop and check digit characters). The reader ignores any symbol not having the specified length.

Serial Cmd: <**K470**,status,check digit status,check digit output,large intercharacter gap,fixed symbol length status,**symbol length**,full ASCII set>

Default: **10**

Default: 1 to 128

Full ASCII Set

Usage: Must be enabled when reading characters outside the standard character set (0-9, A-Z, etc.)

User must know in advance whether or not to use **Full ASCII Set** option. Since **Full ASCII Set** requires two symbol words to encode one character, it is less efficient.

Definition: Standard Code 39 encodes 43 characters; zero through nine, capital "A" through capital "Z", minus symbol, plus symbol, forward slash, space, decimal point, dollar sign and percent symbol. When **Full ASCII Set** is enabled, the reader can read the full ASCII character set, from 0 to 255.

Serial Cmd: <**K470**,*status,check digit status,check digit output,large intercharacter gap,fixed symbol length status,symbol length*,**full ASCII set**>

Default: **Disabled**

Options: 0 = Disabled 1 = Enabled

Code 128/EAN

Usage: **Code 128/EAN** is useful in applications with tight spots and high security needs.

Definition: A very dense alphanumeric symbology. It encodes all 128 ASCII characters; it is continuous, has variable length, and uses multiple element widths measured edge to edge.

Code 128 Status

Serial Cmd: <**K474,status**,fixed symbol length status,fixed symbol length,EAN-128 status,output format,application record separator status,application record separator character,application record brackets,application record padding>

Default: **Disabled**

Options: 0 = Disabled 1 = Enabled

Note: **Code 128** must be **Enabled** for EAN-128 to function.

Fixed Symbol Length Status

Usage: Helps prevent truncations and increases data integrity by ensuring that only a fixed symbol length will be accepted.

Definition: When enabled, the reader will check the symbol length against the symbol length field. When disabled, any length is considered a valid symbol.

Serial Cmd: <**K474,status**,fixed symbol length status,fixed symbol length,EAN-128 status,output format,application record separator status,application record separator character,application record brackets,application record padding>

Default: **Disabled**

Options: 0 = Disabled 1 = Enabled

Symbol Length

Definition: Specifies a fixed number of characters that the reader will recognize (this does not include start and stop and check digit characters). The reader ignores any symbol not having the specified length.

Serial Cmd: <**K474,status**,fixed symbol length status,fixed symbol length,EAN-128 status,output format,application record separator status,application record separator character,application record brackets,application record padding>

Default: **10**

Options: 1 to 128

Note: **Fixed Symbol Length Status** must be enabled for **Symbol Length** to take effect.

EAN-128 Status

Note: Code 128 must be **Enabled** for EAN-128 to function.

Usage: Used as a standard for shipping symbols.

Definition: A subset of Code 128, with extended features. (For more information, see

GS1 US at:

<http://www.gs1us.org/gs1us.html>

Or see **AIM**, at:

<http://www.aimglobal.org/standards/aimpubs.asp>.

Serial Cmd: <**K474**,status,fixed symbol length status,fixed symbol length,**EAN-128 status**,output format,application record separator status,application record separator character,application record brackets,application record padding>

Default: **Disabled**

Options: 0 = Disabled 1 = Enabled 2 = Required

If set to **Enabled**, symbols can be read with or without a function 1 character in the first position.

If set to **Required**, the symbol must have a function 1 in the first position and conform to EAN format in order to decode the symbol.

Output Format

Usage: **Application Record** is useful in applications in which the software can utilize application record formatting to help automate the processing of its EAN-128 data.

Definition: Offers an option between **Standard EAN-128** and **Application Record** format.

Serial Cmd: <**K474**,status,fixed symbol length status,fixed symbol length,EAN-128 status,**output format**,application record separator status,application record separator character,application record brackets,application record padding>

Default: **Standard**

Options: 0 = Application 1 = Standard

In **Standard** UCC/EAN-128 application identifiers and data fields are sent, but none of the formatting (separators, parentheses, padding) will be included.

Application Record is a variation of UCC/EAN-128 that allows the user to define separators between data fields, enclose application identifiers in parentheses, and enable padding (zeros) for variable length fields.

Note: If an illegal **Application Record** format is detected, the reader will process it as a noread and output a noread message (if enabled).

Application Record Separator Status

Definition: When enabled, a separator character is inserted between application records.

Serial Cmd: <**K474**,status,fixed symbol length status,fixed symbol length,EAN-128 status,output format,**application record separator status**,application record separator character,application record brackets,application record padding>

Default: **Disabled**

Options: 0 = Disabled 1 = Enabled

Note: **Output Format** must be set to **Application Record** before this parameter can take effect.

Note: When set to **Disable**, app rec sep char is forced to NUL. When set to **Enabled**, **Application Record Separator Character** must also be sent in the same command.

Application Record Separator Character

Note: **Application Record Separator Character Status** is enabled by setting the parameter to any value other than a null.

Definition: Allows the user to define an ASCII character as an application record separator.

Serial Cmd: <**K474**,status,fixed symbol length status,fixed symbol length,EAN-128 status,output format,application record separator status,**application record separator character**,application record brackets,application record padding>

Default: , (comma)

Options: User Defined ASCII character

Note: Has no effect unless **Application Record Separator Status** is enabled.

Application Record Brackets

Definition: When enabled, parentheses () are added to enclose application identifiers.

Serial Cmd: <**K474**,status,fixed symbol length status,fixed symbol length,EAN-128 status,output format,application record separator status,application record separator character,**application record brackets**,application record padding>

Default: **Disabled**

Options: 0 = Disabled 1 = Enabled

Note: **Output Format** must be set to **Application Record** before this parameter can take effect.

Application Record Padding

Definition: Padding is the insertion of zeros to make up the maximum length of a variable application record data field, except for the last field which does not require padding.

When enabled, padding is included. When disabled, padding is omitted.

Note: Padding is never added to fixed length fields or to the last data field of a symbol. Enabling or disabling **Record Padding** will have no effect on these.

Serial Cmd: <**K474**,*status, fixed symbol length status, fixed symbol length, EAN-128 status, output format, application record separator status, application record separator character, application record brackets, **application record padding***>

Default: **Enabled**

Options: 0 = Disabled 1 = Enabled

Note: Output Format must be set to **Application Record** before this parameter can take effect.

Interleaved 2 of 5

Usage: It has been popular because it is the most dense symbol for printing numeric characters less than 10 characters in length; however, Microscan does not recommend this symbology for any new applications because of inherent problems such as truncation.

Definition: A dense, continuous, self-checking, numeric symbology. Characters are paired together so that each character has five elements, two wide and three narrow, representing numbers 0 through 9, with the bars representing the first character and the interleaved spaces representing the second character. (A check digit is highly recommended.)

Important: You must set **Symbol Length** in order to decode I-2/5 symbols.

Interleaved 2 of 5 Status

Serial Cmd: <**K472,status,check digit status,check digit output status,symbol length #1,symbol length #2,guard bar status,range mode**>

Default: **Disabled**

Options: 0 = Disabled 1 = Enabled

Check Digit Status

Usage: It is typically not used but can be enabled for additional security in applications where the host requires redundant check digit verification.

Definition: An error correcting routine in which the check digit character is added.

Serial Cmd: <**K472,status,check digit status,check digit output status,symbol length #1,symbol length #2,guard bar status,range mode**>

Default: **Disabled**

Options: 0 = Disabled 1 = Enabled

Check Digit Output Status

Definition: When enabled, a check digit character is sent along with the bar symbol data for added data security.

Serial Cmd: <**K472,status,check digit status,check digit output status,symbol length #1,symbol length #2,guard bar status,range mode**>

Default: **Disabled**

Options: 0 = Disabled 1 = Enabled

Symbol Length #1

Usage: With I–2/5, two symbol lengths can be defined. When using only one symbol length in an application, setting **Symbol Length #2** to 0 (zero) to ensure data integrity is recommended.

Definition: Allows user to define the symbol length. Because I–2/5 is a continuous symbology, it is prone to substitution errors. Hence, a symbol length must be defined and a symbol must contain an even number of digits.

Note: If start, stop or check digits are used, they are not included in the symbol length count.

Serial Cmd: <**K472**,status,check digit status,check digit output status,**symbol length #1**,symbol length #2,guard bar status,range mode>

Default: **10**

Options: 0 to 128

Symbol Length #2

Usage: If using a second symbol, a zero or any even symbol length from 2 to 64 may be specified. If not using a second symbol, set **Symbol Length #2** to 0 to ensure data integrity.

Definition: Allows user to define a second symbol length for I–2/5.

Serial Cmd: <**K472**,status,check digit status,check digit output status,symbol length #1,**symbol length #2**,guard bar status,range mode>

Default: **6**

Options: 0 to 128

Since I–2/5 characters are paired, symbol length must be set to an even number. If **Check Digit** is enabled, add 2 to your symbol length. For example, if your symbol is 10 characters plus a check digit, then enable **Symbol Length** for 12.

Note: Typically, when printing an I–2/5 symbol with an odd number of digits, a 0 will be added as the first character.

Options: 0 to 128

Important: When setting **Symbol Length** to any number other than 0, add **1** to account for a reserved space. For example, if your symbol has **3** characters, set **Symbol Length** to **4**.

Guard Bar

- Usage:* Useful when I–2/5 multisymbols are enabled to prevent false data output. This typically occurs with highly tilted or skewed symbols.
- Definition:* A guard bar is a heavy bar, at least 2 times the width of the wide bar, surrounding the printed I–2/5 symbol and helping to prevent false reads.
- Serial Cmd:* <**K472**,status,check digit status,check digit output status,symbol length #1,symbol length #2,**guard bar status**,range mode>
- Default:* **Disabled**
- Options:* 0 = Disabled 1 = Enabled

Range Mode Status

- Usage:* Useful in applications where symbol lengths may vary.
- Definition:* Allows user the option to define a minimum and maximum symbol length range for I–2/5.
- Serial Cmd:* <**K472**,status,check digit status,check digit output status,symbol length #1,symbol length #2,**guard bar status**,**range mode**>
- Default:* **Disabled**
- Options:* 0 = Disabled 1 = Enabled

When enabled, the symbol length range is defined by the values set in **Symbol Length #1** and **Symbol Length #2**.

For example, if the symbol lengths are defined as 10 and 6, a symbol of length 6, 8, or 10 will qualify as candidates for I–2/5.

Note: Either length (1 or 2) can qualify as the minimum or maximum.

Codabar

Usage: Used in photo-finishing and library applications. Formerly used in some medical applications but not typically used in newer applications.

Definition: Codabar is a 16-character set (0 through 9, and the characters \$, :, /, .., +, and -) with start/stop codes and at least two distinctly different bar widths.

Codabar Status

Serial Cmd: <**K471,status**,start & stop match status,start & stop output status,large intercharacter gap,fixed symbol length status,symbol length,check digit type,check digit output status>

Default: **Disabled**

Options: 0 = Disabled 1 = Enabled

Start & Stop Match Status

Usage: Used to increase security of symbology.

Definition: Requires the Codabar start and stop characters (a, b, c, or d) to match before a valid read can occur.

Serial Cmd: <**K471,status,start & stop match status**,start & stop output status,large intercharacter gap,fixed symbol length status,symbol length,check digit type,check digit output status>

Default: **Enabled**

Options: 0 = Disabled 1 = Enabled

Start & Stop Output Status

Usage: Used to verify matching.

Definition: Causes the start and stop characters to be transmitted with symbol data.

Serial Cmd: <**K471,status,start & stop match status,start & stop output status**,large intercharacter gap,fixed symbol length status,symbol length,check digit type,check digit status,check digit output status>

Default: **Enabled**

Options: 0 = Disabled 1 = Enabled

Large Intercharacter Gap

- Usage:* It is helpful for reading symbols that are printed out of specification.
- Caution:** Do not use **Large Intercharacter Gap** with **Narrow Margins** enabled since enabling **Large Intercharacter Gap** (over 3x) could cause a narrow margins (5x) to be interpreted as an intercharacter gap.
- Definition:* Instructs the reader to read symbols with gaps between characters exceeding three times the narrow element width.
- Serial Cmd:* **<K471,status,start & stop match status,start & stop output status,large intercharacter gap, fixed symbol length status, symbol length, check digit type, check digit output status>**
- Default:* **Disabled**
- Options:* 0 = Disabled 1 = Enabled

Fixed Symbol Length Status

- Usage:* Helps prevent truncations and increases data integrity by ensuring that only one symbol length will be accepted.
- Definition:* When set to Enabled, the reader will check the symbol length against the **Fixed Symbol Length** field.
- Serial Cmd:* **<K471,status,start & stop match status,start & stop output status,large intercharacter gap, fixed symbol length status, symbol length, check digit type, check digit output status>**
- Default:* **Disabled**
- Options:* 0 = Disabled 1 = Enabled

Symbol Length

- Definition:* Specifies the exact number of characters that the reader will recognize (this does not include start and stop and check digit characters). The reader ignores any symbol not having the specified length.
- Serial Cmd:* **<K471,status,start & stop match status,start & stop output status,large intercharacter gap, fixed symbol length status, symbol length, check digit type, check digit output status>**
- Default:* **10**
- Options:* 1 to 128

1D Symbologies

Important:

- When setting **Symbol Length** to any number other than zero, add **2** to account for reserved spaces. For example, if your symbol has **3** characters, set **Symbol Length** to **5**.
- If **Symbol Length** is set to zero (**0**) and **Symbol Length Status** is set to **Any/Minimum**, all symbol lengths are decoded.

Note: **Fixed Symbol Length Status** must be enabled for **Symbol Length** to take effect.

Note: Because of symbology limitations, setting **Symbol Length** to any number less than four will produce undetermined results.

Check Digit Type

Usage: Modulus 16 is used in the photo-finishing market. NW7 is used in Japanese markets.

Definition: Allows the user to select the check digit type **Codabar** will use.

Serial Cmd: **<K471,status,start & stop match,start & stop output status,large inter-character gap,fixed symbol length status,fixed symbol length,check digit type,check digit output status>**

Default: **Disabled**

Options: 0 = Disabled 2 = NW 7
1 = Modulus 16 3 = Both

Check Digit Output Status

Usage: For additional security a check digit can be added to the symbol.

Definition: When enabled, the check digit character is sent along with the symbol data. When disabled, symbol data is sent without the check digit.

Serial Cmd: **<K471,status,start & stop match,start & stop output status,large inter-character gap,fixed symbol length status,symbol length,check digit type,check digit output status>**

Default: **Disabled**

Options: 0 = Disabled 1 = Enabled

UPC/EAN

- Usage:* Used primarily in POS application in the retail industry. It is commonly used in applications in combination with **Matchcode** when there is a need to verify that the right product is being placed in the right packaging.
- Definition:* UPC (Universal Product Code) is a fixed length numeric, continuous symbology. UPC can have two- or five-digit supplemental symbol data following the normal code. The U.P.C., Version A (U.P.C., A) symbol is used to encode a 12 digit number. The first digit is the number system character, the next five are the manufacturer number, the next five are the product number, and the last digit is the checksum character.
- When enabled, the reader will read UPC version A and UPC version E only.

UPC Status

- Usage:* Useful where both UPC Version A and Version E symbols are present.
- Definition:* When enabled, the reader attempts to read both versions.
- Note:** The extra character identifies the country of origin.
- Serial Cmd:* <**K473**,**UPC status**,*EAN status*,*supplementals status*,*separator status*,*separator character*,*supplementals type*,*UPC-E output as UPC-A*>
- Default:* **Disabled**
- Options:* 0 = Disabled 1 = Enabled

EAN Status

- Usage:* Used with **EAN**, the European version of the UPC symbology.
- Definition:* EAN is a subset of UPC. When enabled, the reader will read UPC version A, UPC version E, EAN 13, and EAN 8. It also appends a leading zero to UPC version A symbol information and transmits 13 digits. If transmitting 13 digits when reading UPC version A symbols is not desired, disable **EAN**.
- Note:** The extra character identifies the country of origin.
- Serial Cmd:* <**K473**,*UPC status*,**EAN status**,*supplementals status*,*separator status*,*separator character*,*supplementals type*,*UPC-E output as UPC-A*>
- Default:* **Disabled**
- Options:* 0 = Disabled 1 = Enabled

Supplementals Status

Usage: Reads **Supplementals** typically used in publications and documentation.

Definition: A supplemental is a 2 or 5 digit symbol appended to the main symbol. When set to **Enabled** or **Required**, the reader reads supplemental symbol data that has been appended to the standard UPC or EAN codes.

Serial Cmd: <**K473**,UPC status,EAN status,**supplementals status**,separator status,separator character,supplementals type,UPC-E output as UPC-A>

Default: **Disabled**

Options: 0 = Disabled 1 = Enabled 2 = Required

Disabled

UPC **Supplementals** will not be decoded.

Enabled

When enabled, the reader will try to decode a main and a supplemental. However, if a supplemental is not decoded, at the end of the read cycle, the main will be sent by itself. The UPC main and supplemental symbols are considered to be one symbol and will be treated as such.

Required

When set to **Required** and either the main or supplemental symbol is not read, a single noread condition results. The UPC main and supplemental symbols are treated as one symbol.

For example, if **Supplementals** is set to **Required**, **Separator** is enabled, and an asterisk is defined as the UPC separator character, then the data will be displayed as: MAIN * SUPPLEMENTAL. **Note:** Under no circumstances will supplemental symbol data be sent without a main symbol.

Note: If additional symbols—other than the main or supplemental—will be read in the same read cycle, **Number of symbols** should be set accordingly.

Separator Status

Note: **UPC** must be enabled for **EAN** to take effect.

Definition: Allows the user to insert a character between the standard UPC or EAN symbol and the supplemental symbol when **Supplementals** is set to **Enabled** or **Required**.

Serial Cmd: <**K473**,UPC status,EAN status,supplementals status,**separator status**,separator character,supplementals type,UPC-E output as UPC-A>

Default: **Disabled**

Options: 0 = Disabled 1 = Enabled

Separator Character

Note: If **Separator Character** has been changed to any other character and you wish to re-define the separator as a comma, you will need to use **ESP** or the embedded menu.

Usage: As required by the application.

Definition: Allows the user to change the separator character from a comma to a new character.

Serial Cmd: <**K473**,UPC status,EAN status,supplementals status,separator status,**separator character**,supplementals type,UPC-E output as UPC-A>

Default: , (comma)

Options: Any ASCII character

Note: Whenever **Separator Character** is defined as a comma (,) sending a <**K473?**> command will return the current settings including the separator character comma which appears after the separator status comma.

Supplementals Type

Usage: As required by symbology used in application.

Definition: Allows the user to select 2 character or 5 character supplement, or both.

Serial Cmd: <**K473**,UPC status,EAN status,supplementals status,separator status,separator character,**supplementals type**,UPC-E output as UPC-A>

Default: **Both**

Options: 0 = Both 1 = 2 char only 2 = 5 char only

UPC-E Output to UPC-A

Usage: Useful for applications that require UPC-A output.

Definition: Allows the user to output UPC-E as UPC-A, or EAN-13, depending on the setting in the EAN status field.

Serial Cmd: <**K473**,UPC status,EAN status,supplementals status,separator status,separator character,supplementals type,**UPC-E output as UPC-A**>

Default: **Disabled**

Options: 0 = Disabled 1 = Enabled

Code 93

Usage: Used occasionally in clinical industry.

Definition: Code 93 is a variable length, continuous symbology employing four element widths. Each Code 93 character has nine modules that may be either black or white. Each character contains three bars and three spaces.

Code 93 Status

Serial Cmd: <**K475,status,fixed symbol length status,fixed symbol length**>

Default: **Disabled**

Options: 0 = Disabled 1 = Enabled

Fixed Symbol Length Status

Usage: Helps prevent truncations and increases data integrity by ensuring that only one symbol length will be accepted.

Definition: When enabled, the reader will check the symbol length against the symbol length field. When disabled, any length is considered a valid symbol.

Serial Cmd: <**K475,status,fixed symbol length status,symbol length**>

Default: **Disabled**

Options: 0 = Disabled 1 = Enabled

Symbol Length

Definition: Specifies the exact number of characters that the reader will recognize (this does not include start and stop and check digit characters). The reader ignores any symbol not having the specified length.

Serial Cmd: <**K475,status,fixed symbol length status,fixed symbol length**>

Default: **10**

Options: 1 to 128

RSS Expanded

- Usage:* Used to encode primary and supplementary data in retail point-of-sale and other applications.
- Definition:* RSS Expanded is a variable length symbology that can encode supplementary information in addition to the 14-digit EAN.UCC item identification number and is capable of encoding up to 74 numeric or 41 alphabetic characters.
- Serial Cmd:* <**K484**, **status**, *fixed symbol length status*, *fixed symbol length*>
- Default:* **Disabled**
- Options:* 0 = Disabled
1 = Enabled

Fixed Symbol Length Status

- Definition:* When enabled, the reader will check the symbol length against the symbol length field, minus the embedded check digit. If disabled, any length would be considered a valid symbol.
- Serial Cmd:* <**K484**, *status*, **fixed symbol length status**, *fixed symbol length*>
- Default:* **Disabled**
- Options:* 0 = Disabled 1 = Enabled

Fixed Symbol Length

- Usage:* **Fixed Symbol Length** helps prevent truncations and increases data integrity by ensuring that only one symbol length will be accepted.
- Definition:* Specifies the exact number of characters that the reader will recognize (this does not include start and stop and check digit characters). The reader ignores any symbol not having the specified length.
- Serial Cmd:* <**K484**, *status*, *fixed symbol length status*, **fixed symbol length**>
- Default:* **14**
- Options:* 1 to 74

RSS Limited

- Usage:* RSS Limited is designed to be read by laser and CCD readers. It is not recommended for omnidirectional slot readers.
- Definition:* Encodes a smaller 14-digit symbol (74 modules wide) that is not omnidirectional.
- Serial Cmd:* <**K483, status**>
- Default:* **Disabled**
- Options:* 0 = Disabled 1 = Enabled

RSS-14

Usage: Used in the grocery retail and prescription drug industries where full 14-digit EAN.UCC item identification may be needed.

Definition: RSS-14 (Reduced Space Symbology) is a fixed length symbology that encodes 14-digits, including a 1 digit indicator digit and is 96 modules wide. It can be stacked into two rows, read omnidirectional if printed in full height, or not if height-truncated for small marking.

Serial Cmd: <**K482, status**>

Default: **Disabled**

Options: 0 = Disabled 1 = Enabled

Pharmacode

Usage: Pharmacode is used mostly with packaging for the pharmaceuticals industry.

Definition: The symbol encodes up to five different numbers, each with its own color which may be entered in decimal or "binary" format with a 1 represented by a thick bar and a 0 represented by a thin bar. Bar width is independent of height.

In decimal format, each part can be up to 999999.

In binary format, each input have up to 19 ones and zeros.

Note: It is recommended that you disable AGC before enabling Pharmacode.

Pharmacode Status

Serial Cmd: <**K477**,*status*,*fixed bar length status*,*fixed bar length*,*min. no. of bars*,*bar widths*,*direction*,*fixed threshold value*>

Default: **Disabled**

Options: 0 = Disabled 1 = Enabled

Fixed Symbol Length Status

Definition: Helps prevent truncations and increases data integrity by ensuring that only one symbol length will be accepted.

Serial Cmd: <**K477**,*status*,**fixed bar length status**,*fixed bar length*,*min. no. of bars*,*bar widths*,*direction*,*fixed threshold value*>

Default: **Disabled**

Options: 0 = Disabled 1 = Enabled

Symbol Length

Usage: Helps prevent truncations and increases data integrity by ensuring that only one symbol length will be accepted.

Definition: Specifies the exact number of characters that the reader will recognize (this does not include start and stop and check digit characters). The reader ignores any symbol not having the specified length.

Serial Cmd: <**K477**,*status*,*fixed bar length status*,**fixed bar length**,*min. no. of bars*,*bar widths*,*direction*,*fixed threshold value*>

Default: **10**

Options: 4 to 16

Stacked Symbologies

PDF417

PDF Status

Serial Cmd: <**K476,status**, [unused], fixed symbol length status, fixed symbol length, decode at end of read>

Default: **Disabled**

Options: 0 = Disabled 1 = Enabled

Fixed Symbol Length Status

Serial Cmd: <**K476,status**, [unused], **fixed symbol length status**, fixed symbol length, decode at end of read>

Default: **Disabled**

Options: 0 = Disabled 1 = Enabled

Fixed Symbol Length

Usage: Used to increase data integrity by ensuring that only one symbol length will be accepted.

Serial Cmd: <**K476,status**, [unused], fixed symbol length status, **fixed symbol length**, decode at end of read>

Default: **10**

Options: 1 to 2710

Note: Fixed Symbol Length Status must be enabled for Fixed Symbol Length to take effect.

Decode at End of Read

Serial Cmd: <**K476,status**, [unused], fixed symbol length status, fixed symbol length, **decode at end of read**>

Default: **Disabled**

Options: 0 = Disabled 1 = Enabled

Micro PDF417

- Usage:* Used for labeling small items that need large capacity.
- Definition:* A variant of PDF417, a very efficient and compact stacked symbology that can encode up to 250 alphanumeric characters or 366 numeric characters per symbol.
- Serial Cmd:* <**K485,status**,[unused],fixed symbol length status,fixed symbol length>
- Default:* **Disabled**
- Options:* 0 = Disabled 1 = Enabled

Fixed Symbol Length Status

- Serial Cmd:* <**K485,status**,[unused],**fixed symbol length status**,fixed symbol length>
- Default:* **Disabled**
- Options:* 0 = Disabled 1 = Enabled

Fixed Symbol Length

- Usage:* Used to increase data integrity by ensuring that only one symbol length will be accepted.
- Definition:* When enabled, the Micro PDF symbol must contain the same number of characters as the symbol length setting before it can be considered a good read. The reader will ignore any symbol not having the specified length.
- Serial Cmd:* <**K485,status**,[unused],fixed symbol length status,**fixed symbol length**>
- Default:* **10**
- Options:* 1 to 366

Note: **Fixed Symbol Length Status** must be enabled for **Fixed Symbol Length** to take effect.

Composite

When set to **Enabled** or **Required**, will attempt to decode the composite component of a linear symbol. The linear symbol can be RSS14, RSS Expanded, RSS Limited, UCC/EAN-128, UPC-A, EAN-13, EAN-8, and UPC-E.

Usage: Allows reading by both linear and 2D readers.

Definition: Combines 2D and linear width modulated symbology on the same symbol where different messages can be read by each reader type.

Serial Cmd: **<K453,mode,separator status,separator>**

Default: **Disabled**

Options: 0 = Disabled 1 = Enabled 2 = Required

Note: When **Composite** is set to **Enabled** or **Required**, all UPC symbols are considered part of a Composite symbol.

Enabled

If set to **Enabled** and it only decodes the linear component, it will output only the linear component.

Required

If set to **Required**, it must decode both the linear and the composite components; otherwise it outputs a noread.

Separator Status

Usage: Allows user to distinguish between the main and **Supplemental** symbols.

Definition: This separator separates the linear symbol and the composite component.

Serial Cmd: **<K453,mode,separator status,separator>**

Default: **Disabled**

Options: 0 = Disabled 1 = Enabled

Separator Character

Note: If **Separator Character** has been changed to any other character and you wish to re-define the separator as a comma, you will need to use **ESP** or the embedded menu.

Usage: As required by the application.

Definition: Allows the user to change the separator character from a comma to a new character.

Serial Cmd: **<K453,mode,separator status,separator>**

Default: **, (comma)**

Options: Any ASCII character

Narrow Margins

Usage: Used when the leading and trailing edges of the symbols are smaller than the standard margin or when other objects encroach into the margins.

Definition: Allows the reader to read symbols with quiet zones less than 8 times the width of the narrow bar element. "Quiet zone" is the space at the leading and trailing ends of a symbol. Each quiet zone can be as narrow as only five times the width of the narrow bar element when **Narrow Margins** is enabled.

Serial Cmd: <**K450,narrow margins status**,symbology identifier>

Default: **Disabled**

Options: 0 = Disabled 1 = Enabled

Note: Do not use **Narrow Margins** with **Large Intercharacter Gap** enabled in Code 39 or Codabar.

Symbology ID

Usage: Used when the symbology type and how it's decoded needs to be known.

Definition: Symbology ID is an AIM standard prefix set of characters that identify the symbol type.

When enabled, the reader analyzes and identifies the symbology and adds a three character identifying prefix to the data:

1. **]** (close bracket character) indicating the presence of a symbology ID
2. **A, C, E, I, L, O, b, d, p, P, M**
 A = Code 39, C = Code 128 or EAN-128, E = UPC/EAN,
 I = I-2/5, F = Codabar; G = Code 93, L = PDF417, a = Pharmacode,
 e = Composite/RSS, L = PDF417 and Micro PDF417
3. **Modifier** (see **Explanation of Modifiers** below)

Serial Cmd: <**K450**, narrow margins, **symbology identifier status**>

Default: **Disabled**

Options: 0 = Disabled 1 = Enabled

Explanation of Modifiers for Code 39, Codabar, and I-2/5

- For Code 39, Codabar and I-2/5, the modifier indicates **Check Digit** and **Check Digit Output Status**.
- For Code 39 only, **Full ASCII** needs to be enabled to see modifiers **4**, **5**, and **7**.

Modifier	Check Digit	Check Digit Output	Full ASCII conversion performed (Code 39 only)
0	Disabled	N/A	No
1	Enabled	Enabled	No
3	Enabled	Disabled	No
4	Disabled	N/A	Yes
5	Enabled	Enabled	Yes
7	Enabled	Disabled	Yes

Example: **]A5** indicates a Code 39 symbol with **Check Digit** and **Check Digit Output Status** enabled and Full ASCII conversion performed.

For Other Codes

- For Code 128, a **1** indicates EAN-128; otherwise the modifier is a **0**.
- For all other codes, the modifier is **0**.

Background Color

- Usage:* If the background is darker than the symbol, then enable black background.
Typically the background is white; but on PCBs for example, they can be black.
- Definition:* Allows the user to choose which symbol background (spaces and surrounding medium) the reader can read.
- Serial Cmd:* **<K451,background color>**
- Default:* **White**
- Options:* 0 = White 1 = Black

Autodiscriminate

Although **Autodiscriminate** is not a configuration command, but it is included here as a convenient tool for enabling most symbol types.

- Usage:* Commonly used for quick setup mode to detect symbol type. This is particularly useful for users who might be unfamiliar with their application's symbology.
- Note:** It does not alter individual fields such as **Start/Stop, Fixed Length**, etc. These need to be setup individually.
- Definition:* Enables all available symbology types except PDF417, UCC/EAN 128, PDF417, Micro PDF417, and RSS. The user may also individually disable/enable each symbology type.
- Serial Cmd:* **<P>**
- Default:* **Code 39** (only)
- Options:* **<P>** Enables all codes except noted above.
<Q> Enables Code 39 only
<R> Enables Codabar only
<S> Enables I 2/5 only

Note: If using an I 2/5 symbol, verify that the number of characters in the symbol being scanned matches the symbol length enabled for the I 2/5 symbol type (default is 10 and 6).

Chapter

10

I/O Parameters

Chapter Contents

I/O Parameters by ESP	10-2
I/O Parameters by Serial Command.....	10-3
Symbol Data Output	10-4
Noread Message	10-7
Bad Symbol Message	10-8
No Symbol Message	10-9
Output Indicators	10-10
Serial Verification	10-12
EZ Button	10-14
Input	10-15
Output 1.....	10-16
Output 2.....	10-23
Output 3.....	10-24
Quality Output	10-25
Database Number Output	10-26
Symbol Position Output.....	10-27
Read Duration Output	10-30

This section includes instructions for setting up conditions for beeper and EZ Button controls and for changing input/output of data messages and electrical transitions for control of internal and external devices.

Note: The characters **NULL**, **<**, **>**, and **,** can only be entered through embedded menus, not through **ESP** or serial commands.

Note: You can learn the current setting of any parameter by inserting a question mark after the number, as in **<K100?>**. To see all "K" commands, send **<K?>**.

Note on Serial Commands: To preserve continuity with other Microscan products, some serial configuration commands may include 0s (zeros) or 1s as placeholders. In order for a these commands to be implemented, the placeholders must be included.

I/O Parameters by ESP

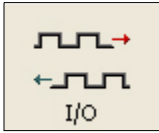

Click this button to bring up the **I/O Parameters** menu

To open nested options, **single-click** the +.

To change a setting, **double-click** the setting and use your cursor to scroll through the options.

Parameters	ESP Values
<input type="checkbox"/> I/O Parameters	
<input type="checkbox"/> Symbol Data Output	Good Read
<input type="checkbox"/> Noread Message	Enabled
<input type="checkbox"/> Bad Symbol Message	Disabled
<input type="checkbox"/> No Symbol Message	Disabled
<input type="checkbox"/> Output Indicators	
<input type="checkbox"/> Serial Verification	
<input type="checkbox"/> EZ Button	Enabled
<input type="checkbox"/> Input 1	Disabled
<input type="checkbox"/> Output 1 Parameters	
<input type="checkbox"/> Output 2 Parameters	
<input type="checkbox"/> Output 3 Parameters	
<input type="checkbox"/> Quality Output	
Quality Output Separator	,
Decodes/Trigger Status	Disabled
Decode Direction Output	Disabled*
<input type="checkbox"/> Database Number Output	Disabled*
<input type="checkbox"/> Symbol Position Output	Enabled
<input type="checkbox"/> Read Duration Output	Disabled

I/O Parameters by Serial Command

I-O Parameters	
Symbol Data Output	< K705 ,symbol data output mode,when to output>
Noread Message	< K714 ,status,noread message>
Bad Symbol Message	< K715 ,bad symbol status,bad symbol message>
No Symbol Message	< K716 ,no symbol status,no symbol message>
Output Indicators	< K750 ,green flash mode,[unused],green flash duration>
Beeper	< K702 ,beeper output>
Serial Verification	< K701 ,serial command echo status,serial command beep status,control/hex output>
Input 1	< K730 ,input mode,active state>
Output 1	< K810 ,output on,active state,pulse width,output mode>
Trend Analysis (1)	< K780 ,trend analysis mode,trigger evaluation period,number to output on,decodes/trigger threshold>
Diagnostics (1)	< K790 ,over temperature,service threshold,[unused],laser current high,laser current low,low temp>
Output 2	< K811 ,output on,output state,pulse width,output mode>
Trend Analysis (2)	< K781 ,trend analysis mode,number of triggers,number to output on,decodes/trigger threshold>
Diagnostics (2)	< K791 ,over temperature,service threshold,unused,laser current high,laser current low,low temp>
Output 3	< K812 ,output on,output state,pulse width,output mode>
Trend Analysis (3)	< K782 ,trend analysis mode,number of triggers,number to output on,decodes/trigger threshold>
Diagnostics (3)	< K792 ,over temperature,service threshold,unused,laser current high,laser current low,low temp>
Quality Output	< K704 ,quality output separator,decodes/trigger status,decode direction status>
Database Number Output	< K759 ,status,separator>
Symbol Position Output	< K758 ,raster status,scan status,separator>
Read Duration Output	< K706 ,status,separator>

Symbol Data Output

Usage: Useful when the host needs symbol data only under certain conditions.
Definition: Defines the conditions under which decoded symbols are transmitted to the host.

Symbol Data Output Status

Serial Cmd: <**K705, symbol output status**, when to output>

Default: **Good Read**

Options: 0 = Disabled 2 = Mismatch
 1 = Match 3 = Good Read

Note: If set to **Match** or **Mismatch**, **Symbol Output Status** will not take effect unless **Matchcode Type** is enabled and a master symbol is loaded into memory.

Disabled

Usage: Useful when an application only needs to use the discrete outputs and can allow the reader to do the decision-making. When **Disabled**, the host does not need the symbol data and the communication lines are used only for setup and status checks.

Definition: When set to **Disabled**, the reader will not transmit any data that is generated during a read cycle (symbols, noreads, etc.).

Match

Usage: **Match** is used in an application that requires specific symbol information and needs to sort, route or verify based on matching the specific symbol data.

Definition: When set to **Match**, the reader transmits symbol data whenever a symbol matches a master symbol. However, if **Matchcode Type** is **Disabled**, it transmits on any good read.

Note: A noread can still be transmitted if **Enabled**.

Mismatch

Usage: **Mismatch** is typically used as a flag within the host system to prevent an item from being routed in the wrong container.

Definition: With **Mismatch** enabled, the reader transmits symbol data whenever the symbol data information does NOT match the master symbol.

Note: A noread can still be transmitted if enabled.

Good Read

Usage: **Good Read** is used when an application requires all symbol data to be transmitted. It's typically used in tracking applications in which each object is uniquely identified.

Definition: With **Good Read** enabled, the reader transmits symbol data on any good read regardless of **Matchcode Type** setting.

Note: A noread can still be transmitted if enabled.

When to Output Symbol Data

Definition: This command allows the user to choose when symbol data can be sent to the host.

Serial Cmd: <**K705**,symbol output status,*when to output*>

Default: **As Soon As Possible**

Options: 0 = As Soon As Possible 1 = End of Read Cycle

As Soon As Possible

Usage: **As Soon As Possible** is useful in applications in which symbol data needs to be moved quickly to the host, typically when the host is making decisions based on symbol data.

Definition: Enabling **As Soon As Possible** causes symbol data to be sent to the host immediately after a symbol has been successfully decoded.

Note: More than one decode might in fact be required to qualify as a good decode, depending on how **Decodes Before Output** is set.

End of Read Cycle

Note: See "**End of Read Cycle**" on page 7-14 for options to end the read cycle.

Usage: **End of Read Cycle** is useful in timing-based systems in which the host is not ready to accept data at the time it is decoded.

Definition: Enabling **End of Read Cycle** means that symbol data does not get sent to the host until the read cycle ends with a timeout or new trigger.

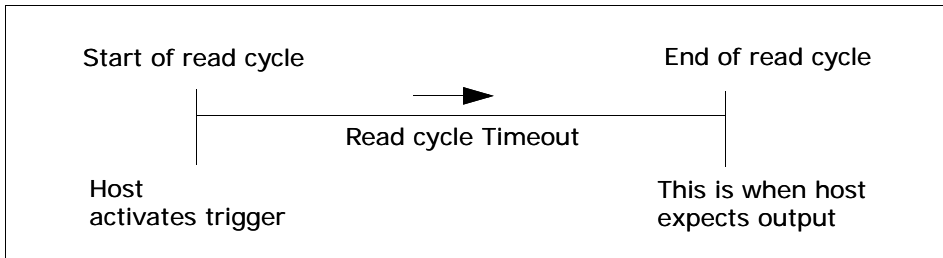

Read Cycle

Noread Message

- Usage:* Used in applications where the host needs serial verification that a symbol has not been read and especially useful in new print verification.
- Definition:* When enabled, and if no symbol has been decoded before timeout or the end of the read cycle, the noread message will be transmitted to the host.

Noread Status

- Serial Cmd:* <**K714,status,noread message**>
- Default:* **Enabled**
- Options:* 0 = Disabled 1 = Enabled

Noread Message

- Definition:* Any combination of ASCII characters can be defined as the noread message.
- Serial Cmd:* <**K714,status,noread message**>
- Default:* **NOREAD**
- Options:* 1 to 128 ASCII characters.

Note: Noread Message will only be transmitted if **Symbol Output** ("**Symbol Data Output Status**" on page 10-4) is set to **Match**, **Mismatch** or **Good Read**.

Noread Message can be set to any ASCII characters except **NULL**, **<**, **>**, and **,** **.**

Bad Symbol Message

Note: **Bad Symbol Message** does not apply to multisymbol operations.

Usage: Useful in verifying the presence of a symbol that has not been decoded.

Definition: When enabled, a message is sent to the host when a symbol is detected but not decoded. See "**Transition Counter**" on page 7-21.

The **Bad Symbol** output is tied to the transition counter. If during a read cycle no symbol is decoded and the required setting for the **Transition Sample Threshold** is met, a user defined message will be sent to the host.

Note: AGC (page 7-19) must be disabled when this feature is used.

Bad Symbol Status

Serial Cmd: <**K715**,*bad symbol status*,*bad symbol message*>

Default: **Disabled**

Options: 0 = Disabled 1 = Enabled

Bad Symbol Message

Serial Cmd: <**K715**,*bad symbol status*,*bad symbol message*>

Default: **BAD_SYMBOL**

Options: Up to 128 ASCII characters (except NUL)

The **Bad Symbol** output is tied to the transition counter. If during a read cycle no symbol is decoded and the required setting for the **Transition Sample Threshold** is met, a user defined message will be sent to the host.

No Symbol Message

Note: **No Symbol Message** does not apply to multisymbol operations.

Usage: Useful in determining if an object has an attached symbol.

Definition: When enabled, sends a message to the host whenever an object is detected but no symbol is detected.

The **No Symbol** output is tied to the transition counter. If during a read cycle no symbol is decoded and the required setting for the **Transition Sample Threshold** is NOT met, a user defined message will be sent to the host. See "**Transition Counter**" on page 7-21.

Note: AGC (page 7-19) must be disabled when this feature is used.

No Symbol Status

Serial Cmd: <**K716,no symbol status,no symbol message**>

Default: **Disabled**

Options: 0 = Disabled 1 = Enabled

No Symbol Message

Serial Cmd: <**K716,no symbol status,no symbol message**>

Default: **NO_SYMBOL**

Options: Up to 128 ASCII characters (except NUL)

Output Indicators

Green Flash Mode

Usage: Used as a visual verification that a good read has occurred.

Definition: A green LED in the front of the reader can be programmed to flash briefly in response to user-defined conditions, or if in **Static Presentation** mode, illuminate for a set period of time.

Serial Cmd: <**K750, green flash mode**, [unused], green flash duration>

Default: **Good Read**

Options:

0 = Disabled	3 = Match
1 = Good Read	4 = Mismatch
2 = Static Presentation	

Disabled

Green flash LEDs are disabled.

Good Read (Green Flash)

Green flash LEDs will flash for less than one second when a good read condition is met or when matchcode is enabled and a match occurs.

Static Presentation (Green Flash)

Static Presentation is used in conjunction with **Continuous Read** mode.

When operating in **Static Presentation** mode, whenever the EZ trigger is pressed, the reader will search for a symbol in **Continuous Read** mode. When a symbol is placed in the FOV and a good read occurs, the green LED will illuminate and stay on for the duration of time set in **Green Flash Duration**. Only one read will occur during that time unless more than one symbol is enabled in **Number of Symbols**.

Note: If **Static Presentation** mode is selected but the reader is not in **Continuous Read, Green Flash Mode** will revert to the default **Good Read**.

To use Static Presentation:

1. Enable **Continuous Read** (see "**Trigger**" on page 3-6).
2. Select the number of symbols (see "**Multisymbol**" on page 7-4).
3. Enable **Static Presentation** in **Green Flash Mode**.
4. Select the read time in **Green Flash Duration** (see "**Green Flash Duration**" on page 10-11).

Match (Green Flash)

Green flash LEDs will flash for less than 1 second when a match condition is met. If multisymbol is enabled, then green flash LEDs will illuminate only if all symbols qualify as a match. If matchcode is disabled, then this mode will activate the LED's on a good read.

Mismatch (Green Flash)

Same as **On Match** except it illuminates on a mismatch.

Green Flash Duration

Usage: A visual verification that a good read has occurred.

Definition: When a good read occurs, the Green flash LED's will illuminate and stay on for the time set for the **Green Flash Duration** value.

Serial Cmd: <**K750**,green flash mode,[unused],**green flash duration**>

Default: **100** (1 second)

Options: 0 to 65535 (in 10mS increments)

Beeper Output Condition

Usage: Provides an audible verification that either a good read, noread or EZ Button action has occurred.

Definition: A beep is emitted either after each good read of a symbol or after each noread, according to the **Beeper Output Condition** selection.

Note: Beeper will also sound if any of the following occur:

- the reader is defaulted a send/save command from **ESP** or an **Exit** command from any embedded menu.
- a <**Z**>, <**Zp**>, <**Zd**>, or <**K,1**> command is sent

Serial Cmd: <**K702**,**beeper output**>

Default: **On Good Read**

Options: 0 = Disabled 1 = On Good Read 2 = On Noread

Serial Verification

Usage: These commands are useful in removing any doubt about the reader's acceptance and response to host configuration commands.

For example, if the current preamble is "SOM" and **<Kd1, START>** is entered, the reader will echo back **<Kd1, SOM>** since the attempted entry "START" exceeds the four character limit for that command. Therefore it is rejected and the existing "SOM" message is echoed back and remains the preamble message.

Definition: Allows the user to verify configuration command status.

Serial Command Echo Status

Important Note: **ESP** will not function whenever this command is enabled.

Definition: When enabled, a configuration command received from the host is echoed back to the host with the resultant settings.

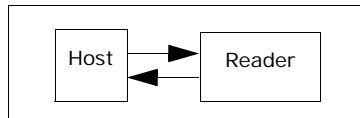

Function: If a command with multiple fields is processed, some of the fields may have been processed properly while others were not. The changes will appear in the string echoed back so that the user will know which fields did or did not change.

Serial Cmd: **<K701,serial command echo status,serial command beep status,control/hex output>**

Default: **Disabled**

Options: 0 = Disabled 1 = Enabled

Serial Command Beep Status

Important: **ESP** will not function whenever this command is enabled.

Usage: Used to audibly verify the acceptance and validity of a command.

Definition: Causes the reader to beep once whenever a K command is entered to indicate that the command was accepted and processed.

Function: If an invalid command is entered, the reader beeps 5 times to indicate an invalid entry. However, this does not necessarily mean that all data fields have been entered incorrectly. Only one bad field needs to be found in order to activate the 5 beep response.

Serial Cmd: <**K701**,serial command echo status,**serial command beep status**,control/hex output>

Default: **Disabled**

Options: 0 = Disabled 1 = Enabled

Control/Hex Output

Usage: Useful for viewing settings with binary characters when using serial command on a terminal.

Definition: Determines the response to a **Serial Command Echo** or status request command.

When set to **Control**, two characters are transmitted to represent a non-displayable character. For example, a carriage return will be shown as the two characters: **^M**.

When set to **Hex**, the output is the hex character.

Serial Cmd: <**K701**,serial command echo status,serial command beep status,**control/hex output**>

Default: **Control**

Options: 0 = Control 1 = Hex

EZ Button

See Chapter 3, "**EZ Button**" for EZ Button options.

See Chapter 4, "**Calibration**" for Raster Framing and Laser Framing.

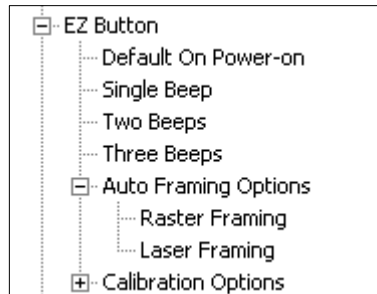

Input

- Usage:* For example, an application is setup so that a mismatch stops the production line by using outputs in a latch mode (see "**Output Mode (Output 1)**" on page 10-18). A push button switch can be connected to the input pin so that when pressed, it unlatches the output, allowing the line to resume operations.
- Definition:* A programmable, discrete input used to reset counters, outputs or control optoelectrical settings.
- Serial Cmd:* `<K730,input mode,active state>`
- Default:* **Disabled**
- Options:* 0 = Disabled 1 = Reset Counts 2 = Unlatch Output

Disabled

- Definition:* When set to **Disabled** there is no effect on operation.

Reset Counts

- Usage:* Primarily used in test mode. Can also be used to reset counters daily.
- Definition:* When set to **Reset Counts**, a transition to the active state of the input will cause the reader to reset the internal counters (See "**Read Rate**" on page 15-3).

Unlatch Output

- Definition:* This setting is used in combination with any of the three discrete outputs that are in **Unlatch Mode 1** (see "**Latch Mode 1 (Unlatch on Input #1)**" on page 10-18). A transition to the active state will clear any of the three outputs that were previously latched.

Active State

- Definition:* Determines the state at which inputs will react to input signals.
- Serial Cmd:* `<K730,input mode,active state>`
- Default:* **Active Closed**
- Options:* 0 = Active Open 1 = Active Closed

When set to **Active Closed**, the input function is activated when the input state is energized. When set to **Active Open**, the input function is activated when the input state is de-energized.

Output 1

Usage: This option provides switching to host software to control external devices such as PLCs and relays. It is useful for routing and sorting and to prevent mis-packaging and mis-routing.

Definition: Sets the discrete output functions for specific user-selected conditions.

Output On

Definition: Allows the user to set the conditions under which an output pulse will occur to output 1.

Serial Cmd: <**K810,output on**,active state,pulse width,output mode>

Default: **Mismatch or Noread**

Options:

0 = Mismatch or Noread	4 = Trend Analysis
1 = Match	5 = Disabled
2 = Mismatch	6 = Diagnostic Warning
3 = Noread	7 = In Read Cycle

Note: If **Output On** is set to **Mismatch or Noread**, **Match**, or **Mismatch**, a transition (switching) will not occur unless **Matchcode Type** is enabled and a master symbol is loaded into memory.

Mismatch or Noread

Activates discrete output when the symbol data does not match that of the master symbol or the symbol has not been decoded before the end of the read cycle.

Match

Activates a discrete output when the symbol data matches the master symbol.

Note: If you want to output for a good read and **Matchcode** is not enabled, you can enable any output for **Match**.

Mismatch

Activates a discrete output whenever the symbol data does not match that of the master symbol.

Noread

Activates a discrete output whenever the symbol data is not decoded before the end of the read cycle.

Trend Analysis

Tracks the occurrences and frequency of mismatches, noreads, and the number of decodes per trigger and output the results to output 1.

Disabled

No output.

Diagnostic Warning

Activates output 1 when a diagnostic warning condition is met. When enabled the **Output State** and **Pulse Width** settings (<**K810**> pulse, latch...) have no affect on output. The output will remain active as long as one of the diagnostic warning conditions persists. The output will go inactive whenever the warning condition no longer exists. The output remains active as long as one of the diagnostic conditions is met.

In Read Cycle

Output is active during the read cycle.

Output State (Output 1)

Definition: Sets the output state of the discrete output.

Serial Cmd: <**K810**,output on,output state,pulse width,output mode>

Default: **Normally Open**

Options: 0 = Normally Open 1 = Normally Closed

Pulse Width (Output 1)

Definition: Sets the time in 10mS increments that the discrete output remains active.

Serial Cmd: <**K810**,output on,output state,pulse width,output mode>

Default: **50 mS** (0.05 seconds)

Options: 1 to 65535 (0.01 to 65.535 seconds)

Output 1

Output Mode (Output 1)

Definition: Sets the condition in which the discrete output is de-activated.

Serial Cmd: <**K810**,output on,output state,pulse width,**output mode**>

Default: **Pulse**

Options: 0 = Pulse 2 = Latch Mode 2
 1 = Latch Mode 1 3 = Latch Mode 3

Pulse

Definition: This is the default mode of operation in which the programmable output is activated when the **Output On** condition has been met and held active for the duration of the selected pulse width.

Latch Mode 1 (Unlatch on Input #1)

Definition: The programmable output goes active when the **Output On** condition is met and will remain active until the state of input #1 changes from inactive to active.

Important: To unlatch using the EZ Button the button's status must be set to unlatch mode. (See "**Unlatch Outputs**" on page 3-6.)

Latch Mode 2 (Unlatch Opposite Condition)

Definition: The programmable output goes active when the **Output On** condition is met and will remain active until the opposite condition selected under **Output On** occurs.

For example, if **Noread** is enabled under **Output On**, the programmable output will go active upon a noread and remain active until the opposite condition, a good read, occurs.

Latch Mode 3 (Unlatch Enter Read Cycle)

Definition: The programmable output goes active when the **Output On** condition has been met and is held active until a new read cycle begins.

NOTE: All of the **Output On** modes are suppressed when any **Output on Warning** is active for **Output 1** (see <**K780**> command).

Trend Analysis (Output 1)

- Usage:** Useful in cases in which the user doesn't want to shut down for a single condition but wants to monitor quality and read conditions.
- Definition:** Applies trend analysis settings to Output 1.
With **Trend Analysis**, the user can track the occurrences and frequency of mismatches, noreads, and the number of decodes per trigger and output the results to any of three outputs.
- Example:** *Trend analysis mode = Noread*
Number to Output On = 4
Number of Triggers = 25
In this example, the reader will activate an output whenever 4 noreads occur within 25 triggers (read cycles).

With the exception of "Service threshold", diagnostic outputs remain active as long as the diagnostic condition is detected.

Trend Analysis Mode

- Definition:** Sets the trend condition (**Mismatch**, **Noread**, or **Decodes/Trigger**) that will activate the output.
- Serial Cmd:** *<K780,trend analysis mode,trigger evaluation period,number to output on,decodes/trigger threshold>*
- Default:** **Noread**
- Options:** 0 = Mismatch 1 = Noread 2 = Decodes per Trigger

Mismatch

- Definition:** Output will occur when the number of **Mismatches** equals the value entered for **Number to Output On** within the trigger window selected in **Trigger Evaluation Period**.

Noread

- Definition:** Output will occur when the number of noreads equals the value entered for **Number to Output On** within the trigger window selected in **Trigger Evaluation Period**.

Output 1

Trigger Evaluation Period

Definition: The number of triggers to examine for the trend analysis condition.

Serial Cmd: <**K780**,trend analysis mode,**trigger evaluation period**,number to output on,decodes/trigger threshold>

Default: **0**

Options: 0 to 255

Number to Output On

Definition: Sets the number of **Trend Analysis** events (mismatches, noreads or decodes/trigger as configured by **Trend Analysis Mode**) to occur within the **Number of Triggers** before activating the associated output.

Usage: For example, if **Number to Output On** is set to 3 and **Trend Analysis Mode** is set to **Noread**, then the output will not occur until 3 noreads have occurred.

Serial Cmd: <**K780**,trend analysis mode,trigger evaluation period,**number to output on**,decodes/trigger threshold>

Default: **0**

Options: 0 to 255

Decodes per Trigger

Definition: Sets the threshold for the number of decodes required per trigger (read cycle) that must occur before an output can occur.

Serial Cmd: <**K780**,trend analysis mode,trigger evaluation period,number to output on,**decodes/trigger threshold**>

Default: **0**

Options: 0 to 65535

Diagnostics (Output 1)

Note: With the exception of “Service threshold”, diagnostic outputs remain active as long as the diagnostic condition is detected.

Note: All warning outputs will remain active for at least one second.

Definition: Applies warning to **Output 1**. Sets up the destinations and specific warnings that will cause activation. (See Chapter 12, "**Diagnostics**", for more information.)

Usage: Alerts user to critical conditions.

Over Temperature

Serial Cmd: <**K790,over temperature,service threshold,[unused],laser current high,laser current low,low temp**>

Default: **Disabled**

Options: 0 = Disabled 1 = Enabled

Service Threshold

Definition: Activates the output whenever the service threshold has been met. Will output upon every occurrence of the threshold.

Serial Cmd: <**K790,over temperature,service threshold,[unused],laser current high,laser current low,low temp**>

Default: **Disabled**

Options: 0 = Disabled 1 = Enabled

Laser Current High

Definition: Activates the output whenever the high current threshold has been met. Will output once.

Serial Cmd: <**K790,over temperature,service threshold,[unused],laser current high,laser current low,low temp**>

Default: **Disabled**

Options: 0 = Disabled 1 = Enabled

Output 1

Laser Current Low

Definition: Activates the output whenever the high current threshold has been met. Will output once.

Serial Cmd: <**K790**,over temperature,service threshold,[unused],laser current high,**laser current low**,low temp>

Default: **Disabled**

Options: 0 = Disabled 1 = Enabled

Low Temperature

Serial Cmd: <**K790**,over temperature,service threshold,[unused],laser current high,laser current low,**low temp**>

Default: **Disabled**

Options: 0 = Disabled 1 = Enabled

Output 2

Serial Cmd: <**K811**,output on,output state,pulse width,output mode>

Output 2 has the same parameters and default settings as **Output 1**.

Trend Analysis (output 2)

Definition: Applies trend analysis settings to **Output 2**.

Serial Cmd: <**K781**,trend analysis mode,number of triggers,number to output on,decodes/trigger threshold>

Trend Analysis to Output 2 has the same parameters and default settings as **Trend Analysis to Output 1**.

Diagnostic Warnings (output 2)

Definition: Applies diagnostic warnings to **Output 2**.

Serial Cmd: <**K791**,over temperature,service threshold,unused,laser current high,laser current low,low temp>

Diagnostic Warnings to Output 2 has the same parameters and default settings as **Diagnostic Warnings to Output 1**.

Output 3

Serial Cmd: <K812,output on,output state,pulse width,output mode>

Output 3 has the same parameters and default settings as **Output 1**.

Trend Analysis (output 3)

Definition: Applies trend analysis settings to Output 3.

Serial Cmd: <K782,trend analysis mode,number of triggers,number to output on,decodes/trigger threshold>

Trend Analysis to Output 3 has the same parameters and default settings as **Trend Analysis to Output 1**.

Diagnostic Warnings (output 3)

Definition: Applies diagnostic warnings to Output 3.

Serial Cmd: <K792,over temperature,service threshold,unused,laser current high,laser current low,low temp>

Diagnostic Warnings to Output 3 has the same parameters and default settings as **Diagnostic Warnings to Output 1**.

Quality Output

Usage: Host system can monitor scanning performance (printing process, scanning environment changes, etc.) by setting thresholds in their processing or displaying the outputs for visual verification.

Definition: Allows the host to track the number of good reads per trigger by appending a five digit numeric field to the end of symbol data.

When enabled, symbol data is followed by a separator, followed by the five digits in the form of 00000. For example, a certain symbol that has been averaging 00100 decodes per read cycle suddenly drops to 00012, this would be a good indication that a problem has arisen even though good reads are still occurring.

Quality Output Separator

Serial Cmd: <**K704**,*quality output separator*,*decodes/trigger status*,*decode direction status*>

Default: , (comma)

Options: Any ASCII character

Note: For all serial configuration commands, the following characters cannot be used: , < , > , and **NULL**.

Decodes/Trigger Status

Serial Cmd: <**K704**,*quality output separator*,**decodes/trigger status**,*decode direction status*>

Default: **Disabled**

Options: 0 = Disabled 1 = Enabled

Decode Direction Output

Definition: If enabled the decode direction is appended to the barcode output with a quality output separator as an "F" (forward) or an "R" (reverse).

Serial Cmd: <**K704**,*quality output separator*,*decodes/trigger status*,**decode direction status**>

Default: **Disabled**

Options: 0 = Disabled 1 = Enabled

Database Number Output

When enabled the database number is appended to the data with a separator. The database number is formatted with a leading identifier of "**DB**" and the number is a zero padded 2 digit number.

Status

Serial Cmd: <**K759,status,separator**>

Default: **Disabled**

Options: 0 = Disabled 1 = Enabled

Separator

Serial Cmd: <**K759,status,separator**>

Default: **(Space)**

Options: Any ASCII character except **, <, >**, and **NULL**.

Example

Assume a symbol with the data "HELLO" is read using database number 3 and the separator is set to space. The data output would be "HELLO DB03" assuming no other outputs or formatting were enabled. It is important to note that if the symbol is read with more than one database setting, the database number output will be associated with the first time the symbol is read.

Symbol Position Output

The location and in some cases the size of a decoded symbol can be determined dynamically. When enabled, raster height and scan locations relative to the reader are calculated and appended to the symbol data output. In most linear symbologies, the actual width of the symbol is added to the scan line location.

Raster Status

Usage: Locates the decoded symbol in the raster position.

Definition: Locates the decoded symbol in the raster position (RP).

The raster position is a 3-digit number from 0 to 255 indicating the height of the raster line with 0 at the top when the reader is in the upright position as shown here.

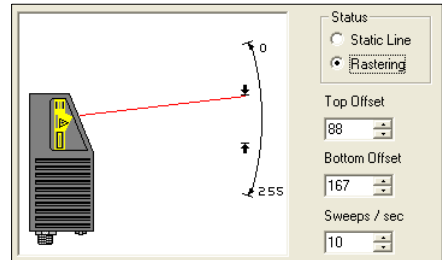

Serial Cmd: `<K758,raster status,scan status,separator>`

Default: **Disabled**

Options: 0 = Disabled 1 = Enabled

When enabled the location of the symbol within the raster pattern is appended to the symbol data output, with a separator. The raster position is formatted with a leading identifier of "RP" and the number is a zero padded 3 digit number in the form of **RPXXX**.

The raster location value corresponds to the configurable raster offsets in the **<K506>** command in **"Raster Setup"** on page 8-3.

Example

For example, assume a symbol with the data "HELLO" is read when the raster is at an offset of 053, and the separator is set as a space.

The data output would be "HELLO RP053" assuming no other outputs or formatting is enabled.

Scan Status

Usage: Locates the decoded symbol in the scan position.

Definition: Locates the decoded symbol in the scan position (SP).

The scan position is a 3-digit number from 0 to 100 indicating the nearest point from the upper or lower extremity of the symbol to the nearest edge of the entire scan width.

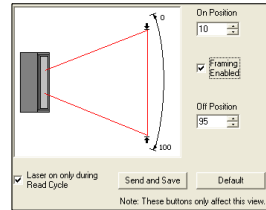

Serial Cmd: <K758,raster status,scan position,separator>

Default: Disabled

Options: 0 = Disabled 1 = Enabled

When enabled the location of the symbol within the scan line is appended to the symbol data output, with a separator. The scan position is formatted with a leading identifier of "SP" plus two zero-padded three digit numbers (corresponding to the first and last bar of the symbol for most symbologies), separated by a colon in the form of:

SPXXX:YYY

The scan position values correspond to the configurable laser on/off position values in the <K700> command.

XXX is the position of the first bar of the symbol

YYY is the position of the last bar, the ranges being 0 to 100.

Note: the scan width data is calculated from the beginning of the full scan width, not the partial or auto-framed width.

Example

Assume a symbol with the data "HELLO" is read when its first bar is at 20% of the scan width. The width of the symbol is 13% of the scan line

The data output would be "HELLO SP020:033" assuming no other outputs or formatting is enabled.

Symbol Position Separator

Definition: Inserts a user-defined character between the decoded data and the symbol position data.

Serial Cmd: <**K758**,*raster status,scan position,separator*>

Default: **Space**

Options: Any ASCII character.

Raster/Scan Position by Symbology Type

Symbology	Timing	Raster position	Scan position
Code 39 Code 128 I2of5 Codabar Code 93 Pharma Code RSS Limited UPC	Position information is from the first decode of the symbol. Symbol position from subsequent decodes of the same symbol is ignored.	Location of raster when symbol was decoded the first time.	Location of symbol within the scan line of the first decode.
UPC, supplemental enabled, and both main and supplemental symbols are decoded	Position values may come from different scans and symbols: Main symbol: First decode. Supplemental: The scan in which both the main and supplemental are decoded.	The most extreme position (closest to the top or bottom of the raster pattern) of either the main or supplemental.	The most extreme position (closest to the edge of scan) from either the main or supplemental. First bar and last bar position values may come from different symbols and scans. Note: At least one position value is from the first decode of the main symbol. The other two values may be from the supplemental. There is no indication as to which position value corresponds to which symbol, but some assumptions can be made if the symbols are moving in a ladder orientation.
UPC, supplemental required	When both symbols decode in the same scan line.	Location of the raster when the symbols were decoded.	The most extreme position (closest to the edge of scan) from either the main or supplemental. First bar and last bar position come from different symbols but the SAME scan.
PDF417	Position values are averaged over several scan lines in which a codeword is decoded.	The average raster position will correspond to the approximate "middle" of the symbol.	Average first and last bar position. Note: If the symbol is moving "fast", position information may tend to "converge" toward the middle of the raster pattern and scan line. First and last bar positions will not correlate to row width.
MicroPDF RSS14 RSS Expanded RSS Stacked	Position values are for the last scan which allows the symbol to fully decode.	The position of the raster when the symbol fully decodes.	These symbologies can sometimes be decoded even when the scan line does not cross all elements in one sweep. Therefore, the position information corresponds to the position of the last scanned element that allows the symbol to fully decode. This is a single point, and therefore, the scan position data is the same for both the first and last bar. Example: SP043:043.
Composite	Position values may be mixed from either the linear or 2D component, and may come from different scans.	The most extreme position (closest to the top or bottom of the raster pattern) of either the linear component or 2D component.	The most extreme position (closest to the edge of scan) from either the linear component or 2D component. First bar and last bar position values may come from different symbols and scans. If both the linear and 2D component are both single-point scan positions (example: RSS+ MicroPDF), then the net scan position will also be a single point.

Read Duration Output

Definition: When enabled the duration (in milliseconds) from when the read cycle started until the symbol data is output is appended to the data with a separator. It is important to note that when in level mode if the user wishes to measure the entire length of the trigger pulse the user needs to set the When to Output Symbol Data to End of Read Cycle. This will prevent the read duration from being shorter than the entire read cycle in the event you qualify the symbol requirements for output before the trigger becomes inactive. This output has the capability of measuring over 49 days worth of duration, if exceeded the message "OVERFLOW" will be output in place of the duration.

Status

Serial Cmd: <K706,status,separator>

Default: **Disabled**

Options: 0 = Disabled 1 = Enabled

Separator

Definition: Any combination of ASCII characters can be defined as the separator.

Serial Cmd: <K706,status,separator>

Default: **(Space)**

Options: Any ASCII character.

Separator can be set to any ASCII characters except **NULL**, **<**, **>**, and **,** .

Chapter

11

Matchcode

Chapter Contents

Matchcode by ESP	11-2
Matchcode by Serial Command	11-2
Overview of Matchcode	11-3
Using Master Symbols.....	11-3
Matchcode Type	11-4
Sequential Matching	11-5
Match Start Position	11-6
Match Length.....	11-7
Wild Card Character	11-8
Sequence On Noread.....	11-9
Sequence On Mismatch	11-10
Sequence Step	11-11
New Master Pin	11-11
Match Replace	11-12
Mismatch Replace.....	11-13

This section explains the matchcode output functions and the master symbol database setup.

Note: When assigning characters in user-defined fields, the characters **NULL**, **<**, **>**, and **,** can only be entered through embedded menus, not through **ESP** or serial commands.

Note: You can learn the current setting of any parameter by inserting a question mark after the number, as in **<K100?>**. To see all "K" commands, send **<K?>**.

Matchcode by ESP



Click this button to bring up the **Matchcode** menu.

To change a setting, **double-click** the setting and use your cursor to scroll through the options.

To open nested options, **single-click** the +.

Parameters	ESP Values
[-] Matchcode	
Matchcode Type	Disabled
Sequential Matching	Increment
Match Start Position	0
Match Length	1
Wild Card	*
Sequence on Noread	Enabled*
Sequence on Mismatch	Disabled
Sequence Step	Enabled*
New Master Pin	Disabled
+ Match Replace	Disabled
[-] Mismatch Replace	Disabled
Replacement String	MISMATCH

Matchcode by Serial Command

Matchcode	
Matchcode Type	<K223,matchcode type,sequential matching,match start position,match length,wild card character,sequence on noread,sequence on mismatch>
Sequence Step	<K228,sequence step>
New Master Pin	<K225,status>
Master Symbol Database Size	<K224,number of master symbols>
Match Replace	<K735,status,message>
Mismatch Replace	<K735,status,message>

Overview of Matchcode

Usage: **Matchcode** is used in applications to sort, route, or verify data based on matching the specific symbol in a variety of ways as defined in this section. For example, a manufacturer might sort a product based on dates that are embedded in the symbol.

Definition: With **Matchcode** you can store master symbol data in the reader's memory, compare this data against the scanned symbols, and define how symbol data and/or discrete signal output will be directed. A master symbol database can be set up for up to 10 master symbols. See "**Master Symbol Database**" on page 15-8.

Using Master Symbols

1. Set **Triggering Mode** to **External** or **Serial** (see "**Trigger Mode**" on page 7-6).
2. Choose the method of symbol comparison that fits your application (see "**Matchcode Type**" on page 11-4).
3. Define the output you want with your matchcode setup:
 - a) Symbol output ("**Symbol Data Output Status**" on page 10-4).
 - b) Discrete output (see Chapter 10, "**I/O Parameters**").
4. Select the number of master symbols you want to create, if more than one (see "**Number of Master Symbols**" on page 15-9).
5. Enter master symbol data in one of the following ways:
 - a) Use **ESP** to type in master symbol data directly into the **Utilities** menu.
 - b) Send a serial command with symbol data in the form of **<Mmaster symbol#,data>** (or **< > data>**) for single master symbol only).
 - c) Send a **<Gmaster symbol number>** command to scan next symbol in as the master symbol.
 - d) Enable the **New Master Pin** command and activate a discrete input to store the next symbol scanned as the master symbol (see "**Sequence Step**" on page 11-11).

See also "**Number of Master Symbols**" on page 15-9 for more information details on entering, requesting, and deleting master symbols.

Matchcode Type

Note: When **Matchcode** is set to **Enabled**, **Wild Card** or **Sequential**, **Number of Symbols** will default back to **1** (if set to any number greater than 1).

Definition: Allows the user to choose the way that master symbols will be compared with subsequently scanned symbols.

Note: First set **Triggering Mode** to **External** or **Serial**.

Serial Cmd: <**K223**,*matchcode type*,*sequential matching*,*match start position*,*match length*,*wild card character*,*sequence on noread*,*sequence on mis-match*>

Default: **Disabled**

Options: 0 = Disabled 2 = Sequential
 1 = Enabled 3 = Wild Card

Disabled: Has no effect on operations.

Enabled: Instructs the reader to compare symbols or portions of symbols with the master symbol.

Sequential Matching: Instructs the reader to sequence after each match (numeric only) and compare symbols or portions of symbols for sequential numbers.

Note: If **Matchcode Type** is set to **Sequential**, **Number of Symbols** will default back to **1** (if set to any number greater than 1).

Wild Card: Allows the user to enter user defined wild card characters in the master symbol.

Sequential Matching

- Usage:* Useful in tracking product serial numbers that increment or decrement sequentially.
- Definition:* With **Sequential** enabled, **Sequential Matching** determines if a count is in ascending (incremental) or descending (decremental) order.
- Serial Cmd:* <**K223**, matchcode type, **sequential matching**, match start position, match length, wild card character, sequence on noread, sequence on mismatch>
- Default:* **Increment**
- Options:* 0 = Increment 1 = Decrement

Match Start Position

Usage: **Match Start Position** is useful in defining specific portions of a symbol for comparisons. For example, if a symbol contains a part number, manufacturing date, and lot code info but the user is only interested in the part number information, **Match Start Position** can be set to only sort on the part number and ignore the rest of the characters.

Definition: **Match Start Position** determines the portions of symbols that will be matched by defining the first character in the symbol (from left to right) that will be compared with those of the master symbol, when **Matchcode Type** is set to **Enabled** or **Sequential**.

Function: For example, if **Match Start Position** is set to 3, the first 2 characters read in the symbol will be ignored and only the 3rd and subsequent characters to the right will be compared, up to the number of characters specified by **Match Length**.

Serial Cmd: <**K223**,matchcode type,sequential matching,**match start position**,match length,wild card character,sequence on noread,sequence on mismatch>

Default: **0**

Options: 0 to 2710

Note: **Match Start Position** must be set to **1** or greater to enable this feature. A **0** setting will disable this feature.

Match Length

- Usage:* For example, if **Match Length** is set to **6** in a 10 character symbol, and **Match Start Position** is set for **2**, only the 2nd through 7th characters (from left to right) will be compared.
- Definition:* Defines the length of the character string that will be compared with that of the master symbol when **Match Start Position** is set to **1** or greater. When **Match Start Position** is set to **0**, no comparison will occur.
- Serial Cmd:* <**K223**,*matchcode type, sequential matching, match start position, match length, wild card character, sequence on noread, sequence on mismatch*>
- Default:* **1**
- Options:* 1 to 2710

Wild Card Character

Usage: For example, with **Wild Card Character** defined as the default asterisk, defining **CR*34** as the master symbol will result in matches for CR**134**, CR**234**, but not CR2345. Entering the wild card at the end of the master symbol as in **CR***** will result in matches for variable symbol lengths such as CR**1**, CR**23**, CR**358**, etc. provided that the number of wild card characters matches or exceeds the number of characters present.

Definition: **Wild Card Character** allows a user to define a wild card character as part of the master symbol.

Serial Cmd: **<K223**, *matchcode type, sequential matching, match start position, match length, **wild card character**, sequence on noread, sequence on mismatch>*

Default: * (asterisk)

Options: Any valid ASCII character

Sequence On Noread

Usage: **Sequence On Noread** is useful when the reader needs to stay in sequence even if no decode occurs.

Definition: When **Sequence On Noread** is **Enabled** and **Matchcode** is set to **Sequential**, the reader sequences the master symbol on every match or noread. When disabled, it does not sequence on a noread.

Serial Cmd: *<K223,matchcode type,sequential matching,match start position,match length,wild card character,sequence on noread,sequence on mismatch>*

Default: **Enabled**

Options: 0 = Disabled 1 = Enabled

As an example of **Sequence on Noread Enabled**, consider the following series of decodes:

Master symbol	Decoded symbol	Master symbol after decode
001	001	002
002	002	003
003	noread	004 (sequenced on noread)
004	004	005
005	noread	006 (sequenced on noread)
006	noread	007 (sequenced on noread)
007	007	008

As an example of **Sequence on Noread Disabled**, consider the following series of decodes:

Master symbol	Decoded symbol	Master symbol after decode
001	001	002
002	002	003
003	noread	003 (not sequenced)
003	003	004
004	noread	004 (not sequenced)
004	noread	004 (not sequenced)
004	004	005

Sequence On Mismatch

Note: Matchcode must be set to **Sequential** for this command to function.

Usage: Enable this parameter if every trigger event should have a decode *and* more than one consecutive mismatch may occur.
 Disable this parameter if every trigger event should have a decode but no more than one consecutive mismatch may occur.

Definition: When set to **Enabled**, the master symbol sequences on every decode, match or mismatch.
 When set to **Disabled**, the master symbol will not sequence whenever consecutive mismatches occur.

Serial Cmd: <**K223**,matchcode type,sequential matching,match start position,match length,wild card character,sequence on noread,**sequence on mismatch**>

Default: **Disabled**

Options: 0 = Disabled 1 = Enabled

The reader will sequence the master to one more/less than the decoded symbol. As an example of **Sequence On Mismatch Enabled**, consider the following decodes:

Master symbol	Decoded symbol	Master symbol after decode
001	001	002
002	002	003
003	abc	004 (sequenced on mismatch)
004	004	005
005	def	006 (sequenced on mismatch)
006	ghi	007 (sequenced on mismatch)
007	007	008

As an example of **Sequence On Mismatch Disabled**, consider the following decodes:

Master symbol	Decoded symbol	Master symbol after decode
001	001	002
002	002	003
003	abc	004 (sequenced because of previous match)
004	004	005
005	def	006 (sequenced because of previous match)
006	ghi	006 (not sequenced because of previous mismatch)
006	006	007

Sequence Step

- Usage:* Useful in applications in which it is desirable to count by intervals other than 1.
- Definition:* Sequencing in **Matchcode** operations can occur in steps from 1 to 32,768.
Sequencing performs like a mechanical counter by displaying positive integers and a specific number of digits after roll-overs. For example, $000 - 3 = 997$ (not -3) and $999 + 3 = 002$ (not 1002).
- Serial Cmd:* **<K228,sequence step>**
- Default:* **1**
- Options:* 0 - 32768

New Master Pin

- Usage:* Some applications require the line worker to change the master symbol. This can be done by installing a switch at the location of the reader. It is very common to have a keyed switch so that accidental switching does not occur.
- Definition:* After **New Master Pin** is enabled, a pulse can be received on the new master pin which will cause the reader to record the next decoded symbol(s) as the new master symbol(s).
It is important to note that the enabling **New Master Pin** does not in itself cause a master symbol to be recorded. The master pin must then be activated momentarily (for a minimum of 10 mS) before a master symbol can be scanned into memory. (See "**Electrical Specifications**" on page A-4.)
- Serial Cmd:* **<K225,status>**
- Default:* **Disabled**
- Options:* 0 = Disabled 1 = Enabled

After **New Master Pin** has been enabled and the pin activated, decodes will be saved in the master database beginning with master symbol #1. If the reader is configured for a multisymbol read cycle (**Number of Symbols** is greater than 1), the remaining decodes will be saved in each consecutive master symbol location. For example, if **Number of Symbols** is set to **3** and **New Master Pin** is then activated, at the end of the next read cycle, the decoded symbols will be saved as master symbols 1, 2, and 3.

Match Replace

Status

Usage: Useful when a user-defined message is needed in place of the match code message.

Definition: When enabled, the **Match Replace** message is output instead of the bar code data when a match occurs.

Serial Cmd: <**K735,status,message**>

Default: **Disabled**

Options: 0 = Disabled 1 = Enabled

Note: In addition to enabling **Match Replace**, you will need to have done the following:

1. Enable a triggered read cycle in "**Trigger**" on page 7-6.
2. Enable "**Matchcode Type**" on page 11-4.
3. Enable "**Symbol Data Output**" on page 10-4.

Match Replacement Message

Definition: Creates the ASCII string that will replace the configured master symbol data that is read whenever a match occurs.

Serial Cmd: <**K735,status,message**>

Default: **MATCH**

Options: 1 to 128 valid ASCII characters

Mismatch Replace

Status

Usage: Useful when a user-defined message is needed in place of the mismatch code message.

Definition: When enabled, the **Mismatch Replace** message is output instead of the bar code data when a mismatch occurs.

Serial Cmd: <**K736,status,message**>

Default: **Disabled**

Options: 0 = Disabled 1 = Enabled

Note: In addition to enabling **Mismatch Replace**, you will need to have done the following:

1. Enable a triggered read cycle in **"Trigger"** on page 7-6.
2. Enable **"Matchcode Type"** on page 11-4.
3. Enable **"Symbol Data Output"** on page 10-4.

Mismatch Replacement Message

Definition: Creates the ASCII string that will replace the configured master symbol data that is read whenever a mismatch occurs.

Serial Cmd: <**K736,status,message**>

Default: **MATCH**

Options: 1 to 128 valid ASCII characters

Chapter

12

Diagnostics

Chapter Contents

Diagnostics by ESP	12-2
Diagnostics by Serial Command	12-2
Diagnostic Messages Overview	12-3
Counts	12-4
Hours Since Last Reset	12-6
Laser High	12-7
Laser Low	12-8
High Temperature	12-9
Low Temperature	12-9
Service Message	12-10

This section describes warning and operating messages and their settings.

Important: Since **Warning Messages** and **NOVRAM Messages** are not enabled by default, these messages will not be displayed. However, if you suspect that erroneous defaults are occurring, enable **Warning Messages** and **NOVRAM Messages** by sending **<K"400,1,,,1>**.

Note: When assigning characters in user-defined fields, the characters **NULL**, **<**, **>**, and **,** can only be entered through embedded menus, not through **ESP** or serial commands.

Note: You can learn the current setting of any parameter by inserting a question mark after the number, as in **<K100?>**. To see all "K" commands, send **<K?>**.

Diagnostics by ESP



Click this button to bring up the **Diagnostics** menu.

To open nested options, **single-click** the +.

To change a setting, **double-click** the setting and use your cursor to scroll through the options.

Parameters	ESP Values
[-] Diagnostics	
[-] Counts	
... Power-on	0
... Resets	0
... Power-on Saves	0
... Custom Default Saves	0
[-] Hours Since Reset (Read Only)	
[-] Laser High	
[-] Laser Low	
[-] High Temperature	
[-] Low Temperature	
[-] Service Message	
... Status	Disabled
... Service Message	SERVICE
... Threshold	300
... Resolution	Seconds*
	Seconds*
	Minutes

Diagnostics by Serial Command

Diagnostics	
Power-on/Resets Counts	<K406,?> returns: <K406,power-on,resets,power-on saves,custom default saves> (read only)
Hours Since Reset	<K407?> returns: <K407,hours,minutes>
Warning Messages	<K400,warning message status,laser high status,laser low status,novram/reset warning status>
Laser High/Laser Low	<K411,laser high status,laser high message,laser low status,laser low message>
High Temperature	<K402,high temperature status,high temperature message>
Low Temperature	<K403,low temperature status,low temperature message>
Service Message	<K409,status,service message,threshold,resolution>

Diagnostic Messages Overview

Usage: These messages serve as a flag to service a scanner or as an early warning that potential problems could arise. They are particularly useful in factories that run 24/7 and can't afford down time.

Definition: Warning messages that relate to the environment and condition of the scanner can be defined and set to activate specific outputs.

Note: When enabled, the error condition will override all other operational modes configured for the output.

When enabled, laser current and NOVRAM warning messages will be transmitted to the host or any active port whenever the pre-defined conditions are met.

Counts

(These commands are **READ ONLY**.)

Sending **<K406?>** returns a four fields of data, as follows:

<K406, power-on, resets, power-on saves, customer default saves>

Power-on Count

Usage: Useful for detecting unwanted resets caused by power supply problems or ESD transients.

Definition Returns the number of times the scanner has been re-powered.

Serial Cmd: Send **<K406?>**

Returns **<K406, power-on, resets, power-on saves, custom default saves>**

Read Only 0 to 65,535 resets.

Ranges:

Resets

Usage: Useful for detecting unwanted resets caused by power supply problems or ESD transients.

Definition Returns Resets for all the "warm" resets, including **<A>**, **<Ard>**, **<Arp>** and **<Arc>**.

Serial Cmd: Send **<K406?>**

Returns **<K406, power-on, resets, power-on saves, custom default saves>**

Read Only 0 to 65,535 resets.

Ranges:

Power-on Saves

<i>Usage:</i>	Useful for detecting unwanted resets caused by power supply problems or ESD transients.
<i>Definition</i>	Returns the number of times the scanner saves for the power-on resets, including <Z> , <Zrd> .
<i>Serial Cmd:</i>	Send <K406?> Returns <K406, power-on, resets, power-on saves, custom default saves>
<i>Read Only Ranges:</i>	0 to 65,535 power-on saves.

Customer Default Saves

<i>Usage:</i>	Useful for detecting unwanted resets caused by power supply problems or ESD transients.
<i>Definition</i>	Returns the number of customer default saves: <Zc> .
<i>Serial Cmd:</i>	Send <K406?> Returns <K406, power-on, resets, power-on saves, custom default saves>
<i>Read Only Ranges:</i>	0 to 65,535 custom default saves.

Hours Since Last Reset

(This command is READ ONLY.)

Usage: Useful as a troubleshooting tool that can help pinpoint the cause of a reset.

Definition: Records the number of hours and minutes of operation since the last system reset.

Serial Cmd: Send **<K407?>**
Returns **<K407, hours, minutes>**

Read Only Ranges: 0 to 23 hours, 0 to 59 minutes.

Laser High

When enabled, a message is transmitted whenever the laser current exceeds a factory-calibrated reference value which cannot be altered. The message repeats once every 30 minutes until the condition is corrected.

Laser High Status

- Usage:* Alerts the user to impending laser failure. (Contact Service.)
- Definition:* Enables the **Laser High** message.
- Serial Cmd:* <**K411**,*laser high status*,*laser high message*,*laser low status*,*laser low message*>
- Default:* **Disabled**
- Options:* 0 = Disabled 1 = Enabled

Laser High Message

- Definition:* Defines the **Laser High** message.
- Serial Cmd:* <**K411**,*laser high status*,*laser high message*,*laser low status*,*laser low message*>
- Default:* **HIGH-LASER**
- Options:* Any 1 to 10 character ASCII string except **NULL**, **<**, or **>**.

Laser Low

When enabled, a message is transmitted whenever the laser current falls below a factory-calibrated reference value which cannot be altered. The message repeats once every 30 minutes until the condition is corrected.

Laser Low Status

- Usage:* Alerts the user to impending laser failure. (Contact Service.)
- Definition:* Enables the **Laser Low** message.
- Serial Cmd:* <**K411**,*laser high status,laser high message,laser low status,laser low message*>
- Default:* **Disabled**
- Options:* 0 = Disabled 1 = Enabled

Laser Low Message

- Definition:* Defines the **Laser Low** message.
- Serial Cmd:* <**K411**,*laser high status,laser high message,laser low status,laser low message*>
- Default:* **LOW-LASER**
- Options:* Any 1 to 10 character ASCII string except **NULL**, <, or >.

High Temperature

High Temperature Status

Serial Cmd: <**K402**,*high temperature status*,*high temperature message*>

Default: **Disabled**

Options: 0 = Disabled 1 = Enabled

High Temperature Message

Serial Cmd: <**K402**,*high temperature status*,**high temperature message**>

Default: **HIGH_TEMP**

Options: Any 1 to 10 character ASCII string except **NULL**, **<**, or **>**.

Low Temperature

Low Temperature Status

Serial Cmd: <**K403**,*low temperature status*,*low temperature message*>

Default: **Disabled**

Options: 0 = Disabled 1 = Enabled

Low Temperature Message

Serial Cmd: <**K403**,*low temperature status*,**low temperature message**>

Default: **HIGH_TEMP**

Options: Any 1 to 10 character ASCII string except **NULL**, **<**, or **>**.

Service Message

Definition: The service timer is reset on power-on. Thus the timer only records the time that has elapsed since the last reset.
The message is sent every time the timer expires.

Service Message Status

Definition: When enabled, a message is sent whenever the system detects that a user-set service time has expired.

Serial Cmd: <**K409,status,service message,threshold,resolution**>

Default: **Disabled**

Options: 0 = Disabled 1 = Enabled

Service Message

Serial Cmd: <**K409,status,service message,threshold,resolution**>

Default: **SERVICE**

Options: Any 1 to 10 ASCII characters except **NULL < , or >**.

Threshold

Definition: Sets the number of hours or minutes that will transpire before the Service message is output.

Serial Cmd: <**K409,status,service message,threshold,resolution**>

Default: **300** (seconds or minutes as set in **Resolution**)

Options: 2 to 65,535

Resolution

Definition: Records time in seconds or minutes.

Serial Cmd: <**K409,status,service message,threshold,resolution**>

Default: **Seconds**

Options: 0 = Seconds 1 = Minutes

Chapter

13

Output Format

Chapter Contents

Output Format by ESP	13-2
Output Format by Serial Command.....	13-2
Output Format Overview	13-3
Extraction Mode	13-4
Insertion Mode.....	13-6
Multisymbol Output Format Status	13-8
Ordered Output	13-10

This section has instructions for assigning formatting rules that determine what portions of a symbol will be read and the specific sequence and data that will be inserted in the output.

Note: The characters **NULL**, **<**, **>**, and **,** can only be entered through embedded menus, not through **ESP** or serial commands.

Note: See Chapter 12, "**Diagnosics**" for definitions and setup of Diagnostic Warnings.

Output Format by ESP



Click this button to bring up the **Output Format** menu.

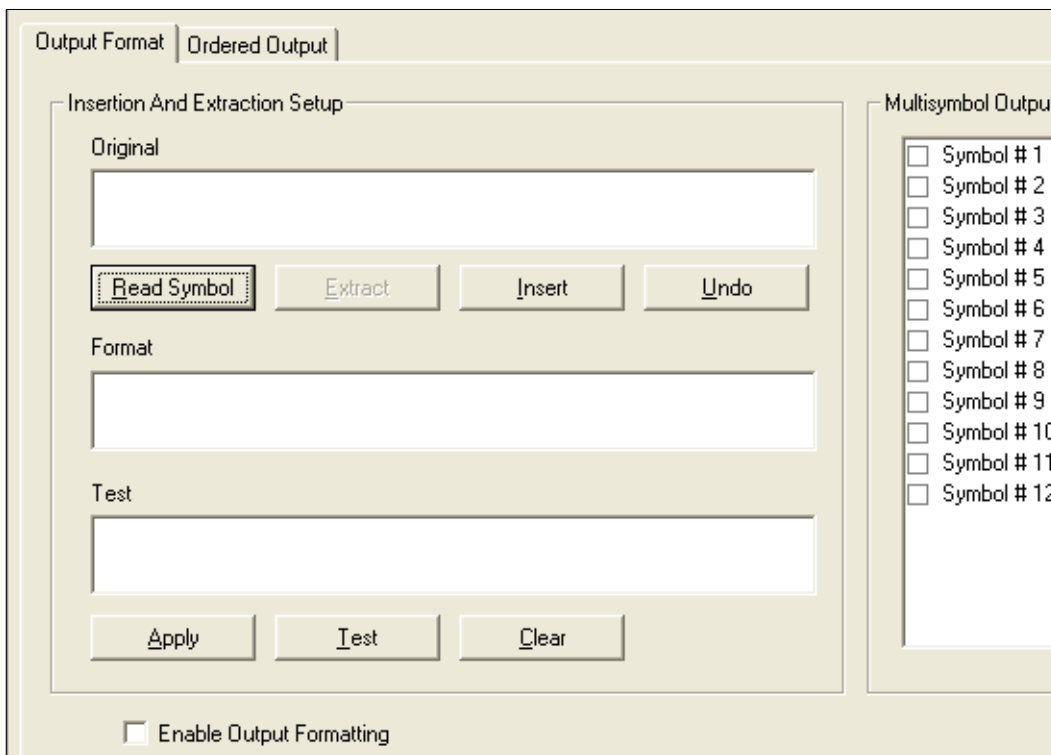

Output Format by Serial Command

Output Format	
Output Format Status	<K743,output format status>
Extraction Mode	<K740,output #,start position,length>
Insertion Mode	<K741,output #,length,hex string>
Multisymbol Output	<K742,symbol number,status>
Ordered Output	<K744,filter index,symbology type,length,wildcard character,placeholder character,data,decode direction,check database number>
Number of Filters	<K745,number of filters involved>

Output Format Overview

Output Format consists of a set of criteria expressed in **Extraction** and **Insertion** serial or **ESP** menu commands that can be chained together to control the presentation of data that is transmitted from decoded symbols. If a symbol does not meet the defined criteria, it is treated as a no-read.

Note that **Extraction** and **Insertion** functions are independent of **Ordered Output** criteria. The output format control can also work with all standard read modes such as **Matchcode**, **Multisymbol** etc.

Commands can be chained together in an array of as many as 100 steps and applied to any symbol.

Output Format Status

Definition: **Output Format Status** is a “master switch” that controls **Output Format**. **Extraction** and/or **Insertion** commands must be defined before an output occurs.

ESP: When you set up **Output Format** in the **ESP Output Format** menu and click on **Apply** in the same menu, **Output Format Status** will be changed to **Enable** in the reader and displayed as such in the **Outputs** configuration menu after you send a **Retrieve Reader Settings** command.

You can also enable/disable **Output Format** from the **Outputs** menu by double-clicking on **Output Format**.

Serial Cmd: <**K743,output format status**>

Default: **Disabled**

Options: 0 = Disabled 1 = Enabled

Note: **Output Format Status** must be enabled in order for any **Output Format** commands to function.

Extraction Mode

Usage: Useful in scanning symbols in which only a portion or portions of the symbol data needs to be transmitted and sorted.

Definition: Selects a portion of the symbol data to be transmitted and ignores the rest.

Extraction by ESP

1. Click **Read Symbol**. This will display in the current symbol data under **Original**.

2. Select text to be extracted.

3. Click **Extract**

4. Click **Apply** or proceed with additional extractions and insertions.

5. Click **Test**.

Note: When you click **Apply**, **Symbol #1** in **Symbol Output Format Status** window will automatically be enabled.

Output Format Extraction

After selecting and entering the extracted portion or portions of a symbol, you can proceed to **Insertion** mode where user-selectable ASCII text can be inserted. You can perform up to 100 instances of extraction and insertion for all symbols being scanned in the read cycle. See "**Multisymbol Output Format Status**" on page 13-8.

Extraction by Serial Command

Output

Definition: An **Output #** identifies the step involved in an output format process. For example, if the routine involves a series of four **Extraction** and/or **Insertion** steps, each of these steps is controlled by assigning sequential output numbers from 1 to 4.

ESP: Output # appears in the **Advanced Formatting** tab.

Serial Cmd: <**K740,output #,start position,length**>

Default: (none) Must be entered.

Options: 1 to 100

Start Position

Definition: Specifies the precise character in the data sequence (from left to right) where the selection for output begins.

Serial Cmd: <**K740,output #,start position,length**>

Default: **0** (Zero is disabled. It also marks the end of a format cell array.)

Options: 0 to maximum characters per symbol (0 is disabled)

Length

Definition: Specifies the length of the output string.

Serial Cmd: <**K740,output #,start position,length**>

Default: **0**

Options: 0 to maximum characters per symbol (0 is disabled)

Insertion Mode

Usage: Useful in adding designators or separators to add meaning or content to data in applications where symbol data needs to be sorted.

Definition: Inserts up to four characters at a time into a data output string. You can add additional characters by repeating the procedure.

Insertion by ESP

Up to 4 ASCII characters can be inserted at any point in symbol input and added to the output. After scanning a symbol and selecting the original characters for extraction, as shown in "Extraction by ESP" on page 13-4, do the following:

The screenshot shows the 'Output Format Insertion' dialog box. It has a title bar 'Output Format | Ordered Output |'. Below the title bar is the 'Insertion And Extraction Setup' section. This section contains three text input fields: 'Original', 'Format', and 'Test'. Below these fields are buttons for 'Read Symbol', 'Insert', 'Apply', 'Test', and 'Clear'. A callout box points to the 'Insert' button with the text: '1. Click **Insert**. You can now add another extraction from the original followed by an insertion and another extraction in any sequence that you want it to appear upon output.' Another callout box points to the 'Format' field with the text: '2. Type in text to be inserted or select ASCII character from the **ASCII** selector and click **OK**. This will append the insertion to the end of the extracted data under **Format**.' A third callout box points to the 'Apply' button with the text: '3. Click on **Apply** when all insertions and extractions are completed.' A fourth callout box points to the 'Test' button with the text: '4. Click on **Test** to see resulting output.' An 'ASCII selector' dialog box is open, titled 'SP 1-1-06', showing a grid of ASCII characters: SOH, STX, ETX, EOT, ENQ, ACK, BEL, BS, HT, LF, VT, FF, CR, SO, SI, SI, DC1, DC2, DC3, DC4, NAK, SYN, ETB, CAN, EM, SUB, ESC, FS, GS, RS, US, SP. It has 'OK' and 'Cancel' buttons.

Output Format Insertion

Insertion by Serial Command

Output

Definition: An **Output #** identifies the step involved in an output format process. For example, if the **Output Format** routine involved a series of four **Extraction** and/or **Insertion** steps, each of these steps is controlled by assigning sequential output numbers from 1 to 4.

Serial Cmd: `<K741,output #,length,hex string>`

Default: (none) Must be entered.

Options: 1 to 100

Length

Definition: Specifies the length of the output string.

Serial Cmd: `<K741,output #,length,hex string>`

Default: **0** (A zero disables **Length** or can mark the end of a format cell array.)

Options: 0 to 4 (0 is disabled)

Hex String

Definition: A pair of hex digits represent an ASCII character. Each pair of hex digits ranges from 00 to FF. Each hex string has a maximum of 4 pairs.

For example, hex 65 = 'e', 6e = 'n', 64 = 'd', thus 656e64 = "end"

Serial Cmd: `<K741,output #,length,hex string>`

Default: **00**

Options: 00 to FF

Output Format Examples by Serial Command

A symbol with the data **ABCDEFGH** needs to be manipulated to output:

DEFGH@\$ABCend.

The following commands are sent to achieve this setup:

`<K740,1,4,5>` for extraction mode, output# = 1, start position = 4, length = 5.

`<K741,2,2,4024>` for insertion mode, output# = 2, length = 2, hex string = 4024.

Note that the hex pairs 40 and 24 = @\$ in ASCII.

`<K740,3,1,3>` for extraction mode, output# = 3, start position = 1, length = 3.

`<K741,4,3,656e64>` for insertion mode, output # = 4, length = 3, hex string = 656e64

Note that 656e64 = "end".

`<K741,0>` This ends the sequence and could have been done with a 740 command, as well.

Multisymbol Output Format Status

Symbol Output Format Status corresponds directly with symbols setup in **Multisymbol**. If **Number of Symbols** in **Multisymbol** is set to the default 1, then only Symbol #1 in **Symbol Output Format Status** will be enabled. See "**Multisymbol**" on page 7-4.

Multisymbol Number

Usage: Allows the user to set up as many symbols that are already assigned in **Multisymbol** for output and filter formatting.

Definition: Specifies the symbol in a multisymbol operation to which output format status is being applied.

Serial Cmd: <K742,symbol number,status>

Options: 1 to 12, as applicable to symbol number.

Output Format Status

Serial Cmd: <K742,symbol number,status>

Default: **Disabled**

Options: 0 = Disabled 1 = Enabled

Enabled means output format control is assigned to a symbol number specified in the first field; for example <K742,9,1> enables symbol number 9.

Output Format Status by ESP

Note: **Multisymbol Output Format Status** table is found on the right side of the **Output Format** tab in the **Output Format** menu.

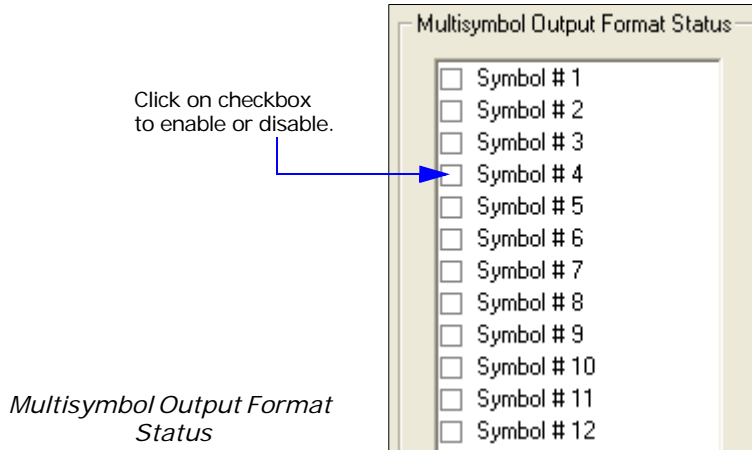

Special Rules for Using Multisymbol with Output Format

1. Unless you want to assign output formatting to more than one symbol at a time in your multisymbol sequence, disable all symbols except the one to which you are applying the output formatting.
2. The 12 symbols in **Multisymbol Output Format Status** correspond to multisymbols; the 12 filters in **Ordered Output** apply only to the order of output and have no relationship to **Multisymbol** or **Symbol Output Format Status**.

Ordered Output

Usage: Useful in sorting several symbols into multiple categories with specific fields and a defined order of output.

Definition: **Ordered Output** involves filtering and ordering.

In the filtering stage, each symbol in a read cycle is read and matched against a user-defined database of up to 12 filters which search on symbology type, symbol length and data contents. A given symbol must meet all three criteria in any one of the filters in order to be included.

In the ordering stage, symbols are transmitted in the order that they match up with the filters. A symbol matching filter #1 will transmit first, another matching filter #2 will transmit next, and so forth.

Rule #1

Each symbol decoded must match one of the filters before it can be saved to a read cycle record. However, an exception exists whenever the number of symbols required for a read cycle exceeds the number of active filters. In this case, unfiltered symbols can be placed into unfiltered output positions. For example, if the number of symbols required is 6 but there are only 4 active filters, the last 2 positions can be filled by any (un-filtered) qualified symbol.

Rule #2

The user can use the same filter setup multiple times. For example, if filters 1, 2, & 3 are setup to filter on Data Matrix symbol type and in the order that they are decoded, qualified Data Matrix symbols will be output in filters 1, 2 & 3 positions.

Rule #3

All qualified symbols will be sorted and output in the filter position they match. If a symbol matches filter 3, it will be output as the 3rd symbol. If a filter does not have a symbol qualified for it, a NOREAD message will be output in place of the symbol (if **Noread** message is enabled). For example, if filter 3 does not have a symbol that meets it's requirements, a NOREAD message will be output in the 3rd output position.

Ordered Output by ESP

- Click on the **Ordered Output** tab.

Filter Number	Code Type	Length	Wildcard	Placeholder	Matching Data
1	Any Type	0	*	?	
2	Any Type	0	*	?	
3		0	*	?	

Number of Filters: 3

Buttons: Receive, Send, Send and Save

Note: These buttons only affect this view.

- Select the **Number of Filters** (1 to 6).
- Double-click on the filter number you wish to define.
- In the **Ordered Output Filter Settings** you can select from the fields shown and add text to be matched, wild cards, etc.
- Click **Apply** to add to the **Ordered Output** table.
- Repeat steps **3** and **4** for each additional filter.
- Click **Send** to save to current memory or **Send and Save** to save for power-on.

Ordered Output Filter Settings

Filter #1 Criteria

Code Type: Any Type

Length: 0

Enter Match String

Matching String: *

ASCII Lookup: CR Add to Match String

Match String Definables

Wildcard Character: *

Placeholder Character: ?

Buttons: Apply, Cancel

Ordered Output by Serial Command

Filter Index

Definition: The filter sequence number from 1 to 12

Serial Cmd: <**K744**,*filter index*,*symbology type*,*length*,*wildcard character*,*placeholder character*,*data*,*decode direction*,*check database number*>

Default: **0** (0 = disabled)

Options: Range 0 to 12

Symbology Type

Definition: User-assigned symbology type that the reader will search for.

If a match is found, the reader then checks **Length**.

Serial Cmd: <**K744**,*filter index*,*symbology type*,*length*,*wildcard character*,*placeholder character*,*data*,*decode direction*,*check database number*>

Default: **0**

Options:

0 = Any type	5 = UPC	10 = RSS
1 = I-2/5	6 = PDF417	11 = MicroPDF
2 = code 39	7 = EAN 128	12 = Composite
3 = code 128	8 = Code 93	
4 = Codabar	9 = Pharmacode	

Symbol Length

Definition: User-assigned symbol length that the reader will search for.

If the length is found, the reader then checks **Wild Card**.

Serial Cmd: <**K744**,*filter index*,*symbology type*,*length*,*wildcard character*,*placeholder character*,*data*,*decode direction*,*check database number*>

Default: **0** (0 = any length)

Options: 0 to 128

Wildcard Character

Definition: **Wildcard Character** indicates that any number of characters that follow the wildcard will be regarded as matches.

For example, "**123***" will match "123", "123456", "123ABC", but not "12".

Filter data "**123*AB?C**" will be interpreted as "123*"

Both **Wildcard Character** and **Placeholder Character** can be mixed in the same filter data.

Serial Cmd: <**K744**,filter index,symbology type,length,**wildcard character**,placeholder character,data,decode direction,check database number>

Default: * = 2A

Options: Any pairings of hex digits representing an ASCII character; for example, 2A = *
(00 = disabled)

Placeholder Character

Definition: **Placeholder Character** is a type of wild card that requires identical data position.

For example, Filter data "**123?**", will match all of the "1234", "123A", but not "123", "12345", "1234C".

Filter data "**123?A**" will match "1234A" and "123BA", but not "123", "1234C" or "1234ABCD"

Both **Wildcard Character** and **Placeholder Character** can be mixed in the same filter data.

Serial Cmd: <**K744**,filter index,symbology type,length,wildcard character,**placeholder character**,data,decode direction,check database number>

Default: ? = 3F

Options: Any ASCII input as pair of hex digit; e.g., 3F=''
(00 = disabled)

Wildcard/Placeholder Matches

Both **Wildcard Character** and **Placeholder Character** can be mixed in the same filter data.

You can regard wildcard marks as the end of matching, whereas a placeholder requires identical data both before and after the placeholder.

For example:

Filter data "**123***" matches "123", "123456", "123ABC" but not "12".

Filter data "**123*AB?C**" will be interpreted as "123*"

Filter data "**123?A?**" matches "1234AB", "123BAT", but not "1234A" or "123BATS".

Filter data "**12??***" matches "1234", "123456", "123ABC", but not "12", "123".

Filter data "**123?A***" matches "1234A", "123BA", "123BATS", but not "1234", "1234C".

Ordered Output

Data

Definition: User-assigned data that the reader will search for.

Serial Cmd: <**K744**,*filter index,symbology type,length,wildcard character,placeholder character,data,decode direction,check database number*>

Default: **Null**

Options: Any pairing of hex digits representing ASCII characters;
e.g., 41422A = "AB*"
(00 = disabled)

Decode Direction

Definition: The current symbol decode direction is compared with the direction of the filter. If decode direction comparison succeeded then move to the next item.

Serial Cmd: <**K744**,*filter index,symbology type,length,wildcard character,placeholder character,data,decode direction,check database number*>

Default: **Any Direction**

Options: 0 = Any direction 1 = Forward 2 = Reverse

Check Index

Definition: The configuration database of the first decode of a symbol is compared with the filter indexes, as enabled. If a match occurs, the current symbol is a qualified symbol and will be saved for output. If it does not match, the remaining filters are searched again, starting again with symbology type.

Serial Cmd: <**K744**,*filter index,symbology type,length,wildcard character,placeholder character,data,decode direction,check database number*>

Default: **0** (0 = any database)

Options: 0 = Any Index 1 = Database #1...12

Number of Filters

Definition: The number of filters that symbols will be compared against, up to the specified number. For example, entering 7 means that filters #1 through #7 will be enabled.

Serial Cmd: <K745,number of filters involved>

Default: 0

Options: 0 to 12

Any number from 1 to 12 enables **Output Filtering**. A zero (0) disables **Output Filtering**. The reader will not perform any filtered output.

For example:

<K745,1> enables **Output Filters** #1 setting.

<K745,3> enables **Output Filters** #1 to filter #3's setting.

<K745,0> disables all output filters. The reader will not perform any filtered output.

Examples to enable and setup filters 1 and 2:

Filter #1

Symbology type = Code 39, Length = disabled, Wildcard = '*', placeholder = '?', data = "AB*" = 41422A

<K744,1,3,0,2A,3F,41422a>

Filter #2

Symbology type = Code 128, Length = 8, Wildcard = '*', placeholder = '?', data = "NBC??FGH" = 4e42433f3f464748.

<K744,2,4,8,2A,3F,4e42433f3f464748>

<K745,2> enables **Ordered Output**. It also enables filter index1 and filter index2.

Let's say we have four symbols, "NBCXYFGH", "NBDXYFGH", "123XYZ", "ABCDE". The reader will registered two good reads only and transmit the following: "ABCDE", "NBCX-YFGH".

Chapter

14

Terminal Mode

Chapter Contents

Terminal Window.....	14-2
Find Function.....	14-3
Macros.....	14-4
Terminal Window Functions	14-5

This section describes the terminal window and macro functions.

Note: The characters **NULL**, **<**, **>**, and **,** can only be entered through embedded menus, not through **ESP** or serial commands.

Note: You can learn the current setting of any parameter by inserting a question mark after the number, as in **<K100?>**. To see all “**K**” commands, send **<K?>**.

Terminal Window

To use the terminal mode, click on the **Terminal** button.



You will see the following window:

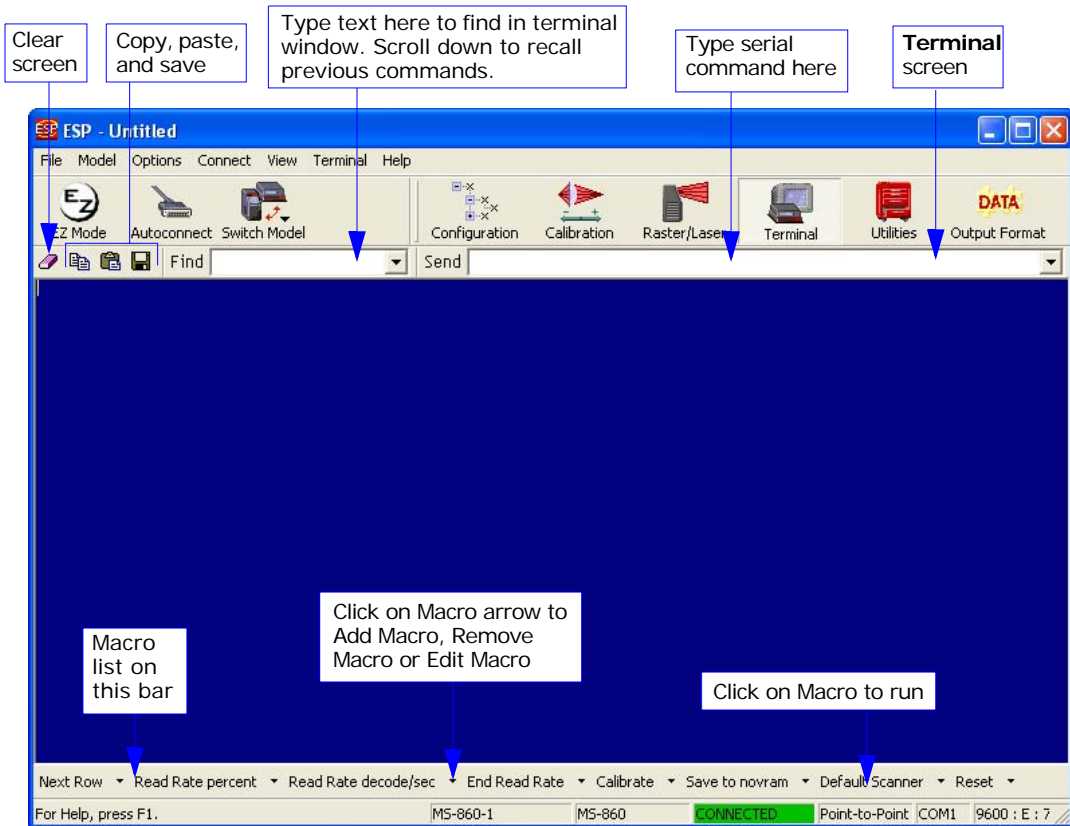

Terminal Window

The terminal screen allows you to enter serial commands (in **red**) from the macro box, by copying, or directly from your keyboard.

The terminal screen also displays bar code data or information from the reader (in blue).

You can also right click in the terminal screen to bring up a handy option box.

Find Function

The **Find** box allows you to enter text strings to be searched for in the terminal window. For example a series of bar codes have been scanned into the terminal view and you want to determine if a particular bar code starting with ABC has been read.

1. Type **ABC** into the **Find** box.

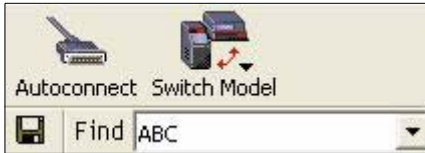

2. Press **Enter**.
The first instance of **ABC** will be high-lighted in the terminal window.
3. Press the **F3** key to search again for the next instance of **ABC**.
4. Press **Shift-F3** to search for the previous instance of **ABC**.

Macros

Macros can be stored in a macro selection bar, edited in a separate window, and executed by clicking on the macro name.



Click on **Next Row** to see the next row of macros

Click on the first arrow here to see **Add Macro** or **Default Macros**. When you default macros, the entire macros set is restored to their original macro commands.

Click any other arrow to edit a macro.

When you click on the macro name, the macro is executed in the terminal window. If this is a command, the command is also sent to the reader at the same time it is displayed.

Editing a Macro

When you click the arrow next to any macro and select **Edit**, the following appears:

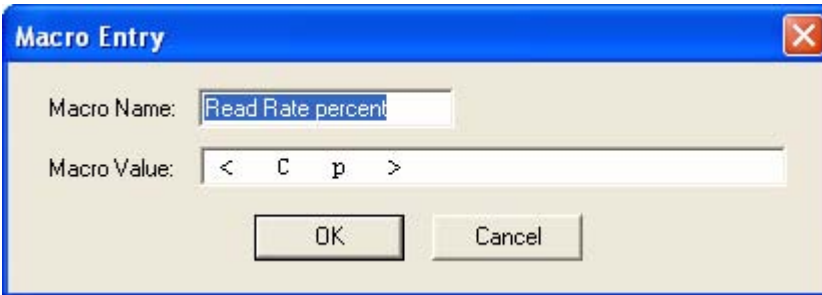

You can edit an existing macro or type in a new macro name and define it in the **Macro Value** text box. Click **OK**.

Terminal Window Functions

Right-click on the terminal window to display the following:

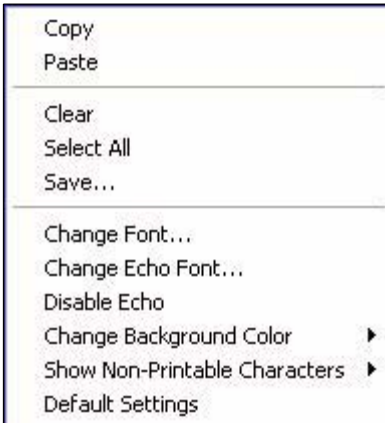

- **Copy** selected text to clipboard.
- **Paste** from terminal or computer text.
- **Clear** all text in terminal window.
- **Select All** text in the terminal window.
- **Save...** brings up a save as dialog box.
- **Change Font...** of data text, brings up a text dialog.
- **Change Echo Font...** to change typed in text or commands.
- **Change Background Color** of terminal window.
- **Default Settings** changes all the above back to default settings.

Terminal Pulldown Menu

The pulldown **Terminal** menu has **Capture and Save Current Text** as well as the functions defined above.

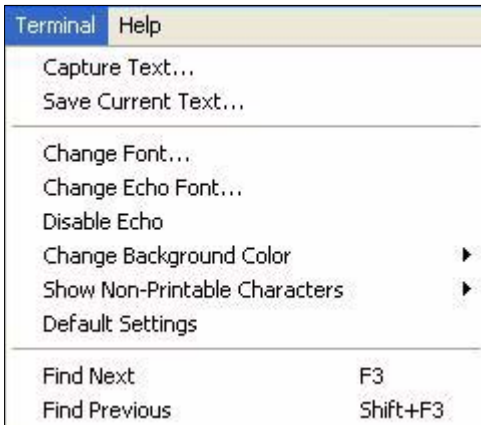

- **Capture** lets you append data in real time to a text file of your choice. While in operation, the text file cannot be opened. You can select **Pause** to interrupt the capture flow or **Stop** to end the flow and open the file.
- **Save Current Text...** saves all text in the terminal window to a text file of your choice.

Chapter

15

Utilities

Chapter Contents

Utilities by ESP	15-2
Read Rate	15-3
Counters	15-4
Device Control	15-6
Master Symbol Database	15-8
Digital Bar Code	15-12
Firmware	15-13
Symbol Type	15-15
Defaulting/Saving/Resetting	15-16

Utility commands are generally commands that are performed during reader operations to check read rates, determine read rates or perform miscellaneous operations on reader hardware. Serial utility commands are not prefaced with a “K” and a numeric code, nor do they require an initialization command (<A> and <Z>). They can be entered from within any terminal program or from within **ESP** in the **Terminal** window.

Note on Serial Commands: To preserve continuity with other Microscan products, some serial configuration commands may include 0s (zeros) or 1s as placeholders. In order for a these commands to be implemented, the placeholder values or commas must be included.

Note: You can learn the current setting of any parameter by inserting a question mark after the number, as in <K100?>. To see all “K” commands, send <K?>.

Note: The characters **NULL**, <, >, and , can only be entered through embedded menus, not through **ESP** or serial commands.

Utilities by ESP

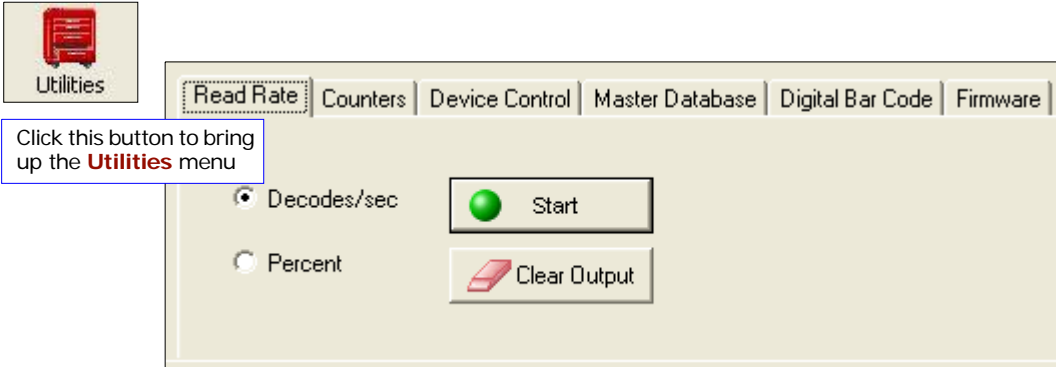

Note: Utility commands are not accessible by embedded menus.

Read Rate

When in a read rate mode, the reader will output a number preceding the symbol data. This number will represent either the number of decoded scans per second or the percentage of successful decoder per total number of scans.

Make a note of the decode rate. It will be a useful reference when calculating the number of decodes. (See "[Formulas for Number of Decodes](#)" on page A-20.)

Read Rate by ESP

You can access **Read Rate** from the **Utilities** menu. To start or end a read rate test, right-click **Read Rate** and select **Start** or **Stop**.

To change from percent read rate to decodes per second, first end the read rate by selecting **Stop**, then right-click and select **Decodes/Sec**.

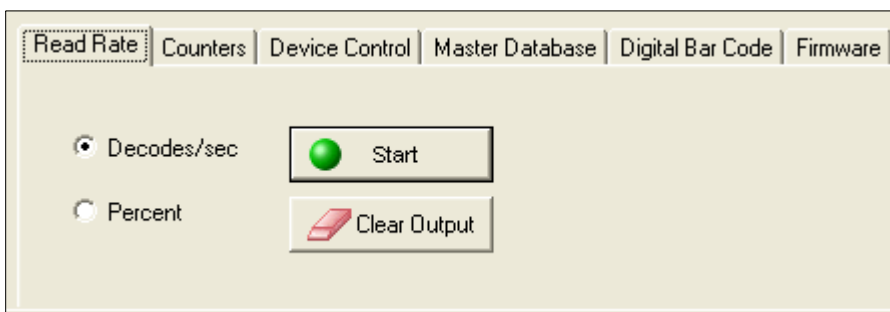

Read Rate by Serial Command

Enter Single Symbol Decodes/Second Test

Sending **<C>** instructs the reader to transmit the decodes per second and symbol data (if any). The decode rate can vary dramatically due to the angle and location of the symbol in relation to the scan line. This test is very useful in aligning and positioning the scanning device during installation.

Enter Single Symbol Percent Test

Sending **<Cp>** instructs the reader to transmit the percentage of decodes and any scanned symbol data.

Extended Read Rate

Sending **<Ce>** instructs the reader to transmit the decodes per second along with the transitions, scan position, and raster position.

Note: The **<Ce>** command has no immediate effect if not preceded by **<C>** or **<Cs>**.

End Read Rate Test

Sending **<J>** ends both the **Percent** test and the **Decodes/Second** test for both single and multi-symbol. Sending a **<J>** will end the read cycle.

Counters

Counter commands can be a numeric value from 00000 to 65,535. After reaching the maximum numeric limit of 65,535, the counter will automatically roll-over and start counting again at 00000 and report any errors. To obtain the cumulative total of counts after the roll-over has occurred, add 65,536 per each roll-over (the reader does not keep track of the number of roll-overs) to the current count.

Note: All counter values will be lost if power is re-cycled to the reader or the reader receives a reset or save command.

Counters by ESP

You can access **Counters** from the **Utilities** menu.

Right-click the appropriate counter option and select **Request** to display count or **Clear** to set counter to zero. Or, right-click on **Counters** and select **Request All**.

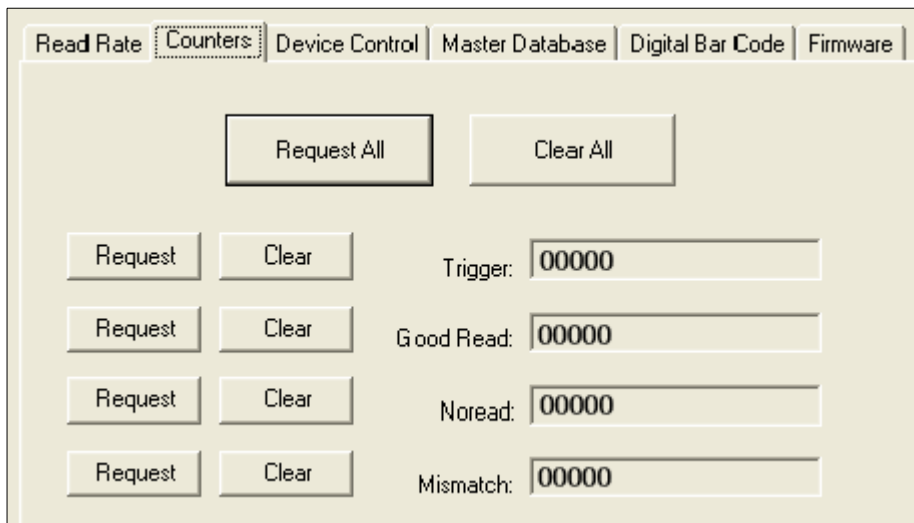

Counters by Serial Command

Noread Counter

Sending **<N>** displays the total number of noreads that have occurred since the last reset.

Noread Counter Reset

Sending **<O>** sets Noread Counter to 00000.

Trigger Counter

Sending **<T>** displays the total number of triggers since the last reset.

Trigger Counter Reset

Sending **<U>** sets the trigger counter to 00000.

Good Read/Match Counter

Sending **<V>** displays the total number of good reads matching the master symbol if **Matchcode** is enabled. This counter is always enabled, but will only work as a match count when **Matchcode** is enabled. If **Matchcode** is not enabled, this counter records the number of good reads. This count can be requested at any time.

Good Read/Match Counter Reset

Sending **<W>** sets the match counter to 00000.

Mismatch Counter

With **Matchcode** enabled, sending **<X>** displays the number of decoded symbols since the last reset that do not match the master symbol.

Mismatch Counter Reset

Sending **<Y>** sets the mismatch counter to zero.

Device Control

Outputs

You can access **Device Control** from the **Utilities** menu.

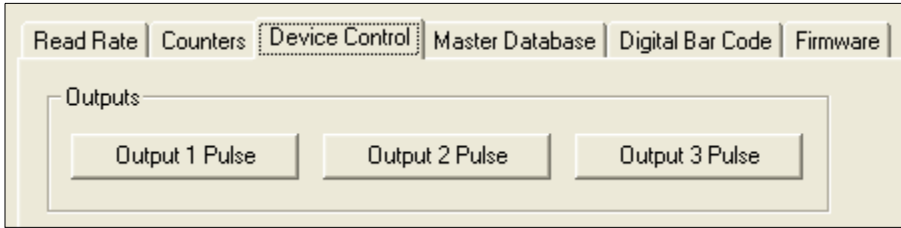

Output # 1 Pulse

Definition: Activates the link between **Output 1 (+)** and **Output 1 (-)** of the host connector for the duration set by "**Pulse Width (Output 1)**" on page 10-17. (regardless of **Master Symbol** or **Output 1** status).

ESP: Click **Output # 1 Pulse** to activate.

Serial Cmd: **<L1>**

Output # 2 Pulse

Definition: Activates the link between **Output 2 (+)** and **Output 2 (-)** of the host connector for the duration set by "**Pulse Width (Output 1)**" on page 10-17. (regardless of **Master Symbol** or **Output 2** status).

ESP: Click **Output # 2 Pulse** to activate.

Serial Cmd: **<L2>**

Output # 3 Pulse

Definition: Activates the link between **Output 3 (+)** and **Output 3 (-)** of the host connector for the duration set by "**Pulse Width (Output 1)**" on page 10-17. (regardless of **Master Symbol** or **Output 3** status).

ESP: Click **Output # 3 Pulse** to activate.

Serial Cmd: **<L3>**

Extras

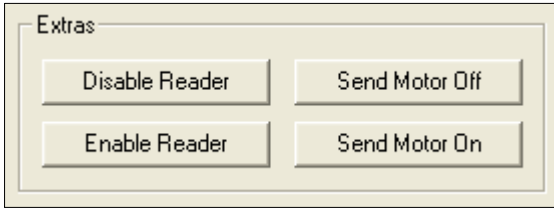

Disable Reader

Usage: This feature is useful during extended periods of time when no symbols are being scanned or the reader is being configured.

Definition: Sending **<I>** will turn the laser off and end the current read cycle.

ESP: Click **Disable Reader** button.

Serial Cmd: **<I>**

Disabling laser scanning will not affect any downloaded commands to the reader.

Enable Reader

Definition: Causes the laser reader to be on continuously.

ESP: Click **Enable Reader** button.

Serial Cmd: **<H>**

Note: **Enable/Disable Reader** does not relate to **Laser On/Off** command.

Send Motor Off

Usage: This feature is useful during extended periods of time when no symbols are being scanned or the reader is being configured.

Definition: Turns the spinning mirror off (if not already running).

ESP: Click **Send Motor Off** button.

Serial Cmd: **<KF>** or **<K501>**

Send Motor On

Usage: This feature is useful during extended periods of time when no symbols are being scanned or the reader is being configured.

Definition: Turns the spinning mirror on (if not already running).

ESP: Click **Send Motor On** button.

Serial Cmd: **<KE>** or **<K500>**

Master Symbol Database

Sequential and **Wild Card** are NOT enabled, and **Start Position** is equal to **0**.

Master Database Overview

Usage: Used where more than one master symbol is required, as in a **Multisymbol** setup, for matching and other matchcode operations.

Definition: Allows you to define up to 10 master symbols as the master symbol database, which can be entered by keyboard, scanned in, displayed, or deleted by serial or **ESP** commands.

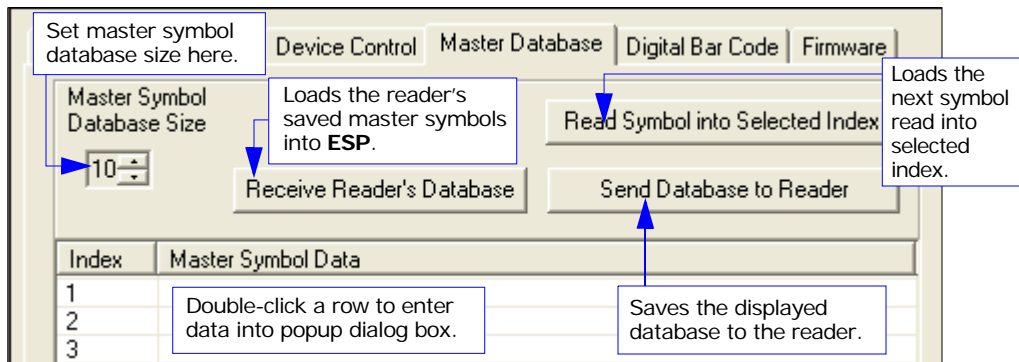

Maximum Characters for Master Symbol Database

Master Symbol Number	Maximum Characters
1	2710
2	1355
3	903
4	667
5	542
6	451
7	387
8	338
9	301
10	271

Number of Master Symbols

Definition: **Number Of Master Symbols** allows you to select 1 to 10 master symbols for the master symbol database.

Serial Cmd: <**K224,number of master symbols**>

Note: To request the number of master symbols Send <**K224,?**>

Default: 1

Options: 1 to 10

To Set the Number of Master Symbols in ESP

1. Click the **Utilities** button and click the **Master Database** tab.
2. Click the **Matchcode Type** checkbox to enable **Matchcode**.
3. Set the number of master symbols you want to include.

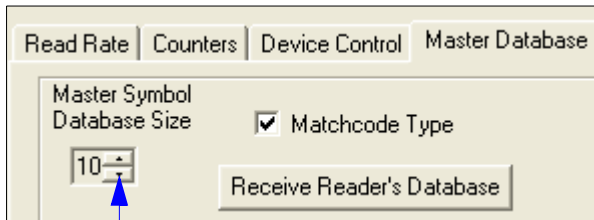

Scroll up or down to set the number of master symbols.

To Request the Number of Master Symbols in ESP

1. Click the **Utilities** button and the **Master Database** tab.
2. Click on the **Receive Reader's Database** button.

Enter Master Symbol Data

Definition: Allows you to enter master symbol data for a specific master symbol index number (1 to 10), provided the index number is not larger than the number of symbols enabled by the **Number Of Master Symbols** (see page 15-9). For example, if **Number Of Master Symbols** is set to 2, you will not be able to enter data for symbols 3 through 10.

Serial Cmd: <K231, master symbol number, master symbol data>

Default: 1, (blank)

Options: 1 to 10, any combination of ASCII text up to the maximum indicated in "**Maximum Characters for Master Symbol Database**" on page 15-8. For example, to enter data for master symbol 9, after making certain that **Number Of Master Symbols** is enabled for 9 or more symbols, send <K231, 9, data>.

To enter master symbol data:

1. **Double-click** on each index number you want to setup and copy or type in your data in the popup data entry box.
2. Click on the **Send Database to Reader** button.

Note: You can also click **Receive Reader's Database** to enter the reader's current database settings.

Caution: Since the total number of characters available for the master symbol database is **128**, changes to the **Number Of Master Symbols** will re-allocate the number of characters available for each master symbol and could cause existing master symbols to be deleted (except master symbol #1 unless it also exceeds the size limitation).

The "**Maximum Characters for Master Symbol Database**" table on page 15-8 specifies the maximum number of characters available to each symbol according to the number of master symbols defined, from 1 through 10. See "**Number of Master Symbols**" on page 15-9.

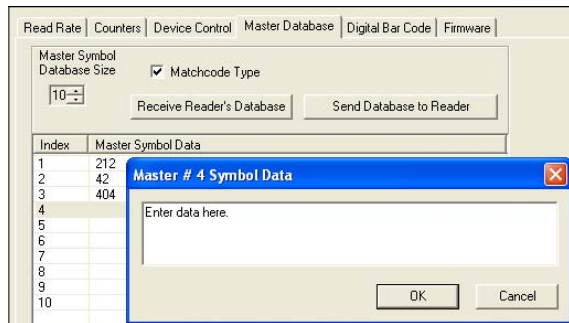

Request Master Symbol Data

- Definition:** Returns master symbol data for any enabled master symbols from 1 to 10.
For example, to request master symbol #5, enter **<K231?,5>**. The reader transmits the following format: **<K231,5,data>**. If no master symbol data available, the output will be: **<M5/?>**.
- Serial Cmd:** Send **<K231?,master symbol number,master symbol data>** to request the current master symbol for a specific master symbol.
Returns all master symbols if no number is added before the question mark.
- Options:** 1 to 10

Request All Master Symbols Data

- Definition:** Returns master symbol data for all enabled master symbols from 1 to 10.
- Serial Cmd:** Send **<K231?>** to request all current master symbols.

Delete Master Symbol Data

- Definition:** **Delete Master Symbol Data** allows you to delete an enabled master symbol.
- Serial Cmd:** Send **<K231,master symbol number,>** to delete the master symbol.
- Options:** 1 to 10

Store Next Symbol as Master Symbol

- Definition:** After you've set the size in the database, you can order the reader to scan-in the next symbol as master symbol 1.
- Serial Cmd:** **<Gmaster symbol number>**
To store the next symbol scanned as master symbol #1 send: **<G>** or **<G1>**. For all symbols numbers except 1, the number must be included.
- Options:** 1 to 10

Digital Bar Code

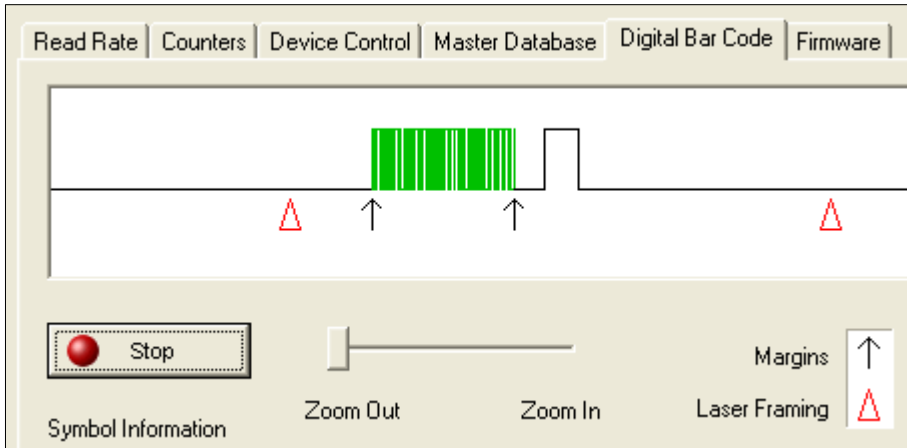

When you click the **Digital Bar Code** tab and the **Start** button, a digitized representation of the symbol in front of the reader will appear.

This routine is useful for conveying a sense of the symbol's readability and graphically indicating bad or unreadable portions of symbols, extraneous "noise," etc. A green waveform indicates a decoded symbol; a red waveform indicates an undecoded symbol or other object.

The read triangles represent the width of the scan beam relative to the symbol. The upward pointing arrows indicated the symbol's margin.

Zoom In, Zoom Out

You can zoom in by sliding the **Zoom** lever to the right. You may have to scroll right or left to locate your symbol, but the results will be striking.

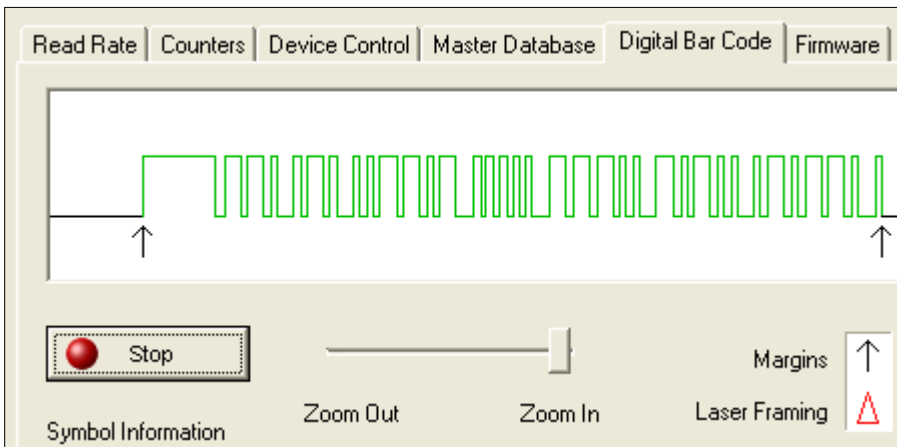

Firmware

Firmware Update

Firmware Update is used to download application code to the reader.

Application code versions are specific to your reader. Consult with your sales representative before downloading application code. If needed, an application code will be sent to you in the form of a ***.mot** file.

To download application code:

1. First make sure the host is connected to your reader.
2. Apply power to the reader.
3. In the **Firmware Update** pulldown window, select **App Code**.
This will open a file dialog box.
4. Navigate to the appropriate file (a ***.mot** file) and open the file.
5. Allow a minute or so for the firmware to download.

As application code begins to download to the reader, the reader will go silent, the reader's RDY and GD/RD LEDs will flash intermittently, and a progress indicator at the bottom of the **ESP** window will let you know when the download is complete.

Caution: Do not interrupt power or disconnect the host cable while download is in progress.

Firmware Verification

Request Part Number

From the **Firmware** tab in the **Utilities** menu, select **App Code** or **Boot Code** from the pulldown selection box and click **Request Part No.**

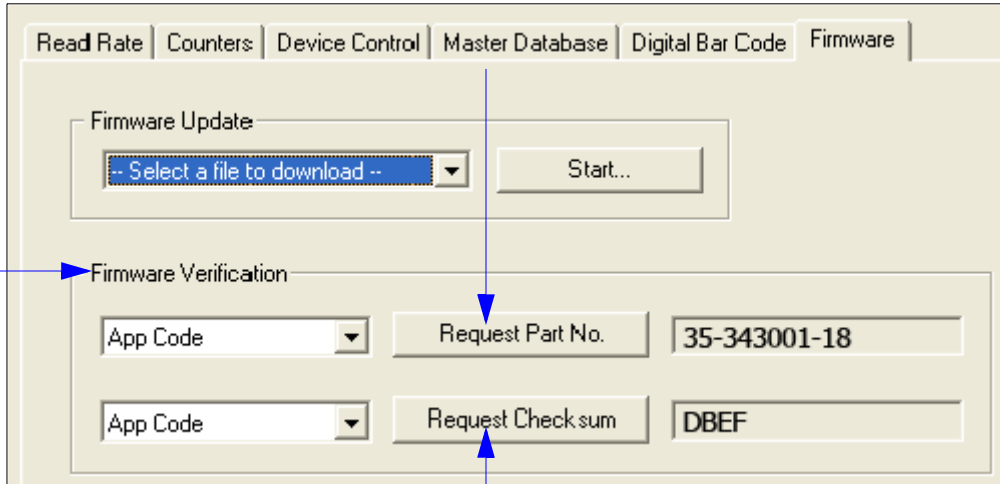

Request Checksum

From the **Firmware** tab in the **Utilities** menu, select **App Code** or **Boot Code** from the pulldown selection box and click **Request Checksum No.**

Firmware/Checksum Verification

From **Firmware Verification** you can request the part number and checksum from by selecting **App Code** or **Boot Code** and clicking the accompanying **Request...** button.

Symbol Type

Sending **<P>** enables the reader to decode all available symbol types except Pharmaco and PDF417 without changing reader configuration.

Sending **<Q>** enables the reader to decode Code 39 symbols without changing reader configuration.

Sending **<R>** enables the reader to decode Codabar symbols without changing reader configuration.

Sending **<S>** enables the reader to decode I-2/5 symbols without changing reader configuration.

Defaulting/Saving/Resetting

Understanding and controlling your reader's active, saved, and default settings is critical to the operation of your reader.

Software Reset/Save/Recall Commands

<A>	Reset (does not save for power-on)
<Ard>	Reset and recall factory defaults
<Arp>	Reset and recall power-on parameters
<Arc>	Reset and recall customer default parameters
<Z>	Save current settings for power-on
<Zc>	Save current settings as customer default parameters
<Zrd>	Recall factory defaults and save for power-on
<Zrc>	Recall customer default and save for power-on
<Zp>	Reset and save factory settings

Important: The following commands need to be followed by a **<Z>** to be saved for power-on:

Host Protocol, Baud Rate, Data Bits, Stop Bits, Parity, Trigger Characters (Delimited, Start, and Stop) Preamble, Postamble, and Noread Message.

All other parameters are saved for power-on without a **<Z>**. However, a **<Zrd>** affects all parameters.

See "[Defaulting/Saving/Resetting](#)" on page A-16 for a complete explanation of resets, saves and defaulting.

Appendices

Chapter Contents

Appendix A General Specifications	A-2
Appendix B Electrical Specifications	A-4
Appendix C Serial Configuration Commands	A-8
Appendix D Serial Command Format.....	A-12
Appendix E ASCII Table.....	A-14
Appendix F Defaulting/Saving/Resetting.....	A-16
Appendix G Symbol Configuration	A-18
Appendix H Formulas for Number of Decodes.....	A-20
Appendix I Operational Tips	A-23
Appendix J Embedded Menus	A-24
Appendix K Interface Standards.....	A-25
Appendix L Multidrop Communications	A-26
Appendix M Glossary of Terms	A-31

Appendix A — General Specifications

Mechanical

Height:	4.28" (109mm)
Width:	3.74" (95mm)
Depth:	1.76" (45mm)
Weight:	16 oz. (453g)

Environmental

Enclosure rating: IP65

Operating temperature: 0° to 50° C
(32° to 122° F)

Storage temperature: -50° to 75°
(-63° to 167° F)

Humidity: Up to 90% (non-condensing)

Emissions

EN 55022:1998 + A1:2000 + A2:2003 Limits & Methods: ITE Disturbances (radiated and conducted)

EN55024:1998 (General Immunity: Residential)

EN61000-6-2:2001 (Heavy Industrial: Immunity)

Laser Light

Type: Semiconductor visible laser diode
(650nm nominal)

Operating Life: 50,000 hours @ 25°C

Safety class: CDRH Class II

Scanning Parameters

Scanning mirror type: Rotating, 10-faceted

Options: Single line, fixed raster

Scan speed: Adjustable from 300 to 1200 scans/second; default = 500 sps

Scan width angle: typically 60°

Pitch: ±50° maximum

Skew: ±40° maximum

Symbol contrast: 25% min. absolute dark to light @ 650nm wavelength

Safety Certifications

FCC, CDRH, CE, UL/cUL, BSMI pending

Communications

RS-232, RS-422/485, Daisy chain, and auxiliary port capable

Symbologies

Standard: Code 39, Code 128/EAN-128, 1-2/5, Codabar, Code 93, UPC/EAN, Pharmacode, and PDF417, Industrial 2/5, RSS 14, RSS Expanded, RSS Limited, PDF417, Composite.

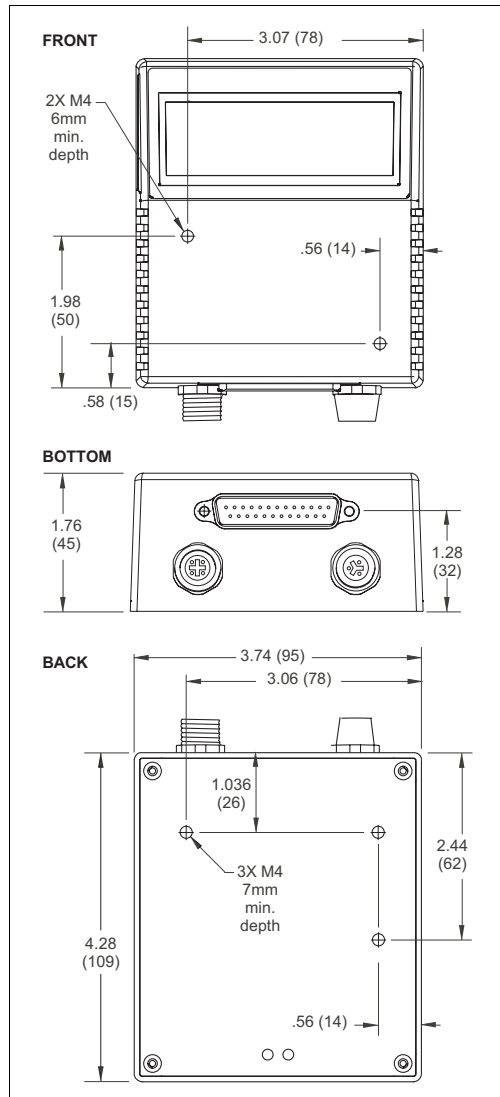

MS-860 Industrial Raster Reader

Read Ranges

Read Ranges with FIS Options

Narrow-bar-width	Range
FIS-0860-0003G - High Density (@ >350 dps)	
5 mil (.127 mm)	1.5" to 2.75" (38 to 70 mm)
7.5 mil (.191 mm)	1" to 4" (25 to 102 mm)
FIS-0860-0002G - Medium Density (@ >350 dps)	
7.5 mil (.191 mm)	1.5" to 5.25" (38 to 113 mm)
10 mil (.254 mm)	.75" to 7.25" (19 to 184 mm)
15 mil (.381 mm)	.5" to 9.25" (13 to 235 mm)
30 mil (.762 mm)	1" to 13" (25 to 330 mm)
FIS-0860-0001G - Low Density (@ >350 dps)	
10 mil (.254 mm)	6.5" to 13.25" (165 to 336 mm)
15 mil (.381 mm)	4" to 18" (102 to 457 mm)
20 mil (.508 mm)	2.5" to 20" (64 to 508 mm)
30 mil (.762 mm)	2" to 24" (50 to 610 mm)
40 mil (1.02 mm)	2" to 28" (50 to 711 mm)

Narrow-bar-width	Range
FIS-0860-0007G - Extended Range, Near Focus @ >350 dps	
10 mil (.254 mm)	3" to 11" (77 to 279 mm)
15 mil (.381 mm)	2" to 16" (51 to 406 mm)
FIS-0860-0008G - Extended Range, Middle Focus @ >350 dps	
10 mil (.254 mm)	14" to 17" (356 - 431 mm)
15 mil (.381 mm)	11" to 21" (280 - 533 mm)
FIS-0860-0004G - Extended Range, Far Focus @ >350 dps)	
20 mil (.508 mm)	25" to 41" (635 - 1041 mm)
30 mil (.762 mm)	21" to 42" (534 - 1066 mm)
40 mil (1.02 mm)	19" to 47" (483 to 1193 mm)

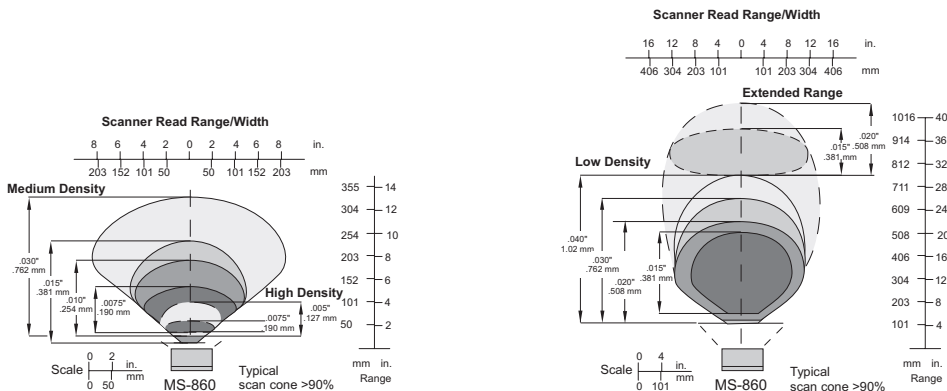

Appendix B — Electrical Specifications

Maximum Operating Power: 5W max.

Power Input: 10 to 28VDC, 200mV p-p max. ripple, 110 mA @ 24VDC (typical)

Outputs (1,2,3): 1 to 28VDC rated (optoisolated) ($I_{CE} < 100mA @ 24VDC$, current limited by user)

Trigger, Input 1, New Master: 5 to 28 VDC rated (optoisolated)

MS-860 Host Connector (25-pin D-subminiature)

Pin	Host RS232	Host & Aux RS232	Host RS422/485	In/Out
1	Chassis ground			
2	TxD			Out
3	RxD			In
4	RTS	Aux TxD		Out
5	CTS	Aux RxD		In
6	Output 1 (+)			Out
7	Signal ground			
8	Output 2 (+)			Out
9	Trigger (-)			In
10	Trigger (+)			In
11	Default configuration (activated by connecting pin 11 to pin 7)			
12	Input 1 (+)			In
13			RxD (+)	In
14			TxD (-)	Out
15	Noread/Output 3 (+)			Out
16			RxD (-)	In
17	Power ground			
18	Power +10 to 28 VDC			In
19			TxD (+)	Out
20	Output 1 (-)			Out
21	Output 2 (-)			Out
22	Noread/Output 3 (-)			Out
23	Input 1 (-)			In
24	New master (-)			In
25	New master (+)			In

MS-860 Power Connector (3-pin MicroChange)

1	Power ground	
2	NC	
3	Power + 10 to 28 VDC	In

MS-860 Trigger Connector (4-pin MicroChange)

1	Power + 10 to 28 VDC	Out
2	Trigger -	
3	Power ground ^a	
4	Trigger +	

a. Power ground: Used for power return only.

Caution:

1. Be sure all cables are connected **BEFORE** applying power.
2. Always power down **BEFORE** disconnecting any cables.

Connectors on the back of the MS-860:

- (1) Power connector
- (2) Host 25-pin connector
- (3) Trigger connector

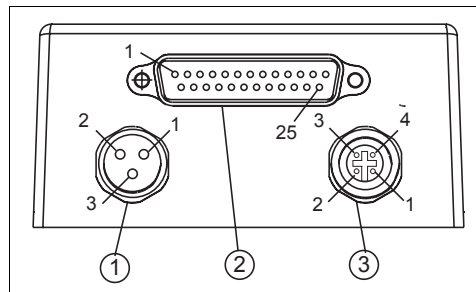

Reader Connectors

Optoisolator Outputs

Optoisolator circuits can transfer pulses between the reader and peripherals with no direct connection with the reader's internal circuitry. However, not every optoisolator configuration provides complete isolation. The following diagrams show both fully optoisolated and non-optoisolated and non-optoisolated circuits. They are only examples and do not represent all the possible wiring configurations.

	$I_{load} = 5\text{mA}$	$I_{load} = 50\text{mA}$	$I_{load} = 100\text{mA}$
V_{Out-On}^a	0.7 V	0.9V	1.0V
t_{On-Typ}	30 μS	20 μS	30 μS
$t_{Off-Typ}$	1000 μS	150 μS	75 μS

a. Voltage drop across output when activated.

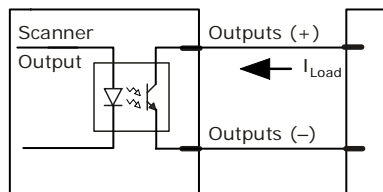

Output Circuit Examples

Fully Optoisolated

This circuit is fully optoisolated and is the recommended configuration. It allows the user to apply 1 to 28 VDC to the circuit.

Caution: The maximum current that can pass through the optoisolator is 100mA.

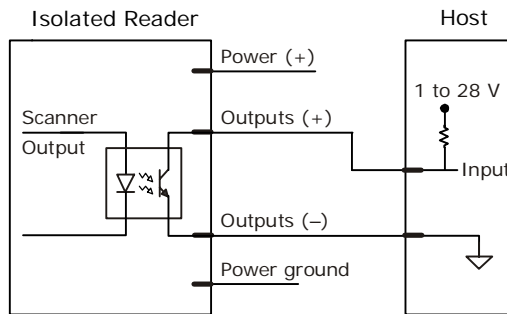

Not Optoisolated, Reader Grounded

In this diagram, power is applied externally, but the reader's power ground is used to complete the circuit. This setup involves some risk to the optoisolator if excessive voltages are applied.

Caution: The maximum current that can pass through the optoisolator is 100mA.

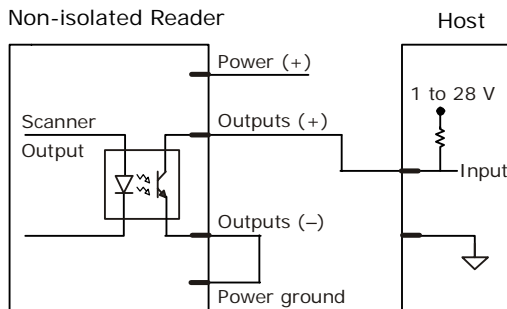

Additional Isolated Output Circuit Examples

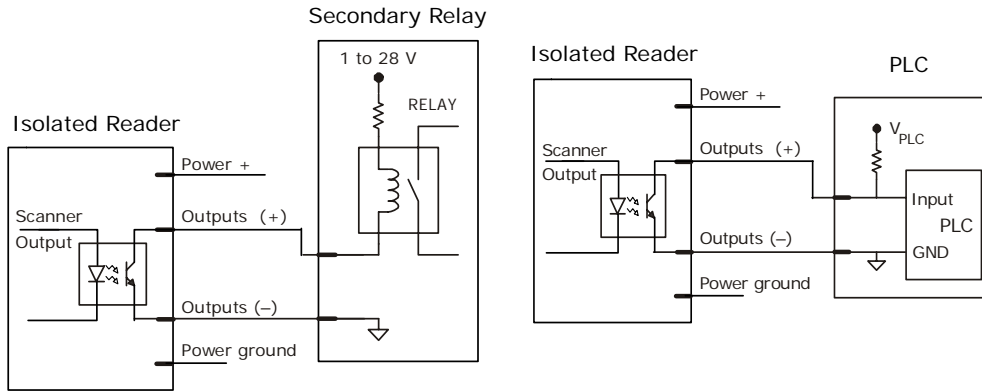

Optoisolator Inputs

All discrete inputs can be fully isolated pulses as PNP or NPN circuits. Inputs include trigger, new master, and input 1.

	Minimum	Maximum
$V_{IN-HIGH}/I_{IN-HIGH}$	10V/4mA	28V/33mA
V_{IN-LOW}/I_{IN-LOW}	0V/0mA	2V/2mA
Pulse Width _{min}	48 μ S	

Note: Trigger pulses can be sent to the reader either through the host 25-pin connector or a separate 4-pin trigger connector.

25-Pin Connector Input Examples

Fully Optoisolated

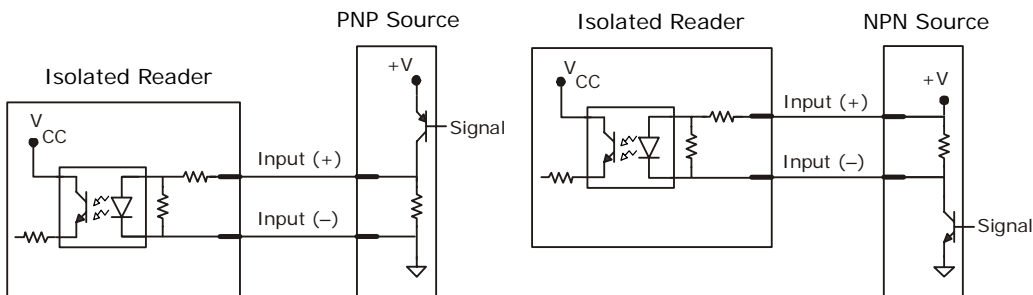

Not Optoisolated

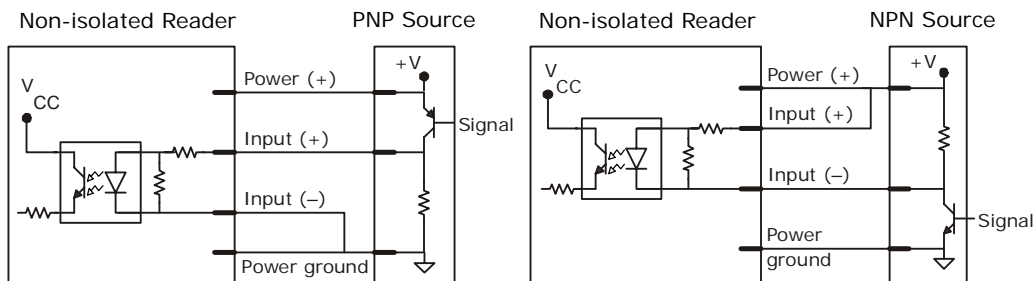

Appendix C — Serial Configuration Commands

The following table is a list of all the available serial configuration commands (also called “K commands”). These commands are also listed at the beginning of each applicable chapter.

Complete List of Serial Configuration Commands

Command Title	Format
EZ Button	
EZ Button Modes	< K771 , <i>position 1 mode[0...9],position 2 mode[0...9],position 3 mode[0...9]</i> >
EZ Button Options	< K770 , <i>global status,default on power-on</i> >
EZ Button Auto Framing	< K773 , <i>raster status,laser status</i> >
Calibration Options	
Calibration Options	< K521 , <i>raster options,video status,scan speed status,laser power status,laser framing status,symbology detect</i> >
Communications	
Host Port Connections	< K100 , <i>baud rate,parity,stop bits,data bits</i> >
Host Protocol	< K140 , <i>protocol</i> >
Auxiliary Port	< K101 , <i>aux port mode,baud rate,parity,stop bits,data bits,daisy chain status,daisy chain ID</i> >
Daisy Chain Auto Configure	< K150DAISY >
Daisy Chain Scanner ID	< K151 , <i>daisy chain scanner,daisy chain scanner ID</i> >
Auxiliary Port System Status	< K146 , <i>aux status</i> >
Preamble	< K141 , <i>status,preamble</i> >
Postamble	< K142 , <i>status,postamble</i> >
LRC	< K145 , <i>status</i> >
Response Timeout	< K143 , <i>timeout</i> >
Read Cycle	
Multisymbol	< K222 , <i>number of symbols,multisymbol separator</i> >
Trigger Mode	< K200 , <i>trigger mode,trigger filter duration</i> >
External Trigger State	< K202 , <i>external trigger state</i> >
Serial Trigger Character	< K201 , <i>serial trigger character</i> >
Start Serial Trigger Character	< K229 , <i>start trigger character</i> >
Stop Serial Trigger Character	< K230 , <i>stop trigger character</i> >
End of Read Cycle	< K220 , <i>end of read cycle mode,read cycle timeout</i> >
Decodes Before Output	< K221 , <i>number before output,decodes before output mode</i> >
Configuration Database Control	
Database Setup	< K253 , <i>index,gain,AGC mode,tracking,raster top,raster bottom,raster speed,laser framing status,laser on position,laser off position,laser power,background color</i> >
Database Operation	< K252 , <i>number of active indexes,database cycles</i> >
Database Mode	< K254 , <i>mode,count/time</i> >
Save Current to Database	< K253+ , <i>database index</i> >
Load Current from Database	< K253- , <i>database index</i> >

Complete List of Serial Configuration Commands

Reader Setup	
Tracking	<K520,tracking>
Scan Speed	<K500,scan speed>
Automatic Gain Control	<K504,gain level,AGC sampling,AGC min,AGC max>
Symbol Detect Status	<K505,symbol detect status,transition counter>
Maximum Element	<K502,maximum element>
Raster/Laser	
Raster Setup	<K506,raster status,top offset,bottom offset,raster sweep rate,read cycle on/off>
Laser Setup	<K700,laser on/off status,laser framing status,laser on position,laser off position,laser power>
Symbologies	
Code 39	<K470,status,check digit status,check digit output status,large intercharacter gap,fixed symbol length status,default symbol length,full ASCII set>
Code 128/EAN-128	<K474,status,fixed symbol length status,fixed symbol length,EAN-128 status,output format,application record separator status,application record separator character,application record brackets,application record padding>
Interleaved 2 of 5	<K472,status,check digit status,check digit output status,symbol length #1,symbol length #2,guard bar status,range mode>
Codabar	<K471,status,start & stop match status,start & stop output status,large intercharacter gap,fixed symbol length status,symbol length,check digit type,check digit output status>
UPC/EAN	<K473,UPC status,EAN status,supplementals status,separator status,separator character,supplementals type,UPC-E output as UPC-A>
Code 93	<K475,status,fixed symbol length status,fixed symbol length>
RSS Expanded	<K484,status,fixed symbol length status,fixed symbol length>
RSS Limited	<K483,status>
RSS-14	<K482,status>
Pharmacode	<K477,status,fixed bar length status,fixed bar length,min. no. of bars,bar widths,direction,fixed threshold value>
PDF417	<K476,status,[unused],fixed symbol length status,fixed symbol length,decode at end of read>
Micro PDF417	<K485,status,[unused],fixed symbol length status,fixed symbol length>
Composite	<K453,mode,separator status,separator>
Narrow Margins/Symbology ID	<K450,narrow margins status,symbology identifier>
Background Color	<K451,background color>
I-O Parameters	
Symbol Data Output	<K705,symbol data output mode,when to output>
Noread Message	<K714,status,noread message>
Bad Symbol Message	<K715,bad symbol status,bad symbol message>
No Symbol Message	<K716,no symbol status,no symbol message>
Output Indicators	<K750,green flash mode,[unused],green flash duration>
Beeper	<K702,beeper output>
Serial Verification	<K701,serial command echo status,serial command beep status,control/hex output>

Serial Configuration Commands

Complete List of Serial Configuration Commands

Input 1	<K730,input mode,active state>
Output 1	<K810,output on,active state,pulse width,output mode>
Trend Analysis (1)	<K780,trend analysis mode,trigger evaluation period,number to output on,decodes/trigger threshold>
Diagnostics (1)	<K790,over temperature,service threshold,[unused],laser current high,laser current low,low temp>
Output 2	<K811,output on,output state,pulse width,output mode>
Trend Analysis (2)	<K781,trend analysis mode,number of triggers,number to output on,decodes/trigger threshold>
Diagnostics (2)	<K791,over temperature,service threshold,unused,laser current high,laser current low,low temp>
Output 3	<K812,output on,output state,pulse width,output mode>
Trend Analysis (3)	<K782,trend analysis mode,number of triggers,number to output on,decodes/trigger threshold>
Diagnostics (3)	<K792,over temperature,service threshold,unused,laser current high,laser current low,low temp>
Quality Output	<K704,quality output separator,decodes/trigger status,decode direction status>
Database Number Output	<K759,status,separator>
Symbol Position Output	<K758,raster status,scan status,separator>
Read Duration Output	<K706,status,separator>
Matchcode	
Matchcode Type	<K223,matchcode type,sequential matching,match start position,match length,wild card character,sequence on noread,sequence on mismatch>
Sequence Step	<K228,sequence step>
New Master Pin	<K225,status>
Master Symbol Database Size	<K224,number of master symbols>
Match Replace	<K735,status,message>
Mismatch Replace	<K735,status,message>
Master Symbol Database	
Enter/Delete Master Symbol Data	<K231,master symbol number,master symbol data [no data will delete current master symbol data]>
Request Master Symbol Data	<K231,?> [for all] or <K231,master symbol number?>
Diagnostics	
Power-on/Resets Counts	<K406,?> returns: <K406,power-on,resets,power-on saves,custom default saves> (read only)
Hours Since Reset	<K407?> returns: <K407,hours,minutes>
Warning Messages	<K400,warning message status,laser high status,laser low status,novram/reset warning status>
Laser High/Laser Low	<K411,laser high status,laser high message,laser low status,laser low message>
High Temperature	<K402,high temperature status,high temperature message>
Low Temperature	<K403,low temperature status,low temperature message>

Complete List of Serial Configuration Commands

Service Message	< K409 , <i>status,service message,threshold,resolution</i> >
Output Format	
Output Format Status	< K743 , <i>output format status</i> >
Extraction Mode	< K740 , <i>output #,start position,length</i> >
Insertion Mode	< K741 , <i>output #,length,hex string</i> >
Multisymbol Output	< K742 , <i>symbol number,status</i> >
Ordered Output	< K744 , <i>filter index,symbology type,length,wildcard character,placeholder character,data,decode direction,check database number</i> >
Number of Filters	< K745 , <i>number of filters involved</i> >

Appendix D — Serial Command Format

Serial commands are of two types: utility and configuration.

Rules that apply to both utility and configuration commands

- A less than **<** and greater than **>** characters enclose the commands unless non-delimited commands are used. (See "**Trigger Mode**" on page 7-6.)
- Commands and data are "case sensitive." That is, characters must be entered as upper or lower case, as specified.

Serial Utility Commands

These are sent during operations and are not followed by **<A>** or **<Z>**.

Serial Configuration "K" Commands

These begin with a single **K** character followed by a three digit numeric, a comma, data fields separated by commas, and typically, an initializing command, as follows:

<K three digit numeric,data,data,...etc.><initializing command>¹

An initializing command of type "**A**" (not saved to non-volatile memory) or type "**Z**" (saved to non-volatile memory) may follow the command.

For example, to enable **UPC** and save the change for power-on, send: **<K473,1><Z>**.

To change **Baud Rate** and reset without saving changes for power-on, send **<K100,3><A>**.

Serial Configuration Command Conventions:

- All data fields (except the last) must be followed by a comma (without a space).
- The following characters cannot be used: **,** **<**, **>**, and **NULL**.
- All fields preceding a modified field must be included.
- If there is no change in preceding fields, then commas alone can be entered in these fields. For example, if only the last field in the following command is changing, **<K100,4,1,0,0>** can be entered as **<K100,,,0>**.
- All fields *following* a modified field can be omitted. For example, to change **Baud Rate**, send **<K100,3>**.

1. In many commands a K command will automatically be saved for power-on with the MS-860.

Concatenating Configuration Commands

Commands can be concatenated (added together) in a single string or data block.

Serial Command Status Request

To ensure that any command was received and accepted, you can send the **Show Reader Status** command: **<?>**.

The status of a specific serial command can be requested by entering the command followed by a question mark, for example **<K101?>**. To see all K commands, send a **<K?>** command.

With the MS-860, each K command is framed with a preamble and postamble and may be mixed with bar code symbol data. To prevent this, send an **<I>** command to disable scanning before sending the K request. Follow the K request with an **<H>** command to restore scanning.

Entering Special Characters in Serial Commands

To enter control characters within a serial command, hold down the control key while typing the desired character.

Entering Special Characters in Embedded Menus

Control Characters

Control characters entered on the command line are displayed in the menu as mnemonic characters, such as: **<CR><LF><NUL><NUL>**.

Press **SP** (the space bar) once, then enter the control character by holding down the control key and simultaneously pressing the desired character. For example to define a line feed, press **SP**, then **Control** and **J** simultaneously. It is displayed as **^J** on the command line and as **<LF>** in the menu when the screen is refreshed.

To Define a Carriage Return as a Character

Press **SP**, then **CR**. It is displayed as **^M** on the command line and as **<CR>** in the menu when the screen is refreshed.

To Define a Space as a Character

Press **SP** twice. It is displayed as a blank space in the menu when the screen is refreshed. While it appears that nothing has been assigned, the hex value 20 will be sent during data transmission.

To Select NUL as the Character

Press **SP**, then a **0** (zero). It is displayed as **<NUL>** in the menu when the screen is refreshed.

Appendix E — ASCII Table

ASCII Table with Control Characters

Dec	Hex	Mne	Ctrl	Dec	Hex	Ch	Dec	Hex	Ch	Dec	Hex	Ch
00	00	NUL	^@	32	20	SP	64	40	@	96	60	`
01	01	SOH	^A	33	21	!	65	41	A	97	61	a
02	02	STX	^B	34	22	"	66	42	B	98	62	b
03	03	ETX	^C	35	23	#	67	43	C	99	63	c
04	04	EOT	^D	36	24	\$	68	44	D	100	64	d
05	05	ENQ	^E	37	25	%	69	45	E	101	65	e
06	06	ACK	^F	38	26	&	70	46	F	102	66	f
07	07	BEL	^G	39	27	'	71	47	G	103	67	g
08	08	BS	^H	40	28	(72	48	H	104	68	h
09	09	HT	^I	41	29)	73	49	I	105	69	i
10	0A	LF	^J	42	2A	*	74	4A	J	106	6A	j
11	0B	VT	^K	43	2B	+	75	4B	K	107	6B	k
12	0C	FF	^L	44	2C	,	76	4C	L	108	6C	l
13	0D	CR	^M	45	2D	-	77	4D	M	109	6D	m
14	0E	SO	^N	46	2E	.	78	4E	N	110	6E	n
15	0F	SI	^O	47	2F	/	79	4F	O	111	6F	o
16	10	DLE	^P	48	30	0	80	50	P	112	70	p
17	11	DC1	^Q	49	31	1	81	51	Q	113	71	q
18	12	DC2	^R	50	32	2	82	52	R	114	72	r
19	13	DC3	^S	51	33	3	83	53	S	115	73	s
20	14	DC4	^T	52	34	4	84	54	T	116	74	t
21	15	NAK	^U	53	35	5	85	55	U	117	75	u
22	16	SYN	^V	54	36	6	86	56	V	118	76	v
23	17	ETB	^W	55	37	7	87	57	W	119	77	w
24	18	CAN	^X	56	38	8	88	58	X	120	78	x
25	19	EM	^Y	57	39	9	89	59	Y	121	79	y
26	1A	SUB	^Z	58	3A	:	90	5A	Z	122	7A	z
27	1B	ESC	^[59	3B	;	91	5B	[123	7B	{
28	1C	FS	^\	60	3C	<	92	5C	\	124	7C	
29	1D	GS]`	61	3D	=	93	5D]	125	7D	}
30	1E	RS	^^	62	3E	>	94	5E	^	126	7E	~
31	1F	US	^_	63	3F	?	95	5F	_	127	7F	D

Communication Protocol Commands

<i>Protocol Command (Mnemonic displayed on Microscan menu)</i>	<i>Control Characters (Entered in menu or serial command)</i>	<i>Hex Code</i>	<i>Effect of Command</i>
<i>RES</i>	<i>^D</i>	<i>04</i>	<i>Reset</i>
<i>REQ</i>	<i>^E</i>	<i>05</i>	<i>Request</i>
<i>EOT</i>	<i>^D</i>	<i>04</i>	<i>Reset</i>
<i>STX</i>	<i>^B</i>	<i>02</i>	<i>Start of Text</i>
<i>ETX</i>	<i>^C</i>	<i>03</i>	<i>End of Text</i>
<i>ACK</i>	<i>^F</i>	<i>06</i>	<i>Acknowledge</i>
<i>NAK</i>	<i>^U</i>	<i>15</i>	<i>Negative Acknowledge</i>
<i>XON</i>	<i>^Q</i>	<i>11</i>	<i>Begin Transmission</i>
<i>XOFF</i>	<i>^S</i>	<i>13</i>	<i>Stop Transmission</i>

Appendix F — Defaulting/Saving/Resetting

Understanding and controlling your reader's active, saved, and default settings is critical to the operation of your reader.

Software Reset/Save/Recall Commands

<A>	Reset (does not save for power-on)
<Ard>	Reset and recall Microscan defaults
<Arp>	Reset and recall power-on parameters
<Arc>	Reset and recall customer default parameters
<Z>	Save current settings for power-on
<Zc>	Save current settings as customer default parameters
<Zrd>	Recall Microscan default parameters and save for power-on
<Zrc>	Recall customer default parameters and save for power-on

Power-on Parameters

Power-on parameters (saved by the **<Z>** command) are saved to NOVRAM and recalled and loaded into current parameters when power is cycled or the **<Arp>** command is issued.

Customer Default Parameters

Customer default parameters (saved by **<Zc>** command) are the same set of parameters as power-on but are saved in a different, isolated section of NOVRAM. This can allow a user to essentially create a backup set of parameters that can be recalled in the event that the current parameters or power-on parameters have been changed and no longer desired. It is important to note that a hardware default does not affect these parameters. For example, a user that inadvertently changed communication settings in power-on parameters in such a way that they either don't know the settings or don't have the capability to communicate at those settings. By using the hardware default to default the power-on settings to the known Microscan default, the user can then recall their previously customer saved settings with the **<Arc>** or **<Zrc>** commands.

Default on Power-On

You can also use the EZ button to default the reader to customer defaults and save for power-on by holding down the EZ button while applying power to the reader, provided that this feature is enabled in "**Default on Power-on**" on page 3-7. This is the same as the **<Zrc>** command.

Microscan Default Parameters

Microscan default parameters are contained in the firmware that cannot be changed.

Software Default

Microscan default parameters can be recalled (loaded into current settings) with **<Ard>** command or recalled and saved for power-on with the **<Zrd>** command.

Hardware Default

If a software default reset is not possible, it may be necessary to reset the reader by shorting (connecting) specific pins. This procedure has the same effect as the **<Zrd>** software command.

Important: For this reset to occur, this command must be executed within 60 seconds after a power-on or a reset.

1. Apply power to the reader.
2. Locate pins 7 and 11 on the host connector.
Caution: Be certain that the correct pins are located. Connecting the wrong pins could cause serious damage to the unit.
3. Momentarily connect these wires (or pins) and listen for a series of short beeps.
4. Within 3 seconds, connect them again. A longer beep should be heard. If not, repeat the process.

Default/Reset Definitions

Defaults are original or saved customer settings that can be recalled, either by software reset **<Zrd>** or hardware reset.

Also when in multidrop, defaulting might be required if the reader has been assigned a polling address and you wish to access the reader's menu.

Defaulting the reader by **<Zrd>** resets the configuration parameters to Microscan default values. Defaulting might be necessary if you have made temporary changes, communications between the reader and another device are lost or interrupted, or you are using incompatible equipment (for example, a terminal that is set at 38.4K baud communicating with a reader that is set at 115.2K baud).¹

Resets ("**A**" commands) affect only the current settings (active memory) and are not saved for power on or recall.

Active Memory is where the reader's active settings are stored during use. These are not available on power-on unless saved by a "**Z**" command.

1. There are no menu options or host commands for resetting the configuration program.

Appendix G — Symbol Configuration

You can configure your reader by presenting Code 128 symbols that the MS-860 reader responds to as serial commands.

Note: Your reader does not need to be enabled for Code 128 in order to enter symbol configuration.

Entering Symbol Configuration

The symbol used to enter configuration is the 7-character code 128 symbol shown below. It is not required that the reader be configured to read code 128 symbols to read this start symbol or the following configuration symbols.

To setup for symbol configuration:

1. Put the reader in a read cycle mode.
2. Place a special Code 128 configuration start symbol in the readers field of view.
Use this symbol or one that you have created yourself.



If the reader is able to read the start symbol, it will begin to beep and the performance LEDs will be activated.

3. When the reader starts to beep, remove the configuration symbol from the reader's field of view.

The beeping will end and the reader will be in the configuration mode.

During the configuration mode the LEDs will emit a side to side "Knight Rider" pattern to let you know you are currently ready to configure.

You can create your own start symbol by encoding the following in Code 128:

FNC4 <_CFG>.

Using Configuration Symbols

Once in symbol configuration mode, serial command data encoded in Code 128 symbols is read by the reader as serial input.

Configuration symbols must meet the following conditions:

1. The only valid configuration symbols are Code 128.
2. Symbol data may contain more than one command, but individual symbols must be presented one at a time. This is because only the first symbol in a read cycle record will be used as a possible configuration symbol. A symbol that is presented to the reader must be read 25 times consecutively to be used as a valid symbol. Once this is done the reader will interpret the symbol data in the same fashion as it interprets serial data.
3. Any valid command may be entered via symbols including operational commands. Because the data is treated like serial input multiple symbols may be used to represent one command as long as the symbols are presented individually and in the correct order.
4. Read rate command may also be used to enter read rate from symbol configuration mode.
5. When in read rate, the reader will read the symbologies that were enabled prior to entering the configuration mode. However it will read a "**<J>**" in code 128 regardless of current enable/disable state of code 128.

Once the **<J>** is issued the reader exit both read rate and symbol configuration. To exit read rate and remain in symbol configuration, you present the start symbol once again. Symbols read in read rate will not configure the reader.

To start a read rate test, scan this symbol:



Exiting Symbol Configuration

There are multiple ways of exiting symbol configuration. The first way is to simply read or serially enter the "**<J>**" command. Other ways include any command that executes a software reset. These commands include the save family as well as the reset family e.g. **<Z>**, **<Zc>**, **<Zrd>**, **<Zrc>**, **<A>**, **<Arc>** and **<Ard>**. When exiting symbol configuration with the symbol "**<J>**," the reader will beep in response.

To end the read rate test and the symbol configuration program, scan this symbol:



This will terminate symbol configuration mode. Changes made in configuration will remain in effect just as would changes made in the menus or by serial commands.

Appendix H — Formulas for Number of Decodes

To ensure reliable scanning, apply a minimum of *five* decodes to each symbol. Use the formulas below to calculate the number of decodes that your symbol will receive.

If the number of decodes you derive from one of these calculations is less than the minimum for your application, plug in the minimum number of decodes (5) and solve for another parameter that might be changed, such as scan speed or scans per second.

Note: While the formulas given here solve for the predicted number of decodes, you may also use the formulas to solve for other parameters that might be changed, such as scan speed, symbol length, etc.

Single Line Ladder Calculation

For single scan line ladder scanning, use the following formula:

$$\left(\frac{SH}{SS} \times DR\right) - 3 = ND \text{ (number of decodes)}^1$$

SH (Symbol Height) (ladder formula only) is a measurement of the height of individual bars.

SS (Scan Speed) is the distance per second that a symbol moves through the scan.

DR (Decode Rate) is the number of decodes per second that a given symbol receives (as derived from a stationary scan test).

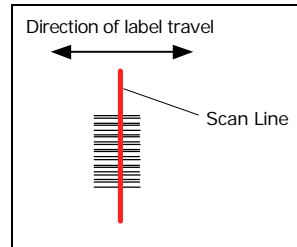

Ladder

Single Scan Line Picket Fence Calculation

For single scan line picket fence scanning use the following formula:

$$\left(\frac{(SW - SL)}{SS} \times DR\right) - 3 = \text{number of complete decodes}$$

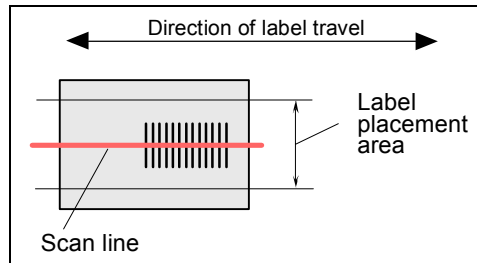

Picket Fence

1. The -3 component in the formula is included to allow for AGC acquisition, an incomplete first scan, and an incomplete last scan. This applies only if the number inside the parentheses equals 4 or more. If the number equals 3, then only subtract 2 to derive 1 good scan.

Raster Picket Fence Calculation

For raster picket fence scanning, the number of decodes (ND) that can be applied to a given symbol can be calculated once the sweep rate (SR) is known.

Sweep Rate (SR)

Sweep rate is the number of raster sweeps (up or down) that occur per second and can be set in **ESP**. Since the sweep rate cannot exceed 30 you first need to ensure that your application can achieve this by solving for sweep rate. The sweep rate should generally be set as low as possible in order to maximize the number of scans on a given symbol.

The formula for determining **Sweep Rate** (SR) is as follows:¹

$$SR = \frac{2 \times SS}{(SW - SL)}$$

SR = Sweep Rate, the number of passes, up or down, that are described by the arc of the raster mirror.

SS = Scan Speed, the distance per second that a symbol moves through the scan.

SW = Scan Width, the width across the scan beam, at a given distance from the reader, in which a symbol can be read (picket fence formula only).

SL = Symbol Length, the length of the longest printed symbol to be read plus the length of the quiet zones (picket fence formula only).

Example:

$$SW = 5$$

$$SS = 2 \text{ inches per second}$$

$$SL = 1$$

$$SR = \frac{2 \times 2}{(5 - 1)} = 1$$

Important: The maximum sweep rate that your can set the reader to is 80. If your solution is greater than 80, you must change another parameter such as scan speed, etc. and recalculate.

Since SR can only be entered into the software as whole numbers, round off fractions of SR to the next higher number, for example enter 0.4 as 1 and 3.5 as 4.

In setting up the reader, raster height depends on the raster arc and the symbol distance (range) from the reader. Both the top offset and bottom offsets can be adjusted independently in 255 increments and the resulting arc can vary from 0° to 30°. (See Chapter 8, "**Raster/Laser**".)

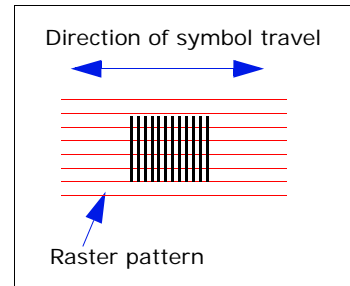

Raster
Picket Fence

1. The number 2 in the SR formula ensures that each symbol receives two full raster sweeps.

Angled Picket Fence Calculation

The number of complete scans for angled picket fence is calculated the same as that for picket fence, with the exception that the scan width is shortened in proportion to scan tilt.

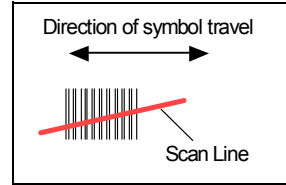

Angled Picket Fence

Improving the Number of Decodes

After changing any of the parameters described in this section, recalculate the number of decodes.

Scan Speed

Scan speed is a function of motor speed and is adjustable. A slower scan speed may allow greater symbol range and/or higher decode rates, but at the cost of fewer scans per symbol. Applies to both picket fence and ladder oriented symbols. If your application allows it, slowing scan speed (the time in seconds that a symbol is fully within the scan width of the reader) is an effective way to increase the number of decodes.

Range

Adjusting the symbol's range, if possible, is one of the quickest and most effective ways to improve decode rates. However, in some applications you may need to select a less than optimum range, or one that is beyond the fringes of the ranges.

Scan Width

Increasing scan width will increase the number of scans in a picket fence oriented application. Scan width is linked with scan range and changing one will usually require a change in the other.

Symbol Dimensions, Symbol Density, and Symbol Ratio

Not usually an option in most applications, but changes to symbol parameters can affect number of decodes calculations and possibly decode rates.

If your application allows it, shortening the length of a picket fence symbol means the symbol will be in the scan range longer and hence receive a greater number of scans. Increasing the height of a ladder symbol means it will receive more scans. Changing symbol density and/or symbol ratio is another way ranges, decode rates, etc. can be altered.

Appendix I — Operational Tips

Do:

- Check inputs (scan speed, length, height, etc.) to ensure the desired number of decodes per symbol.
- Connect reader to host before connecting power to the reader; disconnect power before disconnecting the host from the reader.
- For optimum decodes, mount reader so that your symbols pass through the center of the depth-of-field (minimum/maximum range). You find the center by moving your symbol in and out during a read rate test.
- Avoid excessive tilt, pitch, and skew of the symbol.
- Check the symbol for readability by doing a decode rate test. If there is any question about the symbol's readability, contact your Microscan representative at helpdesk@microscan.com.
- After changing any parameter that might affect decode rate, repeat decode rate test.
- Clean the reader window with a clean, dry Q-tip or cotton cloth on a regular basis.

Do Not:

- Aim the reader into direct light or sunlight.
- Aim the reader into an external object detector or other light-emitting device.
- Obstruct the reader window with mounting hardware or other objects.
- Connect chassis of reader and host to different ground potentials.
- Operate the reader in excessive temperature environments.

Appendix J — Embedded Menus

In addition to **ESP**, you can also use a communications menu such as Microsoft's HyperTerminal™ to establish communication with Microscan's embedded menus.¹ Because of size/space limitations of embedded menus, their structures and terms may not precisely match those of **ESP** or this manual.

1. With your host connected to MS-860, set your host communications settings as follows: **9600** baud, **7** Data Bits, **1** Stop Bits, and **None** Parity.
2. Set **Flow Control** to **None**.
3. Make the communications port selection. (Usually **COM 1** for Windows.)

Upon connection, send a **<D>** command to bring up the main menu.

MAIN MENU 35-338601	
TOPICS	DESCRIPTION
1) COMMUNICATIONS	HOST PROTOCOL & HOST/AUX PORT CONFIG
2) READ CYCLE	TRIGGERING, TIMEOUTS, ETC.
3) SYMBOLOGY 1 AND CODE PARAM	SYMBOLOGIES AND GLOBAL CODE PARAMETERS
4) SYMBOLOGY 2	MORE SYMBOLOGIES
5) SYMBOLOGY 3	MORE SYMBOLOGIES
6) I/O CONDITION	DISCRETE I/O
7) SCANNER OUTPUT	DATA MESSAGES, BEEPER, etc.
8) OUTPUT FILTERING	OUTPUT FILTERING
9) DATABASE SETUP	CONFIGURATION DATABASE
10) SCANNER SETUP	AGC, RASTER, LASER FRAMING, BUTTON, ETC.
11) DIAGNOSTICS	WARNING MESSAGES, SERVICE TIME, ETC.

ESC = MAIN MENU OR EXIT	N = NEXT ITEM
M = PREVIOUS MENU	SP = NEXT ITEM
B = PREVIOUS ITEM	CR = THIS ITEM

MAIN--> COMMUNICATIONS

Menu navigation commands are case sensitive. Use the space bar or **N** to advance to the next item, **CR** (return key) to select a highlighted item, **B** to return to the previous item, **M** to return to the previous menu, and **ESC** to return to the Main menu or to exit the program. When exiting the program, you will be prompted to save your active settings for power up (**Y** or **N**). Typing **Y** will be equivalent to saving with a **<Z>** command.

1. If you are using Microsoft's HyperTerminal program, you may find that the initial screen is not visible when you call up the program with the **<D>** command. If this occurs, exit the embedded menu with a **ESC**, **E**, and **N** sequence and repeat the **<D>** command.

Appendix K — Interface Standards

Interface Standards, established by the Electronic Industries Association (EIA), specify such things as the signaling voltage levels, maximum cable lengths, and number of drivers. With Microscan devices, selection of interface is made by pin assignment and, in the case of the host communications, by software switching between RS232 and RS422. Microscan devices use RS232, RS422, and RS485 multidrop.

RS232

RS232 defines an interface between two devices, such as the reader and host. It differs from the other interfaces by dedicating individual pins to specific functions and by requiring both devices to share a common ground line. Since both device chassis are connected to a common ground, a ground loop potential and the possibility of noise interference exists; therefore, cable lengths are limited to a maximum of 50 feet (19.7m). Despite being the most limited, this interface is used frequently because of the large installed base of RS232 equipment.

RS422

RS422, unlike RS232, measures signals differentially; that is, the receiver looks at the potentials between the two receive (or transmit) wires rather than the potential between signal and ground. As a result, cables, if shielded, can be up to 4000 feet (1219m) in length. Like RS232, RS422 communication is designed for only two devices on a single line and must have a common ground. It can be used wherever RS232 is used.

RS485

RS485, like RS422, can transmit up to 4000 feet (1219 m) using differential voltages, but unlike RS422, its transmitters are turned off until a request for data is received from the host. RS485 is used exclusively in multidrop protocol.

USB

The Universal Serial Bus can connect up to 127 devices to a host at a maximum of 6 megabits per second (Mbps) of bandwidth.

Appendix L — Multidrop Communications

This appendix describes the rules for setting up a concentrator or controller to communicate with a reader in standard Multidrop protocol.

The diagram to the right shows a typical Multidrop network in which 1 to 50 readers can communicate with a host via an intermediary device, a concentrator or a controller.

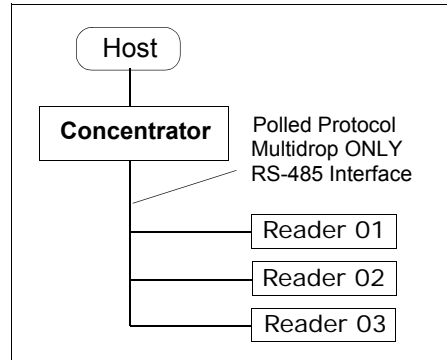

Configure Your Reader for Multidrop

1. With the reader connected to the host, **Retrieve Reader Settings**.
2. Select **Multidrop** in the **Protocol** configuration menu.
You will see the following message:
Important: *You must change your preamble and postamble characters so that they are not CR or NULL.*
This allows data to move through the concentrator without interference.
3. Click **OK**.
4. Next, go to **Preamble Characters** (still in the **Protocol** menu) and double-click on **Characters**.
5. This will open up an ASCII character table. Select any character other than **CR**. For example, select **LF**.
6. Repeat the above for **Postamble**.
7. Check the multidrop address. Enter a number from **01** to **50**.
8. Right-click in the window and select **Save to Reader** and **Send and Save**.
9. Your reader is now in multidrop. From here on, you will need to use the concentrator to relay commands and data between the reader or readers and the host.
10. Next, go to **"Connect to Reader via the Concentrator"** on the next page.

Connect to Reader via the Concentrator

You will need a multidrop concentrator and the required power supplies and cabling to communicate with your reader(s).

1. From the **Communications** drop down menu, select **Configure Multidrop** to bring up the **Multidrop Settings** dialog.

2. If necessary, change the default address to match the address of your multidropped reader and click **OK**.

If the host serial port is not connected in **ESP**, you will see the following popup message:

ESP is not currently connected to the multidrop concentrator. Do you wish to establish a connection now?

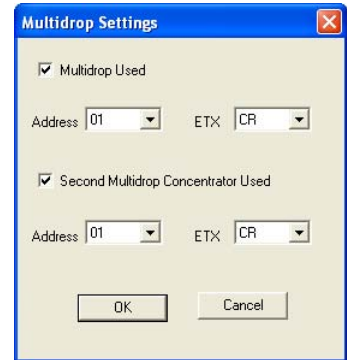

3. Click **Yes**.

You will see a **Serial Communication Parameters** dialog.

Notice that the **Force Connection** option is checked. Do not change this.

4. Select the concentrator's host port communications settings.

When you click **Connect**, you will be connecting to your concentrator, which can then relay commands to the reader whose address was set in the **Multidrop Settings** dialog.

5. Click **Connect**.

6. You should see the **CONNECTED** message in green at the bottom of the window along with the reader's **Multidrop** address.

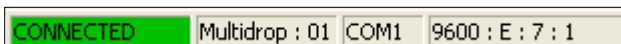

7. Click **Retrieve Reader Settings** to upload reader's configuration. If upload fails, return to the **Serial Communication Parameters** dialog and make the necessary corrections.
8. Follow the same procedure for connecting other readers to your multidrop network.

Note: For more information, see your reader user's manual or Microscan's *MS-5000 Multidrop Concentrator User's Manual, 83-005000*.

Polling Sequence

Data that is transmitted to the host (symbol data, noread messages, counters, etc.) via concentrators is solicited by poll requests from the host.

The polling sequence example is by poll address 1E (ASCII hex value for Reader 02) and a REQ (request). The reader responds by first transmitting its own address, 1E, followed by a STX (start of text) character, and then the data. Next it transmits an ETX (end of text) character and an LRC (longitudinal redundancy check) character.

If the concentrator (or controller) receives the data from the reader and is able to validate it with an LRC calculation, it responds with an ACK (acknowledgment). If the reader in turn receives the ACK, the reader ends this exchange with a RES (reset).

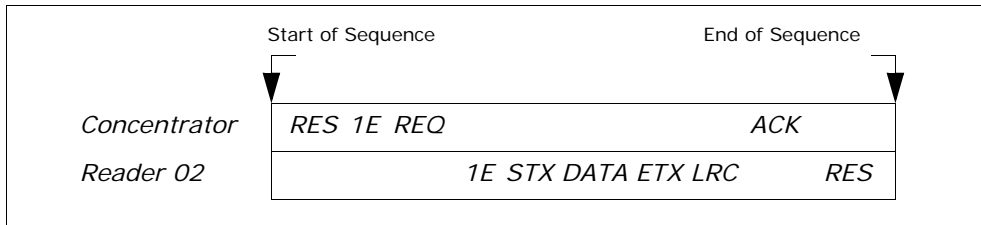

Polling Sequence

Polling Reset

- If the reader has no information, it responds to a poll request by transmitting a RES (reset).
- If the reader receives a NAK instead of the ACK after transmitting its data string, it will re-attempt to send the data string up to three times. If the reader still does not receive an ACK, it will send a RES (reset) and discard the data in its buffers.
- If the reader transmits data to the concentrator and the concentrator responds with an ACK or NAK, but the reader doesn't receive the concentrator's response, the reader will timeout and send a REQ to the concentrator and request another response. If after three retries (the number of times it transmits a REQ to the concentrator) the reader receives no response, it ends the transmission with a RES (reset).

Select Sequence

Unlike poll requests, select commands always originate from the host and consist of serial configuration or operation commands to devices that are configured in Multidrop. The reader complies with the command when it is polled during the cycle.

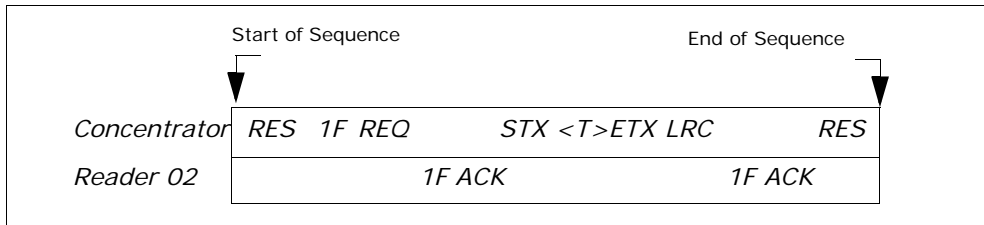

Polling Sequence

A RES (reset) is the first command in the select sequence. The 1F hex is the select address associated with Reader 02 address. It is followed by a REQ (request). The reader responds with its own select address, 1F hex, and an ACK (acknowledge). The concentrator then transmits an STX (start of text), the data (in this case a <T>), an ETX (end of text), and an LRC character.

The reader replies by transmitting its own address, followed by an ACK, acknowledging receipt of the command. Upon receipt of an ACK, the concentrator concludes the successful exchange with a RES.

In the example above, the reader only acknowledges a trigger counter request from the concentrator. It does not respond to the trigger counter request until a subsequent poll. For example, if the reader's trigger count was 12 at the time the trigger counter request was received, on a subsequent poll it would send 02T/00012. (The 02 at the beginning of the string is the reader's address.)

Select Reset

If the reader receives bad data from the concentrator, it transmits a SEL (its select address) and a NAK to the concentrator. The concentrator re-transmits the data up to three times. The concentrator will end the sequence with a RES (reset) if no ACK is received.

Multidrop Addresses

Multidrop Address	Poll Character		Select Character		Multidrop Address	Poll Character		Select Character	
	ASCII	HEX	ASCII	HEX		ASCII	HEX	ASCII	HEX
01	^\ 	1C	^] 	1D	26	N	4E	O	4F
02	^^ 	1E	^- 	1F	27	P	50	Q	51
03	SP 	20	! 	21	28	R	52	S	53
04	" 	22	# 	23	29	T	54	U	55
05	\$ 	24	% 	25	30	V	56	W	57
06	& 	26	' 	27	31	X	58	Y	59
07	(28) 	29	32	Z	5A	[5B
08	* 	2A	+ 	2B	33	\	5C]	5D
09	, 	2C	- 	2D	34	^	5E	_	5F
10	. 	2E	/ 	2F	35	`	60	a	61
11	0 	30	1 	31	36	b	62	c	63
12	2 	32	3 	33	37	d	64	e	65
13	4 	34	5 	35	38	f	66	g	67
14	6 	36	7 	37	39	h	68	i	69
15	8 	38	9 	39	40	j	6A	k	6B
16	: 	3A	; 	3B	41	l	6C	m	6D
17	< 	3C	= 	3D	42	n	6E	o	6F
18	> 	3E	? 	3F	43	p	70	q	71
19	@ 	40	A 	41	44	r	72	s	73
20	B 	42	C 	43	45	t	74	u	75
21	D 	44	E 	45	46	v	76	w	77
22	F 	46	G 	47	47	x	78	y	79
23	H 	48	I 	49	48	z	7A	{	7B
24	J 	4A	K 	4B	49		7C	}	7D
25	L 	4C	M 	4D	50	~	7E	D	7F

Appendix M — Glossary of Terms

Analog Gain Adjustment (AGC). Adjustment to signal strength that seeks to maintain a constant level regardless of the range of the symbol.

Application Record. A variation of UCC/EAN-128 which adds an application identifier to symbol data, including user-definable separators, brackets, and padding.

Autodiscriminate. The ability to decode several different symbologies without changing configuration.

Auxiliary Port. Provides RS-232 connections to an auxiliary terminal or device for remote viewing, for the transfer of data to and from the host, and under certain conditions as a configuration port.

Bar Code. The medium or label on which a symbol is printed or etched.

Bar Code Data. The information that is transmitted from a decoded bar code symbol.

Baud Rate. The number of discrete signal events per second. Bits per second.

Calibration. A routine that cycles through various optical settings and selects the combination that produce the best read rate.

Check Digit. A Modulus 43 or Modulus 10 digit that is added to the symbol message for additional data integrity.

Configuration. A setup or process of changing a reader's settings to conform to a specific application. A physical arrangement of components.

Concentrator. Intermediary device that relays data from readers to a host and commands from the host to the reader or other devices.

Connector. Physical device (plug or socket) on a device or cable to provide in/out connectivity for various circuits and pins.

Counter. Memory space provided to keep track of reader events.

Daisy Chain. Linkage of master and secondary readers to allow data to be relayed up to the host via auxiliary port connections.

Decode. A good read. The successful scanning and decoding of the information encoded in symbol.

Default. (verb) Restore Microscan or customer default settings, initialize serial commands and reset all counters.

Defaults. (noun) The settings that are restored whenever a default takes place.

Delimited. A command or field that is bracketed by pre-defined characters.

Decode Rate (DR) The number of decodes per second that a given reader is capable of receiving.

Depth of Field. The distance between the minimum and maximum range in which symbols have been read.

Discrete I/O. Inputs and outputs characterized by discrete signal transitions from one voltage level to another so that digital switching can occur.

Dynamic Setup. Testing and configuration done with symbols in motion.

EPROM. Erasable, programmable, read only memory.

Glossary of Terms

Embedded Memory. Onboard memory device such as EPROM or flash.

End of Read Cycle. The time or condition at which the reader stops expecting symbol information to decode.

Edge. Allows a read cycle to be initiated by a trigger signal from an object detector when it detects the appearance of an object (rising edge). The read cycle ends with a good read, a timeout, or a new trigger.

ESP. Easy Setup Program. A portable proprietary Windows/NT based program developed by Microscan Systems, Inc.

Falling Edge. A change of state (to inactive) associated with a level trigger in which the reader stops searching for symbols. (See **Rising Edge**.)

Fixed Code Length. Increases data integrity by ensuring that only one symbol length will be accepted.

Flash Memory. Memory that can be changed by downloading new code and recalled on power-on.

Focal Length. The distance measured from the reader to the center of the depth of field, or *focal* point.

Focus. The point at which the tip of the scan beam is at its narrowest.

Full Duplex. Auxiliary port data is sent directly to the host but not displayed on the auxiliary port screen.

Gain. Optimal signal strength.

Good Match. The event occurring when a scanned symbol matches the master symbol information that is stored in the memory of the device.

Good Read. A decode. The successful scanning and decoding of the information encoded in a symbol.

Half Duplex. Auxiliary port data is sent directly to the host and displayed on the auxiliary port screen.

Host. A computer, PLC, or other device that is used to execute commands and process data and discrete signals.

Host Port. The pins or connections on a reader or other device that physically connect with a host and—using the RS-232, RS-422, or RS-485 standards—pass data and serial commands from one device to another.

Initialize. Implement serial configuration commands into the reader's active memory.

Input. A channel or communications line. Decoded data or a discrete signal that is received by a device. See Output.

Intercharacter Delay. The time interval in milliseconds between individual characters transmitted from the reader to the host.

Intercharacter Gap. The extra space between the last element of one character and the first element of the adjacent character of a specific bar code symbol.

Ladder Symbol Orientation. A bar code symbol in which the bars are parallel to the symbol's direction of travel.

Large Intercharacter Gap. Allows the reader to read symbols with gaps between symbol characters that exceed three times (3x) the narrow element width.

Laser Framing. Setting scan width size by adjusting the on/off duration of the laser beam.

Laser On/Off. When enabled, the laser is ON only during the read cycle, provided the reader is enabled for a Serial or External trigger.

LED. Light emitting diode.

Level. The condition in which a read cycle initiated by a trigger signal from an object detector remains active and ends when the object moves out of the detector's range.

Longitudinal Redundancy Check (LRC). An error-checking routine that verifies the accuracy of transmissions.

Master Symbol. A symbol or symbol data that is stored in a reader or reader's memory and is compared with subsequently read symbols.

Master Reader. First reader in a daisy chain mode and linked directly to the host and in tandem to secondary readers.

Matchcode. The ability to compare symbol data being scanned against a master symbol that is stored in the memory of the reader.

Embedded Menu. Configuration options embedded in the reader's erasable memory.

ESP Menu. Easy Setup Program. Configuration program that runs in Windows-based operating systems 95 and above.

Mil. One thousandths of an inch or 0.0254 mm. In bar-coding, a measurement standard that identifies a symbol by the width of its narrowest element.

Mismatch. An event that occurs when the scanned symbol does not match the master symbol that is stored in the memory of the reader.

Multisymbol. A reader mode which allows a reader to read more than one symbol in a single read cycle.

Multidrop. A communications protocol for networking two or more readers or other devices with a concentrator (or controller) and characterized by the use of individual device addresses and the RS-485 standard.

Narrow-bar-width. The width of the narrowest bar of a specific bar code symbol, expressed in thousands of an inch (or mils) as defined by standard code types.

Narrow Margins. Allows the reader to read symbols with quiet zones less than 8 times the width of the narrow bar element.

Non-delimited. A command that is not bracketed by pre-defined characters.

Noread. A non-read. A condition that occurs when the reader is set up to decode symbols but no symbol is scanned during the read cycle.

Normally Closed. A discrete output state that is only active when open.

Normally Open. A discrete output state that is only active when closed.

NOVRAM. Non-volatile random access memory. Data that is "saved for power-on" is saved to NOVRAM.

Null. Also spelled "Nul." A non-printed ASCII character that acts as a space-holder.

Number of Decodes. The number of times a symbol is scanned by the reader during one pass through the laser beam.

Object Detector. A photo electric device used to sense the presence or absence of an object (also referred to as a package detector).

Glossary of Terms

Output. A channel or communications line. Data or discrete signals that are transmitted or displayed by a device.

Output Format. The modification of data output according to a user-defined index of **Extraction** and **Insertion** commands.

Parity. An error detection routine in which one data bit in each character is set to 1 or 0 (zero) so that the total number of 1 bits in the data field is even or odd.

Picket Fence Symbol Orientation. A bar code symbol in which the bars are perpendicular to the symbol's direction of travel.

Pitch. Symbol (or reader) rotation around the center of a line parallel to the scan beam.

Point-to-Point. A protocol consisting of a single communications event, typically used to connect a bar code reader to a terminal or host computer.

Port. Logical circuit for data entry and exit. (One or more ports may be included within a single connector.)

Protocol. The rules for communication between devices, providing a means to control the orderly flow of information between linked devices.

Quiet Zones. Specified "clear" (non printed) areas immediately before and after the bar code symbol. The area is usually white (for black and white symbol) and at least 10 times the width of the narrowest bar, as measured in thousands of an inch. The zones can be other than white as long as their densities remain consistent and they have the required contrast relative to the bars.

RAM. (Random Access Memory) Memory that is lost after power is recycled to the unit.

Raster. Multiple, stacked scans produced by a separate oscillating mirror or by a spinning mirror with varying facet angles.

Read Cycle. A programmed period of time or condition during which the reader will accept symbol input.

Reader. (1) A reader, a bar code device that can read and decode symbols.
(2) A device that reads and decodes 2D matrix codes.

Read Range. The distances in which a symbol can be reliably read, as measured from the front of the reader. See "Depth of Field."

Reed-Solomon Error Correction Code. A linear, error correcting block code, suited to the correction of character errors which could be, in bar or matrix codes, the obliteration or removal of part of the symbol.

Read Range. The distances in which a symbol can be reliably read, as measured from the front of the reader. See "Depth of Field."

Relay. An electrical switch that allows a low power to control a higher one.

Reset. Sets all counters to zero.

Rising Edge. A change of state (to active) that initiates (and in some cases ends) a read cycle with a new trigger, an edge trigger, or the leading edge of a level trigger. (See Falling Edge.)

ROM. (Read Only Memory) Memory that cannot be changed.

Reader. A scanning device that is comprised of a scan head and a decoder integrated in one package.

Scan Speed. The number of laser scan lines per second that a reader projects from the spinning mirror.

Scan Width (SW) is the width across the scan beam at a given distance from the reader in which a symbol can be read.

Send. Transmit data from one device to another.

Separator. A character that separates data fields.

Serial Commands. Online data strings such as **<D>** or **<P>** sent from a host or auxiliary terminal to a reader or other device.

Serial Configuration (Host Configuration). Serial commands that change configuration; distinguished from operational command by the fact that they can modify non-volatile memory for power-on configuration.

Skew. Symbol (or reader) rotation around the center of the skew axis which is perpendicular to the plane of the scan beam.

Secondary Reader. A reader linked to the master or preceding reader in a daisy chain which relays symbol data to the host. See "Daisy Chain."

Specular Reflection. The direct, mirror-like reflection of light back to the source causing saturation and bad reads.

Supplemental. A character or data string that is appended to the main bar code symbol.

Symbol. A one or two dimensional decodable pattern that can be recognized and decoded by a bar code reader or 2D reader.

Symbology. A code type, such as Code 39 or Code 128, with special rules to define the widths and positions of bars and spaces to represent specific numeric or alphanumeric information.

Symbol Density. Symbol size as measured by the narrow bar width.

Symbol Height. (SH) Regardless of orientation, the measurement taken along the length of a symbol's individual bars.

Symbol Length. (SL) Regardless of orientation, the measurement taken across the symbol's bars from one end to the other, including the quiet zone.

Symbol Transitions. The transition of bars and spaces on a symbol, used to detect the presence of a symbol on an object.

Tilt. Symbol (or reader) rotation around the centerline of the scan beam.

Timeout. The termination of a read cycle or other routine by time.

Timeout Duration. The actual time that elapses during a read cycle or other timed routine.

Tracking. Adjustment of the precision of analog-to-digital conversion.

Transmit. Send or convey signals or information from one device to another.

Transparent. Data that passed between the auxiliary port and the host with keyed data echoed to the auxiliary port

Trigger. A signal, transition, or character string that initiates a read cycle.

Watchdog Timer. A security device that detects system crashes and attempts to reset the reader.

Watchdog Reset. A reset that is forced whenever the software locks up.

Wild Card. User-defined character entered into a master symbol to permit matches with variable characters.

Index

A

About the MS-860 Industrial Raster Reader i-viii
Active closed 7-11
Active Memory A-17
Active open 7-11
Active State 10-15
Add Exceptions 2-14
Additional Isolated Output Circuit A-6
Advanced Options 2-14
AGC Maximum Gain 7-20
AGC Minimum Gain 7-20
AGC Mode 7-19
AGC Sampling Mode 7-19
Angled Picket Fence Calculation A-22
App Mode button 1-9, 2-12
Appendices i-vi, A-1
Application Mode 2-3
Application Record
EAN-128 9-8
Application Record Brackets 9-9
Application Record Padding 9-10
Application Record Separator Character 9-9
Application Record Separator Status 9-9
Approvals Pending i-ix
As Is 4-6
As Soon As Possible 10-6
ASCII Table with Control Characters A-14
Auto Frame 3-5
Autoconnect 1-1, 1-5, 2-9
Autodiscriminate 9-1, 9-31
Autodiscrimination 1-8
Automatic Adjustment 8-7
Automatic Gain Control (AGC) 7-19
Aux Port Connections 6-8
Aux Port Mode 6-9
Auxiliary Port System Data 6-1, 6-18
Auxiliary Port System Status 6-18

B

- Background Color 9-1, 9-31
- Bad Symbol Message 10-1, 10-8
- Bad Symbol Status 10-8
- Bar Code Options tab 2-8
- Bar Width Status 9-25
- Barcode Dialog 2-11
- Baud Rate
 - aux port 6-8
 - Baud Rate, Aux Port 6-8
 - Baud Rate, Host Port 6-3
- Beeper Output Condition 10-11
- Bottom Offset 8-4

C

- Calibrate 2-2
- Calibrate the Reader 1-1, 1-8
- Calibrating a Symbol 4-1, 4-4
- Calibration i-iii, 3-5, 4-1
- Calibration by ESP 4-1, 4-2
- Calibration by Serial Command 4-1, 4-2
- Calibration Dialog 4-1, 4-5
- Calibration Methods 4-3
- Calibration Options 4-1, 4-6
- Calibration Overview 4-1, 4-3
- Caution A-4
- Check Digit Output 9-4
- Check Digit Output Status 9-11, 9-16
- Check Digit Status 9-4, 9-11
- Check Digit Type 9-16
- Check Index 13-14
- Codabar 9-14
- Codabar Status 9-14
- Code 128 Status 9-7
- Code 128/EAN 9-7
- Code 39 9-4
- Code 39 Status 9-4
- Code 93 9-20
- Code 93 Status 9-20
- Command Conventions A-12
- Communication Protocol Commands A-15
- Communications i-iv, 6-1, A-2
 - by Serial Command A-8

Communications by ESP 6-1, 6-2
Communications by Serial Command 6-1, 6-2
Composite 9-28
Concatenating Commands A-13
Configuration
by Serial Command 5-2
Configuration by ESP 5-2
Configuration Database i-iii, 4-3, 5-1
Configuration Database Window 5-6
Configure for Multidrop A-26
Configure Multidrop 2-9, A-27
Configure the Reader 1-1, 1-9
Connect 2-9
Connect Menu 2-9
Connect the System 1-1, 1-2
Connect via the Concentrator A-27
Connectors on MS-860 1-2
Continuous 7-19
Continuous Read 7-6
Continuous Read 1 Output 7-7
Control Characters A-13
Control/Hex Output 10-13
Count/Time 5-5
Counter by ESP 15-4
Counters 15-1, 15-4
Counters by Serial Command 15-5
Counts 12-1, 12-4
Customer Default Parameters A-16
Customer Default Saves 12-5

D

Daisy Chain Autoconfigure 6-16
Daisy Chain ID 6-15
Daisy Chain ID Status 6-15
Daisy Chain Mode 6-13
Daisy Chain Reader ID 6-17
Daisy Chain Reader Number 6-17
Daisy Chain Remote Secondary ID 6-17
Data 13-14
Data Bits, Aux Port 6-9
Data Bits, Host Port 6-4
Data initiated from the Auxiliary Port 6-10, 6-11, 6-12
Data initiated from the Host 6-10, 6-11, 6-12
Data initiated from the Reader 6-10, 6-11, 6-12
Database Cycles 5-4

Database Mode 5-5
Database Number Output 10-1, 10-26
Decode at End of Read 9-26
Decode Direction 13-14
Decode Direction Output 10-25
Decode Rate A-20
Decodes Before Output 7-1, 7-16
Decodes Before Output Mode 7-16
Decodes per Trigger 10-20
Decodes/Trigger Status 10-25
Default on Power-On A-16
Default on Power-on 3-7
Default/Reset Definitions A-17
Defaulting 2-14, A-16
Defaulting/Saving/Resetting 15-1, 15-16
Defaults 3-3
Define a Carriage Return as a Character A-13
Define a Space as a Character A-13
Delete Master Symbol Data 15-11
Device Control 15-1, 15-6
Diagnostic Messages Overview 12-1, 12-3
Diagnostic Warning 10-17
Diagnostic Warnings (output 2) 10-23
Diagnostic Warnings (output 3) 10-24
Diagnostics i-v, 12-1
Diagnostics (Output 1) 10-21
Diagnostics by ESP 12-1, 12-2
Diagnostics by Serial Command 12-1, 12-2
Digital Bar Code 15-1, 15-12
Direction 9-25
Disable Reader 15-7
Disabled 3-4, 3-6, 4-8, 7-19, 9-18, 10-4, 10-10, 10-15, 10-17
Disclaimer i-ii
Document Memo 2-8

E

EAN Status 9-17
EAN-128 Status 9-8
Easy Mode 2-2, 2-12
Editing a Macro 14-4
Electrical Specifications A-4
Embedded Menus A-24
Emissions A-2
Enable Reader 15-7
Enabled 3-6, 4-8, 9-18, 9-28

End of Read Cycle 7-1, 7-14, 10-6
End of Read Cycle Mode 7-14
End Read Rate Test 15-3
Enter Master Symbol Data 15-10
Enter Single Symbol Decodes/Second Test 15-3
Enter Single Symbol Percent Test 15-3
Entering Special Characters in Embedded Menus A-13
Entering Special Characters in Serial Commands A-13
Entering Symbol Configuration A-18
Environmental A-2
Exceptions 2-14
Exiting Symbol Configuration A-19
Extended Read Rate 15-3
External Edge 7-9
External Level 7-8
External Trigger State 7-11
Extraction by ESP 13-4
Extraction by Serial Command 13-5
Extraction Mode 13-1, 13-4
Extras 15-7
EZ Button i-iii, 3-1, 10-1, 10-14
EZ Button Auto Framing 3-7
EZ Button by ESP 3-1, 3-2
EZ Button by Serial Command 3-1, 3-2
EZ Button Modes 3-1, 3-4
EZ Button Operation 3-1, 3-3
EZ Button Options 3-1, 3-6

F

Factory Default Parameters A-17
File 2-4
Filter #1 13-15
Filter #2 13-15
Filter Index 13-12
Filters 1 and 2 13-15
Find Function 14-1, 14-3
Firmware 15-1, 15-13
Firmware Update 15-13
Firmware Verification 15-14
Firmware/Checksum Verification 15-14
FIS Options A-3
Fixed Symbol Length 9-21, 9-26, 9-27
Fixed Symbol Length Status 9-5, 9-7, 9-15, 9-20, 9-21, 9-24, 9-26, 9-27
Fixed Threshold Value 9-25
Formulas for Number of Decodes A-20

Frame 4-6
Full ASCII Set 9-6
Full Duplex Mode 6-12
Fully Optoisolated A-5, A-7

G

Gain A-22
Gain Level 7-17
General Specifications A-2
General tab 2-6
Global Status of EZ Button 3-6
Glossary of Terms A-31
Good Read 10-5
Good Read (Green Flash) 10-10
Good Read/Match Counter 15-5
Good Read/Match Counter Reset 15-5
Grading 15-16
Green Flash Duration 10-11
Green Flash Mode 10-10
Guard Bar 9-13

H

Half Duplex Mode 6-11
Hardware Default A-17
Hardware Required 1-2
Hex String 13-7
High Temperature 12-1, 12-9
High Temperature Message 12-9
High Temperature Status 12-9
Highlighting i-viii
Host Communications i-viii
Host Connector, 25-pin, MS-850 A-4
Host Port Connections 6-3
Host Protocol 6-4
Hours Since Last Reset 12-1, 12-6

I

I 2/5 symbol 1-6
I/O Parameters i-iv, 10-1
I/O Parameters by ESP 10-1, 10-2

I/O Parameters by Serial Command 10-1, 10-3
Import/Export 2-4
Improving the Number of Decodes A-22
In Read Cycle 10-17
Index i-vi
Input 10-1, 10-15
Insertion by ESP 13-6
Insertion by Serial Command 13-7
Insertion Mode 13-1, 13-6
Install ESP 1-1, 1-3
Interface Standards A-25
Interleaved 2 of 5 9-11
Interleaved 2 of 5 Status 9-11

K

K Commands A-12

L

Label Configuration 3-5
Label Speed A-22
Ladder A-20
Large Intercharacter Gap 9-5, 9-15
Laser Current High 10-21
Laser Current Low 10-22
Laser Framing 8-7
Laser Framing Status 4-8
Laser High 12-1, 12-7
Laser High Message 12-7
Laser High Status 12-7
Laser Light A-2
Laser Low 12-1, 12-8
Laser Low Message 12-8
Laser Low Status 12-8
Laser Off Position 8-8
Laser On Position 8-8
Laser On/Off 8-6
Laser Power 7-18, 8-8
Laser Power Status 4-8
Laser Setup 7-1, 7-22, 8-1, 8-6
Laser Status 3-7
Latch Mode 1 (Unlatch on Input #1) 10-18
Latch Mode 2 (Unlatch Opposite Condition) 10-18

Latch Mode 3 (Unlatch Enter Read Cycle) 10-18
Latest Manual Version i-ii
Leading Edge 7-19
Length 13-5, 13-7
Limitation of Liability i-vii
List of Serial Commands A-8
Load Current Settings from Database 5-7
Load New Master 3-5
Longitudinal Redundancy Check 6-21
Low Temperature 10-22, 12-1, 12-9
Low Temperature Message 12-9
Low Temperature Status 12-9
LRC Status 6-1, 6-21

M

Macros 14-1, 14-4
Manual Adjustment 8-7
Master Database Overview 15-8
Master Reader 6-16
Master Symbol Database 15-1, 15-8
Match 10-4, 10-16
Match (Green Flash) 10-11
Match Length 11-1, 11-7
Match Replace 11-1, 11-12
Match Replacement Message 11-12
Match Start Position 11-1, 11-6
Matchcode i-v, 11-1
Matchcode by ESP 11-1, 11-2
Matchcode by Serial Command 11-1, 11-2
Matchcode Type 11-1
Maximum Element 7-21
Mechanical A-2
Micro PDF417 9-27
Microscan Grading 15-16
Minimum Bars 9-25
Mismatch 10-4, 10-16, 10-19
Mismatch (Green Flash) 10-11
Mismatch Counter 15-5
Mismatch Counter Reset 15-5
Mismatch or Noread 10-16
Mismatch Replace 11-1, 11-13
Mismatch Replacement Message 11-13
Model 2-5
Model Memo 2-8
Model Selection 1-4

Modifiers for Code 39, Codabar, and I-2/5 9-30
MS-860 Industrial Raster Reader User's Manual i-i
Multidrop 6-6
Multidrop Address Table A-30
Multidrop Communications A-26
Multisymbol 7-1, 7-4
Multisymbol Number 13-8
Multisymbol Output Format Status 13-1, 13-8
Multisymbol Separator 7-5

N

Narrow Margins 9-1, 9-29
Navigating in ESP 2-12
New 2-4
New Master Pin 11-1, 11-11
New Trigger 7-15
No Symbol Message 10-1, 10-9
No Symbol Status 10-9
Noise Interference A-25
Non-delimited Start and Stop Characters 7-13
Noread 10-16, 10-19
Noread Counter 15-5
Noread Counter Reset 15-5
Noread Message 10-1, 10-7
Noread Status 10-7
Normally Closed 10-17
Normally Open 10-17
Not Optoisolated A-7
Not Optoisolated, Reader Grounded A-5
Number Before Output 7-16
Number of Active Indexes 5-4
Number of Filters 13-15
Number of Master Symbols 15-9
Number of Symbols 7-4
Number to Output On 10-20

O

Object detector 1-2
Open/Save 2-4
Operation of Database 5-4
Operational Tips A-23
Options 2-6

Optoisolator Inputs A-7
Optoisolator Outputs A-5
Ordered Output 13-1, 13-10
Ordered Output by ESP 13-11
Ordered Output by Serial Command 13-12
Other Codes 9-30
Output # 13-5, 13-7
Output # 1 Pulse 15-6
Output # 2 Pulse 15-6
Output # 3 Pulse 15-6
Output 1 10-1, 10-16
Output 2 10-1, 10-23
Output 3 10-1, 10-24
Output Circuit Examples A-5
Output Format i-v, 9-8, 13-1
Output Format by ESP 13-1, 13-2
Output Format by Serial Command 13-1, 13-2
Output Format Examples by Serial Command 13-7
Output Format Insertion 13-6
Output Format Overview 13-1, 13-3
Output Format Status 13-3, 13-8
Output Format Status by ESP 13-9
Output Indicators 10-1, 10-10
Output Mode (Output 1) 10-18
Output On 10-16
Output State (Output 1) 10-17
Outputs 15-6
Over Temperature 10-21
Overview of Configuration Database 5-2
Overview of Matchcode 11-1, 11-3

P

Parity
aux port 6-8
Parity, Aux Port 6-8
Parity, Host Port 6-3
PDF Status 9-26
PDF417 9-26
Pharmacode 9-24
Pharmacode Status 9-24
Picket Fence A-20
Pitch 1-6
Placeholder Character 13-13
Point-to-Point (standard) 6-4
Point-to-Point with RTS/CTS 6-5

Point-to-Point with RTS/CTS & XON/XOFF 6-5
Point-to-Point with XON/XOFF 6-5
Polling Mode 6-5
Polling Reset A-28
Polling Sequence A-28
Position Symbol and Reader 1-1, 1-6
Postamble 6-1, 6-20
Postamble Character(s) 6-20
Postamble Status 6-20
Power Connector A-4
Power connector 1-2
Power Supply 1-2
Power-on Count 12-4
Power-on Parameters A-16
Power-on Saves 12-5
Preamble 6-1, 6-19
Preamble Character(s) 6-19
Preamble Status 6-19
Preferences 2-6
Programmable Beeps 3-3
Programmable Options 3-3
Protocol Commands A-15
Pulldown Menus 2-4
Pulse 10-18
Pulse Width (Output 1) 10-17
Pulse, discrete outputs 10-18

Q

Quality Output 10-1, 10-25
Quality Output Separator 10-25
Quick Start i-iii, 1-1

R

Range A-22
Range Mode Status 9-13
Raster Options 4-6
Raster Picket Fence Calculation A-21
Raster Setup 7-1, 7-22, 8-1, 8-3
Raster Status 3-7, 8-3, 10-27
Raster Sweep Rate 8-5
Raster/Laser i-iv, 8-1
Raster/Laser Setup by ESP 8-1, 8-2

Raster/Laser Setup by Serial Command 8-1, 8-2
Read Cycle i-iv, 7-1
Read Cycle by ESP 7-1, 7-2
Read Cycle by Serial Command 7-1, 7-3
Read Cycle On/Off 8-5
Read Cycle Timeout 7-15
Read Duration Output 10-1, 10-30
Read Ranges A-3
Read Rate 1-7, 3-4, 15-1, 15-3
Read Rate by ESP 15-3
Read Rate by Serial Command 15-3
Reader Connectors A-4
Reader Setup 7-1, 7-17
Recall customer default parameters and save for power-on 15-16, A-16
Recall factory default parameters and save for power-on 15-16, A-16
Receiving 2-13
Request All Master Symbols Data 15-11
Request Checksum 15-14
Request Master Symbol Data 15-11
Request Part Number 15-14
Request the Number of Master Symbols in ESP 15-9
Required 9-18, 9-28
Reset 15-16, A-16
Reset and recall customer default parameters 15-16, A-16
Reset and recall factory defaults 15-16, A-16
Reset and recall power-on parameters 15-16, A-16
Reset Counts 10-15
Resets 12-4
Resetting A-16
Resolution 12-10
Response Timeout 6-1, 6-22
RS-232 A-25
RS-232 Auxiliary Port 6-1, 6-8
RS-232/422 Host Port 6-1, 6-3
RS-422 A-25
RS-485 A-25
RSS 9-22
RSS Expanded 9-21
RSS Limited 9-22
RSS-14 9-23
Rule #1
Ordered Output 13-10
Rule #2
Ordered Output 13-10
Rule #3
Ordered Output 13-10

S

- Safety Certifications A-2
- Safety Labels i-ix
- Save current settings as customer default parameters 15-16, A-16
- Save current settings for power-on 15-16, A-16
- Save Current Settings to Database 5-7
- Save for Power-on 3-5
- Saving 2-13, A-16
- Scan Speed 7-17, A-22
- Scan Speed Status 4-7
- Scan Status 10-28
- Scan Width A-21, A-22
- Scanning Parameters A-2
- Search 4-6
- Secondary Reader 6-16
- Select NUL as the Character A-13
- Select Reader Model 1-1
- Select Reset A-29
- Select Sequence A-29
- Send Current Command 2-14
- Send Current View 2-14
- Send Motor Off 15-7
- Send Motor On 15-7
- Send/Receive Options 2-13
- Separator 10-26, 10-30
- Separator Character 9-19, 9-28
- Separator Status 9-18, 9-28
- Sequence On Mismatch 11-1, 11-10
- Sequence On Noread 11-1, 11-9
- Sequence Step 11-1, 11-11
- Sequential Matching 11-1, 11-5
- Serial Command Beep Status 10-13
- Serial Command Echo Status 10-12
- Serial Command Format A-12
- Serial Command Status Request A-13
- Serial Communication Parameters A-27
- Serial Configuration Commands A-8
- Serial Data 7-9
- Serial Data or External Edge 7-10
- Serial Trigger 7-1, 7-12
- Serial Trigger Character 7-12
- Serial Utility Commands A-12
- Serial Verification 10-1, 10-12
- Service Message 12-1, 12-10
- Service Message Status 12-10

Service Threshold 10-21
Set the Number of Master Symbols in ESP 15-9
Setup for Configuration Database 5-3
Setup Mode 2-12
Single Line Ladder Calculation A-20
Single Scan Line Picket Fence Calculation A-20
Sleep Mode 3-5
Software Default A-17
Specular reflection 1-6
Stacked Symbologies 9-1, 9-26
Start & Stop Match Status 9-14
Start & Stop Output Status 9-14
Start Character (non-delimited) 7-13
Start Position 13-5
Static Presentation (Green Flash) 10-10
Status 10-26, 10-30, 11-12, 11-13
Stop Bits, Aux Port 6-9
Stop Bits, Host Port 6-3
Stop Character (non-delimited) 7-13
Store Next Symbol as Master Symbol 15-11
Straight 4-7
Supplementals Status 9-18
Supplementals Type 9-19
Sweep Rate A-21
Symbol Configuration A-18
Symbol Data Output 10-1, 10-4
Symbol Data Output Status 10-4
Symbol Density A-22
Symbol Detect Status 7-20
Symbol Dimensions A-22
Symbol Length 9-5, 9-7, 9-15, 9-20, 9-24, 13-12, A-21
Symbol Length #1 9-12
Symbol Length #2 9-12
Symbol Position Output 10-1, 10-27
Symbol Position Separator 10-29
Symbol Ratio A-22
Symbol Speed A-20, A-21
Symbol Type 15-1, 15-15
Symbologies i-iv, 9-1, A-2
Symbologies by ESP 9-1, 9-2
Symbologies by Serial Command 9-1, 9-3
Symbology Detect 4-9
Symbology ID 9-1, 9-30
Symbology Type 13-12

T

- Table of Contents i-iii
- Terminal Mode i-vi, 14-1
- Terminal Pulldown Menu 14-5
- Terminal tab 2-7
- Terminal Window 14-1, 14-2
- Terminal Window Functions 14-1, 14-5
- Test 2-2
- Test for Read Rate 1-1, 1-7
- This Manual i-viii
- Threshold 12-10
- Timeout 7-14
- Timeout or New Trigger 7-15
- Top Offset 8-4
- Tracking 7-17
- Transition Counter 7-21
- Transparent Mode 6-10
- Trend Analysis 10-17
- Trend Analysis (Output 1) 10-19
- Trend Analysis (output 2) 10-23
- Trend Analysis (output 3) 10-24
- Trend Analysis Mode 10-19
- Trigger 3-6, 7-1, 7-6
- Trigger Connector A-4
- Trigger connector 1-2
- Trigger Connector, 4-pin A-4
- Trigger Counter 15-5
- Trigger Counter Reset 15-5
- Trigger Evaluation Period 10-20
- Trigger Filter Duration 7-11
- Trigger Mode 7-6
- Troubleshooting A-23

U

- Unlatch Output 10-15
- UPC Status 9-17
- UPC/EAN 9-17
- UPC-E Output to UPC-A 9-19
- USB A-25
- User Defined Address 6-6
- User Defined Example 6-7
- User Defined Multidrop 6-7
- User Defined Point-to-Point 6-6

Using Configuration Symbols A-19
Using ESP i-iii, 2-1
Using Master Symbols 11-1, 11-3
Using Multisymbol with Output Format 13-9
Using the EZ Button 3-3
Utilities i-vi, 15-1
Utilities by ESP 15-1, 15-2
Utility and configuration commands A-12

V

Video Status 4-7
View 2-11

W

Warning and Caution Summary i-x
Warranty i-vii
When to Output Symbol Data 10-6
Wild Card Character 11-1, 11-8
Wildcard Character 13-13
Wildcard/Placeholder Matches 13-13
Within a Serial Command 6-19, 6-20
Within an Embedded Menu 6-19, 6-20

Z

Zoom 15-12