

MICROSCAN®

MS-890 Industrial Automation Scanner User's Manual



Copyright and Disclaimer

Copyright ©2010
Microscan Systems, Inc.

ISO 9001 Certified
Issued by TÜV USA

All rights reserved. The information contained herein is proprietary and is provided solely for the purpose of allowing customers to operate and/or service Microscan manufactured equipment and is not to be released, reproduced, or used for any other purpose without written permission of Microscan.

Throughout this manual, trademarked names might be used. Rather than place a trademark (™) symbol at every occurrence of a trademarked name, we state herein that we are using the names only in an editorial fashion, and to the benefit of the trademark owner, with no intention of infringement.

Disclaimer

The information and specifications described in this manual are subject to change without notice.

Latest Manual Version

For the latest version of this manual, see the Download Center on our web site at:
www.microscan.com.

Technical Support

For technical support, e-mail: helpdesk@microscan.com.

Warranty and Terms of Sale

For Standard Warranty information, see: www.microscan.com/warranty.

Microscan Systems, Inc.

Renton Headquarters

Tel: 425.226.5700 / 800.251.7711
Fax: 425.226.8250

Nashua Office

Tel: 603.598.8400
Fax: 603.577.5818

Microscan Europe

Tel: 011 31 172 423360
Fax: 011 31 172 423366

Microscan Asia Pacific

Tel: 65 6846 1214
Fax: 65 6846 4641

Table of Contents

Chapter 1	Quick Start	
	Step 1 Check Required Hardware	1-2
	Step 2 Connect the System	1-3
	Step 3 Position Scanner and Symbol	1-5
	Step 4 Install ESP	1-6
	Step 5 Select Model	1-7
	Step 6 Autoconnect	1-8
	Step 7 Receive Settings	1-9
	Step 8 Calibrate	1-10
	Step 9 Test Read Rate	1-11
	Step 10 Configure the Scanner in ESP	1-12
	Step 11 Save Configuration in ESP	1-13
Chapter 2	Using ESP	
	EZ Mode	2-2
	Application Mode	2-3
	Menu Toolbar	2-4
	Autoconnect	2-12
	View	2-14
	Navigating in ESP	2-15
	Send/Receive Options	2-16
Chapter 3	Communications	
	Communications by ESP	3-2
	Communications Serial Commands	3-2
	RS-232/422 Host Port	3-3
	Host Port Parameters	3-4
	Host Protocol	3-5
	Poll Address	3-7
	ACK / NAK Options	3-8
	Polling Mode Options	3-9
	Auxiliary Port Protocol	3-10
	Daisy Chain Autoconfigure	3-19
	Daisy Chain Scanner ID	3-20
	Auxiliary / Configuration Port System Data	3-21
	Preamble	3-22
	Postamble	3-23
	LRC Status	3-24
	Intercharacter Delay	3-25
	Response Timeout	3-26
Chapter 4	Read Cycle	
	Read Cycle by ESP	4-2
	Read Cycle Serial Commands	4-2
	Multisymbol	4-3

Table of Contents

Trigger	4-5
External Trigger State	4-11
Serial Trigger	4-12
Start Character (Non-Delimited)	4-13
Stop Character (Non-Delimited)	4-13
End of Read Cycle	4-14
Good Decode Reads	4-17
Gain Settings	4-18
Focus	4-19
Scan Speed	4-20
Automatic Gain Control (AGC) Settings	4-21
Maximum Element	4-22
Tracking Adjustment	4-23
Chapter 5 Symbologies	
Symbologies by ESP	5-2
Symbologies Serial Commands	5-2
Code 39	5-3
Code 128 / EAN-128	5-6
Interleaved 2 of 5	5-10
Codabar	5-13
UPC/EAN	5-16
Code 93	5-19
Pharmacode	5-20
PDF417	5-22
Narrow Margins / Symbology ID	5-24
Background Color	5-26
Autodiscriminate	5-27
Chapter 6 I/O Parameters	
I/O Parameters by ESP	6-2
I/O Parameters Serial Commands	6-3
Symbol Data Output	6-4
No Read Message	6-6
Bad Symbol Message	6-7
No Symbol Message	6-7
Read Duration Output	6-8
Output Indicators	6-9
Beeper	6-12
Serial Verification	6-13
EZ Button	6-15
EZ Button Modes	6-17
Input 1	6-19
Configurable Output 1	6-20
Trend Analysis Output 1	6-24
Diagnostics Output 1	6-27

Configurable Output 2	6-28
Trend Analysis Output 2	6-28
Diagnostics Output 2	6-28
Configurable Output 3	6-29
Trend Analysis Output 3	6-29
Diagnostics Output 3	6-29
Database Identifier Output.....	6-30
Quality Output.....	6-31
Chapter 7 Matchcode	
Matchcode by ESP	7-2
Matchcode Serial Commands	7-2
Overview of Matchcode	7-3
Using Master Symbols.....	7-4
Matchcode Type	7-5
Sequence Step	7-10
New Master Pin	7-11
Match Replace.....	7-12
Mismatch Replace	7-13
Chapter 8 Diagnostics	
Diagnostics by ESP	8-2
Diagnostics Serial Commands	8-2
Counts	8-3
Hours Since Last Reset.....	8-4
Warning Messages.....	8-5
Laser Current Warning	8-7
Present Operating Temperature (Deg. C)	8-8
High Temperature Threshold.....	8-9
Low Temperature Threshold	8-10
Lifetime Hours	8-11
Service Message	8-12
Chapter 9 Calibration	
Calibration Serial Commands.....	9-2
Calibration Steps	9-3
Calibration Routine	9-4
Calibration Results	9-5
Configuration Database	9-6
Optoelectric Control	9-8
Advanced Calibration Features	9-14
Calibration by Embedded Menu	9-17
Chapter 10 Raster/Laser	
Raster/Laser Setup by ESP.....	10-2
Raster/Laser Serial Commands	10-2
Raster Setup.....	10-3
Laser Framing	10-7

Table of Contents

Raster/Laser by Embedded Menu.....	10-9
Chapter 11 Terminal	
Terminal Window.....	11-2
Find	11-3
Send	11-4
Macros.....	11-5
Terminal Window Menus.....	11-6
Chapter 12 Utilities	
Serial Utility Commands.....	12-2
Read Rate	12-4
Counters.....	12-6
Device Control.....	12-8
Differences from Default.....	12-10
Master Database	12-11
Digital Bar Code	12-16
Firmware	12-17
Autodiscriminate.....	12-19
Scanner Status Requests.....	12-20
Chapter 13 Output Format	
Output Format Serial Commands.....	13-2
Output Format Status	13-3
Format Assign	13-4
Format Extract.....	13-5
Format Insert.....	13-7
Output Filter Configuration	13-9
Number of Filters.....	13-14
Chapter 14 Wiring Box	
Wiring Box Description	14-2
Installation Steps	14-3
Wiring Box Ports.....	14-5
Wiring Box PCB with Connectors.....	14-8
Mounting Plate	14-9
Appendices	
Appendix A General Specifications	A-2
Appendix B Electrical Specifications	A-4
Appendix C Serial Configuration Commands.....	A-9
Appendix D ASCII Table	A-15
Appendix E Embedded Menus.....	A-17
Appendix F Defaulting / Saving / Initializing	A-18
Appendix G Position Scanner and Symbol	A-21
Appendix H Object Detector	A-22
Appendix I Bar Code Configuration.....	A-23
Appendix J Test Read Rate	A-25
Appendix K Formulas for Number of Decodes	A-27

Appendix L Operational TipsA-32
Appendix M Interface StandardsA-33
Appendix N Multidrop CommunicationsA-34
Appendix O Glossary of TermsA-39
Index

About the MS-890 Industrial Automation Scanner

The key features of the MS-890 Industrial Automation Scanner are:

- Wide angle sweeping raster
- Long-distance read range (10" to 120" (254 mm to 3,048 mm))
- EZ Button setup
- Configurable with ESP Software
- 400 to 1,000 decodes per second
- IP65 rated enclosure
- Optional wiring box
- LED performance indicators

About This Manual

This manual provides complete information on setting up, installing, and configuring the MS-890 Industrial Automation Scanner. The chapters follow the **ESP** menus, which are presented in the order in which a scanner might be set up and made ready for industrial operation. Host serial commands are presented side-by-side with **ESP**.

Highlighting

Serial commands, highlighted command fields, and default command settings are highlighted in **rust bold**. Cross-references and web links are highlighted in **blue bold**. References to **ESP**, its toolbar headings (**Communications**, **Read Cycle**, **Symbologies**, etc.), menu topics, and other points of emphasis, are highlighted in **Bold Initial Caps**.

Host Communications

There are four ways to configure and test the MS-890 Industrial Automation Scanner:

- EZ Button.
- Microscan's Windows-based **ESP** (Easy Setup Program), which offers point-and-click ease of use and visual responses to user adjustments.
- Serial commands, such as **<K100,1>**, that can be sent from **ESP's Terminal** or another terminal program, or encoded in Code 128 symbols.
- The tree controls and graphic interfaces in **ESP's App Mode**.

Statement of Agency Compliance



The MS-890 Industrial Automation Scanner has been tested for compliance with FCC (Federal Communications Commission) regulations and has been found to conform to all applicable FCC Rules and Regulations.

To comply with FCC RF exposure compliance requirements, this device must not be co-located or operate in conjunction with any other antenna or transmitter.

Changes or modifications not expressly approved by the party responsible for compliance could void the user's authority to operate the equipment.



The MS-890 Industrial Automation Scanner has been tested for compliance with CE (Conformité Européenne) standards and guidelines, and has been found to conform to applicable CE standards, specifically EN61000-6-3:2001: for Class A products; EN61000-3-2:2000+A2:2005; EN61000-3-3:1995+A1:2001; EN61000-6-2: Immunity.

The MS-890 Industrial Automation Scanner has been tested by an independent electromagnetic compatibility laboratory in accordance with the applicable specifications and instructions.

Approvals

This equipment is in compliance or approved by the following organizations:

- FCC (Federal Communications Commission)
- CDRH (Center for Devices and Radiological Health)
- CE (Conformité Européenne)
- UL/cUL (Underwriters Laboratories, Inc.; UL Canada)
- BSMI (Bureau of Standards, Metrology and Inspection)

Warning and Caution Summary

This equipment has been tested and found to comply with the limits for a Class A digital device, pursuant to part 15 of the FCC Rules. These limits are designed to provide reasonable protection against harmful interference in a residential installation. This equipment generates, uses, and can radiate radio frequency energy, and, if not installed and used in accordance with the instructions, may cause harmful interference to radio communications. However, there is no guarantee that interference will not occur in a particular installation. If this equipment does cause harmful interference to radio or television reception, which can be determined by turning the equipment off and on, the user is encouraged to try to correct the interference by one or more of the following measures:

- Reorient or relocate the receiving antenna.
- Increase the separation between the equipment and receiver.
- Connect the equipment into an outlet on a circuit different from that to which the receiver is connected.
- Consult the dealer or an experienced radio/TV technician for help.

European models must use a similarly rated Class I or Class II power supply that is certified to comply with standard for safety EN 60950.

Use of controls, adjustments, or performance of procedures other than those specified herein may result in hazardous laser light radiation exposure.

There are no user serviceable parts in the scanner. Opening the scanner voids the Microscan Systems warranty and could expose the user to laser diode power of up to 7 mW.

The laser beam can be harmful to eyesight. Avoid eye contact with the laser beam. Never point the beam at other people, or in a direction where people may be passing.

Statement of RoHS Compliance

All Microscan readers with a 'G' suffix in the FIS number are RoHS-Compliant. All compliant readers were converted prior to March 1, 2007. All standard accessories in the Microscan Product Pricing Catalog are RoHS-Compliant except 20-500013-01 and 98-000039-02. These products meet all the requirements of the European Parliament and the Council of the European Union for RoHS compliance. In accordance with the latest requirements, our RoHS-compliant products and packaging do not contain intentionally added Deca-BDE, Perfluorooctanes (PFOS) or Perfluorooctanoic Acid (PFOA) compounds above the maximum trace levels. To view the documents stating these requirements, please visit:

<http://eur-lex.europa.eu/LexUriServ/LexUriServ.do?uri=CELEX:32002L0095:EN:HTML>

and

<http://eur-lex.europa.eu/LexUriServ/LexUriServ.do?uri=OJ:L:2006:372:0032:0034:EN:PDF>

Please contact your sales manager for a complete list of Microscan's RoHS-Compliant products.

This declaration is based upon information obtained from sources which Microscan believes to be reliable, and from random sample testing; however, the information is provided without any representation of warranty, expressed or implied, regarding accuracy or correctness. Microscan does not specifically run any analysis on our raw materials or end product to measure for these substances.

The information provided in this certification notice is correct to the best of Microscan's knowledge at the date of publication. This notice is not to be considered a warranty or quality specification. Users are responsible for determining the applicability of any RoHS legislation or regulations based on their individual use of the product.

1 Quick Start

Contents

Step 1 Check Required Hardware.....	1-2
Step 2 Connect the System.....	1-3
Step 3 Position Scanner and Symbol.....	1-5
Step 4 Install ESP.....	1-6
Step 5 Select Model	1-7
Step 6 Autoconnect	1-8
Step 7 Receive Settings	1-9
Step 8 Calibrate.....	1-10
Step 9 Test Read Rate.....	1-11
Step 10 Configure the Scanner in ESP	1-12
Step 11 Save Configuration in ESP.....	1-13

This chapter is designed to get your MS-890 up and running quickly, using the EZ Button or **ESP** (Easy Setup Program). Following these steps will allow you to get a sense of the scanner's capabilities and to test symbol decode performance.

Detailed setup information for installing the scanner into your application can be found in the subsequent chapters.

Important: If you are switching from an **MS-880** to an **MS-890** in your application, follow these steps when you open **ESP**:

1. With your MS-890 connected to the host computer, open your most recent MS-880 **.esp** file.
2. Connect to the MS-890 and send all settings.
3. Click the **Switch Model** button at the top of the **ESP** view. When you see the model menu, select the MS-890.
4. Receive settings.

Note: After receiving settings, you can delete the previous MS-880 model by opening the **Model** dropdown menu from the menu toolbar, selecting **Remove Model**, and selecting **MS-880**.

Step 1 — Check Required Hardware

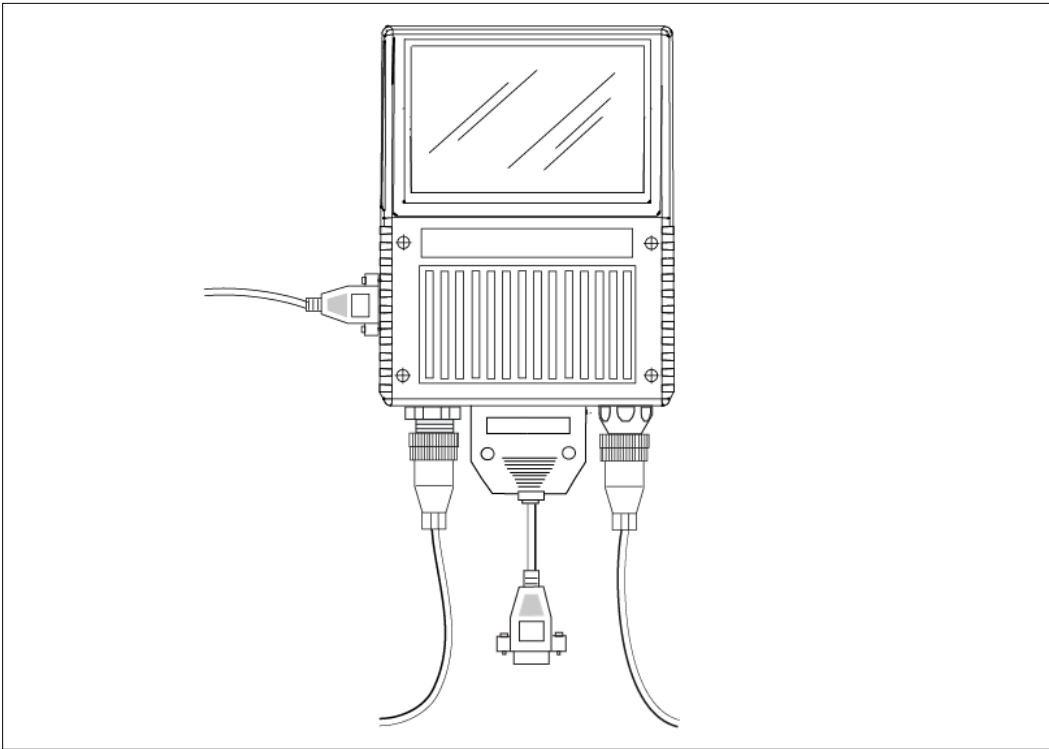

Hardware Required

Caution: Be sure that all cables are connected **BEFORE** applying power to the system. Always power down **BEFORE** disconnecting any cables.

<i>Item</i>	<i>Description</i>	<i>Part Number</i>
1	MS-890 Industrial Automation Scanner	FIS-0890-0001G, -0002G
2	9-Pin Configuration Cable	61-000010-02
3	Power Supply	97-100004-15
4	Object Detector (optional)	99-000004-01
5	Comm./Serial Cable	61-000034-02

Note: Standalone configuration shown above.

Step 2 — Connect the System

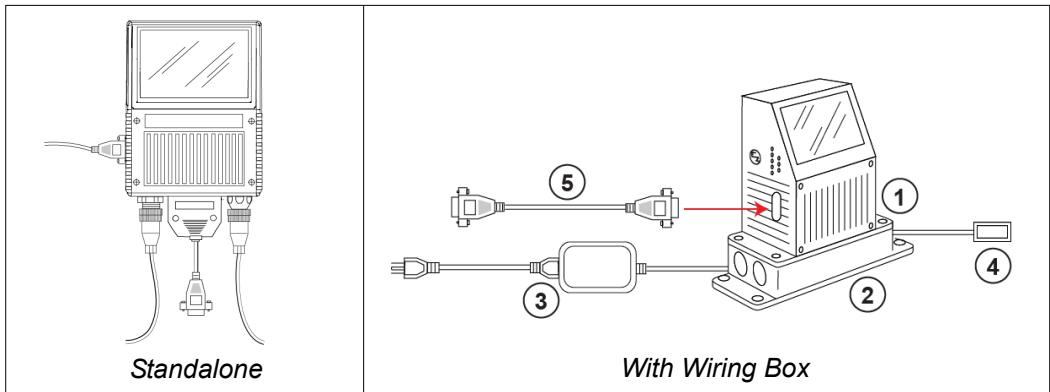

Caution: Be sure that all cables are connected **BEFORE** applying power to the system. Always power down **BEFORE** disconnecting any cables.

Connecting the MS-890 Standalone

1. Attach the configuration cable to either the 9-pin (preferred) or 25-pin connector (on bottom of unit) to configure, test, and default the scanner.

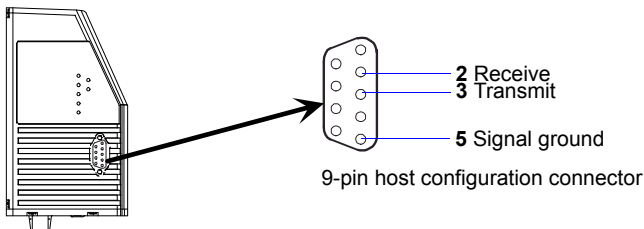

2. Attach the power supply cable to the 3-pin power connector on the bottom of the scanner.

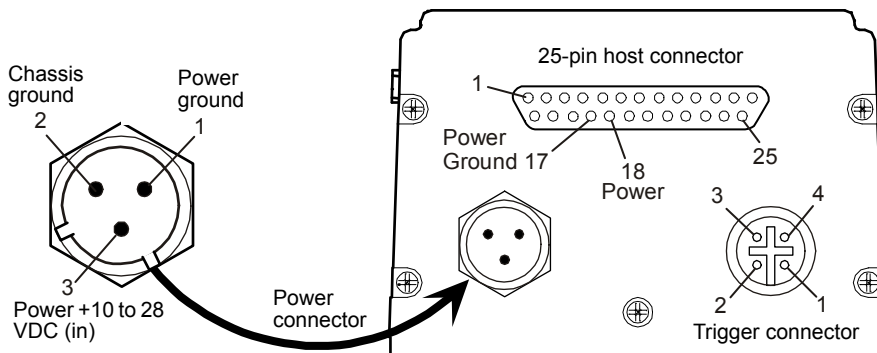

Connecting the MS-890 with Wiring Box

1. Be sure that the wiring box power cord is not plugged in.
2. Connect the scanner to the host computer.
3. Use the 9-pin configuration connector shown below to connect with your computer. This port is useful for setting up, testing, and defaulting the scanner.

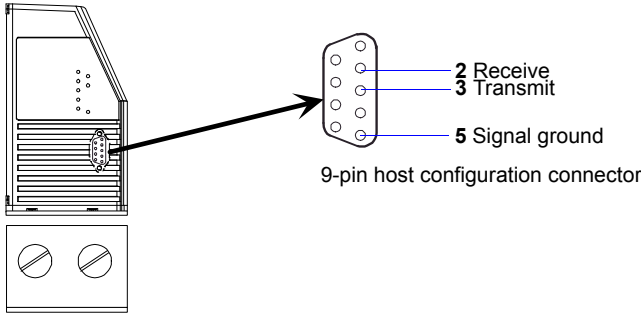

4. Connect power to the wiring box.
5. Apply power to the wiring box and confirm that the LED next to the right side power terminal is green and not red.
6. Disconnect power.

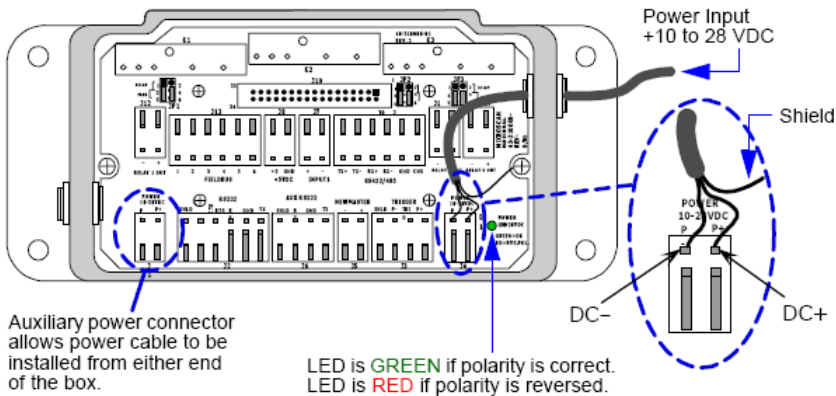

7. Plug the ribbon cable (provided with wiring box) into the bottom of the scanner.
8. Attach the scanner to the wiring box with the 4 screws provided.
9. Power-on the scanner.

Step 3 — Position Scanner and Symbol

- Set up a symbol at the distance that will be used in your application.

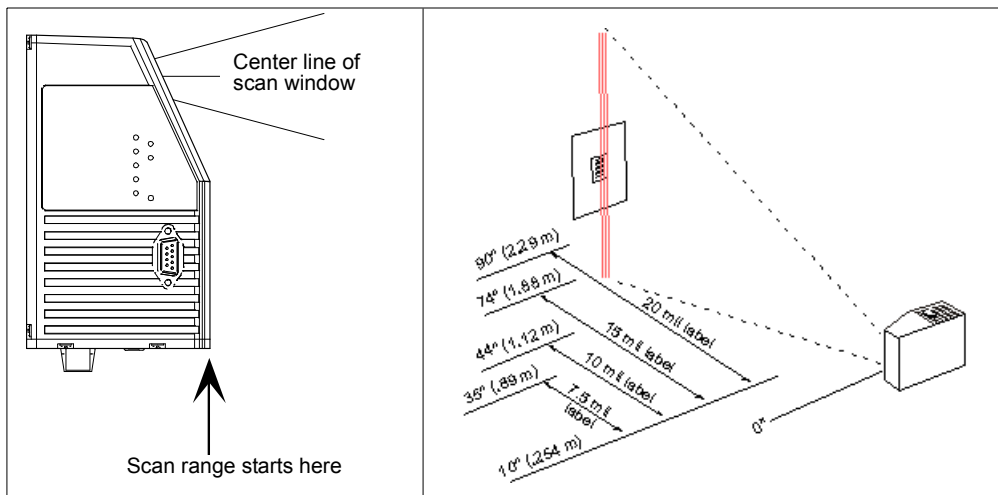

Note: Code 39 is the default symbology enabled. If you are uncertain as to the symbology type in your application, enable all symbologies by clicking the **Autodiscriminate** button in **EZ Mode**.

Important: If using Interleaved 2 of 5 symbols in your application, verify that the number of characters in the symbols being scanned matches the symbol length enabled for the Interleaved 2 of 5 symbology (default is 10 and 6).

Step 4 — Install ESP

Easy Setup Program (ESP) is Microscan's proprietary setup and testing application. The purpose of **ESP** is to provide a quick and easy way to set up and configure Microscan products.

When the MS-890 is connected to a host computer (Windows Vista, XP, or 2000), **ESP** can be used to set up communication with a host, configure various firmware settings, and control verification processes.

Important: To migrate MS-880 settings to MS-890 settings in ESP, refer to the beginning of Chapter 2, **Using ESP**.

If installing from the Microscan Tools CD:

1. Insert the Microscan Tools CD in your computer's CD drive.
2. Choose **ESP Software** from the main menu.
3. Select the **Current Version** of **ESP** and follow the file download prompts.

If downloading from the Microscan website:

1. Go to <http://www.microscan.com/downloadcenter>
2. Create a new "myMicroscan" member account or, if you are already a member, enter your user name and password.
3. Click the **Download Software** link and extract the latest version of **ESP** to a directory of your choice. Note where your ESP.exe file is stored on your hard drive.
4. At the end of the installation process, the following icon will appear on your desktop:



5. Click the **ESP** icon to start the program.

System Requirements for ESP

- 166 MHz Pentium processor (recommended)
- Windows Vista, XP, or 2000 operating system
- Internet Explorer 5.0 or higher
- 64 MB minimum RAM
- 40 MB minimum disk space

Step 5 — Select Model

When you start **ESP**, this menu will appear:

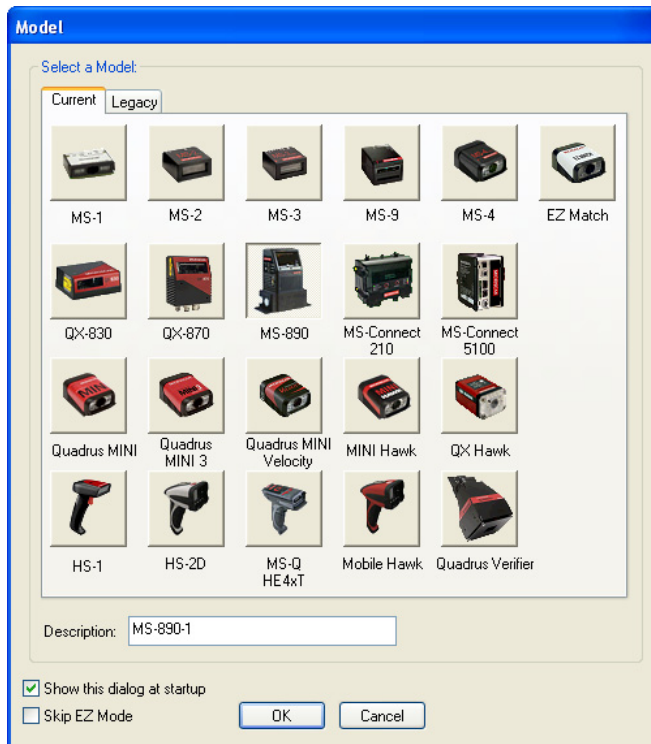

1. Select the MS-890 from the menu and click **OK**. If you do not want to make this selection every time you start **ESP**, uncheck “Show this dialog at startup”.
2. Click **Yes** when the following dialog appears:

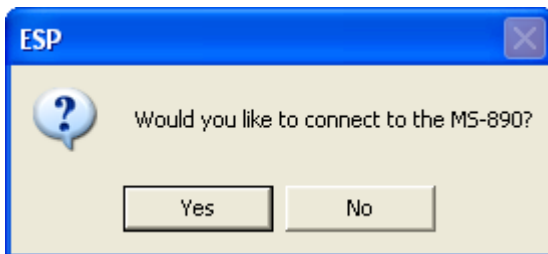

Note: If you need to select another model later, click the **Switch Model** button near the top of the screen.

Step 6 — Autoconnect

1. Select the appropriate port and click **Start** when the following dialog appears.

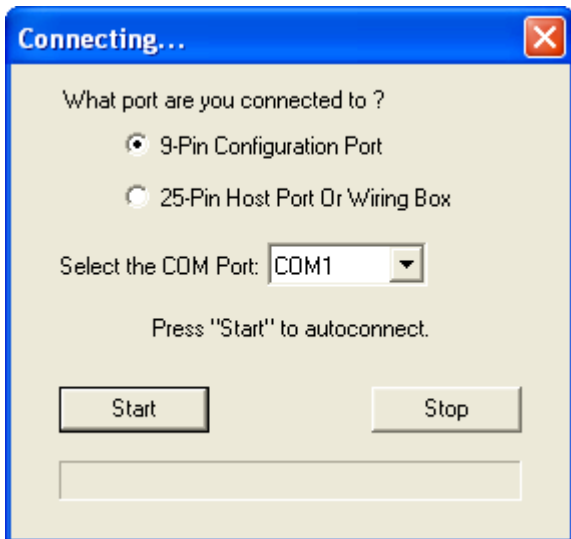

Note: If your communications port is not the default **COM1**, use the dropdown menu to change your port.

Once you have chosen the correct port, click **Start** to connect. 

When you are connected, you will see the green connection indicator in the status bar at the bottom right of your screen:

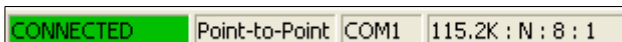

2. If the connection attempt fails, click the **Autoconnect** button, select a different communications port, and try again.

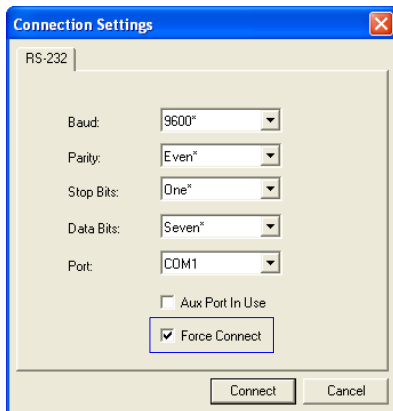

Note: If your RS-232 host settings cannot be changed to match the scanner's settings, select **Connect...** from the **Connect** menu in the menu toolbar, and then click the **Force Connect** box when you see the dialog shown at left.

Step 7 — Receive Settings

To copy the scanner's memory settings into **ESP**, right-click in the configuration window and select **Receive Reader Settings** from the dropdown menu.

Receive Reader Settings

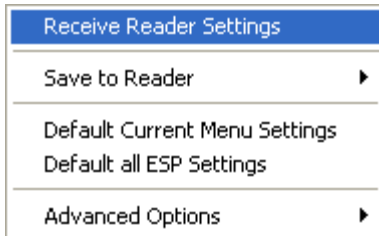

When you select **Receive Reader Settings**, the settings from the scanner's memory are sent to **ESP**.

Step 8 — Calibrate

1. Click the **Calibration** button in **EZ Mode** or in the **Calibration** view.

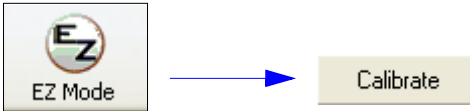

2. Allow some time for the scanner to cycle through the focus, gain, and tracking settings. Do not move or disturb the scanner or test symbol while calibration is in progress.
3. When calibration is complete, the settings that provided the highest read rate will be selected. You will see one of the following messages: **Calibration Passed**, **Calibration Failed**, or **Original Settings Were Optimal**.

Note: To silence the beeper, interrupt scanning by removing or blocking the test symbol, or send a **<K702,0>** command to disable the beeper.

If calibration fails, try the following:

1. Check the read range for your particular symbol density.
2. Examine symbol quality and try a different sample symbol.
3. Slightly skew or tilt the symbol or scanner to minimize specular reflection.
4. Verify that the correct symbology is enabled.

Step 9 — Test Read Rate

Important: To receive symbol data through the 9-pin configuration port, you must enable the port with the following command: **<K146,,1>**.

1. Position the symbol in front of an operational MS-890 scanner.
2. Click the **Utilities** button.
3. Click the **Start** button in the **Read Rate** view.

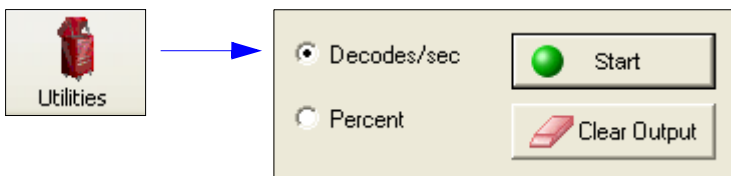

If calibration has passed, the scanner sends data to the host computer and emits a beep (if the beeper is enabled) for each good read.

Move your symbol toward the scanner and away from the scanner until the decode rates drop off in each direction. This will give you a sense of the depth of field (inner and outer ranges) for your symbol's density and range.

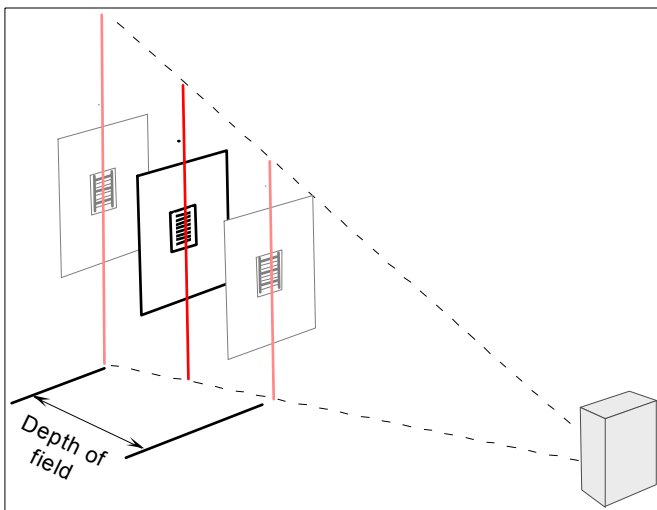

Note: If the scanner is in the default **Continuous Read** mode and not in read rate or calibration routine, it will read and beep repeatedly as long as a readable symbol remains in the read range and the read cycle configuration has not changed.

- To end the read rate test, right click **Read Rate** and select the **Stop** button.

Step 10 — Configure the Scanner in ESP

To make setup changes to the MS-890, click the **App Mode** button.

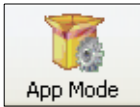

The following modes are accessible by clicking the buttons in the first row of **App Mode** icons:

- **Test** and **Calibrate** the scanner in **EZ Mode**.
- Establish communications between **ESP** and the scanner by clicking the **Autoconnect** button.
- Send or receive commands by clicking the **Send/Recv** button.
- Switch reader models by clicking the **Switch Model** button.
- Click the **Parameters** button to make changes to tree control settings.
- Click the **Setup** button to adjust and test scanner settings in Calibration, Raster Setup, Laser Framing, Configuration Database, Ordered Output, and Output Format.
- Access the **Terminal**, where you can view symbol data and enter serial commands.
- Review status settings or make changes to operational commands in **Utilities**.

Step 11 — Save Configuration in ESP

To make changes to a configuration setting:

1. **Left click** on the **+** to expand the desired tree.
2. **Double click** on the desired parameter and click once in the selection box to view options.
3. Place your cursor in the selection box, scroll down to the setting you want to change, and **click** once on the setting.

Parameters	ESP Values
[-] Communications	
[-] R5232/422 Host Port	
[-] R5232 Auxilliary Port	
[-] Aux/Config System Data	
[-] Preamble	Disabled*
Preamble Characters	Disabled*
[-] Postamble	Enabled
Response Timeout	2
LRC Status	Disabled
Intercharacter Delay	0

4. **Left click** again on the open screen to complete your selection.
5. **Right click** on the open screen and select **Save to Reader** to implement the command in the scanner.

Saving Options

- **Send, No Save.** Changes will be lost when power is re-applied to the scanner.
- **Send and Save.** This activates all changes in current memory *and* saves to the scanner for power-on.

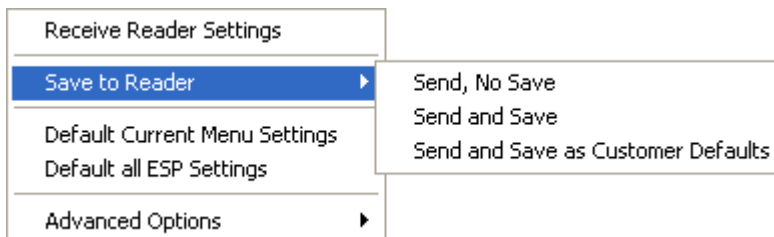

Save Configuration in ESP

2 Using ESP

Contents

EZ Mode.....	2-2
Application Mode.....	2-3
Menu Toolbar.....	2-4
Autoconnect.....	2-12
View.....	2-14
Navigating in ESP.....	2-15
Send/Receive Options.....	2-16

This section is designed to help you understand the basic structure and elements of **ESP** (Easy Setup Program).

When you open **ESP**, unless otherwise specified in the **ESP Preferences** dialog accessible from the **Options** heading on the menu toolbar, you will enter **EZ Mode** for initial setup.

From there, you can enter **Application Mode (App Mode)** and access several configuration menus (**Communications**, **Read Cycle**, **Symbologies**, **I/O Parameters**, **Symbol Quality**, **Matchcode**, and **Diagnostics**), a **Camera** setup interface, a **Terminal** interface, a **Utilities** interface, and an **Output Format** interface.

For **ESP** system requirements, see [System Requirements for ESP](#) in Chapter 1, [Quick Start](#).

Important: If you are switching from an **MS-880** to an **MS-890** in your application, follow these steps when you open **ESP**:

- With your MS-890 connected to the host computer, open your most recent MS-880 **.esp** file.
- Connect to the MS-890 and send all settings.
- Click the **Switch Model** button at the top of the **ESP** view. When you see the model menu, select the MS-890.
- Receive settings.

Note: After receiving settings, you can delete the previous MS-880 model by opening the **Model** dropdown menu from the menu toolbar, selecting **Remove Model**, and selecting **MS-880**.

EZ Mode

In **EZ Mode** you are presented with the **Locate**, **Calibrate**, and **Test** options. After connecting to your scanner, **EZ Mode** is the screen you will see. You will be provided with on-screen instructions that will help you with positioning, testing, and calibration.

Test

Click the **Test** button to start the Read Rate test for a quick indication of the scanner's read capabilities and the limits of your application. When **Decodes per Second** is unchecked, the test will count the percentage of decodes relative to the number of actual scans. Click **Stop** to end the test.

Calibrate

The calibration routine that will optimize the scanner by comparing Read Rates at various camera and image processing settings.

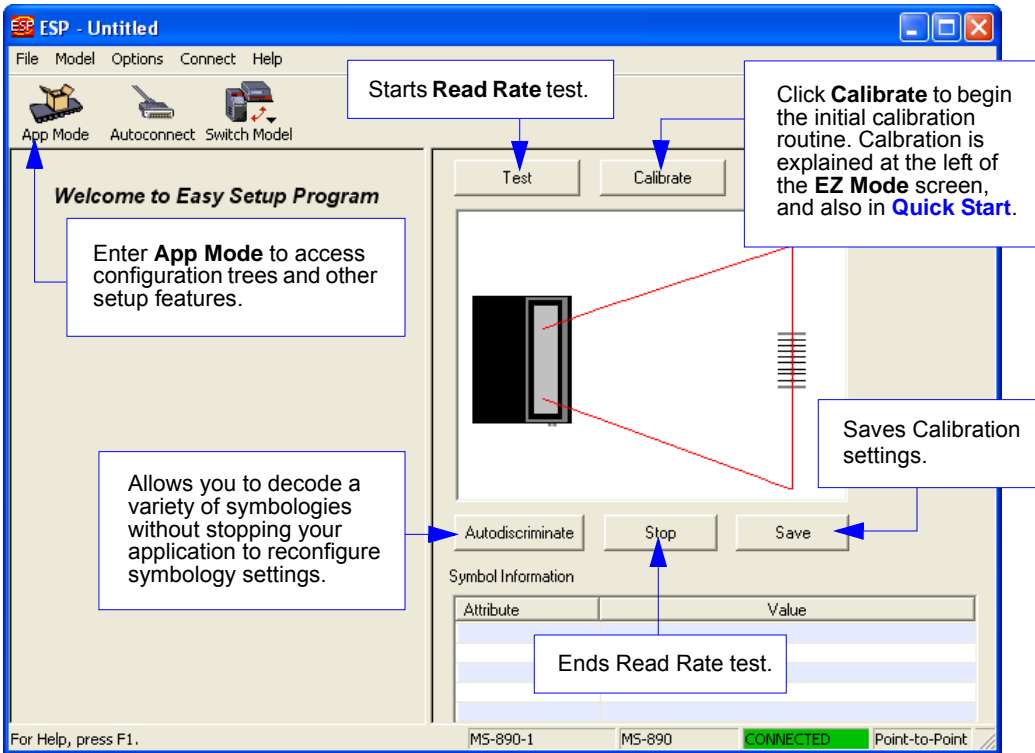

Application Mode

From **EZ Mode**, you can click on the **App Mode** button to access specific configuration menus, **Utilities** tools, **Camera** setup, **Output Format** options, and a **Terminal** window where serial commands can be entered.



Note: The **App Mode** and **EZ Mode** buttons appear in the same position to allow easy switching between these primary modes.

Click this icon to return to **EZ Mode**.

Menu toolbar.

Calibration, Raster/Laser, Terminal, Utilities.

Click here for **Ordered Output** and **Output Format** features.

Click on icons in this row to access configuration trees like the one shown here.

Click the **Configuration** button to return to full **App Mode** view from **Calibration, Raster/Laser, Terminal, Utilities, or Output Format**.

Parameters

- Communications
 - RS232/422 Host Port
 - Host Port Connections
 - Baud Rate
 - Parity
 - Stop Bits
 - Data Bits
 - Host Protocol
 - Address
 - ACK / NAK Options
 - Polling Mode Options
 - RS232 Auxiliary Port
 - Aux Port Connections
 - Aux Port Settings
 - Mode: Disabled
 - Daisy Chain ID Status: Disabled
 - Daisy Chain: 1 /
 - Aux/Config System Data
 - Preamble: Disabled
 - Preamble Characters: CR
 - Postamble: Enabled
 - Postamble Characters: CR LF
 - Response Timeout: 2
 - LRC Status: Disabled
 - Intercharacter Delay: 0

For Help, press F1. MS-890-1 MS-890 CONNECTED Point-to-Point | COM1 | 9600

Note: For specific information on any of the icons shown above in the operations bar or configuration bar, see the corresponding sections of this manual.

Menu Toolbar

File > New

Whenever **New** is selected, the default configuration of **ESP** is loaded.

Open/Save

When **Save** or **Save As** is selected, the **ESP** configuration is saved to the host computer's hard drive and available whenever the same file is selected under **Open**.

Important: When you save menu changes to your hard drive, these changes are not saved to your scanner. The illustration below shows how settings can be saved and received between **ESP** and the scanner, and **ESP** and the host hard drive.

File	
New	Ctrl+N
Open...	Ctrl+O
Save	Ctrl+S
Save As...	
Print...	Ctrl+P
Import...	
Export...	
Recent File	
Exit	

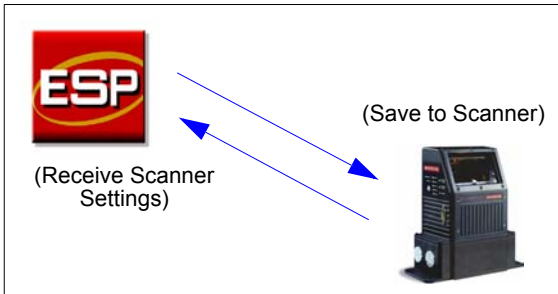

Import/Export

Import converts the ASCII settings from a text file to **ESP** configuration settings.

Export converts the active **ESP** configuration settings to an ASCII text file.

Model

In **Model** you can select any of the models shown in **ESP's** model menu. When you choose another model, your current connection to your present model will be terminated.

To connect to another model, select **New Model**, choose a new model from the menu, and click **OK**.

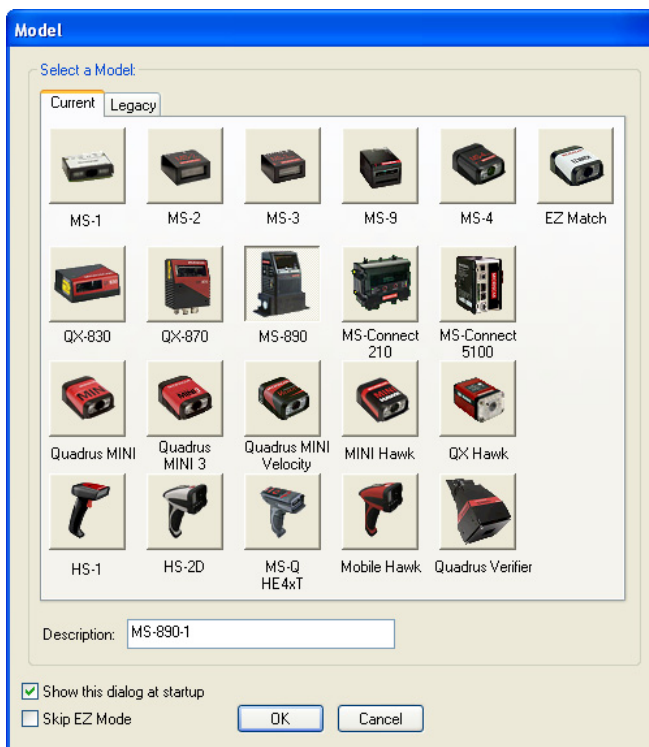
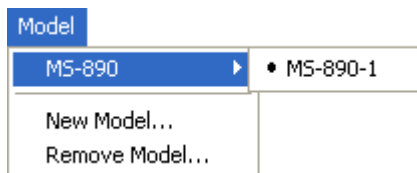

Note: All the models you have enabled by selecting will continue to appear in the Model menu and that the same menu is repeated when clicking the **Switch Model** icon.



When you save your **ESP** file, you will be saving the settings of all the models defined in a single **ESP** file.

Options

The **Options** menu allows you to save memos and set up **ESP Preferences**.

Note: Preferences will be saved and loaded into **ESP** whenever **ESP** is opened next, whether or not you save the **ESP** file.

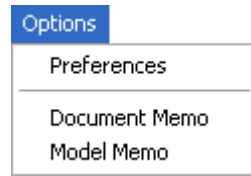

Preferences > General Tab

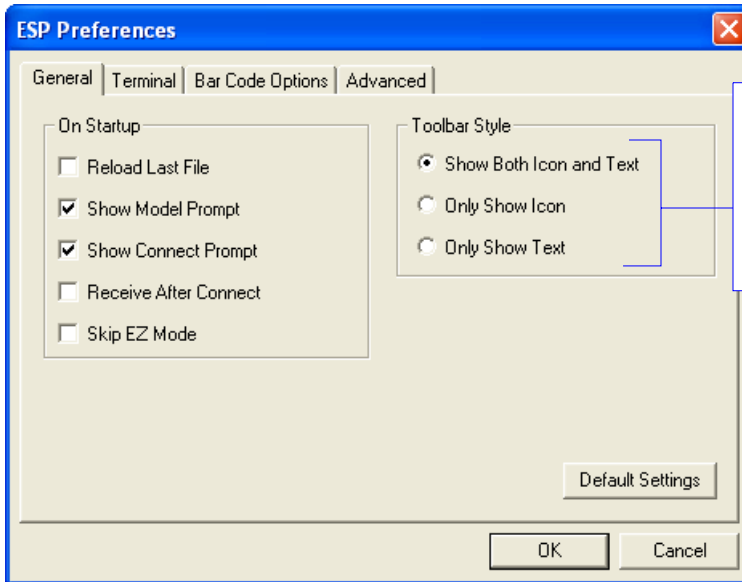

The **Toolbar Style** options allow you to determine how **ESP** will display the mode options in the two rows at the top of the screen.

Reload Last File

At startup, reloads the last file saved to the host computer's hard drive.

Show Model Prompt

At startup, shows the model menu displaying all supported readers.

Show Connect Prompt

At startup, displays the **Would you like to connect to the MS-890?** prompt.

Receive After Connect

At startup, loads the scanner's settings into **ESP**. (This is not recommended if you want to preserve your **ESP** settings for future use.)

Skip EZ Mode

At startup, skips **EZ Mode** and opens directly in **App Mode**.

Enable 'Send and Save as Customer Defaults'

At startup, enables the **Send and Save as Customer Defaults** option in the **Send/Recv** command.

Preferences > Terminal Tab

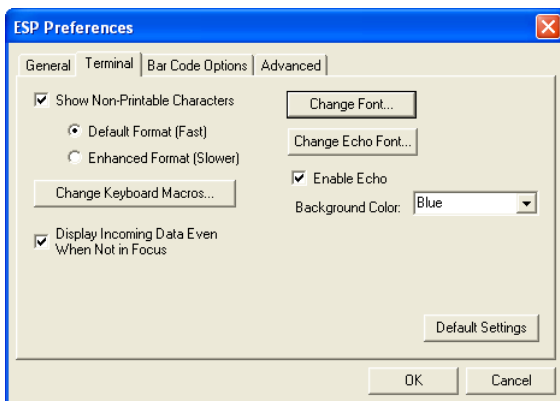

Show Non-Printable Characters

When **Show Non-Printable Characters** is enabled, characters such as “CRLF” will be displayed in the **Terminal** window. When **Enhanced Format** is checked, the characters are displayed with more detailed formatting.

Change Keyboard Macros

Clicking the **Change Keyboard Macros** button brings up the **Function Keys** dialog. In this dialog you can select the desired function key and then enter your macro keystrokes in the associated key map. For example, to make **Ctrl-F2** the keystroke to send a trigger character, select **F2**, then in the **Ctrl** row, enter **<trigger character>** and click **OK**. Then whenever the **Ctrl-F2** keystroke is pressed, the trigger character will start the read cycle.

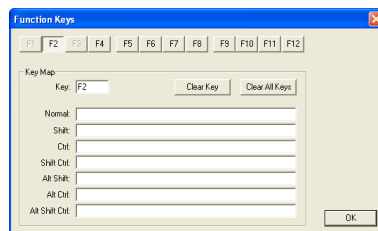

Note: The **F1** key is reserved for opening **ESP Help** and the **F3** key is reserved for the **Find Next** function.

Change Font

Allows you to modify the font used for decode data received from the scanner on the **Terminal** screen.

Change Echo Font

Allows you to modify the font used for command characters typed into the **Terminal** view.

Enable Echo

Allows you to enter command characters in **Terminal**.

Display Incoming Data Even When Not in Focus

When **Display Incoming Data Even When Not in Focus** is enabled, data from the scanner will continue to appear in the terminal even when **ESP** is not the top window.

Preferences > Bar Code Options Tab

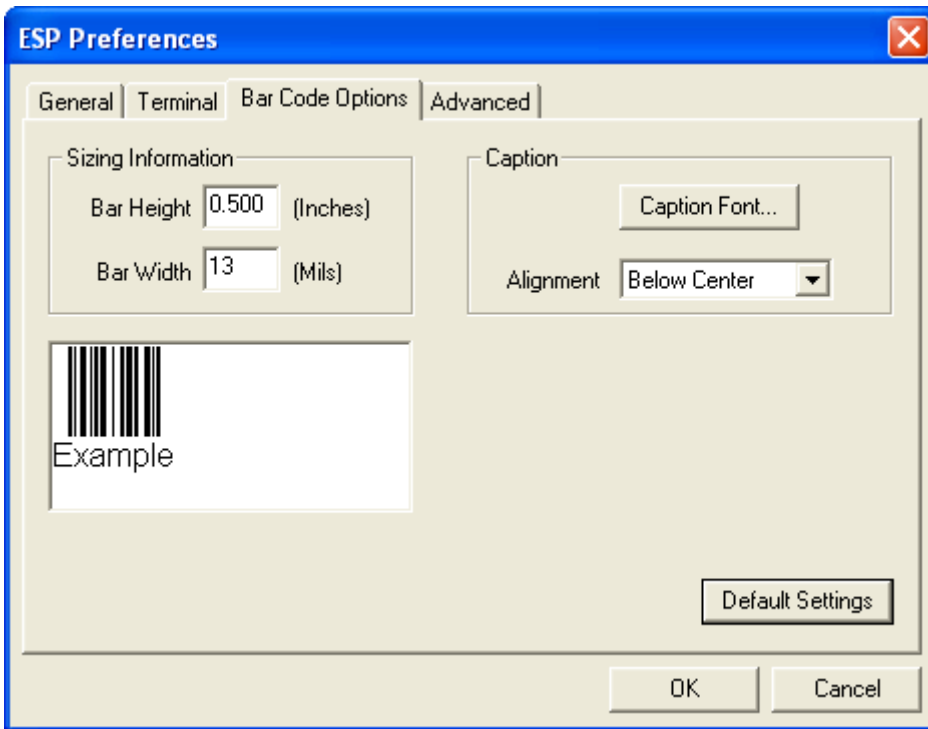

The **Bar Code Options** dialog allows you to set the size of user-created symbols.

Sizing Information

Sets the bar width or module width (in **mils**, or thousandths of an inch) of user-created symbols.

Example: A bar width of 13 is 0.013 inches.

Caption

Allows you to choose the font of human-readable captions (if symbol captions are required), and to determine the orientation of captions in relation to symbols.

Note: Symbols can be created using the [Bar Code Dialog](#).

Preferences > Advanced Tab

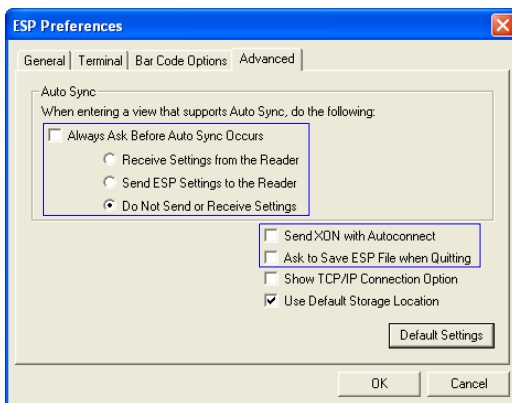

The **Auto Sync** options at the top of the **Advanced** tab allow you to determine whether Auto Sync will be enabled automatically in sections of **ESP** where it is used, or if it will ask you before it enables Auto Sync functions.

Always Ask Before Auto Sync Occurs

If you check this option box, you are then able to determine what specific Auto Sync functions will be enabled. **Receive Settings from the Reader** will automatically send the scanner's settings to **ESP** when Auto Sync is enabled. **Send ESP Settings to the Reader** will automatically send all scanner configuration settings chosen in **ESP** to the scanner. **Do Not Send or Receive Settings** creates a condition in which Auto Sync will not automatically send scanner settings to **ESP**, or send **ESP** settings to the scanner.

Send XON with Autoconnect

Sends an **XON (Begin Transmission)** command to the scanner before starting the **Autoconnect** routine.

Ask to Save ESP File when Quitting

When enabled, prompts the user to save a **.esp** file when ending a session.

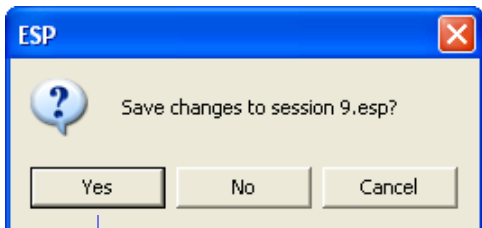

The **.esp** file will be saved in the location of your choice.

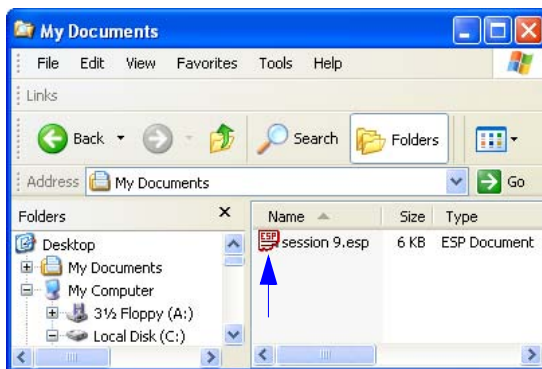

Preferences > Advanced Tab (cont.)

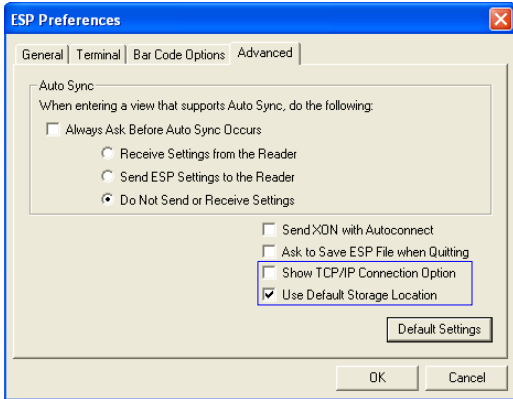

Show TCP/IP Connection Option

When enabled, shows a **TCP/IP** option on the **Select Protocol** dialog.

Note: This option should only be selected if you intend to connect using an Ethernet adapter.

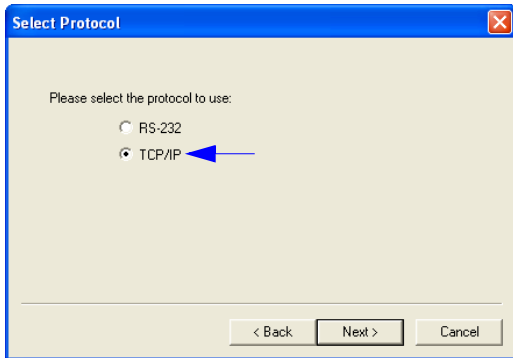

Use Default Storage Location

When enabled, automatically stores data in **ESP's** Application Data folder.

Document Memo

The information you type in the **Document Memo** field will appear in a context-sensitive text box whenever your cursor hovers over the **Document Memo** item on the **Options** menu.

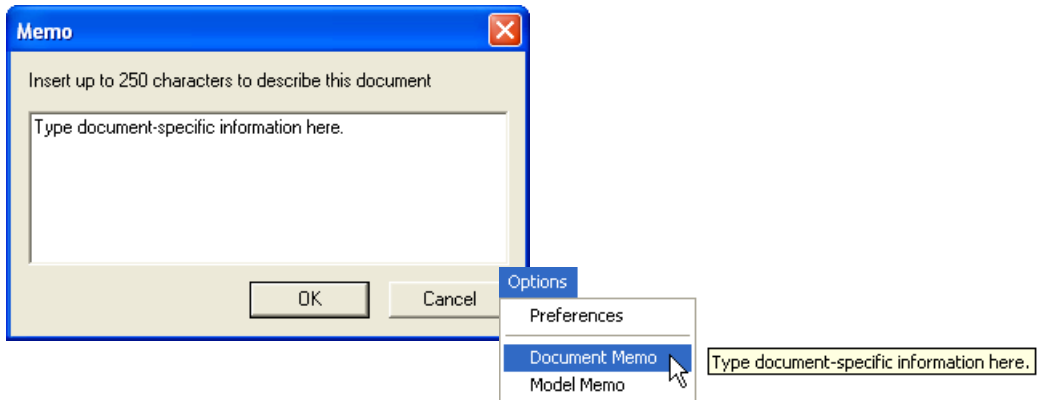

Model Memo

Similar to **Document Memo**, the information you type in the **Model Memo** field will appear in a context-sensitive text box whenever your cursor hovers over the **Model Memo** item on the **Options** menu. Memos created in **Model Memo** are specific to the model enabled when the message was created.

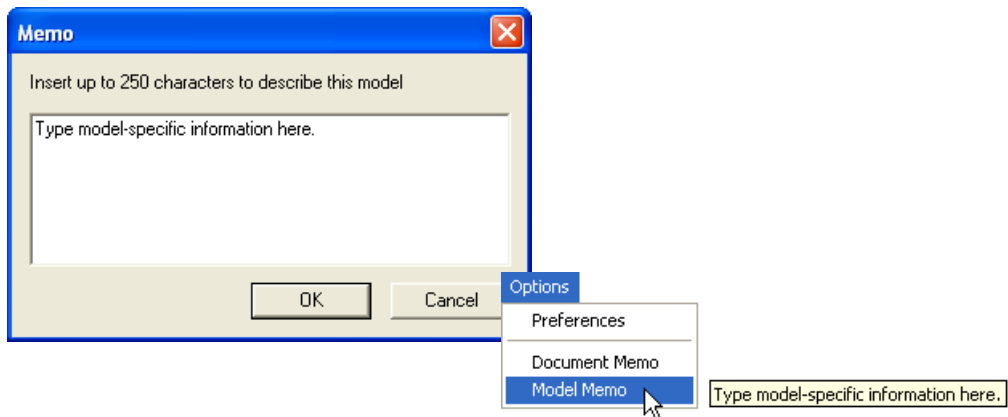

Note: Memos must be saved in a **.esp** file if you want them to be available in your next session. If you do not save your current session, any memos that you have entered during the session will be discarded, and will be unavailable in your next session.

Autoconnect

- You can use **Autoconnect** to establish a connection between the scanner and the host.

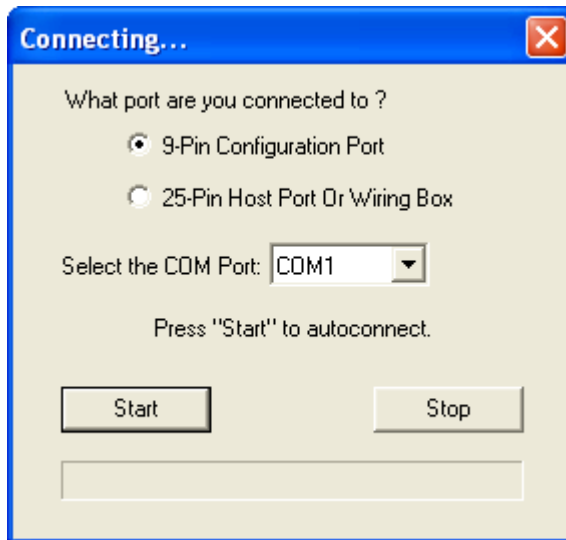

- If your communications port is not the default **COM1**, use the dropdown menu to change ports.

- Once you have chosen the correct port, click **Start** to connect.

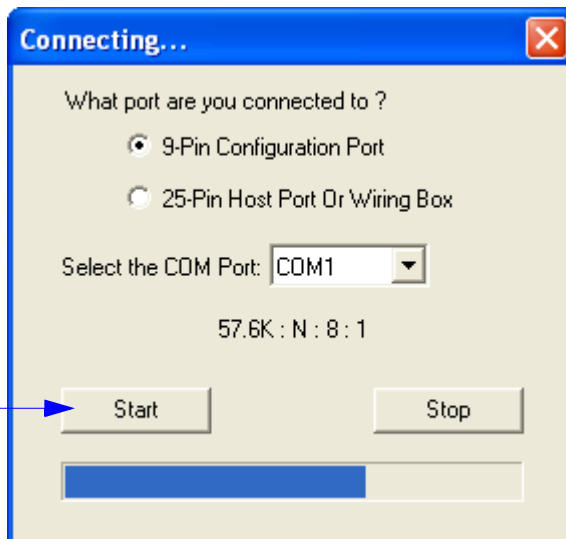

When you are connected, you will see the green connection indicator in the status bar at the bottom right of your screen:

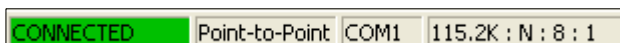

Autoconnect (cont.)

If your RS-232 host settings cannot be changed to match the scanner's settings:

- Click **Connect** on **ESP's** menu toolbar, and then select **Connection Wizard**.
- When the **Select Protocol** dialog appears, select **RS-232** and click **Next**.

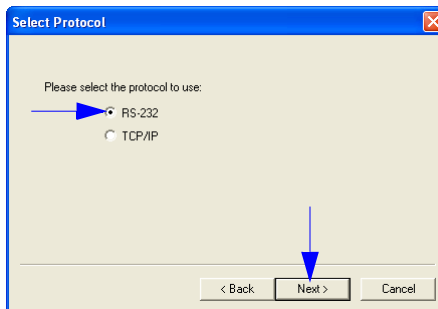

- When the **RS-232** dialog appears, check the **Force Connect** box and click the **Connect** button.

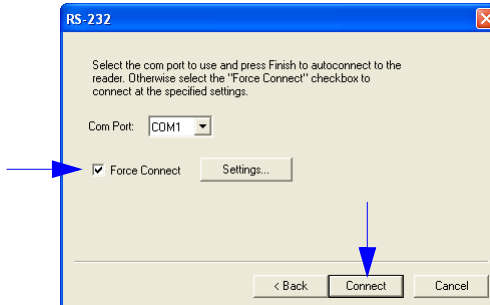

View

The **View** menu allows you to move quickly between interfaces without using the icon buttons on the **App Mode** toolbar. It also allows you to access the **Bar Code Dialog**.

Bar Code Dialog

In the **Bar Code Dialog** you can create symbols by typing the text you wish to encode. This is a useful tool for creating configuration symbols, allowing you to configure your scanner by reading the symbols you create.

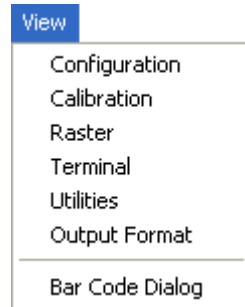

Bar Code Configuration

Print... Save As...

Bar Code Value < >

Rotation 0 Degrees New

Caption

Same As Bar Code Value

Specify

Add start configuration code

Add end configuration code; Save Settings

Differences from Default Settings

The symbols you create will be displayed in the field at the bottom of the Bar Code Dialog.

Drag configuration commands from the tree controls directly into this field to encode new symbols.

Create a caption for the symbol that matches the encoded data, or write your own caption.

Click the **Differences from Default Settings** button to create a symbol encoded with configuration settings that differ from **ESP** defaults. **Differences from Default** can be viewed on the **Differences** tab in the **Utilities** view. Click **Add start configuration code** and **Add end configuration code; Save Settings** to add a symbol that will enable **Bar Code Configuration** mode and a symbol that will save all new configuration settings. (Both symbols shown at left).

See **Bar Code Configuration** on page A-23 for more information about configuring the MS-890 by decoding symbols.

Navigating in ESP

To change scanner settings, or to access the **Calibration**, **Raster/Laser**, **Terminal**, **Utilities**, or **Output Format** views, click the **App Mode** button.



To return to EZ Mode, click the **EZ Mode** button.



To make changes to configuration settings in the tree controls:

1. **Left-click** on the + to expand menu items.
2. **Double-click** the desired parameter and **single-click** in the selection box to view options.
3. Place your cursor in the selection box, scroll down to the setting you want to change, and **single-click** the setting.

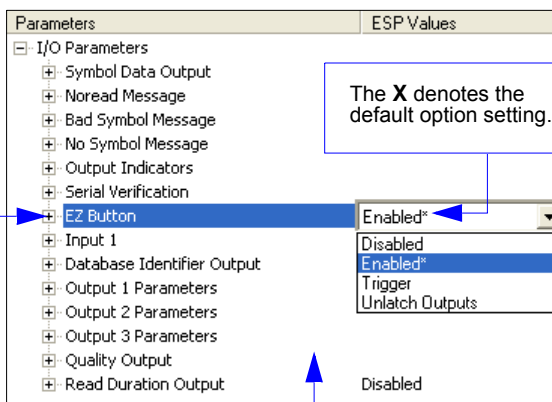

4. **Left-click** again on the open screen to complete the selection.
5. **Right-click** on the open screen and select **Save to Reader** to implement the command in the scanner. You can send the command without saving it, or you can send and save the command simultaneously.

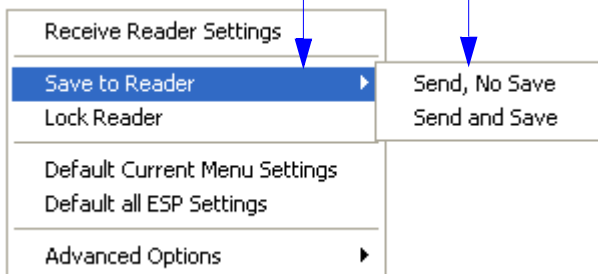

Send/Receive Options

To access **Receive**, **Save**, and **Default** options, click the **Send/Recv** button. You can also access these options by right-clicking in any of the configuration views.



Receiving

From the **Send/Recv** menu, select **Receive Reader Settings**.

Caution: Do not select this option if you do not want to upload the scanner's settings. For example, if your **ESP** file has a number of custom settings that you want to maintain and download into the scanner, these settings would be lost by choosing **Yes**.

This is useful if you want to receive (upload) the scanner's settings and save them as a file for future use. For example, if your scanner has settings that you do not want to change, choosing **Yes** would allow you to load those settings to **ESP** and save them in an **ESP** file for later retrieval.

Receiving the scanner's settings will also assure that you will not be subsequently saving any unwanted changes that you or someone else has made previously in **ESP**.

Saving

Send, No Save (<A>)

Saves **ESP** settings to current memory.

Send and Save (<Z>)

Activates all changes in current memory *and* saves to the scanner for power-on.

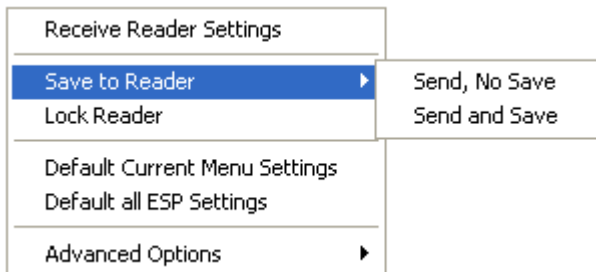

Send and Save as Customer Defaults (<Zc>)

Saves your default settings for quick retrieval.

This option will be visible only if you have checked **Enable 'Send and Save as Customer Defaults'** in **ESP Preferences**.

Defaulting

When you select **Default Current Menu Settings** or **Default all ESP Settings**, you are only defaulting the **ESP** settings.

Advanced Options

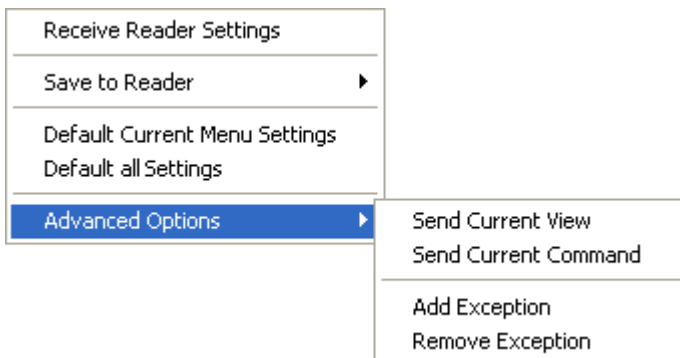

Send Current View

This is the same as **Save to Reader > Send No Save** except that only the commands in the current configuration tree are sent.

Send Current Command

This is the same as **Send Current View**, except that it saves only the command that is currently selected.

Add / Remove Exception

After you perform a **Receive Reader Settings** command¹ and you click on the **Add Exception** option, you may see a list of serial commands. These are commands that may be in your scanner's firmware, but not included in, or different from, your current version of **ESP**. You can edit these commands by double-clicking on them and changing them as needed. It is important to note that these commands will be saved to your scanner whenever you send a **Save to Reader** command, or an **<A>** or a **<Z>** command.

Also, if there is a corresponding **ESP** menu item, the **ESP Value** column for that item will be blank following a **Receive Reader Settings** command.

1. From the **Send/Recv** button or by right-clicking in any blank section of a tree control view.

3 Communications

Contents

Communications by ESP	3-2
Communications Serial Commands	3-2
RS-232/422 Host Port	3-3
Host Port Parameters	3-4
Host Protocol	3-5
Poll Address	3-7
ACK / NAK Options	3-8
Polling Mode Options	3-9
Auxiliary Port Protocol	3-10
Daisy Chain Autoconfigure	3-19
Daisy Chain Scanner ID	3-20
Auxiliary/Configuration Port System Data	3-21
Preamble	3-22
Postamble	3-23
LRC Status	3-24
Intercharacter Delay	3-25
Response Timeout	3-26

With Microscan's **ESP** (Easy Setup Program), configuration changes can be made in the **ESP** menus, then sent and saved to your scanner. The user can also send serial commands to the scanner via the **ESP's Terminal** window.

This section includes connecting parameters and options for communicating by the auxiliary port and various interfaces.

Note: When assigning characters in user-defined fields, the characters **NUL**, **<**, **>**, and **,** can only be entered through embedded menus, not through **ESP** or serial commands.

Note: Default settings for establishing communications are:

Baud =	9600
Parity =	Even
Stop Bits =	One
Data Bits =	Seven
Flow Control =	None

Communications by ESP

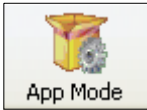

Click this button to bring up the **Applications** menu.



Click this button to bring up the **Communication** menu.

Parameters	ESP Values
[-] Communications	
+ R5232/422 Host Port	
+ R5232 Auxilliary Port	
+ Aux/Config System Data	
[-] Preamble	Disabled*
... Preamble Characters	Disabled*
+ Postamble	Enabled
... Response Timeout	2
... LRC Status	Disabled
... Intercharacter Delay	0

To open nested options, **single-click** the +.

To change a setting, **double-click** the setting and use your cursor to scroll through the options.

Communications Serial Commands

Command Title	Command Format
Host Port Parameters	<K100,baud,parity,stop bits,data bits>
Aux Port Protocol	<K101,aux port mode,baud rate,parity,stop bits,data bits,daisy chain ID status,daisy chain ID>
Host Protocol	<K140,protocol,address>
Preamble	<K141,status,preamble character(s)>
Postamble	<K142,status,postamble character(s)>
Response Timeout	<K143,timeout setting>
Intercharacter Delay	<K144,time interval>
LRC	<K145,status>
Auxiliary/Configuration Port System Data	<K146,aux port status,config port status>
ACK/NAK Options	<K147,RES,REQ,STX,ETX,ACK,NAK>
Polling Mode Options	<K148,RES,REQ,STX,ETX,ACK,NAK>
Daisy Chain Autoconfigure	<K150DAISY>
Daisy Chain Scanner ID	<K151,daisy chain scanner,daisy chain scanner ID>

RS-232/422 Host Port

Includes host port connections and host protocols.

Communications Options

You can communicate with the scanner through the following ports:

- 9-pin D-sub external connector
- Wiring box
- 25-pin D-sub external connector

Only one port can be used at a time to receive commands.

Communications with Host through the 9-pin Host Port

For the 9-pin configuration port, set the host communications settings as follows: **57.6K** baud, **8** data bits, **1** stop bits, and **None** parity. See Chapter 1, [Quick Start](#), for more information on using the 9-pin port.

Note: The 9-pin configuration port settings are not changeable.

Communications with Host through the 25-pin Port

The default 25-pin host port configuration settings are as follows: **9600**, **7**, **1**, and **Even**.

Making changes to these communications parameters without corresponding changes in linked device(s) can result in the loss of menu access. If this should occur, connect via the 9-pin port and reset your scanner's host parameters to match the 25-pin defaults.

Communications with Host through the Wiring Box

The settings are the same as those of the 25-pin port. See Chapter 14, [Wiring Box](#), for details on wiring connections.

Host Port Parameters

Important: This applies only to the **25-pin port** and **wiring box** connections (not for 9-pin port).

Note: See [Communications with Host through the 9-pin Host Port](#) on page 3-3 for 9-pin host port parameters.

Baud Rate (Host Port)

Usage: Can be used to transfer data faster or to match host port settings.

Definition: The rate at which the scanner and host transfer data back and forth.

Serial Cmd: <**K100**,*baud rate*,*parity*,*stop bits*,*data bits*>

Default: **9600**

Options:

0 = 600	1 = 1200	2 = 2400
3 = 4800	4 = 9600	5 = 19.2K
6 = 38.4K	7 = 57.6K	8 = 115.2K

Parity (Host Port)

Usage: Only changed if necessary to match host setting.

Definition: An error detection routine in which one data bit in each character is set to 1 or 0 so that the total number of 1 bits in the data field is even or odd.

Serial Cmd: <**K100**,*baud rate*,*parity*,*stop bits*,*data bits*>

Default: **Even**

Options: 0 = None 1 = Even 2 = Odd

Stop Bits (Host Port)

Usage: Only changed if necessary to match host setting.

Definition: One or two bits added to the end of each character to indicate the end of the character.

Serial Cmd: <**K100**,*baud rate*,*parity*,*stop bits*,*data bits*>

Default: **One**

Options: 0 = One 1 = Two

Data Bits (Host Port)

Usage: Only changed if necessary to match host setting.

Definition: Number of bits in each character.

Serial Cmd: <**K100**,*baud rate*,*parity*,*stop bits*,*data bits*>

Default: **Seven**

Options: 0 = Seven 1 = Eight

Host Protocol

Usage: In general, point-to-point protocols work well in most applications. They require no address and must use RS-232 or RS-422 communications standards.

Definition: Protocols define the sequence and format in which information is transferred between the scanner and the host, or in the case of **Polling Mode**, between scanners and a concentrator.

Important: When using Polling Mode, **LRC** must be **Enabled** and Preamble/Postamble must be **Disabled**.

Serial Cmd: <**K140,protocol**,address>

Default: **Point-to-Point**

Options:

- 0 = Point-to-Point
- 1 = Point-to-Point with RTS/CTS
- 2 = Point-to-Point with XON/XOFF
- 3 = Point-to-Point with RTS/CTS and XON/XOFF
- 4 = ACK/NAK
- 5 = Polling Mode

Point-to-Point (Standard)

Usage: Used only with RS-232 or RS-422.

Definition: Standard **Point-to-Point** requires no address and sends data to the host whenever it is available, without any request or handshake from the host.

Serial Cmd: <**K140,0**>

Point-to-Point with RTS/CTS

Usage: A scanner initiates a data transfer with an RTS (request-to-send) transmission. The host, when ready, responds with a CTS (clear-to-send) and the data is transmitted. CTS and RTS signals are transmitted over two dedicated wires as defined in the RS-232 standard.
Used only with RS-232.

Definition: **Point-to-Point with RTS/CTS** (request-to-send/clear-to-send) is a simple hardware handshaking protocol that allows a scanner to initiate data transfers to the host.

Serial Cmd: <**K140,1**>

Point-to-Point with XON/XOFF

Usage: If an **XOFF** has been received from the host, data will not be sent to the host until the host sends an **XON**. During the **XOFF** phase, the host is free to carry on other tasks and accept data from other devices.
Used only with RS-232.

Definition: This option enables the host to send the **XON** and **XOFF** command as a single byte transmission command of start (^Q) or stop (^S).

Serial Cmd: <K140,2>

Point-to-Point with RTS/CTS and XON/XOFF

Usage: Used only with RS-232.

Definition: This option is a combination of **Point-to-Point with RTS/CTS** and **Point-to-Point with XON/XOFF**.

Serial Cmd: <K140,3>

ACK/NAK

Definition: See the **ACK / NAK Options** command <K147> on page 3-8.

Serial Cmd: <K140,4>

Polling Mode

Definition: See the **Polling Mode Options** command <K148> on page 3-9.

Serial Cmd: <K140,5>

Poll Address

Serial Cmd: <**K140**,protocol,**address**>

Default: **1**

Options: 1 to 50

1 = Poll address 0x1C, Select address 0x1D

2 = Poll address 0x1E, Select address 0x1F

...

50 = Poll address 0x7E, Select address 0x7F

ACK / NAK Options

Definition: These parameters take effect for **ACK/NAK <K140,4>** on the main RS-232 or RS-422 ports (not on the Auxiliary Port), and are completely independent of the **Polling Mode Options <K148>**.

The scanner always follows the protocol in both directions (to and from the host). There is no option to disable it from either direction.

Serial Cmd: **<K147,RES,REQ,STX,ETX,ACK,NAK>**

RES-NAK Defaults

<i>RES: (Reset)</i>	0x00 (disabled)
<i>REQ: (Request)</i>	0x00 (disabled)
<i>STX: (Start of Text)</i>	0x00 (disabled)
<i>ETX: (End of Text)</i>	0x00 (disabled)
<i>ACK: (Acknowledge)</i>	0x06
<i>NAK: (Negative Acknowledge)</i>	0x15

The following are general outlines of the **ACK/NAK** protocol. Items that are framed by brackets ([]) can either be disabled or enabled. LRC does not include STX, but it does include preamble, postamble, and ETX.

Symbol Data Output

TX to host: [STX] [preamble] SYMBOL DATA [postamble] [ETX] [LRC]

Response from host: ACK/NAK. Sent when LRC, ETX, postamble, or timeout (waiting for more data) are detected (if REQ is disabled) depending on what is enabled.

Commands from Host to Scanner

TX to Scanner: [STX] <command> [ETX] [LRC]

Response from Scanner: ACK/NAK. Sent when LRC, ETX, or command-ending angle bracket '>' are received, depending on what is enabled.

Command Response from Scanner to Host

TX to host: [STX] [preamble] COMMAND RESPONSE DATA [postamble] [ETX] [LRC]

Response from host: ACK/NAK. Sent when LRC, ETX, postamble, command-ending angle bracket '>', or timeout (waiting for more data) are detected, depending on what is enabled.

As with **Polling Mode <K140,5>**, the scanner can optionally perform the REQ and RES event sequences in ACK/NAK mode. If the sender does not receive an ACK or NAK, it will send REQ to request such a response (if enabled). When the sender receives an ACK, too many NAKs, or times out (if already enabled), it will send a RES (if enabled) to terminate the transaction.

Polling Mode Options

Definition: These parameters only take effect for **Polling Mode <K140,5>** on the main RS-232 or RS-422 ports (not on the Auxiliary Port), and are completely independent of the **ACK/NAK Options <K147>**.

The values of protocol characters can be changed, but the protocol events cannot be disabled. The polling mode address is configured in the **<K140>** command (see **Poll Address** on page 3-7).

Serial Cmd: **<K148,RES,REQ,STX,ETX,ACK,NAK>**

RES-NAK Defaults

<i>RES: (Reset)</i>	0x04 (disabled)
<i>REQ: (Request)</i>	0x05 (disabled)
<i>STX: (Start of Text)</i>	0x02 (disabled)
<i>ETX: (End of Text)</i>	0x03 (disabled)
<i>ACK: (Acknowledge)</i>	0x06
<i>NAK: (Negative Acknowledge)</i>	0x15

Auxiliary Port Protocol

Note: The Aux Port cannot be used when the host port is set to **RS-422** or **Multidrop**.

As with the host port parameters, the auxiliary terminal's settings (baud rate, parity, stop bits, and data bits) must be identical with those of the auxiliary device.

Usage: These commands set the communication parameters with the auxiliary port which can be used to configure menus, send data to the host, display data transmissions originating from the host of the scanner, and relay data from other scanners set in tandem (Daisy-Chained). If the scanner's host port needs to be dedicated to the host, but configuration must be done on the fly, the auxiliary port can be set to accept configuration changes by Command Processing.

Definition: An auxiliary port connects the scanner to a remote display or to other scanners that can display or transfer data. As with the host port parameters, the auxiliary terminal's settings (baud rate, parity, stop bits, and data bits) must be identical to those of the auxiliary device.

Aux Port Mode

Note: The Aux Port interacts only with the host port via the 25-pin port except when in **Daisy Chain** mode. When in **Daisy Chain** mode, the Aux Port will also interact with the configuration port (9-pin port) or the wiring box network ports.

Definition: Determines the flow of data between the auxiliary port device(s), the scanner, and the host.

Serial Cmd: <**K101,aux port mode**,baud rate,parity,stop bits,data bits,daisy chain ID status,daisy chain ID>

Default: **Disabled**

Options:

- 0 = Disabled
- 1 = Transparent
- 2 = Half Duplex
- 3 = Full Duplex
- 4 = Daisy Chain
- 5 = Command Processing

Transparent (Aux Port Mode)

Usage: Often used in conjunction with handheld scanners. Employs an auxiliary readout to detect mis-applied symbols.

Definition: In **Transparent** mode data is passed between the auxiliary port and the host. The scanner buffers data from the auxiliary port and echoes the keyed data on the auxiliary port.

Data Initiated from the Auxiliary Port

Auxiliary port data is passed through to the host whenever a return key is pressed at the auxiliary port or symbol data is sent.

Whenever Aux Port data is sent with symbol data, the Aux Port data will appear between the preamble and the symbol data.

Auxiliary port data to the host is always sent with a preamble and a postamble.

If the scanner is in a polled mode to the host, auxiliary port data will still pass through.

<D> is the only command accepted by the scanner from the auxiliary port. All other commands will pass through to the host.

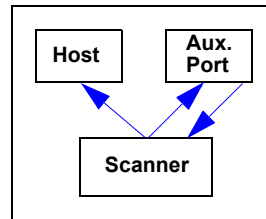

Data Initiated from the Scanner

Transmission to the auxiliary port occurs immediately upon a good read.

Scan data to the auxiliary port does not include a preamble or a postamble.

Communications with the auxiliary port is always in Point-to-Point protocol, even if the host is in a polled protocol mode.

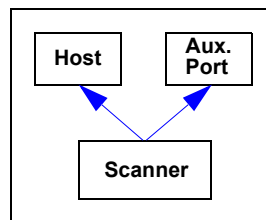

Data Initiated from the Host

All host data is echoed to the auxiliary port in unpolled and polled mode.

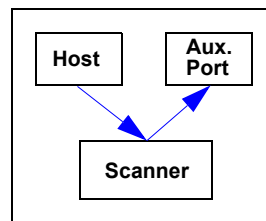

Serial Cmd: **<K101,aux port mode,baud rate,parity,stop bits,data bits,daisy chain ID status,daisy chain ID>**

1 = Transparent

Half Duplex (Aux Port Mode)

Usage: Used to display symbol data on an auxiliary screen close to the scanner.

Definition: In **Half Duplex** mode all auxiliary port data and symbol data is sent directly to the host. Symbol data is displayed on the auxiliary port screen at the same time the data is sent to the host.

Data Initiated from the Auxiliary Port

Auxiliary port data to the host is ignored if the scanner is in a polled mode.

Auxiliary port data or scanned data is sent to the host whenever it is received.

Auxiliary port data is not echoed.

Auxiliary port data to the host is always sent without a preamble or a postamble.

<D> is the only command that is accepted by the scanner from the auxiliary port. All other commands are passed through to the host.

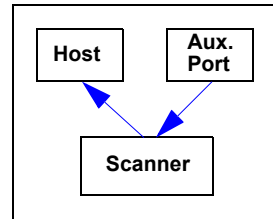

Data Initiated from the Scanner

Scan data is transmitted to the auxiliary port at the same time it is transmitted to the host.

Data transmission conforms with all parameters specified in the configuration menu (e.g., **Preamble**, **Postamble**, **End of Read Cycle**).

Data Initiated from the Host

All host data is echoed to the auxiliary port in unpolled mode.

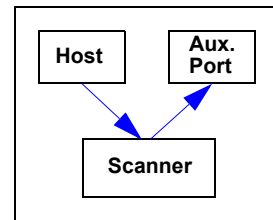
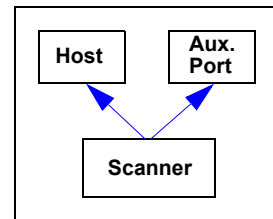

Serial Cmd: **<K101,aux port mode,baud rate,parity,stop bits,data bits,daisy chain ID status,daisy chain ID>**

2 = Half Duplex

Full Duplex (Aux Port Mode)

Usage: Used when communication to and from the auxiliary port is required.

Definition: In **Full Duplex** mode all auxiliary port data and symbol data is sent directly to the host. Symbol data is not displayed on the auxiliary port screen.

Data Initiated from the Auxiliary Port

Auxiliary port data to the host is ignored if the scanner is in a polled mode.

Auxiliary port data or scanned data is sent to the host whenever it is received.

Auxiliary port data is not echoed.

Auxiliary port data to the host is always sent without a preamble or a postamble.

<D> is the only command that is accepted by the scanner from the auxiliary port. All other commands are passed through to the host.

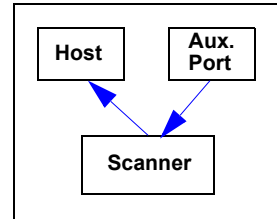

Data Initiated from the Scanner

Scan data is not sent to the auxiliary port.

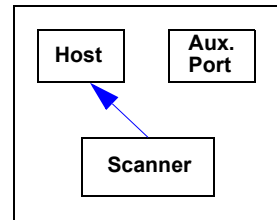

Data Initiated from the Host

All host data is echoed to the auxiliary port in unpolled mode.

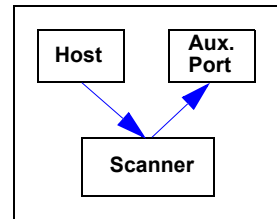

Serial Cmd: **<K101,aux port mode,baud rate,parity,stop bits,data bits,daisy chain ID status,daisy chain ID>**

3 = Full duplex

Daisy Chain (Aux Port Mode)

Note: See also [Daisy Chain Autoconfigure](#) on page 3-19.

Usage: **Used in applications where:**

A symbol might be scanned in both ladder and picket fence directions.
A symbol may be present on multiple sides of a package.
Symbols are presented at different depths.

Definition: In a daisy chain application, scanners are connected in series or “daisy chain” and decoded data is relayed from one scanner to another on up to the host.
A master scanner has its host port linked to the host computer and its auxiliary port linked to the host port of the first secondary scanner in the chain. Thereafter, each secondary’s auxiliary port is linked to the host port of the secondary that is further from the host in the daisy chain.
Each scanner in the daisy chain can be assigned an ID that accompanies any data that it sends.

Serial Cmd: <**K101,aux port mode**,baud rate,parity,stop bits,data bits,daisy chain ID status,daisy chain ID>

4 = Daisy Chain

Function: Before the master scanner times out, it checks its auxiliary port for data. It should be set to wait at least **20 ms** for each secondary in the daisy chain. (See [Read Cycle Timeout](#) on page 4-16.) If no data is received within the read cycle timeout, the master sends a No Read message to the host. Otherwise the complete data is sent.

If for example the master scanner is set to timeout in 120 ms, the first secondary scanner downstream might be set to 100 ms, the next to 80 ms, and so forth, thus assuring that at least 20 ms elapses between transmissions.^a

Daisy-chained scanners can send a series of symbols by enabling **Multisymbol** and a common multisymbol separator. If the master scanner does not receive the expected number of symbols, No Read messages are appended to the data string to make up the difference between the number of symbols enabled in **Multisymbol** and the number of symbols read.

For example, a master and two secondary scanners have **Number of Symbols** set to 3 and **Multisymbol Separator** defined as %. If the master and the first secondary scanner do not find symbols, but the next secondary scanner registers a good read, the transmitted results would be:

```
symbol data % No Read % No Read
```

a. The above example is based on the best case. Other factors such as baud rate, dynamic focus timing, number of characters in a given symbol, and the number of secondaries in the daisy chain can affect timing and may need to be included in your calculations for complete accuracy.

Daisy Chain (Aux Port Mode) (cont.)

Conditions: **The conditions for a daisy chain application are as follows:**

1. The master scanner's trigger must be Serial or External; the secondary scanners' triggers are configured for Serial.
2. All scanners are enabled to **Daisy Chain** mode.
3. Each scanner's auxiliary port must be connected to the Host port of its secondary scanner.
4. Each secondary scanner in the daisy chain must be set to send its data no less than **20 ms** before its preceding scanner.
5. All but the master scanner must have **Postamble** enabled and set to **CR (^M)** only.
6. All but the master scanner must have their No Read messages disabled.
7. If **Multisymbol** is enabled, **Multisymbol Separator** characters must match in all scanners and **Number of Symbols** must be set to number large enough to include all the symbols it may itself read plus the number of symbols that it will be expected to relay to the host or the next scanner up the line.
8. **Symbology ID** enable/disable must be the same in all scanners.
9. All but the master scanner must have their diagnostic warning messages disabled.
10. **Daisy Chain ID Status** enable/disable and the number of characters in **Daisy Chain ID** must be the same in all scanners.

Command Processing (Aux Port Mode)

Usage: Allows user to send configuration from the Host port or the Aux Port.

Definition: When enabled, **Command Processing** allows commands to be entered via the Aux Port. The following rules apply:

- Symbol data, including the serial trigger if used, will be transmitted to the last port from which a command was sent.
- If a reset occurs, all data will be transmitted to the host port.

Serial Cmd: <**K101,aux port mode**,baud rate,parity,stop bits,data bits,daisy chain ID status,daisy chain ID>

Options: **5 = Command Processing**

Baud Rate (Aux Port)

Usage: Can be used to transfer data faster or match an auxiliary device.

Definition: The rate at which the scanner and host transfer data back and forth.

Serial Cmd: <K101,aux port mode,baud rate,parity,stop bits,data bits,daisy chain ID status,daisy chain ID>

Default: 9600

Options:

- 1 = 1200
- 2 = 2400
- 3 = 4800
- 4 = 9600
- 5 = 19.2K
- 6 = 38.4K
- 7 = 57.6K
- 8 = 115.2K

Parity (Aux Port)

Usage: Only changed if necessary to match host setting.

Definition: An error detection routine in which one data bit in each character is set to 1 or 0 so that the total number of 1 bits in the data field is even or odd.

Serial Cmd: <K101,aux port mode,baud rate,parity,stop bits,data bits,daisy chain ID status,daisy chain ID>

Default: Even

Options: 0 = None 1 = Even 2 = Odd

Stop Bits (Aux Port)

Usage: Only changed if necessary to match host setting.

Definition: Allows the user to select the last one or two bits in each character to indicate the end of the character.

Serial Cmd: <K101,aux port mode,baud rate,parity,stop bits,data bits,daisy chain ID status,daisy chain ID>

Default: One

Options: 0 = One 1 = Two

Data Bits (Aux Port)

Usage: Only changed if necessary to match host setting.

Definition: Number of bits in each character.

Serial Cmd: <**K101**,aux port mode,baud rate,parity,stop bits,**data bits**,daisy chain ID status,daisy chain ID>

Default: **Seven**

Options: 0 = Seven 1 = Eight

Daisy Chain ID Status (Aux Port)

Note: Enable/disable and length must be the same in all scanners.

Usage: Used in a daisy chain setup in cases where the host needs to know which scanner in a daisy chain setup sent the data.

Definition: Each scanner in a daisy chain can be assigned a one or two character ID that will appear in front of decoded data and identify its source.

Serial Cmd: <**K101**,aux port mode,baud rate,parity,stop bits,data bits,**daisy chain ID status**,daisy chain ID>

Default: **Disabled**

Options: 0 = Disabled 1 = Enabled

Daisy Chain ID (Aux Port)

Note: All secondary scanners must be set to **Serial** for **Daisy Chain** to function.

See **Trigger** on page 4-5.

Usage: Used in a daisy chain setup in cases where the host needs to know which scanner sent the data.

Definition: A one or two character prefix which identifies the particular daisy chain scanner from which the data is being sent.

Serial Cmd: <**K101**,aux port mode,baud rate,parity,stop bits,data bits,daisy chain ID status,**daisy chain ID**>

Default: **1/**

Options: Any one or two ASCII characters.

Daisy Chain Autoconfigure

Note: This command is not available in **ESP**.

Usage: For quick setup and configuration of the daisy chain network.

Definition: **Daisy Chain Autoconfigure** is issued to the master scanner in the daisy chain and the software responds as follows:

- Counts the number of secondary scanners in the daisy chain.
- Assigns an internal ID number (1...n) to each secondary scanner, where the first secondary scanner is number 1 (and its own ID being a 0).
- Propagates the communications settings and the relevant operating modes of the master scanner to the host and auxiliary ports of each secondary scanner.
- Resets each secondary scanner.
- Verifies that each secondary scanner has acquired the new settings.

Serial Cmd: <**K150DAISY**>

When setting up a daisy chain operation, follow these steps:

1. Set the master (the scanner connected to the host) scanner to **Serial**.
This sets all the scanners in the daisy chain to **Serial** when the command is carried out.

Before **Autoconfigure** you must set the primary scanner to **Serial (S)**:

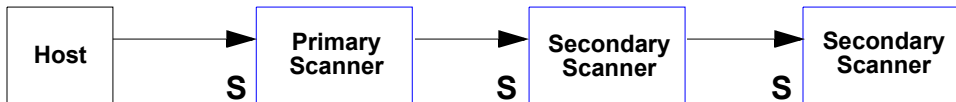

2. Send <**K150DAISY**> command.
3. If necessary, set the master scanner to **Edge**.

After **Autoconfigure** you may set the primary scanner to **Edge (E)**, but the other scanners must remain in **Serial (S)**:

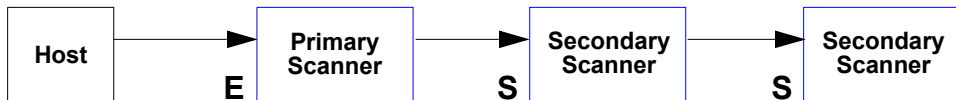

Daisy Chain Scanner ID

Note: Scanner IDs can also be assigned in [Daisy Chain \(Aux Port Mode\)](#) (page 3-14).

Usage: This command provides a convenient way to assign custom daisy chain IDs to specific scanners that were assigned during the daisy chain autoconfigure process.

Definition: Assigns a new daisy chain ID to a daisy chain secondary scanner. The command is sent to the master scanner to configure the other secondary scanners.

Scanner Number

Definition: Specifies the target scanner (by sequential number) which will be receiving the new daisy chain ID. The master scanner is always 0 (zero). All secondary scanners are numbered 1...n in the order that they are connected.

Note: These numbers are for assigning IDs only and are not changeable.

Serial Cmd: <**K151,daisy chain scanner #,daisy chain scanner ID**>

Options: 1....n (0 for the master scanner)

Scanner ID

Definition: A two-character user-defined ASCII message identifying a scanner in the daisy chain.

Serial Cmd: <**K151,daisy chain scanner #,scanner ID**>

Default: Sequential numbering of scanner units resulting from the **Daisy Chain Autoconfigure <K150DAISY>** command; for example: ID Master = **1/**; ID Scanner 1 = **2/**; ID Scanner 2 = **3/**; etc.

Options: Any two characters except **NUL**, **<**, **>**, or **,**.

Note: See also Chapter 13, [Output Format](#).

Note: After a secondary scanner accepts a new ID, it automatically invokes a reset-with-save command.

Auxiliary/Configuration Port System Data

Note: Do not use **Auxiliary Port** in a daisy chain operation.

Auxiliary Port Status

Note: This command only applies if **Auxiliary Port Mode** is set to **Command Processing**. See **Command Processing (Aux Port Mode)** on page 3-16.

Usage: To check symbol data and error messages via the Aux Port.

Definition: When enabled, system data, including decoded data and diagnostic warning messages, will be routed to the Aux Port.

Serial Cmd: <K146,aux port status,config port status>

Default: Disabled

Options: 0 = Disabled 1 = Enabled

Configuration Port Status

Usage: To check symbol data and error messages via the configuration port.

Definition: When enabled, system data, including decoded data and diagnostic warning messages, will be routed to the 9-pin configuration port.

Serial Cmd: <K146,aux port status,config port status>

Default: Enabled

Options: 0 = Disabled
1 = Enabled

Important: Enable **Data Out 9-Pin** when using the configuration port.

Preamble

Preamble Status

Usage: Used for identifying and controlling incoming data. For example, defining the **preamble** as a carriage return and a line feed causes each decoded message to be displayed on its own line.

Definition: Defines a one to four character data string that can be added to the front of the decoded data.

Serial Cmd: <**K141,status,preamble character(s)**>

Default: **Disabled**

Options: 0 = Disabled 1 = Enabled (within any protocol)

Preamble Character(s)

Serial Cmd: <**K141,status,preamble character(s)**>

Default: ^M corresponds to: **carriage return/NUL/NUL/NUL**.

Options: Up to four user-defined ASCII characters, including control characters.

Within a Serial Command

To enter control characters within a serial command, hold down the control key while typing the desired character.

Example: <**K141,1,CTRL-m**> to enter ^M

Within an Embedded Menu

Control characters entered on the command line are displayed in the menu as mnemonic characters, such as: <**CR><NUL><NUL><NUL>**.

To enter a control character from within an embedded menu, first type in a space (with the space key). This has the effect of allowing the control key to be recognized as a part of the control character. Next hold down the control key while typing the desired character.

Example: **Space CTRL-m** to enter ^M

Postamble

Postamble Status

Usage: Used for identifying and controlling incoming data. For example, defining the postamble as a carriage return and a line feed causes each decoded message to be displayed on its own line.

Definition: Defines a one- to four-character data string that can be added to the end of the decoded data.

Serial Cmd: <**K142,status,postamble character(s)**>

Default: **Enabled**

Options: 0 = Disabled 1 = Enabled

Postamble Character(s)

Serial Cmd: <**K142,status,postamble character(s)**>

Default: **^M^J** corresponds to **carriage return/line feed/NUL/NUL**, as displayed in the menu.

Options: Up to four user-defined ASCII characters, including control characters.

Within a Serial Command

To enter control characters within a serial command, hold down the control key while typing the desired character.

Example: <**K142,1,CTRL-m CTRL-j**> to enter **^M^J**.

Within an Embedded Menu

Control characters entered on the command line are displayed in the menu as mnemonic characters, such as: <**CR**><**LF**><**NUL**><**NUL**>

To enter a control character from within an embedded menu, first type in a space (with the space key). This has the effect of allowing the control key to be recognized as a part of the control character. Next hold down the control key while typing the desired character.

Example: **Space CTRL-m Space CTRL-j** to enter **^M^J**.

LRC Status

(Longitudinal Redundancy Check)

Usage: Used when extra data integrity is required.

Definition: An error-checking routine that verifies the accuracy of transmissions. It is the exclusive OR of all characters following the **STX** (start of text) up to and including the **ETX** (end of text). What this means is that the binary representation of all the characters in a transmissions are cumulatively added in a column and each resulting odd integer is assigned a 1 and each even integer a 0 (two 1s = 0, two 0s = 0, a 1 and a 0 = 1). The extra **LRC** character is then appended to the transmission and the receiver connected to the host port performs the same addition and compares the results.

Serial Cmd: <**K145,status**>

Default: **Disabled**

Options: 0 = Disabled 1 = Enabled

Intercharacter Delay

Usage: Used only when a host cannot receive data quickly enough and there is enough time between symbols to allow data to be completely transferred. It is rarely used since any setting other than zero will slow down communications. For example, a 200 setting will result in a 1/5 second delay between each character that is transmitted.

Definition: The time interval in milliseconds between individual characters transmitted from the scanner to the host.

Serial Cmd: <K144,intercharacter delay>

Default: 0

Options: 0 to 255 (in milliseconds)

Note: 0 causes no delay between characters.

Response Timeout

Usage: Used only when a response is required from the host. While in **Multidrop**, if the scanner does not receive an **ACK** or **NAK** from the host after sending polled data, it will act on a fault. The scanner can be set to wait indefinitely by setting **Response Timeout** to zero.

Definition: Time the scanner will wait before timing out if **ACK**, **NAK**, and **ETX** are enabled, and a host response is expected.

Serial Cmd: <**K143**,response timeout>

Default: **2** (x **10** = **20 ms**)

Options: 0 to 255 in 10 ms increments (0 to 2.55 seconds)
(A **0** setting causes an indefinite wait.)

4 Read Cycle

Contents

Read Cycle by ESP	4-2
Read Cycle Serial Commands	4-2
Multisymbol.....	4-3
Trigger	4-5
External Trigger State.....	4-11
Serial Trigger	4-12
Start Character (Non-Delimited).....	4-13
Stop Character (Non-Delimited)	4-13
End of Read Cycle.....	4-14
Good Decode Reads	4-17
Gain Settings	4-18
Focus.....	4-19
Scan Speed.....	4-20
Automatic Gain Control (AGC) Settings	4-21
Maximum Element.....	4-22
Tracking Adjustment.....	4-23

After you've established communications and completed basic read rate testing, you will need to address the spatial and timing parameters associated with your application. In a typical operation, a bar-coded item moves along a line past a scanner. A trigger or timer activates a read cycle during which the scanner actively searches for symbols. You will need to decide how to initiate the read cycle and how and when to end it.

Note: When assigning characters in user-defined fields, the characters **NUL**, **<**, **>**, and **,** can only be entered through embedded menus, not through **ESP** or serial commands.

Note: You can learn the current setting of any parameter by inserting a question mark after the number, as in **<K100?>**. To see all **K** commands, send **<K?>**.

Note on Serial Commands: To preserve continuity with other Microscan products, some serial configuration commands may include **0s** or **1s** as placeholders. In order for these commands to be implemented, the parameter values or a comma must be included.

Read Cycle by ESP

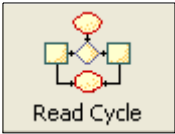

Click this button to bring up the **Read Cycle** menu.

To change a setting, **double-click** the setting and use your cursor to scroll through the options.

Parameters	ESP Values
[-] Read Cycle	
[+] Multisymbol	
[+] Trigger	
[+] Serial Trigger	
[+] End of Read Cycle	
[+] Decodes Before Output	
[+] Optoelectric Control	Disabled
[+] Reader Setup	
[-] Laser Setup	
Laser On/Off	Disabled
Laser Framing Status	Disabled*
Laser On Position	Disabled*
Laser Off Position	Enabled
[+] Raster Setup	

To open nested options, **single-click** the **+**.

Read Cycle Serial Commands

Command Title	Command Format
Trigger	<K200,trigger mode,trigger filter duration>
Serial Trigger Character	<K201,trigger character>
External Trigger State	<K202,external trigger state>
End of Read Cycle	<K220,end of read cycle mode,read cycle timeout>
Good Decode Reads	<K221,number before output,mode>
Multisymbol	<K222,number of symbols,multisymbol separator>
Start Serial Trigger Character	<K229,start trigger character>
End Serial Trigger Character	<K230,end trigger character>
Scan Speed	<K500,scan speed>
Maximum Element	<K502,maximum element>
Gain Settings	<K504,gain adjustment,AGC mode>
AGC Settings	<K505,symbol detect status,minimum number of transitions>
Focus	<K508,focus position>
Tracking Adjustment	<K520,tracking adjustment>

Multisymbol

Usage: **Multisymbol** is commonly used in shipping applications where a shipping symbol contains individual symbols for part number, quantity, etc. This feature allows one trigger to pick up all the symbols. AIAG and EAN-128 are two application standards that address this need.

Definition: **Multisymbol** allows the user to define up to 12 symbols that can be read in a single read cycle.

Conditions: **The following conditions apply:**

1. Each symbol must be different to be read unless they appear in the scan line at the same time.
2. The maximum number of characters in a read cycle is 32520 for all symbols.
3. The maximum number of characters the scanner can transmit is calculated by: Preamble + maximum number of symbols * (aux id + symbology id + maximum symbol length + quality output + ((number of insertion cells x cell length)+ separator) + postamble + LRC = 37425.
4. All No Read messages are posted at the end of the data string.
5. If more than one symbol is within the scan beam at the same time, symbol data may not be displayed in the order of appearance.
6. If **Matchcode Type** is set to **Sequential** or if **Trigger** is set to **Continuous Read 1 Output**, **Number of Symbols** will default to 1 (if set to any number greater than 1).

Number of Symbols

Definition: **Number of Symbols** is the number of different symbols that can be read in a single read cycle.

Conditions: **The following conditions apply:**

1. When Number of Symbols is set to Single, the read cycle ends when one symbol is decoded and output.
2. When **Number of Symbols** is set to **Multiple**, all decoded symbol data (for both the same and different symbols) are output while the read cycle is active and/or no timeout has occurred.

Serial Cmd: <K222,number of symbols,multisymbol separator>

Default: 1

Options 1 to 12

Multisymbol Separator

Usage: Used to delimit or separate data fields with a user defined character.

Definition: The character that's inserted between each symbol scanned when **Multisymbol** is set to any number greater than 1.

ESP: To select a new multisymbol separator, double-click on **Separator** and select a character in the popup window.

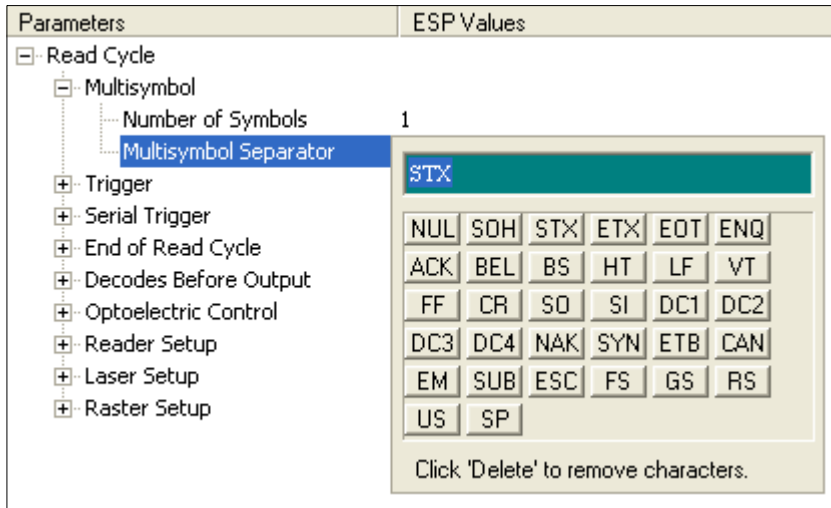

Serial Cmd: <**K222**,number of symbols,**multisymbol separator**>

Note: If **Multisymbol Separator** has been changed to any character other than the default comma and you wish to re-define the separator as a comma, use **ESP** or the embedded menu.

Default: , (comma)

Options: Any available ASCII character, except **NUL**, <, >, and , .

Trigger

Trigger Mode

Note: When doing calibration or read rate testing, the current trigger setting will be disregarded.

Note: This command does not need to be followed by an **<A>** command.

Definition: The type of trigger event that will initiate the read cycle.

Serial Cmd: **<K200,trigger mode,trigger filter duration>**

Default: **Continuous Read**

Options:

- 0 = Continuous Read
- 1 = Continuous Read 1 Output
- 2 = External Level
- 3 = External Edge
- 4 = Serial Data
- 5 = Serial Data and External Edge

Continuous Read

Usage: **Continuous Read** is useful in testing symbol readability or scanner functions. It is not recommended for normal operations.

Definition: In **Continuous Read**, trigger input options are disabled, the scanner is always in the read cycle, and it will attempt to decode and output every scan crossing a symbol. **When To Output** and **No Read** options have no effect on **Continuous Read**.

Serial Cmd: **<K200,0>**

Continuous Read 1 Output

Usage: **Continuous Read 1 Output** can be useful in applications where it is not feasible to use a trigger and all succeeding symbols contain different information. It is also effective in applications where the objects are hand-presented.

Definition: In **Continuous Read 1 Output** the scanner self-triggers whenever it decodes a new symbol or a timeout occurs.

If **End Of Read Cycle** is set to **Timeout** and the symbol doesn't change, the scanner will repeat the output at the end of each timeout period. For example, if **Timeout** is set to one second, the scanner sends the symbol data immediately and repeats the output at intervals of one second for as long as the symbol continues to be scanned.

If **End Of Read Cycle** is set to **New Trigger**, the scanner will send the current symbol data immediately, but send it only once. A new symbol appearing in the scanner's range will be read and sent immediately provided it is not identical to the previous symbol read.

Serial Cmd: <K200,1>

Caution: In automated environments, **Continuous Read 1 Output** is not recommended because there is no one to verify that a symbol was missed.

Note: If **Trigger** is set to **Continuous Read 1 Output**, **Number of Symbols** will default back to 1 (if set to any number greater than 1).

External Trigger Level

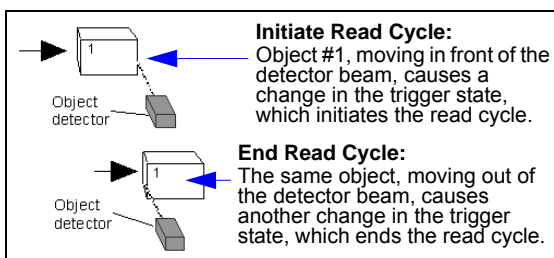

Usage: This mode is effective in an application where the speeds of the conveying apparatus are variable and the time the scanner spends scanning each object is not predictable. It also allows the user to determine if a No Read has occurred.

Definition: **External Level** allows the read cycle to begin when a trigger (change of state) from an external sensing device is received. The read cycle endures until the object moves out of the sensor range and the active trigger state changes again.

Serial Cmd: <K200,2>

Important: **Level** and **Edge** apply to the active logic state (**Open** or **Closed**) that exists while the object is in a read cycle, between the rising edge and falling edge. *Rising edge* is the trigger signal associated with the appearance of an object. *Falling edge* is the trigger signal associated with the subsequent disappearance of the object.

Note: In **External Trigger Level**, sending a non-delimited start serial character will start a read cycle and sending a non-delimited stop serial character will end it. See **Start Character (Non-Delimited)** and **Stop Character (Non-Delimited)** on page 4-13.

External Trigger Edge

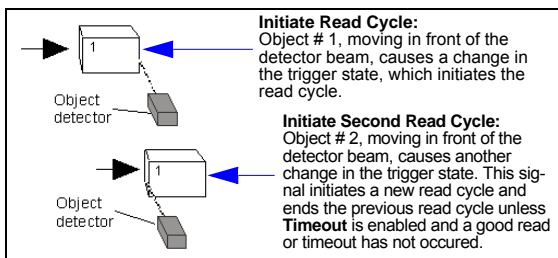

Usage: This mode is highly recommended in any application where conveying speed is constant or if spacing, object size, or timeouts are consistent.

Definition: **External Trigger Edge**, as with **Level**, allows the read cycle to begin when a trigger (change of state) from an external sensing device is received. However, the passing of an object out of sensor range does not end the read cycle. The read cycle ends with a good read output or, depending on **End of Read Cycle** setting, a timeout or new trigger occurs. **External Trigger Edge**, as with **Level**, allows the read cycle to begin when a trigger (change of state) from an external sensing device is received. However, the passing of an object out of sensor range does not end the read cycle. The read cycle ends with a good read or with a No Read when a **No Decode Timeout** occurs.

Serial Cmd: <K200,3>

Important: **Level** and **Edge** apply to the active logic state (**Open** or **Closed**) that exists while the object is in a read cycle, between the rising edge and falling edge. *Rising edge* is the trigger signal associated with the appearance of an object. *Falling edge* is the trigger signal associated with the subsequent disappearance of the object.

Note: In **External Trigger Level**, sending a non-delimited start serial character will start a read cycle and sending a non-delimited stop serial character will end it. See **Start Character (Non-Delimited)** and **Stop Character (Non-Delimited)** on page 4-13.

Serial Data

Usage: **Serial Data** is effective in a highly controlled environment where the host knows precisely when the object is in the scan zone. It is also useful in determining if a No Read has occurred.

Definition: In **Serial Data**, the scanner accepts an ASCII character from the host or controlling device as a trigger to start a read cycle. A **Serial Data** trigger behaves the same as an **External Edge** trigger.

Serial Cmd: <K200,4>

Serial Data and External Edge

Usage: **Serial Data and External Edge** is seldom used but can be useful in an application that primarily uses an external sensing device but occasionally needs to be manually triggered. An auxiliary terminal can be connected to the Aux Port so the user can send the serial trigger character through the scanner to the host.

Definition: In this mode the scanner accepts either a serial ASCII character or an external trigger pulse to start the read cycle.

Serial Cmd: <K200,5>

Trigger Filter Duration

Usage: **Trigger Filter Duration** is useful where trigger bounce could cause false triggers.

Definition: **Trigger Filter Duration** can prevent trigger bounce from falsely triggering the scanner by limiting the time in which trigger pulses can be received.

Serial Cmd: <**K200**,*trigger mode*,**trigger filter duration**>

Default: **320** (10 ms)

Options: 0 to 65535 (0 to 2.047s in 31.25 μ s steps)

External Trigger State

Note: **External Level**, **External Edge**, or **Serial Data and External Edge** trigger mode must be enabled for **External Trigger** to take effect.

Usage: Users can select the trigger state that will operate with their systems. (If using an object detector, use **Active Closed**.)

Definition: When enabled for **Active Closed** the triggering device imposes a current on the optoisolator to activate the read cycle. When enabled for **Active Open** the triggering device interrupts the current to the optoisolator to activate the read cycle.

Serial Cmd: <**K202,external trigger state**>

Default: **Active closed**

Options: 0 = Active open 1 = Active closed

Serial Trigger

Usage: Useful in applications where a read cycle needs to be initiated and/or ended by user-defined serial characters.

Definition: An online host command composed of a single ASCII host serial trigger character that initiates or ends the read cycle.
Trigger characters are of two types: delimited and non-delimited. A delimited character is enclosed within angle bracket delimiters **< >**.
A non-delimited trigger character is one that either starts or ends the read cycle and is NOT enclosed by delimiters such as **< >**.

Rules for Trigger Modes

- In **External Edge** the scanner looks only for the **Start Trigger Character** and ignores any **End Trigger Character** that may be defined.
- In **External Level**, the **Start Trigger Character** begins the read cycle and an **End Trigger Character** ends it. Note that even after a symbol has been decoded and the data transmitted, the scanner remains in External Level trigger read cycle until a **Stop** character is received.
- In **Serial Data and External Edge** trigger mode, command, either a **Start Trigger Character** or a hardware trigger can start an **Edge** trigger read cycle.

Serial Trigger Character (Delimited)

Usage: Useful in applications where a single serial character enclosed in angle brackets initiates the read cycle.

Definition: A delimited trigger character is one that starts the read cycle, is enclosed by delimiters such as **< >**, and can only be sent when the trigger mode is set to **Serial Data** or **Serial Data and External Edge**.

Serial Cmd: **<K201,serial trigger character>**

Default: **^]** (corresponds to **<GS>** displayed in the embedded menu)

Options: Any single ASCII character, including control characters, except **NUL (00** in hex), an existing host command character, or an online protocol character. Control characters entered on the command line are displayed in the menu as mnemonic characters.

Note: **Serial Data** or **Serial Data and External Edge** triggering mode must be enabled for Serial Trigger Character to take effect.

Start Character (Non-Delimited)

Usage: Useful in applications where a different character is required to start a read cycle. Works with **External Edge**, **External Level**, and **Serial Data and External Edge**.

Definition: A single ASCII host serial trigger character that starts the read cycle and is not enclosed by delimiters such as < and >.

Serial Cmd: <**K229**,*start trigger character*>

Default: **NUL** (disabled)

Options: Two hex digits representing an ASCII character except <, >, **XON**, and **XOFF**.

Stop Character (Non-Delimited)

Usage: Useful in applications where a different character is required to end a read cycle. Works with **External Level** only.

Definition: A single ASCII host serial trigger character that ends the read cycle and is not enclosed by delimiters such as < and >.

Serial Cmd: <**K230**,*stop trigger character*>

Default: **NUL** (disabled)

Options: Two hex digits representing an ASCII character except <, >, **XON**, and **XOFF**.

End of Read Cycle

Note: When to Output must be set to **End of Read Cycle** before this command can be active.

Definition: The read cycle is the time during which the scanner will attempt to read and decode a symbol. At the end of a read cycle the scanner stops reading symbols and sends the symbol data or No Read message to the host.

End of Read Cycle Mode

Definition: A read cycle can be terminated by a new trigger, a timeout, or a combination of both.

Serial Cmd: <**K220, end of read cycle, read cycle timeout**>

Default: **Timeout**

Options: 0 = Timeout 1 = New Trigger 2 = Timeout and New Trigger

Note: When operating in **Continuous Read** or **Continuous Read 1 Output**, the scanner is always in the read cycle.

Timeout

Usage: Typically used with **Serial** or **Edge** and **Continuous One**.
It is effective in highly controlled applications when the maximum length of time between objects can be predicted. It assures that a read cycle ends before the next bar-coded object appears, giving the system extra time to decode and transmit the data to the host.

Definition: **Timeout** ends the read cycle when the time set in **Read Cycle Timeout** elapses or “times out.”

If in **Continuous Read 1 Output**, a timeout initiates a new read cycle and allows the same symbol to be read again.

With either **External Edge**, **Serial Data**, or **Serial Data and External Edge** enabled, a timeout ends the read cycle and symbol data or a No Read message is sent to the host.

With **External Level** enabled, the read cycle does not end until the falling edge trigger or a timeout occurs. The next read cycle does not begin until the next rising edge trigger.

New Trigger

Usage: **New Trigger** is an effective way to end a read cycle when objects move past the scanner at irregular intervals (not timing-dependent).

Definition: **New Trigger** ends the current read cycle and initiates a new one when a new trigger occurs. **New Trigger** refers only to a “rising edge” trigger.

With either **External Edge**, **Serial**, or **Serial or Edge** enabled, an edge or serial trigger ends a read cycle and initiates the next read cycle.

In the case of **External Level**, a falling edge trigger ends the read cycle but the next read cycle does not begin until the occurrence of the next rising edge trigger.

Note: When **New Trigger** is enabled and if not in **External Level** mode, **Laser On/Off** will have no effect. When No Reads occur, the laser will remain on.

Timeout and New Trigger

Usage: Useful in applications that require an alternative way to end the read cycle. For example, if an assembly line should stop completely or the intervals between objects are highly irregular.

Definition: **Timeout and New Trigger** is identical to **Timeout**, except that a timeout or a new trigger (whichever occurs first) ends the read cycle.

Read Cycle Timeout

Usage: Useful in many tightly controlled applications which require a read cycle to end before the next object appears and therefore need the flexibility of a timeout adjustment.

Definition: **Read Cycle Timeout** is the time span of the read cycle and is represented in 10 ms increments. It is used in conjunction with **External Edge** or **Serial Trigger**.

Serial Cmd: <**K220**,end of read cycle,**read cycle timeout**>

Default: **100** (x 10 ms)

Options: 0 to 65535. (Divide any positive number entered by 100 to determine the time in seconds.)

Note: A minimum setting of **2** is recommended.

Note: **Timeout** or **Timeout or New Trigger** under **End of Read Cycle** must be enabled for **Read Cycle Timeout** to take effect.

Good Decode Reads

Usage: This is a very useful feature to increase reliability of reads for symbologies that do not have internal error checking such as Pharmacode.

Definition: The number of decodes (from 1 to 31) required per symbol before a symbol's decoded data is sent. It requires the scanner to successfully decode a symbol a designated number of times (not necessarily consecutively) before it is sent. If it doesn't achieve the number of good reads during the read cycle, then a No Read will be sent.

Note: Higher settings will decrease throughput speed.

Serial Cmd: <K221,good decode reads,mode>

Default: 1

Options: 1 to 31

Good Decode Output Mode

Definition: Affects how the scanner counts symbols that it reads successfully.

Serial Cmd: <K221,good decode reads,mode>

Default: **Non-Consecutive**

Options: 0 = Non-Consecutive
1 = Consecutive

Gain Settings

The settings in this section are typically adjusted by Calibration, or by qualified technicians. They are included here for special applications. Before making changes to individual commands in this section, it would be advisable to make a written record of current settings.

Gain Adjustment

Usage: Can be useful for fine-tuning gain or when portions of analog signals spike as in the case of specular reflection or extraneous noise.

Caution: Changes to Gain are typically done by qualified technicians in **Calibration**. See Chapter 9, **Calibration**.

Definition: Sets a voltage amplitude value for the analog circuitry.

Serial Cmd: <**K504,gain adjustment,AGC mode**>

Default: Default is **40** (nominal). **Gain** is optimized at the factory before shipment; the default value may not be 40.

Options: 0 to 255

AGC Mode

Definition: Tracks peak signals and selects an amplitude reference point to sample the analog signals for converting to digital.

Serial Cmd: <**K504,gain adjustment,AGC mode**>

Default: **Disabled**

Options: 0 = Disabled
1 = Enabled

Focus

Focus is generally set during the **Calibration** routine (see Chapter 9, **Calibration**). However, in certain applications involving specific focal lengths, manual control of focus may be appropriate.

Focus Position

Definition: Allows the user to change the focus position setting.

Serial Cmd: <**K508**,*focus position*>

Default: **0**

Options: 0 to 40

Scan Speed

Definition: Allows the user to set the number of scans per second by controlling the spinning mirror motor speed.

Serial Cmd: <**K500,scan speed**>

Default: **400**

Options: 400 to 1000

Automatic Gain Control (AGC) Settings

Important: AGC settings apply to both AGC and symbol detection.

Symbol Detect Status

Usage: During the read cycle, the scanner counts the number of bar and space transitions defined in the **Transition Counter**. If the count matches or exceeds the threshold, the scanner will perform AGC routines.

Definition: AGC is the acronym for Automatic Gain Control. AGC increases the depth of field by attempting to maintain signal strength at a constant level regardless of the range of the symbol.

Serial Cmd: <**K505, symbol detect status, minimum number of transitions**>

Default: **Disabled**

Options: 0 = Disabled 1 = Enabled

Minimum Number of Transitions

Usage: Can be useful in certain application where extraneous objects in the field of view might require a higher threshold.

Definition: Determines the number of bar/space transitions that must be read before a symbol is considered present and AGC can be resolved.

Serial Cmd: <**K505, symbol detect status, minimum number of transitions**>

Default: **14**

Options: 1 to 255

Maximum Element

Definition: Maximum Element represents the maximum bar element width that is allowed before a video reset occurs (default to white).

Caution: Do not change this parameter unless instructed by a Microscan representative.

Serial Cmd: <**K502,maximum element**>

Default: **400** (x 0.01% of scan)

Options: 50 to 5000

Tracking Adjustment

Definition: Sets a tracking value for the scanner's analog circuitry. Changes to tracking adjustment should be made by Autocalibration.

Serial Cmd: <**K520,tracking adjustment**>

Default: **40**

Options: 5 to 127

5 Symbologies

Contents

Symbologies by ESP	5-2
Symbologies Serial Commands	5-2
Code 39	5-3
Code 128 / EAN-128	5-6
Interleaved 2 of 5	5-10
Codabar	5-13
UPC/EAN	5-16
Code 93	5-19
Pharmacode	5-20
PDF417	5-22
Narrow Margins / Symbology ID	5-24
Background Color	5-26
Autodiscriminate	5-27

This section describes the various symbol types that can be read and decoded by the scanner.

Code 39 is enabled by default. To enable all symbologies, right-click **Autodiscrimination** under **Symbol Type** in the **Utilities** menu and select **Enable**, or send a **<P>** serial command to the scanner from the **Terminal** window.

Note: The characters **NUL**, **<**, **>**, and **,** can only be entered through embedded menus, not through **ESP** or serial commands.

Symbologies by ESP



Click this button to bring up the **Symbologies** menu.

To open nested options, **single-click** the **+**.

Parameters	ESP Values
[-] Symbologies	
[-] 1D Symbologies	
+ Code 39	Enabled
+ Code 128	Disabled
+ Interleaved 2 of 5	Disabled
+ Codabar	
+ UPC/EAN	
+ Code 93	
+ Pharmacode	
[-] Stacked Symbologies	
+ PDF417	Disabled
Narrow Margin Status	Disabled*
Symbology Identifier	Disabled*
Background Color	Enabled

To change a setting, **double-click** the setting and use your cursor to scroll through the options.

Symbologies Serial Commands

Command Title	Command Format
Narrow Margins/Symbology ID	<K450,narrow margins status,symbology identifier status>
Background Color	<K451,background color>
Code 39	<K470,status,check character status,check character output status,large intercharacter gap,fixed symbol length status,fixed symbol length,full ASCII set>
Codabar	<K471,status,start and stop match,start and stop output,large intercharacter gap,fixed symbol length status,fixed symbol length,check character type,check character output>
Interleaved 2 of 5	<K472,status,check digit status,check digit output,symbol length #1,symbol length #2,guard bar status,range mode status>
UPC/EAN	<K473,UPCstatus,EAN status,supplemental status,separator status,separator character,supplemental type>
Code 128/EAN-128	<K474,Code 128 status,fixed symbol length status,symbol length,EAN-128 status,output format,application record separator status,application record separator character,application record brackets status,application record padding status,minimum ratio distance>
Code 93	<K475,status,fixed symbol length status,symbol length>
PDF417	<K476,status,raster sweeps before decode attempt,fixed symbol length status,symbol length,decode at end of read>
Pharmacode	<K477,status,fixed symbol length status,symbol length,minimum number of bars,bar widths,direction,fixed threshold value>

Code 39

Usage: **Code 39** is considered the standard for non-retail applications.

Definition: An alphanumeric symbol with unique start/stop symbol patterns, composed of 9 black and white elements per character, of which 3 are wide.

Code 39 Status

Serial Cmd: <**K470,status**,*check character status,check character output,large intercharacter gap,fixed symbol length status,symbol length,full ASCII set*>

Default: **Enabled**

Note: This is the only symbol type enabled by default.

Options: 0 = Disabled 1 = Enabled

Check Character Status (Code 39)

Serial Cmd: <**K470,status,check character status**,*check character output,large intercharacter gap,fixed symbol length status,symbol length,full ASCII set*>

Default: **Disabled**

Options: 0 = Disabled 1 = Enabled

Check Character Output (Code 39)

Usage: **Check Character Output Status**, added to the symbol, provides additional security.

Definition: When enabled, the check character is read and sent along with the symbol data. When disabled, symbol data is sent without the check character.

Note: With **Check Character Output Status** and an **External** or **Serial** trigger option enabled, an invalid check character calculation will cause a No Read message to be transmitted at the end of the read cycle.

Serial Cmd: <**K470,status,check character status,check character output**,*large intercharacter gap,fixed symbol length status,symbol length,full ASCII set*>

Default: **Disabled**

Options: 0 = Disabled 1 = Enabled

Large Intercharacter Gap (Code 39)

Usage: **Large Intercharacter Gap** is helpful for reading symbols that are printed out of specification.

Caution: Do not use **Large Intercharacter Gap** with **Narrow Margins** enabled since a large intercharacter gap (over 3x) could cause a narrow margins (5x) to be interpreted as an intercharacter gap.

Definition: When enabled, the scanner can read symbols with gaps between symbol characters that exceed three times (3x) the narrow element width.

Serial Cmd: <K470,status,check character status,check character output,**large intercharacter gap**,fixed symbol length status,symbol length,full ASCII set>

Default: **Disabled**

Options: 0 = Disabled 1 = Enabled

Fixed Symbol Length Status (Code 39)

Usage: Helps prevent truncations and increases data integrity by ensuring that only a fixed symbol length will be accepted.

Definition: When enabled, the scanner will check the symbol length against the symbol length field. If disabled, any length is considered a valid symbol.

Serial Cmd: <K470,status,check character status,check character output status,**large intercharacter gap**,**fixed symbol length status**,fixed symbol length,full ASCII set>

Default: **Disabled**

Options: 0 = Disabled 1 = Enabled

Symbol Length (Code 39)

Definition: Specifies the exact number of characters that the scanner will recognize (this does not include start and stop and check character characters). The scanner ignores any symbol not having the specified length.

Serial Cmd: <K470,status,check character status,check character output,**large intercharacter gap**,fixed symbol length status,**fixed symbol length**,full ASCII set>

Default: **10**

Default: 1 to 128

Full ASCII Set (Code 39)

- Usage:** Must be enabled when reading characters outside the standard character set (0-9, A-Z, etc.)
User must know in advance whether or not to use **Full ASCII Set** option. Since **Full ASCII Set** requires two symbol words to encode one character, it is less efficient.
- Definition:** Standard Code 39 encodes 43 characters; zero through nine, capital "A" through capital "Z", minus symbol, plus symbol, forward slash, space, decimal point, dollar sign and percent symbol. When **Full ASCII Set** is enabled, the scanner can read the full ASCII character set, from 0 to 255.
- Serial Cmd:** *<K470,status,check character status,check character output,large intercharacter gap,fixed symbol length status,symbol length,full ASCII set>*
- Default:** **Disabled**
- Options:** 0 = Disabled 1 = Enabled

Code 128/EAN-128

Usage: Code 128/EAN-128 is a smaller symbology, and is useful in applications with tight spots and high security needs.

Definition: A very dense alphanumeric symbology. It encodes all 128 ASCII characters; it is continuous, has variable length, and uses multiple element widths measured edge to edge.

Code 128 Status

Serial Cmd: <K474,Code 128 status,fixed symbol length status,symbol length,EAN-128 status,output format,application record separator status,application record separator character,application record brackets status,application record padding status,minimum ratio distance>

Default: Disabled

Options: 0 = Disabled 1 = Enabled 2 = Edge 3 = Serial Standard and Edge
(Serial Standard)

Note: Code 128 must be Enabled for EAN-128 to function.

Fixed Symbol Length Status (Code 128)

Definition: When enabled, the scanner will check the symbol length against the symbol length field. When disabled, any length is considered a valid symbol.

Serial Cmd: <K474,Code 128 status,fixed symbol length status,symbol length,EAN-128 status,output format,application record separator status,application record separator character,application record brackets status,application record padding status,minimum ratio distance>

Default: Disabled

Options: 0 = Disabled 1 = Enabled

Symbol Length (Code 128)

Usage: Fixed Symbol Length helps prevent truncations and increases data integrity by ensuring that only one symbol length will be accepted.

Definition: Specifies the exact number of characters that the scanner will recognize (this does not include start and stop and check characters). The scanner ignores any symbol not having the specified length.

Serial Cmd: <K474,Code 128 status,fixed symbol length status,symbol length,EAN-128 status,output format,application record separator status,application record separator character,application record brackets status,application record padding status,minimum ratio distance>

Default: 10

Options: 1 to 128

Note: Fixed Symbol Length Status must be enabled for Symbol Length to take effect.

EAN-128 Status

- Usage:** Sometimes called the “shipping code,” it is used as a standard to track a product from site to site with a single symbol that contains categories of information identifiable across industries worldwide.
- Definition:** A subset of Code 128, with extended features using application identifiers to define the meaning and format of fields that immediately follow them. For more information, refer to the AIM website at:
<http://www.aimglobal.org/standards/aimpubs.asp>
- Serial Cmd:** <**K474**,Code 128 status,fixed symbol length status,symbol length,**EAN-128 status**,output format,application record separator status,application record separator character,application record brackets status,application record padding status,minimum ratio distance>
Note: Code 128 serial command fields for K474 precede EAN-128.
- Default:** **Disabled**
- Options:** 0 = Disabled 1 = Enabled 2 = Required
- If set to **Enabled**, symbols can be read with or without a function 1 character in the first position.
- If set to **Required**, the symbol must have a function 1 in the first position and conform to EAN format in order to decode the symbol.
- Note:** Code 128 must also be **Enabled** for EAN-128 to function.

Output Format (EAN-128)

- Usage:** **Application Record** is useful in applications in which the software can use application record formatting to help automate the processing of its EAN-128 data.
- Definition:** Offers an option between **Standard EAN-128** and **Application Record** format.
- Serial Cmd:** <**K474**,Code 128 status,fixed symbol length status,symbol length,EAN-128 status,**output format**,application record separator status,application record separator character,application record brackets status,application record padding status,minimum ratio distance>
- Default:** **Standard**
- Options:** 0 = Standard
1 = Application Record
- Standard:** When set to **Standard**, EAN-128 application identifiers and data fields are sent, but none of the formatting (separators, parentheses, padding) will be included.
- Application Record:** **Application Record** is a variation of EAN-128 that allows the user to define separators between data fields, enclose application identifiers in parentheses, and enable padding (zeros) for variable length fields.

Note: If an illegal **Application Record** format is detected, the scanner will process it as a No Read and output a No Read message (if enabled).

Application Record Separator Status (EAN-128)

- Definition:** When enabled, a separator character is inserted between application records.
- Serial Cmd:** <**K474**,Code 128 status,fixed symbol length status,symbol length,EAN-128 status,output format,**application record separator status**,application record separator character,application record brackets status,application record padding status,minimum ratio distance>
- Default:** **Disabled**
- Options:** 0 = Disabled 1 = Enabled

Application Record Separator Character (EAN-128)

- Definition:** Defines an ASCII character as an application record separator.
- Serial Cmd:** <**K474**,Code 128 status,fixed symbol length status,symbol length,EAN-128 status,output format,application record separator status,**application record separator character**,application record brackets status,application record padding status,minimum ratio distance>
- Default:** , (comma)
- Options:** User Defined ASCII character

Note: **Output Format** must be set to **Application Record** before this parameter can take effect.

Application Record Brackets Status (EAN-128)

Definition: When enabled, parentheses () are added to enclose application identifiers.

Serial Cmd: <**K474**,Code 128 status,fixed symbol length status,symbol length,EAN-128 status,output format,application record separator status,application record separator character,**application record brackets status**,application record padding status,minimum ratio distance>

Default: **Disabled**

Options: 0 = Disabled 1 = Enabled

Note: **Output Format** must be set to **Application Record** before this parameter can take effect.

Application Record Padding Status (EAN-128)

Definition: Padding is the insertion of zeros to make up the maximum length of a variable application record data field, except for the last field which does not require padding.

When enabled, padding is included. When disabled, padding is omitted.

Note: Padding is never added to fixed length fields or to the last data field of a symbol. Enabling or disabling **Record Padding** will have no effect on these.

Serial Cmd: <**K474**,Code 128 status,fixed symbol length status,symbol length,EAN-128 status,output format,application record separator status,application record separator character,application record brackets status,**application record padding status**,minimum ratio distance>

Default: **Disabled**

Options: 0 = Disabled 1 = Enabled

Note: **Output Format** must be set to **Application Record** before this parameter can take effect.

Minimum Ratio Distance (Code 128)

Definition: Determines the error tolerance level.

Normal enforces a requirement for normal error tolerance.

High enforces a requirement for high element-to-element quality.

Highest enforces a requirement for very high element-to-element quality.

Serial Cmd: <**K474**,Code 128 status,fixed symbol length status,symbol length,EAN-128 status,output format,application record separator status,application record separator character,application record brackets status,application record padding status,**minimum ratio distance**>

Default: **Normal**

Options: 0 = Normal 1 = High 2 = Highest

Interleaved 2 of 5

Usage: Interleaved 2 of 5 has been popular because it is the most dense symbol for printing numeric characters less than 10 characters in length; however, Microscan does not recommend this symbology for any new applications because of inherent problems (truncation, for example).

Definition: A dense, continuous, self-checking, numeric symbology. Characters are paired together so that each character has five elements, two wide and three narrow, representing numbers 0 through 9, with the bars representing the first character and the interleaved spaces representing the second character. (A check digit is highly recommended.)

Important: You must set **Symbol Length** in order to decode I 2/5 symbols.

Interleaved 2 of 5 Status

Serial Cmd: <K472,status,check digit status,check digit output status,symbol length #1,symbol length #2,guard bar status,range mode>

Default: Disabled

Options: 0 = Disabled 1 = Enabled

Check Digit Status (Interleaved 2 of 5)

Usage: Typically not used but can be enabled for additional security in applications where the host requires redundant check digit verification.

Definition: An error correcting routine in which the check digit character is added.

Serial Cmd: <K472,status,check digit status,check digit output status,symbol length #1,symbol length #2,guard bar status,range mode>

Default: Disabled

Options: 0 = Disabled 1 = Enabled

Check Digit Output Status (Interleaved 2 of 5)

Definition: When enabled, a check digit character is sent along with the bar symbol data for added data security.

Serial Cmd: <K472,status,check digit status,check digit output,symbol length #1,symbol length #2,guard bar status,range mode>

Default: Disabled

Options: 0 = Disabled 1 = Enabled

Symbol Length #1 (Interleaved 2 of 5)

Usage: With I-2/5, two symbol lengths can be defined. When using only one symbol length in an application, setting **Symbol Length #2** to 0 (zero) to ensure data integrity is recommended.

Definition: Allows user to define the symbol length. Because I-2/5 is a continuous symbology, it is prone to substitution errors. Hence, a symbol length must be defined and a symbol must contain an even number of digits.

Note: If start, stop or check digits are used, they are not included in the symbol length count.

Serial Cmd: <K472,status,check digit status,check digit output status,**symbol length #1**,symbol length #2,guard bar status,range mode>

Default: 10

Options: 0 to 128, even

Note: Since I 2/5 characters are paired, symbol length must be set to an even number. If **Check Digit** is enabled, add 2 to your symbol length. For example, if your symbol is 10 characters plus a check digit, then enable **Symbol Length** for 12.

Note: Typically, when printing an I 2/5 symbol with an odd number of digits, a 0 will be added as the first character. **Note:** If both Symbol Length #1 and Symbol Length #2 are set to 0, then I-2 of 5 will be variable.

Symbol Length #2 (Interleaved 2 of 5)

Usage: If using a second symbol, a zero or any even symbol length from 2 to 64 may be specified. If not using a second symbol, set **Symbol Length #2** to 0 to ensure data integrity.

Definition: Allows user to define a second symbol length for I-2/5.

Serial Cmd: <K472,status,check digit status,check digit output status,symbol length #1,**symbol length #2**,guard bar status,range mode>

Default: 6

Options: 0 to 128, even

Since I 2/5 characters are paired, symbol length must be set to an even number. If **Check Digit** is enabled, add 2 to your symbol length. For example, if your symbol is 10 characters plus a check digit, then enable **Symbol Length** for 12.

Note: Typically, when printing an I 2/5 symbol with an odd number of digits, a 0 will be added as the first character.

Note: If both **Symbol Length #1** and **Symbol Length #2** are set to 0, then I-2 of 5 will be variable.

Guard Bar (Interleaved 2 of 5)

Note: Whenever **Guard Bar** is enabled, the presence of guard bars is required for decoding to take place.

Usage: Useful when I 2 of 5 multisymbols are enabled to prevent false data output. This typically occurs with highly tilted or skewed symbols.

Definition: A guard bar is a heavy bar, at least 2 times the width of the wide bar, surrounding the printed I 2 of 5 symbol and helping to prevent false reads.

Serial Cmd: <**K472**,status,check digit status,check digit output status,symbol length #1,symbol length #2,**guard bar**,range mode>

Default: **Disabled**

Options: 0 = Disabled
1 = Enabled

Range Mode (Interleaved 2 of 5)

Note: Whenever **Guard Bar** is enabled, the presence of guard bars is required for decoding to take place.

Definition: When enabled, this feature causes symbol length # 1 and symbol length # 2 to form of a range of lengths that can be decoded.

For example, if symbol lengths of **10** and **6** are enabled, those are the lengths that can be decoded. Note that either length can serve as the minimum or maximum.

Serial Cmd: <**K472**,status,check digit status,check digit output status,symbol length #1,symbol length #2,guard bar,**range mode**>

Default: **Disabled**

Options: 0 = Disabled
1 = Enabled

Codabar

Usage: Used in photo-finishing and library applications. Used in some medical applications at one time, but not typically used in newer applications.

Definition: Codabar is a 16-character set (0 through 9, and the characters \$, :, /, ., +, and -) with start/stop codes and at least two distinctly different bar widths.

Codabar Status

Serial Cmd: <**K471,status,start and stop match status,start and stop output status,large intercharacter gap,fixed symbol length status,symbol length,check character type,check character output status**>

Default: **Disabled**

Options: 0 = Disabled 1 = Enabled

Start and Stop Match Status (Codabar)

Usage: Used to increase security of symbology.

Definition: Requires the Codabar start and stop characters (a, b, c, or d) to match before a valid read can occur.

Serial Cmd: <**K471,status,start and stop match status,start and stop output status,large intercharacter gap,fixed symbol length status,symbol length,check character type,check character output status**>

Default: **Enabled**

Options: 0 = Disabled 1 = Enabled

Start and Stop Output Status (Codabar)

Usage: Used to verify matching.

Definition: Causes the start and stop characters to be transmitted with symbol data.

Serial Cmd: <**K471,status,start and stop match status,start and stop output status,large intercharacter gap,fixed symbol length status,symbol length,check character type,check character status,check character output status**>

Default: **Enabled**

Options: 0 = Disabled 1 = Enabled

Large Intercharacter Gap (Codabar)

- Usage:** It is helpful for reading symbols that are printed out of specification.
Caution: Do not use **Large Intercharacter Gap** with **Narrow Margins** enabled since enabling **Large Intercharacter Gap** (over 3x) could cause a narrow margins (5x) to be interpreted as an intercharacter gap.
- Definition:** Instructs the scanner to read symbols with gaps between characters exceeding three times the narrow element width.
- Serial Cmd:** `<K471,status,start and stop match status,start and stop output status,large intercharacter gap,fixed symbol length status,symbol length,check character type,check character output status>`
- Default:** **Disabled**
- Options:** 0 = Disabled 1 = Enabled

Fixed Symbol Length Status (Codabar)

- Usage:** **Fixed Symbol Length** helps prevent truncations and increases data integrity by ensuring that only one symbol length will be accepted.
- Definition:** When enabled, the scanner will check the symbol length against the fixed symbol length field. When disabled, any length would be considered a valid symbol.
- Serial Cmd:** `<K471,status,start and stop match status,start and stop output status,large intercharacter gap,fixed symbol length status,symbol length,check character type,check character output status>`
- Default:** **Disabled**
- Options:** 0 = Disabled 1 = Enabled

Symbol Length (Codabar)

- Definition:** Specifies the exact number of characters that the scanner will recognize (this does not include start and stop and check character characters). The scanner ignores any symbol not having the specified length.
- Serial Cmd:** `<K471,status,start and stop match status,start and stop output status,large intercharacter gap,fixed symbol length status,fixed symbol length,check character type,check character output status>`
- Default:** **10**
- Options:** 1 to 128

Note: **Fixed Symbol Length Status** must be enabled for **Symbol Length** to take effect.

Note: Because of symbology limitations, setting **Symbol Length** to any number less than four will produce undetermined results.

Check Character Type (Codabar)

Definition: Allows the user to select the check character type **Codabar** will use.

Serial Cmd: <**K471**,status,start and stop match,start and stop output status,large intercharacter gap,fixed symbol length status,fixed symbol length,**check character type**,check character output status>

Default: **Disabled**

Options: 0 = Disabled
1 = Modulus 16
2 = NW 7
3 = Both

Modulus 16: Used in the photo-finishing market.

NW 7: Used in Japanese markets.

Check Character Output Status (Codabar)

Usage: For additional security a check character can be added to the symbol.

Definition: When enabled, the check character character is sent along with the symbol data. When disabled, symbol data is sent without the check character.

Serial Cmd: <**K471**,status,start and stop match,start and stop output status,large intercharacter gap,fixed symbol length status,symbol length,check character type,**check character output status**>

Default: **Disabled**

Options: 0 = Disabled 1 = Enabled

UPC/EAN

Usage: Used primarily in POS application in the retail industry. It is commonly used in applications in combination with **Matchcode** when there is a need to verify that the right product is being placed in the right packaging.

Definition: UPC (Universal Product Code) is a fixed length numeric, continuous symbology. UPC can have two- or five-digit supplemental symbol data following the normal symbol. The U.P.C., Version A (UPC-A) symbol is used to encode a 12 digit number. The first digit is the number system character, the next five are the manufacturer number, the next five are the product number, and the last digit is the checksum character.

When enabled, the scanner will read UPC-A and UPC-E only.

UPC Status

Serial Cmd: <**K473**,**UPC status**,*EAN status*,*supplemental status*,*separator status*,*separator character*,*supplemental type*>

Default: **Disabled**

Options: 0 = Disabled 1 = Enabled

EAN Status

Usage: **UPC/EAN** is the European version of the UPC symbology and is used in European market applications.

Note: **UPC** must be enabled for **EAN** to take effect.

Definition: EAN is a subset of UPC. When enabled, the scanner will read UPC version A, UPC version E, EAN 13, and EAN 8. It also appends a leading zero to UPC version A symbol information and transmits 13 digits. If transmitting 13 digits when reading UPC version A symbols is not desired, disable **UPC/EAN**.

Note: The extra character identifies the country of origin.

Serial Cmd: <**K473**,*UPC status*,**EAN status**,*supplemental status*,*separator status*,*separator character*,*supplemental type*>

Default: **Disabled**

Options: 0 = Disabled 1 = Enabled

Supplemental Status (UPC/EAN)

- Usage:** Reads **Supplementals** typically used in publications and documentation.
- Definition:** A supplemental is a 2 or 5 digit symbol appended to the main symbol. When set to **Enabled** or **Required**, the scanner reads supplemental symbol data that has been appended to the standard UPC or EAN codes.
- Serial Cmd:** <**K473**,UPC status,EAN status,**supplemental status**,separator status,separator character,supplemental type>
- Default:** **Disabled**
- Options:** 0 = Disabled
1 = Enabled
2 = Required
- Disabled:** **UPC Supplementals** will not be decoded.
- Enabled:** When enabled, the scanner will try to decode a main and a supplemental. However, if a supplemental is not decoded, at the end of the read cycle, the main will be sent by itself. The UPC main and supplemental symbols are considered to be one symbol and will be treated as such.
- Required:** When set to **Required** and either the main or supplemental symbol is not read, a single No Read condition results. The UPC main and supplemental symbols are treated as one symbol.
- For example, if **Supplementals** is set to **Required**, **Separator** is enabled, and an asterisk is defined as the UPC separator character, then the data will be displayed as: MAIN * SUPPLEMENTAL.

Note: Under no circumstances will supplemental symbol data be sent without a main symbol.

Note: If additional symbols—other than the main or supplemental—will be read in the same read cycle, **Number of Symbols** should be set accordingly.

Separator Status (UPC/EAN)

- Usage:** Allows user to distinguish between the main and **Supplemental** symbols.
- Definition:** Allows the user to insert a character between the standard UPC or UPC/EAN symbol and the supplemental symbol when **Supplementals** is set to **Enabled** or **Required**.
- Serial Cmd:** <**K473**,UPC status,EAN status,supplemental status,**separator status**,separator character,supplemental type>
- Default:** **Disabled**
- Options:** 0 = Disabled 1 = Enabled

Separator Character (UPC/EAN)

Note: If **Separator Character** has been changed to any other character and you wish to redefine the separator as a comma, you will need to use **ESP** or the embedded menu.

Note: Whenever **Separator Character** is defined as a comma (,) sending a **<K473,?>** command will return the current settings, including the separator character comma which appears after the separator status comma.

Usage: As required by the application.

Definition: Allows the user to change the separator character from a comma to a new character.

Serial Cmd: **<K473,UPC status,EAN status,supplemental status,separator status,separator character,supplemental type>**

Default: , (comma)

Options: Any ASCII character

Supplemental Type (UPC/EAN)

Usage: As required by symbology used in application.

Definition: Allows the user to select 2 character or 5 character supplement, or both.

Serial Cmd: **<K473,UPC status,EAN status,supplemental status,separator status,separator character,supplemental type>**

Default: **Both**

Options: 0 = Both
1 = 2 characters only
2 = 5 characters only

Both: Either 2 character or 5 character supplementals will be considered valid.
2 Char Only: Only two character supplementals will be considered valid.
5 Char Only: Only five character supplementals will be considered valid.

Code 93

- Usage:** Used occasionally in the clinical industry.
- Definition:** Code 93 is a variable length, continuous symbology employing four element widths. Each Code 93 character has nine modules that may be either black or white. Each character contains three bars and three spaces.

Code 93 Status

- Serial Cmd:** <**K475,status,fixed symbol length status,fixed symbol length**>
- Default:** **Disabled**
- Options:** 0 = Disabled 1 = Enabled

Fixed Symbol Length Status (Code 93)

- Usage:** Helps prevent truncations and increases data integrity by ensuring that only one symbol length will be accepted.
- Definition:** When enabled, the scanner will check the symbol length against the symbol length field. When disabled, any length is considered a valid symbol.
- Serial Cmd:** <**K475,status,fixed symbol length status,fixed symbol length**>
- Default:** **Disabled**
- Options:** 0 = Disabled 1 = Enabled

Fixed Symbol Length (Code 93)

- Definition:** Specifies the exact number of characters that the scanner will recognize (this does not include start and stop and check characters). The scanner ignores any symbol not having the specified length.
- Serial Cmd:** <**K475,status,fixed symbol length status,fixed symbol length**>
- Default:** **10**
- Options:** 1 to 128

Pharmacode

Usage: Pharmacode is used mostly with packaging for the pharmaceuticals industry.

Definition: The symbol encodes up to five different numbers, each with its own color which may be entered in decimal or “binary” format with a 1 represented by a thick bar and a 0 represented by a thin bar. Bar width is independent of height.

In decimal format, each part can be up to 999999.

In binary format, each input have up to 19 ones and zeros.

Note: It is recommended that you disable AGC before enabling Pharmacode.

Pharmacode Status

Serial Cmd: <**K477,status, fixed symbol length status, fixed symbol length, min. no. of bars, bar widths, decode direction, fixed threshold value**>

Default: **Disabled**

Options: 0 = Disabled 1 = Enabled

Fixed Symbol Length Status (Pharmacode)

Serial Cmd: <**K477,status, fixed symbol length status, fixed symbol length, min. no. of bars, bar widths,, decode direction, fixed threshold value**>

Default: **Disabled**

Options: 0 = Disabled 1 = Enabled

Fixed Symbol Length (Pharmacode)

Serial Cmd: <**K477,status, fixed symbol length status, fixed symbol length, min. no. of bars, bar widths, decode direction, fixed threshold value**>

Default: **10**

Options: 4 to 16

Minimum Number of Bars (Pharmacode)

Serial Cmd: <**K477,status, fixed symbol length status, fixed symbol length, min. no. of bars, bar widths, decode direction, fixed threshold value**>

Default: **4**

Options: 4 to 16

Bar Widths (Pharmacode)

Serial Cmd: <**K477**,status,fixed symbol length status,fixed symbol length,min. no. of bars,
bar widths,decode direction,fixed threshold value>

Default: **Mixed**

Options: 0 = Mixed
1 = Narrow
2 = Wide

Decode Direction (Pharmacode)

Definition: Specifies the direction that a bar can be read.

Serial Cmd: <**K477**,status,fixed symbol length status,fixed symbol length,min. no. of
bars,bar widths,**decode direction**,fixed threshold value>

Default: **Forward**

Options: 0 = Forward 1 = Reverse

Fixed Threshold Value (Pharmacode)

Serial Cmd: <**K477**,status,fixed symbol length status,fixed symbol length,min. no. of
bars,bar widths,decode direction,**fixed threshold value**>

Default: **400**

Options: 1 to 65535

PDF417

Note: Calibration does not function with PDF417 symbols. However, you can substitute a Code 128 symbol with the same mil size as your PDF417. When you do this, enable **Code 128** and disable **Raster** scanning. After calibration, switch back to **PDF417** and **Raster** scanning.

Usage: Used in applications where a large amount of information (over 32 characters) needs to be encoded within a symbol, typically where the symbol is transported from one facility to another. For example, an automobile assembly line might use a single symbol with multiple fields of information that will be read at several stations along the way, without reference to a database.

Definition: A two-dimensional, multi-row (3 to 90), continuous, variable length symbology that has high data capacity for storing up to 2700 numeric characters, 1,800 printable ASCII characters, or 1100 binary character per symbol. Each symbol character consists of 4 bars and 4 spaces in a 17-module structure.

PDF417 Status

Serial Cmd: *<K476,status,raster sweeps before decode attempt,fixed symbol length status,fixed symbol length,decode at end of read>*

Default: **Disabled**

Options: 0 = Disabled 1 = Enabled

Raster Sweeps Before Decode Attempt (PDF417)

Usage: Might be useful in dynamic applications where symbols are close together and need to be decoded more quickly than the default setting allows.

Definition: Specifies the number of raster sweeps the scanner will execute on PDF symbols before decoding. A value of 0 effectively disables this feature, which allows the decoder to make a “best guess” as to when enough symbol words have been captured.

Serial Cmd: *<K476,status,raster sweeps before decode attempt,fixed symbol length status,fixed symbol length,decode at end of read>*

Default: **0** (disabled)

Options: 0 to 4

Fixed Symbol Length Status (PDF417)

- Usage:** Used to increase data integrity by ensuring that only one symbol length will be accepted.
- Definition:** When enabled, the PDF symbol must contain the same number of characters as the symbol length setting before it can be considered a good decode. The scanner will ignore any symbol not having the specified length.
- Serial Cmd:** <**K476**,status,raster sweeps before decode attempt,**fixed symbol length status**,fixed symbol length,decode at end of read>
- Default:** **Disabled**
- Options:** 0 = Disabled
1 = Enabled

Fixed Symbol Length (PDF417)

- Definition:** Specifies the exact number of characters the scanner will recognize.
- Serial Cmd:** <**K476**,status,raster sweeps before decode attempt,fixed symbol length status,**fixed symbol length**,decode at end of read>
- Default:** **10**
- Options:** 1 to 2710
- Note:** **Fixed Symbol Length Status** must be enabled for **Fixed Symbol Length** to take effect.

Decode at End of Read (PDF417)

- Definition:** Allows the user to specify that the decoding of the PDF417 symbol take place after the requirements of **End of Read Cycle** have been satisfied. This means that the scanner will accumulate information about the PDF417 candidate symbol but will not attempt to error-correct or translate the information until the end of the read cycle.
- Serial Cmd:** <**K476**,status,raster sweeps before decode attempt,fixed symbol length status,fixed symbol length,**decode at end of read**>
- Default:** **Disabled**
- Options:** 0 = Disabled
1 = Enabled

Narrow Margins/Symbology ID

- Usage:** Used when the leading and trailing edges of the symbols are smaller than the standard margin or when other objects encroach into the margins.
- Definition:** Allows the scanner to read symbols with quiet zones less than 8 times the width of the narrow bar element. The “quiet zone” is the space at the leading and trailing ends of a symbol. Each quiet zone can be as narrow as only five times the width of the narrow bar element when **Narrow Margins** is enabled.
- Serial Cmd:** <**K450,narrow margins status,symbology identifier status**>
- Default:** **Disabled**
- Options:** 0 = Disabled 1 = Enabled
- Note:** Do not use **Narrow Margins** with **Large Intercharacter Gap** enabled in Code 39 or Codabar.

Symbology ID

- Usage:** Used when the symbology type and how it's decoded needs to be known.
- Definition:** Symbology ID is an AIM standard prefix set of characters that identify the symbol type.
- When enabled, the scanner analyzes and identifies the symbology and adds a three character identifying prefix to the data:
1. **]** (close bracket character) indicating the presence of a symbology ID
 2. **A, C, E, I, L, Q, b, d, p, P, M**
A = Code 39, C = Code 128 or EAN-128, E = UPC/EAN,
I = I-2/5, F = Codabar; G = Code 93, L = PDF417, a = Pharmacode,
e = Composite/RSS, L = PDF417 and Micro PDF417
 3. **Modifier** (see **Explanation of Modifiers** below)
- Serial Cmd:** <**K450,narrow margins,symbology identifier status**>
- Default:** **Disabled**
- Options:** 0 = Disabled 1 = Enabled

Explanation of Modifiers for Code 39, Codabar, and Interleaved 2/5

- For Code 39, Codabar and I–2/5, the modifier indicates **Check Character** and **Check Character Output Status**.
- For Code 39 only, **Full ASCII** needs to be enabled to see modifiers **4**, **5**, and **7**.

<i>Modifier</i>	<i>Check Character</i>	<i>Check Character Output</i>	<i>Full ASCII conversion performed (Code 39 only)</i>
0	Disabled	N/A	No
1	Enabled	Enabled	No
3	Enabled	Disabled	No
4	Disabled	N/A	Yes
5	Enabled	Enabled	Yes
7	Enabled	Disabled	Yes

Example:]A5 indicates a Code 39 symbol with **Check Character** and **Check Character Output Status** enabled and Full ASCII conversion performed.

Explanation of Modifiers for Other Symbologies

- For Code 128, a **1** indicates EAN-128; otherwise the modifier is a **0**.
- For all other codes, the modifier is **0**.

Background Color

Usage: If the background is darker than the symbol, then enable black background. Typically the background is white; but on PCBs for example, they can be black.

Definition: Allows the user to choose which symbol background (white or black) the scanner can read.

Serial Cmd: **<K451,background color>**

Default: **White**

Options: 0 = White 1 = Black

Autodiscriminate

Although **Autodiscriminate** is not a configuration command, but it is included here as a convenient tool for enabling most symbol types.

Usage: Commonly used for quick setup mode to detect symbol type. This is particularly useful for users who might be unfamiliar with their application's symbology.

Note: It does not alter individual fields such as **Start/Stop**, **Fixed Length**, etc. These need to be setup individually.

Definition: Enables all available symbology types except PDF417, UPC/EAN, and Pharmacode. The user may also individually disable/enable each symbology type.

Serial Cmd: **<P>**

Default: **Code 39** (only)

Options: **<P>** Enables all codes except noted above.

<Q> Enables Code 39 only

<R> Enables Codabar only

<S> Enables I 2/5 only

Note: If using an I 2/5 symbol, verify that the number of characters in the symbol being scanned matches the symbol length enabled for the I 2/5 symbol type (default is **10** and **6**).

Autodiscriminate

6 I/O Parameters

Contents

I/O Parameters by ESP.....	6-2
I/O Parameters Serial Commands	6-3
Symbol Data Output.....	6-4
No Read Message	6-6
Bad Symbol Message	6-7
No Symbol Message	6-7
Read Duration Output	6-8
Output Indicators.....	6-9
Beeper.....	6-12
Serial Verification	6-13
EZ Button	6-15
EZ Button Modes	6-17
Input 1	6-19
Configurable Output 1	6-20
Trend Analysis Output 1.....	6-24
Diagnostics Output 1.....	6-27
Configurable Output 2.....	6-28
Trend Analysis Output 2.....	6-28
Diagnostics Output 2.....	6-28
Configurable Output 3.....	6-29
Trend Analysis Output 3.....	6-29
Diagnostics Output 3.....	6-29
Database Identifier Output	6-30
Quality Output.....	6-31

This section includes instructions on setting up conditions for changing input/output electrical transitions for control of the scanner's internal and external devices.

Note: The characters **NUL**, **<**, **>**, and **,** can only be entered through embedded menus, not through **ESP** or serial commands.

I/O Parameters by ESP

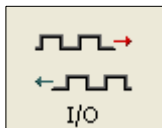

Click this button to bring up the **I/O Parameters** menu.

To open nested options, **single-click** the +.

Parameters	ESP Values
[-] I/O Parameters	
+ Symbol Data Output	Good Read
+ Noread Message	Enabled
+ Bad Symbol Message	Disabled
+ No Symbol Message	Disabled
+ Output Indicators	
+ Serial Verification	
+ EZ Button	Enabled
+ Input 1	Disabled
+ Database Identifier Output	Disabled*
+ Output 1 Parameters	Disabled*
+ Output 2 Parameters	Enabled
+ Output 3 Parameters	
+ Quality Output	
+ Read Duration Output	Disabled

To change a setting, **double-click** the setting and use your cursor to scroll through the options.

I/O Parameters Serial Commands

Command Title	Command Format
Serial Verification	< K701 ,serial command echo status,serial command beep status,control/hex output>
Beeper	< K702 ,status>
Quality Output	< K704 ,quality output separator,reads/trigger status,direction output>
Symbol Data Output	< K705 ,status,when to output>
Read Duration Output	< K706 ,status,separator>
No Read Message	< K714 ,status,message>
Bad Symbol Message	< K715 ,status,bad symbol message>
No Symbol Message	< K716 ,status,no symbol message>
Input 1	< K730 ,mode,active state>
Target/Flood LEDs	< K750 ,green flash LED status,green flash duration>
Database Identifier Output	< K759 ,status,separator>
EZ Button	< K770 ,global mode,default on power-on status>
EZ Button Modes	< K771 ,one beep,two beeps,three beeps>
Trend Analysis Output 1	< K780 ,trend analysis mode,number of triggers,number to output on,decodes/trigger threshold>
Trend Analysis Output 2	< K781 ,trend analysis mode,number of triggers,number to output on,decodes/trigger threshold>
Trend Analysis Output 3	< K782 ,trend analysis mode,number of triggers,number to output on,decodes/trigger threshold>
Diagnostic Output 1	< K790 ,over temperature,service threshold,[unused],laser current high,laser current low,low temperature>
Diagnostic Output 2	< K791 ,over temperature,service threshold,[unused],laser current high,laser current low,low temperature>
Diagnostic Output 3	< K792 ,over temperature,service threshold,[unused],laser current high,laser current low,low temperature>
Configurable Output 1	< K810 ,output on,output state,pulse width,output mode>
Configurable Output 2	< K811 ,output on,output state,pulse width,output mode>
Configurable Output 3	< K812 ,output on,output state,pulse width,output mode>

Symbol Data Output

Usage: Useful when the host needs symbol data only under certain conditions.

Definition: Defines the conditions under which decoded symbols are transmitted to the host.

Symbol Data Output Mode

Serial Cmd: <K705,output status,when to output>

Default: **Good Read**

Options:

- 0 = Disabled
- 1 = Match
- 2 = Mismatch
- 3 = Good Read

Disabled

Usage: **Disabled** is useful when an application only needs to use the discrete outputs and can allow the scanner to do the decision-making. When set to **Disabled**, the host does not need the symbol data and the communication lines are used only for setup and status checks.

Definition: When set to **Disabled**, the scanner will not transmit any data that is generated during a read cycle (symbols, No Reads, etc.).

Match

Usage: **Match** is typically used to route items with the same identifying data to the same location.

Definition: With **Match** enabled, the scanner transmits symbol data whenever the symbol data information matches the master symbol.

Mismatch

Usage: **Mismatch** is typically used as a flag within the host system to prevent an item from being routed in the wrong container.

Definition: With **Mismatch** enabled, the scanner transmits symbol data whenever the symbol data information does NOT match the master symbol.

Note: A No Read can still be transmitted if enabled.

Good Read

Usage: **Good Read** is used when an application requires all symbol data to be transmitted. It's typically used in tracking applications in which each object is uniquely identified.

Definition: With **Good Read** enabled, the scanner transmits symbol data on any good read regardless of **Matchcode Type** setting.

Note: A No Read can still be transmitted if enabled.

When to Output Symbol Data

Definition: This command allows the user to choose when symbol data can be sent to the host.

Serial Cmd: <**K705**,symbol output status,**when to output**>

Default: **As Soon As Possible**

Options: 0 = As Soon As Possible 1 = End of Read Cycle

As Soon As Possible

Usage: **As Soon As Possible** is useful in applications in which symbol data needs to be moved quickly to the host, typically when the host is making decisions based on symbol data.

Definition: Enabling **As Soon As Possible** causes symbol data to be sent to the host immediately after a symbol has been successfully decoded.

Note: More than one decode might in fact be required to qualify as a good decode, depending on how **Decodes Before Output** is set.

End of Read Cycle

Note: See [End of Read Cycle Mode](#) on page 4-14 for options to end the read cycle.

Usage: **End of Read Cycle** is useful in timing-based systems in which the host is not ready to accept data at the time it is decoded.

Definition: Enabling **End of Read Cycle** means that symbol data does not get sent to the host until the read cycle ends with a timeout or new trigger.

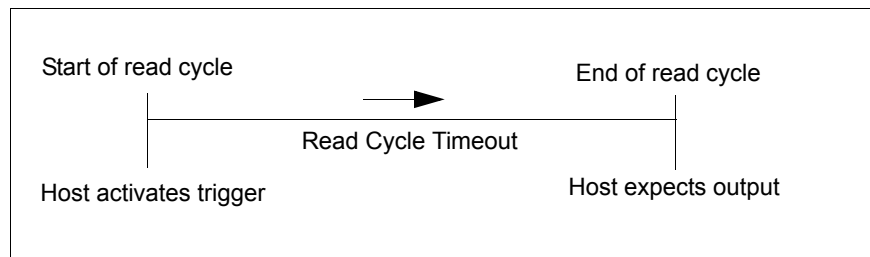

Read Cycle

No Read Message

Usage: Used in applications where the host needs serial verification that a symbol has not been read and especially useful in new print verification.

Definition: When enabled, and if no symbol has been decoded before timeout or the end of the read cycle, the No Read message will be transmitted to the host.

No Read Status

Serial Cmd: <K714,**status**,message>

Default: **Enabled**

Options: 0 = Disabled 1 = Enabled

No Read Message

Definition: Any combination of ASCII characters can be defined as the No Read message.

Serial Cmd: <K714,**status**,**message**>

Default: **NOREAD**

Options: 1 to 128 ASCII characters.

Note: No Read Message will only be transmitted if **Symbol Output** is set to **Match**, **Mismatch** or **Good Read**.

No Read Message can be set to any ASCII characters except **NUL**, **<**, **>**, and **,** .

Bad Symbol Message

- Usage:* Useful in determining if a symbol is present and if user defined requirements for that symbol are met. Can tell the user if a qualified symbol is present but not decodable.
- Definition:* Sets the requirements that will qualify an object or a symbol before outputting a decode or message. When enabled, sends a message to the host whenever an object meets the qualifications setup but is not decoded.
- Serial Cmd:* <K715,[unused],**message**>
- Default:* **BAD_SYMBOL**
- Options:* 1 to 128 ASCII characters

No Symbol Message

- Usage:* Useful in determining if a symbol is present and if user defined requirements for that symbol are met. Can tell the user if an object does not qualify as a symbol.
- Definition:* Sets the requirements that will qualify an object or a symbol before outputting a decode or message. When enabled, sends a message to the host whenever an object meets the qualifications setup but is not decoded.
- Serial Cmd:* <K716,[unused],**message**>
- Default:* **NO_SYMBOL**
- Options:* 1 to 128 ASCII characters

Read Duration Output

Usage: Useful in evaluating actual read cycle timing results, especially when initially setting up an application to determine maximum line speed (obtainable based on spacing between symbols.)

Definition: When enabled the duration of the read cycle (in milliseconds) is appended to the symbol data.
The read duration is the time from the beginning of the read cycle until data is output.

Read Duration Output Mode

Serial Cmd: <K706,status,separator>

Default: Disabled

Options: 0 = Disabled 1 = Enabled

Important: To measure the entire read cycle when in **External Level** trigger mode, set **When to Output Symbol Data** to **End of Read Cycle**.

This output can measure over 49 days' worth of duration; if exceeded, the "OVERFLOW" message will be output in place of the duration.

Read Duration Output Separator

Definition: User defined character that separates the symbol information from the **Read Duration Output**.

Serial Cmd: <K706,status,separator>

Default: , (comma)

Options: Any ASCII character.

Output Indicators

Note: System features such as autocalibration and EZ Button setup may illuminate scanner LEDs regardless of parameter settings.

Green Flash Mode

- Usage:** Used as a visual verification that a Good Read has occurred.
- Definition:** An array of green LEDs in the front of the scanner can be programmed to flash in response to user-defined conditions.
- Serial Cmd:** `<K750,green flash LED status,green flash duration>`
- Default:** **Good Read**
- Options:**
- 0 = Disabled
 - 1 = Good Read**
 - 2 = Static Presentation
 - 3 = Match
 - 4 = Mismatch

Disabled

Green flash LEDs are disabled.

Good Read

Green flash LEDs will flash when a Good Read condition is met or when **Matchcode** is enabled and a match occurs.

Static Presentation Mode

Static Presentation Mode is used in conjunction with **Continuous Read Mode**: `<K200,0>`.

When operating in **Static Presentation Mode**, the red LEDs will illuminate while the scanner is searching for a symbol in **Continuous Read Mode**. When a symbol is placed in the field of view and a Good Read occurs, the green LEDs will illuminate and stay on for the duration of time set in **Green Flash Duration**. Only one read will occur during that time unless more than one symbol is enabled in **Number of Symbols**.

Note: If **Static Presentation Mode** is selected but the scanner is not in **Continuous Read**, the **Green Flash** will not occur.

To use Static Presentation:

1. Enable **Continuous Read**.
2. Select the number of symbols.
3. Enable **Static Presentation** in **Green Flash Mode**.
4. Select the read time in **Green Flash Duration**.

Output Indicators

Match

The green LEDs will flash when a match condition is met. If multisymbol is enabled, then green flash LEDs will illuminate only if all symbols qualify as a match. If matchcode is disabled, then this mode will activate the LEDs on a Good Read.

Mismatch

Same as **Match**, except that LEDs will illuminate on a mismatch.

Green Flash Duration

- Usage:** Provides visual verification that a Good Read has occurred.
- Definition:** When a Good Read occurs, the green LEDs will illuminate and stay on for the time set in the **Green Flash Duration** value.
- Serial Cmd:** *<K750,green flash mode,green flash duration>*
- Default:** **100** (1 second)
- Options:** 0 to 65535 (in 10 ms increments)

Beeper

Usage: Can be used as an audible verification that either a good read or a No Read has occurred.

Definition: A beep is emitted either after each good read of a symbol or after each No Read.

Note: Beeper will also sound if any of the following occur:

- The scanner is defaulted.
- A send/save command from **ESP** or an **Exit** command from any embedded menu.
- A **<Z>**, **<Zp>**, **<Zd>**, or **<K701,,1>** command is sent.

Beeper Status

Serial Cmd: **<K702,status>**

Default: **On Good Read**

Options:
0 = Disabled
1 = On Good Read
2 = On No Read

Serial Verification

Usage: These commands are useful in removing any doubt about the scanner's acceptance and response to host configuration commands.

For example, if the current preamble is "SOM" and <Kd1, START> is entered, the scanner will echo back <Kd1, SOM> since the attempted entry "START" exceeds the four character limit for that command. Therefore it is rejected and the existing "SOM" message is echoed back and remains the preamble message.

Definition: Allows the user to verify configuration command status.

Serial Command Echo Status

Important Note: ESP will not function whenever this command is enabled.

Definition: When enabled, a configuration command received from the host is echoed back to the host with the resultant settings.

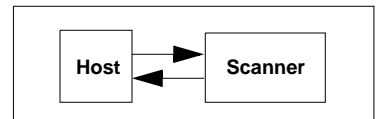

Function: If a command with multiple fields is processed, some of the fields may have been processed properly while others were not. The changes will appear in the string echoed back so that the user will know which fields did or did not change.

Serial Cmd: <K701,serial command echo status,serial command beep status,control/hex output>

Default: Disabled

Options: 0 = Disabled 1 = Enabled

Serial Command Beep Status

Important: ESP will not function whenever this command is enabled.

Usage: Used to audibly verify the acceptance and validity of a command.

Definition: Causes the scanner to beep once whenever a K command is entered to indicate that the command was accepted and processed.

Function: If an invalid command is entered, the scanner beeps 5 times to indicate an invalid entry. However, this does not necessarily mean that all data fields have been entered incorrectly. Only one bad field needs to be found in order to activate the 5 beep response.

Serial Cmd: <K701,serial command echo status,serial command beep status,control/hex output>

Default: Disabled

Options: 0 = Disabled 1 = Enabled

Control/Hex Output

Usage: Useful for viewing settings with binary characters when using serial command on a terminal.

Definition: Determines the response to a **Serial Command Echo** or status request command.

When set to **Control**, two characters are transmitted to represent a non-displayable character. For example, a carriage return will be shown as the two characters: **^M**.

When set to **Hex**, the output is the hex character.

Serial Cmd: *<K701,serial command echo status,serial command beep status,control/hex output>*

Default: **Control**

Options: 0 = Control 1 = Hex

EZ Button

The EZ Button has four positions, selectable by the length of time the button is held down, and indicated by one, two, three, and four beeps in succession. Each position can be programmed for any of eight options.

Definition: Serves as a master switch to enable/disable the EZ Button status.

Serial Cmd: <**K770,global status**,default on power-on,load configuration database,save for power-on>

Default: **Enabled**

Options: 0 = Disabled **1 = Enabled** 2 = Trigger
3 = Unlatch Outputs 4 = Parameter Switch

Global Status

Disabled

When set to **Disabled**, the EZ Button does not function.

Enabled

When selected, the EZ Button is enabled and the function of each button position is selected by the **EZ Button Mode** command.

Trigger

When selected, the EZ Button acts as a trigger for the scanner to start and end read cycles. All other button operations are inactive.

In External Level: The read cycle endures for as long as the EZ Button is pressed, unless a timeout occurs and **Timeout** is enabled for **End of Read Cycle**.

In External Edge: As with **Level**, **Edge** allows a read cycle to be initiated by pressing the EZ Button, but unlike **Level**, the read cycle ends with a Good Read output, a timeout, or a new trigger.

Unlatch Outputs

In this configuration, the EZ Button will unlatch any logic outputs that have been latched.

Parameter Switch

The parameter switch toggles between custom defaults and power-on settings. The condition is the same as that achieved by sending the <**Arc**> and <**Arp**> commands consecutively.

Default on Power-On

Definition: When enabled, if the EZ Button is held down on power-on the scanner will default to customer defaults and save for power-on. This is the same as sending a **<Zrc>** command.

Serial Cmd: **<K770,global status,default on power-on,load configuration database,save for power-on>**

Default: **Enabled**

Options: 0 = Disabled **1 = Enabled**

Load Configuration Database

Definition: Allows the user to load the Configuration Database with calibration results. When the user performs a calibration using the EZ Button, all the database entries are moved down one index and the results of the calibration are saved to index 1. The results will be saved as current settings as well.

Serial Cmd: **<K770,global status,default on power-on,load configuration database,save for power-on>**

Default: **Enabled**

Options: 0 = Disabled **1 = Enabled**

Save for Power-On

Definition: If enabled, after calibration is complete, all parameters will be saved for power-on.

Serial Cmd: **<K770,global status,default on power-on,load configuration database,save for power-on>**

Default: **Disabled**

Options: **0 = Disabled** 1 = Enabled

EZ Button Modes

Usage: Useful for performing multiple, repetitive tasks at the work site.

Definition: Allows the user to program each of the EZ Button's 3 positions from a selection of 10 modes.

Serial Cmd: <**K771**,single beep,two beeps,three beeps>

Options:

Single Beep	Two Beeps	Three Beeps
0 = Disabled	0 = Disabled	0 = Disabled
1 = Read Rate	1 = Read Rate	1 = Read Rate
2 = Calibration	2 = Calibration	2 = Calibration
3 = Save for Power-On	3 = Save for Power-On	3 = Save for Power-On
5 = Load New Master	5 = Load New Master	5 = Load New Master
9 = Bar Code Configuration	9 = Bar Code Configuration	9 = Bar Code Configuration

Disabled

When set to disabled, the associated button position will have no function associated with it, and the position will be skipped over.

Read Rate

Read Rate will be initiated when the associated button position is selected. Read Rate will perform decodes/second and is the same as sending a <**C**> from the terminal. To exit Read Rate Mode quickly press and release the EZ Button.

Calibration

Calibration will be initiated when the associated button position is selected. To abort calibration, quickly press and release the EZ Button.

Save for Power-On

All scanner settings will be saved to non-volatile memory to be recalled on power-on whenever the associated button position is selected. This is the same as sending a <**Z**> from the terminal.

Load New Master

Functions in the same way as new master pin input whenever the associated button position is selected. The new master pin's **Consecutive Decode** requirement holds true for this function.

Bar Code Configuration

Enables Bar Code Configuration mode whenever the associated button position is selected. When enabled, the scanner can accept configuration commands from symbols. To disable, quickly press and release the EZ Button.

EZ Button Operation

Single Beep (Position #1)

Hold down button until a single beep is heard.

Two Beeps (Position #2)

Hold down button until two quick beeps are heard.

Three Beeps (Position #3)

Hold down button until three quick beeps are heard.

Input 1

Definition: A programmable, discrete input used to reset counters, outputs or control optoelectrical settings.

Usage: For example, an application is setup so that a mismatch stops the production line by using outputs in a latch mode. A push-button switch can be connected to the input pin so that when pressed, it unlatches the output, allowing the line to resume operations.

Input Mode

Definition: Determines the functionality of the input.

Serial Cmd: <K730, **input mode**, active state>

Default: **Disabled**

Options: 0 = Disabled
1 = Reset Counts
2 = Unlatch Output

Disabled

Definition: When set to **Disabled**, there is no effect on operation.

Reset Counts

Usage: Primarily used in test mode. Can also be used to reset counters daily.

Definition: When set to **Reset Counts**, a transition to the active state of the input will cause the scanner to reset the internal counters (See [Counters](#) on page 12-6).

Unlatch Output

Definition: This setting is used in combination with any of the three discrete outputs that are in **Unlatch Mode 1**. A transition to the active state will clear any of the three outputs that were previously latched.

Active State

Definition: Determines the function of the input pin.

Serial Cmd: <K730, **input mode**, **active state**>

Default: **Active Closed**

Options: 0 = Active Open 1 = Active Closed

Note: If set to **Match** or **Mismatch**, **Symbol Data Output Status** will not take effect unless **Matchcode Type** is enabled and a master symbol is loaded into memory.

Configurable Output 1

Output On

Usage: This option provides discrete signalling to host software to control external devices such as PLCs and relays. It is useful for routing, sorting, and to prevent mis-packaging and mis-routing.

Definition: Sets the discrete output functions for specific user-selected conditions. Allows the user to set the conditions under which an output (or outputs) will be activated.

Serial Cmd: <**K810,output on,output state,pulse width,output mode**>

Default: **Mismatch or No Read**

Options:

- 0 = Mismatch or No Read
- 1 = Match or Good Read
- 2 = Mismatch
- 3 = No Read
- 4 = Trend Analysis
- 5 = [reserved]
- 6 = Diagnostic Warning
- 7 = In Read Cycle

Note: If **Output On** is set to **Mismatch/No Read** or **Match/Good Read**, a transition (switching) will not occur unless **Matchcode Type** is enabled and a master symbol is loaded into memory.

Mismatch or No Read

Activates a discrete output when the data does not match that of the master symbol or the symbol has not been decoded before the end of the read cycle.

Match or Good Read

Activates a discrete output when the symbol data matches the master symbol.

Note: If you want to output for a Good Read and **Matchcode** is not enabled, you can enable any output for **Match**.

Mismatch

Activates a discrete output whenever the symbol data does not match that of the master symbol.

No Read

Activates a discrete output whenever the symbol data is not decoded before the end of the read cycle.

Trend Analysis

Activates discrete output when a trend analysis condition is met, depending on the trend analysis option enabled.

Typically used when successful decodes are occurring but a discrete output is needed to flag a trend in quality issues.

Diagnostic Warning

Activates discrete output when a diagnostic warning condition is met, depending on the diagnostic option enabled.

Typically used when a discrete indication of a diagnostic condition is needed.

In Read Cycle

Activates a discrete output when the scanner is in a read cycle.

Output State

Definition: Sets the active electrical state of the discrete output.

Serial Cmd: <K810,output on,output state,pulse width,output mode>

Default: **Negative**

Options: 0 = Negative 1 = Positive

Pulse Width

Definition: Sets the time in 10 ms increments that the discrete output remains active.

Serial Cmd: <K810,output on,output state,pulse width,output mode>

Default: **50**

Options: 1 to 65535 (Divide the number entered on the command line by 100 for time in seconds)

Output Mode

Definition: Sets the condition in which the discrete output is de-activated.

Serial Cmd: <K810,output on,output state,pulse width,output mode>

Default: **Pulse**

Options: 0 = Pulse
1 = Latch Mode 1
2 = Latch Mode 2
3 = Latch Mode 3

Pulse

This is the default mode of operation in which the programmable output is activated when the **Output On** condition has been met and held active for the duration of the selected pulse width.

Latch Mode 1 (Unlatch on Input 1 Pin)

In this mode the programmable output will be activated when the Output On condition is met. It will stay active until the state of the Input 1 pin changes from inactive to active or the proper mode is configured using the EZ Button.

Important: To unlatch using the **Input 1** pin, the input status must be set to “Unlatch Outputs”. To unlatch using the **EZ Button**, the button status must be set to Unlatch Mode.

Latch Mode 2 (Unlatch Opposite Condition)

The programmable output is activated when the **Output On** condition has been met and held active until the opposite condition selected under **Output On** has been met.

For example, if **No Read** is enabled under **Output On**, the programmable output will go active on a No Read and remain active until the opposite condition, a Good Read, occurs.

Latch Mode 3 (*Unlatch Re-Enter Read Cycle*)

The programmable output is active when the Output On condition has been met and is held active until a new read cycle begins.

Note: All of the **Output On** modes are inhibited when any **Output on Warning** is active for **Output 1**.

Trend Analysis Output 1

Note: **Output On** in **Output 1 Parameters** must be set to **Trend Analysis** for this output to function.

Usage: Useful in cases where the user doesn't want to shut down for one condition but wants to monitor quality and read conditions.

Definition: Applies **Trend Analysis** settings to **Output 1**.
With **Trend Analysis**, the user can track the occurrences and frequency of mismatches, No Reads, and the number of reads per trigger, and output the results to any of three outputs.

Example: *Trend Analysis Mode = No Read*
Number of Triggers = 25 triggers (read cycles)
Number to Output On = 4
Decodes per Trigger = 1
In this example, the scanner will activate an output when **4** No Reads occur within a period of **25** triggers (read cycles), at **1** decode per trigger.

Trend Analysis Mode

Definition: Sets the trend condition (**Mismatch**, **No Read**, **Decodes/Trigger**, **Bad Symbol**, or **No Symbol**) that will activate the output.

Serial Cmd: <**K780**,*trend analysis mode*,*number of triggers*,*number to output on*,*decodes/trigger threshold*>

Default: **No Read**

Options: 0 = Mismatch

1 = No Read

2 = Decodes/Trigger Threshold

3 = Bad Symbol

4 = No Symbol

Mismatch

Output will be activated when the number of mismatches equals the value entered for **Number to Output On** within the trigger window selected in **Number of Triggers**.

No Read

Output will be activated when the number of No Reads equals the value entered for **Number to Output On** within the trigger window selected in **Number of Triggers**.

Decodes/Trigger Threshold

Output will be activated when the number of decodes equals the value entered for **Number to Output On** within the trigger window selected in **Number of Triggers**.

Bad Symbol

Output will be activated when the number of **Bad Symbol** occurrences equals the value entered for **Number to Output On** within the trigger window selected in **Number of Triggers**.

No Symbol

Output will be activated when the number of **No Symbol** occurrences equals the value entered for **Number to Output On** within the trigger window selected in **Number of Triggers**.

Number of Triggers

- Definition:** The number of triggers to examine for the trend analysis condition.
- Serial Cmd:** <K780,trend analysis mode,number of triggers,number to output on,decodes/trigger threshold>
- Default:** 0
- Options:** 0 to 255

Number to Output On

- Usage:** *Example:* If **Number to Output On** is set to 3 and **Trend Analysis Mode** is set to **No Read**, then the output will not be activated until 3 No Reads have occurred.
- Definition:** Sets the number of **Trend Analysis Mode** events (mismatches, No Reads, or reads/trigger as configured by **Trend Analysis Mode**) to occur within the trigger evaluation period before activating the associated output.
- Serial Cmd:** <K780,trend analysis mode,number of triggers,number to output on,decodes/trigger threshold>
- Default:** 0
- Options:** 0 to 255

Decodes/Trigger Threshold

- Definition:** When set to this mode, and when the appropriate output is set to output on trend analysis, the scanner will function in a **Decodes per Trigger** mode during the read cycle and the trend analysis operation. Output will be activated based on whether or not the symbol decode count at the end of the read cycle crosses the decodes per trigger threshold.
- Note:** Although this setup causes the scanner to function in a **Decodes per Trigger** mode, the decode count will only be appended to the symbol data if the status of the **Decodes per Trigger** command is enabled.
- Serial Cmd:** <K780,trend analysis mode,number of triggers,number to output on,decodes/trigger threshold>
- Default:** 0
- Options:** 0 to 65535

Diagnostics Output 1

Note: Output On in Output 1 Parameters must be set to **Diagnostic Warning** for this output to function.

Over Temperature

Serial Cmd: <**K790,over temperature,service threshold,[unused],laser current high,laser current low,low temperature**>

Default: **0**

Options: 0 = Disabled 1 = Enabled

Service Threshold

Serial Cmd: <**K790,over temperature,service threshold,[unused],laser current high,laser current low,low temperature**>

Default: **0**

Options: 0 = Disabled 1 = Enabled

Laser Current High

Serial Cmd: <**K790,over temperature,service threshold,[unused],laser current high,laser current low,low temperature**>

Default: **0**

Options: 0 = Disabled 1 = Enabled

Laser Current Low

Serial Cmd: <**K790,over temperature,service threshold,[unused],laser current high,laser current low,low temperature**>

Default: **0**

Options: 0 = Disabled 1 = Enabled

Low Temperature

Serial Cmd: <**K790,over temperature,service threshold,[unused],laser current high,laser current low,low temperature**>

Default: **0**

Options: 0 = Disabled 1 = Enabled

Configurable Output 2

Note: Output 2 has the same parameters and default settings as Output 1.

Serial Cmd: <K811,output on,output state,pulse width,output mode>

Trend Analysis Output 2

Note: Output On under Output 2 Parameters must be set to Trend Analysis for this output to function.

Serial Cmd: <K781,trend analysis mode,trigger evaluation period,number to output on,decodes/trigger threshold>

Diagnostics Output 2

Note: Output On under Output 2 Parameters must be set to Diagnostic Warning for this output to function.

Serial Cmd: <K791,over temperature,service threshold,unused,laser current high,laser current low,low temperature>

Configurable Output 3

Note: **Output 3** has the same parameters and default settings as **Output 1** and **Output 2**.

Serial Cmd: <**K812**,output on,output state,pulse width,output mode>

Trend Analysis Output 3

Note: **Output On** under **Output 3 Parameters** must be set to **Trend Analysis** for this output to function.

Serial Cmd: <**K782**,trend analysis mode,trigger evaluation period,number to output on,decodes/trigger threshold>

Diagnostics Output 3

Note: **Output On** under **Output 3 Parameters** must be set to **Diagnostic Warning** for this output to function.

Serial Cmd: <**K792**,over temperature,service threshold,unused,laser current high,laser current low,low temperature>

Database Identifier Output

Usage: Useful in keeping track of which database entries read which symbols.

Serial Cmd: <K759,status,separator>

Default: 0

Options: 0 = Disabled 1 = Enabled

Output Status

Disabled

When this command is disabled, no database identifier information will be output.

Enabled

When this command is enabled, the scanner will append a two-digit number and the characters “DB” to the data output following the separator for each symbol decoded using **Configuration Database**. For example, if the separator is an underscore character and the second database entry reads a symbol encoded with “data capture” during the read cycle, the symbol data output will be “data capture_DB02”. If the database is not active, no identifiers will be attached to output.

Separator

Usage: The separator character separates the symbol data from the database identifier.

Serial Cmd: <K759,status,separator>

Default: <space>

Options: Any ASCII character

Quality Output

Definition: Allows the host to track the number of good reads per trigger by appending a five digit numeric field to the end of symbol data.

When enabled, symbol data is followed by a separator, followed by the five digits in the form of **00000**. For example, a certain symbol that has been averaging **00100** decodes per read cycle suddenly drops to **00012**, this would be a good indication that a problem has arisen even though good reads are still occurring.

Usage: Host system can monitor scanning performance (printing process, scanning environment changes, etc.) by setting thresholds in their processing or displaying the outputs for visual verification.

Quality Output Separator

Serial Cmd: <**K704,quality output separator,decodes/trigger status,direction output**>

Default: , (comma)

Options: Any ASCII character

Note: For all serial configuration commands, the following characters cannot be used: **NUL**, **<**, **>**, and **,** .

Decodes/Trigger Status

Serial Cmd: <**K704,quality output separator,decodes/trigger status,direction output**>

Default: **Disabled**

Options: 0 = Disabled 1 = Enabled

Direction Output

Serial Cmd: <**K704,quality output separator,decodes/trigger status,direction output**>

Default: **Disabled**

Options: 0 = Disabled 1 = Enabled

7 Matchcode

Contents

Matchcode by ESP	7-2
Matchcode Serial Commands	7-2
Overview of Matchcode	7-3
Using Master Symbols	7-4
Matchcode Type	7-5
Sequence Step	7-10
New Master Pin	7-11
Match Replace	7-12
Mismatch Replace	7-13

This section explains the Matchcode output functions and setup.

Note: The characters **NUL**, **<**, **>**, and **,** can only be entered through embedded menus, not through **ESP** or serial commands.

Matchcode by ESP



Click this button to bring up the **Matchcode** menu.

To change a setting, **double-click** the setting and use your cursor to scroll through the options.

Parameters	ESP Values
[-] Matchcode	
Matchcode Type	Disabled
Sequential Matching	Increment
Match Start Position	0
Match Length	1
Wild Card	*
Sequence on Noread	Enabled
Sequence Step	1
Sequence on Mismatch	Disabled
New Master Pin	Disabled*
+ Match Replace	Disabled*
+ Mismatch Replace	Enabled

To open nested options, **single-click** the +.

Matchcode Serial Commands

Command Title	Command Format
Matchcode Type	<K223,matchcode type,sequential matching,match start position,match length,wild card character,sequence on No Read,sequence on mismatch>
Master Symbol Database Size	<K224,number of master symbols>
New Master Pin	<K225,status>
Configuration Database	<K227,database index,focus position,gain,tracking,AGC mode,raster top,raster bottom,raster speed,laser framing status,laser on position,laser off position,laser power,background color>
Sequence Step	<K228,sequence step>
Enter/Delete Master Symbol Data	<K231,master symbol number,master symbol data [no data will delete current master symbol data]>
Request Master Symbol Data	<K231,?>[for all] or <K231,master symbol number?>
Match Replacement Message	<K735,status,match replacement message>
Mismatch Replacement Message	<K736,status,mismatch replacement message>

Overview of Matchcode

- Usage:* **Matchcode** is used in applications to sort, route, or verify data based on matching the specific symbol in a variety of ways, as defined in this section. For example, a manufacturer might sort a product based on dates that are embedded in the symbol.
- Definition:* With **Matchcode** you can store master symbol data in the scanner's memory, compare this data against the scanned symbols, and define how symbol data and/or discrete signal output will be directed. A master symbol database can be set up for up to 10 master symbols.

Using Master Symbols

1. Set **Triggering Mode** to **External** or **Serial** (see **Trigger** on page 4-5).
2. Set **Matchcode Type** to an option that fits your application (see **Matchcode Type** on page 7-5).
3. Define the output you want with your matchcode setup:
 - a) Data output (**Symbol Data Output** on page 6-4).
 - b) Discrete output (see **Configurable Output 1** on page 6-20).
4. Select the number of master symbols you want to create. If more than one, send a **<K224,number of master symbols>** command (see **Master Database** on page 12-11).
5. Enter master symbol data in one of the following ways:
 - a) Use **ESP** to type in master symbol data directly into the **Utilities** menu.
 - b) Send a serial command with symbol data in the form of **<M master symbol#, data>** (or **<) data>** for single master symbol only).
 - c) Send a **<Gmaster symbol number>** command to scan the next symbol as the master symbol.
 - d) Enable the **New Master Pin** command and activate a discrete input to store the next symbol scanned as the master symbol (see **New Master Pin** on page 7-11).

Matchcode Type

Note: When **Matchcode** is set to **Enabled**, **Wild Card** or **Sequential**, **Number of Symbols** will default back to **1** (if set to any number greater than 1).

Definition: Allows the user to choose the way that master symbols will be compared with subsequently scanned symbols.

Note: First set **Triggering Mode** to **External** or **Serial**.

Serial Cmd: <**K223**,*matchcode type*,*sequential matching*,*match start position*,*match length*,*wild card character*,*sequence on No Read*,*sequence on mismatch*>

Default: **Disabled**

Options:
 0 = Disabled
 1 = Enabled
 2 = Sequential
 3 = Wild Card

Disabled: Has no effect on operations.

Enabled: Instructs the scanner to compare symbols or portions of symbols with the master symbol.

Sequential Matching: Instructs the scanner to sequence after each match (numeric only) and compare symbols or portions of symbols for sequential numbers.

Note: If **Matchcode Type** is set to **Sequential**, **Number of Symbols** will default back to **1** (if set to any number greater than 1).

Wild Card: Allows the user to enter user defined wild card characters in the master symbol.

Sequential Matching

Usage: Used in tracking product serial numbers that increment or decrement sequentially.

Definition: With **Sequential** enabled under **Matchcode Type**, **Sequential Matching** determines if a count is in ascending (incremental) or descending (decremental) order.

Serial Cmd: <**K223**,*matchcode type*,*sequential matching*,*match start position*,*match length*,*wild card character*,*sequence on No Read*,*sequence on mismatch*>

Default: **Increment**

Options: 0 = Increment 1 = Decrement

Match Start Position

Usage: **Match Start Position** is useful in defining specific portions of a symbol for comparisons. For example, if a symbol contains a part number, manufacturing date, and lot code info but the user is only interested in the part number information, **Match Start Position** can be set to only sort on the part number and ignore the rest of the characters.

Definition: **Match Start Position** determines the portions of symbols that will be matched by defining the first character in the symbol (from left to right) that will be compared with those of the master symbol, when **Matchcode Type** is set to **Enabled** or **Sequential**.

Function: For example, if **Match Start Position** is set to 3, the first 2 characters read in the symbol will be ignored and only the 3rd and subsequent characters to the right will be compared, up to the number of characters specified by **Match Length**.

Serial Cmd: *<K223,matchcode type,sequential matching,match start position,match length,wild card character,sequence on No Read,sequence on mismatch>*

Default: **0**

Options: 0 to maximum length allowed for master symbol

Note: **Match Start Position** must be set to 1 or greater to enable this feature. A 0 setting will disable this feature.

Match Length

Definition: Defines the length of the character string that will be compared with that of the master symbol when **Match Start Position** is set to 1 or greater. When **Match Start Position** is set to 0, no comparison will occur.

Usage: For example, if **Match Length** is set to 6 in a 10 character symbol, and **Match Start Position** is set for 2, only the 2nd through 7th characters (from left to right) will be compared.

Serial Cmd: *<K223,matchcode type,sequential matching,match start position,match length,wild card character,sequence on No Read,sequence on mismatch>*

Default: **1**

Options: 1 to 2710

Wild Card Character

- Usage:** For example, with **Wild Card Character** defined as the default asterisk, defining **CR*34** as the master symbol will result in matches for CR134, CR234, but not CR2345. Entering the wild card at the end of the master symbol as in **CR***** will result in matches for variable symbol lengths such as CR1, CR**23**, CR**358**, etc. provided that the number of wild card characters matches or exceeds the number of characters present.
- Definition:** **Wild Card Character** allows a user to define a wild card character as part of the master symbol.
- Serial Cmd:** **<K223**,matchcode type,sequential matching,match start position,match length,**wild card character**,sequence on No Read,sequence on mismatch>
- Default:** * (asterisk)
- Options:** Any valid ASCII character

Sequence On No Read

Usage: **Sequence On No Read** is useful when the scanner needs to stay in sequence even if no decode occurs.

Definition: When **Sequence On No Read** is **Enabled** and **Matchcode** is set to **Sequential**, the scanner sequences the master symbol on every match or No Read. When disabled, it does not sequence on a No Read.

Serial Cmd: <**K223**,matchcode type,sequential matching,match start position,match length,wild card character,**sequence on No Read**,sequence on mismatch>

Default: **Enabled**

Options: 0 = Disabled 1 = Enabled

As an example of **Sequence on No Read Enabled**, consider the following series of decodes:

Master symbol	Decoded symbol	Master symbol after decode
001	001	002
002	002	003
003	No Read	004 (sequenced on No Read)
004	004	005
005	No Read	006 (sequenced on No Read)
006	No Read	007 (sequenced on No Read)
007	007	008

As an example of **Sequence on No Read Disabled**, consider the following series of decodes:

Master symbol	Decoded symbol	Master symbol after decode
001	001	002
002	002	003
003	No Read	003 (not sequenced)
003	003	004
004	No Read	004 (not sequenced)
004	No Read	004 (not sequenced)
004	004	005

Sequence On Mismatch

Note: Matchcode must be set to **Sequential** for this command to function.

Usage: Enable this parameter if every trigger event should have a decode *and* more than one consecutive mismatch may occur.
Disable this parameter if every trigger event should have a decode but no more than one consecutive mismatch may occur.

Definition: When set to **Enabled**, the master symbol sequences on every decode, match or mismatch.
When set to **Disabled**, the master symbol will not sequence whenever consecutive mismatches occur.

Serial Cmd: <**K223**,matchcode type,sequential matching,match start position,match length,wild card character,sequence on No Read,**sequence on mismatch**>

Default: **Disabled**

Options: 0 = Disabled 1 = Enabled

The scanner will sequence the master to one more/less than the decoded symbol. As an example of **Sequence On Mismatch Enabled**, consider the following decodes:

<i>Master symbol</i>	<i>Decoded symbol</i>	<i>Master symbol after decode</i>
001	001	002
002	002	003
003	abc	004 (sequenced on mismatch)
004	004	005
005	def	006 (sequenced on mismatch)
006	ghi	007 (sequenced on mismatch)
007	007	008

As an example of **Sequence On Mismatch Disabled**, consider the following decodes:

<i>Master symbol</i>	<i>Decoded symbol</i>	<i>Master symbol after decode</i>
001	001	002
002	002	003
003	abc	004 (sequenced because of previous match)
004	004	005
005	def	005 (sequenced because of previous match)
005	ghi	005 (not sequenced because of previous mismatch)
005	005	006

You can access **Master Symbol** operations from the **Utilities** menu.

Sequence Step

Usage: Useful in applications in which it is desirable to count by intervals other than 1.

Definition: Sequencing in **Matchcode** operations can occur in steps from 1 to 32,768. Sequencing performs like a mechanical counter by displaying positive integers and a specific number of digits after rollovers. For example, 000 – 3 = 997 (not –3) and 999 + 3 = 002 (not 1002).

Serial Cmd: <K228,sequence step>

Default: 1

Options: 1 to 32768

Note: See <K223> (**Matchcode Type** on page 7-5) for more information.

As an example of **Sequence Step**, if **Sequence Step** is set to 3 and **Sequential Matching** is set to **Increment**.

<i>Master Symbol</i>	<i>Decoded Symbol</i>	<i>Master Symbol After Decode</i>
003	001	003
003	002	003
003	003	006
006	004	006
006	005	006
006	006	009

New Master Pin

Usage: Some applications require the line worker to change the master symbol. This can be done by installing a switch at the location of the scanner. It is very common to have a keyed switch so that accidental switching does not occur.

Definition: After **New Master Pin** is enabled, a pulse can be received on the new master pin which will cause the scanner to record the next decoded symbol(s) as the new master symbol(s).

It is important to note that the enabling **New Master Pin** does not in itself cause a master symbol to be recorded. The master pin must then be activated momentarily (for a minimum of 10 ms) before a master symbol can be scanned into memory.

Serial Cmd: <**K225,status**>

Default: **Disabled**

Options: 0 = Disabled 1 = Enabled

After **New Master Pin** has been enabled and the pin activated, decodes will be saved in the master database beginning with master symbol #1. If the scanner is configured for a multisymbol read cycle (**Number of Symbols** is greater than 1), the remaining decodes will be saved in each consecutive master symbol location. For example, if **Number of Symbols** is set to **3** and **New Master Pin** is then activated, at the end of the next read cycle, the decoded symbols will be saved as master symbols 1, 2, and 3.

Match Replace

Usage: Provides a convenient shortcut for applications that need to output a predefined text string whenever a symbol matches a master symbol.

Definition: Outputs a user-defined data string whenever a match occurs and **Matchcode** is enabled.

Serial Cmd: <**K735**,*status*,*replacement string*>

Default: **Disabled**

Options: **0 = Disabled** 1 = Enabled

Replacement String

Definition: User-defined data string that, when enabled, replaces symbol data whenever a match occurs.

Serial Cmd: <**K735**,*status*,**replacement string**>

Default: **MATCH**

Options: 1 to 128 ASCII characters

Mismatch Replace

Usage: Provides a convenient shortcut for applications that need to output a predefined text string whenever a symbol does not match a master symbol.

Definition: Outputs a user-defined data string whenever a mismatch occurs and **Matchcode** is enabled.

Serial Cmd: <**K736**,*status*,*replacement string*>

Default: **Disabled**

Options: **0 = Disabled** 1 = Enabled

Replacement String

Definition: User-defined data string that, when enabled, replaces symbol data whenever a mismatch occurs.

Serial Cmd: <**K736**,*status*,***replacement string***>

Default: **MISMATCH**

Options: 1 to 128 ASCII characters

Mismatch Replace

8 Diagnostics

Contents

Diagnostics by ESP.....	8-2
Diagnostics Serial Commands.....	8-2
Counts.....	8-3
Hours Since Last Reset.....	8-4
Warning Messages.....	8-5
Laser Current Warning.....	8-7
Present Operating Temperature (Deg. C).....	8-8
High Temperature Threshold.....	8-9
Low Temperature Threshold.....	8-10
Lifetime Hours.....	8-11
Service Message.....	8-12

This section describes warning and operating messages and their settings.

Important: Since **Warning Messages** and **NOVRAM Messages** are not enabled by default, these messages will not be displayed. However, if you suspect that erroneous defaults are occurring, enable **Warning Messages** and **NOVRAM Messages** by sending **<K"400,1,,1>**.

Note: The characters **NUL**, **<**, **>**, and **,** can only be entered through embedded menus, not through **ESP** or serial commands.

Diagnostics by ESP



Click this button to bring up the **Diagnostics** menu.

Parameters	ESP Values
[-] Diagnostics	
[+] Counts (Read Only)	
[+] Hours Since Reset (Read Only)	
[+] Laser High	
[+] Laser Low	
[-] High Temperature Threshold	
Status	Disabled*
Message	Disabled*
[+] Low Temperature Threshold	Enabled
[+] Service Message	

To open nested options, **single-click** the +.

To change a setting, **double-click** the setting and use your cursor to scroll through the options.

Diagnostics Serial Commands

Command Title	Command Format
Warning Message Status	<K400,warning message status,laser high status,laser low status,NOVRAM/reset warning status>
Lifetime Hours	<K401,hours x 10,message>
High Temperature Warning	<K402,status,message>
Low Temperature Warning	<K403,status,message>
Power-On/Resets Counts	<K406?> returns: <K406,power-ons,resets,parameter saves> (Read-Only)
Hours Since Last Reset	<K407?> returns: <K407,hours,minutes> (Read-Only)
Present Operating Temperature	<K408?> returns: <K408,current operating temp.> (Read-Only)
Service Message	<K409,status,message,time,resolution>
Laser Current Warning	<K411,high current status,high current message,low current warning,low current message>

Counts

(This command is **Read-Only**.)

Power-Ons

Definition Returns the number of times the scanner has been re-powered or a watchdog reset occurs.

Serial Cmd: Send: <**K406?**>
Returns: <**K406**,*power-ons*,*resets*,*parameter saves*>

Read-Only Range: 0 to 65535 power-ons.

Resets

Usage: Used for detecting unwanted resets caused by power supply problems or ESD transients.

Definition Resets include watchdog reset, <**A**> and <**Z**> commands, and hardware defaults. A watchdog reset is a reset that is forced whenever the software locks up.

Serial Cmd: Send: <**K406?**>
Returns: <**K406**,*power-ons*,*resets*,*parameter saves*>

Read-Only Range: 0 to 65535 resets.

Parameter Saves

Definition Returns the number of times parameters are written to memory, including <**Z**> commands and hardware defaults.

Serial Cmd: Send: <**K406?**>
Returns: <**K406**,*power-ons*,*resets*,*parameter saves*>

Read-Only Range: 0 to 65535 saves.

Hours Since Last Reset

(This command is **Read-Only**.)

Usage: Used as a troubleshooting tool that can help pinpoint the cause of a reset.

Definition: Records the number of hours and minutes of operation since the last system reset.

Serial Cmd: Send: <**K407?**>
Returns: <**K407, hours, minutes**>

Read-Only Ranges: 0 to 255 hours, 0 to 59 minutes.

Warning Messages

Important Note: Warning Message Status must be enabled before any warnings in this menu can be displayed.

Usage: These messages serve as a flag to service a scanner or as an early warning that potential problems could arise. They are particularly useful in factories that run constantly and can't afford down time.

Definition: Warning messages that relate to the environment and condition of the scanner can be defined and set to activate specific outputs.

Note: When enabled, the error condition will override all other operational modes configured for the output. When enabled, laser current and NOVRAM warning messages will be transmitted to the host or any active port whenever the pre-defined conditions are met.

Function: When enabled, warning messages will be transmitted to the host or any active port.

Note: This option must be enabled before any other warning messages can be transmitted.

Warning Message Status

Serial Cmd: <**K400,warning message status**,laser high status,laser low status,NOVRAM/reset warning status>

Default: **Disabled**

Options: 0 = Disabled
1 = Enabled

Laser High Status

When enabled, a message is transmitted whenever the laser current exceeds a factory-calibrated reference value which cannot be altered. The message repeats once every 30 minutes until the condition is corrected.

Usage: Alerts the user to impending laser failure.

Definition: Enables the **Laser High** message.

Serial Cmd: <**K400,warning message status**,**laser high status**,laser low status,NOVRAM/reset warning status>

Default: **Enabled**

Options: 0 = Disabled 1 = Enabled

Laser Low Status

When enabled, a message is transmitted whenever the laser current falls below a factory-calibrated reference value which cannot be altered. The message repeats once every 30 minutes until the condition is corrected.

Usage: Alerts the user to impending laser failure.

Definition: Enables the **Laser Low** message.

Serial Cmd: <K400,warning message status,laser high status,**laser low status**,NOVRAM/reset warning status>

Default: **Enabled**

Options: 0 = Disabled 1 = Enabled

NOVRAM/Reset Warning Status

When enabled, a 7-character message is sent whenever the system detects a warning condition.

Important: Warning Message Status must be enabled before the **NOVRAM** message in this menu can be transmitted.

Usage: Alerts the user to NOVRAM failure.

Serial Cmd: <K400,warning message status,laser high status,laser low status,**NOVRAM/reset warning status**>

Default: **Enabled**

Options: 0 = Disabled
1 = Enabled

Note: If you suspect that erroneous defaults are occurring, enable **NOVRAM Messages** by sending <K400,1,,,1>. This will allow the **NOVRAM** messages, if present, to be viewed.

Warning messages for NOVRAM can appear in one of five formats:

<NVRAM-C>

This message indicates an error in user settings. The message repeats once every 30 minutes. If this message is received, restore customer settings and send a <Z> command.

<NVBAD-D>

Indicates that diagnostic lifetime hours, power-on counts, and reset counts have been lost. The message repeats once every 30 minutes.

<NVBAD-L>

Indicates a problem with laser current factory reference. The message repeats once every 30 minutes.

<DFALT-C>

Indicates that the customer NOVRAM settings have been defaulted either by a customer initiated default or by a problem with the scanner. This message is sent ONLY ONCE.

<DFALT-F>

Indicates that the factory NOVRAM settings have been defaulted. This message is sent ONLY ONCE upon reset.

Laser Current Warning

Alerts the user to impending laser failure.

High Current Status

Definition: The **High Current** message is output whenever the laser current exceeds the factory-defined maximum. The message repeats once every 30 minutes until the condition is eliminated.

Serial Cmd: <**K411,high current status,high current message,low current status,low current message**>

Default: **Disabled**

Options: 0 = Disabled
1 = Enabled

High Current Message

Definition: This message is output whenever the laser current exceeds the factory-defined maximum.

Serial Cmd: <**K411,high current status,high current message,low current status,low current message**>

Default: **HIGH_LASER**

Options: Any ASCII string up to 10 characters.

Low Current Status

Definition: The **Low Current** message is output whenever the laser current exceeds the factory-defined minimum. The message repeats once every 30 minutes until the condition is eliminated.

Serial Cmd: <**K411,high current status,high current message,low current status,low current message**>

Default: **Disabled**

Options: 0 = Disabled
1 = Enabled

Low Current Message

Definition: This message is output whenever the laser current exceeds the factory-defined minimum.

Serial Cmd: <**K411,high current status,high current message,low current status,low current message**>

Default: **LOW_LASER**

Options: Any ASCII string up to 10 characters.

Present Operating Temperature (Deg. C)

(This command is **Read-Only**.)

Usage: Used for setting **Over Temperature Threshold** and **Under Temperature Threshold**.

Definition: Indicates temperature of the environment immediately outside of the scanner. A thermal sensor on the main PCB measures the internal temperature of the scanner. From this, a case-differential constant is subtracted to yield an estimated external temperature.

Serial Cmd: Send: **<K408?>**
Returns: **<K408,current operating temp. (degrees C)>**

Note: When viewing the **Present Operating Temperature**, allow at least 20 minutes after startup for the scanner's inside and outside temperatures to stabilize.

High Temperature Threshold

A message can be defined that will display when a user-set **High Temperature Threshold** has been reached. The message repeats once every 30 minutes until the condition is corrected. This value is a reference to the external ambient temperature in the environment around the scanner.

High Temperature Degrees

Usage: Helps ensure that the scanner is being used within its temperature specification. Also, since hotter environments tend to shorten the life of electronics components, a user may want to set the temperature threshold closer to the nominal temperature of 25°.

Definition: A user can set a temperature value that when exceeded will cause a high temperature message to be displayed. If **High Temperature Threshold** is set to zero, then the warning message will be disabled.

Serial Cmd: <**K402**,*status*,*message*>

Default: **Disabled**

Options: 0 = Disabled
1 = Enabled

High Temperature Message

Definition: The user can enter a message of up to 10-characters that will be displayed whenever **High Temperature Threshold** is exceeded.

Serial Cmd: <**K402**,*status*,*message*>

Default: **HIGH_TEMP**

Options: Any 1 to 10 character ASCII string except **NUL**, <, or >.

Low Temperature Threshold

Low Temperature Degrees

Usage: Helps ensure that the scanner is being used within its temperature specification.

Definition: The user can set a low temperature value that, whenever the ambient temperature falls below it, causes a low temperature message to be displayed. If Low Temperature Threshold is set to zero, the warning message will be disabled.

Serial Cmd: <K403,status,message>

Default: **Disabled**

Options: 0 = Disabled
1 = Enabled

Low Temperature Message

Definition: The user can enter a message of up to 10-characters that will be displayed whenever the ambient temperature falls below the **Low Temperature Threshold**.

Serial Cmd: <K403,status,message>

Default: **LOW_TEMP**

Options: Any 1 to 10 character ASCII string except **NUL**, **<**, or **>**.

Lifetime Hours

A message can be defined that will be transmitted whenever the scanner's elapsed time clock exceeds the set hours threshold. The message repeats one time every 30 minutes.

Hours Threshold

Usage: Used for setting up a preventive maintenance program.

Definition: A user can set a time in hours that will cause a message to be sent whenever the scanner's run time exceeds this value.

The elapsed time is the time the scanner is powered up.

Serial Cmd: <**K401, hours x 10, message**>

Default: **2500** (x 10 = 25,000 hours)

Options: 0 to 65534

Note: Hours entered are 1/10 of the actual hours.

Message

Definition: The user can enter a message of up to 10-characters that will be displayed whenever the hours threshold is reached or exceeded.

Serial Cmd: <**K401, hours x 10, message**>

Default: **SERVICE**

Options: Any 1 to 10 character ASCII string except **NUL**, **<**, or **>**.

Service Message

When **Service Message** is enabled, a message of up to 10 ASCII characters is sent whenever the system detects that the service timer's limit has been reached. The service timer is reset at power-on, meaning that the service timer's limit is the amount of time since last reset. Service timer increments can be set in seconds or minutes.

Serial Cmd: <**K409,status,service message,threshold,resolution**>

Default: **0**

Options: **0 = Disabled** 1 = Enabled

Service Message

Serial Cmd: <**K409,status,service message,threshold,resolution**>

Default: **SERVICE**

Options: An ASCII string between 1 and 10 characters.

Threshold

Serial Cmd: <**K409,status,service message,threshold,resolution**>

Default: **300** (5 minutes)

Options: 1 to 65535

Resolution

Serial Cmd: <**K409,status,service message,threshold,resolution**>

Default: **Seconds**

Options: **0 = Seconds** 1 = Minutes

9 Calibration

Contents

Calibration Serial Commands	9-2
Calibration Steps.....	9-3
Calibration Routine	9-4
Calibration Results.....	9-5
Configuration Database	9-6
Optoelectric Control	9-8
Advanced Calibration Features.....	9-14
Calibration by Embedded Menu.....	9-17

The purpose of calibration is to optimize the scanner's optical settings (focus, gain, and tracking) and scan speed to obtain the highest read rates in one or several symbol positions as required by the user's application. This section includes the overall steps in calibration and specific steps for calibration by **ESP**, serial command, and embedded menus. For most applications calibration is the only optical setup required.

Changes to motor speed, focus, speed, gain, tracking, and AGC can also be made individually by manual command.

Calibration Methods

There are three ways to initiate calibration:

- **ESP** Calibration menu
- Serial command **<@CAL>**
- Embedded menu **<@>**

Note: Calibration does not function with PDF417 symbols. However, you can substitute a Code 128 symbol with the same mil size as your PDF417. When you do this, enable **Code 128** and disable **Raster** scanning. After calibration, switch back to **PDF417** and **Raster** scanning.

Calibration Serial Commands

Command Title	Command Format
Optoelectric Control	< K226 ,mode,# active database settings,latch on trigger, timer/switch value,control trigger 1 status,control trigger 2 status,control trigger 3 status,database cycles>
Configuration Database	< K227 ,database index,focus position,gain,tracking,AGC mode,raster top,raster bottom,raster speed,laser framing status,laser on position,laser off position,laser power, background color>
Save Configuration Database	< K227+ ,database index>
Load Configuration Database	< K227- ,database index>
Request Configuration Database	< K227? ,database index> or < K227? > for entire database.
Autocalibration	< K510 ,auto range,starting focus position,focus step size>

Calibration Steps

Follow this procedure for all three methods of calibration:

1. Position your symbol at the distance used in your application and confirm that it is at a distance within the specifications for that symbol size (see [Position Scanner and Symbol](#) on page 1-5).
2. If you are not certain of the code type, enable all code types by sending a **<P>** command from the terminal window, or clicking on the **Autodiscrimination** button in **Calibration/Advanced** in **ESP**.
3. Start the calibration procedure.

Note: Once a successful calibration is completed, you may want to save the setting to the calibration database (see [Configuration Database](#) on page 9-6).

4. Repeat calibration at other ranges and/or symbol types you might be scanning in your application.
5. Check your readings at each end of the scan width required for your application, keeping in mind that the scan width testing may not produce results that are entirely symmetrical.

Note: If you are setting up for laser framing, be sure that you only test for calibration in the active areas of the scan beam.

6. To save the new settings (including focus, gain, and tracking) for power-on, use the **Send/Recv** button or send a **<Zp>** command.

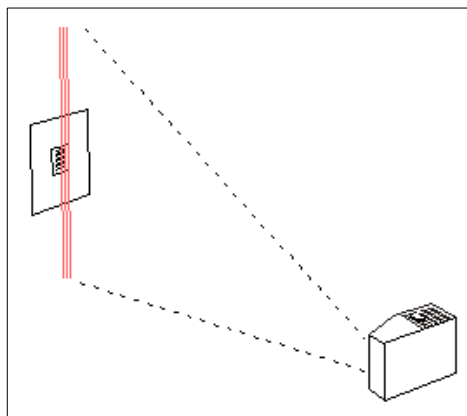

See [Configuration Database](#) on page 9-6 to learn how to setup a database using calibration or manually specified values.

See [Advanced Calibration Features](#) on page 9-14 for ways to speed up and improve your calibration process.

Note: To silence the beeper, send **<K702,0>** or remove or block the test symbol.

Calibration Routine

To calibrate gain, tracking, focus position, and scan speed automatically:

1. Click the **Calibration** button near the top of the screen.



2. Click the **Calibrate** button to start calibration.

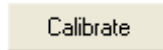

A "Calibration in Progress..." message will be displayed on your monitor along with the pass number and information on the focus position, gain, tracking and read rate.

Allow some time for the scanner to cycle through the settings. Do not move or disturb the scanner or symbol while calibration is in progress. (It might take 2 to 3 minutes to complete.)

3. When completed, the settings that provided the highest read rate will be selected. You will see one of the following messages: "Calibration Passed" or "Calibration Failed".
If calibration passed, you will continue to see the read rate percentage and symbol data in the open pane below the data.

Calibration by Serial Command

To start the calibration process by serial command, send **<@CAL>** from **ESP's Terminal**.

Calibration Results

When a calibration command is sent, the scanner first steps through a coarse grid of focus settings, looking for readable symbols, and recording the highest read rates it encounters. This is **Pass 1**. During **Pass 2**, the scanner returns to the focus position where it found the best read rate and steps through a finer grid of focus, gain and tracking settings. The software evaluates the results and selects the best data. If calibration passes, a “Calibration Passed” message is displayed at the top of the window.

To load the settings obtained from calibration into the Configuration Database:

1. Perform the calibration routine described in [Calibration Routine](#) on page 9-4.
2. Click on the **Configuration Database** tab.
3. Set **Number of Active Database Settings** and make your selection in **Optoelectric Control** in the menu tree to the left of the **Database** tab.
4. Click on an index to load standard settings.
5. Click **Load Standard Settings to Database** button.

This will put **Focus**, **Gain**, and **Tracking** settings that resulted from calibration into the database index.

6. Repeat this procedure for other indexes.

You can also enter individual values in any of the seven indexes by double-clicking anywhere on the index row and making changes in the popup text box.

Configuration Database

Configuration Database by Serial Command

Note: You can also set **Focus**, **Gain Settings**, **Tracking Adjustment**, **Scan Speed**, **Laser Framing**, and **Background Color** individually.

Definition: The **Configuration Database** allows the user to save multiple scanner configuration settings. The database can be used to save the most commonly used configurations, making the scanner easily adaptable to changing applications, or it can be used in conjunction with **Optoelectric Control**, to change configurations dynamically.

When **Optoelectric Control** is set to **Control Trigger (Optoelectric Control Mode)**, the first seven indexes can be switched by external inputs. Each database configuration setting is assigned to a control trigger sequence.

The table below illustrates the relationship between control trigger sequence and database indexes.

Index	Active Trigger(s) = 1, 2, 3			Active Trigger(s) = 1, 2			Active Trigger(s) = 1		
	Control Triggers			Control Triggers			Control Triggers		
	3	2	1	3	2	1	3	2	1
1	0	0	1	Disabled	0	0	Disabled	Disabled	0
2	0	1	0		0	1			1
3	0	1	1		1	0			N/A
4	1	0	0		1	1			N/A
5	1	0	1		N/A	N/A			N/A
6	1	1	0		N/A	N/A			N/A
7	1	1	1		N/A	N/A			N/A

0 = Inactive Input State

1 = Active Input State

Serial Cmd: <K227,database index,focus position,gain,tracking,AGC mode,raster top,raster bottom,raster speed,laser framing status,laser on position,laser off position,laser power, background color>

Important: Control Trigger 3 uses the **External Trigger** input. When this input is active, there is no external trigger available to the scanner. Therefore, when Control Trigger 3 is active and **External Trigger Mode** is selected, a read cycle will be triggered by an active input from any of the control trigger inputs.

Since an active state on one of the control inputs is required to trigger a read cycle, sequence "000" would not be valid. When Control Trigger 3 is active, the sequence starts at "001". This allows a maximum of **7** accessible database settings. When Control Trigger 3 is not active, the sequence starts with all active inputs disabled.

Configuration Database by ESP

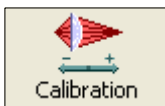

Click this button to bring up the **Calibration** view. Then select the **Configuration Database** tab to display the view shown below.

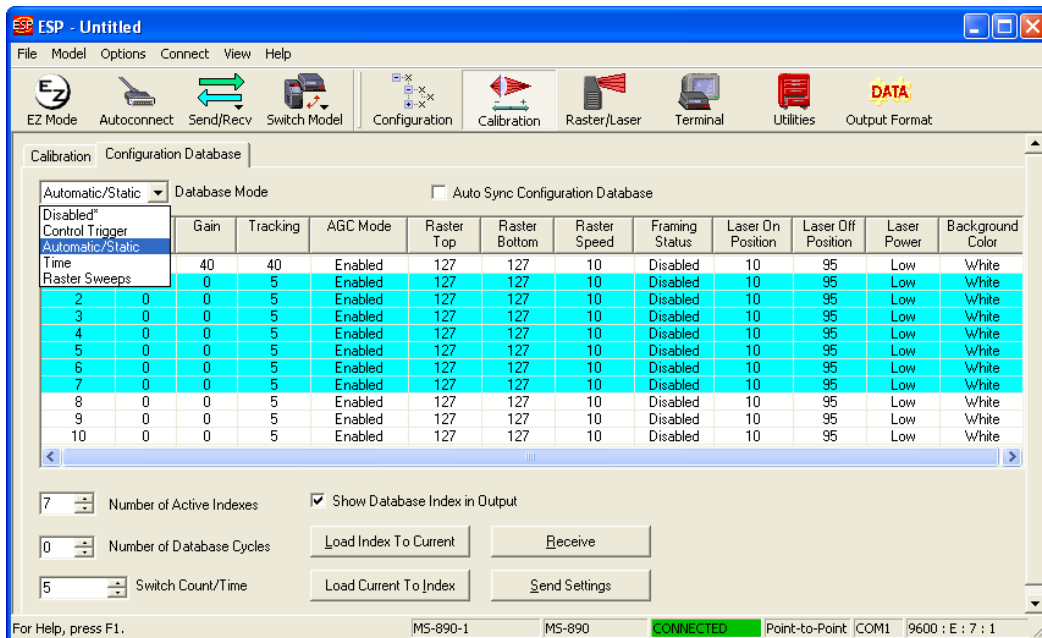

All the database settings in the **<K227>** command can be configured in this graphic interface.

Save Settings to Configuration Database

To save index values by serial command, use the following: **<K227+,database index>**

Load Settings from Configuration Database

To load index values by serial command, use the following: **<K227-,database index>**

Request Configuration Database Settings

To request index values, use the following: **<K227?,database index>** or **<K227?>** for entire database.

Optoelectric Control

Note: Optoelectric Control requires the assembly of a **Configuration Database**.

Optoelectric Control Mode

Usage: Useful where different symbol types, sizes, qualities or distances require more than one optical setup (focus, gain, and tracking) for dynamic optical changes.

Definition: A database index of up to seven pre-defined optical indexes of settings defining focus, gain, and tracking can be accessed and applied in the following modes:

- A timer in which all settings cycle throughout the time duration.
- An automatic search for the best database index.
- A combination of up to three control trigger inputs to dynamically select the optimum database index.

The index settings can also be saved and recalled selectively, or reviewed with a **Request Database Settings** command.

Serial Cmd: `<K226,mode,# active database settings,latch on trigger,timer/switch value,control trigger 1 status,control trigger 2 status,control trigger 3 status,database cycles>`

Default: **Disabled**

Options:

- 0 = Disabled
- 1 = Control Trigger
- 2 = Automatic/Static Mode
- 3 = Timer
- 4 = Number of Raster Sweeps

Disabled

Definition: When disabled, the scanner uses the standard configuration settings that are set in the Calibration tree and shown to the right of **Standard** in the **Database Index**.

Serial Cmd: `<K226,mode,# active database settings,latch on trigger,timer/switch value,control trigger 1 status,control trigger 2 status,control trigger 3 status,database cycles>`

Control Trigger (Optoelectric Control Mode)

Usage: Useful where different symbol types, sizes, and/or distances benefit from pre-defined optical setups (focus, gain, and tracking) that can be accessed 'on the fly' according to the combination of input states.

Definition: When **Optoelectric Control** mode is set to **Control Trigger**, input 1, new master pin, and the trigger input pins are de-activated and re-assigned as control triggers. When activated, a read cycle will be triggered and—in accordance with their respective states—selected from a database of up to seven pre-defined optical settings of **Focus**, **Gain**, and **Tracking**. (See [Configuration Database](#) on page 9-6)

Serial Cmd: `<K226,mode,# active database settings,latch on trigger,timer/switch value,control trigger 1 status,control trigger 2 status,control trigger 3 status,database cycles>`

Using Control Trigger

Set up your application's symbols by symbology type/size in the various positions and/or code type/size at which they will likely appear.

Set up your sensors or other controls. For example, the three object sensors, 1, 2 and 3, are connected to input 1, new master pin, and trigger input respectively. The bar-coded packages on the left are numbered here according to their database index numbers. Package # 7 will cross all three of the sensors and thus activate the settings for index # 7.

In this scenario only four index settings are possible. However, up to seven combinations are possible with other input devices such as PLCs.

You can also enable/disable any combination controls by clicking on the **Control Trigger Status** buttons on the bottom of the **Control Trigger Map**. The red buttons indicate active states on the three control triggers. The combination of active/inactive triggers determines the focus, gain, and tracking settings that will be applied during a read cycle. For example, if only **Control Trigger 1** is active, the focus, gain, and tracking values that appear in the top row will be applied.

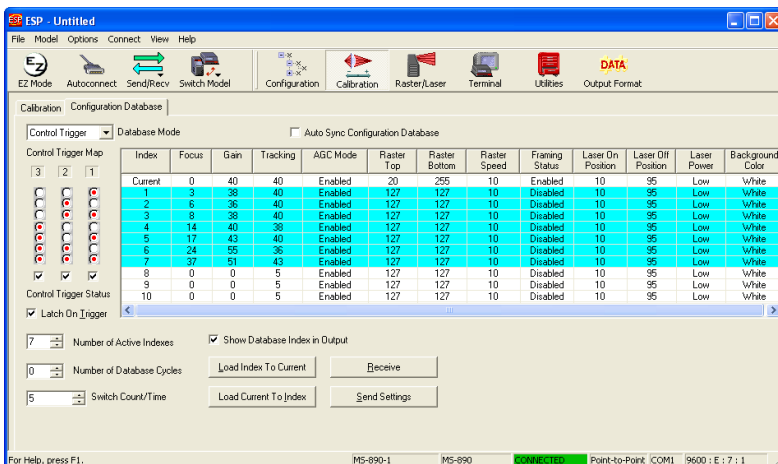

Automatic/Static (Optoelectric Control Mode)

Usage: Useful in a static application in which the symbol is in front of the scanner when the read cycle begins.

Definition: Selects the optimum setting from the **Configuration Database**. When selected, the scanner cycles once through all the **Configuration Database** settings from the closest to the furthestmost focal position, testing first for optimal signal, then for a successful decode.

Note: Since focus positions are tested in ascending order, the closer the symbols are to the scanner, the quicker the best focus position will be found.

Important: The maximum time to move from the most inside focus position to the most outside focus position is **400 ms**. One focus position change takes **10 ms**.

Serial Cmd: *<K226,mode,# active database settings,latch on trigger,timer/switch value,control trigger 1 status,control trigger 2 status,control trigger 3 status,database cycles>*

Timer Mode (Optoelectric Control Mode)

Usage: Useful in applications in which there is enough time to cycle through the database index.

Definition: When this mode is selected, the scanner cycles through database settings at a time interval determined in **Timer Value** setting. (See **Timer/Switch Value** on page 9-11.)

Important Note: The maximum time to move from the most inside focus position to the most outside focus position is **400 ms**. One focus position change takes **10 ms**.

Serial Cmd: *<K226,mode,# active database settings,latch on trigger,timer/switch value,control trigger 1 status,control trigger 2 status,control trigger 3 status,database cycles>*

Note for Multisymbol: With **Multisymbol** enabled for more than one symbol, and either **Timer** or **Automatic/Static** mode enabled, the scanner may not locate symbols that are scanned at various ranges. The reason for this is that once a symbol is located from the optical database index, the scanner will continue to search for symbols that meet that index of focus, tracking and gain settings.

Number of Active Database Settings

- Usage:** Can be useful when certain settings that are needed for one application are not needed in another and processing time is at a premium.
- Definition:** This value sets the number of configuration database settings (in **Database Index**) that are active. If **Control Trigger** mode has been selected, this setting is ignored.
- Serial Cmd:** <**K226**,mode,# active database settings,latch on trigger,timer/switch value,control trigger 1 status,control trigger 2 status,control trigger 3 status,database cycles>
- Default:** 1
- Options:** Any number from 1 to 7.

Latch on Trigger

- Usage:** Useful when only one database index is required for the application.
- Definition:** This feature is only used in **Control Trigger** mode. If enabled, the configuration database settings selected at the start of a read cycle will remain active during the entire read cycle. If **Latch on Trigger** is disabled, depending on the control trigger inputs, the scanner's optical settings can change throughout the read cycle.
- Note:** When **Control Trigger #3** is enabled, **Latch on Trigger** is also enabled regardless of its previous setting.
- Serial Cmd:** <**K226**,mode,# active database settings,latch on trigger,timer/switch value,control trigger 1 status,control trigger 2 status,control trigger 3 status,database cycles>
- Default:** Enabled
- Options:** 0 = Disabled
1 = Enabled

Timer/Switch Value

- Usage:** Useful in slower applications where there is enough time to cycle through the database index.
- Definition:** When **Timer** mode is enabled, **Timer Value** is the time interval in which database index settings are cycled.
- Serial Cmd:** <**K226**,mode,# active database settings,latch on trigger,timer/switch value,control trigger 1 status,control trigger 2 status,control trigger 3 status,database cycles>
- Default:** 5
- Options:** 0 to 255 (increments of 10ms)

Control Trigger 1 Status

Definition: When **Control Trigger** mode is enabled, **Control Trigger #1** takes over **Input 1** (see **Input Mode** on page 6-19) and uses it to select an optoelectric configuration from the configuration database. Active state is set by **Input 1** serial command.

Serial Cmd: <K226,mode,# active database settings,latch on trigger,timer/switch value,**control trigger 1 status**,control trigger 2 status,control trigger 3 status,database cycles>

Default: **Disabled**

Options: 0 = Disabled
1 = Enabled

Control Trigger 2 Status

Definition: **New Master Pin** is used for **Control Trigger #2**. When enabled and **Mode** is set to **Control Trigger**, this input is used to select an optoelectric configuration from **Configuration Database**. **Active State** is “Active Closed”.

Serial Cmd: <K226,mode,# active database settings,latch on trigger,timer/switch value,control trigger 1 status,**control trigger 2 status**,control trigger 3 status,database cycles>

Default: **Disabled**

Options: 0 = Disabled
1 = Enabled

Control Trigger 3 Status

Definition: **Trigger Input** is used for **Control Trigger #3**. When enabled and **Mode** is set to **Control Trigger**, this input is used to select an optoelectric configuration from the **Configuration Database**. **Active State** is set by the **External Trigger State** serial command.

Serial Cmd: <K226,mode,# active database settings,latch on trigger,timer/switch value,control trigger 1 status,control trigger 2 status,**control trigger 3 status**,database cycles>

Default: **Disabled**

Options: 0 = Disabled
1 = Enabled

Database Cycles

Definition: **Database Cycles** refers to the number of times the scanner will load the series of active entries when it is set to **Timer** or **Raster Sweep** modes. When set to **0**, the scanner will cycle repeatedly through all active database entries until the read cycle ends. When set to a value greater than **0**, the scanner will only load the active database entries for the defined number of times before staying with the last active entry for the remainder of the read cycle.

Serial Cmd: **<K226,mode,# active database settings,latch on trigger,timer/switch value,control trigger 1 status,control trigger 2 status,control trigger 3 status, database cycles>**

Default: **0**

Options: 0 to 255

Advanced Calibration Features

In the **Advanced** tab in the **Calibration** menu you can constrain the scan width of the scan beam with **Laser Framing** and set up the rules the scanner will follow during calibration procedure. See **Laser Framing** on page 10-7 for information on laser framing.

Auto Range

Usage: Enabling **Auto Range** improves focus acquisition speed where extraneous objects are not mistaken for symbols.

Definition: With **Auto Range** enabled, the scanner will focus outward and not begin the calibration routine until an object is detected by signal strength.

Serial Cmd: *<K510,auto range,starting focus position,focus step size>*

Default: **Enabled**

Options: 0 = Disabled
1 = Enabled

Using Auto Range

1. Be sure there are no extraneous objects between the symbol and the scanner.
2. Click on the **Advanced** tab in the **Calibration** menu.
3. If **Auto Range** is not enabled, click on it to enable it.
4. Click the **Calibrate** button to start calibration.
5. Examining the read rates in the **Results** graph following calibration.

Starting Focus Position

Usage: **Starting Focus Position** can improve focus acquisition speed during calibration when the approximate range of the symbol is known.

Definition: With **Auto Range** enabled, the scanner will begin the calibration routine at the focal range set in **Starting Focus Position**.

Serial Cmd: <**K510**,auto range,**starting focus position**,focus step size>

Default: **0**

Options: 0 to 40

After you've used calibration and observed the progress of the first and second passes in the graph and table in the **Results** tab, you should sense a relationship between focus position and the distance to the symbol.

Improving the speed and accuracy of focus position setup:

1. Click on the **Advanced** tab in the **Calibration** menu.
2. If **Auto Range** is enabled, click on it to disable.
3. From previous results, estimate the value of **Starting Focus Position** and drop down one or two positions.

For example, if you estimate the distance to your symbol to correspond to a **Starting Focus Position** of **6**, enter **5** or **4** to be certain of not missing the peak performance distance.

4. Click the **Calibrate** button to start calibration.
5. Examining the read rates in the **Results** graph following calibration.

Focus Step Size

Usage: Increasing the **Focus Step Size** can improve focus acquisition speed for symbols.

Definition: **Focus Step Size** is the number of focus increments that will be stepped through during the first calibration pass. The range is **2** to **5**. The higher values will result in fewer readings during the first pass but will increase the risk of missing the peak performance position.

Serial Cmd: `<K510,auto range,starting focus position,focus step size>`

Default: **5**

Options: 2 to 5

Improving the speed and accuracy of focus step size setup:

1. Click on the **Advanced** tab in the **Calibration** menu.
2. If **Auto Range** is enabled, click on it to disable.
3. Enter a value in **Focus Step Size**.
4. Click the **Calibrate** button to start calibration.
5. Examine the read rates in the **Results** graph following calibration.

Calibration by Embedded Menu

To calibrate via the embedded Calibration menu, do the following:

1. Place the sample symbol at a fixed position in the center of the read range being tested.
2. Enter **Calibration** menu by sending an **<@>** command from a terminal.

```

MICROSCAN SYTEMS INC.

=====
                AUTO CALIBRATION SETUP MENU
=====
    To make changes, press appropriate key from list below:
Motor Speed.....M = INCREMENT.....N = DECREMENT
Gain Setting.....G = INCREMENT.....F = DECREMENT
Tracking.....T = INCREMENT.....R = DECREMENT
Focus Position.....P = INCREMENT.....O = DECREMENT
AGC Status.....S = ENABLE/DISABLE
Laser Power.....L = HIGH/LOW
PDF 417 Decode Test...D = ENABLE/DISABLE
=====
MENU OPTIONS:                                MENU SELECTIONS
START Auto Calibration.....A      MENU Calibration Results.....1
RECALL Initial Settings.....B     MENU Raster/Laser Framing Setup...2
SAVE Settings to Data Base...C    MENU Configuration Data Base.....3
EXIT Calibration Setup.....ESC     MENU Advanced Setup.....4
=====
Laser Power = LOW   AGC = ENABLED   PDF 417 Test = DISABLED
=====
Scan | Motor | Gain | Track | Focus | AGC |
Rate |      |     |      |      | Level|
_401 | 400 | 55 | 30 | 9 | 135 | 0 %

```

3. If the application requires a change in scan rate, adjust the motor speed now with the **M** or **N** commands.
Note: All single letter commands must be entered in upper case.
4. Start calibration by typing an uppercase **A** from your terminal while in the calibration menu.
Note: A user can abort calibration at any time by pressing the **ESC** key on the terminal. No other keystroke has any effect while in calibration.
5. Wait for calibration to cycle through its settings.
A **Calibration in Progress** message will be displayed. A new text line will appear below the menu displaying the progress of the calibration.
6. As with the serial command, repeat the routine at other positions in your scan range and width and save each position to the configuration database.
7. If not successful, a **Calibration Failed** message will be displayed. If successful, a **Calibration Passed** message will be displayed along with other settings.
Note: Focus positions **Inside**, **Outside**, and **Set** posted near the bottom of the above menu are explained more fully in [Calibration Results in Embedded Menus](#) on page 9-20.
Note: If you are using the 9-pin configuration port and doing calibration by serial command or embedded menus, you will be able to view decoded symbol data in the menu. However, after exiting the **Calibration** menu, you will not be able to see symbol data without sending the following command: **<K146,,1>**. If using **ESP**, this is not necessary.

Scanner Settings by Embedded Menus

Motor Speed, **Gain Setting**, and **Tracking** adjustments affect the read performance. **Focus** controls a stepper motor that physically slides a lens back and forth to control focal length. These settings are adjusted automatically in calibration.

The status of these parameters is displayed on the bottom line of the menu under **Motor**, **Gain**, **Track**, and **Focus**. These settings are incremented or decremented by pressing the indicated key shown on the menu. **PDF417 Decode**, **AGC Status**, **Laser Power**, and **Raster Status** use single commands to toggle between states.

AGC Status

Typing **S** toggles **AGC** between **Enable/Disable**, as displayed on the status line near the bottom of the menu. With **AGC** disabled this value is simply the Gain setting. However, with **AGC** enabled, this value represents the gain the scanner has to set to maintain the desired signal amplitude. If a symbol is close to the scanner, the AGC level should be a small value because the scanner does not need much gain to achieve the desired signal amplitude. However, as a symbol gets farther away from the scanner, this value will increase to maintain the signal amplitude.

Laser Power

Typing **L** toggles between **High** and **Low** laser settings.

PDF417 Decode Test

Typing **D** toggles the **PDF417 Decode Test** between **Enable/Disable**, as displayed on the status line near the bottom of the menu. Once set to **Enabled**, PDF417 only is enabled and a special test mode is enabled that displays the decodes per second of a full PDF417 symbol. While calibration is not performed in this mode, you can still adjust settings manually.

This special read rate will remain enabled until the Calibration menu is exited or PDF417 is disabled with another **D** command.

Note: This mode averages decode and capture time over a series of readings, thus assuring for a smooth read rate output, but at the cost of delayed reaction to symbol movement and user setting changes.

Calibration Embedded Menu Options

START Calibration

Typing **A** initiates an calibration sequence. Once entered, no other keystrokes will be accepted with the exception of the **ESC** key, which terminates the routine.

RECALL Initial Settings

Typing **B** restores the original settings that were present upon entering the **Calibration Setup Menu**. These settings include **Motor Speed**, **Gain**, **Tracking**, and **Focus**.

SAVE Settings to Database

Typing **C** saves the current **Gain**, **Tracking**, and **Focus** settings to the **Configuration Database**. The database is made up of indexes 1 through 7. Current settings will be saved to the first open index.

EXIT Calibration Setup Menu

To exit the **Calibration Setup** menu, press the **ESC** key. The following prompt will be displayed: "Do you want to save calibration settings for power on? (Y=yes N=no)."

Typing **Y** will cause the current settings in the **Calibration Setup** menu to be saved to Flash Memory for recall when the scanner is powered up at a later date. These settings include **Motor Speed**, **Gain**, **Tracking**, **Focus**, **AGC Status**, **Laser Power**, and **Raster Status**. Typing **N** will cause the scanner to be reset without saving the settings to Flash memory.

Menu Selections

Typing **1** will take you to the **Calibration Results** menu.

Typing **2** will take you to the **Raster/Laser Framing Setup** menu.

Typing **3** will take you to the **Configuration Database** menu.

Typing **4** will take you to the **Advanced Setup** menu.

Calibration Results in Embedded Menus

To access **Calibration Results** menu from within the **Calibration Setup** menu, type the numeral **1**.

CALIBRATION RESULTS MENU													
=====													
To make changes, press appropriate key from list below:													
MENU OPTIONS:							MENU SELECTIONS						
EXIT	Calibration Setup.....ESC						MENU	Calibration Setup.....CR					
=====													
FOCUS POS.	23	24	25	26	27	28	29	30	31	32	33	34	35
=====													
READ RATE													
1st PASS				100									
2nd PASS	40	73	100	100	100	100	100	100	100	100	80	66	46

GAIN													
1st PASS				120									
2nd PASS	125	140	130	140	140	100	110	100	115	135	115	120	140

TRACKING													
1st PASS				40									
2nd PASS	50	50	50	50	50	45	50	45	50	45	50	50	50

FOCAL RANGE			IN				SET				OUT		

The **Calibration Results** menu shows the results of the calibration process for **Read Rate**, **Gain**, and **Tracking** for both the first and second passes. Note that the first pass has only one reading for each parameter.

Focus Positions

In the example above, the focus position selected from the first calibration pass (position 26) represents the optimal focus position for **Read Rate**, **Gain**, and **Tracking**. The second “fine tune” pass commences 3 focus positions in from this and steps out until the read rate drops off to zero.

Focal Range

The algorithm selects the best focus position (**SET**) as the midpoint between those positions (**IN** and **OUT**) at which read rates drop off by no more than 6-2/3 percent of the maximum read rate. For example, in the above menu, the read rate for focus position 24 is 73. Since 73 is more than 6-2/3% below the maximum read rate of 100% shown elsewhere, the **IN** range falls under the next focus position, 25. A mirrored calculation is performed to locate the **OUT** focal range.

Press the enter key (**CR**) to return to the main calibration menu or **ESC** to leave the **Auto Calibration Setup** menu entirely.

Advanced Calibration Setup Embedded Menu

The **Calibration Setup** menu allows you to change the starting focus position and the number of focus steps during the first pass.

For example, if you are preparing to do calibration on symbols whose minimum distances from the scanner is 40 inches, there is no reason for calibration to cycle through all of the focal positions inside 40 inches.

- To increase **Starting Focus Position**, type **T**. To decrease it, type **R**.
- To increase the **First Pass Focus Step**, type **G**. To decrease it, type **F**.

Increasing **First Pass Focus Step** will speed up the autofocus process, but can also cause autofocus to skip over a symbol and not decode it.

Note: All single letter commands must be entered in upper case.

- Auto Range is disabled by default. To enable, press **A**.

```

=====
                          ADVANCED AUTO CALIBRATION SETUP
=====
      To make changes, press appropriate key from list below:
Auto Range.....A = ENABLE/DISABLE
Starting Focus Pos....T = INCREMENT.....R = DECREMENT
1st Pass Focus Step...G = INCREMENT.....F = DECREMENT
      MENU OPTIONS:                                MENU SELECTIONS
EXIT Calibration Setup.....ESC      MENU Calibration Setup.....CR

      STARTING FOCUS POS          MIN LABEL DISTANCE
           0                      10"
           5                      17"
          10                      20"
          15                      25"
          20                      40"
          25                      55"
          30                      75"
          35                      90"
=====
Auto Range = DISABLED
=====
      AUTO CALIBRATION 1ST PASS |
Start Focus Pos. |Step Size |
           0      |  - 2    |
  
```

10 Raster/Laser

Contents

Raster/Laser Setup by ESP	10-2
Raster/Laser Serial Commands	10-2
Raster Setup	10-3
Laser Framing	10-7
Raster/Laser by Embedded Menu	10-9

This section explains the setup and adjustments for the raster and laser.

Note: The characters **NUL**, **<**, **>**, and **,** can only be entered through embedded menus, not through **ESP** or serial commands.

Note: Raster setup commands in the **ESP** are accessed from the **Read Cycle/Triggering** menu or from the **Raster/Laser** or **Calibration** menus on the **ESP** toolbar.

Raster/Laser Setup by ESP



Click this button to bring up the **Raster/Laser** menu.

To open nested options, **single-click** the **+**.

Parameters	ESP Values
[-] Raster / Laser Settings	
[-] Raster Setup	
Status	Disabled
Top Offset	127
Bottom Offset	127
Sweep Rate	10
Read Cycle On/Off	Disabled
[-] Laser Setup	
Laser On/Off	Disabled*
Laser Framing Status	Disabled*
Laser On Position	Enabled
Laser Off Position	95
Laser Power	Low

To change a setting, **double-click** the setting and use your cursor to scroll through the options.

Raster/Laser Serial Commands

Command Title	Format
Raster	< K506 , <i>raster status,top offset,bottom offset,raster sweep rate,read cycle on/off</i> >
Laser On/Off	< K700 , <i>laser on/off status,laser framing status,laser on position,laser off position,laser power</i> >

Raster Setup

You can set up and make changes to the scanner's raster parameters in **ESP's Read Cycle, Calibration, or Raster/Laser** views (preferred).

To access the Raster Setup menu, click the **Raster/Laser** button and the **Raster Setup** tab.



Usage: Raster scanning is useful when symbols vary in placement and a single scan line cannot be counted on to cross the symbol, and for reading stacked symbologies such as PDF417.

Definition: The user can enable raster scanning and adjust the raster sweep limits and the sweep rate.

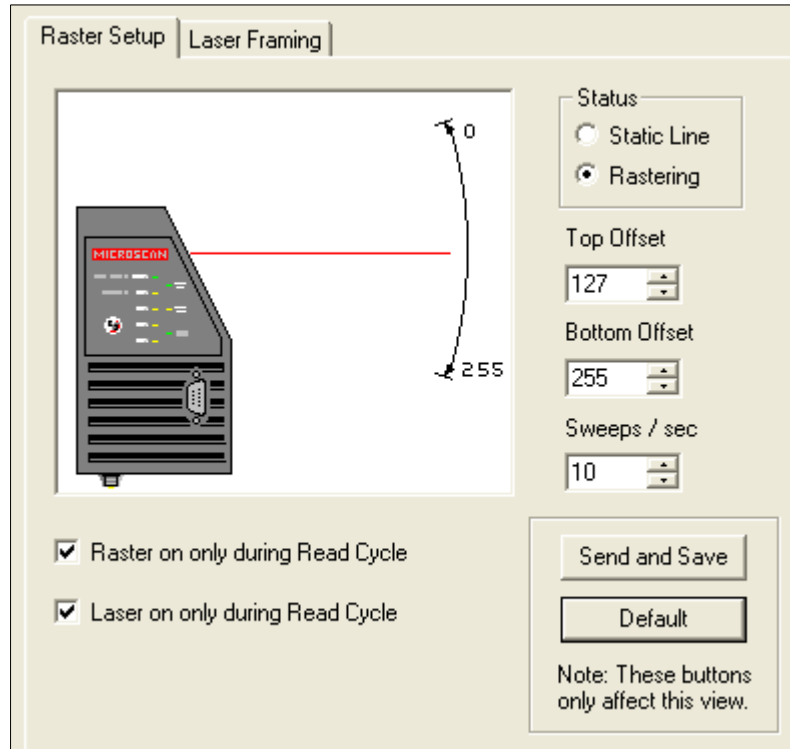

Note: Changes made in the **Raster Setup** menu are dynamic; that is, they take effect without saving.

Raster Status

Definition: When disabled, the raster mirror will park at the top of the raster sweep.

Serial Cmd: <**K506,raster status**,top offset,bottom offset,raster sweep rate,read cycle on/off>

Default: **Disabled**

Options: 0 = Disabled 1 = Enabled

Note: Raster sweeps are only counted during a read cycle (continuous, triggered, and read rate). Raster sweeps are NOT counted when the raster motor is parked, disabled, set to straight line operation (top and bottom are equal), or when performing a self-calibration.

Top Offset

Definition: Decreasing the **Top Offset** value causes the top of the raster pattern to move up.

Serial Cmd: <**K506,raster status**,**top offset**,bottom offset,raster sweep rate,read cycle on/off>

Default: **127**

Options: 0 to 255

Bottom Offset

Definition: Increasing the **Bottom Offset** value causes the bottom of the raster pattern to move down.

Serial Cmd: <**K506**,*raster status,top offset,bottom offset,raster sweep rate,read cycle on/off*>

Default: **127**

Options: 0 to 255

Note: For single scan line operation, set **Top Offset** equal to **Bottom Offset** or click on the **Static Line** option.

Note: Assigning a larger value to **Top Offset** than **Bottom Offset** will park the raster mirror in its “home” (default) position.

Raster Sweep Rate

Usage: If your application allows it, a slower sweep rate can produce more scans per second and higher read rates. To determine the minimum read rate for your application, see [Raster Picket Fence Calculation](#) on page A-28.

Definition: The raster sweep rate is the number of sweeps per second the raster mirror completes. A sweep is one pass of the raster, up or down. The maximum sweep rate is limited by the size of the arc the raster must move through.

Serial Cmd: <**K506**,*raster status,top offset,bottom offset,raster sweep rate,read cycle on/off*>

Default: **10**

Options: 0 to 30.

The table below shows the maximum speeds at selected raster sweep arcs. To maximize the number of scans per symbol, use the lowest effective sweep rate required for the application.

Raster Sweep Arc	Maximum Sweeps per Second
0 to 10°	30
11 to 20°	20
21 to 36°	10

Read Cycle On/Off

Usage: This feature should only be used when the raster sweep rate is at least twice the required trigger rate (decoded outputs per second).

Definition: When **Read Cycle On/Off** is enabled and **Laser On/Off** is also enabled, the raster mirror stops at top offset at the end of triggered read cycle.

Serial Cmd: <**K506**,*raster status,top offset,bottom offset,raster sweep rate,read cycle on/off*>

Default: **Disabled**

Options: 0 = Disabled 1 = Enabled

Laser Framing

To access the Laser Framing menu, click the **Raster/Laser** button and the **Laser Framing** tab.

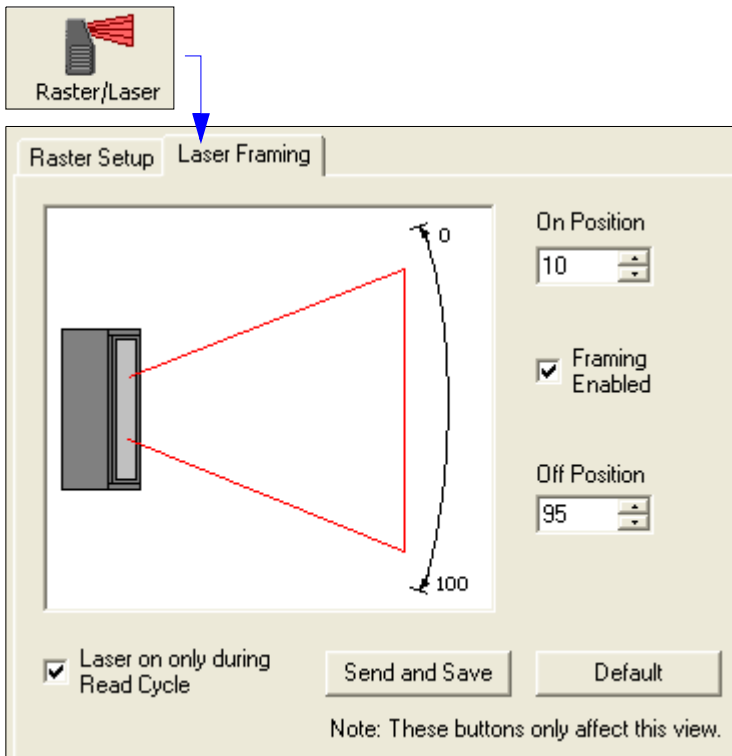

Laser On/Off Status

Usage: **Laser On/Off** extends the life of the laser. It is useful where there are significant time gaps between symbols. It also provides visual confirmation of a read cycle timeout and minimizes laser exposure to people.

Definition: When enabled, the laser is ON only during the read cycle. When disabled, the laser operates continuously.

Serial Cmd: `<K700,laser on/off status,laser framing status,laser on position,laser off position,laser power>`

Default: **Disabled**

Options: 0 = Disabled 1 = Enabled

Note: A serial or external trigger must be enabled for **Laser On/Off** to take effect.

Note: **Laser On/Off** is not recommended when **New Trigger** is enabled, since the laser will effectively remain on continuously.

Laser Framing Status

Usage: Useful in avoiding highly reflective objects, for filtering out unwanted signals, or avoiding the wrong symbols.

Definition: Sets the length of time the laser is ON during each scan so that only a selected portion of the scan width is effectively scanned.

Serial Cmd: <K700,laser on/off status,laser framing status,laser on position,laser off position,laser power>

Default: Disabled

Options: 0 = Disabled 1 = Enabled

To adjust laser framing, click the **Raster** button, click the **Laser Setup** tab, and click the **Laser On** and **Laser Off** arrows up or down.

When **Laser Framing** is not enabled, the scan beam sweeps across the full scan width. When enabled, the laser remains OFF during the **Laser Off Time** beginning at the start of the scan beam sweep and turns ON for the duration of the **Laser On Time**.

Laser On Position

Definition: Measured in increments equal to 1/100th of total scan width.

Serial Cmd: <K700,laser on/off status,laser framing status,laser on position,laser off position,laser power>

Default: 10

Options: 10 to 90

Laser Off Position

Definition: Measured in increments equal to 1/100th of total scan width.

Serial Cmd: <K700,laser on/off status,laser framing status,laser on position,laser off position,laser power>

Default: 95

Options: 15 to 95

Laser Power

Usage: Used to optimize read performance at different distances. Typically higher power is used at greater distances.

Definition: Allows the user or calibration routine to select laser power setting.

Serial Cmd: <K700,laser on/off status,laser framing status,laser on position,laser off position,laser power>

Default: High Power (low or medium density scanner)

Options: 0 = Low (3.0 mW) 1 = Medium (3.25 mW) 2 = High (3.5 mW)

Raster/Laser by Embedded Menu

To access the **Raster/Laser Framing** menu, send **<@>** to open the **Calibration Setup** menu and type the number 2.

```

=====
                    RASTER/LASER FRAMING SETUP MENU
=====
      To make changes, press appropriate key from list below:
                    RASTER SETTINGS
Top Offset..... T   INCR.   DECR.   RANGE   STATUS
Bottom Offset... B   .....   .....   0-255   Raster Status.....E
Sweep Rate..... S   .....   .....   0-30    Raster On/Off.....F

                    LASER SETTINGS
Laser Off Time.. P   INCR.   DECR.   RANGE   STATUS
Laser On Time... L   .....   .....   0-255   Laser Framing Status.....M
                                        Laser On/Off.....N

      MENU OPTIONS:                                MENU SELECTIONS
EXIT Calibration Setup.....ESC   MENU Calibration Setup.....CR
=====
Raster Status = ENABLED                                Raster On/Off = DISABLED
Laser Framing = DISABLED                                Laser On/Off = DISABLED
=====

      RASTER      ||LASER FRAMING|
Top |Bottom|Sweep ||Off  |On  |
Offset|Offset|Rate ||Time |Time |
_127 | 127 | 10  || 0  | 255 | 0 %

```

Raster Settings

Type the letter **T** to increment the **Top Offset** and an **R** to decrement. Notice that the **Top Offset** reading at the bottom of the menu changes accordingly.

Type the letter **B** to increment the **Bottom Offset** and **V** to decrement.

Sweep Rate, **Raster Status**, and **Raster On/Off** are explained more fully in [Raster Setup](#) on page 10-3.

Laser Settings

Laser settings are also dynamically updated at the bottom of the menu.

Full instructions and menus for laser operations can be found in [Laser Framing](#) on page 10-7.

Press the enter key (**CR**) to return to the main calibration menu or **ESC** to leave the **Auto Calibration Setup** menu entirely.

11 Terminal

Contents

Terminal Window	11-2
Find.....	11-3
Send	11-4
Macros.....	11-5
Terminal Window Menus	11-6

This section describes the **Terminal** window and macro functions.

Note: The characters **NUL**, **<**, **>**, and **,** can only be entered through embedded menus, not through **ESP** or serial commands.

Terminal Window



Click this button to bring up the **Terminal** view.

The following window will appear:

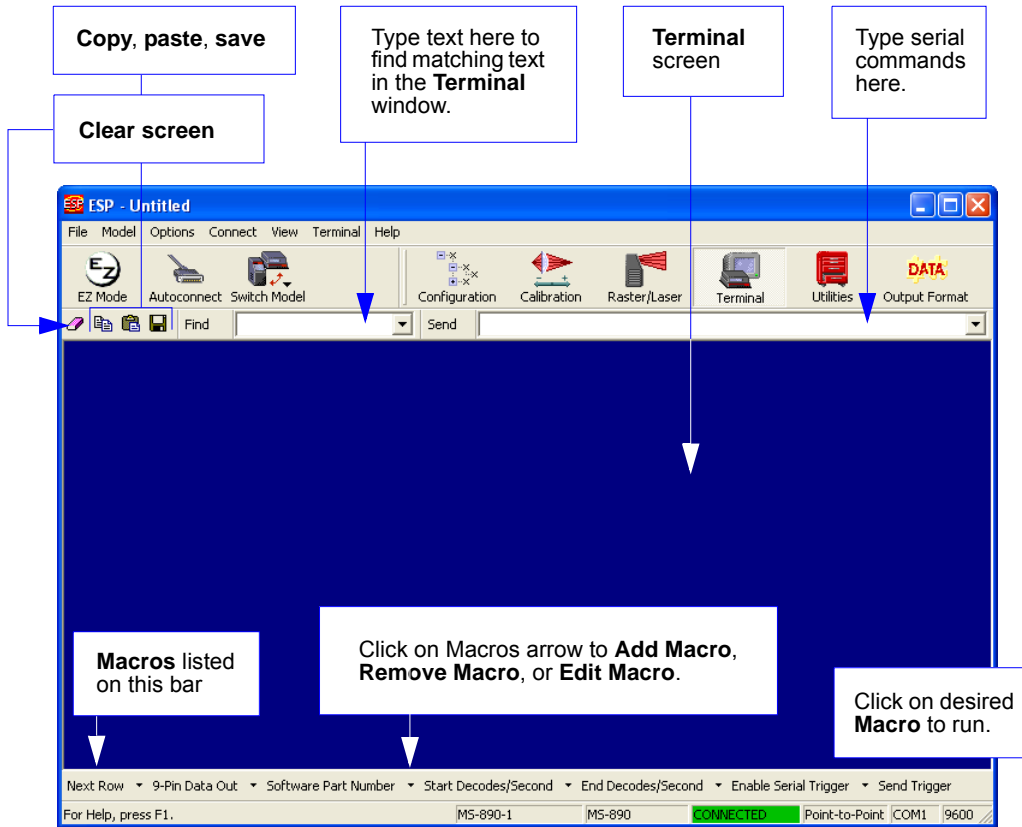

The **Terminal** screen allows you to send serial commands to the scanner by using Macros, by copying and pasting, or by typing commands in the **Send** text field.

The **Terminal** screen also displays symbol data or information from the scanner.

You can also right-click on the **Terminal** screen to bring up a menu of further options.

Find

The **Find** function allows you to enter text strings to be searched for in the **Terminal** window. For example, a series of symbols have been scanned into the **Terminal** view and you want to determine if a particular symbol whose data begins with “ABC” has been read.

1. Type “ABC” into the **Find** box.

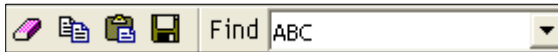

2. Press **Enter**.

The first instance of “ABC” will be highlighted in the **Terminal** window.

3. Click the **Find** button to the right of the text field to locate additional instances of “ABC”.

Send

The **Send** function in **ESP's Terminal** allows you to enter serial commands and then send them to the scanner.

1. Type the command into the **Send** box.

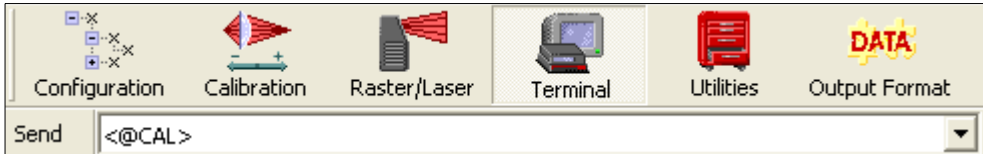

2. Press **Enter**.
3. Click the **Send** button to the left of the text field to send.

Macros

Macros can be stored in a macro selection bar, edited in a separate window, and executed by clicking on the macro name.

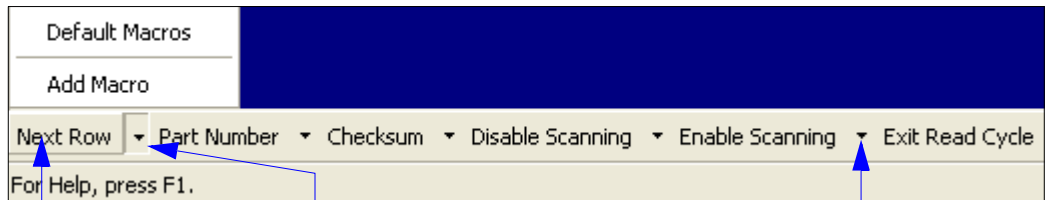

Click on **Next Row** to see the next row of macros

Click on the first arrow here to see **Add Macro** or **Default Macros**. When you default macros, the entire macros set is restored to their original macro commands.

Click on subsequent arrows to edit macros.

When you click on the macro name, the macro is executed in the **Terminal** window. If this is a command, it is sent to the scanner at the same time that it is displayed.

Editing a Macro

When you click the arrow next to any macro and select **Edit**, the following appears:

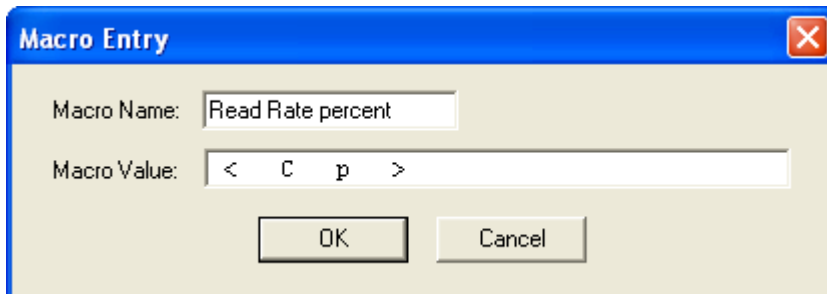

You can edit an existing macro or type in the **Macro Name** text field and define it in the **Macro Value** text field. Click **OK**.

Terminal Window Menus

Right-click on the **Terminal** window to display the following menu:

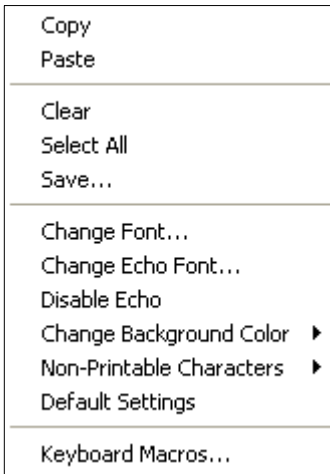

- **Copy** selected text to clipboard.
- **Paste** from **Terminal** or computer text.
- **Clear** all text in **Terminal** window.
- **Select All** text in the **Terminal** window.
- **Save...** brings up a save as dialog box.
- **Change Font...** of data text, brings up a text dialog.
- **Change Echo Font...** to change typed in text or commands.
- **Change Background Color** of **Terminal** window.
- **Default Settings** changes all the above back to default settings.

Terminal Dropdown Menu

The dropdown **Terminal** menu has **Capture Text** and **Save Current Text** functions, as well as the functions defined above.

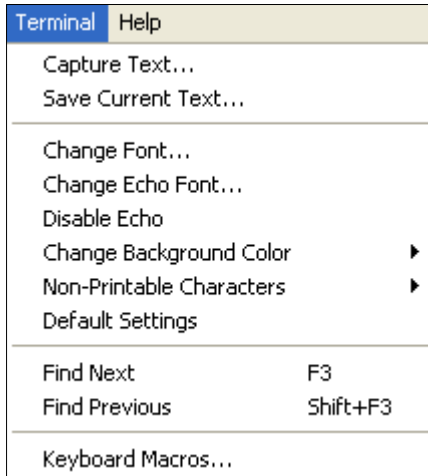

- **Capture** lets you append data in real time to a text file of your choice. While in operation, the text file cannot be opened. You can select **Pause** to interrupt the capture flow or **Stop** to end the flow and open the file.
- **Save Current Text...** saves all text in the **Terminal** window to a text file of your choice.

Contents

Serial Utility Commands	12-2
Read Rate	12-4
Counters	12-6
Device Control	12-8
Differences from Default	12-10
Master Database	12-11
Digital Bar Code	12-16
Firmware	12-17
Autodiscriminate	12-19
Scanner Status Requests	12-20

Utility commands are generally commands that are performed during scanner operations to check read rates, determine read rates or perform miscellaneous operations on scanner hardware. Serial utility commands are not prefaced with a **K** and a numeric code, nor do they require an initialization command (**<A>** and **<Z>**). They can be entered from within any terminal program or from within **ESP** in the **Terminal** window.

Note: The characters **NUL**, **<**, **>**, and **,** can only be entered through embedded menus, not through **ESP** or serial commands.

Serial Utility Commands

Command Type	Command	Name
Read Rate	<C>	Enter Read Rate Test
	<Cs>	Enter Multisymbol Read Rate Test
	<Cp>	Enter Percent Test
	<Cm>	Enter Multisymbol Percent Test
	<Ce>	Extended Read Rate
	<CPDF>	Enter Percent PDF Read Rate Test
	<J>	Exit Read Rate and Percent Test
Counters	<N>	No Read Counter
	<O>	No Read Counter Reset
	<T>	Trigger Counter
	<U>	Trigger Counter Reset
	<V>	Good Read/Match Counter
	<W>	Good Read/Match Counter Reset
	<X>	Mismatch Counter
	<Y>	Mismatch Counter Reset
Device Control	<H>	Enable Laser Scanning (Laser On)
	<I>	Disable Laser Scanning (Laser Off)
	<K500>	Motor On
	<K501>	Motor Off
	<L1>	Programmable Output 1 Pulse
	<L2>	Programmable Output 2 Pulse
Matchcode	<E>	Enable Matchcode Type
	<F>	Disable Matchcode Type
	<G>	Store Next Symbol to Database Index 1
Master Database	<Gn>	Store Next Symbol to Database Index <i>n</i>
	<Mn>	Download Master Symbol Data to Database Index <i>n</i>
	<Mn?>	Display Master Symbol Data from Database Index <i>n</i>
	<Mn,>	Delete Master Symbol from Database Index <i>n</i>
Firmware	<!>	Display Checksums for Boot Code and Application Code
	<!b>	Display Checksum for Boot Code
	<!a>	Display Checksum for Application Code
	<!c>	Display Checksum for Raster Code
	<#>	Display Boot Code and Application Code Part Number
	<#b>	Display Boot Code Part Number
	<#a>	Display Application Code Part Number
Symbologies	<P>	Autodiscriminate All Symbologies
	<Q>	Enable Code 39 Only
	<R>	Enable Codabar Only
	<S>	Enable Interleaved 2/5 Only
Trigger	<char>	Serial Trigger Character

Default/Reset/Save	<A>	Reset (does not save for Power-On)
	<Ard>	Reset and Restore Microscan Default Parameters
	<An>	Reset and Read Flash Parameters
	<Z>	Save Current Settings for Power-On
	<Zrd>	Restore Microscan Default Parameters and Save for Power-On
Status Requests	<?>	Status Byte
	<?1>	Extended Status
	<K?>	All Commands Status
	<K??>	Single Command Status
	<K?#>	All Command Descriptions
	<Knnn?>	Single Command Description
	<Knnn??>	All Command Ranges
	<Knnn?#>	Single Command Range
	<Knnn?*>	Single Command Wildcard
	<Knnnd>	Single Command Default

Read Rate

You can access **Read Rate** from the **Utilities** menu.

To start or end a read rate test, right-click **Read Rate** and select **Start** or **Stop**.

To change from percent read rate to decodes per second, first end the read rate by selecting **Stop**, then right-click select **Decodes/Sec**.

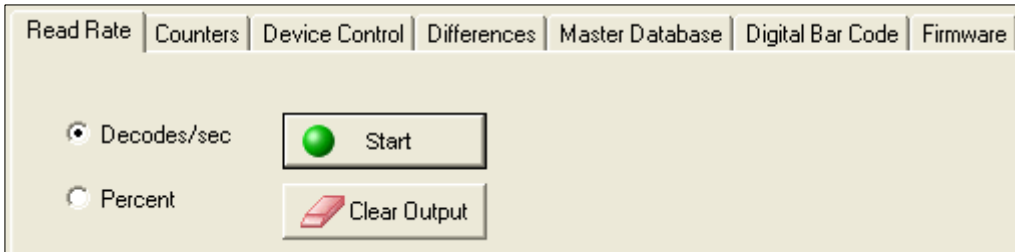

Read Rate by Serial Command

Enter Single Symbol Percent Test

Sending **<Cp>** instructs the scanner to transmit the percentage of decodes and any scanned symbol data.

Enter Multisymbol Percent Test

Sending **<Cm>** instructs the scanner to transmit the percentage of scans decoded and symbol data (if any) for multiple symbols.

Enter Single Symbol Read Rate Test

Sending **<C>** instructs the scanner to transmit the decodes per second and symbol data (if any). The decode rate can vary dramatically due to the angle and location of the symbol in relation to the scan line. This test is very useful in aligning and positioning the scanning device during installation.

Enter Multisymbol Read Rate Test

Sending **<Cs>** instructs the scanner to transmit the decode rate and symbol data (if any) for multiple symbols.

Enter Percent PDF Read Rate Test

Sending **<CPDF>** instructs the scanner to transmit the number of decodes per second on the full PDF symbol. This test includes both capture and decode and translation time. Note that the output format of the data is done as a running average of 750ms windows. This means that you can remove the symbol from the view of the scanner and it will continue to transmit some history of the symbol for a few outputs.

Enable PDF Information

Sending the **<a1>** check box will cause PDF417 symbology data to be prefaced with information consisting of error correction level, number of rows, number of columns, number of informative code words and the number of data characters.

This feature can be disabled by using the exit read rate command **<J>**.

Enable Extended Read Rate Test for Single and Multisymbol

Sending **<Ce>** after **<C>** or **<Cs>** will generate a an extended mode that applies to both single and multiple symbols.

Extended Mode instructs the scanner to output the decode rate, the symbol data, and the transition data.

The example below shows output with Postamble enabled and defined as Carriage Return/Line Feed.

Decode rate	Symbol data	Number of bar/space transitions
800 Decodes/Sec	MICROSCAN4	TRANS = 66
808 Decodes/Sec	MICROSCAN4	TRANS = 67
808 Decodes/Sec	MICROSCAN4	TRANS = 66
832 Decodes/Sec	MICROSCAN4	TRANS = 65
808 Decodes/Sec	MICROSCAN4	TRANS = 67
804 Decodes/Sec	MICROSCAN4	TRANS = 65
832 Decodes/Sec	MICROSCAN4	TRANS = 64

Note: The **<Ce>** command has no immediate effect if not preceded by **<C>** or **<Cs>**.

End Read Rate Test

Sending **<J>** ends both the **Percent** test and the **Decodes/Second** test for both single and multisymbol.

Counters

Counter commands can be a numeric value from 00000 to 65535. After reaching the maximum numeric limit of 65,535, the counter will automatically rollover and start counting again at 00000 and report any errors. To obtain the cumulative total of counts after the rollover has occurred, add 65,536 per each rollover (the scanner does not keep track of the number of rollovers) to the current count.

Note: All counter values will be lost if power is recycled to the scanner or the scanner receives a reset or save command.

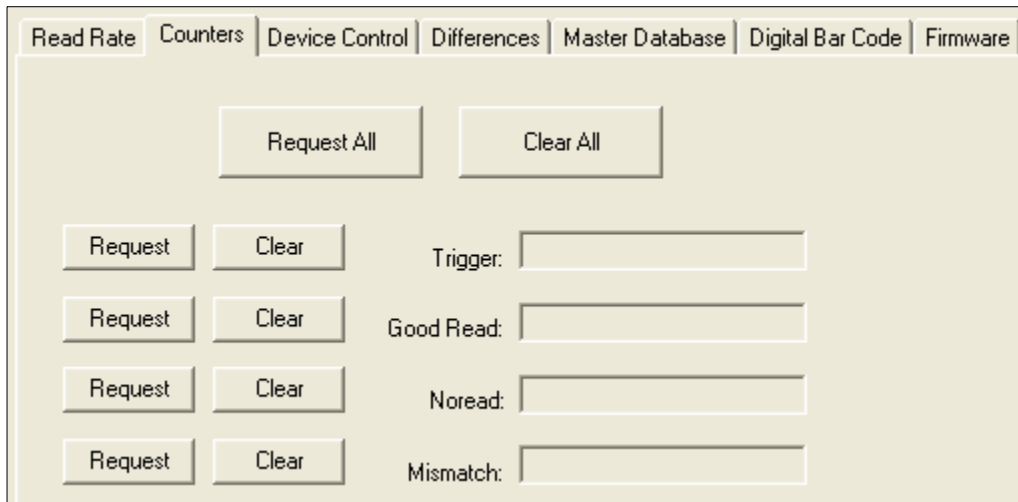

Counters by Serial Command

No Read Counter

Sending **<N>** displays the total number of No Reads that have occurred since the last reset.

No Read Counter Reset

Sending **<O>** sets No Read Counter to 00000.

Trigger Counter

Sending **<T>** displays the total number of triggers since the last reset.

Trigger Counter Reset

Sending **<U>** sets the trigger counter to 00000.

Good Read/Match Counter

Sending **<V>** displays the total number of good reads matching the master symbol if **Matchcode** is enabled. This counter is always enabled, but will only work as a match count when **Matchcode** is enabled. If **Matchcode** is not enabled, this counter records the number of good reads. This count can be requested at any time.

Good Read/Match Counter Reset

Sending **<W>** sets the match counter to 00000.

Mismatch Counter

With **Matchcode** enabled, sending **<X>** displays the number of decoded symbols since the last reset that do not match the master symbol.

Mismatch Counter Reset

Sending **<Y>** sets the mismatch counter to zero.

Device Control

Device Control is accessible from the **Utilities** menu.

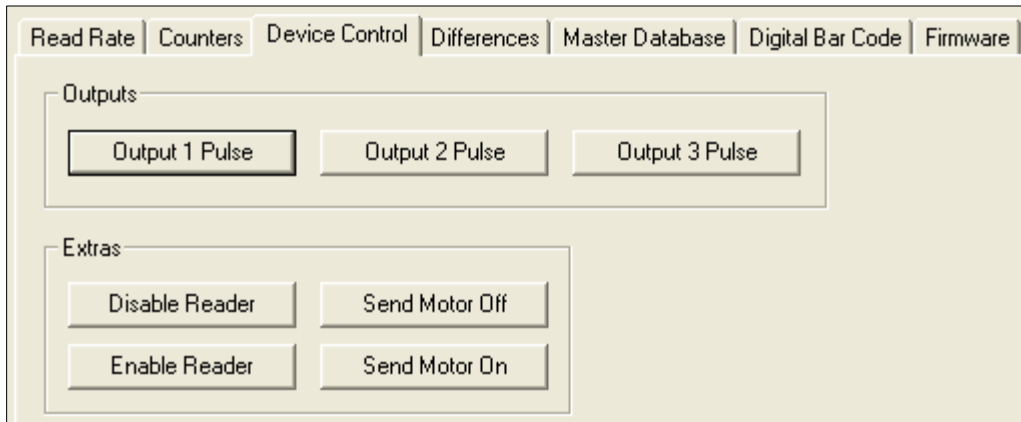

Device Control by Serial Command

Enable Laser Scanning

Sending **<H>** will turn the laser on continuously.

Note: **Enable Laser Scanning** does not relate to **Laser On/Off** command.

Disable Laser Scanning

Sending **<I>** will turn the laser off and end the current read cycle. This feature is useful during extended periods of time when no symbols are being scanned or the scanner is being configured. Disabling laser scanning will not affect any downloaded commands to the scanner.

Note: **Disable Laser Scanning** does not relate to **Laser On/Off**, which, when enabled, also turns off the laser but only between read cycles.

Motor On

Sending **<KE>** turns the spinning mirror and raster mirror motors on (if not already running).

Note: The spinning mirror reaches full speed after a short time delay.

Motor Off

Sending **<KF>** turns the spinning mirror motor off. This command is useful for long idle periods.

Note: Laser turns off whenever motor is off.

Output 1

Sending **<L1>** activates the link between Output 1(+) and Output 1(-) of the host connector (regardless of Master Symbol or Output 1 status).

Output 2

Sending **<L2>** activates the link between Output 2(+) and Output 2(-) of the host connector (regardless of Master Symbol or Output 2 status).

Output 3

Sending **<L3>** activates the link between Output 3(+) and Output 3(-) of the host connector (regardless of Master Symbol or Output 3 status).

Differences from Default

Clicking the **Differences from Default** button will cause **ESP** to check all stored configuration settings and compare them to default settings. All settings that are different than default will appear in the left column (shown below), and descriptions of those settings will appear in the right column.

The screenshot shows a software window with a toolbar at the top containing 'Read Rate', 'Counters', and 'Device Control'. Below the toolbar are two buttons: 'Differences from Default' and 'Generate Barcode'. A table in the center lists configuration differences:

<K200,4>	Mode (Serial Data)
<K201h,52>	Character (Delimited)
<K220,,1000>	Read Cycle Timeout
<K470,1>	Code 39

At the bottom, there are three buttons: 'Save As...', 'Send and Save', and 'Send to Reader'. Several callout boxes provide instructions: 'Click this button for a list of ESP configuration settings that are different than default settings.' points to 'Differences from Default'; 'Click Generate Barcode to bring up the Bar Code Dialog. Then create configuration symbols containing the configuration commands of your choice.' points to 'Generate Barcode'; 'Send configuration settings to the scanner without saving by clicking Send to Reader.' points to 'Send to Reader'; 'Click Save As to save the report as plain text or a tab-delimited text file.' points to 'Save As...'; 'Send configuration settings to the scanner and save in ESP by clicking Send and Save.' points to 'Send and Save'.

- To create a symbol containing any of the command settings in the table, click **Generate Barcode**. This will bring up the **Bar Code Dialog**.
- To save the **Differences from Default** report, either as plain text or as a tab-delimited text file, click **Save As**.
- Click **Send and Save** to send the settings to the scanner and save them, or **Send to Reader** to send the settings without saving them.

Important: The use the **Differences from Default** feature, you must connect to the scanner and **Receive Reader Settings** via the **Send/Recv** button on the toolbar.

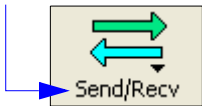

Master Database

Important: **Master Database** is used only for comparing entire symbols, when **Sequential** and **Wild Card** are NOT enabled, and **Start Position** is equal to **0**.

Master Database Overview

Usage: Used where more than one master symbol is required, as in a **Multisymbol** setup, for matching and other matchcode operations.

Definition: Allows you to define up to 10 master symbols as the master symbol database, which can be entered by keyboard, scanned in, displayed, or deleted by serial or **ESP** commands.

1. Click the **Master Database** tab.
2. Set the **Master Symbol Database Size**.
3. Select database index you want to enter the master symbol.
4. Do one of the following to enter master symbol data:
 - **Double-click** the index row to type data directly into index. (See [Enter Master Symbol Data](#) on page 12-13.)
 - Click **Read Symbol into Selected Index** to enter the next decoded symbol.

The screenshot shows the 'Master Symbol Database' configuration window. At the top, there is a 'Master Symbol Database Size' field with a spinner set to '3'. To its right is a checked 'Matchcode Type' checkbox. Below these are four buttons: 'Read Symbol into Selected Index', 'Receive Reader's Database', and 'Send Database to Reader'. A table below contains three rows with 'Index' and 'Master Symbol Data' columns. A 'Caution' note at the bottom explains that changing the database size will re-allocate characters and could delete existing symbols.

Callouts in the image provide the following information:

- Set Master Symbol Database Size here.** (Points to the spinner control)
- Loads the next symbol decoded into the selected index.** (Points to the 'Read Symbol into Selected Index' button)
- Double-click a row to enter data into popup dialog box.** (Points to the first row of the table)
- Loads the scanner's saved master symbols into ESP.** (Points to the 'Receive Reader's Database' button)
- Saves the displayed database to the scanner.** (Points to the 'Send Database to Reader' button)

Caution: Since the total number of characters available for the master symbol database is limited, changes to the Master Symbol Database Size will re-allocate the number of characters available for each master symbol and could cause existing master symbols to be deleted. See manual for details.

Master Symbol Database Size

Definition: **Master Symbol Database Size** allows you to select 1 to 10 master symbols for the master symbol database.

ESP: First set the number of master symbols you want to include by double-clicking Database Size and entering the number.

Serial Cmd: **<K224, master symbol database size>**

Default: **1**

Options: 1 to 10

Master Symbol Database Size Matchcode Type

Set Master Symbol Database Size here.

Enter Master Symbol Data

Definition: Allows you to enter master symbol data for a specific master symbol index number (1 to 10), provided the index number is not larger than the number of symbols enabled by the **Master Symbol Database Size**. For example, if **Master Symbol Database Size** is set to 2, you will not be able to enter data for symbols 3 through 10.

ESP: **Double-click** on the index row.

Serial Cmd: **<K231, master symbol number, master symbol data>**

Default: **1**, (blank)

Options: 1 to 10, any combination of ASCII text up to the maximum indicated in the **Maximum Characters for Master Symbol Database** table below.

For example, to enter data for master symbol 9, after making certain that master symbol database size is enabled for 9 or more symbols (see **Master Symbol Database Size** on page 12-12), send **<K231,9,data>**.

Caution: Since the total number of characters available for the master symbol database is **2710** changes to the **Master Symbol Database Size** will re-allocate the number of characters available for each master symbol and could cause existing master symbols to be deleted (except master symbol #1 unless it also exceeds the size limitation).

The table below specifies the maximum number of characters available to each symbol according to the number of master symbols defined, from 1 through 10.

See **Master Symbol Database Size** on page 12-12.

Maximum Characters for Master Symbol Database

Number of Master Symbols	Maximum Characters	Number of Master Symbols	Maximum Characters
#1	20452710	#6	340
#2	1022	#7	291
#3	681	#8	254
#4	510	#9	226
#5	408	#10	203

Request Master Symbol Data

Definition: Returns master symbol data for any enabled master symbols from 1 to 10. For example, to request master symbol # 5, enter **<K231?,5>**. The scanner transmits the following format: **<K231,5,data>**. If no master symbol data available, the output will be: **<M5/?>**.

Serial Cmd: Send **<K231?,master symbol number,master symbol data>** to request the current master symbol for a specific master symbol.
Returns all master symbols if no number is added before the question mark.

Options: 1 to 10

Delete Master Symbol Data

Definition: This command will delete the current master symbol data.

ESP: You can delete master symbol data for any master symbol by erasing the data in the **Master Database** popup dialog (under **Output Format**) and clicking OK.

Serial Cmd: **<K231,master symbol number,>**To delete a master symbol, enter the database number and a comma, but leave the data field empty. For example, to delete master symbol #5, send the following **<K231,5,>**. The command is entered with a blank master symbol data field which tells the scanner to delete the selected master symbol from the database.

Read Next Symbol as Master Symbol

Definition: After you've set the size in the database, you can order the scanner to read the next symbol as the master symbol.

ESP: In the **Master Database** tab, under the **Output Format** menu:

1. Select the master symbol index number in which you want to store the symbol data.
2. Click **Read Symbol into Selected Index**.

Serial Cmd: **<Gmaster symbol number>**
To store the next symbol scanned as master symbol #1 send: **<G>** or **<G1>**.
For all symbols numbers except 1, the number must be included.

Options: 1 to 10

Note: Utility commands are not accessible by embedded menus.

Digital Bar Code

When you click the **Digital Bar Code** tab and the **Start** button, a digitized representation of the candidate symbol will appear.

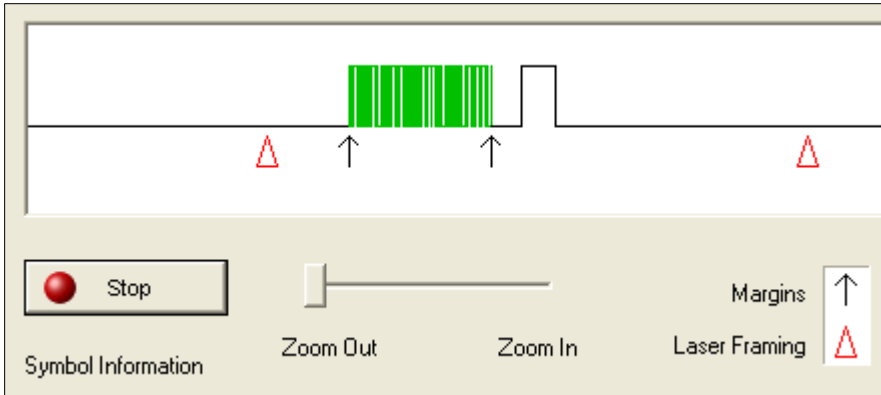

This routine is useful for conveying a sense of the symbol's readability and graphically indicating bad or unreadable portions of symbols or extraneous "noise". A green waveform indicates a decoded symbol; a red waveform indicates an undecoded symbol or other object. The red triangles represent the width of the scan beam relative to the symbol. The upward pointing arrows indicated the symbol's margin.

Zoom In, Zoom Out

You can zoom in by sliding the **Zoom** lever to the right. You may have to scroll right or left to locate your symbol, but the results will be striking.

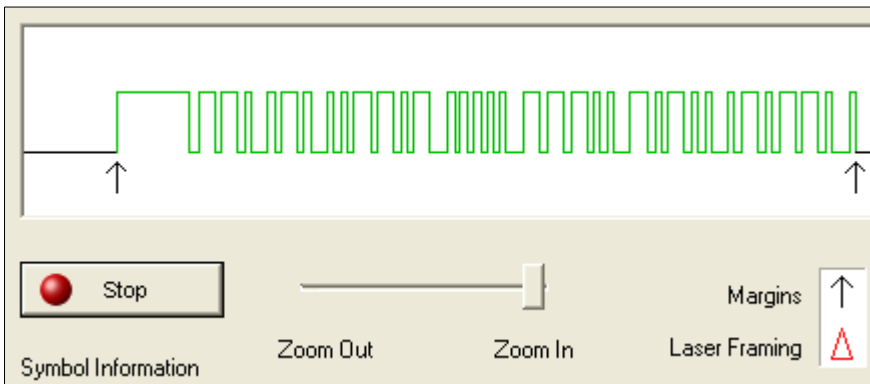

Firmware

Firmware Update

The screenshot shows a software utility window with two main sections: "Firmware Update" and "Firmware Verification".

- Firmware Update:** Contains a dropdown menu labeled "App Code" and a "Start..." button.
- Firmware Verification:** Contains two rows of input fields:
 - Row 1: "App Code" dropdown, "Request Part No." label, and a text box containing "35-634001-E7.2".
 - Row 2: "App Code" dropdown, "Request Checksum" label, and a text box containing "9070".

Firmware Update is used to download application code to the scanner.

Application code versions are specific to your scanner. Consult with your sales representative before downloading application code. If needed, an application code will be sent to you in the form of a *.mot file.

To download application code:

1. First make sure the host is connected to your scanner.
2. Apply power to the scanner.
3. Before updating, verify the current firmware (see **Firmware Verification (Part Number)** below.)
4. Click in the Firmware Update text box and select the file type you want to download. This will open a file locator box.
5. Navigate to the appropriate file (a *.mot file) and open the file.

As application code begins to download to the scanner, the scanner will go silent, the scanner's RDY and GD/RD LEDs will flash intermittently, and a progress indicator at the bottom of the **ESP** window will let you know when the download is complete.

Caution: Do not interrupt power or disconnect the host cable while download is in progress.

Firmware Verification (Part Number)

You can send a request for the scanner's current firmware part numbers using this dialog:

1. From the **Utilities** menu you can access **Firmware Verification** from the **Firmware** tab.
2. Select the firmware code you want to check and click **Request Part No.** to see the associated part number.

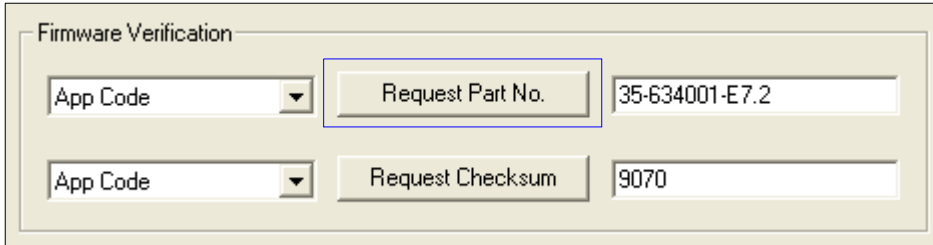

The screenshot shows a dialog box titled "Firmware Verification". It contains two rows of controls. The first row has a dropdown menu labeled "App Code" with a downward arrow, a button labeled "Request Part No.", and a text field containing "35-634001-E7.2". The second row has another "App Code" dropdown, a button labeled "Request Checksum", and a text field containing "9070". The "Request Part No." button in the first row is highlighted with a blue border.

Part Number by Serial Command

Upon sending **<#>** the scanner returns software part numbers for application code **<#a/ _____>** and boot code **<#b/ _____>**.

Individual part numbers for **Application Code** and **Boot Code** are returned when their respective commands **<#a>** and **<#b>** are sent.

Firmware Verification (Checksum)

A checksum verifies a scanner's flash memory.

1. From the **Utilities** menu you can access **Firmware Verification** from the **Firmware** tab.
2. Select the firmware code you want to check and click **Request Checksum** to see the associated part number.

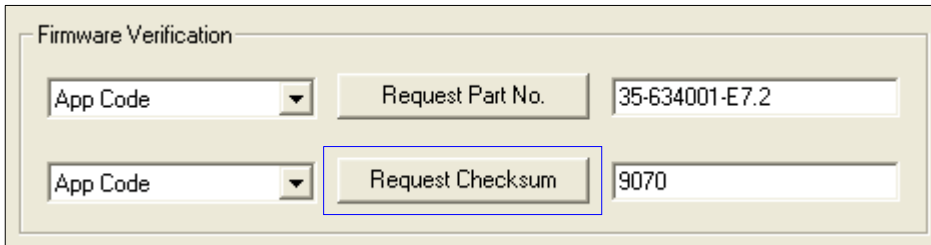

The screenshot shows a dialog box titled "Firmware Verification". It contains two rows of controls. The first row has a dropdown menu labeled "App Code" with a downward arrow, a button labeled "Request Part No.", and a text field containing "35-634001-E7.2". The second row has another "App Code" dropdown, a button labeled "Request Checksum", and a text field containing "9070". The "Request Checksum" button in the second row is highlighted with a blue border.

Checksum by Serial Command

Upon sending **<!>** the scanner returns two 4-digit hex numbers that are the check sums for boot code and the application code.

Individual checksums for **Boot Code** and **Application Code** are returned when their respective commands **<!b>** and **<!a>** and **<!r>** are sent.

Autodiscriminate

You can enable most or specific symbol types by the following operational commands.

Default: **Code 39 (only)**

Options: **<P>** Enables most symbol types.
 <Q> Enable Code 39 only
 <R> Enable Codabar only
 <S> Enable I 2/5 only

Scanner Status Requests

<?> Status Byte

The scanner responds to a status request <?> with a two character hex value, for example <?/22>. To determine the status:

1. Look up the binary conversion in the hex-to-binary table.
For example, the first 2 in binary would be **0 0 1 0** as read from binary digits **3** through **0**; the second 2 the binary digits **7** through **4** which is also **0 0 1 0**.
2. Next, enter your binary values in the “Scanner Status” table, in the “Binary” column next to the appropriate bit.

Bit	Binary	Scanner Status
0	0	Command error detected
1	1	Command received
2	0	Communication error detected
3	0	Flash sector unprotect failure
4	0	Host/Aux port buffer overflow
5	1	Scanner is in a read cycle
6	0	Software Watchdog reset
7	0	Hardware Watchdog reset

Hex Value	Binary Bit Digits			
	7	6	5	4
	3	2	1	0
0	0	0	0	0
1	0	0	0	1
2	0	0	1	0
3	0	0	1	1
4	0	1	0	0
5	0	1	0	1
6	0	1	1	0
7	0	1	1	1
8	1	0	0	0
9	1	0	0	1
A	1	0	1	0
B	1	0	1	1
C	1	1	0	0
D	1	1	0	1
E	1	1	1	0
F	1	1	1	1

3. Under “Binary,” interpret **1s** as true and the **0s** as not true.
For example, bit 1 has a **1** in the “Binary” column, indicating “Command Received.” Bit 5 is also a **1** indicating that the “Scanner is in a read cycle.”

<?1> Extended Status

The scanner responds to an extended status request <?1> with several fields, for example: <?1/20><35-558002-10,35-558001-12,F6D4,20C5,02D3,02D3>.

These represent, in order: the status byte discussed above, the boot part number (**35-558002-10**), the application part number (**35-558001-12**), boot checksum (**5F6D4**), app checksum (**02D3**), RAM parameter checksum (**02D3**), and flash parameter checksum (**02D3**).

<K?> All Commands Status

This is the fastest way to learn the scanner’s current configuration. Sending this request will return the current settings of all commands, starting with the lowest K command value and ending with the highest K command value.

<Knnn?> Single Command Status

This request will return the value of the variables associated with the requested K command. The request of a single entry of a database command cannot exceed the number of database slots for the specific command.

<K??> All Command Descriptions

This request will return all current descriptions of every K command, starting with the lowest K command value and ending with the highest K command value.

<Knnn??> Single Command Description

This request returns the basic functional description of all fields in the requested K command.

<K?#> All Command Ranges

This request will return the current settings of all commands within the user-defined range, starting with the lowest user-defined K command value and ending with the highest user-defined K command value.

<Knnn?#> Single Command Range

This request will return the value range and storage type description of all fields in the requested K command.

<Knnn?*> Single Command Wildcard

This request will return the requested K command's status, description, and range for all parameters.

<Knnnd> Single Command Default

This request will default a single K command for the user, provided that the requested K command has user-defined parameters (rather than factory-defined parameters).

13 Output Format

Contents

Output Format Serial Commands.....	13-2
Output Format Status.....	13-3
Format Assign.....	13-4
Format Extract.....	13-5
Format Insert.....	13-7
Output Filter Configuration.....	13-9
Number of Filters.....	13-14

This section explains how to control the formatting and filtering of decoded symbol data for output.

Output Format Serial Commands

Command Title	Command Format
Format Extract	<K740,output index,start location,length>
Format Insert	<K741,output index,length,hex string>
Format Assign	<K742,symbol number,status>
Format Status	<K743,output format status>
Output Filter Configuration	<K744,filter number,symbology,length,wildcard,placeholder,data,decode direction,database index>
Number of Filters	<K745,number of filters>

Output Format Status

Definition: This is a global enable/disable parameter. In order to use formatting you must set up the format using the insert and extract commands, and you must also assign a symbol to format using the **Format Assign** command.

Serial Cmd: <**K743,output format status**>

Default: **Disabled**

Options: 0 = Disabled
1 = Enabled

Output Format Status Disabled

When **Format Status** is set to **Disabled**, output formatting is globally disabled.

Output Format Status Enabled

When **Format Status** is set to **Enabled**, output formatting is enabled. However, **Format Assign**, **Format Insert**, and **Format Extract** must be properly set up as well.

Output Format Status by ESP

On the **Output Format** tab, check the **Enable Output Format** box.

Ordered Output | **Output Format** | Diagnostic Outputs

Enable Output Format Auto Sync with Reader

Set Number of Symbols: 1

Output Phrase

Preamble:	Symbol #1	Postamble:
<input type="text" value="CR"/>		<input type="text" value="CR LF"/>
<input checked="" type="checkbox"/> Enable	<input checked="" type="checkbox"/> Parse	<input checked="" type="checkbox"/> Enable

Show Parse Table

Format Assign

Symbol Number

Definition: **Symbol Number** refers to the number of the symbol to which output formatting will apply. For example, if you wish to enable user-defined formatting to symbol # 2 in a multisymbol read cycle, you would send the command **<K742,2,1>**. Note that the number of symbols may exceed the format capabilities.

Serial Cmd: **<K742, symbol number, status>**

Options: 1 to 12
1 = Formatted output status for symbol # 1.
2 = Formatted output status for symbol # 2.
...
12 = Formatted output status for symbol # 12.

Format Assign Status

Definition: **Status** refers to the user-defined formatting of a selected symbol position in the read cycle result. Note that there is also a global formatting “enable” command that must be set for the formatting to be applied.

Serial Cmd: **<K742, symbol number, status>**

Default: **Disabled**

Options: 0 = Disabled
1 = Enabled (Assign parameters to specified symbol)

Format Assign by ESP

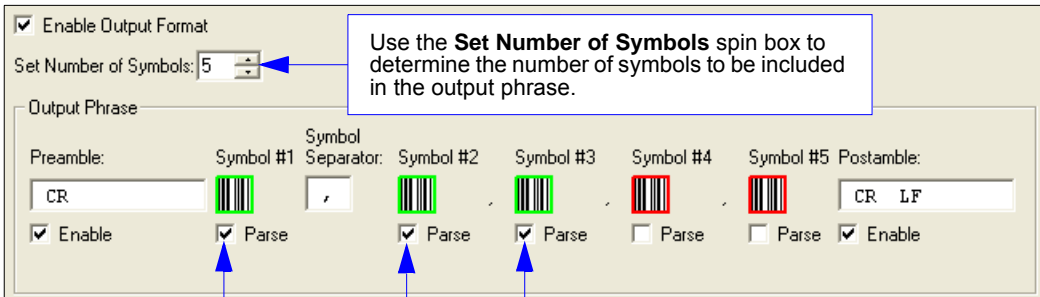

Format Extract

Output Index

Definition: **Output Index** refers to the database entry you wish to modify with this command. A formatted output is built by *extracting data from a symbol's original data output* and/or inserting user-defined characters.

It may be helpful to think of individual indexes as positions in the final formatted output you wish to build. Starting with index # 1, enter either an extract or insert command to begin building your desired output string. Then, with the next index number, enter either an extract or insert command to continue building the output string. Continue this process until you are finished building the string.

Serial Cmd: <**K740,output index,start location,length**>

Options: 1 to 100

Start Location

Definition: Defines the location within the symbol data where the character extraction will begin. The first character extracted will also be the first character in the sequence displayed in user-defined output.

Serial Cmd: <**K740,output index,start location,length**>

Default: **0**

Options: 1 to *n* (maximum number of characters in symbol data)

Length

Definition: Defines the length (in consecutive characters) that will be extracted and placed in user-defined output.

Serial Cmd: <**K740,output index,start location,length**>

Default: **0** (disabled; end of format cell array)

Options: 1 to *n* (maximum number of characters in symbol data)

Format Extract by ESP

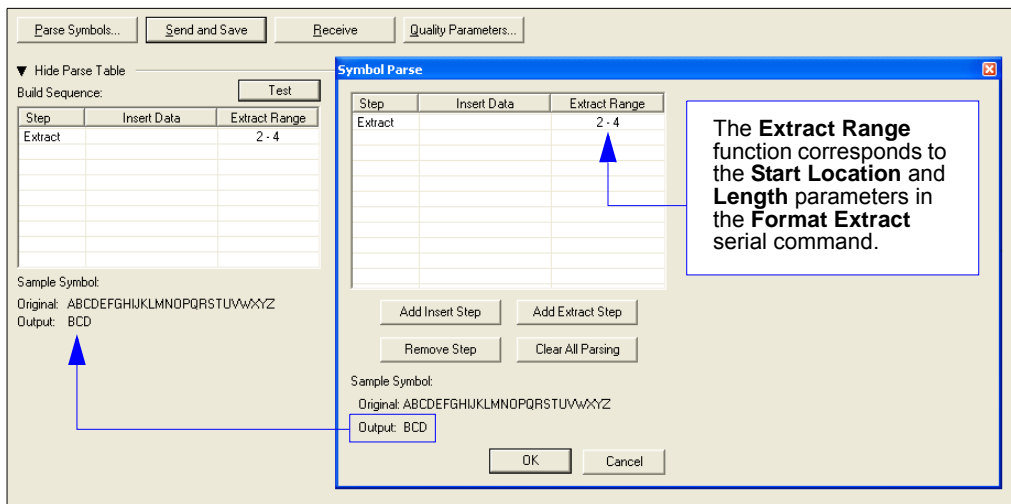

You can extract and insert several character sequences using **ESP's Symbol Parse** feature. In this example, the selected extraction range is characters 2-4. The "Sample Symbol" example on the **Symbol Parse** dialog shows the selected character positions extracted and output as desired. Simultaneously, the data string from the actual selected symbol is displayed at the bottom left of the **Parse Table**, followed by the user-defined extracted output.

Format Insert

Output Index

Definition: **Output Index** refers to the database entry you wish to modify with this command. A formatted output is built by extracting data from a symbol's original data output and/or *inserting user-defined characters*.
It may be helpful to think of individual indexes as positions in the final formatted output you wish to build. Starting with index # 1, enter either an extract or insert command to begin building your desired output string. Then, with the next index number, enter either an extract or insert command to continue building the output string. Continue this process until you are finished building the string.

Serial Cmd: <**K741**,*output index*,*length*,*hex string*>

Options: 1 to 100

Length

Definition: Specifies the length of the user-defined character string that will be inserted. This function is limited to 4 characters per output index, so multiple indexes must be entered in order to insert longer character sequences.

For example, if you wish to insert a 10 character sequence in user-defined output, you would need three commands with consecutive index numbers, where the first two character sequence lengths were 4 and the third was 2.

Serial Cmd: <**K741**,*output index*,*length*,*hex string*>

Default: **0** (disabled; end of format cell array)

Options: 1 to 4

Hex String

Definition: Specifies a character string that represents ASCII characters to be inserted in the database entry. Two hex characters are required for every ASCII character to be inserted in the user-defined output string. These two characters comprise the hex (base 16) value of the ASCII character.

For example, if you wanted to enter the three-character sequence "Hi!" you would enter **3** for the length of the string, and a hex sequence of **486921** for the ASCII sequence to be inserted. (48 = H; 69 = i; 21 = !)

Important: Each pair of hex characters represents one ASCII character. Hex character pairs range from 00 to FF. Since you are limited to 4 ASCII characters per insertion per database entry, you are likewise limited to 8 hex characters per insertion per database entry.

Serial Cmd: <**K741**,*output index*,*length*,*hex string*>

Default: **NUL (00** in hex)

Options: 00 to FF (As many as 4 bytes, or hex pairs.)

Format Insert by ESP

The **Symbol Parse** dialog box contains a table with the following data:

Step	Insert Data	Extract Range
Insert		

Buttons: Add Step, Remove Step, Clear All Parsing, OK, Cancel.

Sample Symbol Parse:
Original: ABCDEFGHIJKLMNOPQRSTUVWXYZ0123456789
Output:

The **Insert** dialog box shows a grid of characters for selection:

SP	SP			
SOH	STX	ETX	EOT	ENQ
ACK	BEL	BS	HT	LF
VT	FF	CR	SO	SI
SI	DC1	DC2	DC3	DC4
NAK	SYN	ETB	CAN	EM
SUB	ESC	FS	GS	RS
US	SP			

Click 'Delete' to remove characters.
Buttons: OK, Cancel.

The **Symbol Parse** dialog box also includes a text box with the following text:

The **Format Insert** process is very similar to the **Format Extract** process, except that **insert** allows you to enter characters using the Insertion Calculator (shown above).

The main interface shows the following controls:

- Parse Symbols
- Send and Save
- Hide Parse Table
- Build Sequence: Test

The main table contains the following data:

Step	Insert Data	Extract Range
Insert	SP SP	
Extract		3 - 5

Buttons: Add Step, Remove Step, Clear All Parsing, OK, Cancel.

Sample Symbol Parse:
Original: micro
Output: cro

The detailed **Symbol Parse** dialog box shows the following data:

Step	Insert Data	Extract Range
Insert	SP SP	
Extract		3 - 5

Buttons: Add Step, Remove Step, Clear All Parsing, OK, Cancel.

Sample Symbol Parse:
Original: ABCDEFGHIJKLMNOPQRSTUVWXYZ0123456789
Output: CDE

Notice that **Extract** and **Insert** share the same **Parse Table**.

Output Filter Configuration

Definition: Output filtering is a method of providing a set of good read qualifiers and also providing ordered output. There is a filter for up to the first 10 positions in a multisymbol output. The first filter corresponds to the first symbol output at the end of the read cycle. Each filter has settings for the following four parameters: **Symbology Type**, **Symbol Length**, **Data**, and **Configuration Database Number**.

Serial Cmd: <**K744**,*filter number,symbology,length,wildcard,placeholder,data,decode direction,database index*>

Rules for Output Filter Configuration

Output Filter Configuration Rule # 1

Each symbol that is decoded must match one of the filters before it can be saved to a read cycle record. There is an exception to this rule, however, when the number of symbols required for a read cycle exceeds the number of active filters. In such a case, unfiltered symbols can be placed into unfiltered output positions.

For example, if the number of symbols required is 6 but there are only 4 active filters, the last 2 positions can be filled by any (unfiltered) qualified symbol.

Output Filter Configuration Rule # 2

The same filter setup can be used multiple times.

For example, filters 1, 2, and 3 can be set up to filter Data Matrix symbols, and the output will occur in the order the symbols are decoded.

Output Filter Configuration Rule # 3

All qualified symbols will be sorted and output in the matching filter position. If a symbol matches filter 3, it will be output as the third symbol. If a filter does not have a matching qualified symbol, a No Read message will be output in place of the symbol (assuming the No Read message is enabled).

For example, if there is not a symbol that meets filter 3's requirements, then a No Read message will be output in the third output position.

Filter Number

Definition: This is the filter index number that represents the position of the symbol in the data output at the end of the read cycle. This index number should be entered along with the following filter settings for the predetermined symbol position.

Serial Cmd: <**K744**, **filter number**, *symbology*, *length*, *wildcard*, *placeholder*, *data*, *decode direction*, *database index*>

Options: 1 to 12

Symbology

Definition: Specifies the symbology type allowed to occupy this location in multisymbol output.

Note: To filter or order a symbol, the symbol must meet all the requirements of the selected filter index.

Serial Cmd: <**K744**, *filter number*, **symbology**, *length*, *wildcard*, *placeholder*, *data*, *decode direction*, *database index*>

Default: **0** (any symbology type)

Options:

- 0 = Any type
- 1 = Interleaved 2 of 5
- 2 = Code 39
- 3 = Code 128
- 4 = Codabar
- 5 = UPC
- 6 = PDF417
- 7 = EAN 128
- 8 = Code 93
- 9 = Pharmacode

Length

Definition: Specifies the length of the decoded symbol allowed to occupy this location in multisymbol output.

Note: To filter or order a symbol, the symbol must meet all requirements of the selected filter index.

Serial Cmd: <**K744**, filter number, symbology, **length**, wildcard, placeholder, data, decode direction, database index>

Default: **0**

Options: 0 to 128

Wildcard

Definition: This is the character to be used in the data output field when performing a data filter comparison. The wildcard character represents the end of matching, and allows for variable lengths of symbol output.

Serial Cmd: <**K744**, filter number, symbology, length, **wildcard**, placeholder, data, decode direction, database index>

Default: “ * ” = (**2A** in hex)

Options: Any ASCII input in the form of a pair of hex characters.

Example:

2A = *

00 = disabled

Placeholder

Definition: The placeholder character requires a character to be present, but does not compare the data value.

Serial Cmd: <**K744**, filter number, symbology, length, wildcard, **placeholder**, data, decode direction, database index>

Default: “ ? ” = (**3F** in hex)

Options: Any ASCII input in the form of a pair of hex characters.

Example:

3F = ?

00 = disabled

Data

Definition: This is the data string to be used when comparing symbol data for output filtering and ordering. This data string may also contain wildcard and placeholder characters to facilitate matching. Remember that in order to filter or order symbol data, it must meet all the requirements of the selected filter index.

Examples:

- Filter data = "123*". This will match data strings of "123", "123456", and "123ABC", but not "12".
- Filter data = "123*AB?C". This will be interpreted as "123*".
- Filter data = "123?". This will match "1234" and "123A", but not "123", "12345", or "1234C".
- Filter data = "123?A". This will match "1234A" and "123BA", but not "123", "1234C", or "1234ABCD".
- Filter data = "123?A?". This will match "1234AB" and "123BAT", but not "1234A" or "123BATS".
- Filter data = "12??*". This will match "1234", "123456", and "123ABC", but not "12" or "123".
- Filter data = "123?A*". This will match "1234A", "123BA", and "123BATS", but not "1234" or "1234C".

Serial Cmd: <K744,filter number,symbology,length,wildcard,placeholder,data,decode direction,database index>

Default: **NUL (00** in hex)

Options: Any ASCII input in the form of a pair of hex characters.
Maximum length: 63 bytes defined.

Examples:

41422A = AB*

Data [0] = **NUL** represents string matching disabled.

Decode Direction

Definition: Decode direction is determined by the direction of the output filter.

Serial Cmd: <K744,filter number,symbology,length,wildcard,placeholder,data,decode direction,database index>

Default: **0** (any direction)

Options: 0 = Any Direction
1 = Forward
2 = Reverse

Database Index

Definition: The index of the database entry that decodes a given symbol must equal this setting for filtering to occur. A setting of **0** allows any database index for this filter entry.

Serial Cmd: <**K744**, filter number, symbology, length, wildcard, placeholder, data, decode direction, **database index**>

Default: **0**

Options: 0 = Any Database Index

1 = Database # 1 to *n* (maximum number of characters in the symbol data)

Number of Filters

Definition: **Number of Filters** refers to the number of active output filters. **0** disables all output filters. Any non-zero numeral will enable filtering to be performed using the filter indexes covered by this value.

For example, if the number of filters is **1**, then only filter index # 1 will be applied. If the number of filters is **2**, then only filter index # 1 and filter index # 2 will be applied, etc.

Serial Cmd: **<K745,number of filters>**

Default: **0**

Options: 0 to 12

14 Wiring Box

Contents

Wiring Box Description	14-2
Installation Steps	14-3
Wiring Box Ports.....	14-5
Wiring Box PCB with Connectors	14-8
Mounting Plate.....	14-9

This section has instructions for assembling, wiring and using the MS-890's optional Wiring Box. When this option is selected, the MS-890 and wiring box option are shipped as an assembly.

Wiring Box Description

Note: The wiring box PCB resides inside the wiring box.

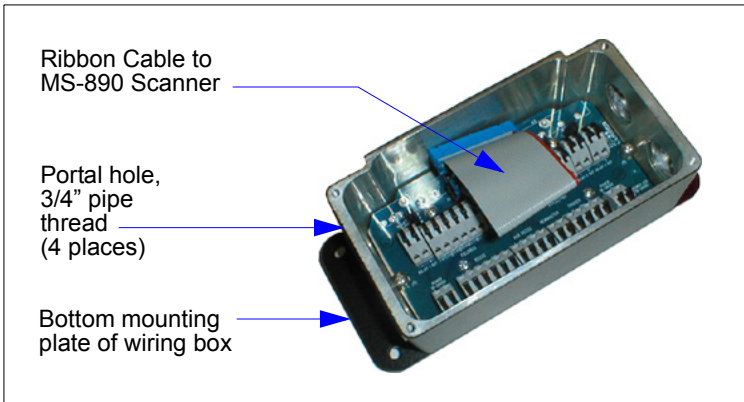

Portal Holes

The wiring box has four external portal holes which are standard 3/4" pipe thread. Mounting of the box is with four through holes in flanges that extend out over the ends.

Terminal Strip Specifications

Wire strip length: .24" (6 mm)

Wiring range: 14 - 28 AWG

Current: 13A maximum

Installation Steps

1. Connect power through the portal holes (see [Check Required Hardware](#) on page 1-2).
2. Temporarily apply power to the scanner and confirm that the light next to the input terminal is green and not red.
3. Disconnect power before making the remaining connections.
4. Connect the host and trigger port wires through the portal holes to the appropriate connections.
5. Plug the ribbon cable into the scanner as shown below (apply pressure back and forth on the connector to ensure that it fits inside the receptacle).

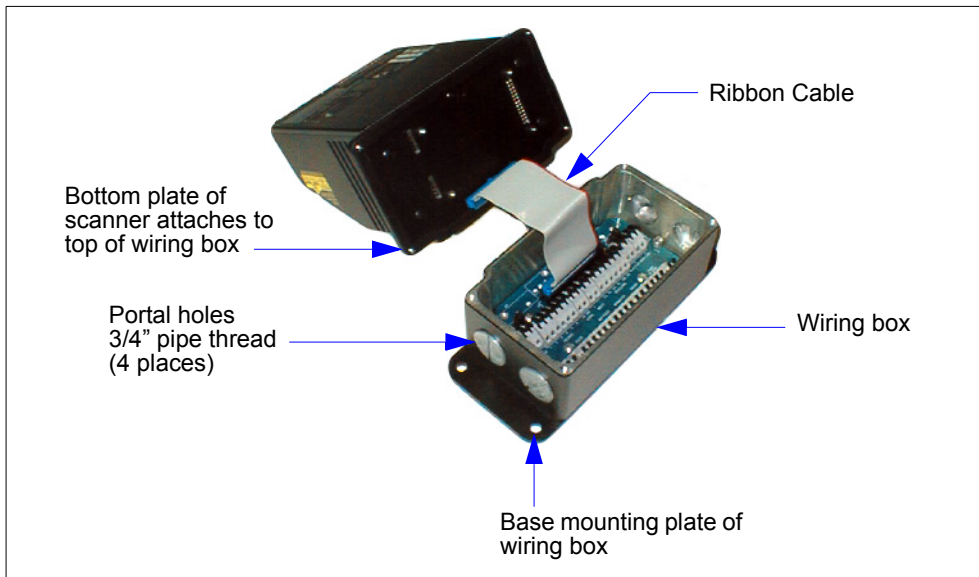

Installation Steps (cont.)

6. Attach the scanner to the wiring box with four attached mounting screws in the bottom plate of the scanner, making sure that the gasket is evenly seated.

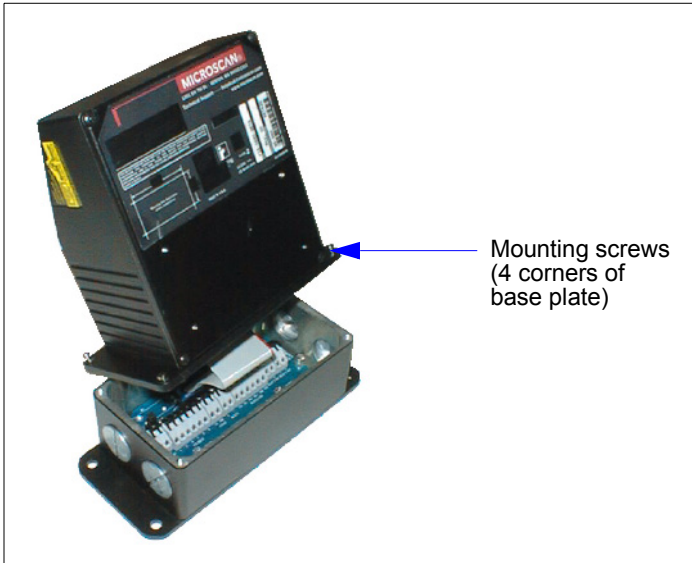

7. Mount the wiring box (see [Wiring Box Ports](#) on page 14-5).

Wiring Box Ports

Relay Modules

These can be used as an alternative to the 3 optoisolated outputs from the scanner itself. K1, K2, and K3 are module sockets for SM off-the-shelf AC/DC output/relay modules.

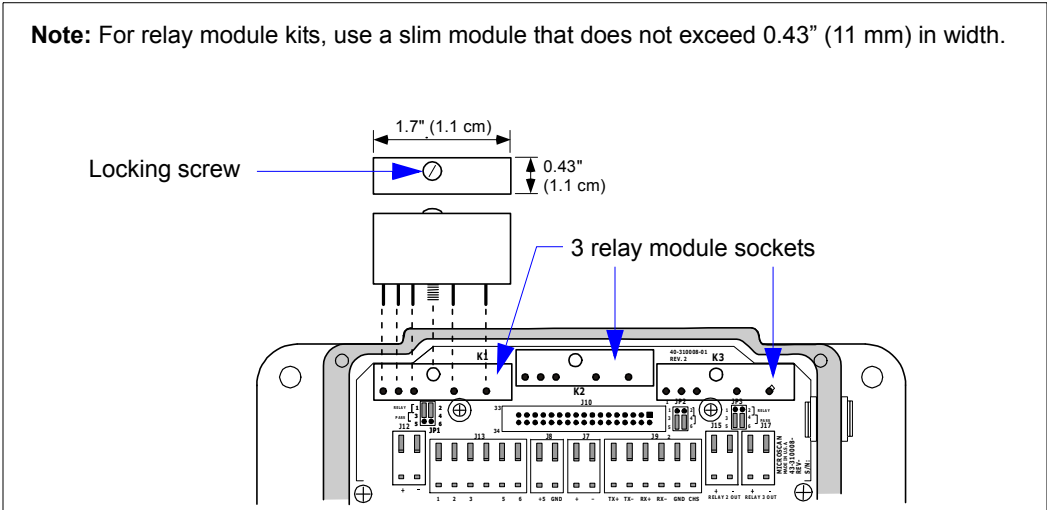

Jumpers

When installing relay modules in K1, K2, and K3, corresponding jumpers (J1, J2, J3) need to be moved. Move jumpers from 3-5 to 1-3 and 4-6 to 2-4 for each relay to be installed (K1, K2, K3).

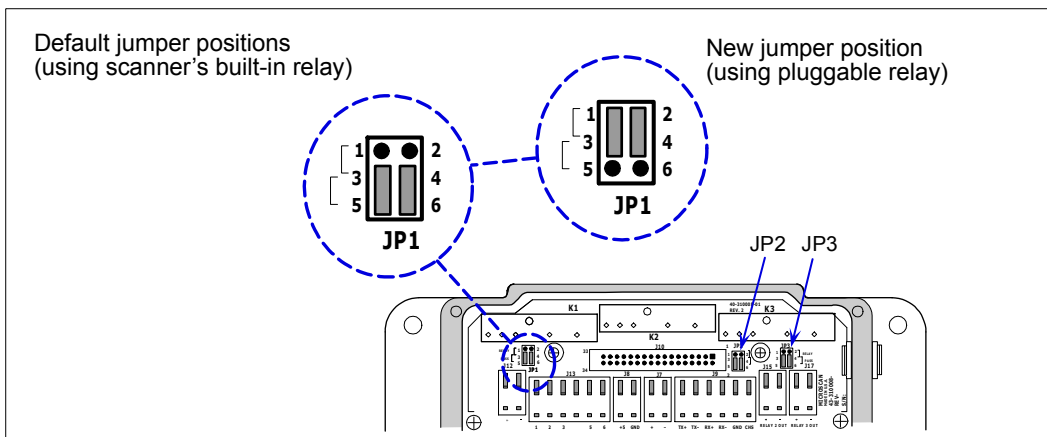

Relay Terminals

Relay terminals 1, 2, and 3 provide output for both internal optoisolated outputs and alternative relay modules that can be installed in modules K1, K2, and K3.

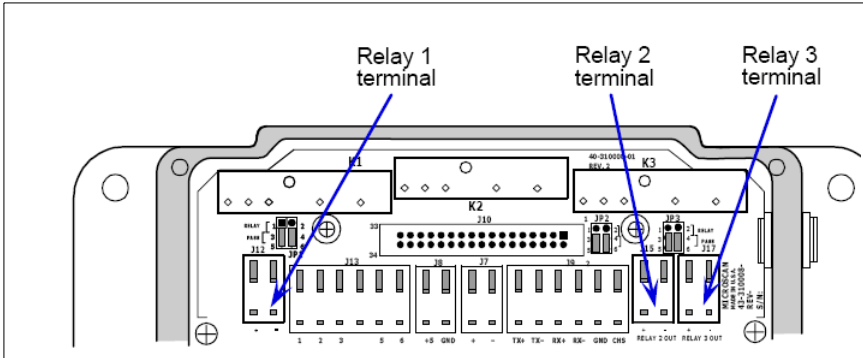

Relay1 Output handles discrete outputs from the scanner that will switch up to 100 mA of optoisolated current.

+5 VDC

Voltage out that can drive a hand held scanner. Maximum current is 5 watts.

Input 1

Used to wire a switch to reset latch mode or counters.

RS-422/485

Used for multidrop or 422 port.

Power 10-28 VDC

Power input port (left side and right side for connectivity convenience).

RS-232

Main serial communication port.

Aux RS-232

Daisy chain and Auxiliary connections.

New Master Pin

Allows you to wire in a switch for New Master Pin. (See [Optoisolator Inputs](#) on page A-7.)

Trigger Port (NPN)

To initiate the read cycle. (See [Optoisolator Inputs](#) on page A-7.)

Power LED

GREEN means the polarity of the input connections is correct; **RED** means it is reversed.

Caution: While the MS-890 scanner has reverse polarity protection built in to its circuitry, the wiring box does not protect external circuits that may already be wired in when power is applied.

Wiring Box PCB with Connectors

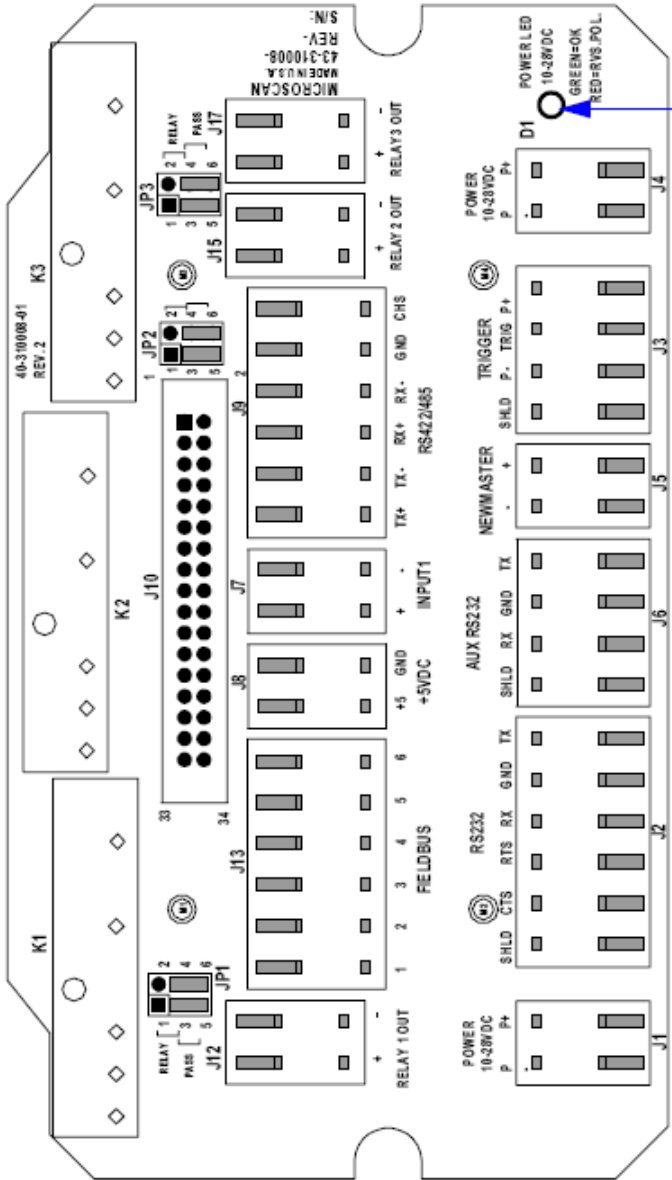

Polarity indicator is **GREEN** if connected correctly and **RED** if connected incorrectly.

Mounting Plate

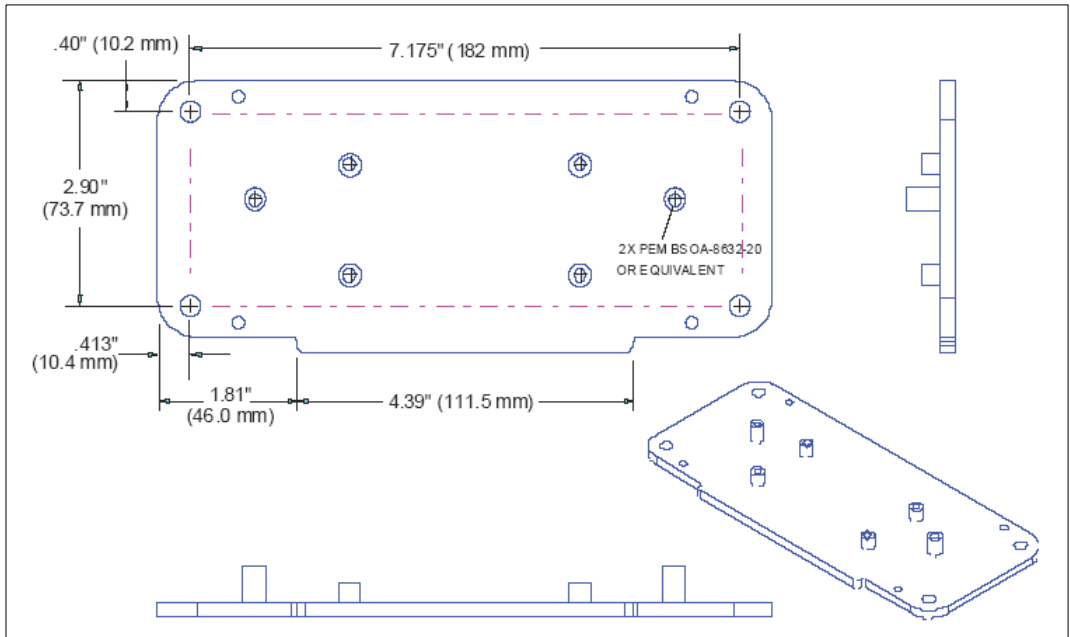

IB-890 Wiring Box Mounting Plate

Appendices

Appendix A General Specifications.....	A-2
Appendix B Electrical Specifications.....	A-4
Appendix C Serial Configuration Commands	A-9
Appendix D ASCII Table	A-15
Appendix E Embedded Menus	A-17
Appendix F Defaulting / Saving / Initializing.....	A-18
Appendix G Position Scanner and Symbol	A-21
Appendix H Object Detector	A-22
Appendix I Bar Code Configuration	A-23
Appendix J Test Read Rate	A-25
Appendix K Formulas for Number of Decodes	A-27
Appendix L Operational Tips.....	A-32
Appendix M Interface Standards.....	A-33
Appendix N Multidrop Communications.....	A-34
Appendix O Glossary of Terms.....	A-39

Appendix A — General Specifications

Mechanical

Height: 3.5" (88 mm)
Width: 5" (127 mm)
Depth: 6" (152 mm)
Weight: 5 lbs. (2268 g)

Environmental

Enclosure: IP65
Operating Temperature: 0° to 50°C (32° to 122°F)
Storage Temperature: -50° to 75° C (-58 to 167°F)
Humidity: up to 90% (non-condensing)

Emissions and Immunity

EN61000-6-3:2001: for Class A products
EN61000-3-2:2000+A2:2005
EN61000-3-3:1995+A1:2001
EN61000-6-2: Immunity

Laser Light

Type: Semiconductor visible laser diode (650 nm nominal)
Operating Life: 50,000 hours @ 25°C (77°F)
Safety Class: CDRH Class II

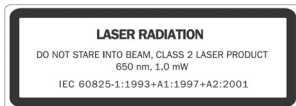

Indicators

Beeper: Good Read, Match/Mismatch, No Read, serial command confirmation
LEDs: 1 status, 1 power, 1 Good Read, 5 read performance (representing percentage of good decodes), network/include status, green flash

Discrete I/O

Trigger, New Master, Input 1: Optoisolated, 5-28V rated (12mA at 24VDC)
Outputs (1, 2, 3): Optoisolated, 1-28VDC rated, (I_{CE} < 100mA @ 24VDC, current limited by user)

Communications

Interface: RS-232, RS-422/485, Daisy Chain/Aux Port-capable, dedicated configuration port

Symbologies

Standard symbologies: Code 39, Code 128, UPC/EAN, Interleaved 2 of 5, Codabar, Code 93, PDF417
Applications Standards: AIAG, GS1-128

Scanning Parameters

Scanner Mirror Type: Rotating, single line, 14-faceted
Scan Rate: Adjustable from 400 to 1000 scans/second (default = 500 scans/second)
Raster Sweep Speed: 1 to 30 sweeps/second
Raster Sweep Angle: 30° maximum
Scan Width Angle: Typically 60°
Pitch Angle: ±50° maximum
Skew Angle: ±40° maximum
Contrast: 25% min. absolute dark-to-light differential at 650 nm wavelength

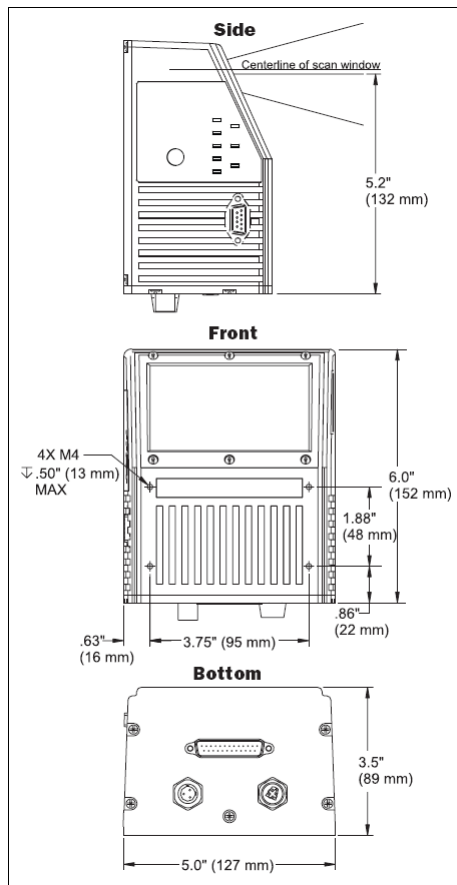

MS-890 Dimensions

Read Ranges

Symbol/Narrow Bar Width	Read Range
7.5 mil (.190 mm)	10" to 35" (254 to 889 mm)
10 mil (.254 mm)	10" to 44" (254 to 1118 mm)
15 mil (.381 mm)	10" to 74" (254 to 1880 mm)
20 mil (.508 mm)	10" to 90" (254 to 2286 mm)
30 mil (.762 mm)	10" to 100" (254 to 2540 mm)
40 mil (1.020 mm)	10" to 110" (254 to 2794 mm)
50 mil (1.27 mm)	10" to 120" (254 to 3048 mm)

FIS Options

MS-890 Industrial Automation Scanner	
Long Range, Stand Alone Version, RS-232/485, 10-28VDC	FIS-0890-0001G
Long Range, Wiring Box-Ready, RS-232/485, 10-28VDC	FIS-0890-0002G

Safety Certifications

FCC, CDRH, CE, UL/cUL, BSMI, RoHS/WEEE Compliance



ISO Certification

ISO 9001 Certified
 Issued by TÜV USA

©2010 Microscan Systems, Inc.

All rights reserved. Specifications subject to change.

Product specifications are given for typical performance at 25°C (77°F) using grade A labels. Performance characteristics may vary at high temperatures or other environmental extremes. Warranty—One year limited warranty on parts and labor. Extended warranty available.

Appendix B — Electrical Specifications

Maximum Operating Power: 24 Watts

Power Requirement: 10 to 28VDC, 200mV p-p max. ripple, 230mA @ 24VDC (typ.)

Trigger, New Master, Input 1: 4.5 to 28 VDC (optoisolated)

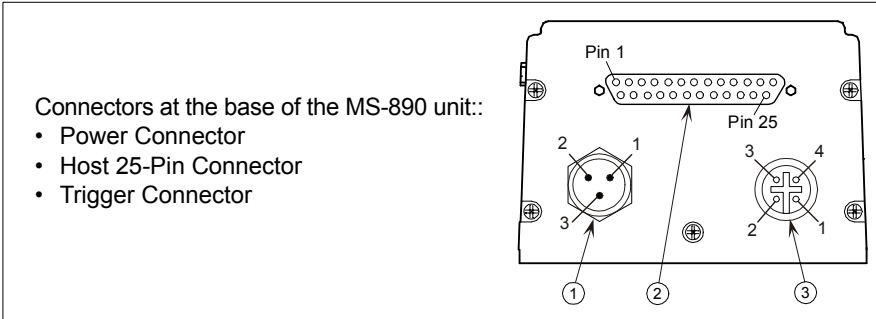

Caution: Be sure that all cables are connected **BEFORE** applying power to the system. Always power down **BEFORE** disconnecting any cables.

Power Connector: 3-pin microchange plug

1	Power Ground
2	N/C
3	Power 10 to 28 VDC (in)

Caution: If using your own power supply, verify correct connection of power and ground lines. Incorrect connections or use of “Chassis ground,” “Power ground,” and “Signal ground” lines could cause equipment and/or software failure.

Trigger Connector: 4-pin microchange socket

1	Power 10 to 28 VDC (out)
2	NPN
3	Ground
4	N/C

Programming Connector: 9-pin D-sub plug

2	RX232
3	TX232
5	Signal Ground
9	Boot Mode

Note: RS-422 and RS-232 are both enabled by default in the MS-890.

Host 25-Pin Connector

25-pin D-sub plug

Pin	Host RS-232	Host and Aux RS-232	Host RS-422/485	I/O
1	Chassis Ground ^a			
2	Host TxD			Out
3	Host RxD			In
4	RTS	Aux TxD		Out
5	CTS	Aux RxD		In
6	Output 1 (+)			Out
7	Signal Ground ^b			
8	Output 2 (+)			Out
9	Trigger (-)			In
10	Trigger (+)			In
11	N/C			
12	Input 1 (+)			In
13			RxD (+)	In
14			TxD (-)	Out
15	No Read/Output 3 (+)			Out
16			RxD (-)	In
17	Power Ground ^c			
18	Power + 10 to 28 VDC			In
19			TxD (+)	Out
20	Output 1 (-)			Out
21	Output 2 (-)			Out
22	No Read/Output 3 (-)			Out
23	Input 1 (-)			In
24	New Master (-)			In
25	New Master (+)			In

a. Chassis Ground: Used to connect chassis body to earth ground only. Not to be used as power or signal return.

b. Signal Ground: Used for communication and signal line grounds only. Not to be used as power or chassis return.

c. Power Ground: Used for power return only.

CAUTION: If using your own power supply, verify correct connection of power and ground lines. Incorrect connections or use of Chassis Ground, Power Ground, and Signal Ground lines could cause equipment failure or software failure.

Optoisolator Outputs

Optoisolator circuits can transfer pulses between the scanner and peripherals with no direct connection with the scanner's internal circuitry. However, not every optoisolator configuration provides complete isolation. The following diagrams show both fully optoisolated and non-optoisolated circuits. They are only examples and do not represent all possible wiring configurations.

	$I_{load}=5mA$	$I_{load}=50mA$	$I_{load}=100mA$
V_{Out-On}	0.7V	0.9V	1.0V
t_{On-Typ}	30 μS	20 μS	30 μS
$t_{Off-Typ}$	1000 μS	150 μS	75 μS

Output Circuit Examples

Fully Optoisolated

This circuit is fully optoisolated and is the recommended configuration. It allows the user to apply 1 to 28VDC to the circuit.

Caution: The maximum current that can pass through the optoisolator is 100mA.

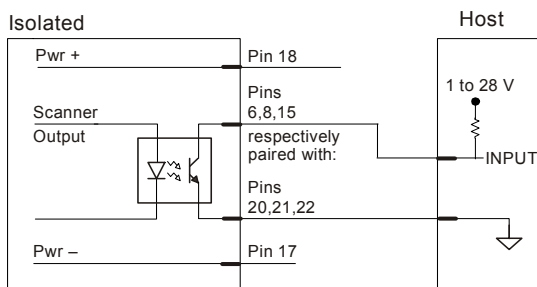

Not Optoisolated, Scanner Grounded

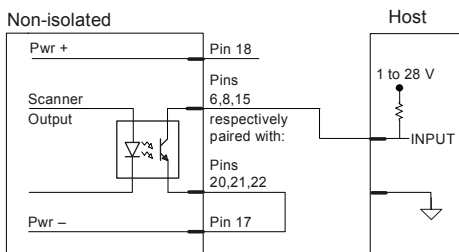
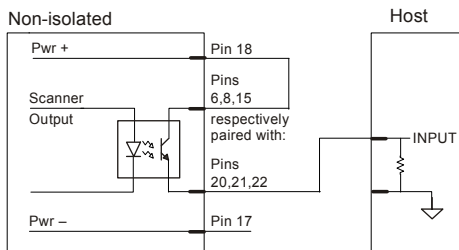

Optoisolator Inputs

New Master pin and Trigger pulses can be sent to the scanner in the following ways:

New Master Pin Inputs

Waveform Characteristics:		
	Minimum	Maximum
$V_{IN-HIGH} / I_{IN-HIGH}$	4.5V / 4 mA	28V / 33 mA
V_{IN-LOW} / I_{IN-LOW}	0V / 0 mA	2V / 2 mA
Pulse Width _{min}	48 μ S	

25-pin Host Connector

The following New Master Pin inputs can be fully isolated pulses as PNP or NPN circuits.

PNP Circuits

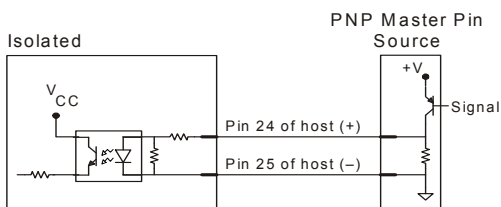

NPN Circuits

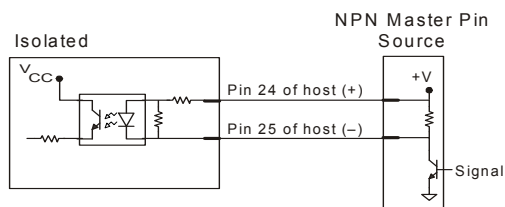

Trigger Inputs

Waveform Characteristics:			
		Minimum	Maximum
$V_{IN-HIGH}$	$I_{IN-HIGH}$	4.5V / 4 mA	28V / 33 mA
V_{IN-LOW}	I_{IN-LOW}	0V / 0 mA	2V / 2 mA
Pulse Width	t_{min}	48 μ S	

Trigger pulses can be sent to the scanner either through the host 25-pin connector or a separate 4-pin trigger connector on the bottom of the scanner.

4-pin Trigger Input

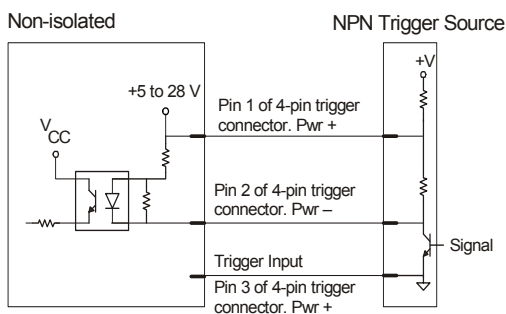

25-pin Trigger Input

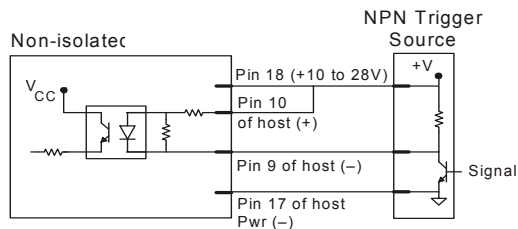
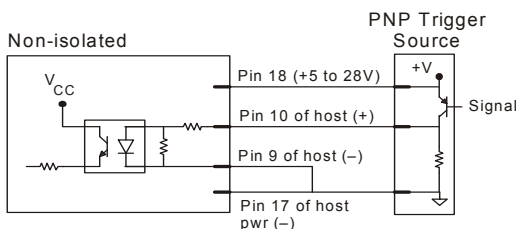
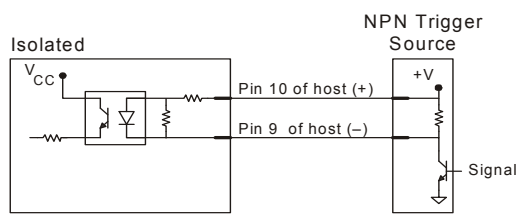
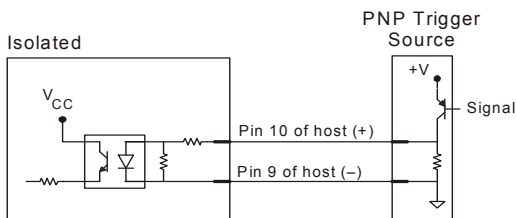

Appendix C — Serial Configuration Commands

Communications	
Host Port Parameters	<K100,baud,parity,stop bits,data bits>
Aux Port Parameters	<K101,aux port mode,baud,parity,stop bits,data bits,daisy chain ID status,daisy chain ID>
Host Protocol	<K140,protocol,address>
Preamble	<K141,status,preamble character(s)>
Postamble	<K142,status,postamble character(s)>
Response Timeout	<K143,timeout setting>
Intercharacter Delay	<K144,time interval>
LRC	<K145,status>
Auxiliary/Configuration Port System Data	<K146,aux port status,config port status>
ACK/NAK Options	<K147,RES,REQ,STX,ETX,ACK,NAK>
Polling Mode Options	<K148,RES,REQ,STX,ETX,ACK,NAK>
Daisy Chain Autoconfigure	<K150DAISY>
Daisy Chain Scanner ID	<K151,daisy chain scanner,daisy chain scanner ID>
Read Cycle	
Trigger Mode	<K200,trigger mode,trigger filter duration>
Serial Trigger Character	<K201,trigger character>
External Trigger State	<K202,external trigger state>
End of Read Cycle	<K220,end of read cycle mode,read cycle timeout>
Good Decode Reads	<K221,number before output,mode>
Multisymbol	<K222,number of symbols,multisymbol separator>
Start Serial Trigger Character	<K229,start trigger character>
End Serial Trigger Character	<K230,end trigger character>
Scan Speed	<K500,scan speed>
Maximum Element	<K502,max element>
Gain/Tracking	<K504,gain,tracking>
AGC Settings	<K505,AGC sampling status,transition counter>
Focus	<K508,focus position,zero position>
Tracking Adjustment	<K520,tracking adjustment>
Symbologies	
Narrow Margins/Symbology ID	<K450,narrow margins status,symbology identifier status>
Background Color	<K451,background color>
Code 39	<K470,status,check character status,check character output status,large intercharacter gap,fixed symbol length status,fixed symbol length,full ASCII set>
Codabar	<K471,status,start and stop match,start and stop output,large intercharacter gap,fixed symbol length status,fixed symbol length,check character type,check character output>
Interleaved 2 of 5	<K472,status,check digit status,check digit output,symbol length #1,symbol length #2,guard bar status,range mode status>

Serial Configuration Commands

UPC/EAN	<K473,UPCstatus,EAN status,supplementals status,separator status,separator character,supplemental type>
Code 128/EAN-128	<K474,Code 128 status,fixed symbol length status,symbol length,EAN-128 status,output format,application record separator status,application record separator character,application record brackets status,application record padding status,minimum ratio distance>
Code 93	<K475,status,fixed symbol length status,fixed symbol length>
PDF417	<K476,status,raster sweeps before decode attempt,fixed symbol length status,fixed symbol length,decode at end of read>
Pharmacode	<K477,status,fixed symbol length status,fixed symbol length,minimum number of bars,bar widths,direction,fixed threshold value>

I/O Parameters

Serial Verification	<K701,serial command echo status,serial command beep status,control/hex output>
Beeper	<K702,status>
Quality Output	<K704,quality output separator,reads/trigger status,direction output>
Symbol Data Output	<K705,status,when to output>
Read Duration Output	<K706,status,separator>
No Read Message	<K714,status,message>
Bad Symbol Message	<K715,status,bad symbol message>
No Symbol Message	<K716,status,no symbol message>
Input 1	<K730,mode,active state>
Target/Flood LEDs	<K750,green flash LED status,green flash duration>
Database Identifier Output	<K759,status,separator>
EZ Button	<K770,global mode,default on power-on status>
EZ Button Modes	<K771,one beep,two beeps,three beeps>
Trend Analysis Output 1	<K780,trend analysis mode,number of triggers,number to output on,decodes/trigger threshold>
Trend Analysis Output 2	<K781,trend analysis mode,number of triggers,number to output on,decodes/trigger threshold>
Trend Analysis Output 3	<K782,trend analysis mode,number of triggers,number to output on,decodes/trigger threshold>
Diagnostic Output 1	<K790,over temperature,service threshold,[unused],laser current high,laser current low,low temperature>
Diagnostic Output 2	<K791,over temperature,service threshold,[unused],laser current high,laser current low,low temperature>
Diagnostic Output 3	<K792,over temperature,service threshold,[unused],laser current high,laser current low,low temperature>
Configurable Output 1	<K810,output on,output state,pulse width,output mode>
Configurable Output 2	<K811,output on,output state,pulse width,output mode>
Configurable Output 3	<K812,output on,output state,pulse width,output mode>

Matchcode

Matchcode Type	<K223,matchcode type,sequential matching,match start position,match length,wild card character,sequence on No Read,sequence on mismatch>
----------------	--

Master Symbol Database Size	<K224,number of master symbols>
New Master Pin	<K225,status>
Configuration Database	<K227,database index,focus position,gain,tracking,AGC mode,raster top,raster bottom,raster speed,laser framing status,laser on position,laser off position,laser power,background color>
Sequential Step	<K228,sequence step>
Enter/Delete Master Symbol Data	<K231,master symbol number,master symbol data [no data will delete current master symbol data]>
Request Master Symbol Data	<K231,?>[for all] or <K231,master symbol number?>
Match Replacement Message	<K735,status,match replacement message>
Mismatch Replacement Message	<K736,status,mismatch replacement message>

Diagnostics

Warning Message Status	<K400,warning message status,laser high status,laser low status,NOVRAM/reset warning status>
Lifetime Hours	<K401,hours10,message>
High Temperature	<K402,degrees,message>
Low Temperature	<K403,degrees,message>
Power-On/Resets Counts	<K406?> returns: power-ons,resets (Read-Only)
Hours Since Last Reset	<K407?> returns: hours,minutes (Read-Only)
Present Operating Temperature	<K408?> returns: current operating temp. (Read-Only)
Service Message	<K409,status,message,time,resolution>
Laser Current Warning	<K411,high current status,high current message,low current warning, low current message>

Calibration / Configuration Database

Optoelectric Control	<K226,mode,# active database settings,latch on trigger,timer/switch value,control trigger 1 status,control trigger 2 status,control trigger 3 status,database cycles>
Configuration Database	<K227,database index,focus position,gain,tracking,AGC mode,raster top,raster bottom,raster speed,laser framing status,laser on position,laser off position,laser power, background color>
Save Configuration Database	<K227+,database index>
Load Configuration Database	<K227-,database index>
Request Configuration Database	<K227?,database index> or <K227?> for entire database.
Advanced Calibration	<K510,auto range,starting focus position,focus step size>

Raster/Laser

Raster	<K506,raster status,top offset,bottom offset,raster sweep rate,read cycle on/off>
Laser On/Off	<K700,laser on/off status,laser framing status,laser on position,laser off position,laser power>

Output Format

Format Extract	<K740,output index,start location,length>
----------------	---

Serial Configuration Commands

Format Insert	<K741,output index,length,hex string>
Format Assign	<K742,symbol number,status>
Format Status	<K743,output format status>
Output Filter Configuration	<K744,filter number,symbology,length,wildcard,placeholder,data,decode direction,decode direction>
Number of Filters	<K745,number of filters>

Serial Command Format

Serial commands are of two types: utility and configuration.

Rules that apply to both utility and configuration commands

- A less than < and greater than > character enclose the commands.
- Commands and data are “case sensitive.” That is, characters must be entered as upper or lower case, as specified.

Serial Utility Commands

These are sent during operations and are not followed by <A> or <Z>.

Serial Configuration “K” Commands

These begin with a single **K** character followed by a 3-digit numeric character, data fields, and an initializing command, as follows:

<K*numeric parameter,data,data,...etc.*><initializing command>

An initializing command <A> or <Z> may follow the command. A <Z> initializes the scanner’s memory and saves for power-on; an <A> initializes the scanner’s memory but does not save for power-on.

For example, to enable **UPC** and save the change for power-on, send <K473,1><Z>.

To change **Baud Rate** and reset without saving changes for power-on, send <K100,3><A>.

Serial Configuration Command Conventions

- All data fields (except the last) must be followed by a comma (*without a space*).
- All fields preceding a modified field must be included.
- If there is no change in preceding fields, then commas alone can be entered in these fields. For example, if only the last field in the following command is changing, <K100,4,1,0,0> can be entered as <K100,,,,0>.
- All fields *following* a modified field can be omitted. For example, to change **Baud Rate** only, send <K100,3>.

Concatenating Configuration Commands

Commands can be concatenated (added together) in a single string or data block. For example, **<K145,1><K220,1><K450,1><A>** enables **LRC**, sets **End of Read Cycle** mode to **New Trigger**, enables **Narrow Margins**, and resets the data buffers (without saving the changes for power-on).

Serial Command Status Request

To ensure that any command was received and accepted, you can send the **Show Reader Status** command: **<?>**.

The status of a specific serial command can be requested by entering the command followed by a question mark. For example, send **<K142?>** to request the status of **Postamble**.

Entering Control Characters in Serial Commands

To enter control characters within a serial command, hold down the **Ctrl** key while typing the desired character.

Example: To enter a carriage return and line feed (**^M^J**), enter **<K141,1,CNTL-m CNTL-j>**

Entering Special Characters in Embedded Menus

Control Characters

Control characters entered on the command line are displayed in the menu as mnemonic characters, such as: **<CR><LF><NUL><NUL>**

Press **SP** (the space bar) once, then enter the control character by holding down the control key and simultaneously pressing the desired character. For example to define a line feed, press **SP**, then **Control** and **J** simultaneously. It is displayed as **^J** on the command line and as **<LF>** in the menu when the screen is refreshed.

To Define a Carriage Return as a Character

Press **SP**, then **CR**. It is displayed as **^M** on the command line and as **<CR>** in the menu when the screen is refreshed.

To Define a Space as a Character

Press **SP** twice. It is displayed as a blank space in the menu when the screen is refreshed. While it appears that nothing has been assigned, the hex value 20 will be sent during data transmission.

To Select NUL as the Character

Press **SP**, then a **0**. It is displayed as **<NUL>** in the menu when the screen is refreshed.

Appendix D — ASCII Table

ASCII Table with Control Characters

Dec	Hex	Mne	Ctrl	Dec	Hex	Ch	Dec	Hex	Ch	Dec	Hex	Ch
00	00	NUL	^@	32	20	SP	64	40	@	96	60	`
01	01	SOH	^A	33	21	!	65	41	A	97	61	a
02	02	STX	^B	34	22	"	66	42	B	98	62	b
03	03	ETX	^C	35	23	#	67	43	C	99	63	c
04	04	EOT	^D	36	24	\$	68	44	D	100	64	d
05	05	ENQ	^E	37	25	%	69	45	E	101	65	e
06	06	ACK	^F	38	26	&	70	46	F	102	66	f
07	07	BEL	^G	39	27	'	71	47	G	103	67	g
08	08	BS	^H	40	28	(72	48	H	104	68	h
09	09	HT	^I	41	29)	73	49	I	105	69	i
10	0A	LF	^J	42	2A	*	74	4A	J	106	6A	j
11	0B	VT	^K	43	2B	+	75	4B	K	107	6B	k
12	0C	FF	^L	44	2C	,	76	4C	L	108	6C	l
13	0D	CR	^M	45	2D	-	77	4D	M	109	6D	m
14	0E	SO	^N	46	2E	.	78	4E	N	110	6E	n
15	0F	SI	^O	47	2F	/	79	4F	O	111	6F	o
16	10	DLE	^P	48	30	0	80	50	P	112	70	p
17	11	DC1	^Q	49	31	1	81	51	Q	113	71	q
18	12	DC2	^R	50	32	2	82	52	R	114	72	r
19	13	DC3	^S	51	33	3	83	53	S	115	73	s
20	14	DC4	^T	52	34	4	84	54	T	116	74	t
21	15	NAK	^U	53	35	5	85	55	U	117	75	u
22	16	SYN	^V	54	36	6	86	56	V	118	76	v
23	17	ETB	^W	55	37	7	87	57	W	119	77	w
24	18	CAN	^X	56	38	8	88	58	X	120	78	x
25	19	EM	^Y	57	39	9	89	59	Y	121	79	y
26	1A	SUB	^Z	58	3A	:	90	5A	Z	122	7A	z
27	1B	ESC	^[59	3B	;	91	5B	[123	7B	{
28	1C	FS	^\	60	3C	<	92	5C	\	124	7C	
29	1D	GS	^]	61	3D	=	93	5D]	125	7D	}
30	1E	RS	^^	62	3E	>	94	5E	^	126	7E	~
31	1F	US	^_	63	3F	?	95	5F	_	127	7F	D

Communications Protocol Command Table

Protocol Command (Mnemonic displayed on menu)	Control Characters (Entered in menu or serial command)	Hex Value	Effect of Command
RES	^D	04	Reset
REQ	^E	05	Request
EOT	^D	04	Reset
STX	^B	02	Start of Text
ETX	^C	03	End of Text
ACK	^F	06	Acknowledge
NAK	^U	15	Negative Acknowledge
XON	^Q	11	Begin Transmission
XOFF	^S	13	Stop Transmission

Appendix E — Embedded Menus

In addition to **ESP**, you can also use a communications menu such as HyperTerminal to establish communication with Microscan's embedded menus.¹

12. With your host connected to the 9-pin configuration port, set your host communications settings as follows: **57.6K** baud, **8** Data Bits, **1** Stop Bits, and **None** Parity. *OR*, with your host connected to the 25-pin configuration port, set your host communications settings as follows: **9600**, **7**, **1**, and **Even**.
13. Set **Flow Control** to **None**.
14. Make the communications port selection. (Usually **COM 1** or **COM 2** for desktops and **COM 1** for laptops.)
15. Upon connection, send a **<D>** command to bring up the main menu.

MICROSCAN SYSTEMS, INC. CONFIGURATION PROGRAM MAIN MENU	
TOPICS	DESCRIPTION
1) COMMUNICATIONS	HOST PROTOCOL & HOST/AUX PORT CONFIG.
2) OPERATIONS	TRIGGERING, TIMEOUTS, ETC.
3) CODE TYPES 1	CODE 39, I 2 OF 5, CODE 128, CODE 93
4) CODE TYPES 2	PDF417, CODABAR, UPC, CODE PARAMETERS
5) OPTO-ELECT. CONTROL	OPTO-ELECT. CONTROL, CONFIG. DATA BASE
6) SCANNER I/O	PROGRAMMABLE I/O
7) SCANNER OUTPUT	BEEPER, LASER, OUTPUT MODES, ETC.
8) SCANNER SETUP	FACTORY, AGC, AND RASTER SETTINGS
9) DIAGNOSTICS SETUP	WARNING MESSAGES, OPERATION TIME, ETC.
10) NETWORK CONFIGURATION	DEVICE NET, PROFIBUS, ETHERNET, DH, REM. I/O
11) OUTPUT ORDER FILTERS	SORT ORDER LABEL OUTPUT FILTERS.

ESC = MAIN MENU OR EXIT	N = NEXT ITEM
M = PREVIOUS MENU	SP = NEXT ITEM
B = PREVIOUS ITEM	CR = THIS ITEM

MAIN--> COMMUNICATIONS	

Note: The 9-pin configuration port settings are fixed.

Important: To receive symbol data through the 9-pin configuration port, you must enable the port with the following command: **<K146,,1>**.

16. Press the return key (**CR**) to view the communications menu.
Menu navigation commands are case sensitive. Use the space bar or **N** to advance to the next item, **CR** (return key) to select a highlighted item, **B** to return to the previous item, **M** to return to the previous menu, and **ESC** to return to the Main menu or to exit the program. When exiting the program, you will be prompted to save your active settings for power up (**Y** or **N**). Typing **Y** will be equivalent to saving with a **<Z>** command.

1. If you are using HyperTerminal, you may find that the initial screen is unviewable when you call up the program with the **<D>** command. If this occurs, simply exit the embedded menu with a **ESC**, **E**, and **N** sequence and repeat the **<D>** command.

Appendix F — Defaulting/Saving/Initializing

Active Memory is where the scanner's settings are stored during current use and are initialized by an **<A>** command.

Microscan Defaults are where the scanner's default application/boot programs are stored. They can only be changed by changing the application/boot codes.¹

User-Saved Settings are where user-defined settings are saved for power-on.

Defaulting

Defaulting occurs when default settings (either Microscan or user-saved) are restored. Defaulting might be necessary if you have to make temporary changes, communications between the scanner and another device are lost or interrupted, or you are using incompatible equipment (for example, a terminal that is set at 9600 baud communicating with a scanner that is set at 38.4K baud).

Restore User-Saved Settings to Active Memory

- Restores user-defined settings to active memory.
- Initializes serial configuration commands in active memory and resets counters to zero.

Restore User-Saved Settings to Active Memory by Serial Command

Send **<An>** command to the scanner.

Note: There is no equivalent **ESP** command.

Restore Microscan Defaults to Active Memory

- Restores Microscan defaults to active memory.
- Initializes serial configuration commands in active memory and resets counters to zero.
- Does not save settings for power-on.

Restore Microscan Defaults to Active Memory by Serial Command

Send **<Ard>** command to the scanner.

Restore Microscan Defaults to Active Memory by ESP

Right-click in the configuration window and select **Default All ESP Settings**.

1. See your Microscan sales representative to access the latest application code.

Restore Microscan Defaults to Active Memory and Power-On

Caution: Defaulting the scanner to Microscan default settings will overwrite user-saved settings.

- Restores Microscan defaults to memory.
- Restores Microscan defaults to user-saved settings for power-on.
- Initializes serial configuration commands in active memory and resets counters to zero.

Restore Microscan Defaults to Active Memory and Power-On

Send **<Zd>** command to the scanner.

Restore Microscan Defaults to Active Memory and Power-On by ESP

1. **Right-click** in the configuration window and select **Default All ESP Settings**.
2. **Right-click** and select **Save to Reader** and **Send and Save**.

Restore Microscan Defaults by Hardware Default

There is no hardware default for the MS-890. Default commands can be entered from any of the host connectors. Since the default communications settings on the 9-pin connector are fixed, you can always send a default the scanner through this port with a software command.

Saving

Power-On settings are those that are saved by a **<Z>** command and are loaded into active memory whenever power to the scanner is recycled.

Save Active Settings (Except Factory) for Power-On

Initializes serial configuration commands into active memory and resets counters to zero. Saves all current settings except factory settings to user-saved settings for power-on.

Save Active Settings (Except Factory) for Power-On by Serial Command

Send **<Z>** command to the scanner.

Save Active Settings (Except Factory) for Power-On by ESP

Right-click in the configuration window and select **Save to Reader**, then **Send and Save**.

Initializing

Initializing occurs whenever any command or set of commands is implemented.

Initializing is a part of all save and default functions. It is also used as a follow-on to implement serial configuration commands.

- Initializes serial configuration commands into active memory and resets counters to zero.
- Does not save settings for power-on.

Initializing by Serial Command

Send **<A>** after a serial configuration command or a string of serial configuration commands. For example: **<K141,1><A>**.

Initializing by ESP

Right-click in the configuration window and select **Save to Reader, Send No Save**. This will initialize all serial configuration changes that have been made in the current **ESP** session.

Note: Allow a **1.5** second delay after sending the **<A>** command before resuming communications.

Loss of Communications

Making changes to communications with the host such as **Baud Rate, Parity, Stop Bits, LRC**, etc. without corresponding changes in linked device(s) can result in the loss of menu access through the 25-pin port and wiring box connections. If this should occur, connect the scanner to the 9-pin port and set your host communications settings as follows: **57.6K** baud, **8** Data Bits, **1** Stop Bits, and **None** Parity. These settings for this port are fixed and cannot be changed. you should restore the scanner's defaults. If you wish to return to the 25-pin host port, you'll first need to change the scanner's communications settings by sending: **<K100,4,1,0,0><Z>**.

Appendix G — Position Scanner and Symbol

In positioning the scanner in relation to the symbols being scanner, consider the following:

- Position the scanner in a place devoid of sunlight, bright lights, or laser light from other sources.
- Avoid excessive tilt, skew, or pitch. Maximum tilt is determined by symbol characteristics and the number of decodes required. Maximum skew is $\pm 40^\circ$; maximum pitch is $\pm 50^\circ$.¹
- Pitch symbol (or scanner) slightly to avoid specular reflection, the return of direct, non-diffused light. Specular reflection is avoided by pitching symbols at least 5° plus or minus from a line perpendicular to the default position of the **Raster Bottom** and **Raster Top**.²

Note: Another way to avoid specular reflection is to skew the scanner slightly in relation to the symbol.

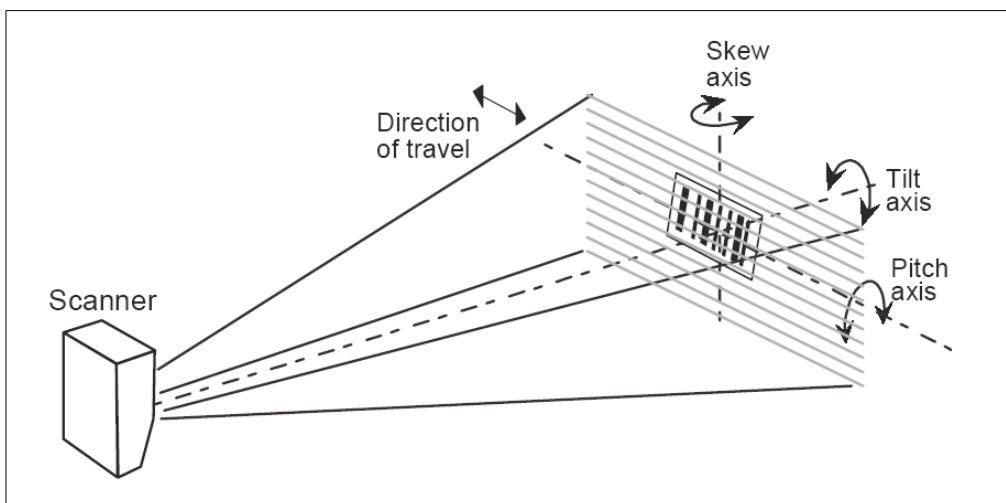

Scanner Position

1. Maximum tilt is determined by symbol characteristics and number of decodes required.
2. The specular reflection zone is a narrow zone straight out from the scanner in which direct reflected light from a symbol can distort the scanner's ability to distinguish bars from spaces.

Appendix H — Object Detector

In a typical operation, a scanner will wait for symbol data only during a triggered read cycle. A read cycle is initiated by a “trigger” and can be in the form of a serial command from the host (internal trigger) or a signal from an object detector (external trigger).

When an object detector (also called a sensor, package detector, etc.) is used, it is set up so that its beam will bounce off the approaching object and the resulting pulse will be sent to the scanner to begin the read cycle. Typically, a detector is positioned so that it will detect the presence of an object before its symbol can be scanned.

An object detector is mounted in almost any position relative to the object as long as:

- (1) the object passes within range of the detector and
- (2) direct or reflected light from the detector does not interfere with the scanner's reception.

As the item continues to move down the line, its symbol moves into the scanner beam and is read by the scanner.

The drawing below shows a symbol in the picket fence direction with the object detector positioned so as not to cause interference.

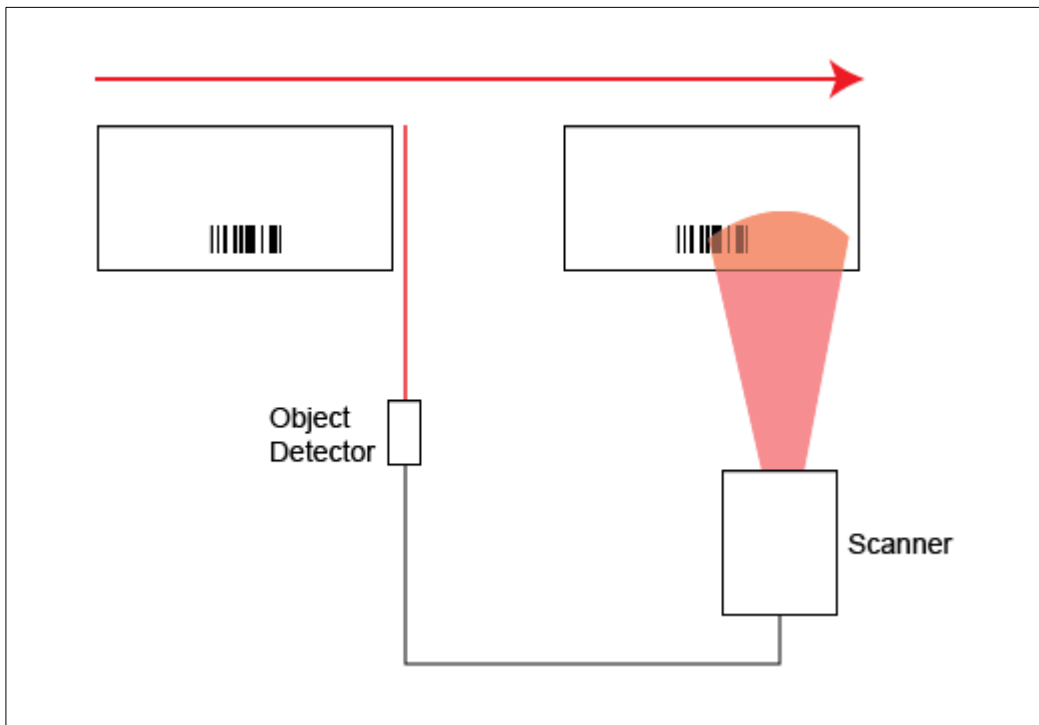

Object Detector Operation

Appendix I — Bar Code Configuration

You can configure the MS-890 by presenting **Code 128** symbols encoded with serial commands.

Note: Your scanner does not need to be enabled for Code 128 in order to enter Bar Code Configuration.

Entering Bar Code Configuration

The symbol used to enter configuration is the 7-character code 128 symbol shown below. It is not required that the scanner be configured to read code 128 symbols to read this start symbol or the following configuration symbols.

To set up Bar Code Configuration:

1. Put the scanner in a read cycle mode.
2. Place a special Code 128 configuration **Start** symbol (provided below) in the scanner's field of view.



If the scanner is able to read the **Start** symbol, it will begin to beep and the performance LEDs will activate.

3. When the scanner starts to beep, remove the configuration symbol from the scanner's field of view.

The scanner is now in Bar Code Configuration mode.

During Bar Code Configuration mode, the LEDs will illuminate in a sequential pattern to indicate that the scanner is ready to be configured.

You can create your own start symbol by encoding the following character sequence in a Code 128 symbol:

FNC4 <_CFG>

Using Configuration Symbols

Once in Bar Code Configuration mode, serial command data encoded in Code 128 symbols is decoded by the scanner as serial input.

Configuration symbols must meet the following conditions:

1. The only valid symbology for Bar Code Configuration is Code 128.
2. Symbol data may contain more than one command, but individual symbols must be presented individually. This is because only the first symbol in a read cycle will be used as a possible configuration symbol. A symbol that is presented to the scanner must be read 25 times consecutively to be used as a valid symbol.

Once this is done, the scanner will interpret the symbol data in the same fashion as it interprets serial data.

3. Any valid command may be encoded in Code 128 symbols, including operational commands.
Because the data is treated like serial input, multiple symbols may be used to represent one command as long as the symbols are presented individually and in the correct order.
4. Read Rate commands may also be used to enter Read Rate from Bar Code Configuration mode.
5. When in Read Rate, the scanner will read the symbologies that were enabled prior to entering Bar Code Configuration mode. However, the scanner *will* read a **<J>** in Code 128 regardless of the current enable/disable state of Code 128.

Once the **<J>** is issued, the scanner will exit both Read Rate and Bar Code Configuration mode. To exit Read Rate and remain in Bar Code Configuration mode, present the start symbol once again. Symbols decoded during Read Rate will not configure the scanner.

Scan the symbol shown to the right to start a Read Rate test.



Exiting Bar Code Configuration

There are multiple ways of exiting Bar Code Configuration.

The first way is simply to decode a symbol encoded with the **<J>** command, or to enter a **<J>** command from a terminal. The scanner will beep when exiting Bar Code Configuration in response to a **<J>** command.

Any command that executes a software reset will also end Bar Code Configuration mode. These commands include the **Save** family as well as the **Reset** family (**<Z>**, **<Zc>**, **<Zrd>**, **<Zrc>**, **<A>**, **<Arc>**, **<Ard>**).

To end the Read Rate test and Bar Code Configuration mode, scan this symbol:



Configuration changes will remain in effect, as would changes made by using serial commands or **ESP**.

Appendix J — Test Read Rate

Test Read Rate by Bar Code Configuration

You can enter a Read Rate test by scanning the following symbols:



<_CFG>

Enable Bar Code Configuration
(Also activates the scanner's read performance LEDs.)



<P>

Enable All Symbologies



<Cp>

Start Read Rate Test



<J>

End Read Rate Test and Disable Bar Code Configuration

Test Read Rate by Serial Command (Static Symbol)

1. Position a stationary symbol in front of a functioning scanner at the scan distance used in your application.
2. Set for single scan line scanning (**Raster Top** setting equal to **Raster Bottom**).
3. Enter a **<C>** command to see the decodes per second.
The decode rate is the number of decoded scans per total number of scan. It will appear at the beginning of the data strings.
Note: You can also enter a **<Cp>** command to see the percentage of decodes per scans.
4. Make a note of the decode rate. You will need this when calculating the number of decodes (see Appendix K, **Formulas for Number of Decodes** on page A-27).
5. End the test by sending the **<J>** command.

Test Read Rate by ESP

See [Read Rate](#) in Chapter 12, [Utilities](#).

Test Read Rate with a Moving Symbol

Before testing with a moving symbol, it is highly recommended that you calculate the expected number of decodes by using the formulas in Appendix K, [Formulas for Number of Decodes](#) on page A-27.

Once you've mounted the scanner, established a good read rate with a stationary symbol, and calculated the number of decodes for your symbol speed, you can begin decoding with moving symbols.

Number of Decodes

To ensure reliable scanning, you need to apply a minimum of five decodes to each symbol. This means that all variables, symbol speed, read range, etc. are significant.

Note: Variations between symbols are common. For this reason, the greater the number of sample symbols tested, the more likely you are to achieve optimum decode rates.

In general, the number of decodes of a given symbol can be increased by:

- Increasing symbol height
- Decreasing symbol length
- Increasing scan rate (spinning mirror speed)
- Slowing symbol speed
- Decreasing raster sweep rate
- Decreasing raster height

Appendix K — Formulas for Number of Decodes

To ensure reliable scanning, apply a minimum of *five* decodes to each symbol. Use the formulas below to calculate the number of decodes that your symbol will receive.

If the number of decodes you derive from one of these calculations is less than the minimum for your application, plug in the minimum number of decodes (5) and solve for another parameter that might be changed, such as symbol speed or scans per second.

Note: While the formulas given here solve for the predicted number of decodes, you may also use the formulas to solve for other parameters that might be changed, such as symbol speed, symbol length, etc.

Single Line Ladder Calculation

Ladder scanning is seldom done with raster scanning unless the raster is set for single scan line scanning (**Top Offset** setting equal to **Bottom Offset**) or symbols are presented as stop-and-go.

For single scan line ladder scanning, use the following formula:¹

$$ND = \left(\frac{SH}{SS} \cdot DR \right) - 3$$

ND (*Number of Decodes*) is the number of decodes that a given symbol can be expected to achieve in a given application.

SH (*Symbol Height*) is a measurement of the height of individual bars.

SS (*Symbol Speed*) is the distance per second that a symbol moves through the scan.

DR (*Decode Rate*) is the number of scans per second that a given symbol receives.

Example:

$SH = 0.5$, $SS = 10/\text{second}$, and $DR = 200$ decodes per second

$$ND = \left(\frac{0.5}{10} \cdot 200 \right) - 3 = 10 \text{ complete decodes}$$

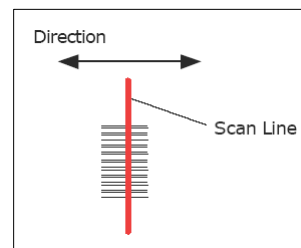

Single Line Ladder Orientation

1. The -3 component in the formula is included to allow for AGC acquisition, an incomplete first scan, and an incomplete last scan. This applies only if the number inside the parentheses equals 4 or more. If the number equals 3, then only subtract 2 to derive 1 good scan.

Raster Picket Fence Calculation

For raster picket fence scanning, the number of decodes (ND) that can be applied to a given symbol can be calculated once the sweep rate (SPS) is known.

Sweep Rate (Sweeps per Second)

Sweep rate is the number of raster sweeps (up or down) that occur per second and can be set in **ESP**. Since the sweep rate cannot exceed 30, you first need to ensure that your application can achieve this by solving for sweep rate (SPS). The sweep rate should generally be set as low as possible in order to maximize the number of scans on a given symbol.

The formula for finding **Sweep Rate** (SPS) is as follows:

$$SPS = \frac{2 \cdot SS}{(SW - SL)}$$

SPS = Sweeps per Second, the number of passes, up or down, that are described by the arc of the raster mirror.

SS = Symbol Speed, the inches per second that a symbol moves through the scan.

SW = Scan Width, the width across the scan beam, at a given distance from the scanner, in which a symbol can be read (picket fence formula only).

SL = Symbol Length, the length of the longest printed symbol to be read plus the length of the quiet zones (picket fence formula only).

Example:

$$SW = 5$$

$$SS = 2 \text{ per second}$$

$$SL = 1$$

$$SPS = \frac{2 \cdot 2}{(5 - 1)} = 1$$

Important: The maximum sweep rate that you can set the scanner to is 30. If your solution is greater than 30, you must change another parameter such as symbol speed, etc., and recalculate.

Since SPS can only be entered into the software as whole numbers, round off fractions of SPS to the next higher number, for example enter 0.4 as 1 and 3.5 as 4.

In setting up the scanner, raster height depends on the raster arc and the symbol distance (range) from the scanner. Both the top offset and bottom offsets can be adjusted independently in 255 increments and the resulting arc can vary from 0° to 30°. (See Chapter 10, [Raster/Laser](#).)

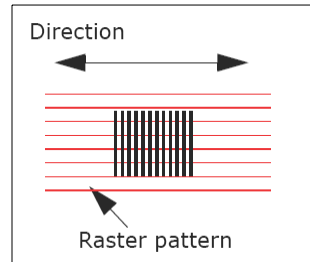

Raster Picket Fence Orientation

Number of Decodes

Note: Because adjustable raster sweeps and scan speeds cannot be synchronized, some variation in raster height should be anticipated.

Number of decodes (ND) for a raster picket fence symbol is calculated by the following formula:

$$ND = \left(\frac{SH \cdot DR}{RH \cdot SPS} \right) - 3$$

ND = Number of Decodes (total applied to each symbol)
SH = Symbol Height
DR = Decode Rate
RH = Raster Height
SPS = Sweeps per Second

Example:

$$SH = 1, DR = 100, RH = 10, SPS = 1$$

$$ND = \left(\frac{1 \cdot 900}{10 \cdot 1} \right) - 3 = 87 \text{ decodes}$$

Raster Height

If raster arc (in degrees) and symbol range are known, raster height can be derived by the following formula, where \emptyset is raster arc in degrees:¹

$$RH = (2 \cdot \text{Symbol Range}) \tan\left(\frac{\emptyset}{2}\right)$$

Raster Arc

If raster height and symbol range are known, then raster arc \emptyset can be derived by using the following formula where RH is raster height:

$$\emptyset = 2 \cdot \text{atan}\left(\frac{RH}{2 \cdot \text{Symbol Range}}\right)$$

Note: Raster arc is not presented in degrees in **ESP**. To convert to degrees, add the **Top Offset** to the **Bottom Offset** and subtract the sum from 255. Enter this as the offset in the following formula:

$$\text{Degrees} = \frac{\text{Offset} \cdot 30}{255}$$

Single Line Picket Fence Calculation

For single scan line picket fence scanning (Top Offset setting equal to Bottom Offset), use the following formula:

$$ND = \left(\frac{(SW - SL)}{SS} \cdot DR \right) - 3$$

ND = Number of Decodes (total applied to each symbol)

SW = Scan Width

SL = Symbol Length

SS = Symbol Speed

DR = Decode Rate

Example:

SL = 2 inches (including quiet zones)

SS = 100 inches per second

SW = 4 inches

DR = 1000 decodes per second

$$\left(\frac{(4 - 2)}{100} \cdot 1000 \right) - 3 = 17 \text{ complete decodes}$$

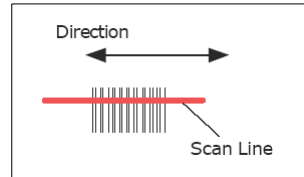

Single Line Picket Fence Orientation

Angled Picket Fence Calculation

The number of complete scans for angled picket fence is calculated the same as that for picket fence, with the exception that the scan width is shortened in proportion to scan tilt.



Angled Picket Fence Orientation

Improving Decode Rate

After changing any of the parameters described in this section, recalculate the number of decodes.

Scan Rate

Scan rate is a function of motor speed and is adjustable. A slower scan rate may allow greater symbol range and/or higher decode rates, but at the cost of fewer scans per symbol and scan width.

Range

Adjusting the symbol's range, if possible, is one of the quickest and most effective ways to improve decode rates. However, in some applications you may need to select a less than optimum range, or one that is beyond the fringes of the ranges.

Scan Width

Increasing scan width will increase the number of scans in a picket fence oriented application. Scan width is linked with scan range and changing one will usually require a change in the other.

Symbol Speed

Applies to both picket fence and ladder oriented symbols. If your application allows it, slowing symbol speed (the time in seconds that a symbol is fully within the scan width of the scanner) is an effective way to increase the number of decodes.

Raster Height

When using the raster features, you can increase the decode rate by decreasing the height of the raster image.

Raster Sweep Rate

Slowing the number of sweeps per second to the minimum needed will result in more scan lines passing over the symbol and a higher decode rate.

Laser Framing

Narrowing the laser frame may not increase the decode rate, but it will minimize the opportunity of extraneous reads.

Symbol Dimensions, Symbol Density, and Symbol Ratio

Not usually an option in most applications, but changes to symbol parameters can affect number of decodes calculations and possibly decode rates.

If your application allows it, shortening the length of a picket fence symbol means the symbol will be in the scan range longer and hence receive a greater number of scans. Increasing the height of a ladder symbol means it will receive more scans. Changing symbol density and/or symbol ratio is another way ranges, decode rates, etc. can be altered.

Gain and Tracking

These adjustments, typically made by qualified technicians, are referenced in the Scanner Setup menu (see [Defaulting/Saving/Initializing](#) on page A-18). Changes to tracking will generally have a limited affect on decode rates.

Appendix L — Operational Tips

Do:

- Check inputs (symbol speed, length, height, etc.) to ensure the desired number of decodes per symbol.
- For optimum decodes, mount scanner so that your symbols pass through the center of the depth-of-field (minimum/maximum range). You find the center by moving your symbol in and out during a read rate test.
- Avoid excessive tilt, pitch, and skew of the symbol.
- Check the symbol for readability by doing a decode rate test. If there is any question about the symbol's readability, contact your Microscan sales representative.
- After changing any parameter that might affect decode rate, repeat decode rate test.
- Clean the scanner window with a clean, dry cotton swab or cotton cloth on a regular basis.

Do Not:

- Aim the scanner into direct light or sunlight.
- Aim the scanner into an external object detector or other light-emitting device.
- Obstruct the scanner window with mounting hardware or other objects.
- Connect chassis of scanner and host to different ground potentials.
- Operate the scanner in excessive temperature environments.

Appendix M — Interface Standards

Interface Standards, established by the Electronic Industries Association (EIA), specify such things as the signaling voltage levels, maximum cable lengths, and number of drivers. With Microscan devices, selection of interface is made by pin assignment and, in the case of the host communications, by software switching between RS-232 and RS-422. Microscan devices use RS-232, RS-422, and RS-485 multidrop.

RS-232

RS-232 defines an interface between two devices such as, for example, the scanner and host. It differs from the other interfaces by dedicating individual pins to specific functions and by requiring both devices to share a common ground line. Since both device chassis are connected to a common ground, a ground loop potential and the possibility of noise interference exists. Therefore cable lengths are limited to a maximum of 50 feet (19.7m). Despite being the most limited, this interface is used frequently because of the large installed base of RS-232 equipment.

RS-422

RS-422, unlike RS-232, measures signals differentially; that is, the receiver looks at the potentials between the two receive (or transmit) wires rather than the potential between signal and ground. As a result, cables, if shielded, can be up to 4000 feet (1219m) in length. Like RS-232, RS-422 communication is designed for only two devices on a single line and must have a common ground. It can be used wherever RS-232 is used.

RS-485

RS-485, like RS-422, can transmit up to 4000 feet (1219 m) using differential voltages but unlike RS-422, its transmitters are turned off until a request for data is received from the host. RS-485 is used exclusively in Multidrop protocol.

Appendix N — Multidrop Communications

This appendix describes the rules for setting up a concentrator or controller to communicate with a scanner in standard Multidrop protocol.

The diagram to the right shows a typical Multidrop network in which 1 to 50 scanners can communicate with a host via an intermediary device, a concentrator, or a controller.

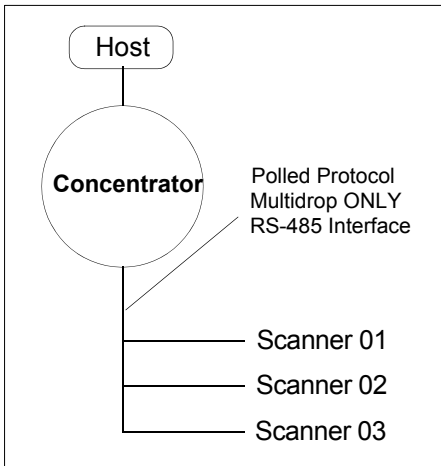

Multidrop

Configure Scanner for Multidrop

1. With the scanner connected to the host, **Retrieve Reader Settings**.
2. Select **Multidrop** in the **Protocol** configuration menu.
You will see the following message:
Important: You must change your preamble and postamble characters so that they are not CR or NUL.
This allows data to move through the concentrator without interference.
3. Click **OK**.
4. Next, go to **Preamble Characters** (still in the **Protocol** menu) and double-click on **Characters**.
5. This will open up an ASCII character table. Select any character but **CR**.
6. Repeat the above process for **Postamble**.
7. Check the multidrop address. Enter a number from **01** to **50**.
8. Right-click in the window and select **Save to Reader** and **Send and Save**.
9. Your scanner is now in Multidrop. From here on, you will need to use the concentrator to relay commands and data between the scanner or scanners and the host.
10. Move on to **Connect to Scanner via Concentrator**.

Connect to Scanner via Concentrator

You will need a multidrop concentrator and the required power supplies and cabling to communicate with your scanner(s).

1. From the **Communications** dropdown menu in the menu toolbar, select **Configure Multidrop**. The **Multidrop Settings** dialog will appear.

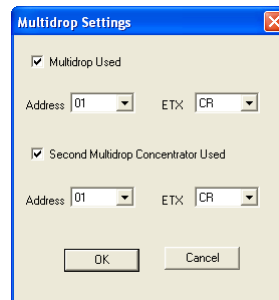

2. If necessary, change the default address to match the address of your multidropped scanner and click **OK**.

If the host serial port is not connected in **ESP**, you will see the following popup message:

“**ESP** is not currently connected to the multidrop concentrator. Do you wish to establish a connection now?”

3. Click **Yes**.
4. The **Connection Settings** dialog will appear. Notice that the **Force Connect** option is checked. Do not change this.

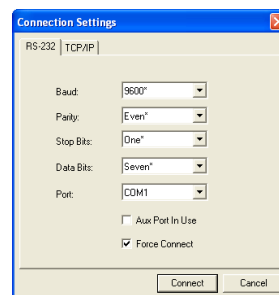

5. Select the concentrator’s host port communications settings.

When you click **Connect**, you will be connecting to your concentrator, which can then relay commands to the scanner whose address was set in the **Multidrop Settings** dialog.

6. Click **Connect**.

You should see the **CONNECTED** message in green at the bottom of the window along with the scanner’s Multidrop address.

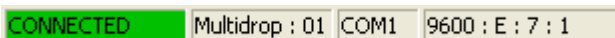

7. Click **Retrieve Reader Settings** to upload the scanner’s configuration. If upload fails, return to the **Connection Settings** dialog and make the necessary parameter changes.
8. Follow the same procedure for connecting other scanners to your multidrop network.

Polling Sequence

Data that is transmitted to the host (symbol data, No Read messages, counters, etc.) via concentrators is solicited by poll requests from the host.

The polling sequence example by poll address 1E (ASCII hex value for Scanner 02) and a REQ (request). The scanner responds by first transmitting its own address, 1E, followed by a STX (start of text) character, and then the data. Next it transmits an ETX (end of text) character and an LRC (longitudinal redundancy check) character.

If the concentrator (or controller) receives the data from the scanner and is able to validate it with an LRC calculation, it responds with an ACK (acknowledgment). If the scanner in turn receives the ACK, the scanner ends this successful exchange with a RES (reset).

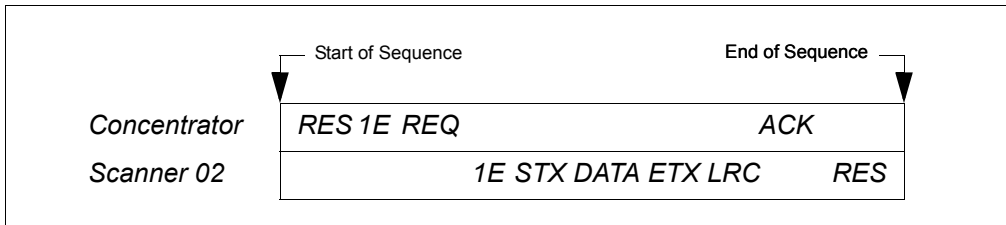

Polling Sequence

Polling Reset

- If the scanner has no information, it responds to a poll request by transmitting a RES (reset).
- If the scanner receives a NAK instead of the ACK after transmitting its data string, it will re-attempt to send the data string up to three times. If the scanner still does not receive an ACK, it will send a RES (reset) and discard the data in its buffers.
- If the scanner transmits data to the concentrator and the concentrator responds with an ACK or NAK, but the scanner doesn't receive the concentrator's response, the scanner will timeout and send a REQ to the concentrator and request another response. If after three retries (the number of times it transmits a REQ to the concentrator) the scanner receives no response, it ends the transmission with a RES (reset).

Select Sequence

Unlike poll requests, select commands always originate from the host and consist of serial configuration or operation commands to devices that are configured in Multidrop. The scanner complies with the command when it is polled during the cycle.

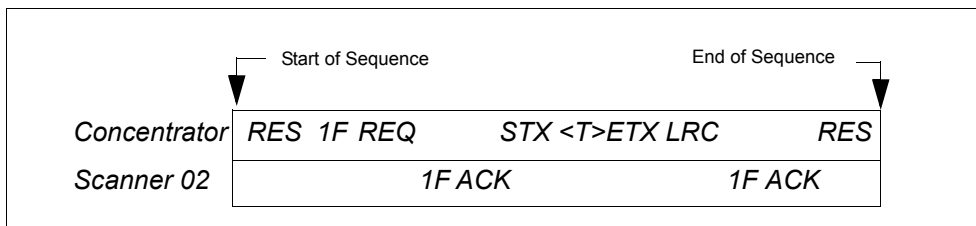

Polling Sequence

A RES (reset) is the first command in the select sequence. The 1F hex is the select address associated with Scanner 02 address. It is followed by a REQ (request). The scanner responds with its own select address, 1F hex, and an ACK (acknowledge). The concentrator then transmits an STX (start of text), the data (in this case a <T>), an ETX (end of text), and an LRC character.

The scanner replies by transmitting its own address, followed by an ACK, acknowledging receipt of the command. Upon receipt of an ACK, the concentrator concludes the successful exchange with a RES.

In the example above, the scanner only acknowledges a trigger counter request from the concentrator. It does not respond to the trigger counter request until a subsequent poll. For example, if the scanner's trigger count was 12 at the time the trigger counter request was received, on a subsequent poll it would send 02T/00012. (The 02 at the beginning of the string is the scanner's address.)

Select Reset

If the scanner receives bad data from the concentrator, it transmits a SEL (its select address) and a NAK to the concentrator. The concentrator re-transmits the data up to three times. The concentrator will end the sequence with a RES (reset) if no ACK is received.

Multidrop Addresses

Multidrop Address	Poll Character		Select Character	
	ASCII	HEX	ASCII	HEX
01	^\ ^	1C	^] ^_	1D
02	^^	1E	^_	1F
03	SP	20	!	21
04	"	22	#	23
05	\$	24	%	25
06	&	26	'	27
07	(28)	29
08	*	2A	+	2B
09	,	2C	-	2D
10	.	2E	/	2F
11	0	30	1	31
12	2	32	3	33
13	4	34	5	35
14	6	36	7	37
15	8	38	9	39
16	:	3A	;	3B
17	<	3C	=	3D
18	>	3E	?	3F
19	@	40	A	41
20	B	42	C	43
21	D	44	E	45
22	F	46	G	47
23	H	48	I	49
24	J	4A	K	4B
25	L	4C	M	4D

Multidrop Address	Poll Character		Select Character	
	ASCII	HEX	ASCII	HEX
26	N	4E	O	4F
27	P	50	Q	51
28	R	52	S	53
29	T	54	U	55
30	V	56	W	57
31	X	58	Y	59
32	Z	5A	[5B
33	\	5C]	5D
34	^	5E	_	5F
35	`	60	a	61
36	b	62	c	63
37	d	64	e	65
38	f	66	g	67
39	h	68	i	69
40	j	6A	k	6B
41	l	6C	m	6D
42	n	6E	o	6F
43	p	70	q	71
44	r	72	s	73
45	t	74	u	75
46	v	76	w	77
47	x	78	y	79
48	z	7A	{	7B
49		7C	}	7D
50	~	7E	D	7F

Appendix O — Glossary of Terms

Active Closed — An optoisolated input-output that's logically "on" when current flows through the connection points.

Active Open — An optoisolated input-output that's logically "on" when no current flows through the connection points.

Analog Gain Adjustment (AGC) — Adjustment to signal strength that seeks to maintain a constant level regardless of the range of the symbol.

Application Record — A variation of EAN-128 which adds an application identifier to symbol data, including user-definable separators, brackets, and padding.

Autocalibration — A routine that cycles through various optical settings and selects the combination that produce the best read rate.

Autodiscrimination — The ability to decode several different symbologies without changing configuration.

Auto Range — Outward focus of the scanner until an object is sensed by signal strength. The scanner then begins searching for a decodable symbol.

Auxiliary Port — Auxiliary terminal connection for remote viewing and command inputs.

Bar Code — A symbol in which data has been encoded in an array of parallel bars and spaces of varying widths.

Baud Rate — The number of discrete signal events per second. Bits per second.

Channel — A high-speed pathway between the computer and the control units of the peripheral devices.

Check Digit — A Modulus 43 or Modulus 10 digit that is added to the symbol data for additional data integrity.

Command Processing — Allows the user to enter **ESP** from the Aux Port or send serial string commands from the Aux Port.

Configuration — A setup or process of changing a scanner's settings to conform to a specific application.

Concentrator — Intermediary device that relays data from scanners to a host and commands from the host to the scanner or other devices.

Connector — Physical device (plug or socket) on a device or cable to provide in/out connectivity for various circuits and pins.

Counter — Memory space provided to keep track of scanner events.

Daisy Chain — Linkage of scanners to allow data to be relayed up to the host via Aux Port connections.

Decode — A Good Read. The successful scanning and decoding of the information encoded in a symbol.

Default — Restores ROM settings and resets the scanner.

Delimited — A command or field that is bracketed by pre-defined characters.

Decode Rate — The number of good reads per second decoded by the scanner.

Glossary of Terms

Depth of Field — The distance between the minimum and maximum range in which a scanner can read symbol.

Discrete I/O — Inputs and outputs characterized by discrete signal transitions.

EPROM — Erasable, programmable, read-only memory.

Embedded Memory — Onboard memory device such as EPROM or flash.

End of Read Cycle — The time or condition at which the scanner stops expecting symbol data to decode.

External Edge — Allows a read cycle to be initiated by a trigger signal from an object detector when it detects the appearance of an object (rising edge). The read cycle ends with a good read, a timeout, or a new trigger.

External Level — Allows a read cycle to be initiated by a trigger signal from an object detector. The read cycle ends when the object moves out of the detector's range.

Fixed Symbol Length — Increases data integrity by ensuring that only one symbol length will be accepted.

Flash Memory — Memory that can be changed by downloading new code.

Focal Length — The distance measured from the scanner to the center of the depth of field, or *focal* point.

Focus — The point at which the tip of the scan beam is at its narrowest.

Full Duplex — Auxiliary port data is sent directly to the host but not displayed on the auxiliary port screen.

Gain — Optimal signal strength.

Good Read — A decode. The successful scanning and decoding of the information encoded in a symbol.

Half Duplex — Auxiliary port data is sent directly to the host and displayed on the auxiliary port screen.

Intercharacter Delay — The time interval in milliseconds between individual characters transmitted from the scanner to the host.

Intercharacter Gap — The extra space between the last element of one character and the first element of the adjacent character of a specific symbol.

Ladder Orientation — An orientation in which a symbol's bars are parallel to its direction of travel.

Large Intercharacter Gap — Allows the scanner to read symbols with gaps between characters that exceed three times (3x) the narrow element width.

Laser Framing — Setting scan width size by adjusting the on/off duration of the laser beam.

Laser On/Off — When enabled, the laser is ON only during the read cycle, provided the scanner is enabled for a Serial or External trigger.

LED — Light emitting diode.

Longitudinal Redundancy Check (LRC) — An error-checking routine that verifies the accuracy of transmissions.

Matchcode — The ability to compare symbols being scanned against a master symbol that is stored in the memory of the scanner.

Embedded Menu — Configuration options embedded in the scanner's erasable memory.

Mil — One thousandths of an inch or 0.0254 mm. In bar coding, a measurement standard that measures a symbol by the width of its narrowest element.

Mismatch — An event that occurs when the scanned symbol does not match the master symbol that is stored in the memory of the scanner.

Multisymbol — A scanner mode which allows a scanner to read more than one symbol in a single read cycle.

Multidrop — A communications protocol for networking two or more scanners or other devices with a concentrator (or controller) and characterized by the use of individual device addresses and the RS-485 standard.

Narrow Bar Width — The width of the narrowest bar of a given symbol, expressed in thousands of an inch (or mils).

Narrow Margins — Allows the scanner to read symbols with quiet zones less than 8 times the width of the narrow bar element.

Non-Delimited — A command that is not bracketed by pre-defined characters.

Non-Volatile RAM (NOVRAM) — Random Access Memory that is available on power on; that is, after power to the unit has been recycled.

No Read — A failed decode attempt. A condition that occurs when the scanner is set up to decode symbols but no symbol is scanned during the read cycle.

NOVRAM — Non-volatile random access memory. Data that is saved for "power on" is saved to NOVRAM.

Number of Decodes — The number of times a symbol is scanned by the scanner during one pass through the laser beam.

Object Detector — A photoelectric device used to sense the presence or absence of an object (also referred to as a package detector).

Output — To transfer or transmit from the computer to a peripheral device or communications line. A channel or communications line. Decoded data or discrete signal.

Output Format — The modification of data output according to a user-defined index of **Extraction** and **Insertion** commands.

Parity — An error detection routine in which one data bit in each character is set to **1** or **0** so that the total number of 1 bits in the data field is even or odd.

Picket Fence Orientation — An orientation in which a symbol's bars are perpendicular to its direction of travel.

Pitch — Symbol (or scanner) rotation around the center of a line perpendicular to the symbol's bars.

Point-to-Point — A protocol consisting of a single communications event, typically used to connect a scanner to a terminal or host computer.

Port — Logical circuit for data entry and exit. (One or more ports may be included within a single connector.)

Protocol — The rules for communication between devices, providing a means to control the orderly flow of information between linked devices.

Quiet Zone — Specified “clear” (nonprinted) area immediately before and after the symbol. The area is usually white (for black and white symbols) and at least 10 times the width of the narrowest bar, as measured in thousands of an inch. The quiet zone can be a shade or color other than white as long as its density remains consistent and it has the required contrast relative to the bars.

RAM (Random Access Memory) — Memory that is lost after power is recycled to the unit.

Raster — Multiple stacked scans produced by a separate oscillating mirror or by a spinning mirror with varying facet angles.

Read Cycle — A programmed period of time or condition during which the scanner will accept symbol input.

Read Range — The distance within which a symbol can be read reliably, as measured from the front of the scanner.

Relay — An electrical switch that allows a low power to control a higher one.

Reset — Clears current data and initializes counters and configuration parameters.

ROM (Read-Only Memory) — Memory that cannot be changed.

Scanner — A scanning device that is comprised of a scan head and a decoder integrated in one package.

Scan Rate (SR) — The number of decodes per second that a given scanner is capable of casting.

Scan Width (SW) — The width across the scan beam at a given distance from the scanner in which a symbol can be read.

Separator — A character that separates data fields.

Serial Commands — Online data strings such as <D> or <P> sent from a host or auxiliary terminal to a scanner or other device.

Serial Configuration (Host Configuration) — Serial command specifically for changing configuration and distinguished from operational command by the fact that they modify the non-volatile for power up configuration.

Skew — Symbol (or scanner) rotation around the center of the skew axis.

Specular Reflection Zone — The narrow zone straight out from the scanner in which direct reflected light from a symbol can distort the scanner’s ability to distinguish bars from spaces.

Supplemental — A character or data string that is appended to the main symbol.

Sweep — One pass of the raster, up or down.

Sweep Rate (SwR) — The number of passes per second, up or down, describing the raster image.

Symbol Density — The number of characters per inch (or other unit of measure) encoded in a symbol.

Symbol Height — Regardless of orientation, the measurement taken along the length of a symbol’s individual bars.

Symbol Length — Regardless of orientation, the measurement taken across the symbol's bars from one end to the other, including the quiet zone.

Symbology — A set of symbols, such as Code 39 or Code 128, that have special rules to define the widths and positions of bars and spaces to represent specific numeric or alphanumeric information.

Symbology ID — An AIM standard prefix character that identifies the symbol type.

Symbol Speed — The distance per second that a symbol moves as it travels through the scan lines.

Symbol Transitions — The transition of bars and spaces on a symbol, used to detect the presence of a symbol on an object.

Tilt — Symbol (or scanner) rotation around the center line of the scan beam.

Timeout — A user-selected period of time that ends a scanner's read cycle.

Tracking — Adjustment of the precision of analog-to-digital conversion.

Transparent — Data is passed between the auxiliary port and the host with keyed data echoed to the auxiliary port

Trigger — A signal, transition, or character string that initiates a read cycle.

TTY — Abbreviation for **Teletypewriter**. This is a device that sends information character by character over an analog line.

Watchdog Timer — A security device that detects system crashes and attempts to reset the scanner.

Watchdog Reset — A reset that is forced whenever the software locks up.

Wildcard — User-defined character entered into a master symbol to permit matches with variable characters.

