

MICROSCAN.

PRODUCT PRICING CATALOG

Corporate Headquarters, USA
Omron Microscan Systems, Inc.
700 SW 39th St.
Renton, WA 98057
Tel 425.226.5700
Fax 425.226.8250

CONFIDENTIAL

www.microscan.com

Rev AV January 2018

MICROSCAN

Contents	Page #
Field Sales Contacts	3
Customer Service Contacts	4
Technical Support and Service Contacts	4
Standard Terms and Conditions	5
RMA Process	9
Professional Services: Extended Warranty; Services; Support	10
Auto ID Readers	12
MS-3 Series Scanners	12
QX-830 Compact Barcode Reader	20
QX-870 Industrial Barcode Reader	25
Auto ID 2D Readers	28
MicroHAWK ID Barcode Reader	28
MS-2D Scan Engine	37
MINI Hawk Series Imagers	38
Barcode Verification	42
Verification Kits	42
LVS-95XX	43
PanelScan	44
Auto ID Handhelds	45
HS-21 Handheld 2D Reader	45
HS-41X Handheld 2D DPM Reader	45
HS-51 Handheld 2D Reader	47
HS-51X Wireless Handheld 2D Reader	47
HS-360X DPM Handheld Reader	48
Auto ID Software, Connectivity, and Accessories	49
MS-Connect Series	49
Auto ID Product Accessories	52
Machine Vision Systems	54
MicroHAWK MV Smart Camera	54
HAWK MV-4000 Industrial Smart Camera	63
Vision MINI Smart Camera	67
Vision HAWK Industrial Smart Camera	70
I-PAK VH	70
Visionscape GigE Solution	73
Machine Vision Accessories	74
NERLITE® Machine Vision Lighting	75
Pharmalite	75
Smart DOAL	76
Smart Ring	78
MAX Lights	80
Area Arrays	82
Edge-to-Edge Backlights	83
Large Backlights	83
Dark Field Lights	85
Product Demo Kits	86
Legacy Products	87

MICROSCAN

Field Sales Contacts

Region	Sales Managers	Address	Phone	Email
Vice President Sales, Americas and Asia Pacific	John Agapakis	486 Amherst St. Nashua, NH 03063	Tel: +603.821.4319 +508.314.4143 (M)	jaagapakis@microscan.com
Western U.S.A.	Bob Taplett	Microscan 700 SW 39th Street Renton, WA 98057	Tel: +1.206.617.9603 (M)	btaplett@microscan.com
Midwest U.S.A.	David Thornton	Oswego, IL U.S.A	Tel: +1.331.254.2062 (M)	dthornton@microscan.com
South Central U.S.A.	Jamey Waldrop	Murphy, TX, U.S.A.	Tel: +1.469.507.9916 (M)	jwaldrop@microscan.com
Northeastern U.S.A. / Ontario, Canada	Ted Rudel	Sparta, NJ, U.S.A.	Tel: +1.973.289.0870 (M)	trudel@microscan.com
Southeastern U.S.A.	Pat Hoskins	Georgia U.S.A.	Tel: +1.404.606.2799 (M)	phoskins@microscan.com
South and Central America, Caribbean	Yamil Arias	Hialeah, FL U.S.A.	Tel: +1.786.779.5544 (M)	varias@microscan.com
Central Mexico	Chris Moya	San Luis Potosi, Mexico	Tel: +52.1.444.828.4848	cmoya@microscan.com
Mexico Border	Victor Martinez	Ciudad Juarez Chihuahua, Mexico	Tel: +52.1.81.1577.8293 (M)	vmartinez@microscan.com
OEM Sales Manager (East)	Kyle O'Brien	486 Amherst Street Nashua, NH 03063	Tel: +1.617.763.5606	kobrien@microscan.com
OEM Sales Manager (West)	Jason Mack	Cypress, CA U.S.A.	Tel: +1.425.757.1357 (M)	jmack@microscan.com
Key Account Manager, LVS products (East)	Teri DeMarco	Fayetteville, GA, U.S.A	Tel: +1.678.850.7811(M)	tdemarco@microscan.com
Key Account Manager, LVS products (Midwest)	John Bauer	Pinckney, MI, U.S.A.	Tel: +1.734.395.4939 (M)	jbauer@microscan.com
Business Development, Americas	Brandon Lew	Microscan 700 SW 39th Street Renton, WA 98057	Tel: +1.425.203.4968	blew@microscan.com
Business Development, LVS	Carol Saniatan	Peachtree City, GA, U.S.A	Tel: +1.404.782.1217	csaniatan@microscan.com
Director, Europe Middle East & Africa and Russia	Bart Nollet	Lemelerberg 17 NL-2402 ZN Alphen aan den Rijn, The Netherlands	Tel: +31.172.4233.60	bnollet@microscan.com
S. Germany, Austria, Switzerland, Liechtenstein	Mirko Karsch	Lemelerberg 17 NL-2402 ZN Alphen aan den Rijn, The Netherlands	Tel: +49.160.8948618 (M)	mkarsch@microscan.com
N. Germany, Eastern Europe, Baltic Countries, Georgia, Slovenia, Croatia, Azerbaijan	Gerhard Muller	Bochum, Germany	Tel: +49.172.23.72.637 (M)	gmuller@microscan.com
Italy, Greece, Spain, Israel, Portugal	Ursala Grotenhuis-Hurtado	Lemelerberg 17 NL-2402 ZN Alphen aan den Rijn, The Netherlands	Tel: +31.172.4233.72	ugrotenhuis@microscan.com
Sweden, Finland, Luxembourg, Belgium, Iceland, The Netherlands, Norway, Denmark, and OEM Sales Manager	Michael de Kegel	Aalst, Belgium	Tel: +32.474.3110.56 (M)	mdekegel@microscan.com
France	Nicolas Rozencwajg	Lemelerberg 17 NL-2402 ZN Alphen aan den Rijn, The Netherlands	Tel: +34.637.80.7979 (M)	NRozencwajg@microscan.com
United Kingdom, England, Scotland, Wales, Ireland, South Africa	Michael Harkin	Letterkenny, Co Donegal, Republic of Ireland	Tel: +353.83.171.4198 (M)	mharkin@microscan.com
Middle East, Morocco, Turkey, Africa (not south)	Ursala Grotenhuis-Hurtado	Lemelerberg 17 NL-2402 ZN Alphen aan den Rijn, The Netherlands	Tel: +31.172.4233.72	ugrotenhuis@microscan.com
EU Private Label Companies	Nico Hooiveld	Lemelerberg 17 NL-2402 ZN Alphen aan den Rijn, The Netherlands	Tel: +31.6.2220.9135 (M)	nhooiveld@microscan.com
Key Account Manager, LVS Europe	Koenraad Vermeiren	Brasschaat, Belgium		kvermeiren@microscan.com
Vice President Sales, Americas and Asia Pacific / Australia, New Zealand, Fiji, Guam, Taiwan	John Agapakis	486 Amherst St. Nashua, NH 03063	Tel: +603.821.4319 +508.314.4143 (M)	jaagapakis@microscan.com
Singapore, Indonesia, Philippines, Vietnam, Thailand, Malaysia, SEA Countries	Janel Kang	Singapore	Tel: +65.9880.8980	jkang@microscan.com
Korea	Moon Soo Kim	Korea	Tel: +82.31.786.0835 +82.10.3784.6437 (M)	mkim@microscan.com
Japan	Moon Soo Kim	Korea	Tel: +82.31.786.0835 +82.10.3784.6437 (M)	mkim@microscan.com
India, Pakistan, Nepal, Sri Lanka, Bangladesh, Bhutan	Vinay Bhasin	India	Tel: +91.981.1412271 (M)	vbhasin@microscan.com

MICROSCAN

Director, Greater China	Richard Cheng	Beijing, China	Tel: +86.186.0006.2619 (M)	rcheng@microscan.com
China-East (Shanghai, Zhejiang ,Hubei)	Bruce He	Shanghai, China	Tel: +86.189.3067.9073(M)	bhe@microscan.com
China – East (Jiangsu, Anhui, Henan)	Jeffrey Luan	Shanghai, China	Tel: +86.186.2190.0703(M)	Jluan@microscan.com
China-South (Guangdong, Guangxi, Hainan, Hong kong)	Johnny Deng	Shenzhen China	Tel: +86.186.6621.9571(M)	Jdeng@microscan.com
China-Southwest (Sichuan, Chongqing, Yunnan, Guizhou)	Jeremy Fan	Chengdu, China	Tel: +86.186.0289.3661(M)	Jfan@microscan.com
China-Southeast (Fujian, Jiangxi, Hunan)	Jack Wu	Shenzhen China	Tel: +86.180.3801.0701(M)	Jwu@microscan.com
China – North & Northeast (Beijing, Tianjin, Hebei, Shandong, Shaanxi, Shanxi, Inner Mongolia, Heilongjiang, Jilin, Liaoning)	Jeffrey Luan	Beijing, China	Tel: +86.186.2190.0703(M)	Jluan@microscan.com

Customer Service Contacts

Region	Inside Sales Managers	Address	Phone	Email
Sales Operations Manager - Americas, AP, EMEA	Matt Scrichfield	Microscan 700 SW 39th Street Renton, WA 98057	Tel: +1.425.226.5700 Press 1 Fax: +1.425.226.8250	AMERICAS_Orders@microscan.com
Americas	Wendy Cianfrocco Scott Rumage Robert Berry	Microscan 700 SW 39th Street Renton, WA 98057	Tel: +1.425.226.5700 Press 1 +1.800.251.7711 Press 1 Fax: +1.425.226.8250	AMERICAS_Orders@microscan.com
Asia Pacific	Ray Wang	Singapore	Tel: +65.6846.1214 Fax: +65.6846.4641	ASIA_Orders@microscan.com
China	Ray Wang Nikki Li	Shanghai, China	Tel: +86.21.6113.3752 Fax: +86.21.6113.3683	CHINA_orders@microscan.com
Europe, Russia, Middle East, Africa	Rudy Pijper	Lemelerberg 17 NL-2402 ZN Alphen aan den Rijn, The Netherlands	Tel: +31.172.4233.72 Fax: +31.172.4233.66	EMEA_Orders@microscan.com

Technical Support and Service Contacts

Support/Service	Contact	Address	Phone	Email
Distributor Business Development	Matt Scrichfield	Microscan 700 SW 39th Street Renton, WA 98057	Tel: +425.226.5700 Press 1 eFax: +1.425.988.7093	partners@microscan.com
Service Contracts, Component Orders (piece parts, returns, obtain RMA #)	Contact your regional Customer Service representative			
United States/ Canada/ Mexico/ Latin America Tech Support			Tel: +1.425.226.5700 Press 2 +1.800.251.7711 Press 2	americas_support@microscan.com
Asia Pacific Tech Support	General		Tel: +65.6846.1214	apac_support@microscan.com
Europe/ Russia/ Middle East/ Africa Tech Support	General		Tel: +31.172.4233.63	emea_support@microscan.com

Note: Only products which are currently active are shown in this product pricing catalog. Information regarding legacy and obsolete products is available by calling the sales/support contacts listed at the top of this page. Reference the end of the catalog for legacy product pricing. These products are not recommended for new applications.

MICROSCAN.

For the purposes of these TERMS AND CONDITIONS OF SALE ("Terms and Conditions"), "contract" means the agreement between Microscan Systems, Inc. ("Supplier") and Buyer arising as a result of Buyer's submission of an order for Supplier's products. Individually, Supplier and Buyer are each a party; collectively, they are parties. Such contract shall be deemed to incorporate and be governed by these Terms and Conditions. No term or condition of Buyer's order additional to or different from these Terms and Conditions shall become part of the contract unless explicitly agreed to in writing by Supplier. These Terms and Conditions may be revised by Supplier from time to time, in Supplier's sole discretion. Supplier will notify Buyer of revisions to these Terms and Conditions forty-five (45) days prior to the revised Terms and Conditions taking effect. Buyer's failure to object in writing to any provision contained in any communication from Supplier before the "effective date" shall be construed as acceptance of any such provision and shall not be construed as a waiver of these Terms and Conditions.

1. Quotations and Orders: Prices, specifications and dates for delivery referenced in Supplier's quotations are for information purposes only and shall not be binding on Supplier until all technical requirements have been agreed upon and Supplier has accepted Buyer's order. All orders must be bona fide commitments showing definite prices and quantities and mutually agreed shipping dates. Quotations terminate if the Buyer does not place an order with the Supplier within 60 days.

2. Taxes: Prices and fees do not include taxes, transport charges, insurance and export and/or import charges or duties including without limitation sales tax, value added tax, use or excise taxes, applicable to the Products sold and or Services supplied under any Contract, which taxes and other charges may, in the Supplier's discretion, be added by the Supplier to the sale price and or fees or billed separately and which taxes and other charges shall be paid by the Buyer unless the Buyer provides the Supplier with any necessary tax exemption certificate. Unless otherwise agreed in writing, the Buyer shall be liable to pay the Supplier's charges for transport, packaging, insurance and export and/or import clearance.

3. Shipment and Delivery: All products will be shipped EXW (Ex Works) Supplier's premises. Delays of convenience, within fourteen (14) days of the acknowledged shipping dates, will be invoiced at 50% of order value on originally scheduled ship date. Delays for convenience will not be accepted beyond sixty (60) days. Orders containing custom "FIS" products or integrated systems cannot be delayed or cancelled after receipt of Sales Order Acknowledgement. In the absence of specific instructions, Supplier will select the carrier and ship "collect". LVS 7000, 7100 and 7500 systems ship approximately 45 business days after receipt of order. Title and risk of loss or damage to any product shall pass from Supplier to Buyer upon the product being packed ready for delivery to carrier. Any claims for loss, damage or mis-delivery thereafter shall be filed with the carrier. All products shall be deemed finally inspected and accepted within ten (10) days after delivery unless notice of rejection is given by Buyer in writing to Supplier within such period. Acceptance shall constitute acknowledgement of full performance by Supplier of all obligations under the contract except as stated in Section 9 (Limitation of Warranties). The Supplier reserves the right to make delivery of Products by instalments and to tender a separate invoice in respect of each instalment. When delivery is to be by instalments or the Supplier exercises its right to deliver by instalments or if there is delay in the delivery of any one or more instalments for whatever reason the Buyer shall not be entitled to treat the Contract as a whole as repudiated. All products returned are subject to the then current Microscan Product Return Process Policy. Microscan reserves the right to change this policy at will.

4. Terms of Payment: Each shipment shall be a separate transaction and Buyer will be invoiced on date of dispatch. Unless otherwise stated on Supplier's invoice, terms of payment shall be net thirty (30) days from date of invoice. Orders of LVS 7000 systems \$20,000 and higher require 50/40/10 payment terms (50% deposit with placement of purchase order, 40% at time of shipment, and 10% at Net 30 days from date of invoice). Orders of LVS 7000 systems under \$20,000 may require deposit, based on customer credit limit.

All amounts due shall be paid in full by the Buyer without deduction, withholding, set-off or counterclaim for any reason whatsoever, whether arising in contract, tort (including negligence), breach of statutory duty or otherwise, save as may be required by law. Supplier may, in its sole discretion, determine at any time that the Buyer's financial condition requires full or partial payment in advance or the provision of security for payment by the Buyer in a form satisfactory to the Supplier. If the Buyer fails to make any payment when due then, without prejudice to any other rights and remedies available to the Supplier, the Supplier may at its option: (i) treat the Contract as repudiated by the Buyer, to suspend or cancel further delivery of Products and/or the provision of Services or any part thereof under that Contract or any other Contract between them and claim damages and/or receive reasonable cancellation fees; or (ii) affirm the Contract and recover, in addition to the payment, interest thereon at the lesser of 1-1/2% per month or the highest rate permitted by law along with reasonable attorney's fees and costs associated with recovering such outstanding payments.

5. Security Interest: Buyer hereby grants to Supplier a purchase money security interest in all Supplier products sold to Buyer as security for the punctual performance by Buyer of all of its

MICROSCAN.

obligations hereunder. Supplier may, at its discretion, file the Buyer's order and these terms and conditions as a financing statement to evidence and perfect said security interest.

6. Force Majeure: Notwithstanding anything to the contrary in these Conditions, the Supplier shall not be liable to the Buyer for any loss or damage which may be suffered by the Buyer as a direct or indirect result of the supply of Products or Services being prevented, delayed or rendered uneconomic by reason of circumstances or events beyond the Supplier's reasonable control. If due to such circumstances or events the Supplier has insufficient stocks to meet all its commitments the Supplier may apportion available stocks between its customers at its sole discretion.

7. Equipment: Supplier may modify specifications provided the modifications do not adversely affect the performance of the equipment to be supplied under the contract ("the equipment"). In addition, Supplier may furnish suitable substitutes for materials unobtainable because of priorities or regulations established by government authority, or non-availability of materials from suppliers. All descriptions, illustrations and any other information relating to the Products contained in the Supplier's catalogues, brochures, price lists, advertising material and any sales or other particulars or literature are made by way of general description, are approximate only and for the general guidance and information of the Buyer. They shall not constitute warranties or representations by the Supplier nor shall they form part of any Contract.

8. Software and Proprietary Information: Buyer acknowledges and agrees that all property, copyright and other intellectual property rights in any work or tangible deliverable item arising from or created, produced or developed by the Supplier under or in the course of provision of any Services (the "Works"), wherever in the world enforceable, including without limitations all right title and interest in and to the Services and all documents, data, drawings, specifications, articles, sketches, drawings, reports, inventions, improvements, modifications, discoveries, tools, scripts and other items relating thereto shall immediately upon creation or performance vest in and shall be and remain the sole and exclusive property of the Supplier and the Buyer shall acquire no right, title or interest in or to the same except as expressly stated in these Conditions. The Supplier grants to the Buyer a revocable, non-exclusive, non-transferable license to use such of the Works as are necessary, and to the extent necessary, for the Buyer to obtain and utilize the intended benefit of the Services. Each party undertakes to keep confidential, not use for its own purposes and not without the prior written consent of the other party disclose to any third party, any information of a confidential nature belonging or relating to the other party which may become known to it unless such information is or becomes public knowledge (other than by breach of this Section) or is required to be disclosed by order of a competent authority.

9. Limited Warranty; Remedies; Exclusions:

A. Supplier warrants that all equipment shall be free from defects in material and workmanship under normal use for a period of one year from date of shipment to Buyer save that Supplier does not warrant that operation of the software will be completely uninterrupted or error free or that all program errors will be corrected. Buyer shall be responsible for determining that the equipment is suitable for Buyer's use and that such use complies with any applicable local, state or federal law. Provided that Buyer notifies Supplier in writing of any claimed defect in the equipment immediately upon discovery and any such equipment is returned to the original shipping point, transportation charges prepaid, within one (1) year from date of shipment to Buyer and upon examination Supplier determines to its satisfaction that such equipment is defective in material or workmanship, i.e. contains a defect arising out of the manufacture of the equipment and not a defect caused by other circumstances, including, but not limited to accident, misuse, unforeseeable use, neglect, alteration, improper installation, improper adjustment, improper repair, or improper testing, Supplier shall at its option repair or replace the equipment, shipment to Buyer prepaid. Supplier shall have reasonable time to make such repair or to replace such equipment. Any repair or replacement of equipment shall not extend the period of warranty. This warranty is limited to a period of one (1) year, without regard to whether any claimed defects were discoverable or latent on the date of shipment.

B. If Buyer shall fail to pay when due any portion of the purchase price or any other payment required from Buyer to Supplier under this contract or otherwise, all warranties and remedies granted under this Section 9 may, at Supplier's option, be terminated.

C. THE FOREGOING WARRANTY IS EXCLUSIVE AND IN LIEU OF ALL OTHER REPRESENTATIONS, WARRANTIES AND COVENANTS, EXPRESS OR IMPLIED, WITH RESPECT TO THE EQUIPMENT AND ANY DEFECTS THEREIN OF ANY NATURE WHATSOEVER, INCLUDING WITHOUT LIMITATION WARRANTIES OF MERCHANTABILITY OR FITNESS FOR A PARTICULAR PURPOSE. SUPPLIER SHALL NOT BE LIABLE FOR, AND BUYER ASSUMES ALL RISK OF, ANY ADVICE OR FAILURE TO PROVIDE ADVICE BY SUPPLIER TO BUYER REGARDING THE EQUIPMENT OR BUYER'S USE OF THE SAME. UNDER NO CIRCUMSTANCES SHALL SUPPLIER BE LIABLE TO BUYER UNDER ANY TORT, NEGLIGENCE, STRICT LIABILITY, OR PRODUCT LIABILITY CLAIM AND BUYER AGREES TO WAIVE SUCH CLAIMS. SUPPLIER'S SOLE AND EXCLUSIVE LIABILITY, AND BUYER'S SOLE AND EXCLUSIVE REMEDY, FOR ANY NONCONFORMITY OR DEFECT IN THE PRODUCTS OR ANYTHING DONE IN CONNECTION WITH THIS CONTRACT, IN TORT (INCLUDING NEGLIGENCE), CONTRACT, OR OTHERWISE, SHALL BE AS SET FORTH IN SUBSECTION

MICROSCAN.

9A HEREOF AS LIMITED BY SUBSECTION 9B HEREOF. THIS EXCLUSIVE REMEDY SHALL NOT HAVE FAILED OF ITS ESSENTIAL PURPOSE (AS THAT TERM IS USED IN THE UNIFORM COMMERCIAL CODE) PROVIDED THAT THE SUPPLIER REMAINS WILLING TO REPAIR OR REPLACE DEFECTIVE EQUIPMENT (AS DEFINED IN SUBSECTION 9A) WITHIN A COMMERCIALY REASONABLE TIME AFTER RECEIVING SUCH EQUIPMENT. BUYER SPECIFICALLY ACKNOWLEDGES THAT SUPPLIER'S PRICE FOR THE EQUIPMENT IS BASED UPON THE LIMITATIONS OF SUPPLIER'S LIABILITY AS SET FORTH IN THIS CONTRACT.

10. Patents: If any claim is made against the Buyer that the Products or Services infringe any third party's US patent, the Supplier shall indemnify the Buyer against all losses, damages, costs and expenses awarded against, or incurred by, the Buyer in connection with the claim provided that: (i) the Supplier is given full control of any proceedings or negotiations in connection with any such claim; (ii) the Buyer shall give the Supplier all reasonable assistance for the purposes of any such proceedings or negotiations; (iii) except pursuant to a final award, the Buyer shall not pay or accept any such claim, or compromise any such proceedings without the consent of the Supplier; (iv) the Buyer shall do nothing which would or might vitiate any insurance policy or cover which the Buyer may have in relation to such infringement and shall use its best endeavors to recover any sums due thereunder and this indemnity shall not apply to the extent that the Buyer recovers any sums under any such policy or cover; (v) the Supplier shall be entitled to the benefit of, and the Buyer shall accordingly account to the Supplier for, all damages and costs (if any) awarded in favor of the Buyer which are payable by, or agreed with the consent of the Buyer (which consent shall not be unreasonably withheld) to be paid by, any other party in respect of any such claim; and (vi) without prejudice to any duty of the Buyer at common law, the Supplier shall be entitled to require the Buyer to take such steps as the Supplier may reasonably require to mitigate or reduce any such loss, damages, costs or expenses for which the Supplier is liable to indemnify the Buyer under Section 11, which steps may include (at the Supplier's option) accepting from the Supplier non-infringing, modified or replacement Products or Services. The Supplier shall have no obligation or liability under Section 11 insofar as the infringement arises from: (i) any additions or modifications made to the Products and/or Services in question, otherwise than by the Supplier or with its prior written consent; (ii) any information provided by the Buyer to the Supplier including without limitation any specification; (iii) performance by the Supplier of any work required to any Products, or performance of any Services, in compliance with the Buyer's requirements or specification; (iv) a combination with or an addition to equipment not manufactured or developed by the Supplier; or (v) the use of Products beyond that scope established by the Supplier or approved in writing by the Supplier.

11. Limitation of Liability and Buyer Indemnity: NOTHING IN THESE CONDITIONS SHALL EXCLUDE OR LIMIT THE SUPPLIER'S LIABILITY TO THE EXTENT THAT THE SAME MAY NOT BE EXCLUDED OR LIMITED AS A MATTER OF LAW. IN NO EVENT, REGARDLESS OF THE FORM OF ACTION, SHALL SUPPLIER BE LIABLE FOR ANY SPECIAL, INDIRECT, INCIDENTAL, OR CONSEQUENTIAL LOSSES OR DAMAGES ARISING OUT OF THE SALE OF ITS PRODUCTS TO BUYER OR ARISING OUT OF ANYTHING DONE IN CONNECTION WITH THE CONTRACT, INCLUDING, BUT NOT LIMITED TO, LOSSES OR DAMAGES ARISING OUT OF CLAIMS FOR LOSS OF USE, LOSS OF INCOME, LOSS OF REVENUE, BUSINESS, GOODWILL, OR PROFITS, AND CLAIMS ARISING OUT OF THIRD-PARTY ACTIONS, REGARDLESS OF WHETHER SUCH THIRD-PARTY ACTIONS, OR ANY OTHER CLAIMS, LOSSES, OR DAMAGES, WERE REASONABLY FORESEEABLE TO BUYER OR SUPPLIER. BUYER'S EXCLUSIVE REMEDY ARISING OUT OF ITS PURCHASE AND USE OF SUPPLIER'S PRODUCTS, OR ARISING OUT OF ANYTHING DONE IN CONNECTION WITH THE CONTRACT, SHALL BE FOR DAMAGES AND NO CLAIM OR CLAIMS OF ANY KIND, WHETHER BASED UPON CONTRACT, WARRANTY, TORT (INCLUDING, BUT NOT LIMITED TO, NEGLIGENCE, WARRANTY AND STRICT LIABILITY), STATUTORY OR REGULATORY PROVISIONS, INDEMNITY, CONTRIBUTION, OR OTHERWISE, SHALL BE GREATER IN AMOUNT IN AGGREGATE THAN THE PURCHASE PRICE OF THE PRODUCTS IN RESPECT OF WHICH DAMAGES ARE CLAIMED. Buyer shall indemnify and hold harmless Supplier, its officers, agents, employees, subsidiaries, parents, affiliates and insurers from and against any and all liabilities, damages, losses, claims, lawsuits, including costs and expenses in connection therewith, for death or injury to any persons or loss of any property whatsoever, caused in any manner by Buyer's possession, use or operation of equipment.

12. Non-Waiver; Remedies: No waiver of any breach of these Terms and Conditions shall constitute a waiver of any prior or subsequent breach of any similar or dissimilar provision or a modification of the contract. All Supplier rights and remedies, whether evidenced hereby or by any other contract or document, shall be cumulative and nonexclusive and may be exercised singularly or concurrently.

13. Applicable Law; Dispute resolution; Severability: The validity, performance and construction of the contract shall be governed by the laws of the State of Washington, without regard to conflicts of law principles. The parties agree that the United Nations Convention on Contracts for the International Sale of Goods is specifically excluded from application to these Conditions. Any claim, dispute or other matter in question arising out of or relating to this provision, shall be subject to mediation as a condition precedent to binding dispute resolution. Any mediation under this Agreement shall be administered by the American Arbitration Association in accordance with its mediation procedures then in effect. The parties shall equally share the mediator's fee and any filing fees. If the parties do not resolve their dispute through mediation, the dispute shall be resolved in mandatory arbitration

MICROSCAN.

pursuant to an arbitration administered by the American Arbitration Association in accordance with its arbitration rules then in effect. The arbitrator(s) award shall be final and judgment may be entered upon it in accordance with applicable in any court having jurisdiction thereof. Any mediation or arbitration shall be held in Seattle, WA. If Supplier is the substantially prevailing party, Supplier will be entitled to and awarded, in addition to any other relief, its reasonable costs incurred, including attorneys' fees. Notwithstanding any attempts to resolve differences, any action brought by Buyer against Supplier arising out of this contract or Buyer's purchase and use of the equipment must be commenced within one year after such use occurs and in no event later than two years after date of shipment of such equipment. Nothing in this Section 13 shall prevent any party from having recourse to a court of competent jurisdiction for the sole purpose of seeking a preliminary injunction or such other provisional judicial relief as it considers necessary. If any provision of these Terms and Conditions is held to be unenforceable, such holding shall not affect the enforceability of any other provision.

14. Government Contracts: If the products to be furnished under the contract are to be used in the performance of a United States Government contract or subcontract, the Government contract number and a statement to that effect shall appear on Buyer's purchase order. If Buyer's purchase order includes all of said information and if said order is accepted in writing by Supplier, then those clauses of the applicable Government procurement regulations which are mandatorily required by Federal statute or regulation to be included in this contract shall be incorporated herein by reference. In all other events, said clauses shall not be incorporated herein by reference.

15. Export: Regardless of any disclosure made by Buyer to Supplier of the ultimate destination of Supplier product(s), Buyer shall not export either directly or indirectly any Supplier product, or any system incorporating said product(s) either in contravention of statute or regulation or without first obtaining all required licenses and permits from the United States Department of Commerce and any other relevant agencies or departments of the United States government.

16. Assignment: The contract shall be binding upon and inure to the benefit of the parties and their respective legal representatives, successors and permitted assigns. The contract is personal to Buyer, and Buyer may not assign any of its rights or delegate any of its obligations hereunder, in whole or in part, without the prior written consent of Supplier, which Supplier may withhold for any reason or no reason.

17. Entire Agreement; Modifications: This contract constitutes the entire agreement between the parties as relates to the sale of the equipment and no addition to or modification of any provision of said agreement, together with any agreement to which these Terms and Conditions are an exhibit or schedule, and shall be binding upon Supplier unless agreed to in writing by Supplier.

18. Notices: All notices given under the contract shall be in writing, mailed by first class mail, certified or registered, or delivered by hand to the address of the other party set forth in the quotation or to such other address as such party may designate from time to time by such notice, and shall take effect when received.

Rev: 12/02/2016 | Previous: Rev. H

MICROSCAN.

Product Return Process

The following describes the process for returning products. This is broken down into two main processes:

1. **RMA (Return Material Authorization) process for NEW PRODUCT**
2. **RMA (Return Material Authorization) process for IN SERVICE PRODUCT**

RMA (Return material Authorization) process for NEW PRODUCT

This process is used to return a new product because it failed to work on initial startup (damaged on arrival) or the end customer wants to return the product to stock.

- **Damaged on arrival** = Out of box failures, determined at time of initial power up and within 30 days of shipment from Microscan.
 1. Contact your inside sales representative with the FIS part number, serial number, original sales order and/or purchase order and description of failure.
 2. If required, a REPLACEMENT sales order can be entered immediately for ASAP shipment. NOTE - Replacement scanner is processed as a NEW order and NEW INVOICE is generated at time of shipment.

Contact your inside sales representative with FIS or accessory part number, serial number (if applicable), original sales order and/or purchase order and reason for return. Upon approval all returns are subject to a standard 20% restocking fee.
 3. RMA# issued by Inside Sales Rep. This number MUST appear on the outside of the shipping container and on all related paperwork. Product must be returned in its original factory packaging.

RMA (return material authorization) process for IN SERVICE PRODUCT

- **IN WARRANTY**
 1. **Contact Customer Service (see customer service contacts) with the part number, serial number, description of failure, and request a return material authorization form (RMA).**
 2. The RMA# issued by a Customer Service Representative MUST appear on the outside of the shipping container and on all related paperwork.
- **OUT OF WARRANTY**
 1. Contact Customer Service as per "In Warranty" (above) and request a return material authorization form. Upon completion of this document, return it along with your confirming PURCHASE ORDER and an RMA# will then be issued authorizing the return of the product.
 2. The RMA# issued by a Customer Service Representative MUST appear on the outside of the shipping container and on all related paperwork.
All RMAs, warranty and non warranty will be cancelled in 60 days from issuing date if not received. If a warranty repair is changed to a non warranty repair, a purchase order must be received within 30 days of notification or the item will be returned to the sender.

MICROSCAN.

Microscan's Professional Services programs offer dedicated support and training from barcode and machine vision experts. Our team of subject matter experts have decades of real-world technical experience to support your automated application or even help design a new one

Professional services include:

- Extended Warranties
- Priority Support
- Product Training
- Field Service
- Engineering Development Services



Professional Services

Extended Warranties

Part Number	Description	List Price	Type
98-12EW-IDMV-TI	12 MO EXT WARR, TIER 1 PRODUCT	€ 95	A
98-12EW-IDMV-TII	12 MO EXT WARR, TIER 2 PRODUCT	€ 145	A
98-12EW-IDMV-TIII	12 MO EXT WARR, TIER 3 PRODUCT	€ 195	A
98-24EW-IDMV-TI	24 MO EXT WARR, TIER 1 PRODUCT	€ 145	A
98-24EW-IDMV-TII	24 MO EXT WARR, TIER 2 PRODUCT	€ 245	A
98-24EW-IDMV-TIII	24 MO EXT WARR, TIER 3 PRODUCT	€ 245	A
98-12EW-VER	12 MO EXT WARR, LVS-95XX	€ 795	A
98-24EW-VER	24 MO EXT WARR, LVS-95XX	€ 995	A
98-12EW-VER-75XX	12 MO EXT WARR, LVS-75XX	€ 2,995	A
98-24EW-VER-75XX	24 MO EXT WARR, LVS-75XX	€ 4,495	A

Tiers based on product list price. 15% premium added when ordered after date of product purchase, up to 6 months after product shipment

Tier I: <=€999, Tier II: €1000 - €2999, Tier III: €3000 - €6900.

Extended warranty excludes handhelds and NERLITE

LVS-95XX Extended Warranty excludes 5 day RMA turn-around

Highlight of Extended Warranties below. Detailed information on Professional Services located online: www.microscan.com/services



Extended Warranty Program

Additional product coverage and guaranteed response time

Protect the investment you've made in the equipment that drives your automated systems. An extended warranty on Microscan products is the best insurance policy to support uptime and overall equipment effectiveness.

- 2- and 3-year product warranties are available
- Includes guaranteed priority RMA response time
- Extended warranties are maintained by individual product serial numbers

	STANDARD	GOLD	PLATINUM
Warranty	12 Months	24 Months	36 Months
RMA Response Time	10 Days	5 Days	5 Days

Product Training

Part Number	Description	List Price	Type
98-ID-TRN-INT	ONLINE TRAINING, ID, INTRODUCTION	€ 630	A
98-ID-TRN-ADV	ONLINE TRAINING, ID, ADVANCED	€ 905	A
98-AV-TRN-ADV	ONLINE TRAINING, AUTOVISION, ADVANCED	€ 905	A
98-VS-TRN	VISIONSCAPE TRAINING, CLASSROOM	€ 1,360	A

Highlight of Product Training below. Detailed information on Professional Services located online: www.microscan.com/services

Online training can be delivered on-site at the daily rate for field service.



Training Services

Structured education and real-world application training

Microscan's professional training courses are based on our decades of experience to provide students with the best balance of practical theory and real-world application training.

- Learn about AutoVISION® and Visionscape® software, from basic to advanced topics
- Presented online, or on-site at your facility or ours
- Customized training is also available

Field Service/Engineering Development - Daily Rate

Part Number	Description	List Price	Type
98-IDMV-SS-L1	SUPPORT-DEVELOPMENT, IDMV, APP SPC	€ 1,275	A
98-IDMV-SS-L2	SUPPORT-DEVELOPMENT, IDMV, SOL ENG	€ 1,820	A
98-IDMV-SS-L3	SUPPORT-DEVELOPMENT, IDMV, PROG-DEV	€ 2,180	A
98-VER-SS-L1	SUPPORT-DEVELOPMENT, VER, APP SPC	€ 1,275	A
98-VER-SS-L2	SUPPORT-DEVELOPMENT, VER, SOL ENG	€ 1,820	A
98-VER-SS-L3	SUPPORT-DEVELOPMENT, VER, PROG-DEV	€ 2,180	A
98-IDMV-SS-L1-EXP	SUPPORT-DEVELOPMENT, IDMV, APP SPC, EXP	€ 1,720	A
98-IDMV-SS-L2-EXP	SUPPORT-DEVELOPMENT, IDMV, SOL ENG, EXP	€ 2,455	A
98-IDMV-SS-L3-EXP	SUPPORT-DEVELOPMENT, IDMV, PROG-DEV, EXP	€ 2,945	A
98-VER-SS-L1-EXP	SUPPORT-DEVELOPMENT, VER, APP SPC, EXP	€ 1,720	A
98-VER-SS-L2-EXP	SUPPORT-DEVELOPMENT, VER, SOL ENG, EXP	€ 2,455	A
98-VER-SS-L3-EXP	SUPPORT-DEVELOPMENT, VER, PROG-DEV, EXP	€ 2,945	A
98-IDMV-TRAVEL	TRAVEL EXPENSES, ID/MV (Billed at actual cost)	€ -	A
98-VER-TRAVEL	TRAVEL EXPENSES, VERIFICATION (Billed at actual cost)	€ -	A

Highlight of Field Service and Engineering Development Services below. Detailed information on Professional Services located online: www.microscan.com/services

L1: Application Specialist, L2: Solutions Engineer, L3: Program Management/R&D Engineer

EXP: Expedited Services delivered <48 hours

Domestic (in region) travel time billed in 1/2 day increments. International travel billed at daily increments.

Field Service and Engineering Development must be based on a Statement of Work (SOW) mutually agreed upon by both Microscan and the receiving customer. Contact you RSM or RSD for additional information.



Field Service Program

Dedicated on-site support and solution delivery from top experts

Whether for a day, a week, or longer, we offer daily rates to dispatch individuals and teams of subject matter experts (SMEs) direct to your site with the skills to support your project.

- Hands-on troubleshooting and preventative maintenance
- Select an Application Specialist, Solution Engineer or Program Manager
- Expedited response time is available

Support and project examples:

- Installation and integration
- On-site support
- Validation
- Application development
- System auditing and test
- Image processing
- Training and education
- Program and project management



Engineering Development Service

Custom solutions tailored to your needs

For more than 35 years, Microscan's solution development team has combined the expertise of solving real-world applications with the knowledge of deploying and validating systems.

- Design and development of custom solutions to meet specific customer and industry needs
- Automate a traceability, inspection or verification application
- Custom firmware development, user interfaces and machine vision job creation
- OEM and end-licenses of software modules

Support and project examples:

- Software design and development
- Hardware design and development
- Electrical design and development
- Mechanical design and development
- Custom product development
- Image processing
- System documentation
- Program and project management

MICROSCAN.

MS-3 Series Scanners

Read Ranges *

Narrow Bar	Laser High Density*
3.3 mil (.084 mm)	2.3" to 2.6" (58 to 66 mm)
5 mil (.127 mm)	2.0" to 3.1" (51 to 79 mm)
7.5 mil (.191 mm)	1.7" to 3.7" (43 to 94 mm)
10 mil (.254 mm)	1.5" to 4.0" (38 to 102 mm)
Narrow Bar	Laser Low Density*
7.5 mil (.191 mm)	3.0" to 6.0" (76 to 152 mm)
10 mil (.254 mm)	2.0" to 7.0" (51 to 178 mm)
15 mil (.381 mm)	2.0" to 8.0" (51 to 203 mm)
20 mil (.508 mm)	2.0" to 10.0" (51 to 254 mm)



Best Sellers

- 1) FIS-0003-0004G
- 2) FIS-0003-0003G

*Call for custom focus. For right-angle version, subtract -0.6" (15mm) from Read Range.

Important Pricing Discount Note Product discounts are applied based on the Product TYPE code shown in the TYPE column below.

Product Type codes are defined as: P = PRODUCT Discount, A = ACCESSORY Discount.

A Product Type code modified with L signifies Legacy Status (refer to Legacy section of this catalog).

Refer to your Partner Agreement for the actual discount percentage by Product Type.

Scanners MS-3 Standard

Part Number	Description	List Price	Type
FIS-0003-0001G	MS-3 Barcode Reader,Single Line,Low Density	€ 918	P
FIS-0003-0002G	MS-3 Barcode Reader,Single Line,High Density	€ 918	P
FIS-0003-0003G	MS-3 Barcode Reader,Raster,Low Density	€ 970	P
FIS-0003-0004G	MS-3 Barcode Reader,Raster,High Density	€ 970	P
FIS-0003-0005G	MS-3 Barcode Reader,Single Line,Low Density,Right Angle	€ 1,032	P
FIS-0003-0007G	MS-3 Barcode Reader,Raster,Low Density,Right Angle	€ 1,082	P

MS-3 Series Scanner Accessories

Accessories

Part Number	Description	List Price	Type
FIS-0210-0001G	MS-Connect 210, Connectivity Box with Display	€ 820	A
FIS-0210-0002G	MS-Connect 210, Connectivity Box	€ 558	A
FIS-0210-0003G	MS-Connect 210, Connectivity Box with Display & Ethernet	€ 932	A
FIS-0210-0004G	MS-Connect 210, Connectivity Box with Ethernet	€ 820	A
98-000013-04	Relay Module,120VAC,3 Amp Output,Series 70,Type SM,for MS-Connect 210 + MS-890	€ 56	A
98-000013-05	Relay Module,240VAC,3 Amp Output,Series 70,Type SM for MS-Connect 210 + MS-890	€ 56	A
98-000013-06	Relay Module, 24VDC, 3 Amp Output, Series 70, Type SM, for MS-Connect 210,MS-890	€ 56	A
61-000127-02	Cable, MS-2-to-MS-Connect 210, 6 ft.	€ 112	A
FIS-0001-0030G	IB-3PC Keyboard Wedge/Interface Box	€ 166	A
98-000051-01	IC-3USB Interface Kit, USB-to-Serial, 15-Pin	€ 94	A
FIS-0001-0035G	Converter, IC-332, 24V/5V, Opto I/O, for Use with IB-131	€ 184	A
99-000018-01	IB-131 Interface Box	€ 184	A
61-300026-03	Cable, Communication, DB-25 Plug-to-DB-9 Socket, 6 ft.	€ 36	A
61-000010-02	Cable, Communication, DB-9 Socket-to-DB-9 Socket, 6 ft.	€ 36	A
61-000011-02	Extension Cable, Reader-to-IB-131 (MS-2, MS-3, MS-4, MS-9, MS-710, MS-820, MINI)	€ 36	A
61-100029-03	Cable, Daisy Chain, IB-131	€ 36	A
98-000055-05*	Demo Kit, MS-3, MINI	€ 596	A

* This Demo Kit does not contain a reader and is discounted 25%. The separately purchased reader is discounted 60%.

Power Supplies

Part Number	Description	List Price	Type
97-000011-01	Power Supply,100-240VAC,+5VDC, 5PIN, USA/EUR Plug	€ 94	A
97-000011-02	Power Supply,100-240VAC,+5VDC, 2PN PLG, USA/EUR Plug	€ 94	A
97-000012-02	Power Supply (100-240 VAC, +24VDC, TRK 3Pin, USA/Euro Plug)	€ 154	A

Mounting and Connectors

Part Number	Description	List Price	Type
98-000048-01	Kit, Mounting Arm/Adapter, 4 in., for MS-2, MS-3	€ 78	A
98-000054-01	Kit, Mounting Stand Base Plate	€ 36	A
98-000053-01	Mounting Arm Extension Kit, 4 in., for MS-3, MS-4, MINI	€ 40	A
98-000053-02	Mounting Arm Extension Kit, 3 in., for MS-2, MS-3, MS-4, MINI	€ 40	A
98-000060-01	Kit, Bracket, Side Mount, MS-2, MS-3, MINI	€ 24	A
98-000059-01	Kit, Bracket, Angle Mount, MS-2, MS-3, MINI	€ 24	A
98-000057-02	Kit, Bracket, Through-Hole Mount, MS-2, MS-3, MINI	€ 24	A
98-000058-02	Kit, Extended Right Angle Mirror, MS-2, MS-3	€ 56	A
98-000061-03	Kit, Bracket Conversion, MS-2, MS-3-to-MS-520/MS-525	€ 24	A
20-610024-01	Trigger Connector, 4-Pin Plug (Screw Terminal, Field-Wireable) (Self-Wiring)	€ 36	A
20-610020-01	Power Conn.,3-Pin Socket (Screw Term.,Field-Wireable for Custom IB-131 Wiring)	€ 36	A

Package Detector/Sensor

Part Number	Description	List Price	Type
99-000017-01	Photo Sensor, Visible, NPN, Dark ON	€ 196	A
99-000017-02	Photo Sensor, Visible, NPN, Light ON	€ 196	A

Software/Manuals

Part Number	Description	List Price	Type
37-000010-01*	Tools Drive, User Documentation, Software	€ 30	A

* 1 free per order.

Stand Alone (5V)

Tech Reference MS-3

This is the basic setup for a single MS-3.

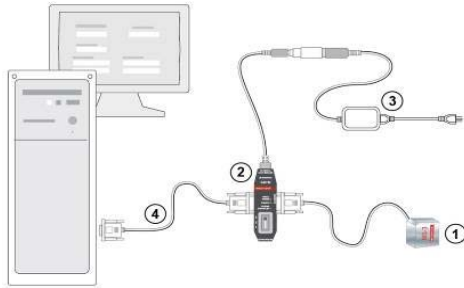

System Matrix

Product	Reference No.	Description	List Price
(1) MS-3 Laser	FIS-0003-XXXXG	Scanner Model	Varies
(2) IB-3PC	FIS-0001-0030G	IB-3PC Keyboard Wedge/Interface Box	€ 166
(3) Power Supply	97-000011-01	Power Supply, 100-240VAC, +5VDC, 5PIN, USA/EUR Plug	€ 94
(4) Communication Cable	61-000010-02	Cable, Communication, DB-9 Socket-to-DB-9 Socket, 6 ft.	€ 36
Mounting Arm/Adapter Kit	98-000048-01	Kit, Mounting Arm/Adapter, 4 in., for MS-2, MS-3	€ 78
Mounting Plate	98-000054-01	Kit, Mounting Stand Base Plate	€ 36
User Documentation, Software	37-000010-01*	Tools Drive, User Documentation, Software	€ 30

* 1 free per order.

Tech Reference MS-3

Stand Alone (5V)

This is the basic setup for a single MS-3 and MS-Connect 210.

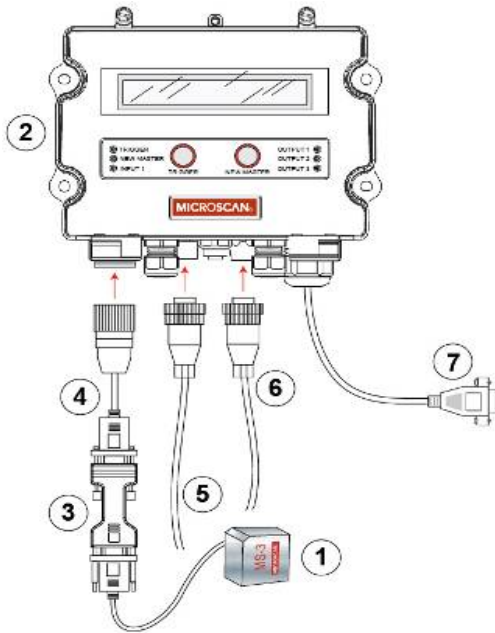

System Matrix

Product	Reference No.	Description	List Price
1	FIS-0003-XXXXG	Scanner Model	Varies
2	FIS-0210-000XG	Connectivity Box A	Varies
3	FIS-0001-0035G	Converter, IC-332, 24V/5V, Opto I/O, for Use with IB-131	€ 184
4	61-000127-02	Cable, MS-2-to-MS-Connect 210, 6 ft.	€ 112
5	97-000012-02	Power Supply (100-240 VAC, +24VDC, TRK 3Pin, USA/Euro Plug)	€ 154
6	99-000017-02	Photo Sensor, Visible, NPN, Light ON	€ 196
7	61-000105-01	Cable, Pre-Stripped-to-9-Pin Host Cable, 6 ft.	€ 32
User Documentation, Software	37-000010-01*	Tools Drive, User Documentation, Software	€ 30

^A See MS-Connect Series section for a complete listing of Accessories

** 1 free host cable is included with each MS-Connect 210

* 1 free per order.

Tech Reference *MS-3*

Keyboard Wedge

Allows the scanner to bypass RS-232 port and input data to a host via the keyboard line.

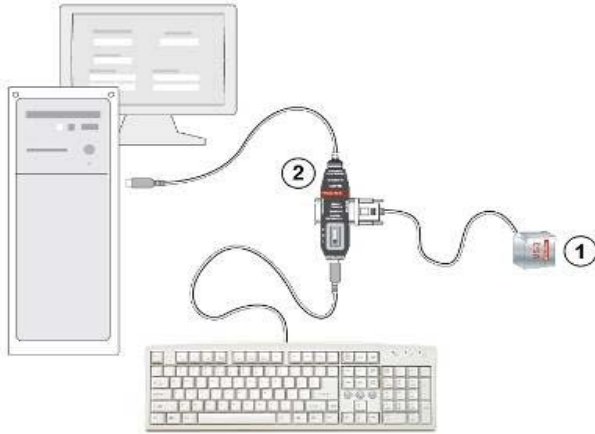

System Matrix

Product	Reference No.	Description	List Price
1	FIS-0003-XXXXG	Scanner Model	Varies
2	FIS-0001-0030G	IB-3PC Keyboard Wedge/Interface Box	€ 166
Mounting Arm/Adapter Kit	98-000048-01	Kit, Mounting Arm/Adapter, 4 in., for MS-2, MS-3	€ 78
Mounting Plate	98-000054-01	Kit, Mounting Stand Base Plate	€ 36
User Documentation, Software	37-000010-01*	Tools Drive, User Documentation, Software	€ 30

* 1 free per order.

Tech Reference MS-3

USB

Allows the scanner to be powered and communicate via a USB port (virtual com port).

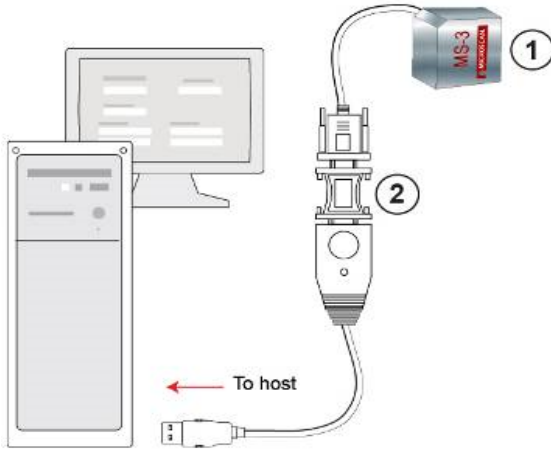

System Matrix

Product	Reference No.	Description	List Price
1	FIS-0003-XXXXG	Scanner Model	Varies
2	98-000051-01	IC-3USB Interface Kit, USB-to-Serial, 15-Pin	€ 94
Mounting Arm/Adapter Kit	98-000048-01	Kit, Mounting Arm/Adapter, 4 in., for MS-2, MS-3	€ 78
Mounting Plate	98-000054-01	Kit, Mounting Stand Base Plate	€ 36
User Documentation, Software	37-000010-01*	Tools Drive, User Documentation, Software	€ 30

* 1 free per order.

Tech Reference MS-3

Stand Alone (10-28V)

This is the basic setup for a single MS-3.

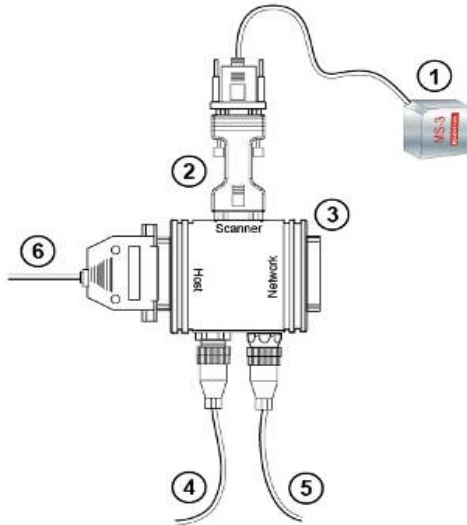

System Matrix

Product	Reference No.	Description	List Price
1	FIS-0003-XXXXG	Scanner Model	Varies
2	FIS-0001-0035G	Converter, IC-332, 24V/5V, Opto I/O, for Use with IB-131	€ 184
3	99-000018-01	IB-131 Interface Box	€ 184
4	97-000012-02	Power Supply (100-240 VAC, +24VDC, TRK 3Pin, USA/Euro Plug)	€ 154
5	99-000017-01	Photo Sensor, Visible, NPN, Dark ON	€ 196
6	61-300026-03	Cable, Communication, DB-25 Plug-to-DB-9 Socket, 6 ft.	€ 36
Mounting Arm/Adapter Kit	98-000048-01	Kit, Mounting Arm/Adapter, 4 in., for MS-2, MS-3	€ 78
Mounting Plate	98-000054-01	Kit, Mounting Stand Base Plate	€ 36
User Documentation, Software	37-000010-01*	Tools Drive, User Documentation, Software	€ 30

* 1 free per order.

Tech Reference MS-3

Daisy Chain

A primary scanner is linked directly to the host. Secondary scanners (up to 9) are linked in tandem. Data is sent from the primary scanner directly to the host.

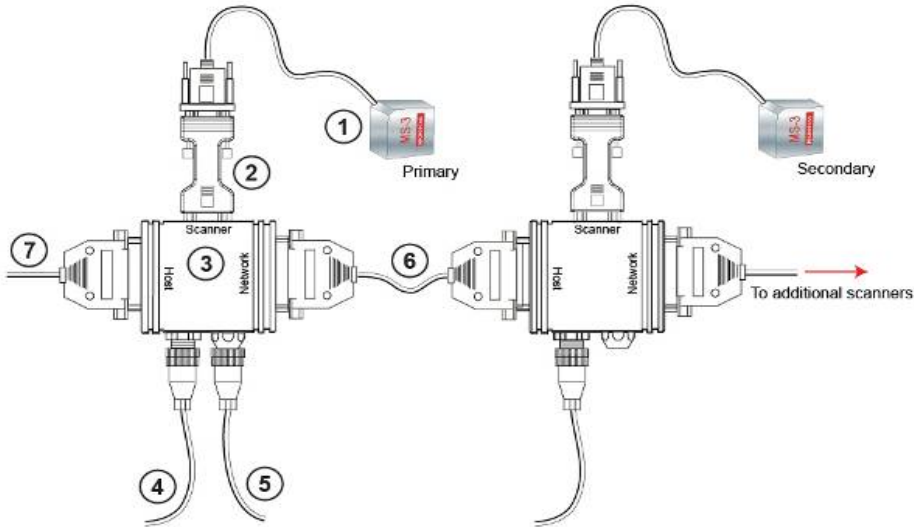

System Matrix

Product	Reference No.	Description	List Price
1	FIS-0003-XXXXG	Scanner Model	Varies
2	FIS-0001-0035G	Converter, IC-332, 24V/5V, Opto I/O, for Use with IB-131	€ 184
3	99-000018-01	IB-131 Interface Box	€ 184
4	97-000012-02	Power Supply (100-240 VAC, +24VDC, TRK 3Pin, USA/Euro Plug)	€ 154
5	99-000017-01	Photo Sensor, Visible, NPN, Dark ON	€ 196
6	61-100029-03	Cable, Daisy Chain, IB-131	€ 36
7	61-300026-03	Cable, Communication, DB-25 Plug-to-DB-9 Socket, 6 ft.	€ 36
Mounting Arm/Adapter Kit	98-000048-01	Kit, Mounting Arm/Adapter, 4 in., for MS-2, MS-3	€ 78
Mounting Plate	98-000054-01	Kit, Mounting Stand Base Plate	€ 36
User Documentation, Software	37-000010-01	Tools Drive, User Documentation, Software	€ 30

* 1 free per order.

Optional Interface Protocols

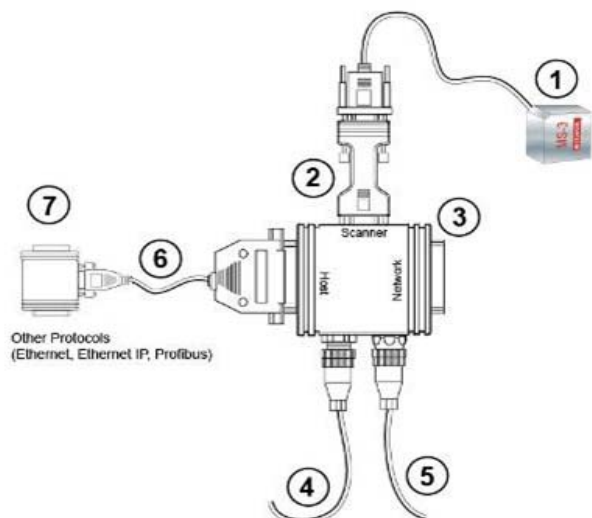

System Matrix

Product	Reference No.	Description	List Price
1	FIS-0003-XXXXG	Scanner Model	Varies
2	FIS-0001-0035G	Converter, IC-332, 24V/5V, Opto I/O, for Use with IB-131	€ 184
3	99-000018-01	IB-131 Interface Box	€ 184
4	97-000012-02	Power Supply (100-240 VAC, +24VDC, TRK 3Pin, USA/Euro Plug)	€ 154
5	99-000017-01	Photo Sensor, Visible, NPN, Dark ON	€ 196
6	61-300026-03	Cable, Communication, DB-25 Plug-to-DB-9 Socket, 6 ft.	€ 36
7	Third Party	Ask your Microscan sales representative which solution is appropriate for your application.	Varies
Mounting Arm/Adapter Kit	98-000048-01	Kit, Mounting Arm/Adapter, 4 in., for MS-2, MS-3	€ 78
Mounting Plate	98-000054-01	Kit, Mounting Stand Base Plate	€ 36
User Documentation, Software	37-000010-01*	Tools Drive, User Documentation, Software	€ 30

* 1 free per order.

MICROSCAN

QX-830 High Performance Compact Industrial Barcode Reader

Read Ranges

Narrow Bar	High Density
5 mil (.127 mm)	4.0" to 5.5" (101 to 140 mm)
7.5 mil (.191 mm)	3.5" to 6.75" (89 to 171 mm)
10 mil (.254 mm)	3.25" to 8.0" (82 to 203 mm)
15 mil (.381 mm)	3.25" to 9.0" (82 to 228 mm)
Narrow Bar	Medium Density
7.5 mil (.191 mm)	2.5" to 5.5" (64 to 140 mm)
10 mil (.254 mm)	1.5" to 7.0" (38 to 178 mm)
15 mil (.381 mm)	1.5" to 8.5" (38 to 216 mm)
20 mil (.508 mm)	1.5" to 11" (38 to 280 mm)
30 mil (.762 mm)	1.0" to 12" (25 to 304 mm)
Narrow Bar	Low Density
7.5 mil (.191 mm)	10" to 12" (254 to 304 mm)
10 mil (.254 mm)	7.0" to 16" (177 to 406 mm)
15 mil (.381 mm)	6.0" to 19" (152 to 483 mm)
20 mil (.508 mm)	5.0" to 22" (127 to 558 mm)
40 mil (1.02 mm)	4.0" to 30" (101 to 762 mm)



Best Sellers
1) FIS-0830-1004G
2) FIS-0830-1005G

****Important Pricing Discount Note**** Product discounts are applied based on the Product TYPE code shown in the TYPE column below. Product Type codes: P = PRODUCT Discount, A = ACCESSORY Discount. 'L' = Legacy status. Refer to your Partner Agreement for the actual discount percentage by Product Type.

Scanners

Part Number	Description	List Price	Type
FIS-0830-0001G	QX-830 Scanner, Single Line, LD, Serial	€ 1,576	P
FIS-0830-0002G	QX-830 Scanner, Single Line, MD, Serial	€ 1,576	P
FIS-0830-0003G	QX-830 Scanner, Single Line, HD, Serial	€ 1,576	P
FIS-0830-0004G	QX-830 Scanner, Raster Line, LD, Serial	€ 1,576	P
FIS-0830-0005G	QX-830 Scanner, Raster Line, MD, Serial	€ 1,576	P
FIS-0830-0006G	QX-830 Scanner, Raster Line, HD, Serial	€ 1,576	P
FIS-0830-0010G	QX-830 Scanner, Raster Line, LD, Serial, Plastic Window	€ 1,576	P
FIS-0830-1001G	QX-830, Industrial Barcode Reader, Single Line, Low Density, Serial+Ethernet	€ 1,754	P
FIS-0830-1002G	QX-830 Scanner, Single Line, MD, Serial & Ethernet	€ 1,754	P
FIS-0830-1003G	QX-830 Scanner, Single Line, HD, Serial & Ethernet	€ 1,754	P
FIS-0830-1004G	QX-830, Industrial Barcode Reader, Raster Line, Low Density, Serial+Ethernet	€ 1,754	P
FIS-0830-1005G	QX-830 Scanner, Raster Line, MD, Serial & Ethernet	€ 1,754	P
FIS-0830-1006G	QX-830 Scanner, Raster Line, HD, Serial & Ethernet	€ 1,754	P
FIS-0830-1010G	QX-830 Scanner, Raster Line, LD, Serial & Ethernet, Plastic Window	€ 1,754	P

Accessories

Part Number	Description	List Price	Type
98-000102-01*	Demo Kit, QX-830/QX-870	€ 554	A

* This Demo Kit does not contain a reader and is discounted 25%. The separately-purchased reader is discounted 60%.

QX-1 and Cordsets

Part Number	Description	List Price	Type
98-000103-02	QX-1 Interface Device	€ 196	A
61-000148-02	QX Cordset, Common, M12 12-Pin Socket(Screw-On)-to-M12 12-Pin Plug(Screw-On), 3m.	€ 96	A
61-000162-02	QX Cordset, Common, M12 12-Pin Socket(Screw-On)-to-M12 12-Pin Plug(Screw-On), 1m.	€ 92	A
61-000153-02	QX Cordset, Host, Serial, M12 12-Pin Socket (Screw-On)-to-DB-9 Socket, 1 m.	€ 92	A
61-000164-02	QX Cordset, Host, Serial, M12 12-Pin Socket (Screw-On)-to-DB-9 Socket, 3 m.	€ 96	A
61-000152-02	QX Cordset, Host, Serial, M12 12-Pin Plug (Screw-On)-to-DB-9 Socket, 1 m.	€ 92	A
61-000165-02	QX Cordset, Host, Serial M12 12-Pin Plug (Screw-On)-to-DB-9 Socket, 3 m.	€ 96	A
61-000163-03	QX Cordset, Host, Ethernet, M12 8-Pin Plug (Screw-On)-to-RJ45, 3 m.	€ 96	A
61-000160-03	QX Cordset, Host, Ethernet, M8 8-Pin Plug (Screw-On)-to-RJ45, 1 m.	€ 92	A
61-000172-02	QX Cordset, M12 12-Pin Plug-to-M12 12-Pin Socket-to-DB-25 Plug, Turck Connectors	€ 280	A
61-000158-03	QX Cordset, M12 12-Pin Plug & M12 12-Pin Socket-to-MS-Connect 210 (RS-232), 2 m.	€ 346	A
61-000166-02	QX Cordset, M12 12-Pin Plug (Screw-On)-to-Flying Leads, 3 m.	€ 96	A
61-000167-02	QX Cordset, M12 12-Pin Socket (Screw-On)-to-Flying Leads, 3 m.	€ 96	A
61-000159-03	QX Cordset, M12 12-Pin Plug & Socket-to-IB-131, RS-232, 2 m.	€ 182	A
61-000159-04	QX Cordset, M12 12-Pin Socket-to-IB-131, RS-232/RS-485, 2 m.	€ 182	A
98-000013-04	Relay Module, 120VAC, 3 Amp Output, Series 70, Type SM, for MS-Connect 210 + MS-890	€ 56	A
98-000013-05	Relay Module, 240VAC, 3 Amp Output, Series 70, Type SM for MS-Connect 210 + MS-890	€ 56	A
98-000013-06	Relay Module, 24VDC, 3 Amp Output, Series 70, Type SM, for MS-Connect 210, MS-890	€ 56	A

QX-830 Industrial Scanner Continued

Power Supplies

Part Number	Description	List Price	Type
97-000012-01	Power Supply, 100-240VAC, +24VDC, M12 12-pin Socket	€ 140	A
97-000012-04	QX Power Supply, 24V, M12 12 pin Plug, USA /Euro Plug	€ 136	A

Package Detector/Sensor

Part Number	Description	List Price	Type
99-000020-02	QX Photo Sensor, M12 4-Pin Plug, NPN, Dark On, 2 m.	€ 196	A
99-000020-01	QX Photo Sensor, M12 4-Pin Plug, NPN, Dark Off, 2 m.	€ 196	A

Mounting and Connectors

Part Number	Description	List Price	Type
98-500006-01*	Kit, Mounting Plate, MS-710, MS-820, QX-830, QX-870	€ 24	A
98-200026-02	Kit, Right Angle Mirror, MS-820/QX-830	€ 84	A
61-000166-02	QX Cordset, M12 12-Pin Plug (Screw-On)-to-Flying Leads, 3 m.	€ 96	A
61-000167-02	QX Cordset, M12 12-Pin Socket (Screw-On)-to-Flying Leads, 3 m.	€ 96	A
20-610024-01	Trigger Connector, 4-Pin Plug (Screw Terminal, Field-Wireable) (Self-Wiring)	€ 36	A
98-000016-01	Kit, 6 in. Mounting Arm/Adapter, MS-820, QX-830, QX-870	€ 120	A
98-000037-01	Mounting Arm Extension Kit, 6 in., All Readers	€ 62	A
98-000054-01	Kit, Mounting Stand Base Plate	€ 36	A
98-000148-01	Kit, L-Bracket, QX Series	€ 46	A

* Though-hole mounting plate; not for use with mounting arm.

Software/Manuals

Part Number	Description	List Price	Type
37-000010-01*	Tools Drive, User Documentation, Software	€ 30	A

* 1 free per order.

Tech Reference QX-830

Stand Alone Configurations

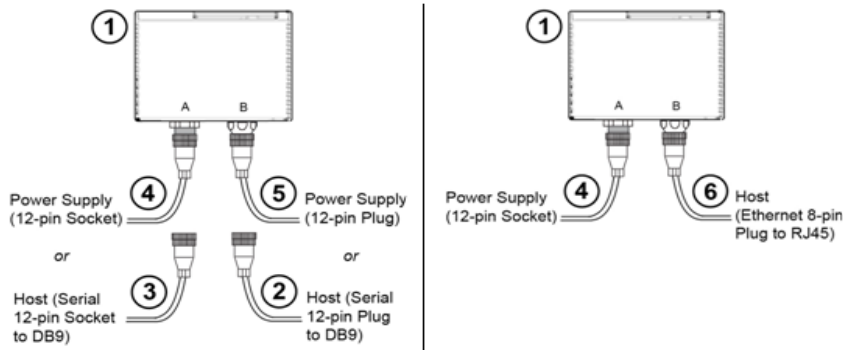

Item	Part Number	Description	List Price
1	FIS-0830-XXXXG	QX-830 Compact Industrial Scanner	Varies
2	61-000152-02*	QX Cordset, Host, Serial, M12 12-Pin Plug (Screw-On)-to-DB-9 Socket, 1 m.	€ 92
3	61-000153-02*	QX Cordset, Host, Serial, M12 12-Pin Socket (Screw-On)-to-DB-9 Socket, 1 m.	€ 92
4	97-000012-01	Power Supply, 100-240VAC, +24VDC, M12 12-Pin Socket	€ 140
5	97-000012-04	QX Power Supply, 24V, M12 12 pin Plug, USA /Euro Plug	€ 136
6	61-000160-03	QX Cordset, Host, Ethernet, M8 8-Pin Plug (Screw-On)-to-RJ45, 1 m.	€ 92
	98-000016-01	Kit, 6 in. Mounting Arm/Adapter, MS-820, QX-830, QX-870	€ 120
	98-000054-01	Kit, Mounting Stand Base Plate	€ 36
	37-000010-01**	Tools Drive, User Documentation, Software	€ 30

* Cordsets available in multiple lengths

** One free per order.

Stand Alone Configurations

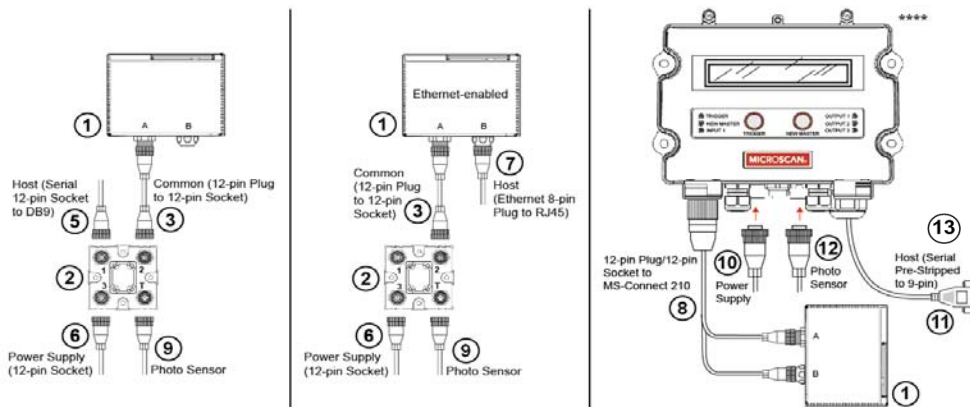

Item	Part Number	Description	List Price
1	FIS-0830-XXXXG	QX-830 Compact Industrial Scanner	Varies
2	98-000103-02	QX-1 Interface Device	€ 196
3	61-000162-02*	QX Cordset, Common, M12 12-Pin Socket (Screw-On)-to-M12 12-Pin Plug (Screw-On), 1m.	€ 92
4	61-000152-02*	QX Cordset, Host, Serial, M12 12-Pin Plug (Screw-On)-to-DB-9 Socket, 1 m.	€ 92
5	61-000153-02*	QX Cordset, Host, Serial, M12 12-Pin Socket (Screw-On)-to-DB-9 Socket, 1 m.	€ 92
6	97-000012-01	Power Supply, 100-240VAC, +24VDC, M12 12-Pin Socket	€ 140
7	61-000160-03*	QX Cordset, Host, Ethernet, M8 8-Pin Plug (Screw-On)-to-RJ45, 1 m.	€ 92
8	61-000158-03	QX Cordset, M12 12-Pin Plug & M12 12-Pin Socket-to-MS-Connect 210 (RS-232), 2 m.	€ 346
9	99-000020-02	QX Photo Sensor, M12 4-Pin Plug, NPN, Dark On, 2 m.	€ 196
10	97-000012-02	Power Supply, 100-240VAC, +24VDC, TRK 3-Pin, U.S./Euro Plug)	€ 154
11	61-000105-01	Cable, Pre-Stripped-to-9-Pin Host Cable, 6 ft.	€ 32
12	99-000017-01	Photo Sensor, Visible, NPN, Dark ON	€ 196
13	FIS-0210-000XG***	Connectivity Box	Varies
	98-000016-01	Kit, 6 in. Mounting Arm/Adapter, MS-820, QX-830, QX-870	€ 120
	98-000054-01	Kit, Mounting Stand Base Plate	€ 36
	37-000010-01**	Tools Drive, User Documentation, Software	€ 30

* Cordsets available in multiple lengths

** One free per order.

*** Refer to MS-Connection section for complete listing of MS-Connection 210 options

Tech Reference QX-830

Daisy Chain Configurations

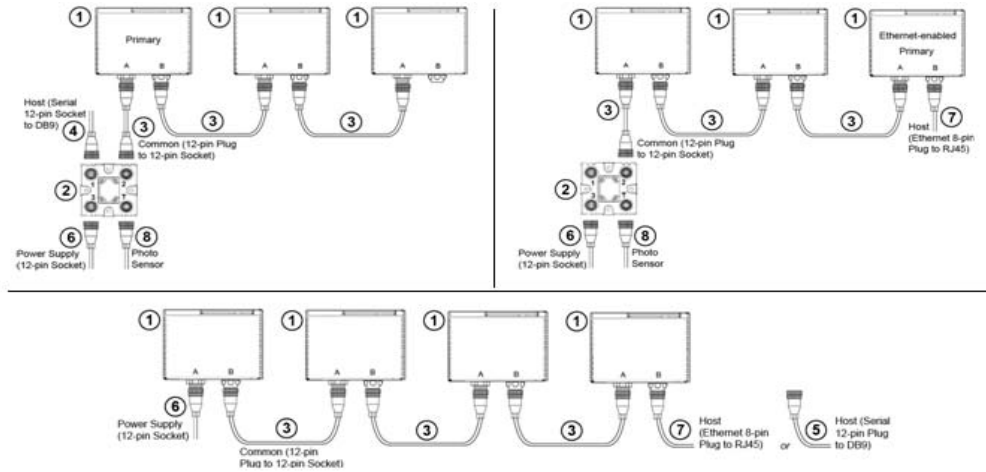

Item	Part Number	Description	List Price
1	FIS-0830-XXXXG	QX-830 Compact Industrial Scanner	Varies
2	98-000103-02	QX-1 Interface Device	€ 196
3	61-000162-02*	QX Cordset, Common, M12 12-Pin Socket (Screw-On)-to-M12 12-Pin Plug (Screw-On), 1m.	€ 92
4	61-000153-02*	QX Cordset, Host, Serial, M12 12-Pin Socket (Screw-On)-to-DB-9 Socket, 1 m.	€ 92
5	61-000152-02*	QX Cordset, Host, Serial, M12 12-Pin Plug (Screw-On)-to-DB-9 Socket, 1 m.	€ 92
6	97-000012-01	Power Supply, 100-240VAC, +24VDC, M12 12-Pin Socket	€ 140
7	61-000160-03	QX Cordset, Host, Ethernet, M8 8-Pin Plug (Screw-On)-to-RJ45, 1 m.	€ 92
8	99-000020-02	QX Photo Sensor, M12 4-Pin Plug, NPN, Dark On, 2 m.	€ 196
	98-000016-01	Kit, 6 in. Mounting Arm/Adapter, MS-820, QX-830, QX-870	€ 120
	98-000054-01	Kit, Mounting Stand Base Plate	€ 36
	37-000010-01**	Tools Drive, User Documentation, Software	€ 30

* Cordsets available in multiple lengths

** One free per order.

Optional Interface Protocols

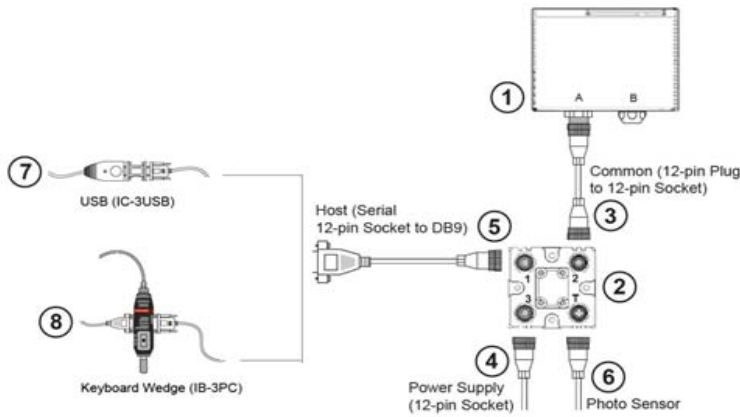

Item	Part Number	Description	List Price
1	FIS-0830-XXXXG	QX-830 Compact Industrial Scanner	Varies
2	98-000103-02	QX-1 Interface Device	€ 196
3	61-000162-02*	QX Cordset, Common, M12 12-Pin Socket(Screw-On)-to-M12 12-Pin Plug(Screw-On), 1m.	€ 92
4	97-000012-01	Power Supply, 100-240VAC, +24VDC, M12 12-Pin Socket	€ 140
5	61-000153-02*	QX Cordset, Host, Serial, M12 12-Pin Socket (Screw-On)-to-DB-9 Socket, 1 m.	€ 92
6	99-000020-02	QX Photo Sensor, M12 4-Pin Plug, NPN, Dark On, 2 m.	€ 196
7	98-000051-01	IC-3USB Interface Kit, USB-to-Serial, 15-Pin	€ 94
8	FIS-0001-0030G	IB-3PC Keyboard Wedge/Interface Box	€ 166
	98-000016-01	Kit, 6 in. Mounting Arm/Adapter, MS-820, QX-830, QX-870	€ 120
	98-000054-01	Kit, Mounting Stand Base Plate	€ 36
	37-000010-01**	Tools Drive, User Documentation, Software	€ 30

* Cordsets available in multiple lengths. See Accessories section for additional detail.

** One free per order.

MICROSCAN.

QX-870 High Performance Industrial Sweeping Raster Barcode Reader

Read Ranges	
Narrow Bar	High Density
5 mil (.127 mm)	4" to 5" (102 to 127 mm)
7.5 mil (.191 mm)	3.5" to 6.75" (89 to 171 mm)
10 mil (.254 mm)	3.25" to 8" (82 to 203 mm)
15 mil (.381 mm)	3.25" to 9" (82 to 228 mm)
Narrow Bar	Medium Density
7.5 mil (.191 mm)	2.5" to 5.5" (64 to 140 mm)
10 mil (.254 mm)	1.5" to 7" (38 to 178 mm)
15 mil (.381 mm)	1.5" to 8.5" (38 to 216 mm)
30 mil (.762 mm)	1" to 12" (25 to 304 mm)
Narrow Bar	Low Density
7.5 mil (.191 mm)	10" to 12" (254 to 305 mm)
10 mil (.254 mm)	7" to 16" (178 to 406 mm)
15 mil (.381 mm)	6" to 19" (152 to 483 mm)
20 mil (.508 mm)	5" to 22" (127 to 558 mm)
40 mil (1.02 mm)	4" to 30" (102 to 762 mm)



Best Sellers
1) FIS-0870-0004G
2) FIS-0870-1004G

****Important Pricing Discount Note**** Product discounts are applied based on the Product TYPE code shown in the TYPE column below.

Product Type codes are defined as: P = PRODUCT Discount, A = ACCESSORY Discount.

A Product Type code modified with L signifies Legacy Status (refer to Legacy section of this catalog).

Refer to your Partner Agreement for the actual discount percentage by Product Type.

Barcode Readers		List Price	Type
Part Number	Description		
FIS-0870-0004G	QX-870,Industrial Barcode Reader,Low Density,Sweeping Raster,Serial	€ 2,540	P
FIS-0870-0005G	QX-870,Industrial Barcode Reader,Medium Density,Sweeping Raster,Serial	€ 2,540	P
FIS-0870-0006G	QX-870,Industrial Barcode Reader,High Density,Sweeping Raster,Serial	€ 2,540	P
FIS-0870-0007G	QX-870,Industrial Barcode Rdr,Plastic Window,Low Density,Sweeping Raster,Serial	€ 2,774	P
FIS-0870-1004G	QX-870,Industrial Barcode Reader,Low Density,Sweeping Raster,Serial+Ethernet	€ 2,736	P
FIS-0870-1005G	QX-870,Industrial Barcode Reader,Medium Density,Sweeping Raster,Serial+Ethernet	€ 2,736	P
FIS-0870-1006G	QX-870,Industrial Barcode Reader,High Density,Sweeping Raster,Serial+Ethernet	€ 2,736	P

QX-1 and Cordsets		List Price	Type
Part Number	Description		
98-000103-02	QX-1 Interface Device	€ 196	A
61-000148-02	QX Cordset,Common,M12 12-Pin Socket(Screw-On)-to-M12 12-Pin Plug(Screw-On),3m.	€ 96	A
61-000162-02	QX Cordset,Common,M12 12-Pin Socket(Screw-On)-to-M12 12-Pin Plug(Screw-On),1m.	€ 92	A
61-000153-02	QX Cordset, Host, Serial, M12 12-Pin Socket (Screw-On)-to-DB-9 Socket, 1 m.	€ 92	A
61-000164-02	QX Cordset, Host, Serial, M12 12-Pin Socket (Screw-On)-to-DB-9 Socket, 3 m.	€ 96	A
61-000152-02	QX Cordset, Host, Serial, M12 12-Pin Plug (Screw-On)-to-DB-9 Socket, 1 m.	€ 92	A
61-000165-02	QX Cordset, Host, Serial M12 12-Pin Plug (Screw-On)-to-DB-9 Socket, 3 m.	€ 96	A
61-000163-03	QX Cordset, Host, Ethernet, M12 8-Pin Plug (Screw-On)-to-RJ45, 3 m.	€ 96	A
61-000160-03	QX Cordset, Host, Ethernet, M8 8-Pin Plug (Screw-On)-to-RJ45, 1 m.	€ 92	A
61-000172-02	QX Cordset,M12 12-Pin Plug-to-M12 12-Pin Socket-to-DB-25 Plug, Turck Connectors	€ 280	A
61-000158-03	QX Cordset, M12 12-Pin Plug & M12 12-Pin Socket-to-MS-Connect 210 (RS-232), 2 m.	€ 346	A
61-000166-02	QX Cordset, M12 12-Pin Plug (Screw-On)-to-Flying Leads, 3 m.	€ 96	A
61-000167-02	QX Cordset, M12 12-Pin Socket (Screw-On)-to-Flying Leads, 3 m.	€ 96	A
98-000013-04	Relay Module,120VAC,3 Amp Output,Series 70,Type SM,for MS-Connect 210 + MS-890	€ 56	A
98-000013-05	Relay Module,240VAC,3 Amp Output,Series 70,Type SM for MS-Connect 210 + MS-890	€ 56	A
98-000013-06	Relay Module, 24VDC, 3 Amp Output, Series 70, Type SM, for MS-Connect 210,MS-890	€ 56	A

QX-870 Industrial Scanner Accessories (Similar to QX-830)

Accessories		List Price	Type
Part Number	Description		
98-000102-01*	Demo Kit, QX-830/QX-870	€ 554	A

* This Demo Kit does not contain a reader and is discounted 25%. The separately purchased reader is discounted 60%.

Power Supplies		List Price	Type
Part Number	Description		
97-000012-01	Power Supply, 100-240VAC, +24VDC, M12 12-pin Socket	€ 140	A
97-000012-04	QX Power Supply, 24V, M12 12 pin Plug, USA /Euro Plug	€ 136	A

Package Detector/Sensor		List Price	Type
Part Number	Description		
99-000020-02	QX Photo Sensor, M12 4-Pin Plug, NPN, Dark On, 2 m.	€ 196	A
99-000020-01	QX Photo Sensor, M12 4-Pin Plug, NPN, Dark Off, 2 m.	€ 196	A

Mounting and Connectors

Part Number	Description	List Price	Type
98-50006-01*	Kit, Mounting Plate, MS-710, MS-820, QX-830, QX-870	€ 24	A
20-610024-01	Trigger Connector, 4-Pin Plug (Screw Terminal, Field-Wireable) (Self-Wiring)	€ 36	A
61-000166-02	QX Cordset, M12 12-Pin Plug (Screw-On)-to-Flying Leads, 3 m.	€ 96	A
61-000167-02	QX Cordset, M12 12-Pin Socket (Screw-On)-to-Flying Leads, 3 m.	€ 96	A
98-000016-01	Kit, 6 in. Mounting Arm/Adapter, MS-820, QX-830, QX-870	€ 120	A
98-000037-01	Mounting Arm Extension Kit, 6 in., All Readers	€ 62	A
98-000054-01	Kit, Mounting Stand Base Plate	€ 36	A
98-000148-01	Kit, L-Bracket, QX Series	€ 46	A

* Though-hole mounting plate; not for use with mounting arm.

Software/Manuals

Part Number	Description	List Price	Type
37-000010-01*	Tools Drive, User Documentation, Software	€ 30	A

* 1 free per order.

Tech Reference QX-870

Stand Alone Configurations

MS-Connect 210



Item	Part Number	Description	List Price
1	FIS-0870-XXXXG	QX-870 Industrial Raster Barcode Reader	Varies
4	61-000152-02*	QX Cordset, Host, Serial, M12 12-Pin Plug (Screw-On)-to-DB-9 Socket, 1 m.	€ 92
6	97-000012-01	Power Supply, 100-240VAC, +24VDC, M12 12-Pin Socket	€ 140
7	61-000160-03*	QX Cordset, Host, Ethernet, M8 8-Pin Plug (Screw-On)-to-RJ45, 1 m.	€ 92
8	61-000158-03	QX Cordset, M12 12-Pin Plug & M12 12-Pin Socket-to-MS-Connect 210 (RS-232), 2 m.	€ 346
9	99-000020-02***	QX Photo Sensor, M12 4-Pin Plug, NPN, Dark On, 2 m.	€ 196
10	97-000012-02	Power Supply, 100-240VAC, +24VDC, TRK 3-Pin, U.S./Euro Plug)	€ 154
13	FIS-0210-000XG****	Connectivity Box	Varies
	98-000016-01	Kit, 6 in. Mounting Arm/Adapter, MS-820, QX-830, QX-870	€ 120
	98-000054-01	Kit, Mounting Stand Base Plate	€ 36
	37-000010-01**	Tools Drive, User Documentation, Software	€ 30

* Cordsets available in multiple lengths

** One free per order.

***QX-870 with MS-Connect 210 requires a PNP photo sensor such as IDEX SA1E-NP1 (LO) and -NP2 (DO)

**** Refer to MS-Connection section for complete listing of MS-Connection 210 options

Daisy Chain Configuration

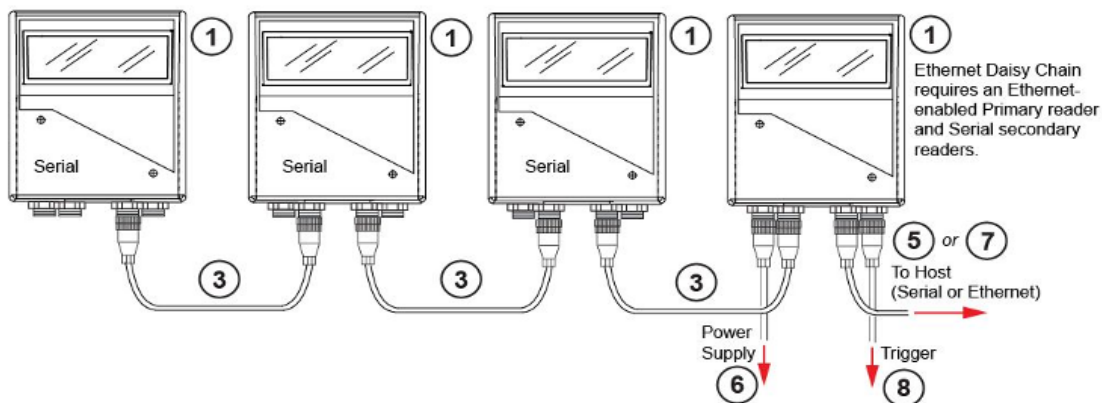

Please also Reference QX-830 section for alternative Daisy Chain configurations

Item	Part Number	Description	List Price
1	FIS-0870-XXXXG	QX-870 Industrial Raster Barcode Reader	Varies
2	98-000103-02	QX-1 Interface Device	€ 196
3	61-000162-02*	QX Cordset, Common, M12 12-Pin Socket (Screw-On)-to-M12 12-Pin Plug (Screw-On), 1m.	€ 92
4	61-000153-02*	QX Cordset, Host, Serial, M12 12-Pin Socket (Screw-On)-to-DB-9 Socket, 1 m.	€ 92
5	61-000152-02*	QX Cordset, Host, Serial, M12 12-Pin Plug (Screw-On)-to-DB-9 Socket, 1 m.	€ 92
6	97-000012-01	Power Supply, 100-240VAC, +24VDC, M12 12-Pin Socket	€ 140
7	61-000160-03*	QX Cordset, Host, Ethernet, M8 8-Pin Plug (Screw-On)-to-RJ45, 1 m.	€ 92
8	99-000020-02	QX Photo Sensor, M12 4-Pin Plug, NPN, Dark On, 2 m.	€ 196
	98-000016-01	Kit, 6 in. Mounting Arm/Adapter, MS-820, QX-830, QX-870	€ 120
	98-000054-01	Kit, Mounting Stand Base Plate	€ 36
	37-000010-01**	Tools Drive, User Documentation, Software	€ 30

* Cordsets available in multiple lengths

** One free per order.

MICROSCAN.

MicroHAWK Auto ID Barcode Readers



- World's smallest industrial barcode readers
- Read any code on any surface
- User-friendly barcode reading platform
- Customizable hardware options

Features	ID-20	ID-30	ID-40
1D Omnidirectional Barcodes	•	•	•
1D/2D Barcodes	•	•	•
Damaged Barcodes	•	•	•
Direct Part Mark (DPM)		•	•
Enclosure	IP40	IP54	IP65/67
Ethernet TCP/IP, EtherNet/IP™			•
Ethernet over USB	•	•	
Serial (RS-232)		•	•
USB 2.0 High Speed / HID	•	•	
Power over Ethernet (PoE)			•
Outer Illumination		•	•
Liquid Lens Autofocus		•	•
Standard or High-Density	•	•	•
Color Sensor	•	•	•
High-Speed		•	•
WebLink User Interface	•	•	•



SENSOR:
WVGA, SXGA
or QSXGA



DECODER:
Standard, Plus,
or X-Mode



SPEED:
Standard or
High-Speed



LENS:
Standard or
High-Density



LIGHTING:
Inner/Outer;
Red or White LEDs

****Important Pricing Discount Note**** Product discounts are applied based on the Product TYPE code shown in the TYPE column below.

Product Type codes are defined as: P = PRODUCT Discount, A = ACCESSORY Discount.

A Product Type code modified with L signifies Legacy Status (refer to Legacy section of this catalog).

Refer to your Partner Agreement for the actual discount percentage by Product Type.

MICRO HAWK

MICROSCAN.
WEBLINK

To customize your MicroHAWK, please use the MicroHAWK Builder (automated version available on OMS).

3 Sensor Options

- WVGA 0.3MP
- SXGA 1.2MP
- QSXGA 5MP

3 Decoder Options

- 1D Labels Standard
- 1D/2D Labels Plus
- 1D/2D Labels+DPM X-Mode

2 Speed Options

- Standard 10 frames/second
- High Max frame rate of sensor

2 Lens Options

- Standard Density
- High Density
- Ultra-High Density

3 Illumination Options

- Inner
- Outer Red
- Outer White
- Outer Blue
- Outer IR

ID-20 Series Readers Standard Configurations



IP40 enclosure
Micro-USB connector (USB only)
5VDC
M2 mounting holes

MicroHAWK ID-20 Series Readers

Part Number	Description	List Price	Type
7211-1102-0000	MICROHAWK,ID-20,WVGA,SD,102MM,RED	€ 462	P
7211-1102-0004	MICROHAWK,ID-20,WVGA,SD 102MM,RED,HS,P	€ 928	P
7211-1102-0005	MICROHAWK,ID-20,WVGA,SD 102MM,RED,HS,X	€ 1,206	P
7212-1102-0000	MICROHAWK,ID-20,SXGA,SD,102MM,RED	€ 742	P
7212-1102-0005	MICROHAWK,ID-20,SXGA,SD,102MM,RED,HS,X	€ 1,486	P
7212-2102-0002	MICROHAWK,ID-20,SXGA,HD,102MM,RED,P	€ 834	P
7212-3064-0003	MICROHAWK,ID-20,SXGA,UHD,64MM,X	€ 1,208	P
7212-3400-0003	MICROHAWK,ID-20,SXGA,UHD,400MM,X	€ 1,208	P

Standard configurations above. Customize ID-20 on the Partner Portal.

Note: Above ID-20 models include 6ft USB 2.0 power cable.

ID-30 Series Readers Standard Configurations



Compact size, corner cable design
IP54 enclosure
DB-15 connector (USB, Serial, I/O)
5V DC
Status Indicators
Added Illumination Option
M3 Mounting holes

MicroHAWK ID-30 Series Readers

Part Number	Description	List Price	Type
7311-1000-1005	MICROHAWK,ID-30,WVGA,SD,AUTOFOCUS,RED,HS,X	€ 1,768	P
7311-2000-1005	MICROHAWK,ID-30,WVGA,HD,AUTOFOCUS,RED,HS,X	€ 1,768	P
7312-1000-1005	MICROHAWK,ID-30,SXGA,SD,AUTOFOCUS,RED,HS,X	€ 1,954	P
7312-2000-1005	MICROHAWK,ID-30,SXGA,HD,AUTOFOCUS,RED,HS,X	€ 1,954	P
7312-3000-2005	MICROHAWK,ID-30,SXGA,UHD AUTOFOCUS,WHT,HS,X	€ 2,140	P
7312-5000-2005	MICROHAWK,ID-30,SXGA,UHD ,PLZ,AF,WHT,HS,X	€ 2,232	P
7311-1102-1005	MICROHAWK,ID-30,WVGA,SD,102MM,RED,HS,X	€ 1,486	P
7311-2102-1003	MICROHAWK,ID-30,WVGA,HD,102MM,RED,X	€ 1,114	P
7311-2102-1005	MICROHAWK,ID-30,WVGA,HD,102MM,RED,HS,X	€ 1,486	P
7312-1102-1005	MICROHAWK,ID-30,SXGA,SD,102MM,RED,HS,X	€ 1,766	P
7312-2102-1003	MICROHAWK,ID-30,SXGA,HD,102MM,RED,X	€ 1,394	P
7312-2102-1005	MICROHAWK,ID-30,SXGA,HD,102MM,RED,HS,X	€ 1,766	P
7312-3064-1005	MICROHAWK,ID-30,SXGA,UHD,64MM,RED,HS,X	€ 1,860	P
7312-3400-1005	MICROHAWK,ID-30,SXGA,UHD,400MM,RED,HS,X	€ 1,860	P

Standard configurations above. Customize ID-30 on the Partner Portal.

ID-40 Series Readers Standard Configurations



Industrial IP65/67 Enclosure
M12 connectors
Serial, TCP/IP and Ethernet IP
Isolated I/O
5-30VDC
Side and Bottom M3 Mounting holes

Part Number	Description	List Price	Type
7411-1000-1005	MICROHAWK, ID-40, WVGA, SD, AUTOFOCUS, RED, HS, X	€ 1,954	P
7411-2000-1005	MICROHAWK, ID-40, WVGA, HD, AUTOFOCUS, RED, HS, X	€ 1,954	P
7412-1000-1005	MICROHAWK, ID-40, SXGA, SD, AUTOFOCUS, RED, HS, X	€ 2,326	P
7412-2000-1005	MICROHAWK, ID-40, SXGA, HD, AUTOFOCUS, RED, HS, X	€ 2,326	P
7412-3000-2005	MICROHAWK, ID-40, SXGA, UHD AUTOFOCUS, WHT, HS, X	€ 2,418	P
7412-5000-2005	MICROHAWK, ID-40, SXGA, UHD , PLZ, AF, WHT, HS, X	€ 2,510	P
7411-1102-0000	MICROHAWK, ID-40, WVGA, SD, 102MM	€ 928	P
7412-1102-0000	MICROHAWK, ID-40, SXGA, SD, 102MM	€ 1,206	P
7411-1102-1005	MICROHAWK, ID-40, WVGA, SD, 102MM, RED, HS, X	€ 1,766	P
7411-2102-1005	MICROHAWK, ID-40, WVGA, HD, 102MM, RED, HS, X	€ 1,766	P
7412-1102-1005	MICROHAWK, ID-40, SXGA, SD, 102MM, RED, HS, X	€ 2,046	P
7412-2102-1005	MICROHAWK, ID-40, SXGA, HD, 102MM, RED, HS, X	€ 2,046	P
7412-3064-1005	MICROHAWK, ID-40, SXGA, UHD, 64MM, RED, HS, X	€ 2,140	P
7412-3400-1005	MICROHAWK, ID-40, SXGA, UHD, 400MM, RED, HS, X	€ 2,140	P

Standard configurations above. Customize ID-40 on the Partner Portal.

MicroHAWK Smart Part Numbering

To customize your MicroHAWK, please use the Smart Part Numbering table (automated version available on OMS).

18 Standard Configurations; over 1,700 possible options.

MicroHAWK Smart Part Numbering

Part Number Format: 7ABX-YZZZ-LPPP-CCC
7 - MicroHAWK

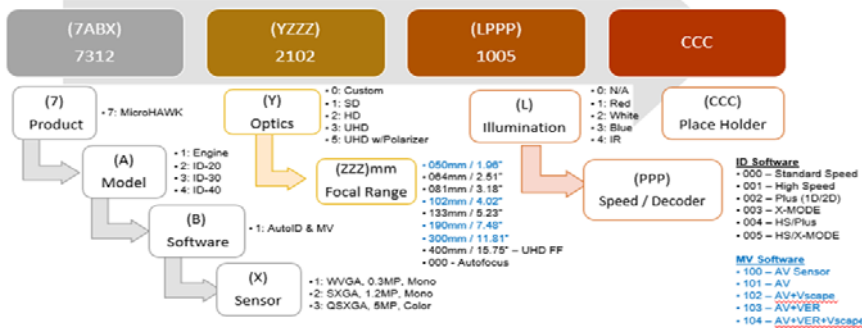

Example Part Number: 7312-2102-1005
Description: ID-30, SXGA, HD, 4" Fixed Focus, Red LEDs, HS, X-Mode

Notes:

- LED (L): additional LEDs provide extra illumination
 - base level illumination is always included with each model
- Decoder (PPP): basic level decoding is always included with each model
 - Included: 1D (omni-directional)
 - Plus: the standard decoder option includes both 1D and 2D, for printed labels
 - X-Mode: is full decoder package; 1D, 2D, and DPM, and damaged codes
- Field Upgrades: Speed, Decoder and Illumination are field upgradeable via licenses or purchase of illumination kit.

Part Description Legend

SD= STANDARD DENSITY LENS
HD= HIGH DENSITY LENS
RED= RED ILLUM
WHT= WHITE ILLUM
HS= HIGH SPEED
P= PLUS DECODER
X= X-MODE DECODER

Sensor Table

	Pixels (HxV), MP	Shutter	Frame Rate (Standard/High)
WVGA	752x480, 0.3MP, Monochrome	Global	10 fps / 60 fps
SXGA	1280x960, 1.2MP, Monochrome	Global	10 fps / 42 fps
QSXGA	2592x1944, 5MP, Color	Rolling	5 fps

Note: Focus Distance (ZZZ) is factory-set and available in 7 standard options.

Note: For Focus Range and Resolution data for each Focus Distance (ZZZ) setting, please refer to Specification Sheet or User Manual.

MicroHAWK-ID Europe Pricing

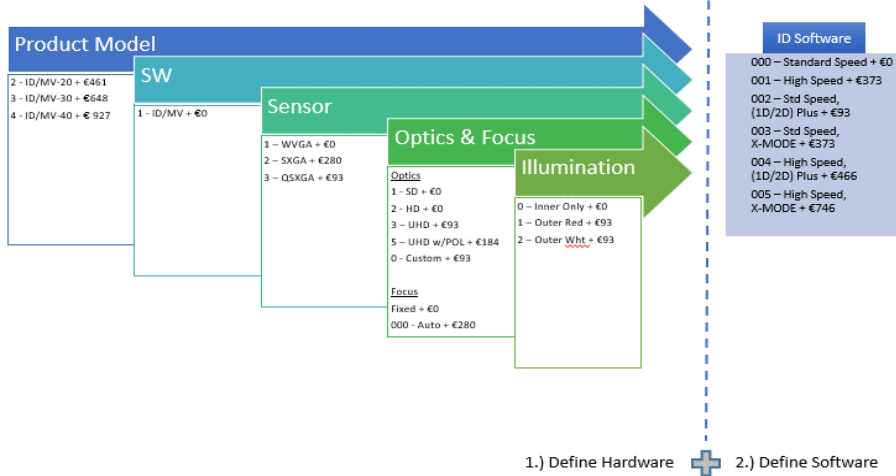

1.) Define Hardware + 2.) Define Software

Note: 1.2MP SXGA uses latest sensor technology, with improved sensitivity.

MicroHAWK Accessories

MicroHAWK MV License Upgrades

Part Number	Description	List Price	Type
LIC-0701-001	LICENSE, AUTOID, HIGH SPEED, MICROHAWK	€ 374	A
LIC-0701-002	LICENSE, AUTOID, PLUS DECODER,1D/2D, MICROHAWK	€ 94	A
LIC-0701-003	LICENSE, AUTOID, DECODER, XMODE, MICROHAWK	€ 374	A
LIC-0701-004	LICENSE, AUTOID, HIGH SPEED,PLUS DECODER 1D/2D, MICROHAWK	€ 466	A
LIC-0701-005	LICENSE, AUTOID, HIGH SPEED, X-MODE, MICROHAWK	€ 746	A

MicroHAWK-20/30 Connectivity Cables

Part Number	Description	List Price	Type
61-9000034-01	CABLE, USB A MALE TO MICRO USB B MALE, 6FT	€ 20	A
61-9000045-01	CABLE, USB A MALE TO MICRO USB B MALE, 3 FT	€ 20	A
61-9000037-01	CABLE,DB15 to EXT PWR/RS232,MICROHAWK-30 (Cable only)	€ 76	A
61-9000038-01	CABLE,DB15 to EXT PWR/USB,MICROHAWK-30 (Cable only)	€ 76	A
61-9000039-01	CABLE,DB15 to EXT PWR/USB,I/O,MICROHAWK-30 (Cable only)	€ 96	A
61-9000043-01	CABLE,DB15 to BUS PWR USB,MICROHAWK-30	€ 66	A
61-9000102-01	CABLE,DB15 TO USB/RS232,TRIGGERED,MICROHAWK-30 (CABLE ONLY)	€ 386	A
61-9000131-01	CABLE, USB/RS232/PWR, MICROHAWK-30, 1M (Cable Only) REQ PWR SUPPLY (97-000011-02)	€ 76	A

MicroHAWK-30 Connectivity Cable Kits

Part Number	Description	List Price	Type
98-9000048-01	KIT, CABLE,DB15 to EXT PWR/RS232,W/PWR SUPPLY,MICROHAWK-30 ** INCLUDES PN:61-9000037-01 and PN:97-9000006-01	€ 106	A
98-9000049-01	KIT, CABLE,DB15 to EXT PWR/USB,W/PWR SUPPLY,MICROHAWK-30 ** INCLUDES PN:61-9000038-01 and PN:97-9000006-01	€ 106	A
98-9000050-01	KIT, CABLE,DB15 to EXT PWR/USB,I/O,W/PWR SUPPLY,MICROHAWK-30 ** INCLUDES PN:61-9000039-01 and PN:97-000011-02 ***RECOMMENDED TO PURCHASE SEPARATELY: (Select one of below, not included with Kit) - PN:99-000019-01,PHOTO SENSOR,VIS,NPN,5VDC,LIGHT ON - PN:61-000151-01,FLYING LEAD CABLE	€ 186	A

MicroHAWK-40 Connectivity Cables

Part Number	Description	List Price	Type
61-000148-02	QX Cordset,Common,M12 12-Pin Socket(Screw-On)-to-M12 12-Pin	€ 96	A
61-000162-02	QX Cordset,Common,M12 12-Pin Socket(Screw-On)-to-M12 12-Pin Plug(Screw-On),1m.	€ 92	A
61-000153-02	QX Cordset, Host, Serial, M12 12-Pin Socket (Screw-On)-to-DB-9 Socket, 1 m.	€ 92	A
61-000164-02	QX Cordset, Host, Serial, M12 12-Pin Socket (Screw-On)-to-DB-9 Socket, 3 m.	€ 96	A
61-000163-03	QX Cordset, Host, Ethernet, M12 8-Pin Plug (Screw-On)-to-RJ45, 3 m.	€ 96	A
61-000160-03	QX Cordset, Host, Ethernet, M8 8-Pin Plug (Screw-On)-to-RJ45, 1 m.	€ 92	A
61-000167-02	QX Cordset, M12 12-Pin Socket (Screw-On)-to-Flying Leads, 3 m.	€ 96	A
61-000226-01	MINI HAWK Xi CORDSET,M12 SOCKET	€ 151	A
61-9000054-01	ASSY, CABLE, M12 12-PIN SOCKET TO 9PIN SOCKET AND M12 PLUG	€ 226	A
61-9000088-01	ASSY,CABLE,,M12 12-PIN SOCKET TO USB KYBRD AND M12 PLUG	€ 386	A

Note: ID-40 compatible with QX series Screw-On cables and accessories (with exception to Ultra Lock, quick disconnect cables).

COMMON CORDSETS (5M) MICROHAWK-40

Part Number	Description	List Price	Type
61-9000133-01	CORDSET, M12 12 PIN SOCKET TO FLYING LEADS, HIGH FLEX, 5M	€ 120	A
61-9000118-01	CORDSET, ETHERNET, M12 8 PIN PLUG TO RJ45, HIGH FLEX, 5M	€ 120	A
61-9000117-01	CORDSET, M12 12 PIN PLUG TO M12 12 PIN SOCKET, HIGH FLEX, 5M	€ 120	A

COMMON CORDSETS (90DEG) MICROHAWK-40

Part Number	Description	List Price	Type
61-000148-03	CORDSET, M12 12 PIN PLUG TO M12 12 PIN SOCKET, RIGHT ANGLE UP, 3M	€ 96	A
61-000148-04	CORDSET, M12 12 PIN PLUG TO M12 12 PIN SOCKET, RIGHT ANGLE UP, 3M	€ 96	A
61-000162-03	CORDSET, M12 12 PIN PLUG TO M12 12 PIN SOCKET, RIGHT ANGLE DOWN, 1M	€ 92	A
61-000162-04	CORDSET, M12 12 PIN PLUG TO M12 12 PIN SOCKET, RIGHT ANGLE UP, 1M	€ 92	A
61-000167-03	CORDSET, M12 12 PIN SOCKET TO FLYING LEADS, RIGHT ANGLE DOWN, 3M	€ 96	A
61-000167-04	CORDSET, M12 12 PIN SOCKET, FLYING LEADS, RIGHT ANGLE UP, 3M	€ 96	A
61-000160-04	CORDSET, M12 8 PIN PLUG TO RJ45 ETHERNET, RIGHT ANGLE DOWN, 1M	€ 92	A
61-000160-05	CORDSET, M12 8 PIN PLUG TO RJ45 ETHERNET, RIGHT ANGLE UP, 1M	€ 92	A
61-000163-04	M12 8 PIN PLUG TO RJ45 ETHERNET, RT ANG,	€ 96	A
61-000163-05	CORDSET, M12 8 PIN PLUG TO RJ45 ETHERNET, RIGHT ANGLE UP, 3M	€ 96	A

MicroHAWK Power Supplies

Part Number	Description	List Price	Type
97-9000006-01	Power Supply, 5V for use with 61-9000037-01 & 61-9000038-01 cables	€ 36	A
97-000011-02	Power Supply, 100-240VAC, +5VDC, 2PN PLG, USA/EUR Plug	€ 94	A
97-000012-01	Power Supply, 100-240VAC, +24VDC, M12 12-pin Socket	€ 140	A

Note: 97-000011-02 is for ID-30 with cable 61-9000039-01 & kit 98-9000050-01

MicroHAWK Mounting

Part Number	Description	List Price	Type
98-9000034-01	KIT, ADAPTER, MS-4 to MICROHAWK-20	€ 46	A
98-9000041-01	KIT, L BRACKET, MICROHAWK	€ 46	A
98-9000047-01	KIT, 1/4-20 CAMERA MOUNT, MICROHAWK	€ 26	A
98-9000052-01	KIT, MOUNTING STAND, MS-3, MS-4, MINI, MICROHAWK, 4"	€ 86	A
98-9000053-01	KIT, MOUNTING STAND, MS-3, MS-4, MINI, MICROHAWK, 3"	€ 86	A
98-9000054-01	KIT, MOUNTING, APG, MS-4, MINI, MICROHAWK	€ 104	A
98-9000059-01	KIT, ADAPTER PLATE, MICROHAWK 20/30/40 TO MINI	€ 96	A

MicroHAWK Accessories

Part Number	Description	List Price	Type
98-9000051-01	KIT, WINDOW, MICROHAWK-30/40	€ 36	A
98-9000043-01	KIT, DIFFUSER, MICROHAWK-30/40	€ 76	A
98-9000129-01	KIT, POLARIZER, MICROHAWK 30/40, EXTERNAL	€ 126	A
98-9000132-01	KIT, ESD-SAFE WINDOW, MICROHAWK	€ 121	A
98-9000131-01	KIT, YAG FILTER, MICROHAWK	€ 126	A
98-9000083-01	KIT, RED FILTER, MICROHAWK, 30 & 40	€ 76	A
98-9000084-01	KIT, BLUE FILTER, MICROHAWK, 30 & 40	€ 76	A
98-9000045-02	KIT, RED LED, MICROHAWK 30/40	€ 126	A
98-9000046-01	KIT, WHITE LED, MICROHAWK-30/40	€ 126	A
98-9000160-01	KIT, BLUE LED, MICROHAWK 30 & 40	€ 126	A
98-9000159-01	KIT, IR LED, MICROHAWK 30 & 40	€ 126	A
98-9000057-01	KIT, RA MIRROR, MICROHAWK 20	€ 120	A
98-9000058-01	KIT, RA MIRROR, MICROHAWK, 30 & 40	€ 120	A
98-9000064-01	KIT, ISOLATION MOUNTING, M3, MICROHAWK ID-30/40	€ 16	A

Stand Alone Configurations

Note: Daisy-Chain Configurations are currently not available.

ID-20 Series Imagers

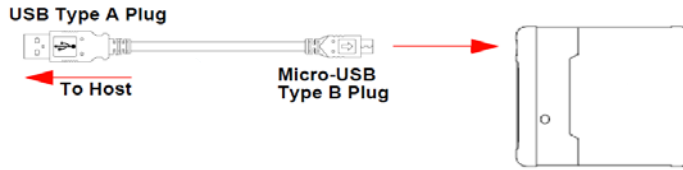

ID-30 Series Imagers

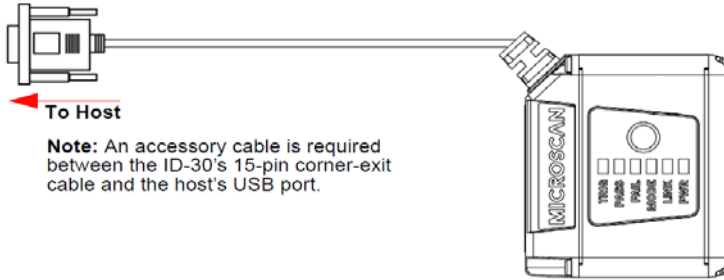

ID-40 Series Imagers

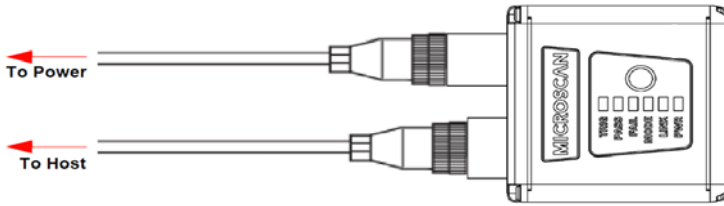

Tech Reference MicroHAWK ID-20

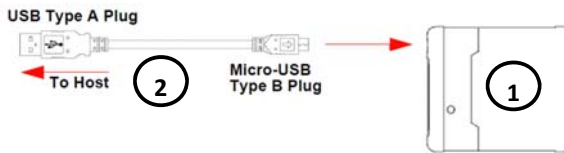

System Matrix

Product	Reference No. & Description	List Price
1	MicroHAWK ID-20	Varies
2	61-9000034-01, CABLE,USB A to MicroB,6FT,MICROHAWK-20	€ 20
2	61-9000045-01, CABLE,USB A to MicroB,3FT,MICROHAWK-20	€ 20

Tech Reference MicroHAWK ID-30

Stand Alone with DB-15 to BUS PWR USB Type A

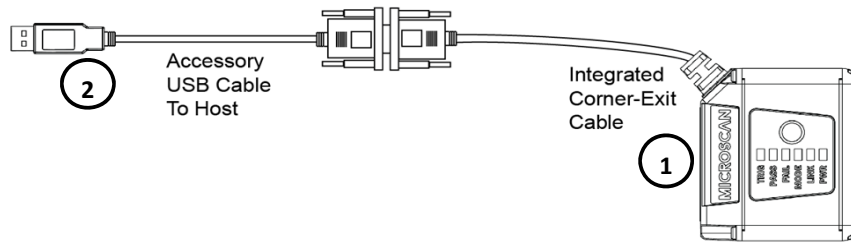

System Matrix

Product	Reference No. & Description	List Price
1	MicroHAWK ID-30	Varies
2	61-9000043-01, CABLE,DB15 to BUS PWR USB,MICROHAWK-30	€ 66

Note: Bus powered cable delivers reduced illumination..."approximately 30% less brightness"

Note: Does not include I/O interface option: trigger cable with photo-sensor, or flying lead cable

Stand Alone with DB15 to EXT PWR/USB Type A

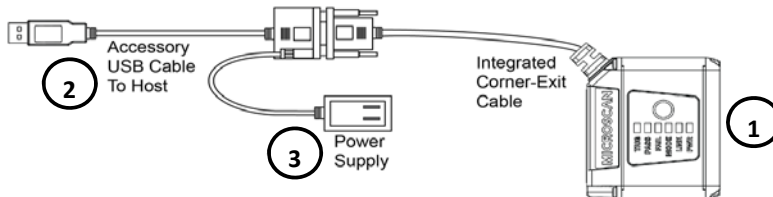

System Matrix

Product	Reference No. & Description	List Price
1	MicroHAWK ID-30	Varies
2	61-9000038-01, CABLE,DB15 to EXT PWR/USB,MICROHAWK-30	€ 76
3	97-9000006-01, POWER SUPPLY,5V,for PN:61-9000037-01 &	€ 36
	98-9000049-01, KIT,CABLE,DB15 to EXT PWR/USB,W/PWR SUPPLY,MICROHAWK-30	€ 106

Note: Does not include I/O interface option: trigger cable with photo-sensor, or flying lead cable

Stand Alone with DB15 to EXT PWR/RS232

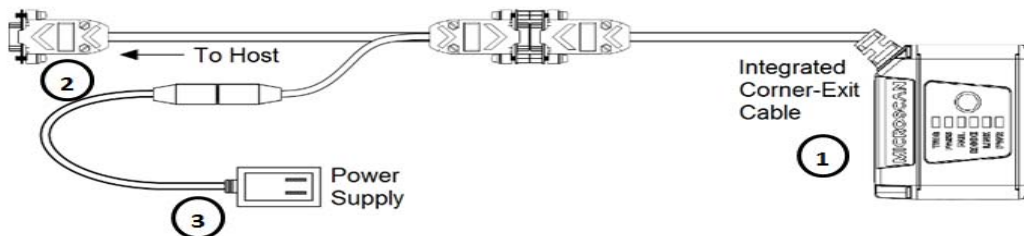

System Matrix

Product	Reference No. & Description	List Price
1	MicroHAWK ID-30	Varies
2	61-9000037-01,CABLE,DB15 to EXT PWR/RS232,MICROHAWK-30 (Cable only)	€ 76
3	97-9000006-01, POWER SUPPLY,5V,for PN:61-9000037-01 & PN:61-9000038-01	€ 36
	98-9000048-01, KIT,CABLE,DB15 to EXT PWR/RS232,W/PWR SUPPLY,MICROHAWK-30	€ 106

Note: Does not include I/O interface option: trigger cable with photo-sensor, or flying lead cable

Note: RS232 Connector to host is a standard DB-9

Stand Alone with DB15 to EXT PWR/USB,I/O

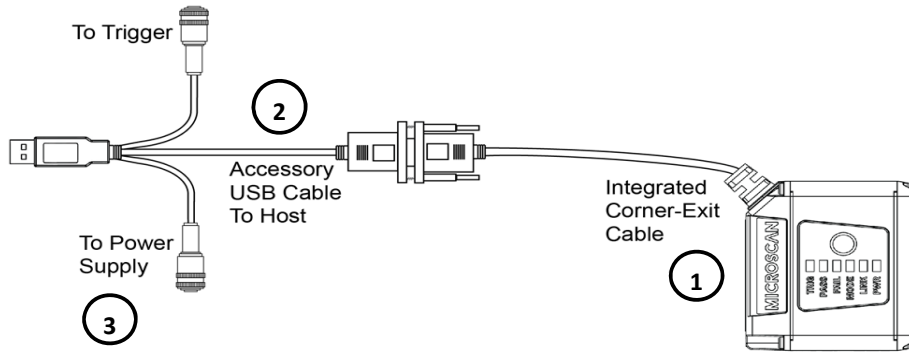

System Matrix

Product	Reference No. & Description	List Price
1	MicroHAWK ID-30	Varies
2	61-9000039-01, CABLE,DB15 to EXT PWR/USB,I/O,	€ 96
3	97-000011-02, Power Supply, 100-240VAC, +5VDC, 2-Pin Plug, U.S./Euro Plug	€ 94
	98-9000050-01, KIT,CABLE,DB15 to EXT PWR/USB,I/O,W/PWR SUPPLY,MICROHAWK-30	€ 186

Stand Alone with IB-131 and IC-332

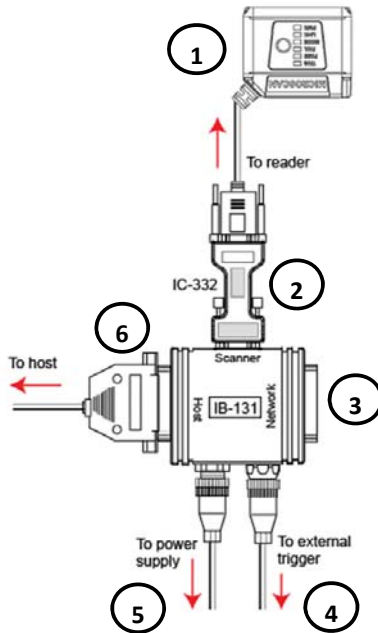

System Matrix

Product	Reference No. & Description	List Price
1	MicroHAWK ID-30	Varies
2	FIS-0001-0035G, Converter, IC-332, 24V/5V, Opto I/O, for Use with IB-131	€ 184
3	99-000018-01, IB-131 Interface Box	€ 184
4	99-000019-01, Photo Sensor, Visible, NPN, Light On, 5VDC	€ 196
5	97-000012-02, Power Supply, 100-240VAC, +24VDC, TRK 3-Pin, U.S./Euro Plug)	€ 154
6	61-300026-03, Cable, Communication, DB-25 Plug-to-DB-9 Socket, 6 ft.	€ 36

Stand Alone with QX-1 Interface

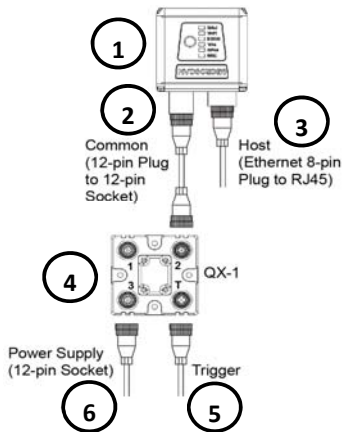

System Matrix

Product	Reference No. & Description	List Price
1	MicroHAWK ID-40	Varies
2	61-000162-02, QX Cordset, Common, M12 12-Pin Socket (Screw-On)-to-M12 12-Pin Plug (Screw-On), 1m.	€ 92
3	61-000160-03, QX Cordset, Host, Ethernet, M12 8-Pin Plug (Screw-On)-to-RJ45, 1 m.	€ 92
4	98-000103-02, QX-1 Interface Device	€ 196
5	97-000012-01, Power Supply, 100-240VAC, +24VDC, M12 12-Pin Socket	€ 140
6	99-000020-01, QX Photo Sensor, M12 4-Pin Plug, NPN, Dark Off, 2 m.	€ 196
6	99-000020-02, QX Photo Sensor, M12 4-Pin Plug, NPN, Dark, On, 2 m.	€ 196

MICROSCAN

MS-2D Scan Engine



MS-2D Scan Engine with Bracket and integrated Decode Board



MS-2D Scan Engine with Tabs and separate Decode Board

Best Sellers
1) FIS-MS2D-0002G
2) FIS-MS2D-0004G

READ RANGE TABLE

Narrow-Bar	Read Range
STANDARD DENSITY	
1D	
.0050" (.127 mm)	3.7 to 5.0" (94 to 127 mm)
.0075" (.191 mm)	2.2 to 6.5" (56 to 165 mm)
.010" (.254 mm)	1.5 to 8.0" (38 to 203 mm)
.020" (.508 mm)	2.3 to 15.5" (58 to 394 mm)
2D	
.0050" (.127 mm)	3.7 to 4.6" (94 to 117 mm)
.0075" (.191 mm)	1.5 to 6.0" (38 to 152 mm)
.010" (.254 mm)	1.6 to 7.1" (41 to 180 mm)
.020" (.508 mm)	1.6 to 10.5" (41 to 267 mm)

Note: Subject to change. Working ranges are a combination of both wide angle and high density fields

****Important Pricing Discount Note**** Product discounts are applied based on the Product TYPE code shown in the TYPE column below.

Product Type codes are defined as: P = PRODUCT Discount, A = ACCESSORY Discount.

A Product Type code modified with L signifies Legacy Status (refer to Legacy section of this catalog).

Refer to your Partner Agreement for the actual discount percentage by Product Type.

Note: MS-2D Engines must be ordered in multiples of 10pc. List Price 1pc each.

MS-2D Scan Engine

Part Number	Description	List Price	Type
FIS-MS2D-0001G	MS-2D Engine, USB, Tabs, 12 in. Ribbon, Standard Focus	€ 274	A
FIS-MS2D-0002G	MS-2D Engine, USB, Bracket, 12 in. Ribbon, Standard Focus	€ 288	A
FIS-MS2D-0003G	MS-2D Engine, Serial, Tabs, 12 in. Ribbon, Standard Focus	€ 274	A
FIS-MS2D-0004G	MS-2D Engine, Serial, Bracket, 12 in. Ribbon, Standard Focus	€ 288	A

Note: MS-2D Engines must be ordered in multiples of 10 units.

Note: Ribbon cables must be ordered in multiples of 10pc. List Price 1pc each.

Accessories

Part Number	Description	List Price	Type
61-000209-01	MS-2D Ribbon Cable, Engine-to-Host, 2 in.	€ 10	A
61-000209-02	MS-2D Ribbon Cable, Engine-to-Host, 6 in.	€ 12	A
61-000209-03	MS-2D Ribbon Cable, Engine-to-Host, 12 in.	€ 14	A
98-000224-01	MS-2D Demo Kit, USB	€ 600	A
98-000224-02	MS-2D Demo Kit, Serial	€ 600	A

Note: MS-2D Ribbon Cables must be ordered in multiples of 10 units.

Software / Manuals

Part Number	Description	List Price	Type
37-000010-01*	Tools Drive, User Documentation, Software	€ 30	A

* One free per order.

MICROSCAN

MINI Hawk Series of Imagers



High Resolution (HR) Specification

Narrow-bar-width		Field of View (maximum)	Read Range (with autofocus)
1D	2D		
Ultra High Density			
.0033" (0.08 mm)	.005" (.13 mm)	2.2" (56 mm)	2.0 to 4.4" (51 mm to 112 mm)
.0075" (0.19 mm)	.010" (.25 mm)	3.6" (91 mm)	1.9 to 6.7" (48 mm to 170 mm)
.015" (0.38 mm)	.020" (.51 mm)	4.0" (102 mm)	1.9 to 7.7" (48 mm to 196 mm)
High Density			
.005" (0.13 mm)	.0075" (.19 mm)	3.1" (79 mm)	1.5 to 6.0" (38 mm to 152 mm)
.0075" (0.19 mm)	.010" (.25 mm)	4.2" (107 mm)	1.2 to 8.0" (30 mm to 203 mm)
.015" (0.38 mm)	.020" (.51 mm)	5.6" (142 mm)	0.9 to 10.5" (23 mm to 267 mm)
Standard Density			
.005" (0.13 mm)	.0075" (.19 mm)	3.2" (81 mm)	1.8 to 3.5" (46 mm to 89 mm)
.0075" (0.19 mm)	.010" (.25 mm)	4.2" (107 mm)	1.6 to 5.0" (41 mm to 127 mm)
.010" (0.25 mm)	.015" (.38 mm)	6.8" (173 mm)	1.4 to 7.5" (36 mm to 191 mm)
.020" (0.51 mm)	.030" (.76 mm)	9.5" (241 mm)	1.0 to 11.0" (25 mm to 279 mm)

Best Sellers
1) FIS-6300-4009G
2) FIS-6300-4008G
3) FIS-6300-5006G
4) FIS-6300-5005G

High speed (HS) specification

Narrow-bar-width		Field of View (maximum)	Read Range (with autofocus)
1D	2D		
Ultra-High Density			
.0033" (.08 mm)	.005" (.13 mm)	1.6" (40 mm)	1.9 to 4.4" (47 mm to 110 mm)
.0075" (.19 mm)	.010" (.25 mm)	2.5" (64 mm)	1.7 to 6.7" (42 mm to 170 mm)
.015" (.38 mm)	.020" (.51 mm)	2.9" (74 mm)	1.5 to 8.0" (38 mm to 203 mm)
Standard Density			
.005" (.13 mm)	.0075" (.19 mm)	2.8" (72 mm)	1.6 to 4.4" (41 mm to 112 mm)
.0075" (.19 mm)	.010" (.25 mm)	3.8" (97 mm)	1.5 to 6.2" (38 mm to 157 mm)
.010" (.25 mm)	.015" (.38 mm)	4.7" (118 mm)	1.4 to 7.6" (36 mm to 193 mm)
.020" (.51 mm)	.030" (.76 mm)	6.2" (158 mm)	1.3 to 10.0" (33 mm to 254 mm)

Listed above is the read range chart for MINI Hawk (Xi) Imagers. See MINI Hawk 3MP section for additional specifications

****Important Pricing Discount Note** Product discounts are applied based on the Product TYPE code shown in the TYPE column below.**

Product Type codes are defined as: P = PRODUCT Discount, A = ACCESSORY Discount.

A Product Type code modified with L signifies Legacy Status (refer to Legacy section of this catalog).

Refer to your Partner Agreement for the actual discount percentage by Product Type.

MINI Hawk ESD Safe



Performance specifications match MINI Hawk High Resolution.

MINI Hawk ESD Safe Imagers

Part Number	Description	List Price	Type
FIS-6300-1011G	MINI Hawk Imager, SD, ESD Safe, RS-232/RS-422/RS-485, 5VDC	€ 2,092	P
FIS-6300-1012G	MINI Hawk Imager, HD, ESD Safe, RS-232/RS-422/RS-485, 5VDC	€ 2,092	P
FIS-6300-1013G	MINI Hawk Imager, Ultra HD, ESD Safe, RS-232/RS-422/RS-485, 5VDC	€ 2,092	P

MICROSCAN

MINI Hawk 3MP



3MP Specification

Narrow-bar-width		Field of View (maximum)	Read Range (using autofocus)
1D	2D		
Micro Density			
.0028" (.07mm)	.0033" (.08 mm)	1.2" (30.4 mm)	1.9 to 2.0" (48.3 mm to 50.8 mm)
.0033" (.08 mm)	.005" (.13 mm)	4" (101.6 mm)	1.9 to 5.1" (48.3 mm to 129.5 mm)
.0075" (.19 mm)	.010" (.25 mm)	4.5" (114.3 mm)	1.7 to 5.6" (43.2 mm to 142.2 mm)
.015" (.38 mm)	.020" (.51 mm)	5.0" (127 mm)	1.7 to 6" (43.2 mm to 152.4 mm)
Standard Density			
.0033" (.08 mm)	.005" (.13 mm)	3.2" (81.3 mm)	1.9 to 3" (48 mm to 76.2 mm)
.005" (.13 mm)	.0075" (.19 mm)	5.0" (127 mm)	1.8 to 4.8" (46 mm to 121.9 mm)
.0075" (.19 mm)	.010" (.25 mm)	6.2" (157.5 mm)	1.6 to 6.5" (41 mm to 165.1 mm)
.010" (.25 mm)	.015" (.38 mm)	8.5" (215.9 mm)	1.4 to 8.5" (36 mm to 215.9 mm)
.020" (.51 mm)	.030" (.76 mm)	9.5" (241 mm)	1.0 to 10" (25 mm to 254 mm)

MINI Hawk 3MP Imagers

Part Number	Description	List Price	Type
FIS-6300-2013G	MINI Hawk Imager, 3 Megapixel Imager, Micro Density, Serial, 5VDC	€ 2,514	P
FIS-6300-2014G	MINI Hawk Imager, 3 Megapixel Imager, SD, Serial, 5VDC	€ 2,514	P
FIS-6300-2015G*	MINI Hawk Imager, 3 Megapixel Imager, Micro Density, USB & I/O, 5VDC	€ 2,602	P
FIS-6300-2016G*	MINI Hawk Imager, 3 Megapixel Imager, SD, USB & I/O, 5VDC	€ 2,602	P

* Cable terminated with USB type A connector. Includes required power supply.

MINI Hawk High Resolution



MINI Hawk High Resolution

Part Number	Description	List Price	Type
FIS-6300-4007G	MINI Hawk Imager, High Resolution, SD, Serial, 5VDC	€ 1,824	P
FIS-6300-4008G	MINI Hawk Imager, High Resolution, HD, Serial, 5VDC	€ 1,824	P
FIS-6300-4009G	MINI Hawk Imager, High Resolution, Ultra HD, Serial, 5VDC	€ 1,824	P
FIS-6300-4010G*	MINI Hawk Imager, High Resolution, SD, USB & I/O, 5VDC	€ 1,912	P
FIS-6300-4011G*	MINI Hawk Imager, High Resolution, HD, USB & I/O, 5VDC	€ 1,912	P
FIS-6300-4012G*	MINI Hawk Imager, High Resolution, Ultra HD, USB & I/O, 5VDC	€ 1,912	P

* Cable terminated with USB type A connector. Includes required power supply.

MINI Hawk High Speed



MINI Hawk High Speed Imagers

Part Number	Description	List Price	Type
FIS-6300-5005G	MINI Hawk Imager, High Speed, SD, Serial, 5VDC	€ 1,824	P
FIS-6300-5006G	MINI Hawk Imager, High Speed, Ultra HD, Serial, 5VDC	€ 1,824	P
FIS-6300-5007G*	MINI Hawk Imager, High Speed, SD, USB & I/O, 5VDC	€ 1,912	P
FIS-6300-5008G*	MINI Hawk Imager, High Speed, Ultra HD, USB & I/O, 5VDC	€ 1,912	P

* Cable terminated with USB type A connector. Includes required power supply.

MINI Hawk Accessories

Accessories

Part Number	Description	List Price	Type
FIS-0210-0001G	MS-Connect 210, Connectivity Box with Display	€ 820	A
FIS-0210-0002G	MS-Connect 210, Connectivity Box	€ 558	A
FIS-0210-0003G	MS-Connect 210, Connectivity Box with Display & Ethernet	€ 932	A
FIS-0210-0004G	MS-Connect 210, Connectivity Box with Ethernet	€ 820	A
98-000013-04	Relay Module,120VAC,3 Amp Output,Series 70,Type SM,for MS-Connect 210 + MS-890	€ 56	A
98-000013-05	Relay Module,240VAC,3 Amp Output,Series 70,Type SM for MS-Connect 210 + MS-890	€ 56	A
98-000013-06	Relay Module, 24VDC, 3 Amp Output, Series 70, Type SM, for MS-Connect 210,MS-890	€ 56	A
61-000127-02	Cable, MS-2-to-MS-Connect 210, 6 ft.	€ 112	A
FIS-0001-0035G	Converter, IC-332, 24V/5V, Opto I/O, for Use with IB-131	€ 184	A
99-000018-01	IB-131 Interface Box	€ 184	A
61-300026-03	Cable, Communication, DB-25 Plug-to-DB-9 Socket, 6 ft.	€ 36	A
61-100029-03	Cable, Daisy Chain, IB-131	€ 36	A
61-000011-02	Extension Cable, Reader-to-IB-131 (MS-2, MS-3, MS-4, MS-9, MS-710, MS-820, MINI)	€ 36	A
61-000151-01	Cable, MINI USB, I/O Breakout, Flying Leads, 3 ft.	€ 36	A
98-000098-01	Kit, MINI Diffuser	€ 56	A
98-000086-02*	Demo Kit, MINI Hawk	€ 656	A

* This Demo Kit does not contain a reader and is discounted 25%. The separately purchased reader is discounted 60%.

Power Supply

Part Number	Description	List Price	Type
97-000011-02	Power Supply,100-240VAC,+5VDC, 2PN PLG, USA/EUR Plug	€ 94	A
97-000012-01	Power Supply, 100-240VAC, +24VDC, M12 12-pin Socket	€ 140	A
97-000012-02	Power Supply (100-240 VAC, +24VDC, TRK 3Pin, USA/Euro Plug)	€ 154	A

Mounting and Connectors

Part Number	Description	List Price	Type
98-000048-01	Kit, Mounting Arm/Adapter, 4 in., for MS-2, MS-3	€ 78	A
98-000054-01	Kit, Mounting Stand Base Plate	€ 36	A
98-000053-01	Mounting Arm Extension Kit, 4 in., for MS-3, MS-4, MINI	€ 40	A
98-000053-02	Mounting Arm Extension Kit, 3 in., for MS-2, MS-3, MS-4, MINI	€ 40	A
98-000060-01	Kit, Bracket, Side Mount, MS-2, MS-3, MINI	€ 24	A
98-000059-01	Kit, Bracket, Angle Mount, MS-2, MS-3, MINI	€ 24	A
98-000057-02	Kit, Bracket, Through-Hole Mount, MS-2, MS-3, MINI	€ 24	A
98-000088-01	Kit, Right Angle Mirror, MS-4/MINI Hawk/Vision MINI	€ 56	A
20-610024-01	Trigger Connector, 4-Pin Plug (Screw Terminal, Field-Wireable) (Self-Wiring)	€ 36	A
20-610020-01	Power Conn.,3-Pin Socket (Screw Term.,Field-Wireable for Custom IB-131 Wiring)	€ 36	A
99-000055-01	Bracket, Smart Series DOAL-50 mm-to-Vision MINI & MINI Hawk	€ 256	A
99-000057-01	Bracket, Smart Series DOAL-75 mm-to-Vision MINI & MINI Hawk	€ 256	A
99-000059-01	Bracket, Smart Series DOAL-100 mm-to-Vision MINI & MINI Hawk	€ 256	A
99-000053-01	Bracket, Smart Series Ring-60/70 mm-to-Vision MINI & MINI Hawk	€ 138	A
99-000054-01	Bracket, Smart Series Ring-100 mm-to-Vision MINI & MINI Hawk	€ 138	A

Package Detector/Sensor

Part Number	Description	List Price	Type
99-000017-01	Photo Sensor, Visible, NPN, Dark ON	€ 196	A
99-000017-02	Photo Sensor, Visible, NPN, Light ON	€ 196	A
99-000019-01	Photo Sensor, Visible, NPN, Light On, 5VDC	€ 196	A

Software/Manuals

Part Number	Description	List Price	Type
37-000010-01*	Tools Drive, User Documentation, Software	€ 30	A

*One free per order

MICROSCAN

Verification Kits



Best Sellers	
1)	SLN-0000005
2)	SLN-0000006

****Important Pricing Discount Note**** Product discounts are applied based on the Product TYPE code shown in the TYPE column below.

Product Type codes are defined as: P = PRODUCT Discount, A = ACCESSORY Discount.

A Product Type code modified with L signifies Legacy Status (refer to Legacy section of this catalog).

Refer to your Partner Agreement for the actual discount percentage by Product Type.

Verification Kits

Part Number	Description	List Price	Type
SLN-0000004	Dot Peen Verif. Kit (Cables Not Included)	€ 4,688	P
SLN-0000005	1D/2D LABEL Verification Kit	€ 5,864	P
SLN-0000006	LARGE LINEAR Verification Kit	€ 6,586	P
SLN-0000018	Large Linear Verif. Kit with VMI & Accessories	€ 10,108	P

NOTE: Software is included on the TOOLS DRIVE. Order as a separate item.

Accessories

Part Number	Description	List Price	Type
97-000012-01	Power Supply, 100-240VAC, +24VDC, M12 12-pin Socket	€ 140	A
98-000103-02	QX-1 Interface Device	€ 196	A
61-000148-01	QX Cordset, Common, M12 12-Pin Socket(Ult.Lock)-to-M12 12-Pin Plug(Ult.Lock),3m.	€ 74	A
61-000148-02	QX Cordset, Common, M12 12-Pin Socket(Screw-On)-to-M12 12-Pin Plug(Screw-On),3m.	€ 96	A
61-000204-01	QX Cordset, Smart Series Light-to-QX-1, Continuous Power	€ 206	A
61-000218-01	QX Cordset, Smart series light to QX-1, strobe, NPN	€ 132	A
99-000020-02	QX Photo Sensor, M12 4-Pin Plug, NPN, Dark On, 2 m.	€ 196	A

Software/Manuals

Part Number	Description	List Price	Type
37-000010-01	Tools Drive, User Documentation, Software	€ 30	A
98-000217-05	AV to Verif. & VMI License Upgrade	€ 2,750	A

Tech Reference Verification Kits

The required accessories are an Ethernet cable for the camera, a power supply,

The minimum set of accessories required to complete a bench-top installation follows.

Item	Function	Part Number	Description
1	Camera/Light Power Supply	97-000012-01	Power Supply, 100-240VAC, +24 VDC, M12 12-pin Socket (Screw-On)
2	Connection Block	98-000103-02	QX-1 Connection Block
3	Ethernet Cable	61-000183-03	QX Cordset, Host, Ethernet, M12 8-pin Plug (Screw-On) to RJ45, 3 m
4	Camera Power and Signal Cable	61-000148-02	QX Cordset, Common, M12 12-pin, Socket (Screw-On) to M12 12-pin Plug (Screw-On), 3 m
5	Continuous Lighting Cable or	61-000204-01	Cable, Power, Smart Series to QX-1
	Strobe Lighting Cable	61-000218-01	Cable, Smart Series to QX-1, Strobe, NPN
6	Photo Sensor (Optional)	99-000020-02	Trigger, M12 4-pin Plug, NPN, Dark On, 2 m

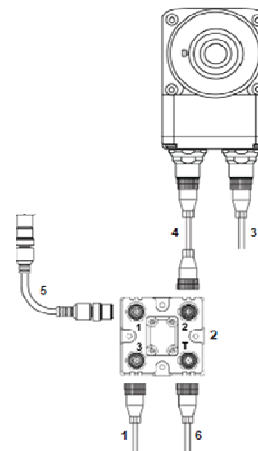

MICROSCAN

LVS-95XX



Best Sellers
9510-5-4.0
9510-5-4.5
9580-C-3

Effective: January 22, 2018 Expiration: March 30, 2018

****Important Pricing Discount Note**** Product discounts are applied based on the Product TYPE code shown in the TYPE column below.

LVS Product Type codes are defined as: VFP = VERIFICATION PRODUCT Discount, A = ACCESSORY Discount.

A Product Type code modified with L signifies Legacy Status (refer to Legacy section of this catalog).

Refer to your Partner Agreement for the actual discount percentage by Product Type.

Verifiers

Part Number	Description	List Price	Type
9510-5-1.75	LVS-9510 Verifier, 1.75" FoV	€ 5,750	VFP
9510-5-3.0	LVS-9510 Verifier, 3" FoV	€ 5,750	VFP
9510-5-4.0	LVS-9510 VERIFIER, 4" FOV	€ 5,750	VFP
9510-5-4.5	LVS-9510 Verifier, 4.5" FoV	€ 5,750	VFP
9510-5-6.250	LVS-9510 Verifier, 6.25" FoV	€ 5,750	VFP
9570-C-5	LVS-9570 Roller, 1D & 2D Codes	€ 5,300	VFP
9570-1D-5	LVS-9570 Roller 1D Codes	€ 3,900	VFP
9580-1D-3	LVS-9580 Handheld, 1D Barcode Verification	€ 3,900	VFP
9580-2D-3	LVS-9580 Handheld, 2D Barcode Verification	€ 4,200	VFP
9580-C-3	LVS-9580 Handheld, 1D & 2D Barcode Verification	€ 5,420	VFP
9580-DPM	LVS-9580 Handheld, 1D, 2D & DPM Barcode Verification	€ 5,995	VFP
9585-DPM	LVS-9585 HANDHELD, 1D, 2D & DPM DOME AND 30 DEGREE LIGHTING	€ 6,745	VFP

NOTE: Software is included on the USB Media shipped with the product.

Accessories

Part Number	Description	List Price	Type
98-CAL020	LVS Calibration Conformance Test Card, 9570/9580/9510 EAN/UPC	€ 470	A
98-CAL021	Calibration Conformance Test Card, 128	€ 470	A
98-CAL010	LVS Calibration Conformance Test Card, Datamatrix	€ 580	A
98-CAL004	Calibration Conformance Test Card, DataBar	€ 470	A
98-SOF0039	LVS-9510 Software Upgrade Option: Multi-Sector Verification	€ 480	A
98-SOF0056	LVS-95xx Software Upgrade Option: Automatic Login Feature	€ 290	A
98-SOF0088	Software Upgrade Option: EAIV (Enhanced Application Identifier Verification)	€ 670	A
98-SOF0069	LVS-9580 Software Upgrade Option: 1D only to both 1D&2D	€ 1,920	A
98-SOF0094	LVS-9580 Software Upgrade Option: 2D only to both 1D&2D	€ 1,920	A
98-SOF0095	LVS-9580 Upgrade (1D/2D to DPM)	€ 910	A
98-SOF0096	LVS-9570 Upgrade (1D to 1D&2D)	€ 1,555	A
98-9000200-01	LVS-9580/9585 ADJUSTABLE STAND MOUNTING FOR USE WITH AMSCOPE BSS-140	€ 268	A

Spare Parts

Part Number	Description	List Price	Type
98-WIN0035	Clear Window Replacement, for LVS-9510 (window only)	€ 120	A
98-WIN0036	Red Window Replacement, for LVS-9510 (window only)	€ 120	A
98-9000090-01	KIT, PRESSURE PLATE, LVS 9510	€ 86	A
98-WIN042	Red Replacement Window for LVS-9580	€ 50	A
98-WIN0044	LVS-9585 Clear Replacement Window	€ 50	A
98-PS107	12V DC POWER SUPPLY FOR LVS-9510	€ 45	A
98-CAB0631	USB 2.0 Cable, 6 ft. for LVS-9570 (with thumbscrews)	€ 50	A
98-CAB0605	USB 2.0 Cable, 6 ft. for LVS-9510	€ 15	A
98-CAB0620	USB 2.0 Cable, 10 Ft. (3m) for LVS-9580	€ 50	A
98-9000162-01	LVS-958x USB 2m cable	€ 50	A

Services

Part Number	Description	List Price	Type
98-LVS0076	LVS-95XX IQ-OQ VALIDATION PROCEDURE GUIDELINES	€ 2,880	A
98-LVS0077	Validation IQ-OQ Guidelines for v. 4.3 and later software (with 25 test cards)	€ 2,880	A
98-LVS-VTC	LVS-95XX Validation Test Cards (IQ-OQ Challenge Labels) for use with 98-LVS0076	€ 480	A
98-LVS-BVS	Barcode Verification Service, (cost per code, 50 EUR set-up fee not included)	€ 25	A
98-LVS00021	LVS Training, Go to Meeting, LVS-9510	€ 770	A
98-LVS00022	LVS Training, Go to Meeting, LVS-9580	€ 770	A
98-LVS00023	LVS Training, Go to Meeting, LVS-9570	€ 995	A
98-12EW-VER	12 MO EXT WARR, LVS-95XX	€ 795	A
98-24EW-VER	24 MO EXT WARR, LVS-95XX	€ 995	A

MICROSCAN.

PanelScan™ PCB Traceability System



PanelScan Wide Configuration (Two Cameras)

****Important Pricing Discount Note**** Product discounts are applied based on the Product TYPE code shown in the TYPE column below.

Product Type codes are defined as: P = PRODUCT Discount, A = ACCESSORY Discount.

A Product Type code modified with L signifies Legacy Status (refer to Legacy section of this catalog).

Refer to your Partner Agreement for the actual discount percentage by Product Type.

PanelScan

Part Number	Description	List Price	Type
SLN-0001010	PanelScan, Standard (10 in.x24 in., 254 mmx609 mm Field of View), White Light	€ 18,136	A
SLN-0001011	PanelScan, Wide (20 in.x24 in., 508 mmx609 mm Field of View), White Light	€ 23,592	A
SLN-0001110	PanelScan, Standard (10 in.x24 in., 254 mmx609 mm Field of View), Red Light	€ 18,136	A
SLN-0001111	PanelScan, Wide (20 in.x24 in., 508 mmx609 mm Field of View), Red Light	€ 23,592	A

1) Standard Kit- includes single camera, lens, single line light, PanelScan software interface, Visionscape software, setup guide, power and Ethernet accessories.

2) Wide Kit- includes 2 cameras, 2 lenses, 2 line lights, PanelScan software interface, Visionscape software, setup guide, power and ethernet accessories.

3) PC, conveyor, mounting structure, and encoder not included

MICROSCAN.

Auto ID Handhelds

HS-21 and HS-41X 2D Handheld Readers

Read Ranges

1D	
5 mil (.127 mm)	3.7" to 5.0" (94 to 127 mm)
7.5 mil (.191 mm)	2.2" to 6.5" (56 to 165 mm)
10 mil (.254 mm)	1.5" to 8.0" (38 to 203 mm)
20 mil (.508 mm)	2.3 to 15.5" (58 to 394 mm)
2D	
5 mil (.127 mm)	3.7" to 4.6" (94 to 117 mm)
7.5 mil (.191 mm)	1.5" to 6.0" (38 to 152 mm)
15 mil (.381 mm)	1.6" to 7.7" (41 to 196 mm)
20 mil (.508 mm)	1.6" o 9.4" (41 to 239 mm)



Best Seller

FIS-HS41X-0001G

****Important Pricing Discount Note**** Product discounts are applied based on the Product TYPE code shown in the TYPE column below.

Product Type codes are defined as: P = PRODUCT Discount, A = ACCESSORY Discount.

A Product Type code modified with L signifies Legacy Status (refer to Legacy section of this catalog).

Refer to your Partner Agreement for the actual discount percentage by Product Type.

HS-21 Reader

Part Number	Description	List Price	Type
FIS-HS21-0001G	HS-21 Handheld Reader, USB, 6 ft. Straight Cable	€ 462	P
FIS-HS21-0005G*	HS-21 2D Handheld Reader, RS232, 8ft. Coiled Cable, no power supply	€ 462	P

Note: HS-21 is offered in light gray.

HS-41X DPM Reader

Part Number	Description	List Price	Type
FIS-HS41X-0001G	HS-41X Handheld DPM Reader, USB, 6 ft. Straight Cable	€ 882	P
FIS-HS41X-0005G*	HS-41X 2D DPM Handheld Reader, RS232, 8ft. Coiled Cable, no power supply	€ 882	P
FIS-HS41X-0006G	HS-41X Handheld DPM Reader, HD, USB, 6 ft. Straight Cable	€ 1,488	P

Note: HS-41X is offered in dark gray.

*Power Supply Sold Separately (see 20-00033X-02 options below)

Accessories

Part Number	Description	List Price	Type
98-000264-01*	Demo Kit, HS-21 & HS-41X, USB, 2 6 ft. Strt. USB Cables, 1 8 ft. Serial Cable	€ 960	P
98-000270-03	Kit, Presentation Stand, HS-21/HS-41X	€ 52	A
98-9000026-01	Kit, Presentation Mount without Stand, HS-21/HS-41X	€ 36	A
61-000224-01	Cable, USB, HS-21/HS-41X, 6 ft., Straight	€ 46	A
61-000224-02	Cable, USB, HS-21/HS-41X, 8 ft., Coiled	€ 46	A
61-000224-03	Cable, RS-232, HS-21/HS-41X, 8 ft., Coiled	€ 40	A
20-000335-02	Power Supply, Handheld Reader, Wall Mount, 90-264 VAC, +5VDC, 1.5A, U.S. Plug	€ 46	A
20-000336-02	Power Supply, Handheld Reader, Wall Mount, 90-264 VAC, +5VDC, 1.5A, Euro Plug	€ 74	A
20-000337-02	Power Supply, Handheld Reader, Wall Mount, 90-264 VAC, +5VDC, 1.5A, UK Plug	€ 90	A

*NOTE: This demo kit contains 2 readers and is discounted at 25%

Software/Manuals

Part Number	Description	List Price	Type
37-000010-01*	Tools Drive, User Documentation, Software	€ 30	A

* 1 free per order.

Tech Reference *HS-21 / HS-41X*

USB and Serial Configuration

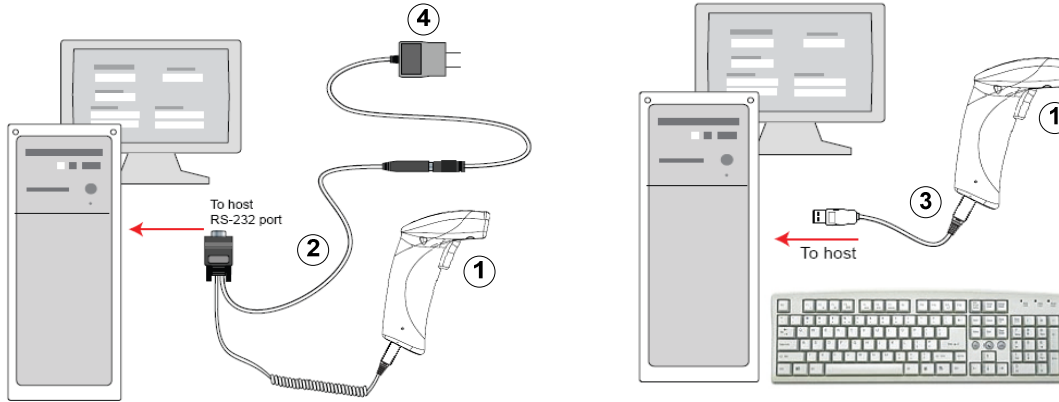

Item	Part Number	Description	List Price
1	FIS-HSX1-0001G	HS-21 / HS-41X Handheld 2D Reader, USB, 6ft Straight Cable	Varies
	OR		
1	FIS-HSX1-0005G	HS-21 / HS-41X Handheld 2D Reader, RS-232, 8ft Coiled Cable	Varies
2	61-000224-03	Cable, RS-232, HS-21/HS-41X, 8 ft., Coiled	€ 40
3	61-000224-01	Cable, USB, HS-21/HS-41X, 6 ft., Straight	€ 46
4	20-00033X-02 **	POWER SUPPLY, WALL MOUNT, 90-264 VAC, +5VDC, 1.5A	Varies
	98-000270-03	Kit, Presentation Stand, HS-21/HS-41X	€ 52
	37-000010-01*	Tools Drive, User Documentation, Software	\$ 30

* One free per order. **Select Supply by Plug type for RS232

MICROSCAN

Auto ID Handhelds

HS-51 and HS-51X 2D Wireless Handheld Readers

Read Ranges

1D	
5 mil (.127 mm)	3.7" to 5.0" (94 to 127 mm)
7.5 mil (.191 mm)	2.2" to 6.5" (56 to 165 mm)
10 mil (.254 mm)	1.5" to 8.0" (38 to 203 mm)
20 mil (.508 mm)	2.3 to 15.5" (58 to 394 mm)
2D	
5 mil (.127 mm)	3.7" to 4.6" (94 to 117 mm)
7.5 mil (.191 mm)	1.5" to 6.0" (38 to 152 mm)
15 mil (.381 mm)	1.6" to 7.7" (41 to 196 mm)
20 mil (.508 mm)	1.6" o 9.4" (41 to 239 mm)



Best Seller
 FIS-HS51X-0002G

****Important Pricing Discount Note**** Product discounts are applied based on the Product TYPE code shown in the TYPE column below.

Product Type codes are defined as: P = PRODUCT Discount, A = ACCESSORY Discount.

A Product Type code modified with L signifies Legacy Status (refer to Legacy section of this catalog).

Refer to your Partner Agreement for the actual discount percentage by Product Type.

HS-51X Reader

Part Number	Description	List Price	Type
FIS-HS51X-0002G**	HS-51X Wireless DPM Handheld with Battery, Bluetooth Charging Base and USB cable	€ 1,572	P

**Wall mount power supply is not included with reader. Please select the appropriate regional power supply from Accessories below.

Accessories

Part Number	Description	List Price	Type
98-9000009-01	HS-51/51X Battery Charger, 4-Bay	€ 256	A
98-9000007-01	HS-51/51X Charging Base Station, USB Only (No Bluetooth)	€ 136	A
98-9000008-01	HS-51/51X Battery, Li-Ion, 1300 mAH	€ 126	A
20-000335-02	Power Supply, Handheld Reader, Wall Mount, 90-264 VAC, +5VDC, 1.5A, U.S. Plug	€ 46	A
20-000337-02	Power Supply, Handheld Reader, Wall Mount, 90-264 VAC, +5VDC, 1.5A, UK Plug	€ 90	A
20-000336-02	Power Supply, Handheld Reader, Wall Mount, 90-264 VAC, +5VDC, 1.5A, Euro Plug	€ 74	A

Software/Manuals

Part Number	Description	List Price	Type
37-000010-01*	Tools Drive, User Documentation, Software	€ 30	A

* 1 free per order.

Tech Reference HS-51 / HS-51X

USB Configuration

Charging Station with Embedded Modem and Wireless Handheld Reader

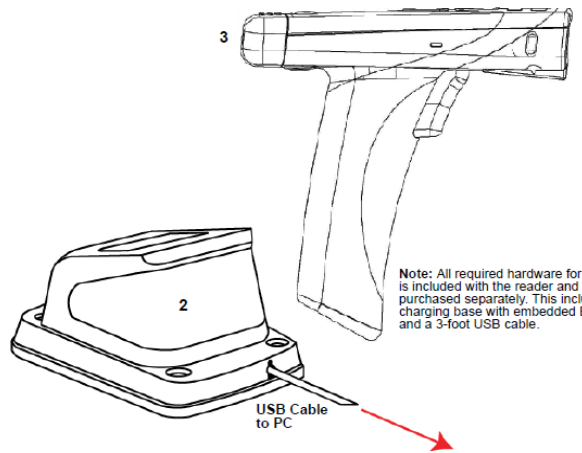

Item	Part Number	Description	List Price
1	FIS-HSX1-XXXXG	HS-51 / HS-51X Handheld 2D Reader	Varies
2	98-9000007-01	HS-51/51X Charging Base Station, USB Only (No Bluetooth)	€ 136
3	98-9000008-01	HS-51/51X Battery, Li-Ion, 1300 mAH	€ 126
	20-000335-02	Power Supply, Handheld Reader, Wall Mount, 90-264 VAC, +5VDC, 1.5A,	€ 46
	20-000337-02	Power Supply, Handheld Reader, Wall Mount, 90-264 VAC, +5VDC, 1.5A,	€ 90
	20-000336-02	Power Supply, Handheld Reader, Wall Mount, 90-264 VAC, +5VDC, 1.5A,	€ 74
	37-000010-01*	Tools Drive, User Documentation, Software	€ 30

* One free per order.

MICROSCAN.

Auto-ID DPM Handhelds

HS-360X Ultra-Rugged High Performance DPM Handheld Reader



Best Seller
HDS-3678-0001

Read Ranges

Data Matrix	
5 mil (.127 mm)	.4" to 2.5" (44 to 64 mm)
10 mil (.254 mm)	.0" to 3.4" (44 to 103 mm)

****Important Pricing Discount Note**** Product discounts are applied based on the Product TYPE code shown in the TYPE column below.
Product Type codes are defined as: P = PRODUCT Discount, A = ACCESSORY Discount.
A Product Type code modified with L signifies Legacy Status (refer to Legacy section of this catalog).
Refer to your Partner Agreement for the actual discount percentage by Product Type.

HS-360X Wired

Part Number	Description	List Price	Type
HDS-3608-0001	HANDHELD DPM SCANNER, CORDED, HDS-3608 **** Wired Cordset Required ****	€ 1,682	P

HS-360X Wired Cordsets

Part Number	Description	List Price	Type
12-9000946-01	CABLE, USB, SHIELDED, 2M, HDS-3600 FAMILY	€ 41	A
12-9000947-01	CABLE, USB, SHIELDED, 4.6M, HDS-3600 FAMILY	€ 59	A

HS-360X Wireless

Part Number	Description	List Price	Type
HDS-3678-0001	HANDHELD DPM SCANNER, CORDLESS, HDS-3678 **** Cradle and Cordset Required ****	€ 2,273	P

HS-360X Wireless Accessories and Cordsets

Part Number	Description	List Price	Type
12-9000937-01	CRADLE / CHARGER, HDS-3678	€ 273	A
12-9000946-01	CABLE, USB, SHIELDED, 2M, HDS-3600 FAMILY	€ 41	A
12-9000947-01	CABLE, USB, SHIELDED, 4.6M, HDS-3600 FAMILY	€ 59	A
12-9000942-01	CABLE, USB, SHIELDED, 2M, EXT 12V, HDS-3600 FAMILY *** Power Supply Required ***	€ 41	A
12-9000943-01	CABLE, USB, SHIELDED, 4.6M, EXT 12V, HDS-3600 FAMILY *** Power Supply Required ***	€ 59	A
98-9000181-01	KIT, POWER SUPPLY FOR CRADLE / CHARGER, HDS-3678 ***A/C Power Cord Required ***	€ 41	A
98-9000185-01	4 SLOT, BATTERY CHARGER, HDS-3678 *** Power Supply Required ***	€ 205	A
98-9000182-01	KIT, POWER SUPPLY FOR BATTERY CHARGER, 4SLOT, HDS-3678 ***A/C Power Cord Required***	€ 59	A
12-9000939-01	BATTERY, SPARE, HDS-3678	€ 59	A

Cordset Kits

Part Number	Description	List Price	Type
98-9000181-01	KIT, POWER SUPPLY FOR CRADLE / CHARGER, HDS-3678 ***A/C Power Cord Required***	€ 59	A
98-9000182-01	KIT, POWER SUPPLY FOR BATTERY CHARGER, 4 SLOT, HDS-3678 ***A/C Power Cord Required***	€ 59	A

A/C Power Cord by Region

Part Number	Description	List Price	Type
12-9000959-01	AC POWER CORD, 2.5M, US, C13 CONN.	€ 15	A
12-9000960-01	AC POWER CORD, 2.5M, EU, C13 CONN.	€ 15	A
12-9000961-01	AC POWER CORD, 2.5M, UK, C13 CONN.	€ 15	A
12-9000962-01	AC POWER CORD, 2.5M, CHINA, C13 CONN.	€ 15	A

Accessories

Part Number	Description	List Price	Type
98-9000186-01	STAND, INTELLIGENT, HS-360X	€ 59	A

NOTE: Demo kits are not available for the HS-360X. A reader, specifically purchased as a demo unit will be discounted 50%.



Intelligent Stand

MICROSCAN

Auto ID Software, Connectivity, and Accessories

MS-Connect Series



Best Sellers

- 1) FIS-0210-0001G
- 2) FIS-0210-0003G

****Important Pricing Discount Note**** Product discounts are applied based on the Product TYPE code shown in the TYPE column below.

Product Type codes are defined as: P = PRODUCT Discount, A = ACCESSORY Discount.

A Product Type code modified with L signifies Legacy Status (refer to Legacy section of this catalog).

Refer to your Partner Agreement for the actual discount percentage by Product Type.

MS-Connect 210 Options

Part Number	Description	List Price	Type
FIS-0210-0001G	MS-Connect 210, Connectivity Box with Display	€ 820	A
FIS-0210-0002G	MS-Connect 210, Connectivity Box	€ 558	A
FIS-0210-0003G	MS-Connect 210, Connectivity Box with Display & Ethernet	€ 932	A
FIS-0210-0004G	MS-Connect 210, Connectivity Box with Ethernet	€ 820	A

Accessories

Part Number	Description	List Price	Type
61-000105-01	Cable, Pre-Stripped-to-9-Pin Host Cable, 6 ft.	€ 32	A
61-000122-01	Cable to MS-Connect 210, Host RS-422/RS-485 for Multidrop, 6 ft.	€ 112	A
61-000123-01	Cable to MS-Connect 210, Host/Aux RS-232 for Daisy Chain, 210-to-210, 6 ft.	€ 112	A
61-000127-02	Cable, MS-2-to-MS-Connect 210, 6 ft.	€ 112	A
FIS-0001-0035G	Converter, IC-332, 24V/5V, Opto I/O, for Use with IB-131	€ 184	A
98-000013-04	Relay Module,120VAC,3 Amp Output,Series 70,Type SM,for MS-Connect 210 + MS-890	€ 56	A
98-000013-05	Relay Module,240VAC,3 Amp Output,Series 70,Type SM for MS-Connect 210 + MS-890	€ 56	A
98-000013-06	Relay Module, 24VDC, 3 Amp Output, Series 70, Type SM, for MS-Connect 210,MS-890	€ 56	A
61-000066-01	Cable, MS-Connect 210-to-MS-Q (Pre-Strip before Wiring)	€ 90	A
61-000158-03	QX Cordset, M12 12-Pin Plug & M12 12-Pin Socket-to-MS-Connect 210 (RS-232), 2 m.	€ 346	A
61-000108-01	Cable, RJ12-to-9-Pin D-sub, 6 ft.	€ 52	A
61-000112-01	Cable, USB Type A Plug-to-Mini-B Plug, 10 ft.	€ 36	A
99-000018-01	IB-131 Interface Box	€ 184	A
98-000040-02	Cable, Interface & Reader, 6 ft., IB-150	€ 196	A
98-000095-02**	Demo Kit, MS-Connect 210	€ 896	A

** This demo kit does not contain the MS-Connect 210 and is discounted 25%. A MS-Connect 210 ordered separately is discounted 60%

Power Supply

Part Number	Description	List Price	Type
97-000012-02	Power Supply (100-240 VAC, +24VDC, TRK 3Pin, USA/Euro Plug)	€ 154	A

Mounting

Part Number	Description	List Price	Type
98-000093-01	Kit, DIN Rail Mounting, MS-Connect 210	€ 52	A

Package Detector/Sensor

Part Number	Description	List Price	Type
99-000017-01	Photo Sensor, Visible, NPN, Dark ON	€ 196	A
99-000017-02	Photo Sensor, Visible, NPN, Light ON	€ 196	A

Software/Manuals

Part Number	Description	List Price	Type
37-000010-01*	Tools Drive, User Documentation, Software	€ 30	A

* 1 free per order.

Stand Alone

These are the setup options for one MS-Connect 210 and one 10-28V or 5V reader.

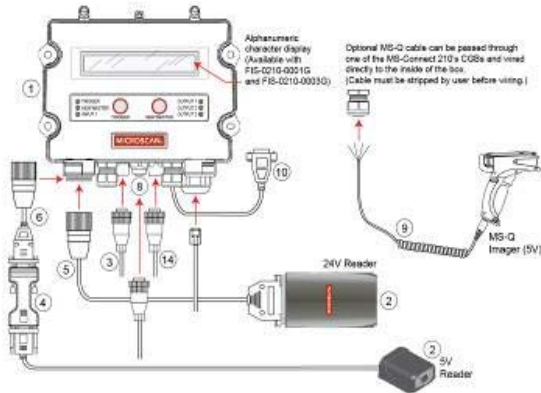

Product	Reference No.	Description	List Price
(1) MS-Connect 210	FIS-0210-0001G	MS-Connect 210, Connectivity Box with Display	€ 820
	FIS-0210-0002G	MS-Connect 210, Connectivity Box	€ 558
	FIS-0210-0003G	MS-Connect 210, Connectivity Box with Display & Ethernet	€ 932
	FIS-0210-0004G	MS-Connect 210, Connectivity Box with Ethernet	€ 820
(2) Microscan Reader	FIS-XXXX-XXXXG	Varies	Varies
(3) Power Supply	97-000012-02	Power Supply, 100-240VAC, +24VDC, TRK 3-Pin, U.S./Euro Plug)	€ 154
(4) IC-332 (5V Readers)	FIS-0001-0035G	Converter, IC-332, 24V/5V, Opto I/O, for Use with IB-131	€ 184
(5) Reader Cable (10-28V Readers)	61-000122-01	Cable to MS-Connect 210, Host RS-422/RS-485 for Multidrop, 6 ft.	€ 112
(6) Reader Cable (5V Readers and MS-9)	61-000127-02	Cable, MS-2-to-MS-Connect 210, 6 ft.	€ 112
(7) Reader Cable (5V Readers and MS-9)	61-000139-01	Cable to MS-Connect 210, Host RS-422/RS-485 for Multidrop, 6 ft.	€ 112
(8) Reader Cable (MS-820 only; not shown)	61-000121-02	Cable, MS-820-to-MS-Connect 210, 3 ft.	€ 36
(9) Internal Ethernet Cable (If applicable)	61-000128-01	Cable, External Micro-Change-to-Internal Ethernet Module, MS-Connect 210, 8 in.	€ 56
(10) MS-Q Reader Cable (If applicable)	61-000066-01	Cable, MS-Connect 210-to-MS-Q (Pre-Strip before Wiring)	€ 90
(11) MS-Connect 210 Host Cable	61-000105-01	Cable, Pre-Stripped-to-9-Pin Host Cable, 6 ft.	€ 32
(12) Pluggable Relay Module (If applicable; not shown)	98-000013-04	Relay Mod., 120VAC, 3A Output, Series 70, Type SM, for MS-Connect 210 & MS-890	€ 56
(13) Pluggable Relay Module (If applicable; not shown)	98-000013-05	Relay Mod., 240VAC, 3A Output, Series 70, Type SM, for MS-Connect 210 & MS-890	€ 56
(14) Pluggable Relay Module (If applicable; not shown)	98-000013-06	Relay Module, 24VDC, 3 Amp Output, Series 70, Type SM, for MS-Connect 210,MS-890	€ 56
(15) Object Detector (If applicable)	99-000017-02	Photo Sensor, Visible, NPN, Light ON	€ 196
DIN Rail Mounting Kit	98-000093-01	Kit, DIN Rail Mounting, MS-Connect 210	€ 52

Tech Reference *MS-Connect 210*

Daisy Chain

Multiple MS-Connect 210s can be used to connect multiple readers in a Daisy Chain configuration. (One MS-Connect 210 per reader.)

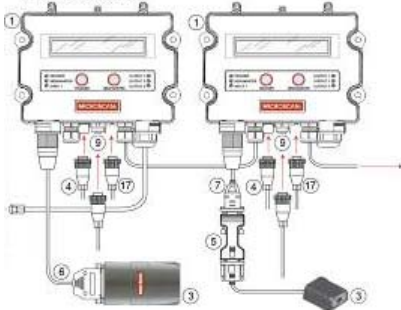

Product	Reference No.	Description	List Price
(1) MS-Connect 210	FIS-0210-0001G	MS-Connect 210, Connectivity Box with Display	€ 820
	FIS-0210-0002G	MS-Connect 210, Connectivity Box	€ 558
	FIS-0210-0003G	MS-Connect 210, Connectivity Box with Display & Ethernet	€ 932
	FIS-0210-0004G	MS-Connect 210, Connectivity Box with Ethernet	€ 820
(3) Microscan Reader	FIS-XXXX-XXXXG	Varies	Varies
(4) Power Supply	97-000012-02	Power Supply, 100-240VAC, +24VDC, TRK 3-Pin, U.S./Euro Plug)	€ 154
(5) IC-332	FIS-0001-0035G	Converter, IC-332, 24V/5V, Opto I/O, for Use with IB-131	€ 184
(6) Reader Cable (10-28V)	61-000122-01	Cable to MS-Connect 210, Host RS-422/RS-485 for Multidrop, 6 ft.	€ 112
(7) Reader Cable (5V Readers and MS-9)	61-000127-02	Cable, MS-2-to-MS-Connect 210, 6 ft.	€ 112
(8) Reader Cable (MS-820 only; not shown)	61-000121-02	Cable, MS-820-to-MS-Connect 210, 3 ft.	€ 36
(9) Internal Ethernet Cable (If applicable)	61-000128-01	Cable, External Micro-Change-to-Internal Ethernet Module, MS-Connect 210, 8 in.	€ 56
(11) MS-Connect 210 Host Cable (not shown)	61-000105-01	Cable, Pre-Stripped-to-9-Pin Host Cable, 6 ft.	€ 32
(14) Pluggable Relay Module (If applicable; not shown)	98-000013-04	Relay Mod., 120VAC, 3A Output, Series 70, Type SM, for MS-Connect 210 & MS-890	€ 56
(15) Pluggable Relay Module (If applicable; not shown)	98-000013-05	Relay Mod., 240VAC, 3A Output, Series 70, Type SM, for MS-Connect 210 & MS-890	€ 56
(16) Pluggable Relay Module (If applicable; not shown)	98-000013-06	Relay Module, 24VDC, 3 Amp Output, Series 70, Type SM, for MS-Connect 210,MS-890	€ 56
(17) Object Detector (If applicable)	99-000017-02	Photo Sensor, Visible, NPN, Light ON	€ 196
DIN Rail Mounting Kit	98-000093-01	Kit, DIN Rail Mounting, MS-Connect 210	€ 52

Auto ID Product Accessories

Best Sellers

Right Angle Mirror Kits

1) FIS-0001-0035G

Part Number	Description	List Price	Type
98-200026-02	Kit, Right Angle Mirror, MS-820/QX-830	€ 84	A
98-200036-01	Kit, Right Angle Mirror, MS-9	€ 84	A
98-000088-01	Kit, Right Angle Mirror, MS-4/MINI Hawk/Vision MINI	€ 56	A
98-000058-02	Kit, Extended Right Angle Mirror, MS-2, MS-3	€ 56	A

Package Detector/Sensor

Part Number	Description	List Price	Type
99-000017-01	Photo Sensor, Visible, NPN, Dark ON	€ 196	A
99-000017-02	Photo Sensor, Visible, NPN, Light ON	€ 196	A
99-000019-01	Photo Sensor, Visible, NPN, Light On, 5VDC	€ 196	A
99-000004-01	Package Detector, Standard Diffuse, 120 in. Range, 4-Pin Plug	€ 250	A
99-000004-02	Package Detector, Standard Diffuse, 120 in. Range, Underterminated	€ 250	A
99-000020-02	QX Photo Sensor, M12 4-Pin Plug, NPN, Dark On, 2 m.	€ 196	A
99-000020-01	QX Photo Sensor, M12 4-Pin Plug, NPN, Dark Off, 2 m.	€ 196	A

Cable / Connectivity

Part Number	Description	List Price	Type
61-000010-02	Cable, Communication, DB-9 Socket-to-DB-9 Socket, 6 ft.	€ 36	A
61-000011-02	Extension Cable, Reader-to-IB-131 (MS-2, MS-3, MS-4, MS-9, MS-710, MS-820, MINI)	€ 36	A
61-000034-02	Cable, Communication/Serial, 25-Pin Socket-to-9-Pin Socket, 6 ft.	€ 32	A
61-100029-03	Cable, Daisy Chain, IB-131	€ 36	A
61-300026-03	Cable, Communication, DB-25 Plug-to-DB-9 Socket, 6 ft.	€ 36	A
98-000040-02	Cable, Interface & Reader, 6 ft., IB-150	€ 196	A
61-000112-01	Cable, USB Type A Plug-to-Mini-B Plug, 10 ft.	€ 36	A
61-000151-01	Cable, MINI USB, I/O Breakout, Flying Leads, 3 ft.	€ 36	A

Connector Kits

Part Number	Description	List Price	Type
20-610024-01	Trigger Connector, 4-Pin Plug (Screw Terminal, Field-Wireable) (Self-Wiring)	€ 36	A
20-610020-01	Power Conn., 3-Pin Socket (Screw Term., Field-Wireable for Custom IB-131 Wiring)	€ 36	A

Power Supplies

Part Number	Description	List Price	Type
97-000011-02	Power Supply, 100-240VAC, +5VDC, 2PN PLG, USA/EUR Plug	€ 94	A
97-000012-02	Power Supply (100-240 VAC, +24VDC, TRK 3Pin, USA/Euro Plug)	€ 154	A
97-000012-01	Power Supply, 100-240VAC, +24VDC, M12 12-pin Socket	€ 140	A
97-000012-04	QX Power Supply, 24V, M12 12 pin Plug, USA /Euro Plug	€ 136	A

Interface Boxes

Part Number	Description	List Price	Type
98-000014-02	Kit, IB-131/MS-820 Connectivity	€ 214	A
99-000018-01	IB-131 Interface Box	€ 184	A
99-000008-02	IB-150 Interface Box	€ 166	A
99-000009-02	Interconnectivity, IB-151, RS-232, Ethernet TCP/IP	€ 112	A
FIS-0001-0035G	Converter, IC-332, 24V/5V, Opto I/O, for Use with IB-131	€ 184	A
98-000051-01	IC-3USB Interface Kit, USB-to-Serial, 15-Pin	€ 94	A
FIS-0001-0030G	IB-3PC Keyboard Wedge/Interface Box	€ 166	A
98-9000022-01	IB-3USB, USB Keyboard Wedge, 9600 bps, 9-Pin	€ 150	A
98-9000022-02	IB-3USB, USB Keyboard Wedge, 38.4K bps, 9-Pin	€ 150	A
99-420003-04	Accessory, Wiring Box, IB-890	€ 352	A
98-000103-02	QX-1 Interface Device	€ 196	A
61-000204-01	QX Cordset, Smart Series Light-to-QX-1, Continuous Power	€ 206	A

Mounting Components

Part Number	Description	List Price	Type
Mounting Arm Kits			
98-000016-01	Kit, 6 in. Mounting Arm/Adapter, MS-820, QX-830, QX-870	€ 120	A
98-000017-01	Mounting Arm/Adapter Kit, IB-890, 6 in.	€ 100	A
98-000018-01	Mounting Arm/Adapter Kit, MS-890, 6 in.	€ 100	A
98-000019-01	Mounting Stand Kit, MS-911, 6"	€ 100	A
98-000048-01	Kit, Mounting Arm/Adapter, 4 in., for MS-2, MS-3	€ 78	A
Extension Arm Kits			
98-000037-01	Mounting Arm Extension Kit, 6 in., All Readers	€ 62	A
98-000053-01	Mounting Arm Extension Kit, 4 in., for MS-3, MS-4, MINI	€ 40	A
98-000053-02	Mounting Arm Extension Kit, 3 in., for MS-2, MS-3, MS-4, MINI	€ 40	A
Base Plates			
98-000046-01	Large Base Plate, 12 in.x12 in.	€ 46	A
98-000054-01	Kit, Mounting Stand Base Plate	€ 36	A
Standard Mounting Plates			
98-000092-01	Kit, Mounting Plate, MS-9	€ 24	A
98-500006-01	Kit, Mounting Plate, MS-710, MS-820, QX-830, QX-870	€ 24	A
98-200037-01	Kit, Mounting Plate, MS-890	€ 46	A
98-000060-01	Kit, Bracket, Side Mount, MS-2, MS-3, MINI	€ 24	A
98-000059-01	Kit, Bracket, Angle Mount, MS-2, MS-3, MINI	€ 24	A
98-000057-02	Kit, Bracket, Through-Hole Mount, MS-2, MS-3, MINI	€ 24	A

* Through-hole mounting plate; not for use with mounting arm.

Software / Manuals

Part Number	Description	List Price	Type
37-000010-01*	Tools Drive, User Documentation, Software	€ 30	A

* 1 free per order.

MICROSCAN.

MicroHAWK Machine Vision Smart Cameras



MICRO HAWK



Features	MV-20	MV-30	MV-40
Barcode Reading (1D/2D)	●	●	●
Complete Machine Vision	●	●	●
Enclosure	IP40	IP54	IP65/67
PROFINET®			●
Ethernet TCP/IP, EtherNet/IP™			●
Ethernet over USB	●	●	
Serial RS-232		●	●
USB 2.0 High Speed / HID	●	●	
Power over Ethernet (PoE)			●
Outer Illumination		●	●
Liquid Lens Autofocus		●	●
Color Sensor	●	●	●
AutoVISION® Sensor Software	●	●	●
AutoVISION® Software	●	●	●
Visionscape® Software	●	●	●

To customize your MicroHAWK, please use the MicroHAWK Builder (automated version available on OMS).

3 Sensor Options

- WVGA 0.3MP
- SXGA 1.2MP
- QSXGA 5MP

2 Lens Options

- Standard Density
- High Density
- Ultra-High Density

2 Focus Options

- Fixed Focus
- Autofocus

3 Illumination Options

- Inner
- Outer Red
- Outer White
- Outer Blue
- Out IR

5 License Levels

- AutoVISION Sensor
- AutoVISION
- AutoVISION + Verification
- AutoVISION + Visionscape
- AutoVISION + Verification + Visionscape

****Important Pricing Discount Note**** Product discounts are applied based on the Product TYPE code shown in the TYPE column below.

Product Type codes are defined as: P = PRODUCT Discount, A = ACCESSORY Discount.

A Product Type code modified with L signifies Legacy Status (refer to Legacy section of this catalog).

Refer to your Partner Agreement for the actual discount percentage by Product Type.

MV-20 Series Smart Cameras Standard Configurations



IP40 enclosure
Micro-USB connector (USB only)
5VDC
M2 mounting holes

MicroHAWK MV-20 Smart Cameras			List Price	Type
Part Number	Description			
7211-1102-0100	MICROHAWK, MV-20, WVGA, SD, 102MM, AV SENSOR	€	1,114	P
7211-1102-0101	MICROHAWK, MV-20, WVGA, SD, 102MM, AV	€	1,486	P
7211-1102-0102	MICROHAWK, MV-20, WVGA, SD, 102MM, AV+VS	€	1,860	P
7212-2102-0101	MICROHAWK, MV-20, SXGA, HD, 102MM, AV	€	1,766	P
7212-2102-0102	MICROHAWK, MV-20, SXGA, HD, 102MM, AV+VS	€	2,138	P
7212-2102-0103	MICROHAWK, MV-20, SXGA, HD, 102MM, AV+VERIF./OCV	€	2,138	P
7212-2102-0104	MICROHAWK, MV-20, SXGA, HD, 102MM, AV+VERIF./OCV+VS	€	2,418	P
7213-1102-0100	MICROHAWK, MV-20, QSXGA, SD, 102MM, AV SENSOR	€	1,206	P
7213-1102-0101	MICROHAWK, MV-20, QSXGA, SD, 102MM, AV	€	1,580	P
7213-1102-0102	MICROHAWK, MV-20, QSXGA, SD, 102MM, AV+VS	€	1,954	P
7212-3064-0102	MICROHAWK, MV-20, SXGA, UHD, 64MM, AV+VS	€	2,234	P
7212-3400-0102	MICROHAWK, MV-20, SXGA, UHD, 400MM, AV+VS	€	2,234	P

Standard configurations above. Customize MV-20 on the Partner Portal.

Note: Above MV-20 models include 6ft USB 2.0 power cable.

MV-30 Series Smart Cameras

Standard Configurations



Compact size, corner cable design
 IP54 enclosure
 DB-15 connector (USB, Serial, I/O)
 5V DC
 Status Indicators
 Added Illumination Option
 M3 Mounting holes

MicroHAWK MV-30 Smart Cameras			List Price	Type
Part Number	Description			
7311-1102-1100	MICROHAWK, MV-30, WVGA, SD, 102MM, RED, AV SENSOR	€	1,394	P
7311-1102-1101	MICROHAWK, MV-30, WVGA, SD, 102MM, RED, AV	€	1,766	P
7311-1102-1102	MICROHAWK, MV-30, WVGA, SD, 102MM, RED, AV+VS	€	2,138	P
7311-2190-1101	MICROHAWK, MV-30, WVGA, HD, 190MM, RED, AV	€	1,766	P
7311-2190-1102	MICROHAWK, MV-30, WVGA, HD, 190MM, RED, AV+VS	€	2,138	P
7311-2190-1103	MICROHAWK, MV-30, WVGA, HD, 190MM, RED, AV+VERIF./OCV	€	2,138	P
7311-2190-1104	MICROHAWK, MV-30, WVGA, HD, 190MM, RED, AV+VERIF./OCV+VS	€	2,418	P
7311-1000-1100	MICROHAWK, MV-30, WVGA, SD, AUTOFOCUS, RED, AV SENSOR	€	1,674	P
7311-1000-1101	MICROHAWK, MV-30, WVGA, SD, AUTOFOCUS, RED, AV	€	2,046	P
7311-1000-1102	MICROHAWK, MV-30, WVGA, SD, AUTOFOCUS, RED, AV+VS	€	2,418	P
7312-1102-1100	MICROHAWK, MV-30, SXGA, SD, 102MM, RED, AV SENSOR	€	1,674	P
7312-1102-1101	MICROHAWK, MV-30, SXGA, SD, 102MM, RED, AV	€	2,046	P
7312-1102-1102	MICROHAWK, MV-30, SXGA, SD, 102MM, RED, AV+VS	€	2,418	P
7312-2190-1101	MICROHAWK, MV-30, SXGA, HD, 190MM, RED, AV	€	2,046	P
7312-2190-1102	MICROHAWK, MV-30, SXGA, HD, 190MM, RED, AV+VS	€	2,418	P
7312-2190-1103	MICROHAWK, MV-30, SXGA, HD, 190MM, RED, AV+VERIF./OCV	€	2,418	P
7312-2190-1104	MICROHAWK, MV-30, SXGA, HD, 190MM, RED, AV+VERIF./OCV+VS	€	2,698	P
7312-3064-1102	MICROHAWK, MV-30, SXGA, UHD, 64MM, RED, AV+VS	€	2,514	P
7312-3400-1102	MICROHAWK, MV-30, SXGA, UHD, 400MM, RED, AV+VS	€	2,514	P
7312-3064-2102	MICROHAWK, MV-30, SXGA, UHD, 64MM, WHT, AV+VS	€	2,514	P
7312-3400-2102	MICROHAWK, MV-30, SXGA, UHD, 400MM, WHT, AV+VS	€	2,514	P
7312-2000-1101	MICROHAWK, MV-30, SXGA, HD, AUTOFOCUS, RED, AV	€	2,326	P
7312-2000-1102	MICROHAWK, MV-30, SXGA, HD, AUTOFOCUS, RED, AV+VS	€	2,698	P
7312-2000-1103	MICROHAWK, MV-30, SXGA, HD, AUTOFOCUS, RED, AV+VERIF./OCV	€	2,698	P
7312-2000-1104	MICROHAWK, MV-30, SXGA, HD, AUTOFOCUS, RED, AV+VERIF./OCV + VS	€	2,978	P
7312-3000-1102	MICROHAWK, MV-30, SXGA, UHD, AUTOFOCUS, RED, AV+VS	€	2,792	P
7312-3000-2102	MICROHAWK, MV-30, SXGA, UHD, AUTOFOCUS, WHT, AV+VS	€	2,792	P
7313-1102-2100	MICROHAWK, MV-30, QSXGA, SD, 102MM, WHT, AV SENSOR	€	1,486	P
7313-1102-2101	MICROHAWK, MV-30, QSXGA, SD, 102MM, WHT, AV	€	1,860	P
7313-1102-2102	MICROHAWK, MV-30, QSXGA, SD, 102MM, WHT, AV+VS	€	2,232	P
7313-2190-2101	MICROHAWK, MV-30, QSXGA, HD, 190MM, WHT, AV	€	1,860	P
7313-2190-2102	MICROHAWK, MV-30, QSXGA, HD, 190MM, WHT, AV+VS	€	2,232	P
7313-1000-2100	MICROHAWK, MV-30, QSXGA, SD, AUTOFOCUS, WHT, AV SENSOR	€	1,766	P
7313-1000-2101	MICROHAWK, MV-30, QSXGA, SD, AUTOFOCUS, WHT, AV	€	2,138	P
7313-1000-2102	MICROHAWK, MV-30, QSXGA, SD, AUTOFOCUS, WHT, AV+VS	€	2,512	P
7313-2000-2101	MICROHAWK, MV-30, QSXGA, HD, AUTOFOCUS, WHT, AV	€	2,138	P
7313-2000-2102	MICROHAWK, MV-30, QSXGA, HD, AUTOFOCUS, WHT, AV+VS	€	2,512	P
7312-2000-2106	MICROHAWK, MV-30, SXGA, HD, AF, WHT, AV/VER/OCV/VS/HS/XM/DUAL BOOT	€	3,070	P

Standard configurations above. Customize MV-30 on the Partner Portal.

MV-40 Series Smart Cameras Standard Configurations



MicroHAWK MV-40 Smart Cameras			List Price	Type
Part Number	Description			
7411-1102-1100	MICROHAWK, MV-40, WVGA, SD, 102MM, RED, AV SENSOR	€	1,674	P
7411-1102-1101	MICROHAWK, MV-40, WVGA, SD, 102MM, RED, AV	€	2,046	P
7411-1102-1102	MICROHAWK, MV-40, WVGA, SD, 102MM, RED, AV+VS	€	2,418	P
7411-2190-1101	MICROHAWK, MV-40, WVGA, HD, 190MM, RED, AV	€	2,046	P
7411-2190-1102	MICROHAWK, MV-40, WVGA, HD, 190MM, RED, AV+VS	€	2,418	P
7411-2190-1103	MICROHAWK, MV-40, WVGA, HD, 190MM, RED, AV+VERIF./OCV	€	2,418	P
7411-2190-1104	MICROHAWK, MV-40, WVGA, HD, 190MM, RED, AV+VERIF./OCV+VS	€	2,698	P
7411-1000-1100	MICROHAWK, MV-40, WVGA, SD, AUTOFOCUS, RED, AV SENSOR	€	1,954	P
7411-1000-1101	MICROHAWK, MV-40, WVGA, SD, AUTOFOCUS, RED, AV	€	2,326	P
7411-1000-1102	MICROHAWK, MV-40, WVGA, SD, AUTOFOCUS, RED, AV+VS	€	2,698	P
7412-1102-1100	MICROHAWK, MV-40, SXGA, SD, 102MM, RED, AV SENSOR	€	1,954	P
7412-1102-1101	MICROHAWK, MV-40, SXGA, SD, 102MM, RED, AV	€	2,326	P
7412-1102-1102	MICROHAWK, MV-40, SXGA, SD, 102MM, RED, AV+VS	€	2,698	P
7412-2190-1101	MICROHAWK, MV-40, SXGA, HD, 190MM, RED, AV	€	2,326	P
7412-2190-1102	MICROHAWK, MV-40, SXGA, HD, 190MM, RED, AV+VS	€	2,698	P
7412-2190-1103	MICROHAWK, MV-40, SXGA, HD, 190MM, RED, AV+VERIF./OCV	€	2,698	P
7412-2190-1104	MICROHAWK, MV-40, SXGA, HD, 190MM, RED, AV+VERIF./OCV+VS	€	2,978	P
7412-3064-1102	MICROHAWK, MV-40, SXGA, UHD, 64MM, RED, AV+VS	€	2,792	P
7412-3400-1102	MICROHAWK, MV-40, SXGA, UHD, 400MM, RED, AV+VS	€	2,792	P
7412-3064-2102	MICROHAWK, MV-40, SXGA, UHD, 64MM, WHT, AV+VS	€	2,792	P
7412-3400-2102	MICROHAWK, MV-40, SXGA, UHD, 400MM, WHT, AV+VS	€	2,792	P
7412-2000-1101	MICROHAWK, MV-40, SXGA, HD, AUTOFOCUS, RED, AV	€	2,606	P
7412-2000-1102	MICROHAWK, MV-40, SXGA, HD, AUTOFOCUS, RED, AV+VS	€	2,978	P
7412-2000-1103	MICROHAWK, MV-40, SXGA, HD, AUTOFOCUS, RED, AV+VERIF./OCV	€	2,978	P
7412-2000-1104	MICROHAWK, MV-40, SXGA, HD, AUTOFOCUS, RED, AV+VERIF./OCV + VS	€	3,256	P
7412-3000-1102	MICROHAWK, MV-40, SXGA, UHD, AUTOFOCUS, RED, AV+VS	€	3,072	P
7412-3000-2102	MICROHAWK, MV-40, SXGA, UHD, AUTOFOCUS, WHT, AV+VS	€	3,072	P
7413-1102-2100	MICROHAWK, MV-40, QSXGA, SD, 102MM, WHT, AV SENSOR	€	1,766	P
7413-1102-2101	MICROHAWK, MV-40, QSXGA, SD, 102MM, WHT, AV	€	2,138	P
7413-1102-2102	MICROHAWK, MV-40, QSXGA, SD, 102MM, WHT, AV+VS	€	2,512	P
7413-2190-2101	MICROHAWK, MV-40, QSXGA, HD, 190MM, WHT, AV	€	2,138	P
7413-2190-2102	MICROHAWK, MV-40, QSXGA, HD, 190MM, WHT, AV+VS	€	2,512	P
7413-1000-2100	MICROHAWK, MV-40, QSXGA, SD, AUTOFOCUS, WHT, AV SENSOR	€	2,046	P
7413-1000-2101	MICROHAWK, MV-40, QSXGA, SD, AUTOFOCUS, WHT, AV	€	2,418	P
7413-1000-2102	MICROHAWK, MV-40, QSXGA, SD, AUTOFOCUS, WHT, AV+VS	€	2,792	P
7413-2000-2101	MICROHAWK, MV-40, QSXGA, HD, AUTOFOCUS, WHT, AV	€	2,418	P
7413-2000-2102	MICROHAWK, MV-40, QSXGA, HD, AUTOFOCUS, WHT, AV+VS	€	2,792	P
7412-2000-2106	MICROHAWK, MV-40, SXGA, HD, AF, WHT, AV/VER/OCV/VS/HS/XM/DUAL BOOT	€	3,346	P

Standard configurations above. Customize MV-40 on the Partner Portal.

MicroHAWK Smart Part Numbering

To customize your MicroHAWK, please use the Smart Part Numbering table (automated version available on OMS).

18 Standard Configurations; over 932 possible options.

MicroHAWK Smart Part Numbering

Part Number Format: 7ABX-YZZZ-LPPP-CCC
7 = MicroHAWK

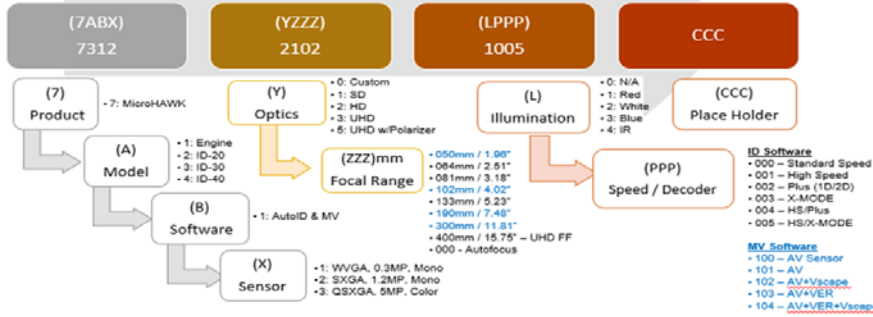

Example Part Number: 7312-2102-1005
Description: ID-30, SXGA, HD, 4" Fixed Focus, Red LEDs, HS, X-Mode

Notes:

- LED (L): Additional Outer LEDs provide extra illumination. Base level illumination is always included with each model
- MV License Bundle (PPP): MV Licenses are field upgradable
- Focus Distance (ZZZ): Focus distance is factory settable. 50 mm, 102 mm, 190 mmm and 300 mm are standard for MV.

Part Description Legend

SD= STANDARD DENSITY LENS
HD= HIGH DENSITY LENS
RED= RED ILLUM
WHT= WHITE ILLUM
AV = AutoVISION
VER = Verification

Sensor Table

	Pixels (HxV), MP	Shutter	Frame Rate (Standard/High)
WVGA	752x480, 0.3MP, Monochrome	Global	10 fps / 60 fps
SXGA	1280x960, 1.2MP, Monochrome	Global	10 fps / 42 fps
QSXGA	2592x1944, 5MP, Color	Rolling	5 fps

MicroHAWK-MV Europe Pricing

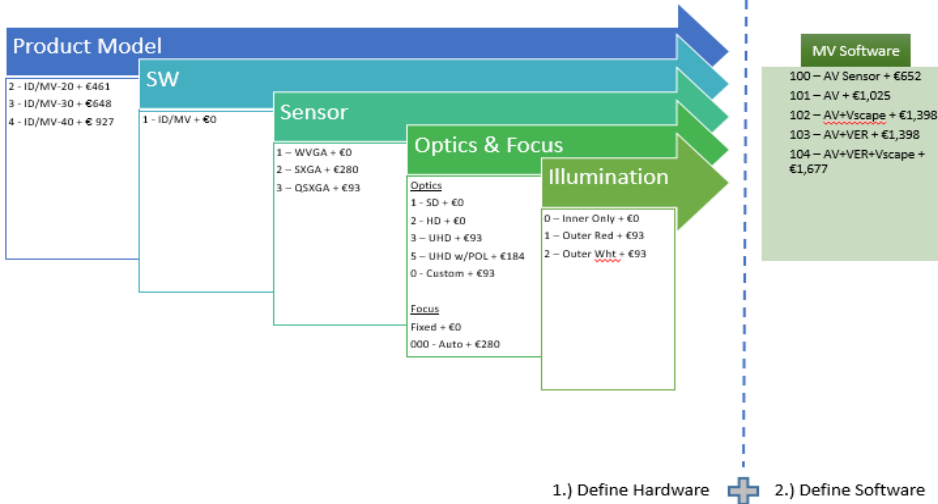

MicroHAWK Accessories

MicroHAWK MV License Upgrades

Part Number	Description	List Price	Type
LIC-0700-003*	LICENSE,MACHINE VISION,AUTOVISION	€ 364	A
LIC-0700-006*	LICENSE,MACHINE VISION,VISIONSCAPE	€ 374	A
LIC-0700-009*	LICENSE,MACHINE VISION,VERIFICATION/OCV	€ 364	A
LIC-0700-011*	LICENSE,MACHINE VISION,AUTOVISION SENSOR	€ -	A
LIC-0700-325*	LICENSE,MACHINE VISION,MACHINE VISION UNLOCK	€ 652	A

* All MicroHAWK ID units converting to Machine Vision must purchase the MACHINE VISION UNLOCK license, LIC-0700-325 in addition to the software licenses required

MicroHAWK-20/30 Connectivity Cables

Part Number	Description	List Price	Type
61-9000034-01	CABLE, USB A MALE TO MICRO USB B MALE, 6FT	€ 20	A
61-9000045-01	CABLE, USB A MALE TO MICRO USB B MALE, 3 FT	€ 20	A
61-9000037-01	CABLE,DB15 to EXT PWR/RS232,MICROHAWK-30 (Cable only)	€ 76	A
61-9000038-01	CABLE,DB15 to EXT PWR/USB,MICROHAWK-30 (Cable only)	€ 76	A
61-9000039-01	CABLE,DB15 to EXT PWR/USB,I/O,MICROHAWK-30 (Cable only)	€ 96	A
61-9000043-01	CABLE,DB15 to BUS PWR USB,MICROHAWK-30	€ 66	A
61-9000102-01	CABLE,DB15 TO USB/RS232,TRIGGERED,MICROHAWK-30 (CABLE ONLY)	€ 386	A
61-9000131-01	CABLE, USB/RS232/PWR, MICROHAWK-30, 1M (Cable Only) REQ PWR SUPPLY (97-000011-02	€ 76	A

MicroHAWK-30 Connectivity Cable Kits

Part Number	Description	List Price	Type
98-9000048-01	KIT,CABLE,DB15 to EXT PWR/RS232,W/PWR SUPPLY,MICROHAWK-30 ** INCLUDES PN:61-9000037-01 and PN:97-9000006-01	€ 106	A
98-9000049-01	KIT,CABLE,DB15 to EXT PWR/USB,W/PWR SUPPLY,MICROHAWK-30	€ 106	A
98-9000050-01	KIT,CABLE,DB15 to EXT PWR/USB,I/O,W/PWR SUPPLY,MICROHAWK-30	€ 186	A

MicroHAWK-40 Connectivity Cables

Part Number	Description	List Price	Type
61-000148-02	QX Cordset,Common,M12 12-Pin Socket(Screw-On)-to-M12 12-Pin Plug(Screw-	€ 96	A
61-000162-02	QX Cordset,Common,M12 12-Pin Socket(Screw-On)-to-M12 12-Pin Plug(Screw-On),1m.	€ 92	A
61-000153-02	QX Cordset, Host, Serial, M12 12-Pin Socket (Screw-On)-to-DB-9 Socket, 1 m.	€ 92	A
61-000164-02	QX Cordset, Host, Serial, M12 12-Pin Socket (Screw-On)-to-DB-9 Socket, 3 m.	€ 96	A
61-000163-03	QX Cordset, Host, Ethernet, M12 8-Pin Plug (Screw-On)-to-RJ45, 3 m.	€ 96	A
61-000160-03	QX Cordset, Host, Ethernet, M8 8-Pin Plug (Screw-On)-to-RJ45, 3 m.	€ 92	A
61-000167-02	QX Cordset, M12 12-Pin Socket (Screw-On)-to-Flying Leads, 3 m.	€ 96	A
61-000226-01	MINI HAWK Xi CORDSET,M12 SOCKET	€ 151	A
61-9000054-01	ASSY, CABLE, M12 12-PIN SOCKET TO 9PIN SOCKET AND M12 PLUG	€ 226	A
61-9000088-01	ASSY,CABLE,M12 12-PIN SOCKET TO USB KYBRD AND M12 PLUG	€ 386	A

Note: ID-40 compatible with QX series Screw-On cables and accessories (with exception to Ultra Lock, quick disconnect cables).

COMMON CORDSETS (5M) MICROHAWK-40

Part Number	Description	List Price	Type
61-9000133-01	CORDSET, M12 12 PIN SOCKET TO FLYING LEADS, HIGH FLEX, 5M	€ 120	A
61-9000118-01	CORDSET, ETHERNET, M12 8 PIN PLUG TO RJ45, HIGH FLEX, 5M	€ 120	A
61-9000117-01	CORDSET, M12 12 PIN PLUG TO M12 12 PIN SOCKET, HIGH FLEX, 5M	€ 120	A

COMMON CORDSETS (90DEG) MICROHAWK-40

Part Number	Description	List Price	Type
61-000148-03	CORDSET, M12 12 PIN PLUG TO M12 12 PIN SOCKET, RIGHT ANGLE UP, 3M	€ 96	A
61-000148-04	CORDSET, M12 12 PIN PLUG TO M12 12 PIN SOCKET, RIGHT ANGLE UP, 3M	€ 96	A
61-000162-03	CORDSET, M12 12 PIN PLUG TO M12 12 PIN SOCKET, RIGHT ANGLE DOWN, 1M	€ 92	A
61-000162-04	CORDSET, M12 12 PIN PLUG TO M12 12 PIN SOCKET, RIGHT ANGLE UP, 1M	€ 92	A
61-000167-03	CORDSET, M12 12 PIN SOCKET TO FLYING LEADS, RIGHT ANGLE DOWN, 3M	€ 96	A
61-000167-04	CORDSET, M12 12 PIN SOCKET, FLYING LEADS, RIGHT ANGLE UP, 3M	€ 96	A
61-000160-04	CORDSET, M12 8 PIN PLUG TO RJ45 ETHERNET, RIGHT ANGLE DOWN, 1M	€ 92	A
61-000160-05	CORDSET, M12 8 PIN PLUG TO RJ45 ETHERNET, RIGHT ANGLE UP, 1M	€ 92	A
61-000163-04	M12 8 PIN PLUG TO RJ45 ETHERNET, RT ANG,	€ 96	A
61-000163-05	CORDSET, M12 8 PIN PLUG TO RJ45 ETHERNET, RIGHT ANGLE UP, 3M	€ 96	A

MicroHAWK Power Supplies

Part Number	Description	List Price	Type
97-9000006-01	Power Supply, 5V for use with 61-9000037-01 & 61-9000038-01 cables	€ 36	A
97-000011-02	Power Supply,100-240VAC,+5VDC, 2PN PLG, USA/EUR Plug	€ 94	A
97-000012-01	Power Supply, 100-240VAC, +24VDC, M12 12-pin Socket	€ 140	A

Note: 97-000011-02 is for ID-30 with cable 61-9000039-01 & kit 98-9000050-01

MicroHAWK Mounting

Part Number	Description	List Price	Type
98-9000034-01	KIT, ADAPTER,MS-4 to MICROHAWK-20	€ 46	A
98-9000041-01	KIT, L BRACKET, MICROHAWK	€ 46	A
98-9000047-01	KIT, 1/4-20 CAMERA MOUNT,MICROHAWK	€ 26	A
98-9000052-01	KIT, MOUNTING STAND,MS-3,MS-4,MINI,MICROHAWK,4"	€ 86	A
98-9000053-01	KIT, MOUNTING STAND,MS-3,MS-4,MINI,MICROHAWK,3"	€ 86	A
98-9000054-01	KIT, MOUNTING, APG, MS-4, MINI, MICROHAWK	€ 104	A
98-9000059-01	KIT, ADAPTER PLATE, MICROHAWK 20/30/40 TO MINI	€ 96	A

MicroHAWK Accessories			List Price	Type
Part Number	Description			
98-9000051-01	KIT, WINDOW, MICROHAWK-30/40	€	36	A
98-9000043-01	KIT, DIFFUSER, MICROHAWK-30/40	€	76	A
98-9000129-01	KIT, POLARIZER, MICROHAWK 30/40, EXTERNAL	€	126	A
98-9000132-01	KIT, ESD-SAFE WINDOW, MICROHAWK	€	121	A
98-9000131-01	KIT, YAG FILTER, MICROHAWK	€	126	A
98-9000083-01	KIT, RED FILTER, MICROHAWK, 30 & 40	€	76	A
98-9000084-01	KIT, BLUE FILTER, MICROHAWK, 30 & 40	€	76	A
98-9000045-02	KIT, RED LED, MICROHAWK 30/40	€	126	A
98-9000046-01	KIT, WHITE LED, MICROHAWK-30/40	€	126	A
98-9000160-01	KIT, BLUE LED, MICROHAWK 30 & 40	€	126	A
98-9000159-01	KIT, IR LED, MICROHAWK 30 & 40	€	126	A
98-9000057-01	KIT, RA MIRROR, MICROHAWK 20	€	120	A
98-9000058-01	KIT, RA MIRROR, MICROHAWK, 30 & 40	€	120	A
98-9000064-01	KIT, ISOLATION MOUNTING,M3,MICROHAWK ID-30/40	€	16	A

Demo Kits - MicroHAWK			List Price	Type
Part Number	Description			
98-9000039-03	DEMO KIT, MICROHAWK (NO UNITS)	€	632	A
SLN-0000036	MicroHAWK ID/MV 30, SXGA, HD, White LED, Dual Boot Camera with Accessories	€	2,880	P
SLN-0000037	MicroHAWK ID/MV 40, SXGA, HD, White LED, Dual Boot Camera with Accessories	€	3,068	P

[Top](#)

Stand Alone Configurations

Note: Daisy-Chain Configurations are currently not available.

MV-20 Series Imagers

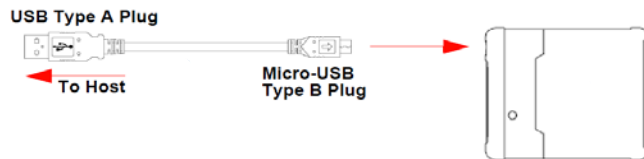

MV-30 Series Imagers

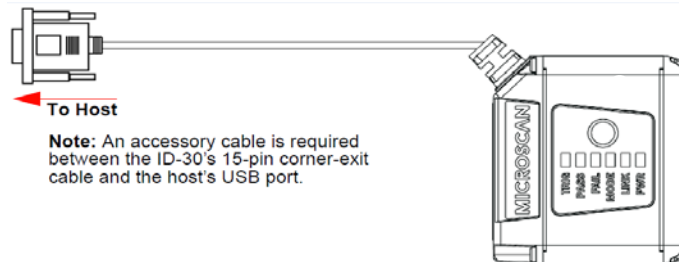

MV-40 Series Imagers

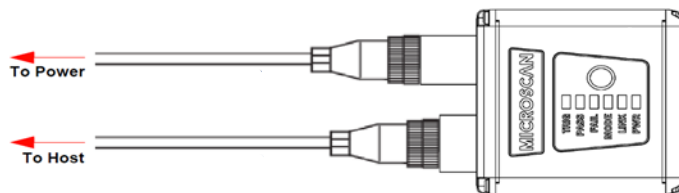

Tech Reference MicroHAWK MV-20



System Matrix

Product	Reference No. & Description	List Price
1	MicroHAWK ID-20	Varies
2	61-9000034-01, CABLE,USB A to MicroB,6FT,MICROHAWK-20	€ 20
2	61-9000045-01, CABLE,USB A to MicroB,3FT,MICROHAWK-20	€ 20

Tech Reference MicroHAWK MV-30

Stand Alone with DB-15 to BUS PWR USB Type A

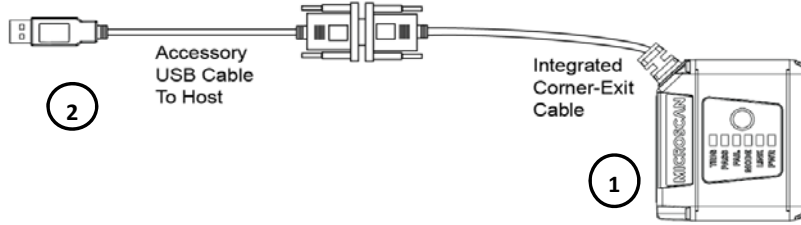

System Matrix

Product	Reference No. & Description	List Price
1	MicroHAWK ID-30	Varies
2	61-9000043-01, CABLE,DB15 to BUS PWR USB,MICROHAWK-30	€ 66

Note: Bus powered cable delivers reduced illumination... "approximately 30% less brightness"
 Note: Does not include I/O interface option: trigger cable with photo-sensor, or flying lead cable

Stand Alone with DB15 to EXT PWR/USB Type A

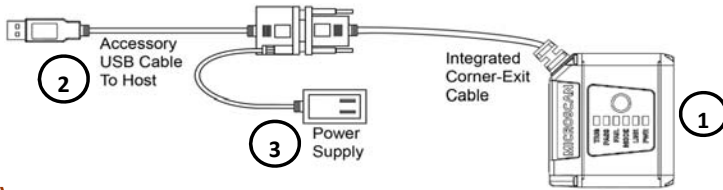

System matrix

Product	Reference No. & Description	List Price
1	MicroHAWK ID-30	Varies
2	61-9000038-01, CABLE,DB15 to EXT PWR/USB,MICROHAWK-30	€ 76
3	97-9000006-01, POWER SUPPLY,5V,for PN:61-9000037-01 &	€ 36
	98-9000049-01, KIT,CABLE,DB15 to EXT PWR/USB,W/PWR SUPPLY,MICROHAWK-30	€ 106

Note: Does not include I/O interface option: trigger cable with photo-sensor, or flying lead cable

Stand Alone with DB15 to EXT PWR/RS232

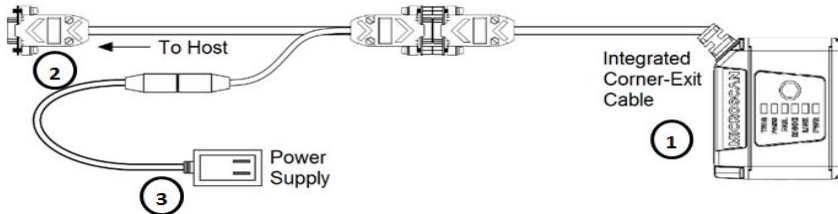

System Matrix

Product	Reference No. & Description	List Price
1	MicroHAWK ID-30	Varies
2	61-9000037-01,CABLE,DB15 to EXT PWR/RS232,MICROHAWK-30 (Cable only)	€ 76
3	97-9000006-01, POWER SUPPLY,5V,for PN:61-9000037-01 & PN:61-9000038-01	€ 36
	98-9000048-01, KIT,CABLE,DB15 to EXT PWR/RS232,W/PWR SUPPLY,MICROHAWK-30	€ 106

Note: Does not include I/O interface option: trigger cable with photo-sensor, or flying lead cable
 Note: RS232 Connector to host is a standard DB-9

Stand Alone with DB15 to EXT PWR/USB,I/O

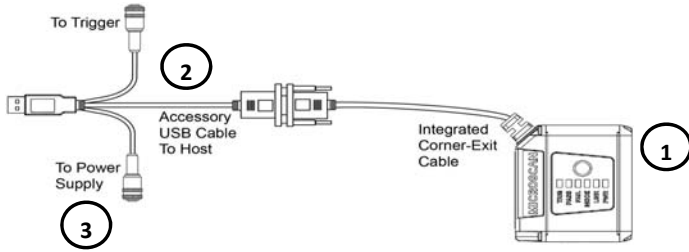

System Matrix

Product	Reference No. & Description	List Price
1	MicroHAWK ID-30	Varies
2	61-9000039-01, CABLE,DB15 to EXT PWR/USB,I/O.	€ 96
3	97-000011-02, Power Supply, 100-240VAC, +5VDC, 2-Pin Plug, U.S./Euro Plug	€ 94
	98-9000050-01, KIT,CABLE,DB15 to EXT PWR/USB,I/O,W/PWR SUPPLY,MICROHAWK-30	€ 186

Stand Alone with IB-131 and IC-332

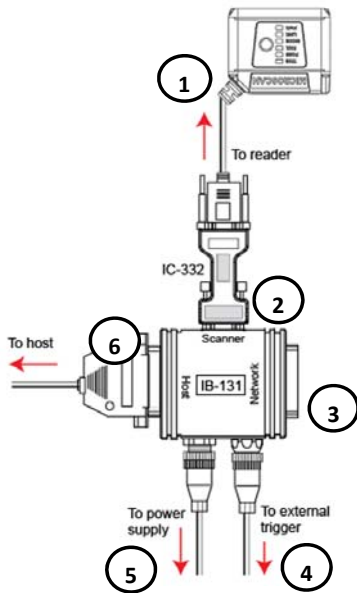

System Matrix

Product	Reference No. & Description	List Price
1	MicroHAWK ID-30	Varies
2	FIS-0001-0035G, Converter, IC-332, 24V/5V, Opto I/O, for Use with IB-131	€ 184
3	99-000018-01, IB-131 Interface Box	€ 184
4	99-000019-01, Photo Sensor, Visible, NPN, Light On, 5VDC	€ 196
5	97-000012-02, Power Supply, 100-240VAC, +24VDC, TRK 3-Pin, U.S./Euro Plug)	€ 154
6	61-300026-03, Cable, Communication, DB-25 Plug-to-DB-9 Socket, 6 ft.	€ 36

Stand Alone with QX-1 Interface

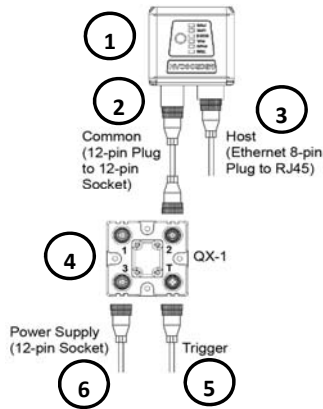

System Matrix

Product	Reference No. & Description	List Price
1	MicroHAWK ID-40	Varies
2	61-000162-02, QX Cordset, Common, M12 12-Pin Socket(Screw-On)-to-M12 12-Pin Plug(Screw-On), 1m.	€ 92
3	61-000160-03, QX Cordset, Host, Ethernet, M12 8-Pin Plug (Screw-On)-to-RJ45, 1 m.	€ 92
4	98-000103-02, QX-1 Interface Device	€ 196
5	97-000012-01, Power Supply, 100-240VAC, +24VDC, M12 12-Pin Socket	€ 140
6	99-000020-01, QX Photo Sensor, M12 4-Pin Plug, NPN, Dark Off, 2 m.	€ 196
6	99-000020-02, QX Photo Sensor, M12 4-Pin Plug, NPN, Dark, On, 2 m.	€ 196

MICROSCAN

HAWK MV-4000 High Performance Smart Camera



0.3, 1.3, 2.0 and 5 MP
 Monochrome and Color
 CMOS Global Shutter
 C-Mount Configuration
 Ethernet and Serial Connectivity
 Ethernet/IP and ProfiNET I/O via Microscan LINK
 IP67
 24 VDC
 AutoVISION Software*
 Supports AutoVISION and Visionscape Software
 CloudLink Dashboard web HMI

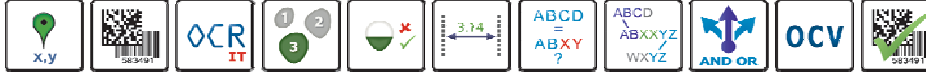

****Important Pricing Discount Note**** Product discounts are applied based on the Product TYPE code shown in the TYPE column below.

Product Type codes are defined as: P = PRODUCT Discount, A = ACCESSORY Discount.

Refer to your Partner Agreement for the actual discount percentage by Product Type.

HAWK MV-4000 High Performance Smart Cameras

Part Number	Description	List Price	Type	Configuration Reference #
0.3 MP Mono				
8011-0000-0100	HAWK MV-4000-03, 0.3 MP (640X480), MONO, AV SENSOR	€ 3,791	P	1
8011-0000-0101	HAWK MV-4000-03, 0.3 MP (640X480), MONO, AV	€ 4,148	P	1
8011-0000-0102	HAWK MV-4000-03, 0.3 MP (640X480), MONO, AV+VS	€ 4,504	P	1
8011-0000-0103	HAWK MV-4000-03, 0.3 MP (640X480), MONO, AV+VERIF/OCV	€ 4,504	P	1
8011-0000-0104	HAWK MV-4000-03, 0.3 MP (640X480), MONO, AV+VS+VERIF/OCV	€ 4,772	P	1
1.3 MP Mono				
8012-0000-0100	HAWK MV-4000-13, 1.3 MP (1280X1024), MONO, AV SENSOR	€ 4,598	P	1
8012-0000-0101	HAWK MV-4000-13, 1.3 MP (1280X1024), MONO, AV	€ 4,955	P	1
8012-0000-0102	HAWK MV-4000-13, 1.3 MP (1280X1024), MONO, AV+VS	€ 5,311	P	1
8012-0000-0103	HAWK MV-4000-13, 1.3 MP (1280X1024), MONO, AV+VERIF/OCV	€ 5,311	P	1
8012-0000-0104	HAWK MV-4000-13, 1.3 MP (1280X1024), MONO, AV+VS+VERIF/OCV	€ 5,579	P	1
2.0 MP Mono				
8013-0000-0100	HAWK MV-4000-20, 2.0 MP (1920X1200), MONO, AV SENSOR	€ 5,160	P	1
8013-0000-0101	HAWK MV-4000-20, 2.0 MP (1920X1200), MONO, AV	€ 5,516	P	1
8013-0000-0102	HAWK MV-4000-20, 2.0 MP (1920X1200), MONO, AV+VS	€ 5,873	P	1
8013-0000-0103	HAWK MV-4000-20, 2.0 MP (1920X1200), MONO, AV+VERIF/OCV	€ 5,873	P	1
8013-0000-0104	HAWK MV-4000-20, 2.0 MP (1920X1200), MONO, AV+VS+VERIF/OCV	€ 6,141	P	1
5.0 MP Mono				
8014-0000-0100	HAWK MV-4000-50, 5.0 MP (2592X2048), MONO, AV SENSOR	€ 5,975	P	1
8014-0000-0101	HAWK MV-4000-50, 5.0 MP (2592X2048), MONO, AV	€ 6,331	P	1
8014-0000-0102	HAWK MV-4000-50, 5.0 MP (2592X2048), MONO, AV+VS	€ 6,688	P	1
8014-0000-0103	HAWK MV-4000-50, 5.0 MP (2592X2048), MONO, AV+VERIF/OCV	€ 6,688	P	1
8014-0000-0104	HAWK MV-4000-50, 5.0 MP (2592X2048), MONO, AV+VS+VERIF/OCV	€ 6,955	P	1
0.3 MP Color				
8015-0000-0100	HAWK MV-4000-03C, 0.3 MP (640X480), COLOR, AV SENSOR	€ 3,998	P	1
8015-0000-0101	HAWK MV-4000-03C, 0.3 MP (640X480), COLOR, AV	€ 4,354	P	1
8015-0000-0102	HAWK MV-4000-03C, 0.3 MP (640X480), COLOR, AV+VS	€ 4,711	P	1
8015-0000-0103	HAWK MV-4000-03C, 0.3 MP (640X480), COLOR, AV+VERIF/OCV	€ 4,711	P	1
8015-0000-0104	HAWK MV-4000-03C, 0.3 MP (640X480), COLOR, AV+VS+VERIF/OCV	€ 4,979	P	1
1.3 MP Color				
8016-0000-0100	HAWK MV-4000-13C, 1.3 MP (1280X1024), COLOR, AV SENSOR	€ 4,805	P	1
8016-0000-0101	HAWK MV-4000-13C, 1.3 MP (1280X1024), COLOR, AV	€ 5,161	P	1
8016-0000-0102	HAWK MV-4000-13C, 1.3 MP (1280X1024), COLOR, AV+VS	€ 5,518	P	1
8016-0000-0103	HAWK MV-4000-13C, 1.3 MP (1280X1024), COLOR, AV+VERIF/OCV	€ 5,518	P	1
8016-0000-0104	HAWK MV-4000-13C, 1.3 MP (1280X1024), COLOR, AV+VS+VERIF/OCV	€ 5,785	P	1
2.0 MP Color				
8017-0000-0100	HAWK MV-4000-20C, 2.0 MP (1920X1200), COLOR, AV SENSOR	€ 5,366	P	1
8017-0000-0101	HAWK MV-4000-20C, 2.0 MP (1920X1200), COLOR, AV	€ 5,723	P	1
8017-0000-0102	HAWK MV-4000-20C, 2.0 MP (1920X1200), COLOR, AV+VS	€ 6,079	P	1
8017-0000-0103	HAWK MV-4000-20C, 2.0 MP (1920X1200), COLOR, AV+VERIF/OCV	€ 6,079	P	1
8017-0000-0104	HAWK MV-4000-20C, 2.0 MP (1920X1200), COLOR, AV+VS+VERIF/OCV	€ 6,347	P	1
5 MP Color				
8018-0000-0100	HAWK MV-4000-50C, 5.0 MP (2592X2048), COLOR, AV SENSOR	€ 6,181	P	1
8018-0000-0101	HAWK MV-4000-50C, 5.0 MP (2592X2048), COLOR, AV	€ 6,538	P	1
8018-0000-0102	HAWK MV-4000-50C, 5.0 MP (2592X2048), COLOR, AV+VS	€ 6,894	P	1
8018-0000-0103	HAWK MV-4000-50C, 5.0 MP (2592X2048), COLOR, AV+VERIF/OCV	€ 6,894	P	1
8018-0000-0104	HAWK MV-4000-50C, 5.0 MP (2592X2048), COLOR, AV+VS+VERIF/OCV	€ 7,162	P	1

MICROSCAN.

HAWK Lenses, Lense Caps and Optical Accessories

Part Number	Description	List Price	Type	Configuration Reference #
Standard Resolution for 2/3" Sensors - (General Inspection, Reading, Some Verification)				
98-9000167-01	LENS, C-MOUNT, 6MM, STANDARD RES, 2/3" SENSOR	€ 217	A	2
98-9000168-01	LENS, C-MOUNT, 9MM, STANDARD RES, 2/3" SENSOR	€ 200	A	2
98-9000169-01	LENS, C-MOUNT, 12.5MM, STANDARD RES, 2/3" SENSOR	€ 200	A	2
98-9000170-01	LENS, C-MOUNT, 16MM, STANDARD RES, 2/3" SENSOR	€ 200	A	2
98-9000171-01	LENS, C-MOUNT, 25MM, STANDARD RES, 2/3" SENSOR	€ 200	A	2
98-9000172-01	LENS, C-MOUNT, 35MM, STANDARD RES, 2/3" SENSOR	€ 200	A	2
High Resolution for 2/3" Sensors - (Gauging, Verification)				
98-9000192-01	LENS, C-MOUNT, 6MM, HIGH RES, 2/3" SENSOR	€ 652	A	2
98-9000165-01	LENS, C-MOUNT, 8MM, HIGH RES, 2/3" SENSOR	€ 478	A	2
98-9000166-01	LENS, C-MOUNT, 12MM, HIGH RES, 2/3" SENSOR	€ 478	A	2
98-9000154-01	LENS, C-MOUNT, 16MM, HIGH RES, 2/3" SENSOR	€ 478	A	2
98-9000164-01	LENS, C-MOUNT, 25MM, HIGH RES, 2/3" SENSOR	€ 478	A	2
98-9000163-01	LENS, C-MOUNT, 35MM, HIGH RES, 2/3" SENSOR	€ 478	A	2
High Resolution for 1" Sensors - (All applications. Required for 1" 5 MP Sensor)*				
98-9000174-01*	LENS, C-MOUNT, 12.5MM, HIGH RES, 1" SENSOR	€ 913	A	2
98-9000175-01*	LENS, C-MOUNT, 16MM, HIGH RES, 1" SENSOR	€ 748	A	2
98-9000176-01*	LENS, C-MOUNT, 25MM, HIGH RES, 1" SENSOR	€ 713	A	2
98-9000177-01*	LENS, C-MOUNT, 35MM, HIGH RES, 1" SENSOR	€ 713	A	2
C-Mount Liquid Lens				
98-9000179-01*	LENS, LIQUID, C-MOUNT, F2.8/16MM, 2/3" SENSOR, I2C INTERFACE	€ 869	A	2
98-9000178-01*	LENS, LIQUID, C-MOUNT, F4/25MM, 2/3" SENSOR, I2C INTERFACE	€ 869	A	2
Lens Accessories				
98-9000155-01*	IP67 LENS COVER FOR HAWK 4000, 50MM LENGTH	€ 230	A	3
98-9000156-01*	IP67 LENS COVER FOR HAWK 4000, 70MM LENGTH	€ 230	A	3
98-CO206	Lens Extension Tube Set, 0.5 mm, 1 mm, 5 mm, 10 mm, 20 mm, 40 mm	€ 146	A	3
98-92800371	Lens, Polarizing Filter, 25.5 mm, P0.5	€ 102	A	
98-9000191-01	FILTER, POLARIZING, CIRCULAR, 40.5 X 0.5 MM, B+W	€ 130	A	

* Not all lenses can be used in combination with the lens protection housings. See HAWK MV-4000 Guide.

HAWK 4000 CABLES, LIGHT CONTROL CABLES, AND POWER SUPPLY

Part Number	Description	List Price	Type	Configuration Reference #
HAWK 4000 X-CODE Ethernet Port Cables				
61-9000134-01*	CABLE, HAWK 4000 ETHERNET, X-CODE/RJ45 CAT 6A, 1 METER	€ 165	A	5
61-9000134-02**	CABLE, HAWK 4000 ETHERNET, X-CODE/RJ45 CAT 6A, 3 METER	€ 178	A	5
61-9000134-03**	CABLE, HAWK 4000 ETHERNET, X-CODE/RJ45 CAT 6A, 5 METER	€ 195	A	5
HAWK 4000 VGA/USB Port Connector Cables				
61-9000143-01	CABLE, HAWK 4000 M12 TO USB FEMALE, 1 METER	€ 25	A	6
61-9000147-01	CABLE, HAWK 4000 M12 TO VGA & USB, 1 METER	€ 47	A	6
HAWK 4000 Digital IO Port Connector Cables				
61-9000132-01	CABLE, ADAPTER, HAWK 4000 TO ACCESSORY CABLES/POWER SUPPLY (Comes with camera)	€ 89	A	7
61-9000151-01	CABLE, HAWK 4000 M12 TO FLYING LEADS, 3 METER (NO ADAPTOR NEEDED)	€ 108	A	8
QX-1 Interface Cables and Accessories				
61-000162-02	QX Cordset, Common, M12 12-Pin Socket(Screw-On)-to-M12 12-Pin Plug(Screw-On), 1m.	€ 92	A	9
61-000148-02	QX Cordset, Common, M12 12-Pin Socket(Screw-On)-to-M12 12-Pin Plug(Screw-On), 3m.	€ 96	A	9
98-000103-02	QX-1 Interface Device	€ 196	A	10
99-000020-02	QX Photo Sensor, M12 4-Pin Plug, NPN, Dark On, 2 m.	€ 196	A	11
99-000020-01	QX Photo Sensor, M12 4-Pin Plug, NPN, Dark Off, 2 m.	€ 196	A	11
20-610024-01	Trigger Connector, 4-Pin Plug (Screw Terminal, Field-Wireable) (Self-Wiring)	€ 36	A	11
SMART LIGHT CONTROL CABLES				
61-9000135-01***	Y CABLE, HAWK 4000 ADAPTOR TO SMART LIGHT AND QX-1, POWER, 1 METER	€ 289	A	12
61-9000137-01***	Y CABLE, HAWK 4000 ADAPTOR TO SMART LIGHT AND QX-1, STROBE, 1 METER	€ 289	A	12
61-000204-01	QX Cordset, Smart Series Light-to-QX-1, Continuous Power	€ 206	A	13
61-000218-01	QX Cordset, Smart series light to QX-1, strobe, NPN	€ 132	A	13
61-000223-01	Cable, Power, Edge-to-Edge Backlight-to-QX-1	€ 206	A	13
Power Supply				
97-000012-01	Power Supply, 100-240VAC, +24VDC, M12 12-pin Socket	€ 140	A	14

* Use alternative 1 Meter ETHERNET cable 60-9000060-01. Standard production cables available starting 2/15/2018.

** Use alternative 5 Meter ETHERNET cable 60-9000061-01. Standard production cables available starting 2/15/2018.

*** Use QX-1 Configuration. See configuration reference diagrams. Production Y cables available starting 3/1/2018.

HAWK 4000 AND SMART LIGHT MOUNTS

Part Number	Description	List Price	Type	Configuration Reference #
Standard Mounts				
98-9000209-01	UNIVERSAL MOUNT, HAWK 4000	€ 42	A	15
98-9000054-01	KIT, MOUNTING, APG, MS-4, MINI, MICROHAWK	€ 104	A	15
Smart Light/HAWK 4000 Mounting Kits				
98-9000120-01	KIT, BRACKET, MAX 300 TO HAWK 4000	€ 435	A	
98-9000121-01	KIT, BRACKET, DOAL TO HAWK 4000	€ 243	A	
98-9000122-01	KIT, BRACKET, RING 60/70 TO HAWK 4000	€ 243	A	
98-9000123-01	KIT, BRACKET, RING 100 TO HAWK 4000	€ 243	A	
98-9000137-01	ASSY, SMART SERIES, PHARMALITE AND BRACKET FOR HAWK MV-4000	€ 1,304	A	

LICENSING

Part Number	Description	List Price	Type	Configuration Reference #
HAWK 4000 X-CODE Ethernet Port Cables				
LIC-0700-003	LICENSE,MACHINE VISION,AUTOVISION	€ 364	A	
LIC-0700-006	LICENSE,MACHINE VISION,VISIONSCAPE	€ 374	A	
LIC-0700-009	LICENSE,MACHINE VISION,VERIFICATION/OCV	€ 364	A	
LIC-0700-011	LICENSE,MACHINE VISION,AUTOVISION SENSOR	€ -	A	
LIC-0700-325	LICENSE,MACHINE VISION,MACHINE VISION UNLOCK	€ 652	A	

Camera Kits - with License, Lens, IP Cover and Mount

Part Number	Description	List Price	Type	Configuration Reference #
0.3 MP, Standard Lens				
8211-1090-0102	HAWK MV-4000-03, AV+VS, 9MM STD LENS, IP COVER	€ 4,976	P	1,2,3
8111-1160-0102	HAWK MV-4000-03, AV+VS, 16MM STD LENS, IP COVER	€ 4,976	P	1,2,3
1.3 MP, Standard Lens				
8112-1120-0104	HAWK MV-4000-13, AV+VS+VERIF/OCV, 12.5MM STD LENS, IP COVER	€ 6,050	P	1,2,3
8112-1250-0104	HAWK MV-4000-13, AV+VS+VERIF/OCV, 25MM STD LENS, IP COVER	€ 6,050	P	1,2,3
1.3 MP, High Res Lens				
8212-2160-0104	HAWK MV-4000-13, AV+VS+VERIF/OCV, 16MM HD LENS, IP COVER	€ 6,328	P	1,2,3
8212-2250-0104	HAWK MV-4000-13, AV+VS+VERIF/OCV, 25MM HD LENS, IP COVER	€ 6,328	P	1,2,3
8212-2350-0104	HAWK MV-4000-13, AV+VS+VERIF/OCV, 35MM HD LENS, IP COVER	€ 6,328	P	1,2,3
2.0 MP, Standard Lens				
8113-1160-0104	HAWK MV-4000-20, AV+VS+VERIF/OCV, 16MM STD LENS, IP COVER	€ 6,612	P	1,2,3
8113-1350-0104	HAWK MV-4000-20, AV+VS+VERIF/OCV, 35MM STD LENS, IP COVER	€ 6,612	P	1,2,3
2.0 MP, High Res Lens				
8213-2160-0104	HAWK MV-4000-20, AV+VS+VERIF/OCV, 16MM HD LENS, IP COVER	€ 6,890	P	1,2,3
8213-2250-0104	HAWK MV-4000-20, AV+VS+VERIF/OCV, 25MM HD LENS, IP COVER	€ 6,890	P	1,2,3
8213-2350-0104	HAWK MV-4000-20, AV+VS+VERIF/OCV, 35MM HD LENS, IP COVER	€ 6,890	P	1,2,3
2.0 Color, Standard Lens				
8117-1090-0102	HAWK MV-4000-20C, AV+VS, 9MM STD LENS, IP COVER	€ 6,550	P	1,2,3
8117-1160-0102	HAWK MV-4000-20C, AV+VS, 16MM STD LENS, IP COVER	€ 6,550	P	1,2,3
8117-1350-0102	HAWK MV-4000-20C, AV+VS, 35MM STD LENS, IP COVER	€ 6,550	P	1,2,3
0.3 MP, Standard Lens				
8014-3160-0104	HAWK MV-4000-50, AV+VS+VERIF/OCV, 16MM 1" LENS	€ 7,745	P	1,2
8014-3250-0104	HAWK MV-4000-50, AV+VS+VERIF/OCV, 25MM 1" LENS, NO COVER	€ 7,745	P	1,2
8014-3350-0104	HAWK MV-4000-50, AV+VS+VERIF/OCV, 35MM 1" LENS, NO COVER	€ 7,745	P	1,2

Verification Kits and Verification Calibration Cards

Part Number	Description	List Price	Type	Configuration Reference #
Verification Kits				
SLN-0000046	DOT-PEEN SYMBOLOGY VERIFICATION KIT, DOAL-50, HAWK MV-4000	€ 6,609	P	
SLN-0000047	LABEL SYMBOLOGY VERIFICATION KIT, PHARMALITE, HAWK MV-4000	€ 7,739	P	
SLN-0000048	LARGE CODE SYMBOLOGY VERIFICATION KIT, MAX-300, HAWK MV-4000	€ 7,739	P	
Calibration Cards				
98-000265-01	AV Verif. Calibration Card with NIST-Traceable Measurement Report	€ 476	A	
98-000265-02	AV Verif. Calibration Card	€ 226	A	

Software/Manuals

Part Number	Description	List Price	Type	Configuration Reference #
37-000010-01*	Tools Drive, User Documentation, Software	€ 30	A	

*One free per order

Configuration Reference *HAWK MV-4000*

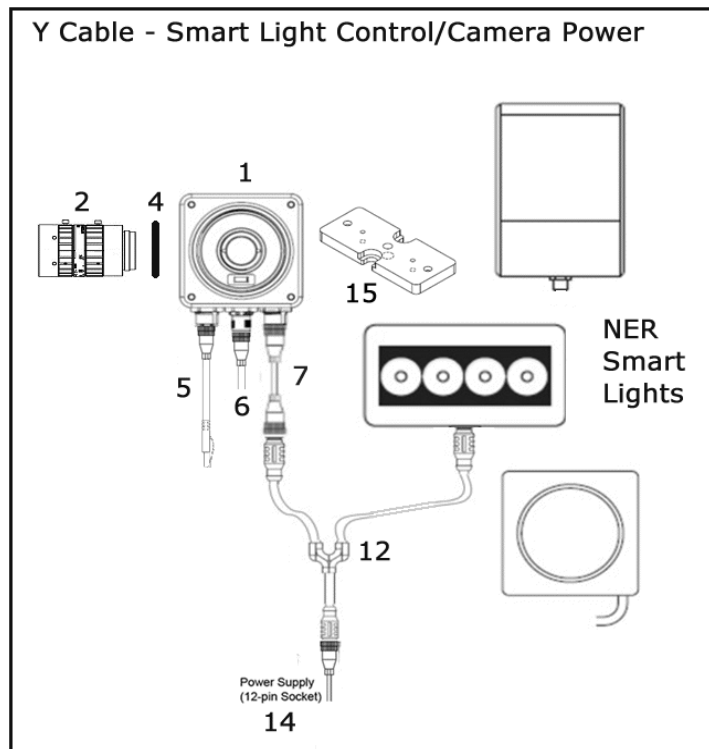
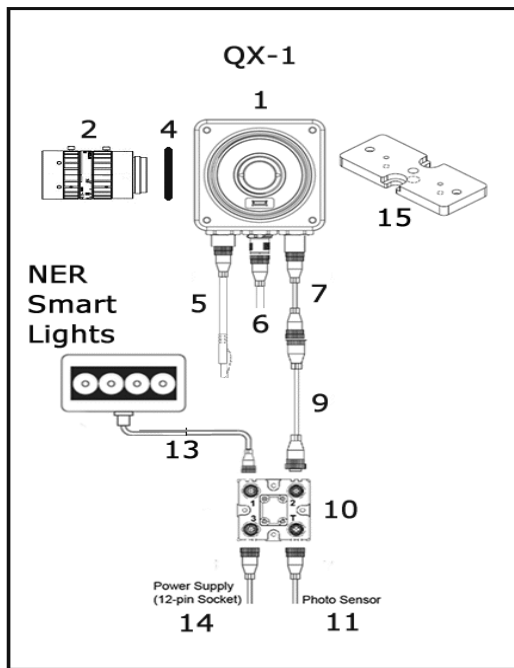
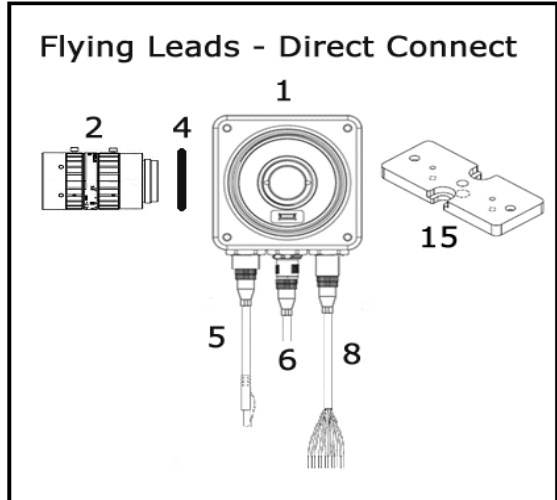
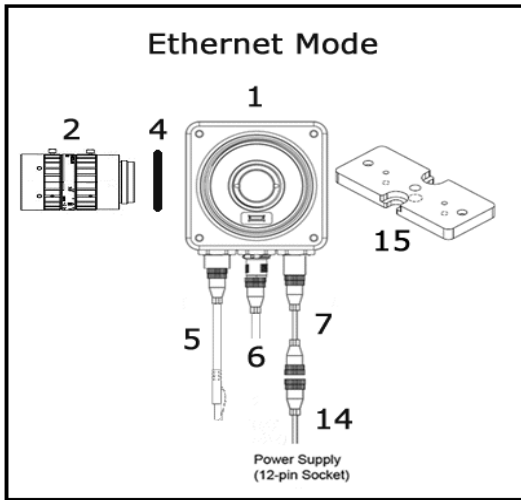

MICROSCAN

Vision MINI Smart Camera



Integrated Lighting
Standard and High Density Models
SXGA CMOS 1.3 MP mono
QXGA CMOS 3.0 MP color
WVGA CMOS 0.4 MP mono
USB or Serial**
IP-54
+5VDC



MICROSCAN
LINK

Best Sellers	
1)	GMV-6300-2212G
2)	GMV-6300-2200G
3)	GMV-6300-2210G



*Color models are only supported by Visionscape

** Serial requires optional adapter

****Important Pricing Discount Note**** Product discounts are applied based on the Product TYPE code shown in the TYPE column below.

Product Type codes are defined as: P = PRODUCT Discount, A = ACCESSORY Discount.

A Product Type code modified with L signifies Legacy Status (refer to Legacy section of this catalog).

Refer to your Partner Agreement for the actual discount percentage by Product Type.

Vision MINI Smart Camera - 1.3 MP SXGA (1280 x 1024)

Part Number	Description	List Price	Type
GMV-6300-2110G	Vision MINI, SXGA Mono, SD, AV, RS-232/USB	€ 1,856	P
GMV-6300-2210G	Vision MINI, SXGA Mono, HD, AV, RS-232/USB	€ 1,856	P
GMV-6300-2112G	Vision MINI, SXGA Mono, SD, VS+AV, RS-232/USB	€ 2,322	P
GMV-6300-2212G	Vision MINI, SXGA Mono, HD, VS+AV, RS-232/USB	€ 2,322	P
GMV-6300-2114G*	Vision MINI, SXGA Mono, SD, Verif.+AV, RS-232/USB	€ 2,228	P
GMV-6300-2214G*	Vision MINI, SXGA Mono, HD, Verif.+AV, RS-232/USB	€ 2,228	P
GMV-6300-2116G*	Vision MINI, SXGA Mono, SD, Verif.+AV+VS, RS-232/USB	€ 2,696	P
GMV-6300-2216G*	Vision MINI, SXGA Mono, HD, Verif.+AV+VS RS-232/USB	€ 2,696	P

* Verification calibration card not included in verification license

Vision MINI Smart Camera - 0.4 MP WVGA (752 x 480)

Part Number	Description	List Price	Type
GMV-6300-2100G	Vision MINI, WVGA Mono, SD, AV, RS-232/USB	€ 1,856	P
GMV-6300-2200G	Vision MINI, WVGA Mono, HD, AV, RS-232/USB	€ 1,856	P
GMV-6300-2102G	Vision MINI, WVGA Mono, SD, VS+AV, RS-232/USB	€ 2,322	P
GMV-6300-2202G	Vision MINI, WVGA Mono, HD, VS+AV, RS-232/USB	€ 2,322	P
GMV-6300-2104G*	Vision MINI, WVGA Mono, SD, Verif.+AV, RS-232/USB	€ 2,228	P
GMV-6300-2204G*	Vision MINI, WVGA Mono, HD, Verif.+AV, RS-232/USB	€ 2,228	P
GMV-6300-2106G*	Vision MINI, WVGA Mono, SD, Verif.+AV+VS, RS-232/USB	€ 2,696	P
GMV-6300-2206G*	Vision MINI, WVGA Mono, HD, Verif.+AV+AV, RS-232/USB	€ 2,696	P

* Verification calibration card not included in verification license

Vision MINI Smart Camera - 3 MP Color QXGA (2048 x 1536)

Part Number	Description	List Price	Type
GMV-6300-2172G	Vision MINI, QXGA Color, SD, VS, RS-232/USB	€ 2,788	P
GMV-6300-2272G	Vision MINI, QXGA Color, HD, VS, RS-232/USB	€ 2,788	P

The GMV-6300-2272G is a Smart Camera with 3.0 MPixel color sensors. It is not detected and listed as cameras that can be connected and programmed by AutoVISION. It is detected and listed by Visionscape which is required for programming and monitoring.

Software

Part Number	Description	List Price	Type
98-000217-01	AV to VS License Upgrade	€ 500	A
98-000217-02	AV to VS Verif. & OCV License Upgrade	€ 402	A
98-000217-03	AV to VS with Verif. & OCV License Upgrade	€ 902	A

Verification Calibration Card

Part Number	Description	List Price	Type
98-000265-01	AV Verif. Calibration Card with NIST-Traceable Measurement Report	€ 476	A
98-000265-02	AV Verif. Calibration Card	€ 226	A

Accessories

Part Number	Description	List Price	Type
98-000215-01*	Demo Kit, AV, Supports Vision MINI & Vision HAWK (Cameras Not Included)	€ 596	A
FIS-0210-0001G	MS-Connect 210, Connectivity Box with Display	€ 820	A
FIS-0210-0002G	MS-Connect 210, Connectivity Box	€ 558	A
FIS-0210-0003G	MS-Connect 210, Connectivity Box with Display & Ethernet	€ 932	A
FIS-0210-0004G	MS-Connect 210, Connectivity Box with Ethernet	€ 820	A
98-000013-04	Relay Module, 120VAC, 3 Amp Output, Series 70, Type SM, for MS-Connect 210 + MS-890	€ 56	A
98-000013-05	Relay Module, 240VAC, 3 Amp Output, Series 70, Type SM for MS-Connect 210 + MS-890	€ 56	A
98-000013-06	Relay Module, 24VDC, 3 Amp Output, Series 70, Type SM, for MS-Connect 210, MS-890	€ 56	A
61-000127-02	Cable, MS-2-to-MS-Connect 210, 6 ft.	€ 112	A
FIS-0001-0035G	Converter, IC-332, 24V/5V, Opto I/O, for Use with IB-131	€ 184	A
99-000018-01	IB-131 Interface Box	€ 184	A
61-300026-03	Cable, Communication, DB-25 Plug-to-DB-9 Socket, 6 ft.	€ 36	A
61-100029-03	Cable, Daisy Chain, IB-131	€ 36	A
61-000208-01	Cable, USB 2.0, Type A/Type B, with Ferrite	€ 26	A
61-000011-02	Extension Cable, Reader-to-IB-131 (MS-2, MS-3, MS-4, MS-9, MS-710, MS-820, MINI)	€ 36	A
98-000098-01	Kit, MINI Diffuser	€ 56	A

* This Demo Kit does not contain a reader and is discounted 25%. The separately purchased reader is discounted 60%.

Power Supply

Part Number	Description	List Price	Type
97-000012-02	Power Supply (100-240 VAC, +24VDC, TRK 3Pin, USA/Euro Plug)	€ 154	A

Mounting and Connectors

Part Number	Description	List Price	Type
98-000048-01	Kit, Mounting Arm/Adapter, 4 in., for MS-2, MS-3	€ 78	A
98-000054-01	Kit, Mounting Stand Base Plate	€ 36	A
98-000053-01	Mounting Arm Extension Kit, 4 in., for MS-3, MS-4, MINI	€ 40	A
98-000053-02	Mounting Arm Extension Kit, 3 in., for MS-2, MS-3, MS-4, MINI	€ 40	A
98-000060-01	Kit, Bracket, Side Mount, MS-2, MS-3, MINI	€ 24	A
98-000059-01	Kit, Bracket, Angle Mount, MS-2, MS-3, MINI	€ 24	A
98-000057-02	Kit, Bracket, Through-Hole Mount, MS-2, MS-3, MINI	€ 24	A
98-000088-01	Kit, Right Angle Mirror, MS-4/MINI Hawk/Vision MINI	€ 56	A
20-610024-01	Trigger Connector, 4-Pin Plug (Screw Terminal, Field-Wireable) (Self-Wiring)	€ 36	A
20-610020-01	Power Conn., 3-Pin Socket (Screw Term., Field-Wireable for Custom IB-131 Wiring)	€ 36	A
99-000055-01	Bracket, Smart Series DOAL-50 mm-to-Vision MINI & MINI Hawk	€ 256	A
99-000057-01	Bracket, Smart Series DOAL-75 mm-to-Vision MINI & MINI Hawk	€ 256	A
99-000059-01	Bracket, Smart Series DOAL-100 mm-to-Vision MINI & MINI Hawk	€ 256	A
99-000053-01	Bracket, Smart Series Ring-60/70 mm-to-Vision MINI & MINI Hawk	€ 138	A
99-000054-01	Bracket, Smart Series Ring-100 mm-to-Vision MINI & MINI Hawk	€ 138	A

Package Detector/Sensor

Part Number	Description	List Price	Type
99-000017-01	Photo Sensor, Visible, NPN, Dark ON	€ 196	A
99-000017-02	Photo Sensor, Visible, NPN, Light ON	€ 196	A
99-000019-01	Photo Sensor, Visible, NPN, Light On, 5VDC	€ 196	A

Software/Manuals

Part Number	Description	List Price	Type
37-000010-01*	Tools Drive, User Documentation, Software	€ 30	A

* 1 free per order.

MICROSCAN.

Tech Reference *Vision MINI*

Stand Alone USB

A single reader is connected directly to the host via USB.

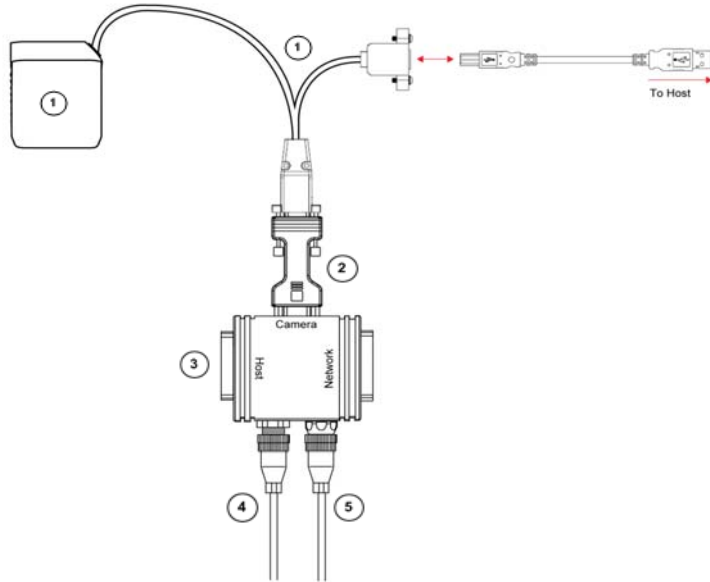

System Matrix

Item	Part Number	Description	List Price
1	GMV-6300-2XXXG	Vision MINI Smart Camera and Included Cables	Varies
2	FIS-0001-0035G	Converter, IC-332, 24V/5V, Opto I/O, for Use with IB-131	€ 184
3	99-000018-01	IB-131 Interface Box	€ 184
4	97-000012-02	Power Supply, 100-240VAC, +24VDC, TRK 3-Pin, U.S./Euro Plug)	€ 154
5	99-000017-01	Photo Sensor, Visible, NPN, Dark ON	€ 196
	37-000010-01	Tools Drive, User Documentation, Software	€ 30

MICROSCAN.

Vision HAWK Industrial Smart Camera



WVGA CMOS mono
SXGA CCD mono & color
WUXGA Mono
C-Mount Configuration
Ethernet and Serial Connectivity
Ethernet/IP and ProfiNET I/O via Microscan LINK
IP67
5 - 28 VDC
AutoVISION Software*
Supports AutoVISION and Visionscape Software
CloudLink Dashboard web HMI



*Color models are only supported by Visionscape

Important Pricing Discount Note Product discounts are applied based on the Product TYPE code shown in the TYPE column below.

Product Type codes are defined as: P = PRODUCT Discount, A = ACCESSORY Discount.

A Product Type code modified with L signifies Legacy Status (refer to Legacy section of this catalog).

Refer to your Partner Agreement for the actual discount percentage by Product Type.

Best Sellers
1) GMV-6800-1032G
2) GMV-6800-1002G
3) GMV-6800-1012G

Vision HAWK Smart Camera WVGA (752 x 480)

Part Number	Description	List Price	Type
GMV-6800-1010G	Vision HAWK, WVGA Mono, C-Mount, AV	€ 3,238	P
GMV-6800-1012G	Vision HAWK, WVGA Mono, C-Mount, VS+AV	€ 3,612	P
GMV-6800-1014G*	Vision HAWK, WVGA Mono, C-Mount, AV+Verif./OCV	€ 3,612	P
GMV-6800-1016G*	Vision HAWK, WVGA Mono, C-Mount, VS+AV+Verif./OCV	€ 3,892	P

* Verification calibration card not included in verification license

Vision HAWK Smart Camera 1.2 MP SXGA (1280 x 960)

Part Number	Description	List Price	Type
GMV-6800-1000G	Vision HAWK, SXGA Mono, C-Mount, AV	€ 3,436	P
GMV-6800-1002G	Vision HAWK, SXGA Mono, C-Mount, VS+AV	€ 3,808	P
GMV-6800-1004G*	Vision HAWK, SXGA Mono, C-Mount, AV+Verif./OCV	€ 3,808	P
GMV-6800-1006G*	Vision HAWK, SXGA Mono, C-Mount, VS+AV+Verif./OCV	€ 4,088	P

Vision HAWK Smart Camera 2MP WUXGA (2048 x 1088)

Part Number	Description	List Price	Type
GMV-6800-1030G	Vision HAWK, WUXGA Mono, C-Mount, AV	€ 5,242	P
GMV-6800-1032G	Vision HAWK, WUXGA Mono, C-Mount, VS+AV	€ 5,616	P
GMV-6800-1034G*	Vision HAWK, WUXGA Mono, C-Mount, AV+Verif./OCV	€ 5,616	P
GMV-6800-1036G*	Vision HAWK, WUXGA Mono, C-Mount, VS+AV+Verif./OCV	€ 5,896	P

* Verification calibration card not included in verification license

Vision HAWK Smart Camera 1.2MP SXGA (1280 960) Color

Part Number	Description	List Price	Type
GMV-6800-1022G	Vision HAWK, SXGA Color, C-Mount, VS+AV	€ 4,588	P

The Vision HAWK Color Smart Camera is not detected and listed as cameras that can be connected and programmed by AutoVISION.

It is detected and listed by Visionscape which is required for programming and monitoring.

Software

Part Number	Description	List Price	Type
98-000217-01	AV to VS License Upgrade	€ 500	A
98-000217-02	AV to VS Verif. & OCV License Upgrade	€ 402	A
98-000217-03	AV to VS with Verif. & OCV License Upgrade	€ 902	A
37-9000017-01*	Visionscape I-PAK VH, Inspection System Interface for Vision HAWK Smart Cameras	€ 1,925	VP

*Compatible with Vision HAWK Smart Camera models equipped with Visionscape license

Verification Calibration Card

Part Number	Description	List Price	Type
98-000265-01	AV Verif. Calibration Card with NIST-Traceable Measurement Report	€ 476	A
98-000265-02	AV Verif. Calibration Card	€ 226	A

QX-1 and Cordsets

Part Number	Description	List Price	Type
98-000103-02	QX-1 Interface Device	€ 196	A
61-000148-01	QX Cordset, Common, M12 12-Pin Socket (Ult.Lock)-to-M12 12-Pin Plug (Ult.Lock), 3m.	€ 74	A
61-000148-02	QX Cordset, Common, M12 12-Pin Socket (Screw-On)-to-M12 12-Pin Plug (Screw-On), 3m.	€ 96	A
61-000162-02	QX Cordset, Common, M12 12-Pin Socket (Screw-On)-to-M12 12-Pin Plug (Screw-On), 1m.	€ 92	A
61-000153-02	QX Cordset, Host, Serial, M12 12-Pin Socket (Screw-On)-to-DB-9 Socket, 1 m.	€ 92	A
61-000164-02	QX Cordset, Host, Serial, M12 12-Pin Socket (Screw-On)-to-DB-9 Socket, 3 m.	€ 96	A
61-000152-02	QX Cordset, Host, Serial, M12 12-Pin Plug (Screw-On)-to-DB-9 Socket, 1 m.	€ 92	A
61-000165-02	QX Cordset, Host, Serial M12 12-Pin Plug (Screw-On)-to-DB-9 Socket, 3 m.	€ 96	A
61-000163-03	QX Cordset, Host, Ethernet, M12 8-Pin Plug (Screw-On)-to-RJ45, 3 m.	€ 96	A
61-000160-03	QX Cordset, Host, Ethernet, M8 8-Pin Plug (Screw-On)-to-RJ45, 1 m.	€ 92	A
61-000172-02	QX Cordset, M12 12-Pin Plug-to-M12 12-Pin Socket-to-DB-25 Plug, Turck Connectors	€ 280	A
61-000158-03	QX Cordset, M12 12-Pin Plug & M12 12-Pin Socket-to-MS-Connect 210 (RS-232), 2 m.	€ 346	A
61-000166-02	QX Cordset, M12 12-Pin Plug (Screw-On)-to-Flying Leads, 3 m.	€ 96	A
61-000167-02	QX Cordset, M12 12-Pin Socket (Screw-On)-to-Flying Leads, 3 m.	€ 96	A
98-000013-04	Relay Module, 120VAC, 3 Amp Output, Series 70, Type SM, for MS-Connect 210 + MS-890	€ 56	A
98-000013-05	Relay Module, 240VAC, 3 Amp Output, Series 70, Type SM for MS-Connect 210 + MS-890	€ 56	A
98-000013-06	Relay Module, 24VDC, 3 Amp Output, Series 70, Type SM, for MS-Connect 210, MS-890	€ 56	A
61-000204-01	QX Cordset, Smart Series Light-to-QX-1, Continuous Power	€ 206	A
61-000207-01	QX Cordset, Smart Series Light-to-QX-1, Continuous ON/OFF	€ 232	A
61-000218-01*	QX Cordset, Smart series light to QX-1, strobe, NPN	€ 132	A

*Strobe is available on C-Mount Vision HAWK only

Power Supplies

Part Number	Description	List Price	Type
97-000012-01	Power Supply, 100-240VAC, +24VDC, M12 12-pin Socket	€ 140	A

Package Detector/Sensor

Part Number	Description	List Price	Type
99-000020-02	QX Photo Sensor, M12 4-Pin Plug, NPN, Dark On, 2 m.	€ 196	A
99-000020-01	QX Photo Sensor, M12 4-Pin Plug, NPN, Dark Off, 2 m.	€ 196	A

Mounting and Connectors

Part Number	Description	List Price	Type
20-610024-01	Trigger Connector, 4-Pin Plug (Screw Terminal, Field-Wireable) (Self-Wiring)	€ 36	A
98-000037-01	Mounting Arm Extension Kit, 6 in., All Readers	€ 62	A
98-000054-01	Kit, Mounting Stand Base Plate	€ 36	A
98-000016-01	Kit, 6 in. Mounting Arm/Adapter, MS-820, QX-830, QX-870	€ 120	A
99-000061-01	Bracket, Smart Series DOAL-50/70/100 mm-to-C-Mount Vision HAWK and QX Hawk	€ 256	A
99-000049-01	Bracket, Smart Series Ring-100 mm-to-C-Mount Vision HAWK & QX Hawk	€ 138	A
99-000051-01	Bracket, Smart Series Ring-R-60/70-to-C-Mount Vision HAWK & QX Hawk	€ 138	A
98-000148-01	Kit, L-Bracket, QX Series	€ 46	A

* Though-hole mounting plate; not for use with mounting arm.

Optical Accessories, C-Mount

Part Number	Description	List Price	Type
98-92800471	Lens Extension Tube, 5 mm (C-CS Mount Adapter)	€ 40	A
98-CO206	Lens Extension Tube Set, 0.5 mm, 1 mm, 5 mm, 10 mm, 20 mm, 40 mm	€ 146	A
98-92800571	Lens 8mm F/1.4-16, Front thread 25.5mm P 0.5mm, 2/3" C-mount	€ 386	A
98-000257-01*	Lens 12.5 mm F/1.4-close, Front Thread 40.5 mm P 0.5 mm, 1 in. C-Mount	€ 416	A
98-000258-01	Lens 16 mm F/1.4-16, Front Thread 27 mm P 0.5 mm, 2/3 in. C-Mount	€ 416	A
98-000259-01	Lens 25 mm F/1.4-16, Front Thread 27 mm P 0.5 mm, 2/3 in. C-Mount	€ 416	A
98-92800575	Lens, 35 mm F/2.1-22, Front Thread 25.5 mm P 0.5 mm, 2/3 in. C-Mount	€ 386	A
98-92800576	Lens, 50 mm F/2.8-22, Front Thread 25.5 mm P 0.5 mm, 2/3 in. C-Mount	€ 386	A
98-92800577	Lens, 75 mm F/3.9-32, Front Thread 25.5 mm P 0.5 mm, 2/3 in. C-Mount	€ 386	A
98-92800311	Lens, Skylight UV Filter, 25.5 mm	€ 76	A
98-92800371	Lens, Polarizing Filter, 25.5 mm, P0.5	€ 102	A
98-92800372	Lens, Polarizing Filter, 27 mm, P0.5	€ 102	A
98-000218-01	Lens Protection Housing, Standard Length (to 48 mm)	€ 316	A
98-000226-01	Lens Protection Housing, Long (to 72 mm)	€ 330	A

* This lens cannot be used in combination with the lens protection housings.

Software/Manuals

Part Number	Description	List Price	Type
37-000010-01*	Tools Drive, User Documentation, Software	€ 30	A

*One free per order

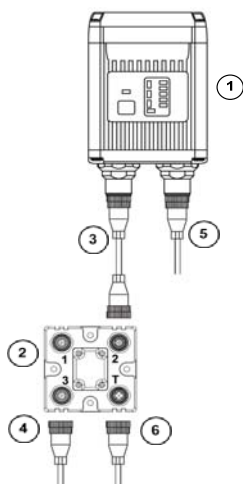

System Matrix

Item	Part Number	Description	List Price
1	GMV-6800-1XXXG	Vision HAWK Smart Camera	Varies
2	98-000103-02	QX-1 Interface Device	€ 196
3	61-000162-02	QX Cordset, Common, M12 12-Pin Socket(Screw-On)-to-M12 12-Pin Plug	€ 92
4	97-000012-01	Power Supply, 100-240VAC, +24VDC, M12 12-pin Socket	€ 140
5	61-000160-03	QX Cordset, Host, Ethernet, M8 8-Pin Plug (Screw-On)-to-RJ45, 1 m.	€ 92
6	99-000020-02	QX Photo Sensor, M12 4-Pin Plug, NPN, Dark On, 2 m.	€ 196
	37-000010-01	Tools Drive, User Documentation, Software	€ 30

* Cordsets available in multiple lengths

MICROSCAN

Visionscape GigE Solution

Rapid Application Development

Up to 8 Microscan GigE Cameras
Consult factory for 3rd party GigE Camera support

Flexible IO

PC Based discrete IO
Strobe and Trigger at camera

Out of Box Experience

Evaluation and Off-Line Programming is license free

Platforms and Customization

Windows XP and Windows 7
Microsoft Visual Studio 6 and .NET



Best Sellers
1) GMV-VGL8-1DD1
2) GMV-VGL0-1DD1
3) 98-000222-01
4) 98-000120-01

****Important Pricing Discount Note** Product discounts are applied based on the Product TYPE code shown in the TYPE column below.**

Product Type codes are defined as: P = PRODUCT Discount, A = ACCESSORY Discount.

A Product Type code modified with L signifies Legacy Status (refer to Legacy section of this catalog).

Refer to your Partner Agreement for the actual discount percentage by Product Type.

Visionscape Software

Part Number	Description	List Price	Type
GMV-VGL0-1DD1	VS GigE License Key with Intellifind & DIVs	€ 1,748	P
GMV-VGL8-1DD1	VS GigE License Key with Intellifind DIVs, Eight Third-Party GigE Cameras	€ 4,004	P

GigE Cameras

Part Number	Description	List Price	Type
98-000115-01	VS GigE Camera, 0.3 MP Mono, CMG03, 656x494 Pixels, CCD	€ 960	A
98-000116-01	VS GigE Camera, 0.3 MP Color, CMG03c, 656x494 Pixels, CCD	€ 1,200	A
98-000141-01	VS GigE Camera, 0.3 MP, Mono, CMG04, 656x494 Pixels, CCD, 1/2 in. Sensor	€ 1,602	A
98-000117-01	VS GigE Camera, 0.8 MP Mono, CMG08, 1032x776 Pixels, CCD	€ 1,602	A
98-000267-01	VS GigE Camera, 0.3 MP Mono, CMG04h, 640x480 Pixels, CCD, High Speed	€ 3,596	A
98-000220-01	VS GigE Camera, 0.8 MP Color, CMG08c, 1032x776 Pixels, CCD	€ 1,602	A
98-000118-01	VS GigE Camera, 1.3 MP Mono, CMG13, 1392x1040 Pixels, CCD	€ 2,096	A
98-000221-01	VS GigE Camera, 1.3 MP Color, CMG13c, 1392x1040 Pixels, CCD	€ 2,246	A
98-000119-01	VS GigE Camera, 2 MP Mono, CMG20, 1624x1236 Pixels, CCD	€ 2,596	A
98-000189-01	VS GigE Camera, 2 MP Color, CMG20c, 1624x1236 Pixels, CCD	€ 2,896	A
98-000120-01	VS GigE Camera, 5 MP Mono, CMG50, 2448x2050 Pixels, CCD	€ 4,496	A
98-000190-01	VS GigE Camera, 5 MP Color, CMG50c, 2448x2050 Pixels, CCD	€ 4,996	A
98-000222-01	VS GigE Camera, 5 MP Mono, CMGC50, 2592x1944 Pixels, CMOS	€ 1,696	A
98-000230-01	VS GigE Camera, 5 MP Color, CMGC50c, 2592x1944 Pixels, CMOS	€ 1,996	A
98-000260-01	VS GigE Camera, 8 MP Mono, CMG80, 3296x2472 Pixels, CCD	€ 12,496	A

Accessories

Part Number	Description	List Price	Type
98-000130-01	VS GigE, PCIe I/O Card, 16 Inputs/16 Outputs, NPN with Cable & Terminal	€ 796	A
98-000142-01	VS GigE, PCIe I/O Card, 16 Inputs/16 Outputs, PNP with Cable & Terminal	€ 802	A
98-000140-01	Single Port GigE Network Interface Card PCIe	€ 146	A
98-000132-01	Dual Port GigE Network Interface Card PCIe	€ 402	A
98-000138-01	VS GigE Camera Power Supply, 24V, U.S./Euro/UK	€ 106	A
98-000126-01	Visionscape GigE Camera, Trigger & Strobe Cable, M8 4-Pin, 5 m., Open-End Cable	€ 86	A
98-000129-01	VS GigE Camera, Power Cable, M8 3-Pin, 5 m., Open-End	€ 80	A
98-000133-01	CAT 6 Ethernet Cable Jack Screw-to-RJ45 High Flex 2 m.	€ 92	A
98-000134-01	CAT 6 Ethernet Cable Jack Screws-to-RJ45 High Flex 5 m.	€ 116	A
98-000139-01**	VS GigE Demo Kit, License Key, CMG03, Power Supply, Cables, Lens	€ 4,236	A
98-000199-01*	VS GigE Demo Kit, License Key, Camera Not Included, Power Supply, Cables, Lens	€ 3,506	A

** Demo Kit contains Camera. Kit is discounted 25%.

* This Demo Kit does not contain a camera and is discounted 25%. The separately purchased camera is discounted 30%.

MICROSCAN

Optical Accessories, C-Mount

Part Number	Description	List Price	Type
98-92800471	Lens Extension Tube, 5 mm (C-CS Mount Adapter)	€ 40	A
98-CO206	Lens Extension Tube Set, 0.5 mm, 1 mm, 5 mm, 10 mm, 20 mm, 40 mm	€ 146	A
98-92800571	Lens 8mm F/1.4-16, Front thread 25.5mm P 0.5mm, 2/3" C-mount	€ 386	A
98-000257-01	Lens 12.5 mm F/1.4-close, Front Thread 40.5 mm P 0.5 mm, 1 in. C-Mount	€ 416	A
98-000258-01	Lens 16 mm F/1.4-16, Front Thread 27 mm P 0.5 mm, 2/3 in. C-Mount	€ 416	A
98-000259-01	Lens 25 mm F/1.4-16, Front Thread 27 mm P 0.5 mm, 2/3 in. C-Mount	€ 416	A
98-92800575	Lens, 35 mm F/2.1-22, Front Thread 25.5 mm P 0.5 mm, 2/3 in. C-Mount	€ 386	A
98-92800576	Lens, 50 mm F/2.8-22, Front Thread 25.5 mm P 0.5 mm, 2/3 in. C-Mount	€ 386	A
98-92800577	Lens, 75 mm F/3.9-32, Front Thread 25.5 mm P 0.5 mm, 2/3 in. C-Mount	€ 386	A
98-92800311	Lens, Skylight UV Filter, 25.5 mm	€ 76	A
98-92800371	Lens, Polarizing Filter, 25.5 mm, P0.5	€ 102	A
98-92800372	Lens, Polarizing Filter, 27 mm, P0.5	€ 102	A
98-000218-01	Lens Protection Housing, Standard Length (to 48 mm)	€ 316	A
98-000226-01	Lens Protection Housing, Long (to 72 mm)	€ 330	A

DOAL Camera Mounting Brackets

Part Number	Description	List Price	Type
99-000062-01	Bracket, Smart Series Ring-60/70 mm-to-GigE Camera	€ 156	A
99-000063-01	Bracket, Smart Series DOAL-to-GigE Camera	€ 306	A
99-000064-01	Bracket, Smart Series Ring-100 mm-to-GigE Camera	€ 170	A

Software/Manuals

Part Number	Description	List Price	Type
37-000010-01*	Tools Drive, User Documentation, Software	€ 30	A

* 1 free per order.

MICROSCAN.

NERLITE® PHARMALITE

NERLITE® Smart Series Pharmalite uses MAX Light LEDs and feature an integrated strobe controller for easy integration in industrial applications. It can be mounted easily on the QX Hawk, Vision HAWK, Vision MINI, MINI Hawk and GigE Cameras without using an additional bracket.



Best Seller

98-000228-01

****Important Pricing Discount Note** Product discounts are applied based on the Product TYPE code shown in the TYPE column below.**

Product Type codes are defined as: P = PRODUCT Discount, A = ACCESSORY Discount.

A Product Type code modified with L signifies Legacy Status (refer to Legacy section of this catalog).

Refer to your Partner Agreement for the actual discount percentage by Product Type.

Pharmalite			
98-000228-01	Smart Series Pharmalite, 60°, Dark Field, White, M12 Connector	€ 1,152	P

Power Supply

Part Number	Description	List Price	Type
NER-011504100	DSP60 24VDC 2.5A DIN Mount Power Supply	€ 210	A
97-000006-01	DSP100, 24VDC, 4.2A DIN Mount Power Supply	€ 260	A

Power Supply Cordsets

Part Number	Description	List Price	Type
NER-030028300	AC Power Cord for DSPxx Power Supply, U.S.	€ 62	A
NER-030028400	AC Power Cord for DSPxx Power Supply, EU	€ 62	A
NER-030028500	AC Power Cord for DSPxx Power Supply, UK	€ 62	A
61-000186-01	Cable, M12 5-Pin Socket-to-Flying Leads, 3 m.	€ 72	A
61-000187-01	Cable, M12 5-Pin Socket-to-Flying Leads, 5 m.	€ 126	A
61-000204-01	QX Cordset, Smart Series Light-to-QX-1, Continuous Power	€ 206	A
61-000207-01	QX Cordset, Smart Series Light-to-QX-1, Continuous ON/OFF	€ 232	A
61-000218-01	QX Cordset, Smart series light to QX-1, strobe, NPN	€ 132	A

Strobe is available on C-Mount Vision HAWK only

Tech Reference *Pharmalite*

Hardware Required		
Item	Description	Part Number
1	Smart Series Pharmalite	98-000228-01
2	Power Supply DSP60 24VDC 2.5A DIN Mount	NER-011504100
2	Power Supply DSP100 24VDC 4.2A DIN Mount	97-000006-01
3	Cable 5 Pin M12 Female To Flying Leads, 3M	61-000186-01
3	Cable 5 Pin M12 Female To Flying Leads, 5M	61-000187-01
4	QX Cordset, Smart Series to QX-1 Continuous	61-000204-01
4	QX Cordset, Smart Series to QX-1, Continuous On/Off	61-000207-01
4	QX Cordset, Smart Series to QX-1 Strobe, NPN	61-000218-01
5	QX-1 Interface Device	98-000103-02

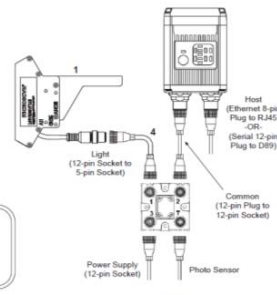
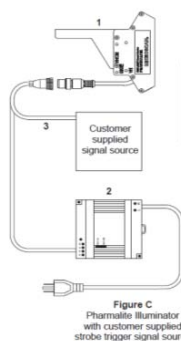
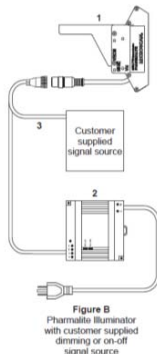
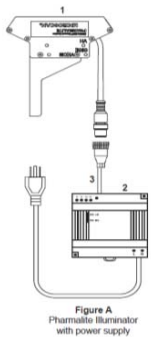

MICROSCAN.

NERLITE® SMART DOAL® LIGHTS

NERLITE® Smart Series DOAL lights use MAX Light LEDs and feature an integrated strobe controller for easy integration in industrial applications.



Best Sellers
1) NER-011660500G
2) NER-011660700G

****Important Pricing Discount Note**** Product discounts are applied based on the Product TYPE code shown in the TYPE column below.

Product Type codes are defined as: P = PRODUCT Discount, A = ACCESSORY Discount.

A Product Type code modified with L signifies Legacy Status (refer to Legacy section of this catalog).

Refer to your Partner Agreement for the actual discount percentage by Product Type.

25 mm			
Part Number	Description	List Price	Type
NER-011660400G	Smart Series DOAL, 25 mm, Red, M12 Connector	€ 446	P
NER-011660410G	Smart Series DOAL, 25 mm, White, M12 Connector	€ 520	P
NER-011660420G	Smart Series DOAL, 25 mm, Blue, M12 Connector	€ 548	P
50 mm			
NER-011660500G	Smart Series DOAL, 50 mm, Red, M12 Connector	€ 548	P
NER-011660510G	Smart Series DOAL, 50 mm, White, M12 Connector	€ 810	P
NER-011660520G	Smart Series DOAL, 50 mm, Blue, M12 Connector	€ 822	P
75 mm			
NER-011660600G	Smart Series DOAL, 75 mm, Red, M12 Connector	€ 1,096	P
NER-011660610G	Smart Series DOAL, 75 mm, White, M12 Connector	€ 1,358	P
NER-011660620G	Smart Series DOAL, 75 mm, Blue, M12 Connector	€ 1,390	P
100 mm			
NER-011660700G	Smart Series DOAL, 100 mm, Red, M12 Connector	€ 1,544	P
NER-011660710G	Smart Series DOAL, 100 mm, White, M12 Connector	€ 2,144	P
NER-011660720G	Smart Series DOAL, 100 mm, Blue, M12 Connector	€ 2,144	P
Power Supply (25mm to 50mm)			
Part Number	Description	List Price	Type
NER-011504100	DSP60 24VDC 2.5A DIN Mount Power Supply	€ 210	A
Power Supply (50mm to 100mm)			
97-000006-01	DSP100, 24VDC, 4.2A DIN Mount Power Supply	€ 260	A
Power Supply Cordsets and Cables			
Part Number	Description	List Price	Type
NER-030028300	AC Power Cord for DSPxx Power Supply, U.S.	€ 62	A
NER-030028400	AC Power Cord for DSPxx Power Supply, EU	€ 62	A
NER-030028500	AC Power Cord for DSPxx Power Supply, UK	€ 62	A
61-000186-01	Cable, M12 5-Pin Socket-to-Flying Leads, 3 m.	€ 72	A
61-000218-01	QX Cordset, Smart series light to QX-1, strobe, NPN	€ 132	A
61-000207-01	QX Cordset, Smart Series Light-to-QX-1, Continuous ON/OFF	€ 232	A
61-000204-01	QX Cordset, Smart Series Light-to-QX-1, Continuous Power	€ 206	A
61-000187-01	Cable, M12 5-Pin Socket-to-Flying Leads, 5 m.	€ 126	A

DOAL Camera Mounting Brackets			
Part Number	Description	List Price	Type
99-000057-01	Bracket, Smart Series DOAL-75 mm-to-Vision MINI & MINI Hawk	€ 256	A
99-000061-01	Bracket, Smart Series DOAL-50/70/100 mm-to-C-Mount Vision HAWK and QX Hawk	€ 256	A
99-000063-01	Bracket, Smart Series DOAL-to-GigE Camera	€ 306	A

Tech Reference *DOAL Lights*

Hardware Required		
Item	Description	Part Number
1	Smart Series DOAL Lights	NER-011660XXXG
2	Power Supply DSP60 24VDC 2.5A DIN Mount	NER-011504100
2	Power Supply DSP100 24VDC 4.2A DIN Mount	97-000006-01
3	Cable 5 Pin M12 Female To Flying Leads, 3M	61-000186-01
3	Cable 5 Pin M12 Female To Flying Leads, 5M	61-000187-01
4	QX Cordset, Smart Series to QX-1 Continuous	61-000204-01
4	QX Cordset, Smart Series to QX-1, Continuous On/Off	61-000207-01
4	QX Cordset, Smart Series to QX-1 Strobe, NPN	61-000218-01
5	QX-1 Interface Device	98-000103-02

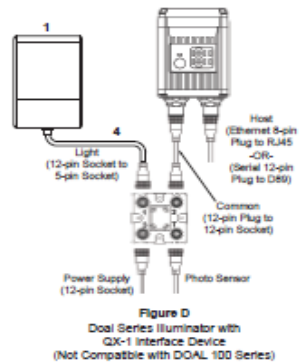
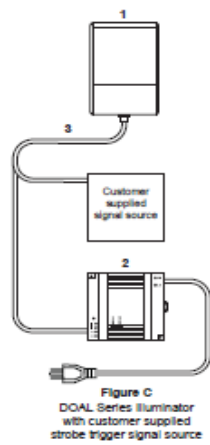
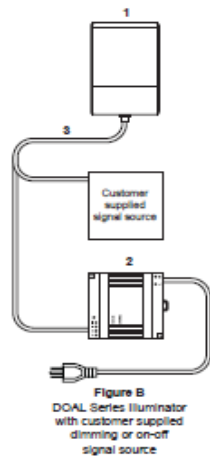
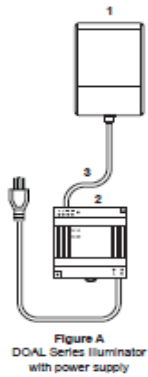
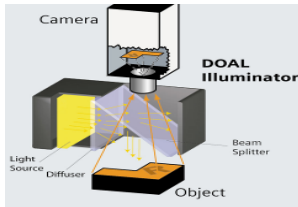

5

MICROSCAN

NERLITE® SMART RING LIGHTS

NERLITE® Smart Series Ring Lights use MAX Light LEDs and feature an integrated strobe controller for easy integration in industrial applications.



Best Sellers	
1)	NER-011660810G
2)	NER-011661110G

****Important Pricing Discount Note**** Product discounts are applied based on the Product TYPE code shown in the TYPE column below.

Product Type codes are defined as: P = PRODUCT Discount, A = ACCESSORY Discount.

A Product Type code modified with L signifies Legacy Status (refer to Legacy section of this catalog).

Refer to your Partner Agreement for the actual discount percentage by Product Type.

60 mm			
Part Number	Description	List Price	Type
NER-011660800G	Smart Series Ring, 60 mm, Red, M12 Connector	€ 412	P
NER-011660810G	Smart Series Ring, 60 mm, White, M12 Connector	€ 482	P
NER-011660820G	Smart Series Ring, 60 mm, Blue, M12 Connector	€ 472	P
NER-011660840G	Smart Series Ring, 60 mm, Ultraviolet, M12 Connector	€ 482	P
70 mm			
NER-011660900G	Smart Series Ring, 70 mm, Red, M12 Connector	€ 438	P
NER-011660910G	Smart Series Ring, 70 mm, White, M12 Connector	€ 516	P
NER-011660920G	Smart Series Ring, 70 mm, Blue, M12 Connector	€ 516	P
100 mm			
NER-011661100G	Smart Series Ring, 100 mm, Red, M12 Connector	€ 580	P
NER-011661110G	Smart Series Ring, 100 mm, White, M12 Connector	€ 690	P
NER-011661120G	Smart Series Ring, 100 mm, Blue, M12 Connector	€ 680	P
Power Supply			
Part Number	Description	List Price	Type
NER-011504100	DSP60 24VDC 2.5A DIN Mount Power Supply	€ 210	A
97-000006-01	DSP100, 24VDC, 4.2A DIN Mount Power Supply	€ 260	A
Power Supply Cordsets			
Part Number	Description	List Price	Type
NER-030028300	AC Power Cord for DSPxx Power Supply, U.S.	€ 62	A
NER-030028400	AC Power Cord for DSPxx Power Supply, EU	€ 62	A
NER-030028500	AC Power Cord for DSPxx Power Supply, UK	€ 62	A
61-000186-01	Cable, M12 5-Pin Socket-to-Flying Leads, 3 m.	€ 72	A
61-000187-01	Cable, M12 5-Pin Socket-to-Flying Leads, 5 m.	€ 126	A
61-000218-01	QX Cordset, Smart series light to QX-1, strobe, NPN	€ 132	A
61-000207-01	QX Cordset, Smart Series Light-to-QX-1, Continuous ON/OFF	€ 232	A
61-000204-01	QX Cordset, Smart Series Light-to-QX-1, Continuous Power	€ 206	A

NERLITE® RING LIGHT ACCESSORIES

Note: For mounting and alternate focused optics use the following

60 mm Mounts and Optics			
Part Number	Description	List Price	Type
99-000026-01	R-60 Focusing Lens, Focal Length = 70 mm	€ 152	A
99-000026-02	R-60 Focusing Lens, Focal Length = 102 mm	€ 152	A
99-000026-03	R-60 Focusing Lens, Focal Length = 127 mm	€ 152	A
99-000025-01	R-60 Lens Adapter, 25.5 mmx0.50 mm	€ 66	A
99-000025-02	R-60 Lens Adapter, 27.0 mmx0.50 mm	€ 66	A
99-000025-03	R-60 Lens Adapter, 30.5 mmx0.50 mm	€ 66	A
99-000025-04	R-60 Lens Adapter, 40.5 mmx0.50 mm	€ 66	A
99-000025-05	R-60 Lens Adapter, 46.0 mmx0.75 mm	€ 66	A
70 mm Mounts and Optics			
99-000028-01	R-70 Focusing Lens, Focal Length = 70 mm	€ 152	A
99-000028-02	R-70 Focusing Lens, Focal Length = 102 mm	€ 152	A
99-000028-03	R-70 Focusing Lens, Focal Length = 127 mm	€ 152	A
99-000027-01	R-70 Lens Adapter, 25.5 mmx0.50 mm	€ 66	A
99-000027-02	R-70 Lens Adapter, 27.0 mmx0.50 mm	€ 66	A
99-000027-03	R-70 Lens Adapter, 30.5 mmx0.50 mm	€ 66	A
99-000027-04	R-70 Lens Adapter, 40.5 mmx0.50 mm	€ 66	A

100 mm Mounts and Optics			
99-000030-01	R-100 Focusing Lens, Focal Length = 70 mm	€ 152 A	
99-000030-02	R-100 Focusing Lens, Focal Length = 102 mm	€ 152 A	
99-000030-03	R-100 Focusing Lens, Focal Length = 127 mm	€ 152 A	
99-000030-04	R-100 Focusing Lens, Focal Length = 152 mm	€ 152 A	
99-000029-01	R-100 Lens Adapter, 25.5 mmx0.50 mm	€ 66 A	
99-000029-02	R-100 Lens Adapter, 27.0 mmx0.50 mm	€ 66 A	
99-000029-03	R-100 Lens Adapter, 30.5 mmx0.50 mm	€ 66 A	
99-000029-04	R-100 Lens Adapter, 40.5 mmx0.50 mm	€ 66 A	
Ring Light Camera Mounting Brackets			
Part Number	Description	List Price	Type
99-000053-01	Bracket, Smart Series Ring-60/70 mm-to-Vision MINI & MINI Hawk	€ 138	A
99-000054-01	Bracket, Smart Series Ring-100 mm-to-Vision MINI & MINI Hawk	€ 138	A
99-000049-01	Bracket, Smart Series Ring-100 mm-to-C-Mount Vision HAWK & QX Hawk	€ 138	A
99-000051-01	Bracket, Smart Series Ring-R-60/70-to-C-Mount Vision HAWK & QX Hawk	€ 138	A
99-000062-01	Bracket, Smart Series Ring-60/70 mm-to-GigE Camera	€ 156	A
99-000064-01	Bracket, Smart Series Ring-100 mm-to-GigE Camera	€ 170	A

Tech Reference *Ring Lights*

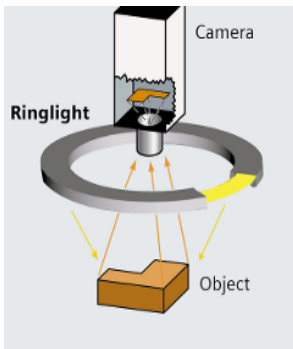

Hardware Required		
Item	Description	Part Number
1	Smart Series Ring Lights	Various
2	Power Supply DSP60 24VDC 2.5A DIN Mount	NER-011504100
2	Power Supply DSP100 24VDC 4.2A DIN Mount	97-000006-01
3	Cable 5 Pin M12 Female To Flying Leads, 3M	61-000186-01
3	Cable 5 Pin M12 Female To Flying Leads, 5M	61-000187-01
4	QX Cordset, Smart Series to QX-1 Continuous	61-000204-01
4	QX Cordset, Smart Series to QX-1, Continuous On/Off	61-000207-01
4	QX Cordset, Smart Series to QX-1 Strobe, NPN	61-000218-01
5	QX-1 Interface Device	98-000103-02

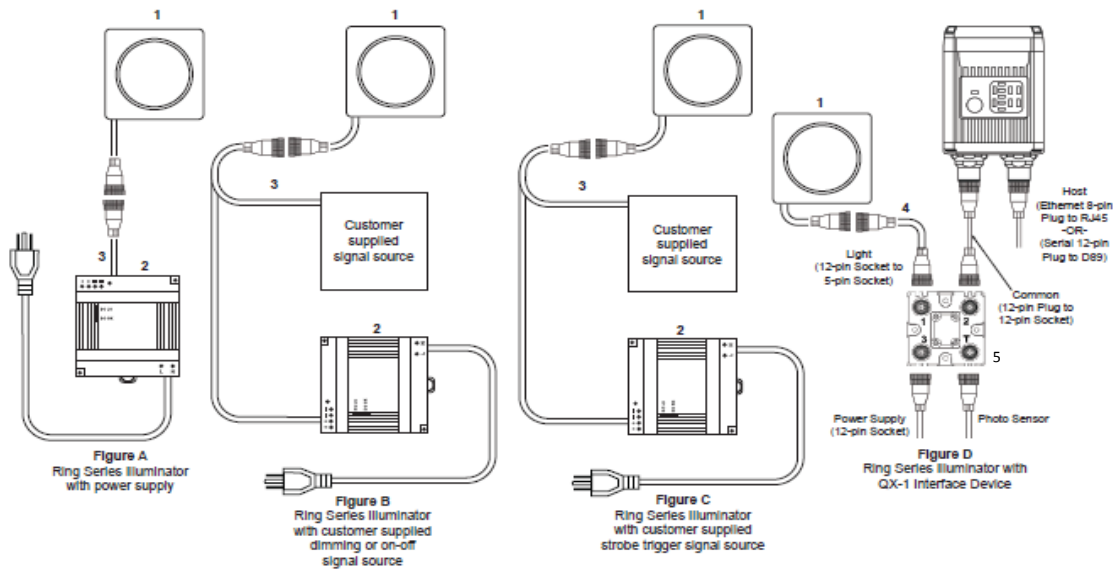

MICROSCAN.

MAX Lights

MAX lights are designed to provide high intensity illumination over a large area. MAX lights have an industrial design with IP67 enclosure and built in controller.



Best Sellers
1) NER-011660211G
2) NER-011660311G

****Important Pricing Discount Note** Product discounts are applied based on the Product TYPE code shown in the TYPE column below.**

Product Type codes are defined as: P = PRODUCT Discount, A = ACCESSORY Discount.

A Product Type code modified with L signifies Legacy Status (refer to Legacy section of this catalog).

Refer to your Partner Agreement for the actual discount percentage by Product Type.

MAX 300 mm

Part Number	Description	List Price	Type
NER-011660300G	Smart Series MAX Narrow, 300 mm, Red, M12 Connector	€ 822	P
NER-011660310G	Smart Series MAX Narrow, 300 mm, White, M12 Connector	€ 866	P
NER-011660301G	Smart Series MAX Wide, 300 mm, Red, M12 Connector	€ 822	P
NER-011660311G	Smart Series MAX Wide, 300 mm, White, M12 Connector	€ 866	P

MAX 100 mm

NER-011660200G	Smart Series MAX Narrow, 100 mm, Red, M12 Connector	€ 636	P
NER-011660210G	Smart Series MAX Narrow, 100 mm, White, M12 Connector	€ 684	P
NER-011660201G	Smart Series MAX Wide, 100 mm, Red, M12 Connector	€ 636	P
NER-011660211G	Smart Series MAX Wide, 100 mm, White, M12 Connector	€ 684	P

MAX 45 mm

NER-011660100G	Smart Series MAX Narrow, 45 mm, Red, M12 Connector	€ 366	P
NER-011660110G	Smart Series MAX Narrow, 45 mm, White, M12 Connector	€ 412	P
NER-011660101G	Smart Series MAX Wide, 45 mm, Red, M12 Connector	€ 366	P
NER-011660111G	Smart Series MAX Wide, 45 mm, White, M12 Connector	€ 412	P

MAX 300 mm - Focused Line Light

NER-011661710G	Smart Series MAX Focused Line Light, 300 mm, White, M12 Connector	€ 1,024	P
----------------	---	---------	---

MAX Cables (Not included with light)

Part Number	Description	List Price	Type
61-000184-01	Cable, M12 5-Pin Plug-to-M12 5-Pin Socket, 1 m., Shielded (for Daisy Chain)	€ 66	A
61-000185-01	Cable, M12 5-Pin Plug-to-M12 5-Pin Socket, 3 m., Shielded (for Daisy Chain)	€ 76	A
61-000204-01	QX Cordset, Smart Series Light-to-QX-1, Continuous Power	€ 206	A
61-000218-01	QX Cordset, Smart series light to QX-1, strobe, NPN	€ 132	A
61-000207-01	QX Cordset, Smart Series Light-to-QX-1, Continuous ON/OFF	€ 232	A
61-000186-01	Cable, M12 5-Pin Socket-to-Flying Leads, 3 m.	€ 72	A
61-000187-01	Cable, M12 5-Pin Socket-to-Flying Leads, 5 m.	€ 126	A

Power Supply

MAX Lights	Description	List Price	Type
NER-011504100	DSP60 24VDC 2.5A DIN Mount Power Supply	€ 210	A
97-000006-01	DSP100, 24VDC, 4.2A DIN Mount Power Supply	€ 260	A

Power Supply Cordsets

Part Number	Description	List Price	Type
NER-030028300	AC Power Cord for DSPxx Power Supply, U.S.	€ 62	A
NER-030028400	AC Power Cord for DSPxx Power Supply, EU	€ 62	A
NER-030028500	AC Power Cord for DSPxx Power Supply, UK	€ 62	A

Camera Mounting Brackets

Part Number	Description	List Price	Type
98-000268-01	Accessory, Bracket, MAX 300 Smart Light-to-C-Mount Vision HAWK & QX Hawk	€ 566	A

Tech Reference *MAX Lights*

Hardware Required		
Item	Description	Part Number
1	Smart Series MAX Light	NER-011660XXG
2	Power Supply DSP60 24VDC 2.5A DIN Mount	NER-011504100
2	Power Supply DSP100 24VDC 4.2A DIN Mount	97-000006-01
3	Cable 5 Pin M12 Female To Flying Leads, 3M	61-000186-01
3	Cable 5 Pin M12 Female To Flying Leads, 5M	61-000187-01
4	Cable, 5P M12 Male to 5P M12 Female, 1M	61-000184-01
4	Cable, 5P M12 Male to 5P M12 Female, 3M	61-000185-01
5	QX Cordset, Smart Series to QX-1 Continuous	61-000204-01
5	QX Cordset, Smart Series to QX-1, Continuous On/Off	61-000207-01
5	QX Cordset, Smart Series to QX-1 Strobe, NPN	61-000218-01
6	QX-1 Interface Device	98-000103-02

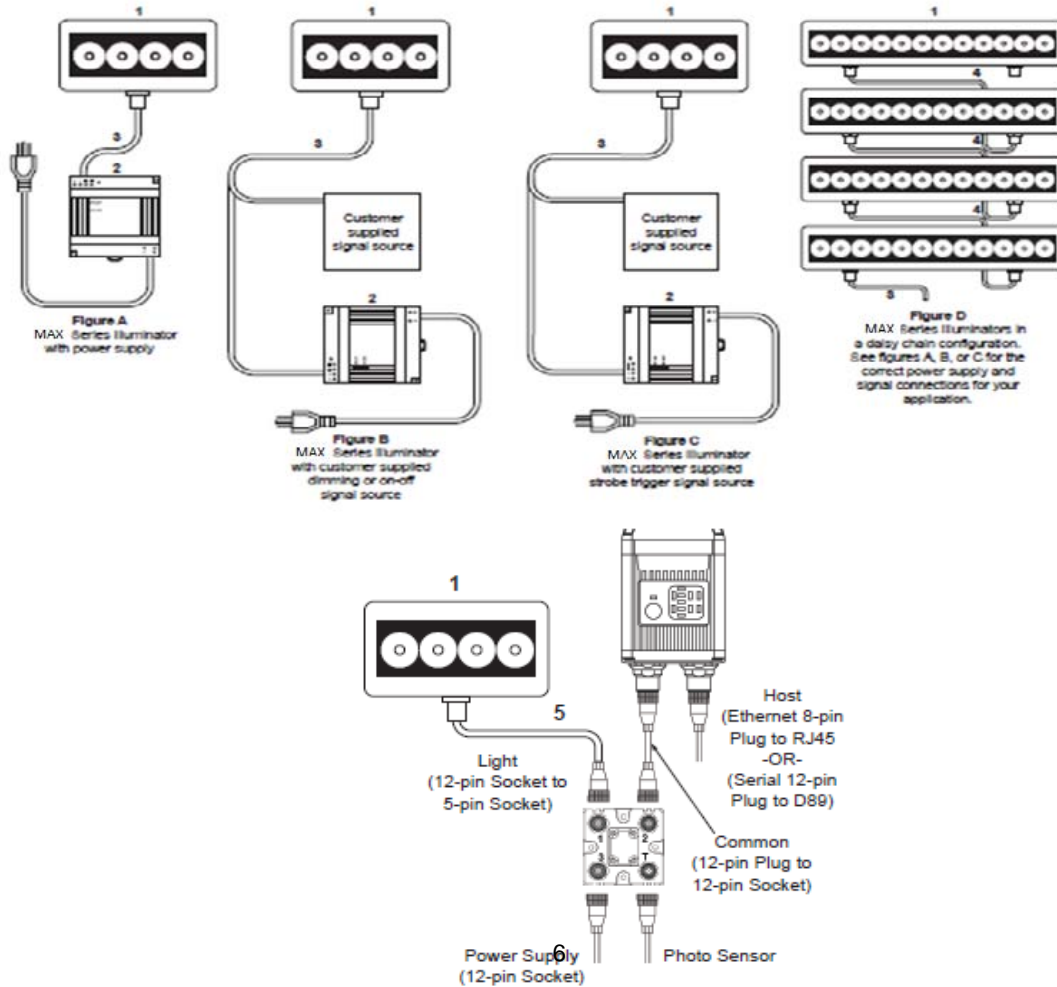

MICROSCAN.

AREA ARRAYS

Area Arrays are designed for non-specular surface lighting in applications that demand economical solutions.



Best Sellers
1) NER-011652115
2) NER-011904201

****Important Pricing Discount Note**** Product discounts are applied based on the Product TYPE code shown in the TYPE column below.

Product Type codes are defined as: P = PRODUCT Discount, A = ACCESSORY Discount.

A Product Type code modified with L signifies Legacy Status (refer to Legacy section of this catalog).

Refer to your Partner Agreement for the actual discount percentage by Product Type.

Area Arrays 50X50 Continuous		
NER-011652115	NERLITE AR-50x50-HO, Red, Non-Diffuse, Array, 24V Continuous, Open-End Cable	€ 346 P
NER-011652114	NERLITE AR-50x50-HO, White, Non-Diffuse, Array, 24V Continuous, Open-End Cable	€ 450 P
Area Arrays 75X75 Continuous		
NER-011903401	NERLITE AR-75x75-HO, Red, Array, 24V Continuous, Open-End Cable	€ 518 P
NER-011903502	NERLITE AR-75x75-HO, White, Array, 24V Continuous, Open-End Cable	€ 802 P
Area Arrays 100X100 Continuous		
NER-011904101	NERLITE AR-100x100-HO, Red, Array, 24V Continuous, Open-End Cable	€ 842 P
NER-011904201	NERLITE AR-100x100-HO, White, Array, 24V Continuous, Open-End Cable	€ 1,162 P
Power Supply/Controllers		
NER-011504100	DSP60 24VDC 2.5A DIN Mount Power Supply	€ 210 A
98-000152-01*	NL-200 Lighting Controller (Front Panel Control Only)	€ 884 A
98-000152-02*	NL-220 Lighting Controller (Ethernet Control Only)	€ 1,274 A
98-000152-03*	NL-220F Lighting Controller (Ethernet Control Only with Fast Strobe Capability)	€ 1,622 A
Power Supply Cordsets		
030-028300	AC Power Cord for DSPxx Power Supply, U.S.	€ 62 A
030-028400	AC Power Cord for DSPxx Power Supply, EU	€ 62 A
030-028500	AC Power Cord for DSPxx Power Supply, UK	€ 62 A

*Note: Can be used to control intensity of continuous lights

Tech Reference Arrays

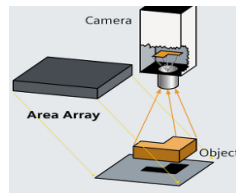
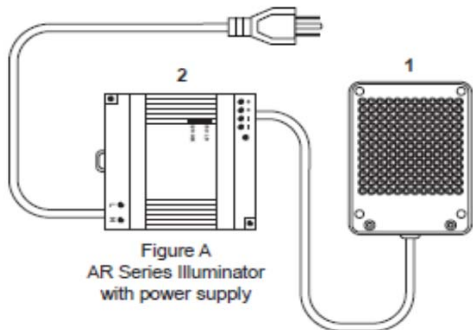

Hardware Required

Item	Description	Part Number
1	AR Series Illuminators	NER-011XXXXXX
2	Power Supply DSP60 24VDC 2.5A DIN Mount	NER-011504100

MICROSCAN.

NERLITE® BACKLIGHTS with "Edge-to-Edge" Lighting

Backlights provide sharp contrast to outline a parts shape, hide clear housings, and view openings such as drilled holes.



Best Sellers
1) NER-011659510G
2) NER-011659300G

****Important Pricing Discount Note**** Product discounts are applied based on the Product TYPE code shown in the TYPE column below.

Product Type codes are defined as: P = PRODUCT Discount, A = ACCESSORY Discount.

A Product Type code modified with L signifies Legacy Status (refer to Legacy section of this catalog).

Refer to your Partner Agreement for the actual discount percentage by Product Type.

Note: For basic applications continuous lights only require a light + power supply

Backlights 47X59 Continuous

Part Number	Description	List Price	Type
NER-011659300G	NERLITE 47x59 mm, Red, Backlight, 24V Continuous, 150 mm, Cable M12	€ 504	P
NER-011659310G	NERLITE 47x59 mm, White, Backlight, 24V Continuous, 150 mm, Cable M12	€ 636	P

Backlights 71X88 Continuous

NER-011659400G	NERLITE 71x88 mm, Red, Backlight, 24V Continuous, 150 mm, Cable M12	€ 584	P
NER-011659410G	NERLITE 71x88 mm, White, Backlight, 24V Continuous, 150 mm, Cable M12	€ 722	P

Backlights 100X100 Continuous

NER-011659500G	NERLITE 100x100 mm, Red, Backlight, 24V Continuous, 150 mm, Cable M12	€ 624	P
NER-011659510G	NERLITE 100x100 mm, White, Backlight, 24V Continuous, 150 mm, Cable M12	€ 802	P

Backlights 50X200 Continuous

NER-011659600G	NERLITE 50x200 mm, Red, Backlight, 24V Continuous, 150 mm, Cable M12	€ 624	P
NER-011659610G	NERLITE 50x200 mm, White, Backlight, 24V Continuous, 150 mm, Cable M12	€ 802	P

Power Supply Backlights Continuous

NER-011504100	DSP60 24VDC 2.5A DIN Mount Power Supply	€ 210	A
---------------	---	-------	---

Power Supply Cordsets

NER-030028300	AC Power Cord for DSPxx Power Supply, U.S.	€ 62	A
NER-030028400	AC Power Cord for DSPxx Power Supply, EU	€ 62	A
NER-030028500	AC Power Cord for DSPxx Power Supply, UK	€ 62	A

Backlight Accessories

NER-030029100	Cable, NERLITE, 4.5M, M12 5-Pin-to-Open-End Cable	€ 56	A
---------------	---	------	---

Note: For high speed or high intensity applications strobed lights require a light + controller + power supply

Backlights 47X59 Strobed

NER-011659301G	NERLITE 47x59 mm, Red, Backlight, Current Control, 150 mm, Cable M12	€ 504	P
----------------	--	-------	---

Backlights 71X88 Strobed

NER-011659401G	NERLITE 71x88 mm, Red, Backlight, Current Control, 150 mm, Cable M12	€ 584	P
----------------	--	-------	---

Backlights 100X100 Strobed

NER-011659501G	NERLITE 100x100 mm, Red, Backlight, Current Control, 150 mm, Cable M12	€ 624	P
----------------	--	-------	---

Backlights 50X200 Strobed

NER-011659601G	NERLITE 50x200 mm, Red, Backlight, Current Control, 150 mm, Cable M12	€ 624	P
----------------	---	-------	---

Power Supply/Controllers

NER-011504100	DSP60 24VDC 2.5A DIN Mount Power Supply	€ 210	A
98-000152-01*	NL-200 Lighting Controller (Front Panel Control Only)	€ 884	A
98-000152-02*	NL-220 Lighting Controller (Ethernet Control Only)	€ 1,274	A
98-000152-03*	NL-220F Lighting Controller (Ethernet Control Only with Fast Strobe Capability)	€ 1,622	A

*Note: Can also be used to control intensity of continuous lights

Power Supply Cordsets

030-028300	AC Power Cord for DSPxx Power Supply, U.S.	€ 62	A
030-028400	AC Power Cord for DSPxx Power Supply, EU	€ 62	A
030-028500	AC Power Cord for DSPxx Power Supply, UK	€ 62	A

Backlight Accessories

NER-030029100	Cable, NERLITE, 4.5M, M12 5-Pin-to-Open-End Cable	€ 56	A
---------------	---	------	---

Part Number	Description	Item
NER-011659XXXG	Edge to Edge Backlight Series	1
NER-011504100	DSP60 24VDC 2.5A DIN Mount Power Supply	2
98-000152-0X	NL200 Lighting Controller	3
NER-030029100	Cable, NERLITE, 4.5M, M12 5-Pin-to-Open-End Cable	4

Tech Reference *Backlights*

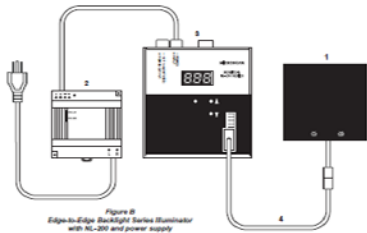

Figure B
Edge-to-Edge Backlight Series Illuminator
with NL-200 and power supply

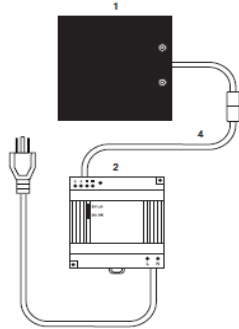

Figure A
Edge-to-Edge Backlight Series Illuminator
with power supply

MICROSCAN.

NERLITE® DARKFIELD LIGHTS

NERLITE® Darkfield Lights enhance the contrast of surface features (e.g. embossed or engraved marks).



Best Sellers	
1)	NER-011609311
2)	NER-011601521

****Important Pricing Discount Note**** Product discounts are applied based on the Product TYPE code shown in the TYPE column below.

Product Type codes are defined as: P = PRODUCT Discount, A = ACCESSORY Discount.

A Product Type code modified with L signifies Legacy Status (refer to Legacy section of this catalog).

Refer to your Partner Agreement for the actual discount percentage by Product Type.

Darkfield 50 Continuous

Part Number	Description	List Price	Type
NER-011609311	NERLITE DF-50, Red, Non-Diffuse, Dark Field, 24V Continuous, Open-End Cable	€ 440	P
NER-011609321	NERLITE DF-50, White, Non-Diffuse, Dark Field, 24V Continuous, Open-End Cable	€ 506	P

Darkfield 100 Continuous

NER-011601520	NERLITE DF-100-1, Red, Non-Diffuse, Dark Field, 24V Continuous, Open-End Cable	€ 502	P
NER-011601521	NERLITE DF-100-1, Red, Diffuse, Dark Field, 24V Continuous, Open-End Cable	€ 502	P

Darkfield 150 Continuous

NER-011600020	NERLITE DF-150-1, Red, Non-Diffuse, Dark Field, 24V Continuous, Open-End Cable	€ 714	P
NER-011600021	NERLITE DF-150-1, Red, Diffuse, Dark Field, 24V Continuous, Open-End Cable	€ 714	P
NER-011600208	NERLITE DF-150-3, Red, Non-Diffuse, Dark Field, 24V Continuous, Open-End Cable	€ 980	P

Darkfield 200 Continuous

NER-011603300	NERLITE DF-200-1, Red, Diffuse, Dark Field, 24V Continuous, Open-End Cable	€ 1,426	P
---------------	--	---------	---

Power Supply Darkfields Continuous

Part Number	Description	List Price	Type
NER-011504100	DSP60 24VDC 2.5A DIN Mount Power Supply	€ 210	A

Power Supply Cordsets

Part Number	Description	List Price	Type
NER-030028300	AC Power Cord for DSPxx Power Supply, U.S.	€ 62	A
NER-030028400	AC Power Cord for DSPxx Power Supply, EU	€ 62	A
NER-030028500	AC Power Cord for DSPxx Power Supply, UK	€ 62	A

Tech Reference Dark Field Lights

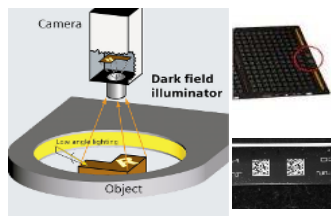

Hardware Required

Item	Description	Part Number
1	DF Series Illuminators	NER-01160XXXX
2	Power Supply DSP60 24VDC 2.5A DIN Mount	NER-011504100

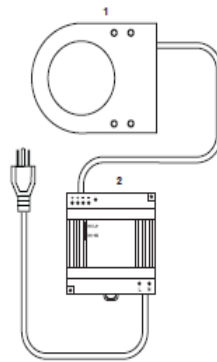

Figure A
Dark Field Series Illuminator
with power supply

MICROSCAN.

Product Demonstration Kits



For flexibility, many Microscan Demonstration Kits do not contain scanners, readers or cameras. These are indicated by * in the part number listing below and require a separate purchase of the desired reader or camera.

Demo Kits - Scanner / Camera Not Included*		
Part Number	Description	List Price
98-000102-01	Demo Kit, QX-830/QX-870	€ 554
98-000090-03	Demo Kit, MS-890	€ 596
98-000086-02	Demo Kit, MINI Hawk	€ 656
98-000095-02	Demo Kit, MS-Connect 210	€ 896

Demo Kits - Scanner / Camera Included**		
Part Number	Description	List Price
98-000224-01	MS-2D Demo Kit, USB	€ 600
98-000224-02	MS-2D Demo Kit, Serial	€ 600
98-000264-01	Demo Kit, HS-21 & HS-41X, USB, 2 6 ft. Strt. USB Cables, 1 8 ft. Serial Cable	€ 960

** No separate reader purchase required. These kits are discounted 25%.

NOTE: Demo kit is not available for Mobile Hawk. A reader, specifically purchased as a demo unit will be discounted 50%.

MicroHAWK Demo Kit



MicroHAWK Demo Kit Contents:

Cables: Micro-USB, PWR-Serial I/O, Ethernet

Power Supply, Symbol Card, Setup Guide

User chooses the ID or MV Cameras separately at 80% discount
1ea, MicroHAWK 20, 30, and 40

MICRO HAWK

Demo Kits - MicroHAWK		
Part Number	Description	List Price
98-9000039-03	DEMO KIT, MICROHAWK (NO UNITS)	€ 632
SLN-0000036	MicroHAWK ID/MV 30, SXGA, HD, White LED, Dual Boot Camera with Accessories	€ 2,880
SLN-0000037	MicroHAWK ID/MV 40, SXGA, HD, White LED, Dual Boot Camera with Accessories	€ 3,068

Software/Manuals		
Part Number	Description	List Price
37-000010-01*	Tools Drive, User Documentation, Software	€ 30

* 1 free per order.

Legacy Products

Note: These products are not recommended for new applications, but are still actively shipping and supported.

****Important Pricing Discount Note**** Product discounts are applied based on the Product TYPE code shown in the TYPE column below.

Product Type codes are defined as: P = PRODUCT Discount, A = ACCESSORY Discount.

A Product Type code modified with L signifies Legacy Status (refer to Legacy section of this catalog).

Refer to your Partner Agreement for the actual discount percentage by Product Type.



MS-890 Industrial Barcode Reader

Part Number	Description	List Price	Type
FIS-0890-0001G	MS-890 Scanner, Long Range, St&alone Version, RS-232/485,10-28VDC	€ 5,400	LP
FIS-0890-0002G	MS-890 Scanner, Long Range, Wiring Box-Ready, RS-232/485,10-28VDC	€ 5,588	LP



MS-4 Ultra-Compact Barcode Imagers

Part Number	Description	List Price	Type
FIS-0004-0001G	MS-4 Imager, SD, RS-232, 5VDC	€ 1,022	LP
FIS-0004-0002G	MS-4 Imager, LD, RS-232, 5VDC	€ 1,022	LP
FIS-0004-0003G	MS-4 Imager, SD, USB	€ 1,022	LP
FIS-0004-0004G	MS-4 Imager, LD, USB	€ 1,022	LP

USB cable terminated with USB type A connector.



MS-4X Ultra-Compact DPM Imagers

Part Number	Description	List Price	Type
FIS-0004-2001G	MS-4X Imager, SD, X-Mode, RS-232, 5VDC	€ 1,208	LP
FIS-0004-2002G	MS-4X Imager, LD, X-Mode, RS-232, 5VDC	€ 1,208	LP
FIS-0004-2003G	MS-4X Imager, SD, X-Mode, USB, 5VDC	€ 1,208	LP
FIS-0004-2004G	MS-4X Imager, LD, X-Mode, USB, 5VDC	€ 1,208	LP
FIS-0004-2005G	MS-4X Imager, 2D, SD, DPM, X-Mode, USB with I/O, 5VDC	€ 1,208	LP
FIS-0004-2006G	MS-4X Imager, 2D, LD, DPM, X-Mode, USB with I/O, 5VDC	€ 1,208	LP

USB cable terminated with USB type A connector.



Interface Boxes

Part Number	Description	List Price	Type
98-000039-02	Kit, IB-152	€ 138	LA
20-500013-01	Box, Interface, DeviceNet, Brand-Label	€ 656	LA

Note: parts are not RoHS compliant.

DeviceNet protocol box works with IB-131



NERLITE Legacy Accessories

Part Number	Description	List Price	Type
NER-011503800	NERLITE LC-50 Current Controller, 0.35A, Input 40VDC Max.	€ 212	LA
NER-011503801	NERLITE LC-50 Current Controller, 0.7A, Input 40VDC Max.	€ 212	LA
NER-011503802	NERLITE LC-50 Current Controller, 1.05A, Input 40VDC Max.	€ 212	LA

Legacy Products

Note: These products are not recommended for new applications, but are still actively shipping and supported.



CDI (Continuous Diffuse Illuminator)

Part Number	Description	List Price	Type
NER-011252000	NERLITE CDI 200/75, Red, CDI Light, 24V Continuous, Open-End Cable	€ 3,436	LP
NER-011252010	NERLITE CDI 200/75, White, CDI Light, 24V Continuous, Open-End Cable	€ 3,590	LP



Dome Lights

Part Number	Description	List Price	Type
NER-011600403	NERLITE D150, Red, Dome, 24V Continuous, Open-End Cable	€ 820	LP
NER-011600411	NERLITE D150, White, Dome, 24V Continuous, Open-End Cable	€ 1,398	LP



Linear Arrays

Part Number	Description	List Price	Type
NER-011654195	NERLITE LA-50-1, Red, Linear Array, 24V Continuous, Open-End Cable	€ 296	LP
NER-011654198	NERLITE LA-50-1, White, Linear Array, 24V Continuous, Open-End Cable	€ 320	LP
NER-011654593	NERLITE LA-150-1, Red, Linear Array, 24V Continuous, Open-End Cable	€ 446	LP
NER-011654540	NERLITE LA-150-1, White, Linear Array, 24V Continuous, Open-End Cable	€ 520	LP



Machine Vision Optical

Part Number	Description	List Price	Type
98-92800572	Lens 12mm F/1.8-16, Front thread 25.5mm P 0.5mm, 2/3" C-mount	€ 386	LA
98-92800573	Lens 16mm F/1.4-16, Front thread 25.5mm P 0.5mm, 2/3" C-mount	€ 386	LA
98-92800574	Lens, 25 mm F/1.6-16, Front Thread 25.5 mm P 0.5 mm, 2/3 in. C-Mount	€ 386	LA



Machine Vision Hardware Accessories

Part Number	Description	List Price	Type
98-001904091	Calibration Target for 1.87 mmx3.0 mm Field of View	€ 1,396	LA
98-001904092	Calibration Target for 2.80 mmx4.50 mm Field of View	€ 1,396	LA
98-001904093	Calibration Target for 4.20 mmx6.75 mm Field of View	€ 1,396	LA
98-001904094	Calibration Target for 6.34 mmx10.2 mm Field of View	€ 1,396	LA
98-001904095	Calibration Target for 9.33 mmx15.0 mm Field of View	€ 1,396	LA
98-001904096	Calibration Target for 14.0 mmx22.5 mm Field of View	€ 1,396	LA
98-001904097	Calibration Target for 20.5 mmx33.0 mm Field of View	€ 1,396	LA
98-001904098	Calibration Target for 47.3 mmx76.1 mm Field of View	€ 1,396	LA
98-001904099	Calibration Target for 63.1 mmx101 mm Field of View	€ 1,268	LA
98-001904100	Calibration Target for 94.7 mmx152 mm Field of View	€ 1,268	LA
98-001904101	Calibration Target for 158 mmx254 mm Field of View	€ 1,268	LA
98-001904175	Calibration Target for 30.8 mmx49.5 mm Field of View	€ 1,268	LA



MS-Connect 5100 Options

Part Number	Description	List Price	Type
FIS-5100-0001G	MS-Connect 5100, Enhanced Multidrop Concentrator	€ 1,096	LA
61-000161-02	QX Cordset, M12 12-Pin Plug (Screw-On)-to-MS-Connect 5100, 3 m.	€ 70	LA