

**MICROSCAN.**

# PRODUCT PRICING CATALOG

**Corporate Headquarters, USA**

Microscan Systems, Inc.  
700 SW 39th St  
Renton, WA  
98057  
Tel 425.226.5700  
Fax 425.226.8250

*CONFIDENTIAL*

[www.microscan.com](http://www.microscan.com)

*Rev AR January 2017*

# MICROSCAN

Contents	Page #
Field Sales Contacts	3
Customer Service Contacts	5
Technical Support and Service Contacts	5
Standard Terms and Conditions	6
Product Return Process	9
Auto ID Barcode Readers	10
MS-1 Series Scan Engines	10
MS-2 Series CCD Readers	11
MS-3 Series Scanners	14
QX-830 Compact Barcode Reader	23
QX-870 Industrial Barcode Reader	28
MS-890 Industrial Barcode Reader	32
<b>MicroHAWK Barcode Readers</b>	<b>39</b>
MS-2D Scan Engine	47
MINI Hawk Series of Imagers	48
QX Hawk	53
Barcode Verification	56
Barcode Verification Kits	56
PanelScan	57
Auto ID Handhelds	58
HS-21 Handheld 2D Reader	58
HS-41X DPM Handheld 2D Reader	58
HS-51 Wireless Handheld 2D Reader	60
HS-51X Wireless Handheld 2D Reader	60
Mobile Hawk Handled DPM Imager	61
Auto ID Software, Connectivity, and Accessories	62
MS-Connect Series	62
Auto ID Product Accessories	65
Machine Vision Systems	67
<b>MicroHAWK Machine Vision Smart Cameras</b>	<b>67</b>
Vision MINI	76
Vision HAWK	79
<b>Vision HAWK I-PAK System</b>	<b>80</b>
Visionscape GigE Solution	83
Machine Vision Accessories	84
NERLITE ® Machine Vision Lighting	85
NERLITE Pharamalite	85
Smart DOAL	86
Smart Ring	88
MAX Lights	91
Area Arrays	93
Edge-to-Edge Backlights	94
Large Backlights	96
Darkfield Lights	97
Product Demo Kits	98
Legacy Products	99

# MICROSCAN.

## Field Sales Contacts

Region	Sales Managers	Address	Phone	Email
<b>Director, Americas Sales</b>	John Agapakis	486 Amherst St. Nashua, NH 03063	Tel: +603.821.4319 +508.314.4143 (M)	<a href="mailto:jaapakis@microscan.com">jaapakis@microscan.com</a>
<b>Western U.S.A.</b>	Bob Taplett	Microscan 700 SW 39th Street Renton, WA 98057	Tel: +1.206.617.9603 (M)	<a href="mailto:btaplett@microscan.com">btaplett@microscan.com</a>
<b>Midwest U.S.A.</b>	David Thornton	Oswego, IL U.S.A.	Tel: +1.331-254-2062 (M)	<a href="mailto:dthornton@microscan.com">dthornton@microscan.com</a>
<b>South Central U.S.A.</b>	Jamey Waldrop	Murphy, TX, U.S.A.	Tel: +1.469-507-9916 (M)	<a href="mailto:jwaldrop@microscan.com">jwaldrop@microscan.com</a>
<b>Northeastern U.S.A. / Ontario, Canada</b>	Ted Rudel	Sparta, NJ, U.S.A.	Tel: +973.289.0870 (M)	<a href="mailto:trudel@microscan.com">trudel@microscan.com</a>
<b>Southeastern U.S.A. / Caribbean</b>	Yamil Arias	Hialeah, FL U.S.A.	Tel: +1.786-779-5544 (M)	<a href="mailto:yarias@microscan.com">yarias@microscan.com</a>
<b>South and Central America</b>	Yamil Arias	Hialeah, FL U.S.A.	Tel: +1.786-779-5544 (M)	<a href="mailto:yarias@microscan.com">yarias@microscan.com</a>
<b>Central Mexico</b>	Chris Moya	San Luis Potosi, Mexico	Tel: +52.1.444.828.4848	<a href="mailto:cmoya@microscan.com">cmoya@microscan.com</a>
<b>Mexico Border</b>	Victor Martinez	Ciudad Juarez Chihuahua, Mexico	Tel: +52.1.81.1577.8293 (M)	<a href="mailto:vmartinez@microscan.com">vmartinez@microscan.com</a>
<b>OEM Sales Manager (East)</b>	Kyle O'Brien	486 Amherst Street Nashua, NH 03063	Tel: +1.617.763.5606	<a href="mailto:kobrien@microscan.com">kobrien@microscan.com</a>
<b>OEM Sales Manager (West)</b>	Jason Mack	Cypress, CA U.S.A.	Tel: +1.425.757.1357 (M)	<a href="mailto:jmack@microscan.com">jmack@microscan.com</a>
<b>Key Account Manager, LVS products (East)</b>	Teri DeMarco	Fayetteville, GA, U.S.A	Tel: +1.678.850.7811(M)	<a href="mailto:tdemarco@microscan.com">tdemarco@microscan.com</a>
<b>Key Account Manager, LVS products (Midwest)</b>	John Bauer	Pinckney, MI, U.S.A.	Tel: +1.734.395.4939 (M)	<a href="mailto:jbauer@microscan.com">jbauer@microscan.com</a>
<b>OEM Account Manager, LVS products</b>	Art Jensen	Monticello, MN, U.S.A.	Tel: +1.951-265-0227 (M)	<a href="mailto:ajensen@microscan.com">ajensen@microscan.com</a>
<b>Business Development, Americas</b>	Brandon Lew	Microscan 700 SW 39th Street Renton, WA 98057	Tel: +1.425.203.4968	<a href="mailto:blew@microscan.com">blew@microscan.com</a>
<b>Business Development, LVS</b>	Carol Saniatan	Peachtree City, GA, U.S.A	Tel: +1.404.782.1217	<a href="mailto:csaniatan@microscan.com">csaniatan@microscan.com</a>
<b>Director, Europe</b>	Bart Nollet	Lemelerberg 17 NL-2402 ZN Alphen aan den Rijn, The Netherlands	Tel: +31.172.4233.60	<a href="mailto:bnollet@microscan.com">bnollet@microscan.com</a>
<b>S. Germany, Austria, Switzerland, Liechtenstein</b>	Mirko Karsch	Lemelerberg 17 NL-2402 ZN Alphen aan den Rijn, The Netherlands	Tel: +49.160.8948618 (M)	<a href="mailto:mkarsch@microscan.com">mkarsch@microscan.com</a>
<b>N. Germany, Eastern Europe, Baltic Countries, Georgia, Slovenia, Croatia, Azerbaijan</b>	Gerhard Muller	Bochum, Germany	Tel: +49.172.23.72.637 (M)	<a href="mailto:gmuller@microscan.com">gmuller@microscan.com</a>
<b>Italy, Greece, Spain, Israel, Portugal</b>	Ursala Grotenhuis-Hurtado	Lemelerberg 17 NL-2402 ZN Alphen aan den Rijn, The Netherlands	Tel: +31.172.4233.72	<a href="mailto:rpijper@microscan.com">rpijper@microscan.com</a>
<b>Sweden, Finland, Luxembourg, Belgium, Iceland, The Netherlands, Norway, Denmark, and OEM Sales Manager</b>	Michael de Kegel	Aalst, Belgium	Tel: +32.474.3110.56 (M)	<a href="mailto:mdekegel@microscan.com">mdekegel@microscan.com</a>
<b>France</b>	Nicolas Rozencwajg	Lemelerberg 17 NL-2402 ZN Alphen aan den Rijn, The Netherlands	Tel: +34.637.80.7979 (M)	<a href="mailto:NRozencwajg@microscan.com">NRozencwajg@microscan.com</a>
<b>United Kingdom, England, Scotland, Wales, Ireland, South Africa</b>	Michael Harkin	Letterkenny, Co Donegal, Republic of Ireland	Tel: +353.83.171.4198 (M)	<a href="mailto:mharkin@microscan.com">mharkin@microscan.com</a>
<b>Middle East, Morocco, Turkey, Africa (not south)</b>	Rudy Pijper (temporary)	Lemelerberg 17 NL-2402 ZN Alphen aan den Rijn, The Netherlands	Tel: +31.172.4233.72	<a href="mailto:rpijper@microscan.com">rpijper@microscan.com</a>
<b>EU Private Label Companies</b>	Nico Hooveld	Lemelerberg 17 NL-2402 ZN Alphen aan den Rijn, The Netherlands	Tel: +31.6.2220.9135 (M)	<a href="mailto:nhooveld@microscan.com">nhooveld@microscan.com</a>
<b>Key Account Manager, LVS Europe</b>	Koenraad Vermeiren	Brasschaat, Belgium		<a href="mailto:kvermeiren@microscan.com">kvermeiren@microscan.com</a>
<b>Director, Asia Pacific / Australia, New Zealand, Fiji, Guam, Taiwan</b>	Eu-Gene Ng	31 Kaki Bukit Road 3, #05-08 TechLink, Singapore 417818	Tel: +65.9090.8558	<a href="mailto:eng@microscan.com">eng@microscan.com</a>
<b>Singapore, Indonesia, Philippines, Vietnam, Thailand, Malaysia, SEA Countries</b>	Janel Kang	31 Kaki Bukit Road 3, #05-08 TechLink, Singapore 417818	Tel: +65.9880.8980	<a href="mailto:jkang@microscan.com">jkang@microscan.com</a>
<b>Korea</b>	Moon Soo Kim	8F, SH Energy Bldg., 16.6, Sunae-dong, Bundang-gu, Seongnam City, Kyeonggi-Do, Korea, 463-825	Tel: +82.31.786.0835 +82.10.3784.6437 (M)	<a href="mailto:mkim@microscan.com">mkim@microscan.com</a>
<b>Japan</b>	Moon Soo Kim	8F, SH Energy Bldg., 16.6, Sunae-dong, Bundang-gu, Seongnam City, Kyeonggi-Do, Korea, 463-825	Tel: +82.31.786.0835 +82.10.3784.6437 (M)	<a href="mailto:mkim@microscan.com">mkim@microscan.com</a>
<b>India, Pakistan, Nepal, Sri Lanka, Bangladesh, Bhutan</b>	Vinay Bhasin	BPTP Park Centra, 201-B, 2nd Floor Sector-30, Gurgaon, Haryana 122 002 India	Tel: +91.981.1412271 (M)	<a href="mailto:vbhasin@microscan.com">vbhasin@microscan.com</a>
<b>Director, China / Beijing, Guangdong, Shandong</b>	Richard Cheng	Beijing Shougang International Bldg. Rm. 1818, No.60 North Street, Xizhimen Haidan District, Beijing 100088 P.R.C.	Tel: +86.10.5993.5766 +86.186.0006.2619 (M)	<a href="mailto:rcheng@microscan.com">rcheng@microscan.com</a>

# MICROSCAN.

China-East (Shanghai, Zhejiang, Hubei)	<b>Bruce He</b>	Unit 201, XinAn Plaza, Building 13, No.99 Tianzhou Road, Shanghai, China	Tel: <b>+86.189.3067.9073(M)</b>	<a href="mailto:bhe@microscan.com">bhe@microscan.com</a>
China – East (Jiangsu, Anhui, Henan)	<b>Jeffrey Luan</b>	Unit 201, XinAn Plaza, Building 13, No.99 Tianzhou Road, Shanghai, China	Tel: <b>+86.186.2190.0703(M)</b>	<a href="mailto:JLuan@microscan.com">JLuan@microscan.com</a>
China-South (Guangdong, Guangxi, Hainan, Hong kong)	<b>Johnny Deng</b>	Unit 5D Hanjing Plaza, No. 23 Dengliang Road, Nanshan District, Shenzhen 518052, China	Tel: <b>+86.186.6621.9571(M)</b>	<a href="mailto:Jdeng@microscan.com">Jdeng@microscan.com</a>

# MICROSCAN.

China-West (Sichuan, Chongqing, Yunnan, Guizhou)	Johnny Deng	Rm A3601, Fantasia Hallrun Complex, 216, Lower Dongda Street Section, Jinjiang District, Chengdu, China	Tel: +86.186.6621.9571(M)	<a href="mailto:Jdeng@microscan.com">Jdeng@microscan.com</a>
China-Southeast (Fujian, Jiangxi, Hunan)	Johnny Deng	Unit 5D Hanjing Plaza, No. 23 Dengliang Road, Nanshan District, Shenzhen 518052, China	Tel: +86.186.6621.9571(M)	<a href="mailto:Jdeng@microscan.com">Jdeng@microscan.com</a>
China - north & northeast (Beijing, Tianjin, Hebei, Shandong, Shaanxi)	Jog Yang	Rm.0908, Ruida Building, No.74, Lugu road, Shijingshan District, Beijing, China	Tel: +86.10.5993.6887(O) +86.186.1196.7717(M)	<a href="mailto:Jyang@microscan.com">Jyang@microscan.com</a>

## Customer Service Contacts

Region	Inside Sales Managers	Address	Phone	Email
Sales Operations Manager - Americas, AP, EMEA	Andrew Edgerton	Microscan 700 SW 39th Street Renton, WA 98057	Tel: +1.425.203.4921 Fax: +1.425.226.8250	<a href="mailto:Aedgerton@microscan.com">Aedgerton@microscan.com</a>
Americas	Matt Scrichfield Saedee Xaykosy Wendy Cianfrocco	Microscan 700 SW 39th Street Renton, WA 98057	Tel: +1.425.203.4844/ +1.800.251.7711 Fax: +1.425.226.8250	<a href="mailto:AMERICAS_Orders@microscan.com">AMERICAS_Orders@microscan.com</a>
Asia Pacific	Ray Wang	31 Kaki Bukit Road 3 #04-05/07 TechLink, Singapore 417818	Tel: +65.6846.1214 Fax: +65.6846.4641	<a href="mailto:ASIA_Orders@microscan.com">ASIA_Orders@microscan.com</a>
China	Ray Wang Nikki Li	Unit 201, XinAn Plaza, Bldg. 13, No.99 Tianzhou Road, Shanghai, 200233, P.R.C.	Tel: +86.21.6113.3752 Fax: +86.21.6113.3683	<a href="mailto:CHINA_orders@microscan.com">CHINA_orders@microscan.com</a>
Europe, Russia, Middle East, Africa	Rudy Pijper	Lemelerberg 17 NL-2402 ZN Alphen aan den Rijn, The Netherlands	Tel: +31.172.4233.72 Fax: +31.172.4233.66	<a href="mailto:EMEA_Orders@microscan.com">EMEA_Orders@microscan.com</a>

## Technical Support and Service Contacts

Support/Service	Contact	Address	Phone	Email
Distributor Business Development	Matt Scrichfield, Global Channel Manager	Microscan 700 SW 39th Street Renton, WA 98057	Tel: +425.203.4955 eFax: +1.425.988.7093	<a href="mailto:partners@microscan.com">partners@microscan.com</a>
Service Contracts, Component Orders (piece parts, returns, obtain RMA #)	Contact your regional Customer Service representative.			
United States/Canada/Mexico/Latin America Help Desk	Auto ID/General		Tel: +1.425.203.4841 / +1.800.251.7711	<a href="mailto:helpdesk@microscan.com">helpdesk@microscan.com</a>
	Lighting			<a href="mailto:nerlitesupport@microscan.com">nerlitesupport@microscan.com</a>
	Vision			<a href="mailto:visionsupport@microscan.com">visionsupport@microscan.com</a>
Asia Pacific Help Desk	General		Tel: +65.6846.1214	<a href="mailto:apac_support@microscan.com">apac_support@microscan.com</a>
Europe, Russia, Middle	General		Tel: +31.172.4233.63	<a href="mailto:emea_support@microscan.com">emea_support@microscan.com</a>

Note: Only products which are currently active (recommended for new applications) are shown in this product pricing

For the purposes of these TERMS AND CONDITIONS OF SALE ("Terms and Conditions"), "contract" means the agreement between Microscan Systems, Inc. ("Supplier") and Buyer arising as a result of Buyer's submission of an order for Supplier's products. Individually, Supplier and Buyer are each a party; collectively, they are parties. Such contract shall be deemed to incorporate and be governed by these Terms and Conditions. No term or condition of Buyer's order additional to or different from these Terms and Conditions shall become part of the contract unless explicitly agreed to in writing by Supplier. These Terms and Conditions may be revised by Supplier from time to time, in Supplier's sole discretion. Supplier will notify Buyer of revisions to these Terms and Conditions forty-five (45) days prior to the revised Terms and Conditions taking effect. Buyer's failure to object in writing to any provision contained in any communication from Supplier before the "effective date" shall be construed as acceptance of any such provision and shall not be construed as a waiver of these Terms and Conditions.

**1. Quotations and Orders:** Prices, specifications and dates for delivery referenced in Supplier's quotations are for information purposes only and shall not be binding on Supplier until all technical requirements have been agreed upon and Supplier has accepted Buyer's order. All orders must be bona fide commitments showing definite prices and quantities and mutually agreed shipping dates. Quotations terminate if the Buyer does not place an order with the Supplier within 60 days.

**2. Taxes:** Prices and fees do not include taxes, transport charges, insurance and export and/or import charges or duties including without limitation sales tax, value added tax, use or excise taxes, applicable to the Products sold and or Services supplied under any Contract, which taxes and other charges may, in the Supplier's discretion, be added by the Supplier to the sale price and or fees or billed separately and which taxes and other charges shall be paid by the Buyer unless the Buyer provides the Supplier with any necessary tax exemption certificate. Unless otherwise agreed in writing, the Buyer shall be liable to pay the Supplier's charges for transport, packaging, insurance and export and/or import clearance.

**3. Shipment and Delivery:** All products will be shipped EXW (Ex Works) Supplier's premises. Delays of convenience, within fourteen (14) days of the acknowledged shipping dates, will be invoiced at 50% of order value on originally scheduled ship date. Delays for convenience will not be accepted beyond sixty (60) days. Orders containing custom "FIS" products or integrated systems cannot be delayed or cancelled after receipt of Sales Order Acknowledgement. In the absence of specific instructions, Supplier will select the carrier and ship "collect". LVS 7000, 7100 and 7500 systems ship approximately 45 business days after receipt of order. Title and risk of loss or damage to any product shall pass from Supplier to Buyer upon the product being packed ready for delivery to carrier. Any claims for loss, damage or mis-delivery thereafter shall be filed with the carrier. All products shall be deemed finally inspected and accepted within ten (10) days after delivery unless notice of rejection is given by Buyer in writing to Supplier within such period. Acceptance shall constitute acknowledgement of full performance by Supplier of all obligations under the contract except as stated in Section 9 (Limitation of Warranties). The Supplier reserves the right to make delivery of Products by instalments and to tender a separate invoice in respect of each instalment. When delivery is to be by instalments or the Supplier exercises its right to deliver by instalments or if there is delay in the delivery of any one or more instalments for whatever reason the Buyer shall not be entitled to treat the Contract as a whole as repudiated. All products returned are subject to the then current Microscan Product Return Process Policy. Microscan reserves the right to change this policy at will.

**4. Terms of Payment:** Each shipment shall be a separate transaction and Buyer will be invoiced on date of dispatch. Unless otherwise stated on Supplier's invoice, terms of payment shall be net thirty (30) days from date of invoice. Orders of LVS 7000 systems \$20,000 and higher require 50/40/10 payment terms (50% deposit with placement of purchase order, 40% at time of shipment, and 10% at Net 30 days from date of invoice). Orders of LVS 7000 systems under \$20,000 may require deposit, based on customer credit limit.

All amounts due shall be paid in full by the Buyer without deduction, withholding, set-off or counterclaim for any reason whatsoever, whether arising in contract, tort (including negligence), breach of statutory duty or otherwise, save as may be required by law. Supplier may, in its sole discretion, determine at any time that the Buyer's financial condition requires full or partial payment in advance or the provision of security for payment by the Buyer in a form satisfactory to the Supplier. If the Buyer fails to make any payment when due then, without prejudice to any other rights and remedies available to the Supplier, the Supplier may at its option: (i) treat the Contract as repudiated by the Buyer, to suspend or cancel further delivery of Products and/or the provision of Services or any part thereof under that Contract or any other Contract between them and claim damages and/or receive reasonable cancellation fees; or (ii) affirm the Contract and recover, in addition to the payment, interest thereon at the lesser of 1-1/2% per month or the highest rate permitted by law along with reasonable attorney's fees and costs associated with recovering such outstanding payments.

**5. Security Interest:** Buyer hereby grants to Supplier a purchase money security interest in all Supplier products sold to Buyer as security for the punctual performance by Buyer of all of its obligations hereunder. Supplier may, at its discretion, file the Buyer's order and these terms and conditions as a financing statement to evidence and perfect said security interest.

**6. Force Majeure:** Notwithstanding anything to the contrary in these Conditions, the Supplier shall not be liable to the Buyer for any loss or damage which may be suffered by the Buyer as a direct or indirect result of the supply of Products or Services being prevented, delayed or rendered uneconomic by reason of circumstances or events beyond the Supplier's reasonable control. If due to such circumstances or events the Supplier has insufficient stocks to meet all its commitments the Supplier may apportion available stocks between its customers at its sole discretion.

**7. Equipment:** Supplier may modify specifications provided the modifications do not adversely affect the performance of the equipment to be supplied under the contract ("the equipment"). In addition, Supplier may furnish suitable substitutes for materials unobtainable because of priorities or regulations established by government authority, or non-availability of materials from suppliers. All descriptions, illustrations and any other information relating to the Products contained in the Supplier's catalogues, brochures, price lists, advertising material and any sales or other particulars or literature are made by way of general description, are approximate only and for the general guidance and information of the Buyer. They shall not constitute warranties or representations by the Supplier nor shall they form part of any Contract.

**8. Software and Proprietary Information:** Buyer acknowledges and agrees that all property, copyright and other intellectual property rights in any work or tangible deliverable item arising from or created, produced or developed by the Supplier under or in the course of provision of any Services (the "Works"), wherever in the world enforceable, including without limitations all right title and interest in and to the Services and all documents, data, drawings, specifications, articles, sketches, drawings, reports, inventions, improvements, modifications, discoveries, tools, scripts and other items relating thereto shall immediately upon creation or performance vest in and shall be and remain the sole and exclusive property of the Supplier and the Buyer shall acquire no right, title or interest in or to the same except as expressly stated in these Conditions. The Supplier grants to the Buyer a revocable, non-exclusive, non-transferable license to use such of the Works as are necessary, and to the extent necessary, for the Buyer to obtain and utilize the intended benefit of the Services. Each party undertakes to keep confidential, not use for its own purposes and not without the prior written consent of the other party disclose to any third party, any information of a confidential nature belonging or relating to the other party which may become known to it unless such information is or becomes public knowledge (other than by breach of this Section) or is required to be disclosed by order of a competent authority.

## 9. Limited Warranty; Remedies; Exclusions:

A. Supplier warrants that all equipment shall be free from defects in material and workmanship under normal use for a period of one year from date of shipment to Buyer save that Supplier does not warrant that operation of the software will be completely uninterrupted or error free or that all program errors will be corrected.

Provided that Buyer notifies Supplier in writing of any claimed defect in the equipment immediately upon discovery and any such equipment is returned to the original shipping point, transportation charges prepaid, within one (1) year from date of shipment to Buyer and upon examination Supplier determines to its satisfaction that such equipment is defective in material or workmanship, i.e. contains a defect arising out of the manufacture of the equipment and not a defect caused by other circumstances, including, but not limited to accident, misuse, unforeseeable use, neglect, alteration, improper installation, improper adjustment, improper repair, or improper testing, Supplier shall at its option repair or replace the equipment, shipment to Buyer prepaid. Supplier shall have reasonable time to make such repair or to replace such equipment. Any repair or replacement of equipment shall not extend the period of warranty. This warranty is limited to a period of one (1) year, without regard to whether any claimed defects were discoverable or latent on the date of shipment.

B. If Buyer shall fail to pay when due any portion of the purchase price or any other payment required from Buyer to Supplier under this contract or otherwise, all warranties and remedies granted under this Section 9 may, at Supplier's option, be terminated.

C. THE FOREGOING WARRANTY IS EXCLUSIVE AND IN LIEU OF ALL OTHER REPRESENTATIONS, WARRANTIES AND COVENANTS, EXPRESS OR IMPLIED, WITH RESPECT TO THE EQUIPMENT AND ANY DEFECTS THEREIN OF ANY NATURE WHATSOEVER, INCLUDING WITHOUT LIMITATION WARRANTIES OF MERCHANTABILITY OR FITNESS FOR A PARTICULAR PURPOSE. SUPPLIER SHALL NOT BE LIABLE FOR, AND BUYER ASSUMES ALL RISK OF, ANY ADVICE OR FAILURE TO PROVIDE ADVICE BY SUPPLIER TO BUYER REGARDING THE EQUIPMENT OR BUYER'S USE OF THE SAME. UNDER NO CIRCUMSTANCES SHALL SUPPLIER BE LIABLE TO BUYER UNDER ANY TORT, NEGLIGENCE, STRICT LIABILITY, OR PRODUCT LIABILITY CLAIM AND BUYER AGREES TO WAIVE SUCH CLAIMS. SUPPLIER'S SOLE AND EXCLUSIVE LIABILITY, AND BUYER'S SOLE AND EXCLUSIVE REMEDY, FOR ANY NONCONFORMITY OR DEFECT IN THE PRODUCTS OR ANYTHING DONE IN CONNECTION WITH THIS CONTRACT, IN TORT (INCLUDING NEGLIGENCE), CONTRACT, OR OTHERWISE, SHALL BE AS SET FORTH IN SUBSECTION 9A HEREOF AS LIMITED BY SUBSECTION 9B HEREOF. THIS EXCLUSIVE REMEDY SHALL NOT HAVE FAILED OF ITS ESSENTIAL PURPOSE (AS THAT TERM IS USED IN THE UNIFORM COMMERCIAL CODE) PROVIDED THAT THE SUPPLIER REMAINS WILLING TO REPAIR OR REPLACE DEFECTIVE EQUIPMENT (AS DEFINED IN SUBSECTION 9A) WITHIN A COMMERCIALLY REASONABLE TIME AFTER RECEIVING SUCH EQUIPMENT. BUYER SPECIFICALLY ACKNOWLEDGES THAT SUPPLIER'S PRICE FOR THE EQUIPMENT IS BASED UPON THE LIMITATIONS OF SUPPLIER'S LIABILITY AS SET FORTH IN THIS CONTRACT.

10. **Patents:** If any claim is made against the Buyer that the Products or Services infringe any third party's US patent, the Supplier shall indemnify the Buyer against all losses, damages, costs and expenses awarded against, or incurred by, the Buyer in connection with the claim provided that: (i) the Supplier is given full control of any proceedings or negotiations in connection with any such claim; (ii) the Buyer shall give the Supplier all reasonable assistance for the purposes of any such proceedings or negotiations; (iii) except pursuant to a final award, the Buyer shall not pay or accept any such claim, or compromise any such proceedings without the consent of the Supplier; (iv) the Buyer shall do nothing which would or might vitiate any insurance policy or cover which the Buyer may have in relation to such infringement and shall use its best endeavors to recover any sums due thereunder and this indemnity shall not apply to the extent that the Buyer recovers any sums under any such policy or cover; (v) the Supplier shall be entitled to the benefit of, and the Buyer shall accordingly account to the Supplier for, all damages and costs (if any) awarded in favor of the Buyer which are payable by, or agreed with the consent of the Buyer (which consent shall not be unreasonably withheld) to be paid by, any other party in respect of any such claim; and (vi) without prejudice to any duty of the Buyer at common law, the Supplier shall be entitled to require the Buyer to take such steps as the Supplier may reasonably require to mitigate or reduce any such loss, damages, costs or expenses for which the Supplier is liable to indemnify the Buyer under Section 11; (iv) a combination with or an addition to equipment not manufactured or developed by the Supplier; or (v) the use of Products beyond that scope established by the Supplier or approved in writing by the Supplier.

11. **Limitation of Liability and Buyer Indemnity:** NOTHING IN THESE CONDITIONS SHALL EXCLUDE OR LIMIT THE SUPPLIER'S LIABILITY TO THE EXTENT THAT THE SAME MAY NOT BE EXCLUDED OR LIMITED AS A MATTER OF LAW. IN NO EVENT, REGARDLESS OF THE FORM OF ACTION, SHALL SUPPLIER BE LIABLE FOR ANY SPECIAL, INDIRECT, INCIDENTAL, OR CONSEQUENTIAL LOSSES OR DAMAGES ARISING OUT OF THE SALE OF ITS PRODUCTS TO BUYER OR ARISING OUT OF ANYTHING DONE IN CONNECTION WITH THE CONTRACT, INCLUDING, BUT NOT LIMITED TO, LOSSES OR DAMAGES ARISING OUT OF CLAIMS FOR LOSS OF USE, LOSS OF INCOME, LOSS OF REVENUE, BUSINESS, GOODWILL, OR PROFITS, AND CLAIMS ARISING OUT OF THIRD-PARTY ACTIONS, REGARDLESS OF WHETHER SUCH THIRD-PARTY ACTIONS, OR ANY OTHER CLAIMS, LOSSES, OR DAMAGES, WERE REASONABLY FORESEEABLE TO BUYER OR SUPPLIER. BUYER'S EXCLUSIVE REMEDY ARISING OUT OF ITS PURCHASE AND USE OF SUPPLIER'S PRODUCTS, OR ARISING OUT OF ANYTHING DONE IN CONNECTION WITH THE CONTRACT, SHALL BE FOR DAMAGES AND NO CLAIM OR CLAIMS OF ANY KIND, WHETHER BASED UPON CONTRACT, WARRANTY, TORT (INCLUDING, BUT NOT LIMITED TO, NEGLIGENCE, WARRANTY AND STRICT LIABILITY), STATUTORY OR REGULATORY PROVISIONS, INDEMNITY, CONTRIBUTION, OR OTHERWISE, SHALL BE GREATER IN AMOUNT IN AGGREGATE THAN THE PURCHASE PRICE OF THE PRODUCTS IN RESPECT OF WHICH DAMAGES ARE CLAIMED. Buyer shall indemnify and hold harmless Supplier, its officers, agents, employees, subsidiaries, parents, affiliates and insurers from and against any and all liabilities, damages, losses, claims, lawsuits, including costs and expenses in connection therewith, for death or injury to any persons or loss of any property whatsoever, caused in any manner by Buyer's possession, use or operation of equipment.

12. **Non-Waiver; Remedies:** No waiver of any breach of these Terms and Conditions shall constitute a waiver of any prior or subsequent breach of any similar or dissimilar provision or a modification of the contract. All Supplier rights and remedies, whether evidenced hereby or by any other contract or document, shall be cumulative and nonexclusive and may be exercised singularly or concurrently.

13. **Applicable Law; Dispute resolution; Severability:** The validity, performance and construction of the contract shall be governed by the laws of the State of Washington, without regard to conflicts of law principles. The parties agree that the United Nations Convention on Contracts for the International Sale of Goods is specifically excluded from application to these Conditions. Any claim, dispute or other matter in question arising out of or relating to this provision, shall be subject to mediation as a condition precedent to binding dispute resolution. Any mediation under this Agreement shall be administered by the American Arbitration Association in accordance with its mediation procedures then in effect. The parties shall equally share the mediator's fee and any filing fees. If the parties do not resolve their dispute through mediation, the dispute shall be resolved in mandatory arbitration pursuant to an arbitration administered by the American Arbitration Association in accordance with its arbitration rules then in effect. The arbitrator(s) award shall be final and judgment may be entered

# MICROSCAN.

upon it in accordance with applicable law in any court having jurisdiction thereof. Any mediation or arbitration shall be held in Seattle, WA. If Supplier is the substantially prevailing party, Supplier will be entitled to and awarded, in addition to any other relief, its reasonable costs incurred, including attorneys' fees. Notwithstanding any attempts to resolve differences, any action brought by Buyer against Supplier arising out of this contract or Buyer's purchase and use of the equipment must be commenced within one year after such use occurs and in no event later than two years after date of shipment of such equipment. Nothing in this Section 13 shall prevent any party from having recourse to a court of competent jurisdiction for the sole purpose of seeking a preliminary injunction or such other provisional judicial relief as it considers necessary. If any provision of these Terms and Conditions is held to be unenforceable, such holding shall not affect the enforceability of any other provision.

**14. Government Contracts:** If the products to be furnished under the contract are to be used in the performance of a United States Government contract or subcontract, the Government contract number and a statement to that effect shall appear on Buyer's purchase order. In all other events, said clauses shall not be incorporated herein by reference.

**15. Export:** Regardless of any disclosure made by Buyer to Supplier of the ultimate destination of Supplier product(s), Buyer shall not export either directly or indirectly any Supplier product, or any system incorporating said product(s) either in contravention of statute or regulation or without first obtaining all required licenses and permits from the United States Department of Commerce and any other relevant agencies or departments of the United States government.

**16. Assignment:** The contract shall be binding upon and inure to the benefit of the parties and their respective legal representatives, successors and permitted assigns. The contract is personal to Buyer, and Buyer may not assign any of its rights or delegate any of its obligations hereunder, in whole or in part, without the prior written consent of Supplier, which Supplier may withhold for any reason or no reason.

**17. Entire Agreement; Modifications:** This contract constitutes the entire agreement between the parties as relates to the sale of the equipment and no addition to or modification of any provision of said agreement, together with any agreement to which these Terms and Conditions are an exhibit or schedule, and shall be binding upon Supplier unless agreed to in writing by Supplier.

**18. Notices:** All notices given under the contract shall be in writing, mailed by first class mail, certified or registered, or delivered by hand to the address of the other party set forth in the quotation or to such other address as such party may designate from time to time by such notice, and shall take effect when received.

Rev: 12/02/2016 | Previous: Rev. H

## Product Return Process

The following describes the process for returning products. This is broken down into two main processes:

1. **RMA (Return Material Authorization) process for NEW PRODUCT**
2. **RMA (Return Material Authorization) process for IN SERVICE PRODUCT**

### RMA (Return material Authorization) process for NEW PRODUCT

This process is used to return a new product because it failed to work on initial startup (damaged on arrival) or the end customer wants to return the product to stock.

- **Damaged on arrival** = Out of box failures, determined at time of initial power up and within 30 days of shipment from Microscan.
  1. Contact your inside sales representative with the FIS part number, serial number, original sales order and/or purchase order and description of failure.
  2. If required, a REPLACEMENT sales order can be entered immediately for ASAP shipment. NOTE - Replacement scanner is processed as a NEW order and NEW INVOICE is generated at time of shipment.  
  
Contact your inside sales representative with FIS or accessory part number, serial number (if applicable), original sales order and/or purchase order and reason for return. Upon approval all returns are subject to a standard 20% restocking fee.
  3. RMA# issued by Inside Sales Rep. This number **MUST** appear on the outside of the shipping container and on all related paperwork. Product must be returned in its original factory packaging.

### RMA (return material authorization) process for IN SERVICE PRODUCT

- **IN WARRANTY**
  1. Contact Customer Service (425-226-5700) with the part number, serial number, description of failure, and request a return material authorization form (RMA).
  2. The RMA# issued by a Customer Service Representative **MUST** appear on the outside of the shipping container and on all related paperwork.
- **OUT OF WARRANTY**
  1. Contact Customer Service as per "In Warranty" (above) and request a return material authorization form. Upon completion of this document, return it along with your confirming PURCHASE ORDER and an RMA# will then be issued authorizing the return of the product.
  2. The RMA# issued by a Customer Service Representative **MUST** appear on the outside of the shipping container and on all related paperwork.  
**All RMAs, warranty and non warranty will be cancelled in 60 days from issuing date if not received.**  
If a warranty repair is changed to a non warranty repair, a purchase order must be received within 30 days of notification or the item will be returned to the sender.

# MICROSCAN.

## Auto ID Barcode Readers

### MS-1 Series Scan Engines

#### Read Ranges \*

Narrow Bar		Laser High Density	
5 mil (.127 mm)		0.6" to 2.1" (15 to 53 mm)	
10 mil (.254 mm)		0.6" to 4.1" (15 to 104 mm)	
15 mil (.381 mm)		0.6" to 5.1" (15 to 130 mm)	
Narrow Bar		Laser Low Density	
5 mil (.127 mm)		1.8" to 3.6" (46 to 91 mm)	
10 mil (.254 mm)		1.8" to 7.0" (46 to 178 mm)	
20 mil (.508 mm)		1.8" to 12.6" (46 to 320 mm)	



**Best Seller**  
 1) FIS-0001-8004G

**\*\*Important Pricing Discount Note\*\*** Product discounts are applied based on the Product TYPE code shown in the TYPE column below.

Product Type codes are defined as: P = PRODUCT Discount, A = ACCESSORY Discount.

A Product Type code modified with L signifies Legacy Status (refer to Legacy section of this catalog).

Refer to your Partner Agreement for the actual discount percentage by Product Type.

#### MS-1 Series Scan Engines

Part Number	Description	List Price	Type
FIS-0001-8003G	MS-1 CCD Scan Engines LD 32-Bit 8-Pack	€ 1,204	P
FIS-0001-8004G	MS-1 CCD Scan Engines HD 32-Bit 8-Pack	€ 1,204	P

#### Accessories

Part Number	Description	List Price	Type
98-000051-01	IC-3USB Interface Kit USB-to-Serial 15-Pin	€ 94	A
98-000097-02	MS-1 Demo Kit (Contains One HD MS-1 & One LD MS-1)	€ 296	A

\*\* This demo kit contains readers and is discounted 25%.

#### Package Detector/Sensor

Part Number	Description	List Price	Type
99-000017-01	Photo Sensor Visible NPN Dark ON	€ 196	A
99-000017-02	Photo Sensor Visible NPN Light ON	€ 196	A

#### Software/Manuals

Part Number	Description	List Price	Type
37-000010-01	Tools Drive, User Documentation, Software	€ 30	A

# MICROSCAN.

## MS-2 Series CCD Readers

### Read Ranges

Narrow Bar	High Density
5 mil (.127 mm)	0.4" to 1.9" (10 to 48 mm)
10 mil (.254 mm)	0.4" to 3.9" (10 to 99 mm)
15 mil (.381 mm)	0.4" to 4.9" (10 to 124 mm)
Narrow Bar	Low Density
5 mil (.127 mm)	1.6" to 3.4" (36 to 84 mm)
MAX Lights	1.6" to 6.8" (36 to 188 mm)
20 mil (.508 mm)	1.6" to 12.4" (36 to 325 mm)



Best Sellers
1) FIS-0002-0007G
2) FIS-0002-0005G

### MS-2 (32 bit)

Part Number	Description	List Price	Type
FIS-0002-0005G	MS-2 LD 32-Bit RS-232 Serial	€ 458	P
FIS-0002-0006G	MS-2 LD 32-Bit USB	€ 458	P
FIS-0002-0007G	MS-2 HD 32-Bit RS-232 Serial	€ 458	P
FIS-0002-0008G	MS-2 HD 32-Bit USB	€ 458	P

### Accessories

Part Number	Description	List Price	Type
FIS-0210-0001G	MS-Connect 210 Connectivity Box with Display	€ 880	A
FIS-0210-0002G	MS-Connect 210 Connectivity Box	€ 600	A
FIS-0210-0003G	MS-Connect 210 Connectivity Box with Display & Ethernet	€ 1,000	A
FIS-0210-0004G	MS-Connect 210 Connectivity Box with Ethernet	€ 880	A
98-000013-04	Relay Module 120VAC 3 Amp Output Series 70 Type SM for MS-Connect 210 + MS-890	€ 56	A
98-000013-05	Relay Module 240VAC 3 Amp Output Series 70 Type SM for MS-Connect 210 + MS-890	€ 56	A
98-000013-06	Relay Module 24VDC 3 Amp Output Series 70 Type SM for MS-Connect 210 MS-890	€ 56	A
61-000127-02	Cable MS-2-to-MS-Connect 210 6 ft.	€ 112	A
FIS-0001-0030G	IB-3PC Keyboard Wedge/Interface Box	€ 166	A
98-000051-01	IC-3USB Interface Kit USB-to-Serial 15-Pin	€ 94	A
FIS-0001-0035G	Converter IC-332 24V/5V Opto I/O for Use with IB-131	€ 184	A
99-000018-01	IB-131 Interface Box	€ 184	A
61-300026-03	Cable Communication DB-25 Plug-to-DB-9 Socket 6 ft.	€ 36	A
61-000010-02	Cable Communication DB-9 Socket-to-DB-9 Socket 6 ft.	€ 36	A
61-000011-02	Extension Cable Reader-to-IB-131 (MS-2 MS-3 MS-4 MS-9 MS-710 MS-820 MINI)	€ 36	A
61-100029-03	Cable Daisy Chain IB-131	€ 36	A

## MS-2 Series Accessories

### Power Supplies

Part Number	Description	List Price	Type
97-000011-01	Power Supply 100-240VAC +5VDC 5-Pin Plug U.S./Euro Plug	€ 94	A
97-000011-02	Power Supply 100-240VAC +5VDC 2-Pin Plug U.S./Euro Plug	€ 94	A
97-000012-02	Power Supply 100-240VAC +24VDC TRK 3-Pin U.S./Euro Plug)	€ 154	A

### Mounting and Connectors

Part Number	Description	List Price	Type
98-000048-01	Kit Mounting Arm/Adapter 4 in. for MS-2 MS-3	€ 78	A
98-000054-01	Kit Mounting Stand Base Plate	€ 36	A
98-000053-01	Mounting Arm Extension Kit 4 in. for MS-3 MS-4 MINI	€ 40	A
98-000053-02	Mounting Arm Extension Kit 3 in. for MS-2 MS-3 MS-4 MINI	€ 40	A
98-000060-01	Kit Bracket Side Mount MS-2 MS-3 MINI	€ 24	A
98-000059-01	Kit Bracket Angle Mount MS-2 MS-3 MINI	€ 24	A
98-000057-02	Kit Bracket Through-Hole Mount MS-2 MS-3 MINI	€ 24	A
98-000058-02	Kit Extended Right Angle Mirror MS-2 MS-3	€ 56	A
98-000061-03	Kit Bracket Conversion MS-2 MS-3-to-MS-520/MS-525	€ 24	A
20-610024-01	Trigger Connector 4-Pin Plug (Screw Terminal Field-Wireable) (Self-Wiring)	€ 33	A
20-610020-01	Power Conn.3-Pin Socket (Screw Term.Field-Wireable for Custom IB-131 Wiring)	€ 33	A

### Package Detector/Sensor

Part Number	Description	List Price	Type
99-000017-01	Photo Sensor Visible NPN Dark ON	€ 196	A
99-000017-02	Photo Sensor Visible NPN Light ON	€ 196	A

### Software/Manuals

Part Number	Description	List Price	Type
37-000010-01*	Tools Drive, User Documentation, Software	€ 30	A

\* 1 free per order.

## Tech Reference MS-2

### Configurations

Standalone (5V)

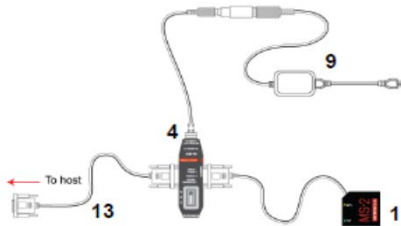

Standalone (10-28V)

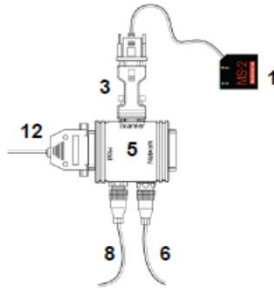

USB (5V)



Keyboard Wedge (5V)

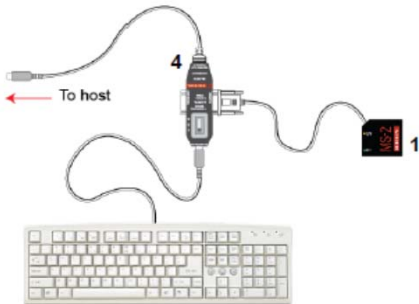

Standalone with MS-Connect 210 (10-28V)

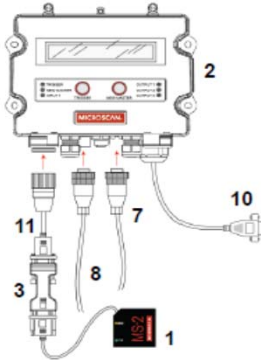

### System Matrix

Product	Reference No.	Description	List Price
1	FIS-0002-000XG	MS-2 CCD Reader	€ 458.00
2	FIS-0210-00XG	MS-Connect 210	Varies
3	FIS-0001-0035G	Converter, IC-332, 24V/5V, Opto I/O, for Use with IB-131	€ 184
4	FIS-0001-0030G	IB-3PC Keyboard Wedge/Interface Box	€ 166
5	99-000018-01	IB-131 Interface Box	€ 184
6,7	99-000017-XX	Object Detector, Light or Dark ON	€ 196
8	97-000012-02	Power Supply, 100-240VAC, +24VDC, TRK 3-Pin, U.S./Euro Plug)	€ 154
9	97-000011-01	Power Supply, 100-240VAC, +5VDC, 5-Pin Plug, U.S./Euro Plug	€ 94
10	61-000105-01	Cable, Pre-Stripped-to-9-Pin Host Cable, 6 ft.	€ 32
11	61-000127-02	Cable, MS-2-to-MS-Connect 210, 6 ft.	€ 112
12	61-300026-03	Cable, Communication, DB-25 Plug-to-DB-9 Socket, 6 ft.	€ 36
13	61-000010-02	Cable, Communication, DB-9 Socket-to-DB-9 Socket, 6 ft.	€ 36

# MICROSCAN.

## MS-3 Series Scanners

### Read Ranges \*

Narrow Bar		Laser High Density*	
3.3 mil (.084 mm)		2.3" to 2.6" (58 to 66 mm)	
5 mil (.127 mm)		2.0" to 3.1" (51 to 79 mm)	
7.5 mil (.191 mm)		1.7" to 3.7" (43 to 94 mm)	
10 mil (.254 mm)		1.5" to 4.0" (38 to 102 mm)	
Narrow Bar		Laser Low Density*	
7.5 mil (.191 mm)		3.0" to 6.0" (76 to 152 mm)	
10 mil (.254 mm)		2.0" to 7.0" (51 to 178 mm)	
15 mil (.381 mm)		2.0" to 8.0" (51 to 203 mm)	
20 mil (.508 mm)		2.0" to 10.0" (51 to 254 mm)	



### Best Sellers

- 1) FIS-0003-0004G
- 2) FIS-0003-0003G

\*Call for custom focus. For right-angle version, subtract -.6" (15mm) from Read Range.

**\*\*Important Pricing Discount Note\*\* Product discounts are applied based on the Product TYPE code shown in the TYPE column below.**

Product Type codes are defined as: P = PRODUCT Discount, A = ACCESSORY Discount.

A Product Type code modified with L signifies Legacy Status (refer to Legacy section of this catalog).

Refer to your Partner Agreement for the actual discount percentage by Product Type.

### Scanners MS-3 Standard

Part Number	Description	List Price	Type
FIS-0003-0001G	MS-3 Barcode ReaderSingle LineLow Density	€ 918	P
FIS-0003-0002G	MS-3 Barcode ReaderSingle LineHigh Density	€ 918	P
FIS-0003-0003G	MS-3 Barcode ReaderRasterLow Density	€ 970	P
FIS-0003-0004G	MS-3 Barcode ReaderRasterHigh Density	€ 970	P
FIS-0003-0005G	MS-3 Barcode ReaderSingle LineLow DensityRight Angle	€ 1,032	P
FIS-0003-0006G	MS-3 Barcode ReaderSingle LineHigh DensityRight Angle	€ 1,032	P
FIS-0003-0007G	MS-3 Barcode ReaderRasterLow DensityRight Angle	€ 1,082	P
FIS-0003-0008G	MS-3 Barcode ReaderRasterHigh DensityRight Angle	€ 1,082	P
FIS-0003-0033G	MS-3 Barcode ReaderSingle LineLow DensityVS-310 Replacement	€ 918	P
FIS-0003-0036G	MS-3 Barcode ReaderRasterHigh DensityVS-310 Replacement	€ 968	P

## MS-3 Series Scanner Accessories

### Accessories

Part Number	Description	List Price	Type
FIS-0210-0001G	MS-Connect 210 Connectivity Box with Display	€ 880	A
FIS-0210-0002G	MS-Connect 210 Connectivity Box	€ 600	A
FIS-0210-0003G	MS-Connect 210 Connectivity Box with Display & Ethernet	€ 1,000	A
FIS-0210-0004G	MS-Connect 210 Connectivity Box with Ethernet	€ 880	A
98-000013-04	Relay Module 120VAC 3 Amp Output Series 70 Type SM for MS-Connect 210 + MS-890	€ 56	A
98-000013-05	Relay Module 240VAC 3 Amp Output Series 70 Type SM for MS-Connect 210 + MS-890	€ 56	A
98-000013-06	Relay Module 24VDC 3 Amp Output Series 70 Type SM for MS-Connect 210 MS-890	€ 56	A
61-000127-02	Cable MS-2-to-MS-Connect 210 6 ft.	€ 112	A
FIS-0001-0030G	IB-3PC Keyboard Wedge/Interface Box	€ 166	A
98-000051-01	IC-3USB Interface Kit USB-to-Serial 15-Pin	€ 94	A
FIS-0001-0035G	Converter IC-332 24V/5V Opto I/O for Use with IB-131	€ 184	A
99-000018-01	IB-131 Interface Box	€ 184	A
61-300026-03	Cable Communication DB-25 Plug-to-DB-9 Socket 6 ft.	€ 36	A
61-000010-02	Cable Communication DB-9 Socket-to-DB-9 Socket 6 ft.	€ 36	A
61-000011-02	Extension Cable Reader-to-IB-131 (MS-2 MS-3 MS-4 MS-9 MS-710 MS-820 MINI)	€ 36	A
61-100029-03	Cable Daisy Chain IB-131	€ 36	A
98-000055-05*	Demo Kit MS-3 MINI	€ 596	A

\* This Demo Kit does not contain a reader and is discounted 25%. The separately purchased reader is discounted 60%.

### Power Supplies

Part Number	Description	List Price	Type
97-000011-02	Power Supply 100-240VAC +5VDC 2-Pin Plug U.S./Euro Plug	€ 94	A
97-000012-02	Power Supply 100-240VAC +24VDC TRK 3-Pin U.S./Euro Plug)	€ 154	A

### Mounting and Connectors

Part Number	Description	List Price	Type
98-000048-01	Kit Mounting Arm/Adapter 4 in. for MS-2 MS-3	€ 78	A
98-000054-01	Kit Mounting Stand Base Plate	€ 36	A
98-000053-01	Mounting Arm Extension Kit 4 in. for MS-3 MS-4 MINI	€ 40	A
98-000053-02	Mounting Arm Extension Kit 3 in. for MS-2 MS-3 MS-4 MINI	€ 40	A
98-000060-01	Kit Bracket Side Mount MS-2 MS-3 MINI	€ 24	A
98-000059-01	Kit Bracket Angle Mount MS-2 MS-3 MINI	€ 24	A
98-000057-02	Kit Bracket Through-Hole Mount MS-2 MS-3 MINI	€ 24	A
98-000058-02	Kit Extended Right Angle Mirror MS-2 MS-3	€ 56	A
98-000061-03	Kit Bracket Conversion MS-2 MS-3-to-MS-520/MS-525	€ 24	A
20-610024-01	Trigger Connector 4-Pin Plug (Screw Terminal Field-Wireable) (Self-Wiring)	€ 33	A
20-610020-01	Power Conn. 3-Pin Socket (Screw Term. Field-Wireable for Custom IB-131 Wiring)	€ 33	A

### Package Detector/Sensor

Part Number	Description	List Price	Type
99-000017-01	Photo Sensor Visible NPN Dark ON	€ 196	A
99-000017-02	Photo Sensor Visible NPN Light ON	€ 196	A

### Software/Manuals

Part Number	Description	List Price	Type
37-000010-01*	Tools Drive, User Documentation, Software	€ 30	A

\* 1 free per order.

## Stand Alone (5V)

### Tech Reference MS-3

This is the basic setup for a single MS-3.

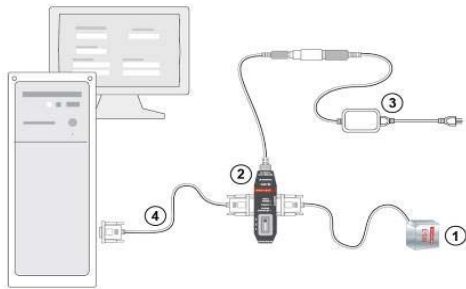

### System Matrix

Product	Reference No.	Description	List Price
(1) MS-3 Laser	FIS-0003-XXXXG	Scanner Model	Varies
(2) IB-3PC	FIS-0001-0030G	IB-3PC Keyboard Wedge/Interface Box	€ 166
(3) Power Supply	97-000011-01	Power Supply 100-240VAC +5VDC 5-Pin Plug U.S./Euro Plug	€ 94
(4) Communication Cable	61-000010-02	Cable Communication DB-9 Socket-to-DB-9 Socket 6 ft.	€ 36
Mounting Arm/Adapter Kit	98-000048-01	Kit Mounting Arm/Adapter 4 in. for MS-2 MS-3	€ 78
Mounting Plate	98-000054-01	Kit Mounting Stand Base Plate	€ 36
User Documentation, Software	37-000010-01*	Tools Drive, User Documentation, Software	€ 30

\* 1 free per order.

## Tech Reference MS-3

### Stand Alone (5V)

This is the basic setup for a single MS-3 and MS-Connect 210.

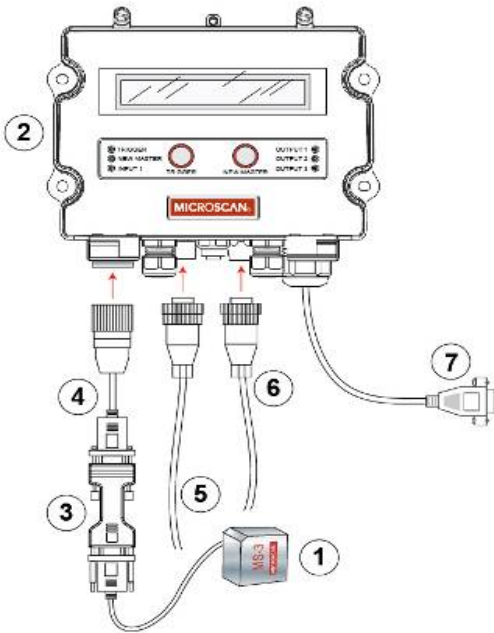

### System Matrix

Product	Reference No.	Description	List Price
1	FIS-0003-XXXXG	Scanner Model	Varies
2	FIS-0210-000XG	Connectivity Box A	Varies
3	FIS-0001-0035G	Converter IC-332 24V/5V Opto I/O for Use with IB-131	€ 184
4	61-000127-02	Cable MS-2-to-MS-Connect 210 6 ft.	€ 112
5	97-000012-02	Power Supply 100-240VAC +24VDC TRK 3-Pin U.S./Euro Plug)	€ 154
6	99-000017-02	Photo Sensor Visible NPN Light ON	€ 196
7	61-000105-01	Cable Pre-Stripped-to-9-Pin Host Cable 6 ft.	€ 32
User Documentation, Software	37-000010-01*	Tools Drive, User Documentation, Software	€ 30

<sup>A</sup> See MS-Connect Series section for a complete listing of Accessories

\*\* 1 free host cable is included with each MS-Connect 210

\* 1 free per order.

## Tech Reference MS-3

### Keyboard Wedge

Allows the scanner to bypass RS-232 port and input data to a host via the keyboard line.

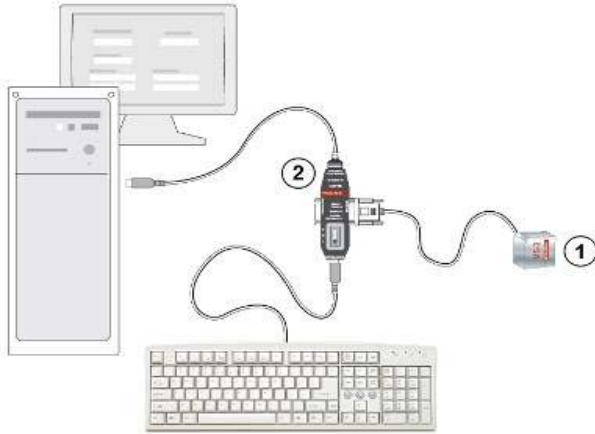

### System Matrix

Product	Reference No.	Description	List Price
1	FIS-0003-XXXXG	Scanner Model	Varies
2	FIS-0001-0030G	IB-3PC Keyboard Wedge/Interface Box	€ 166
Mounting Arm/Adapter Kit	98-000048-01	Kit Mounting Arm/Adapter 4 in. for MS-2 MS-3	€ 78
Mounting Plate	98-000054-01	Kit Mounting Stand Base Plate	€ 36
User Documentation, Software	37-000010-01*	Tools Drive, User Documentation, Software	€ 30

\* 1 free per order.

## Tech Reference MS-3

### USB

Allows the scanner to be powered and communicate via a USB port (virtual com port).

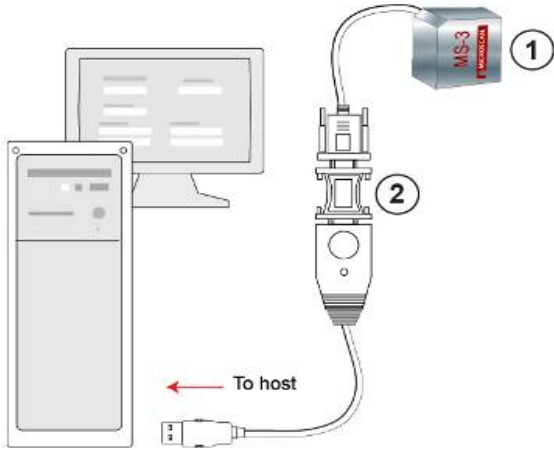

### System Matrix

Product	Reference No.	Description	List Price
1	FIS-0003-XXXXG	Scanner Model	Varies
2	98-000051-01	IC-3USB Interface Kit USB-to-Serial 15-Pin	€ 94
Mounting Arm/Adapter Kit	98-000048-01	Kit Mounting Arm/Adapter 4 in. for MS-2 MS-3	€ 78
Mounting Plate	98-000054-01	Kit Mounting Stand Base Plate	€ 36
User Documentation, Software	37-000010-01*	Tools Drive, User Documentation, Software	€ 30

\* 1 free per order.

## Tech Reference MS-3

### Stand Alone (10-28V)

This is the basic setup for a single MS-3.

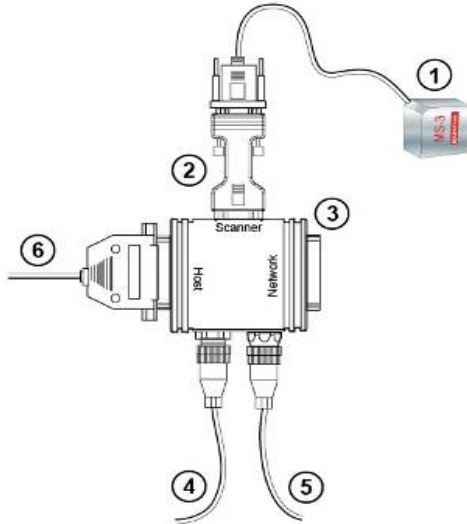

### System Matrix

Product	Reference No.	Description	List Price
1	FIS-0003-XXXXG	Scanner Model	Varies
2	FIS-0001-0035G	Converter IC-332 24V/5V Opto I/O for Use with IB-131	€ 184
3	99-000018-01	IB-131 Interface Box	€ 184
4	97-000012-02	Power Supply 100-240VAC +24VDC TRK 3-Pin U.S./Euro Plug)	€ 154
5	99-000017-01	Photo Sensor Visible NPN Dark ON	€ 196
6	61-300026-03	Cable Communication DB-25 Plug-to-DB-9 Socket 6 ft.	€ 36
Mounting Arm/Adapter Kit	98-000048-01	Kit Mounting Arm/Adapter 4 in. for MS-2 MS-3	€ 78
Mounting Plate	98-000054-01	Kit Mounting Stand Base Plate	€ 36
User Documentation, Software	37-000010-01*	Tools Drive, User Documentation, Software	€ 30

\* 1 free per order.

## Tech Reference MS-3

### Daisy Chain

A primary scanner is linked directly to the host. Secondary scanners (up to 9) are linked in tandem. Data is sent from the primary scanner directly to the host.

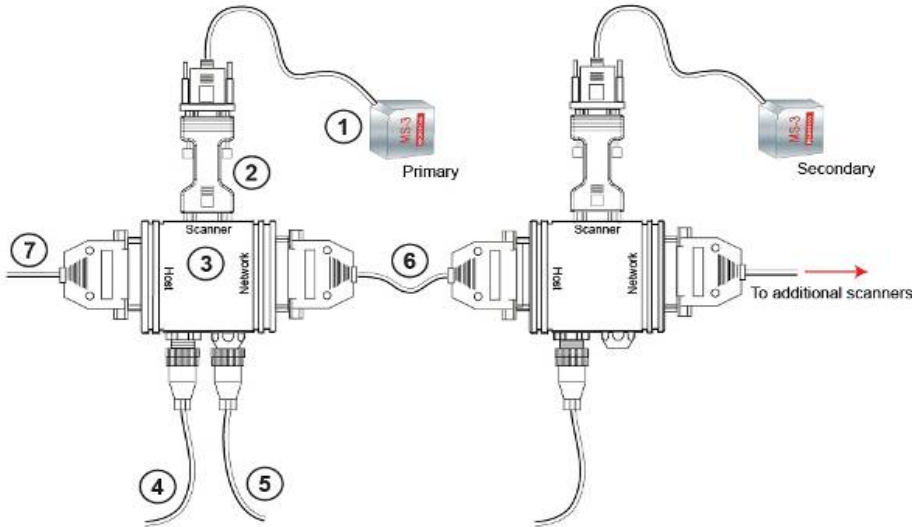

### System Matrix

Product	Reference No.	Description	List Price
1	FIS-0003-XXXXG	Scanner Model	Varies
2	FIS-0001-0035G	Converter IC-332 24V/5V Opto I/O for Use with IB-131	€ 184
3	99-000018-01	IB-131 Interface Box	€ 184
4	97-000012-02	Power Supply 100-240VAC +24VDC TRK 3-Pin U.S./Euro Plug)	€ 154
5	99-000017-01	Photo Sensor Visible NPN Dark ON	€ 196
6	61-100029-03	Cable Daisy Chain IB-131	€ 36
7	61-300026-03	Cable Communication DB-25 Plug-to-DB-9 Socket 6 ft.	€ 36
Mounting Arm/Adapter Kit	98-000048-01	Kit Mounting Arm/Adapter 4 in. for MS-2 MS-3	€ 78
Mounting Plate	98-000054-01	Kit Mounting Stand Base Plate	€ 36
User Documentation, Software	37-000010-01	Tools Drive, User Documentation, Software	€ 30

\* 1 free per order.

### Optional Interface Protocols

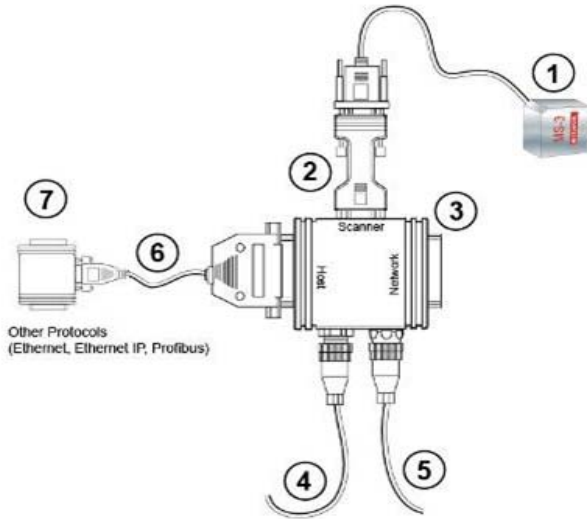

#### System Matrix

Product	Reference No.	Description	List Price
1	FIS-0003-XXXXG	Scanner Model	Varies
2	FIS-0001-0035G	Converter IC-332 24V/5V Opto I/O for Use with IB-131	€ 184
3	99-000018-01	IB-131 Interface Box	€ 184
4	97-000012-02	Power Supply 100-240VAC +24VDC TRK 3-Pin U.S./Euro Plug)	€ 154
5	99-000017-01	Photo Sensor Visible NPN Dark ON	€ 196
6	61-300026-03	Cable Communication DB-25 Plug-to-DB-9 Socket 6 ft.	€ 36
7	Third Party	Ask your Microscan sales representative which solution is appropriate for your application.	Varies
Mounting Arm/Adapter Kit	98-000048-01	Kit Mounting Arm/Adapter 4 in. for MS-2 MS-3	€ 78
Mounting Plate	98-000054-01	Kit Mounting Stand Base Plate	€ 36
User Documentation, Software	37-000010-01*	Tools Drive, User Documentation, Software	€ 30

\* 1 free per order.

# MICROSCAN

## QX-830 High Performance Compact Industrial Barcode Reader

### Read Ranges

Narrow Bar	High Density
5 mil (.127 mm)	4.0" to 5.5" (101 to 140 mm)
7.5 mil (.191 mm)	3.5" to 6.75" (89 to 171 mm)
10 mil (.254 mm)	3.25" to 8.0" (82 to 203 mm)
15 mil (.381 mm)	3.25" to 9.0" (82 to 228 mm)
Narrow Bar	Medium Density
7.5 mil (.191 mm)	2.5" to 5.5" (64 to 140 mm)
10 mil (.254 mm)	1.5" to 7.0" (38 to 178 mm)
15 mil (.381 mm)	1.5" to 8.5" (38 to 216 mm)
20 mil (.508 mm)	1.5" to 11" (38 to 280 mm)
30 mil (.762 mm)	1.0" to 12" (25 to 304 mm)
Narrow Bar	Low Density
7.5 mil (.191 mm)	10" to 12" (254 to 304 mm)
10 mil (.254 mm)	7.0" to 16" (177 to 406 mm)
15 mil (.381 mm)	6.0" to 19" (152 to 483 mm)
20 mil (.508 mm)	5.0" to 22" (127 to 558 mm)
40 mil (1.02 mm)	4.0" to 30" (101 to 762 mm)



Best Sellers
1) FIS-0830-1004G
2) FIS-0830-1005G

**\*\*Important Pricing Discount Note\*\*** Product discounts are applied based on the Product TYPE code shown in the TYPE column below. Product Type codes: P = PRODUCT Discount, A = ACCESSORY Discount. 'L' = Legacy status. Refer to your Partner Agreement for the actual discount percentage by Product Type.

### Scanners

Part Number	Description	List Price	Type
FIS-0830-0001G	QX-830 Scanner Single Line LD Serial	€ 1,674	P
FIS-0830-0002G	QX-830 Scanner Single Line MD Serial	€ 1,674	P
FIS-0830-0003G	QX-830 Scanner Single Line HD Serial	€ 1,674	P
FIS-0830-0004G	QX-830 Scanner Raster Line LD Serial	€ 1,674	P
FIS-0830-0005G	QX-830 Scanner Raster Line MD Serial	€ 1,674	P
FIS-0830-0006G	QX-830 Scanner Raster Line HD Serial	€ 1,674	P
FIS-0830-0010G	QX-830 Scanner Raster Line LD Serial Plastic Window	€ 1,674	P
FIS-0830-1001G	QX-830 Industrial Barcode Reader Single Line Low Density Serial+Ethernet	€ 1,860	P
FIS-0830-1002G	QX-830 Scanner Single Line MD Serial & Ethernet	€ 1,860	P
FIS-0830-1003G	QX-830 Scanner Single Line HD Serial & Ethernet	€ 1,860	P
FIS-0830-1004G	QX-830 Industrial Barcode Reader Raster Line Low Density Serial+Ethernet	€ 1,860	P
FIS-0830-1005G	QX-830 Scanner Raster Line MD Serial & Ethernet	€ 1,860	P
FIS-0830-1006G	QX-830 Scanner Raster Line HD Serial & Ethernet	€ 1,860	P
FIS-0830-1010G	QX-830 Scanner Raster Line LD Serial & Ethernet Plastic Window	€ 1,860	P

### Accessories

Part Number	Description	List Price	Type
98-000102-01*	Demo Kit QX-830/QX-870	€ 596	A

\* This Demo Kit does not contain a reader and is discounted 25%. The separately-purchased reader is discounted 60%.

### QX-1 and Cordsets

Part Number	Description	List Price	Type
98-000103-02	QX-1 Interface Device	€ 196	A
61-000148-01	QX CordsetCommonM12 12-Pin Socket(Ult.Lock)-to-M12 12-Pin Plug(Ult.Lock)3m.	€ 80	A
61-000148-02	QX CordsetCommonM12 12-Pin Socket(Screw-On)-to-M12 12-Pin Plug(Screw-On)3m.	€ 96	A
61-000162-02	QX CordsetCommonM12 12-Pin Socket(Screw-On)-to-M12 12-Pin Plug(Screw-On)1m.	€ 92	A
61-000153-02	QX Cordset Host Serial M12 12-Pin Socket (Screw-On)-to-DB-9 Socket 1 m.	€ 92	A
61-000164-02	QX Cordset Host Serial M12 12-Pin Socket (Screw-On)-to-DB-9 Socket 3 m.	€ 96	A
61-000152-02	QX Cordset Host Serial M12 12-Pin Plug (Screw-On)-to-DB-9 Socket 1 m.	€ 92	A
61-000165-02	QX Cordset Host Serial M12 12-Pin Plug (Screw-On)-to-DB-9 Socket 3 m.	€ 96	A
61-000163-03	QX Cordset Host Ethernet M12 8-Pin Plug (Screw-On)-to-RJ45 3 m.	€ 96	A
61-000160-01	QX Cordset Host Ethernet M12 8-Pin Plug (Ult.Lock)-to-RJ45 1 m.	€ 102	A
61-000160-03	QX Cordset Host Ethernet M12 8-Pin Plug (Screw-On)-to-RJ45 3 m.	€ 92	A
61-000172-02	QX CordsetM12 12-Pin Plug-to-M12 12-Pin Socket-to-DB-25 Plug Turck Connectors	€ 286	A
61-000158-03	QX Cordset M12 12-Pin Plug & M12 12-Pin Socket-to-MS-Connect 210 (RS-232) 2 m.	€ 374	A
61-000158-04	QX Cordset M12 12-Pin Plug & M12 12-Pin Socket-to-MS-Connect 210 (RS-422) 2 m.	€ 250	A
61-000166-02	QX Cordset M12 12-Pin Plug (Screw-On)-to-Flying Leads 3 m.	€ 96	A
61-000167-02	QX Cordset M12 12-Pin Socket (Screw-On)-to-Flying Leads 3 m.	€ 96	A
61-000159-03	QX Cordset M12 12-Pin Plug & Socket-to-IB-131 RS-232 2 m.	€ 182	A
61-000159-04	QX Cordset M12 12-Pin Socket-to-IB-131 RS-232/RS-485 2 m.	€ 182	A
98-000013-04	Relay Module120VAC3 Amp OutputSeries 70Type SMfor MS-Connect 210 + MS-890	€ 56	A
98-000013-05	Relay Module240VAC3 Amp OutputSeries 70Type SM for MS-Connect 210 + MS-890	€ 56	A
98-000013-06	Relay Module 24VDC 3 Amp Output Series 70 Type SM for MS-Connect 210MS-890	€ 56	A

# MICROSCAN

## QX-830 Industrial Scanner Continued

### Power Supplies

Part Number	Description	List Price	Type
97-000012-01	Power Supply 100-240VAC +24VDC M12 12-pin Socket	€ 140	A
97-000012-04	QX Power Supply 24V M12 12 pin Plug USA /Euro Plug	€ 136	A

### Package Detector/Sensor

Part Number	Description	List Price	Type
99-000020-02	QX Photo Sensor M12 4-Pin Plug NPN Dark On 2 m.	€ 196	A
99-000020-01	QX Photo Sensor M12 4-Pin Plug NPN Dark Off 2 m.	€ 196	A

### Mounting and Connectors

Part Number	Description	List Price	Type
98-500006-01*	Kit Mounting Plate MS-710 MS-820 QX-830 QX-870	€ 24	A
98-200026-02	Kit Right Angle Mirror MS-820/QX-830	€ 84	A
61-000166-02	QX Cordset M12 12-Pin Plug (Screw-On)-to-Flying Leads 3 m.	€ 96	A
61-000167-02	QX Cordset M12 12-Pin Socket (Screw-On)-to-Flying Leads 3 m.	€ 96	A
20-610024-01	Trigger Connector 4-Pin Plug (Screw Terminal Field-Wireable) (Self-Wiring)	€ 33	A
98-000016-01	Kit 6 in. Mounting Arm/Adapter MS-820 QX-830 QX-870	€ 120	A
98-000037-01	Mounting Arm Extension Kit 6 in. All Readers	€ 62	A
98-000054-01	Kit Mounting Stand Base Plate	€ 36	A
98-000148-01	Kit L-Bracket QX Series	€ 46	A

\* Though-hole mounting plate; not for use with mounting arm.

### Software/Manuals

Part Number	Description	List Price	Type
37-000010-01*	Tools Drive, User Documentation, Software	€ 30	A

\* 1 free per order.

## Tech Reference QX-830

## Stand Alone Configurations

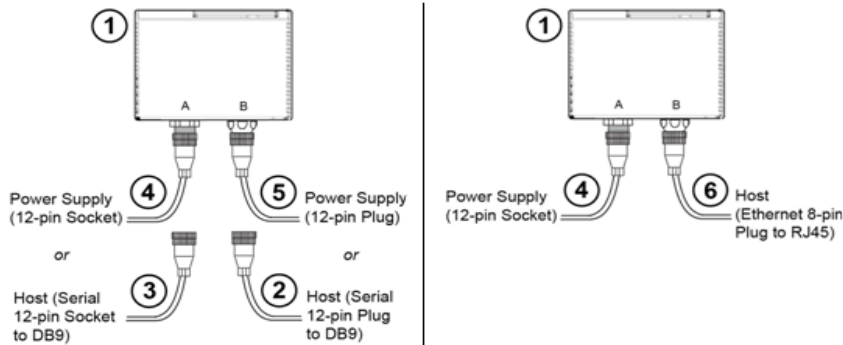

Item	Part Number	Description	List Price
1	FIS-0830-XXXXG	QX-830 Compact Industrial Scanner	Varies
2	61-000152-02*	QX Cordset, Host, Serial, M12 12-Pin Plug (Screw-On)-to-DB-9 Socket, 1 m.	€ 92
3	61-000153-02*	QX Cordset, Host, Serial, M12 12-Pin Socket (Screw-On)-to-DB-9 Socket, 1 m.	€ 92
4	97-000012-01	Power Supply, 100-240VAC, +24VDC, M12 12-Pin Socket	€ 140
5	97-000012-04	QX Power Supply, 24V, M12 12 pin Plug, USA /Euro Plug	€ 136
6	61-000160-01	QX Cordset, Host, Ethernet, M12 8-Pin Plug (Ult.Lock)-to-RJ45, 1 m.	€ 102
	98-000016-01	Kit, 6 in. Mounting Arm/Adapter, MS-820, QX-830, QX-870	€ 120
	98-000054-01	Kit, Mounting Stand Base Plate	€ 36
	37-000010-01**	Tools Drive, User Documentation, Software	€ 30

\* Cordsets available in multiple lengths

\*\* One free per order.

## Tech Reference QX-830

### Stand Alone Configurations

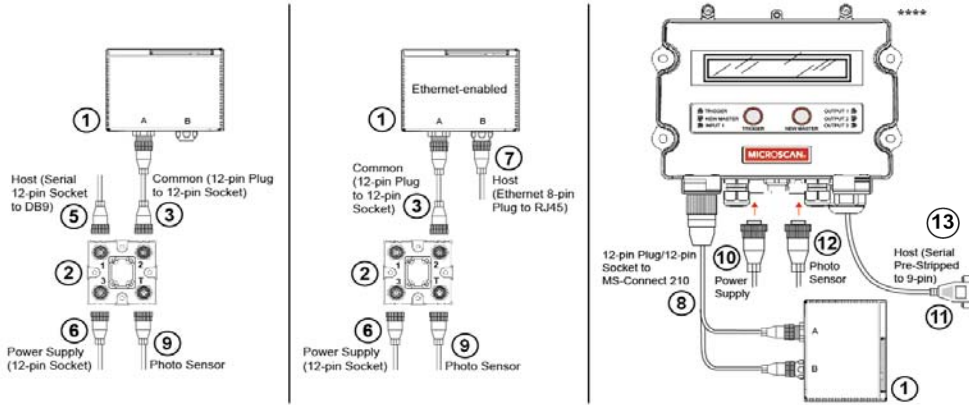

Item	Part Number	Description	List Price
1	FIS-0830-XXXG	QX-830 Compact Industrial Scanner	Varies
2	98-000103-02	QX-1 Interface Device	€ 196
3	61-000162-02*	QX Cordset, Common, M12 12-Pin Socket (Screw-On)-to-M12 12-Pin Plug (Screw-On), 1m.	€ 92
4	61-000152-02*	QX Cordset, Host, Serial, M12 12-Pin Plug (Screw-On)-to-DB-9 Socket, 1 m.	€ 92
5	61-000153-02*	QX Cordset, Host, Serial, M12 12-Pin Socket (Screw-On)-to-DB-9 Socket, 1 m.	€ 92
6	97-000012-01	Power Supply, 100-240VAC, +24VDC, M12 12-Pin Socket	€ 140
7	61-000160-01*	QX Cordset, Host, Ethernet, M12 8-Pin Plug (Ult.Lock)-to-RJ45, 1 m.	€ 102
8	61-000158-03	QX Cordset, M12 12-Pin Plug & M12 12-Pin Socket-to-MS-Connect 210 (RS-232), 2 m.	€ 374
9	99-000020-02	QX Photo Sensor, M12 4-Pin Plug, NPN, Dark On, 2 m.	€ 196
10	97-000012-02	Power Supply, 100-240VAC, +24VDC, TRK 3-Pin, U.S./Euro Plug)	€ 154
11	61-000105-01	Cable, Pre-Stripped-to-9-Pin Host Cable, 6 ft.	€ 32
12	99-000017-01	Photo Sensor, Visible, NPN, Dark ON	€ 196
13	FIS-0210-000XG***	Connectivity Box	Varies
	98-000016-01	Kit, 6 in. Mounting Arm/Adapter, MS-820, QX-830, QX-870	€ 120
	98-000054-01	Kit, Mounting Stand Base Plate	€ 36
	37-000010-01**	Tools Drive, User Documentation, Software	€ 30

\* Cordsets available in multiple lengths

\*\* One free per order.

\*\*\* Refer to MS-Connection section for complete listing of MS-Connection 210 options

### Daisy Chain Configurations

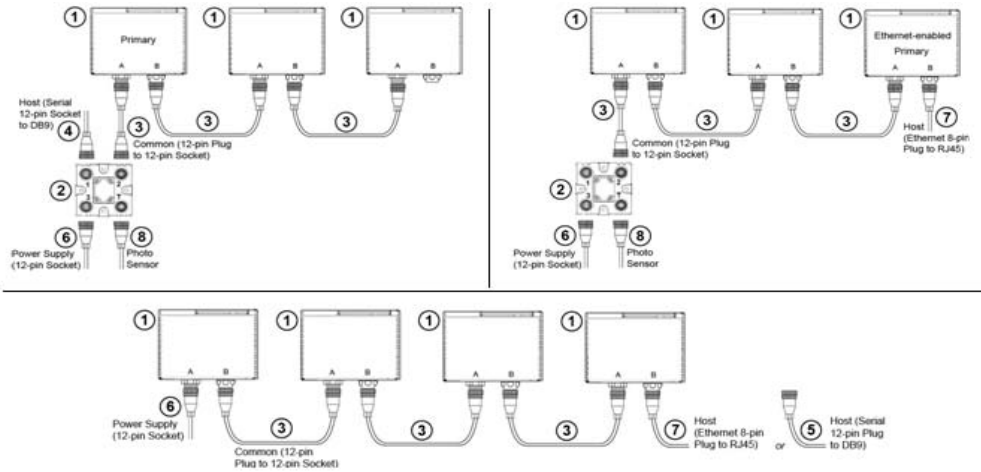

Item	Part Number	Description	List Price
1	FIS-0830-XXXXG	QX-830 Compact Industrial Scanner	Varies
2	98-000103-02	QX-1 Interface Device	€ 196
3	61-000162-02*	QX Cordset, Common, M12 12-Pin Socket (Screw-On)-to-M12 12-Pin Plug (Screw-On), 1m.	€ 92
4	61-000153-02*	QX Cordset, Host, Serial, M12 12-Pin Socket (Screw-On)-to-DB-9 Socket, 1 m.	€ 92
5	61-000152-02*	QX Cordset, Host, Serial, M12 12-Pin Plug (Screw-On)-to-DB-9 Socket, 1 m.	€ 92
6	97-000012-01	Power Supply, 100-240VAC, +24VDC, M12 12-Pin Socket	€ 140
7	61-000160-01	QX Cordset, Host, Ethernet, M12 8-Pin Plug (Ult.Lock)-to-RJ45, 1 m.	€ 102
8	99-000020-02	QX Photo Sensor, M12 4-Pin Plug, NPN, Dark On, 2 m.	€ 196
	98-000016-01	Kit, 6 in. Mounting Arm/Adapter, MS-820, QX-830, QX-870	€ 120
	98-000054-01	Kit, Mounting Stand Base Plate	€ 36
	37-000010-01**	Tools Drive, User Documentation, Software	€ 30

\* Cordsets available in multiple lengths

\*\* One free per order.

### Optional Interface Protocols

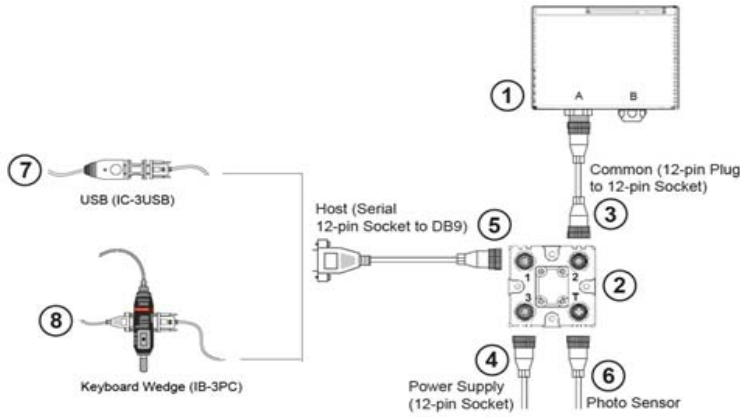

Item	Part Number	Description	List Price
1	FIS-0830-XXXXG	QX-830 Compact Industrial Scanner	Varies
2	98-000103-02	QX-1 Interface Device	€ 196
3	61-000162-02*	QX Cordset, Common, M12 12-Pin Socket(Screw-On)-to-M12 12-Pin Plug(Screw-On), 1m.	€ 92
4	97-000012-01	Power Supply, 100-240VAC, +24VDC, M12 12-Pin Socket	€ 140
5	61-000153-02*	QX Cordset, Host, Serial, M12 12-Pin Socket (Screw-On)-to-DB-9 Socket, 1 m.	€ 92
6	99-000020-02	QX Photo Sensor, M12 4-Pin Plug, NPN, Dark On, 2 m.	€ 196
7	98-000051-01	IC-3USB Interface Kit, USB-to-Serial, 15-Pin	€ 94
8	FIS-0001-0030G	IB-3PC Keyboard Wedge/Interface Box	€ 166
	98-000016-01	Kit, 6 in. Mounting Arm/Adapter, MS-820, QX-830, QX-870	€ 120
	98-000054-01	Kit, Mounting Stand Base Plate	€ 36
	37-000010-01**	Tools Drive, User Documentation, Software	€ 30

\* Cordsets available in multiple lengths. See Accessories section for additional detail.

\*\* One free per order.

# MICROSCAN.

## QX-870 High Performance Industrial Sweeping Raster Barcode Reader

Read Ranges	
<b>Narrow Bar</b>	<b>High Density</b>
5 mil (.127 mm)	4" to 5" (102 to 127 mm)
7.5 mil (.191 mm)	3.5" to 6.75" (89 to 171 mm)
10 mil (.254 mm)	3.25" to 8" (82 to 203 mm)
15 mil (.381 mm)	3.25" to 9" (82 to 228 mm)
<b>Narrow Bar</b>	<b>Medium Density</b>
7.5 mil (.191 mm)	2.5" to 5.5" (64 to 140 mm)
10 mil (.254 mm)	1.5" to 7" (38 to 178 mm)
15 mil (.381 mm)	1.5" to 8.5" (38 to 216 mm)
30 mil (.762 mm)	1" to 12" (25 to 304 mm)
<b>Narrow Bar</b>	<b>Low Density</b>
7.5 mil (.191 mm)	10" to 12" (254 to 305 mm)
10 mil (.254 mm)	7" to 16" (178 to 406 mm)
15 mil (.381 mm)	6" to 19" (152 to 483 mm)
20 mil (.508 mm)	5" to 22" (127 to 558 mm)
40 mil (1.02 mm)	4" to 30" (102 to 762 mm)



Best Sellers
1) FIS-0870-0004G
2) FIS-0870-1004G

**\*\*Important Pricing Discount Note\*\* Product discounts are applied based on the Product TYPE code shown in the TYPE column below.**

Product Type codes are defined as: P = PRODUCT Discount, A = ACCESSORY Discount.

A Product Type code modified with L signifies Legacy Status (refer to Legacy section of this catalog).

Refer to your Partner Agreement for the actual discount percentage by Product Type.

Barcode Readers		List Price	Type
FIS-0870-0004G	QX-870 Industrial Barcode Reader Low Density Sweeping Raster Serial	€ 2,540	P
FIS-0870-0005G	QX-870 Industrial Barcode Reader Medium Density Sweeping Raster Serial	€ 2,540	P
FIS-0870-0006G	QX-870 Industrial Barcode Reader High Density Sweeping Raster Serial	€ 2,540	P
FIS-0870-0007G	QX-870 Industrial Barcode Rdr Plastic Window Low Density Sweeping Raster Serial	€ 2,774	P
FIS-0870-1004G	QX-870 Industrial Barcode Reader Low Density Sweeping Raster Serial+Ethernet	€ 2,736	P
FIS-0870-1005G	QX-870 Industrial Barcode Reader Medium Density Sweeping Raster Serial+Ethernet	€ 2,736	P
FIS-0870-1006G	QX-870 Industrial Barcode Reader High Density Sweeping Raster Serial+Ethernet	€ 2,736	P

QX-1 and Cordsets		List Price	Type
98-000103-02	QX-1 Interface Device	€ 196	A
61-000148-01	QX Cordset Common M12 12-Pin Socket (Ult.Lock)-to-M12 12-Pin Plug (Ult.Lock) 3m.	€ 80	A
61-000148-02	QX Cordset Common M12 12-Pin Socket (Screw-On)-to-M12 12-Pin Plug (Screw-On) 3m.	€ 96	A
61-000162-02	QX Cordset Common M12 12-Pin Socket (Screw-On)-to-M12 12-Pin Plug (Screw-On) 1m.	€ 92	A
61-000153-02	QX Cordset Host Serial M12 12-Pin Socket (Screw-On)-to-DB-9 Socket 1 m.	€ 92	A
61-000164-02	QX Cordset Host Serial M12 12-Pin Socket (Screw-On)-to-DB-9 Socket 3 m.	€ 96	A
61-000152-02	QX Cordset Host Serial M12 12-Pin Plug (Screw-On)-to-DB-9 Socket 1 m.	€ 92	A
61-000165-02	QX Cordset Host Serial M12 12-Pin Plug (Screw-On)-to-DB-9 Socket 3 m.	€ 96	A
61-000163-03	QX Cordset Host Ethernet M12 8-Pin Plug (Screw-On)-to-RJ45 3 m.	€ 96	A
61-000160-01	QX Cordset Host Ethernet M12 8-Pin Plug (Ult.Lock)-to-RJ45 1 m.	€ 102	A
61-000160-03	QX Cordset Host Ethernet M12 8-Pin Plug (Screw-On)-to-RJ45 1 m.	€ 92	A
61-000172-02	QX Cordset M12 12-Pin Plug-to-M12 12-Pin Socket-to-DB-25 Plug Turck Connectors	€ 286	A
61-000158-03	QX Cordset M12 12-Pin Plug & M12 12-Pin Socket-to-MS-Connect 210 (RS-232) 2 m.	€ 374	A
61-000158-04	QX Cordset M12 12-Pin Plug & M12 12-Pin Socket-to-MS-Connect 210 (RS-422) 2 m.	€ 250	A
61-000166-02	QX Cordset M12 12-Pin Plug (Screw-On)-to-Flying Leads 3 m.	€ 96	A
61-000167-02	QX Cordset M12 12-Pin Socket (Screw-On)-to-Flying Leads 3 m.	€ 96	A
98-000013-04	Relay Module 120VAC 3 Amp Output Series 70 Type SM for MS-Connect 210 + MS-890	€ 56	A
98-000013-05	Relay Module 240VAC 3 Amp Output Series 70 Type SM for MS-Connect 210 + MS-890	€ 56	A
98-000013-06	Relay Module 24VDC 3 Amp Output Series 70 Type SM for MS-Connect 210 MS-890	€ 56	A

## QX-870 Industrial Scanner Accessories (Similar to QX-830)

### Accessories

Part Number	Description	List Price	Type
98-000102-01*	Demo Kit QX-830/QX-870	€ 596	A

\* This Demo Kit does not contain a reader and is discounted 25%. The separately purchased reader is discounted 60%.

### Power Supplies

Part Number	Description	List Price	Type
97-000012-01	Power Supply 100-240VAC +24VDC M12 12-pin Socket	€ 140	A
97-000012-04	QX Power Supply 24V M12 12 pin Plug USA /Euro Plug	€ 136	A

### Package Detector/Sensor

Part Number	Description	List Price	Type
99-000020-02	QX Photo Sensor M12 4-Pin Plug NPN Dark On 2 m.	€ 196	A
99-000020-01	QX Photo Sensor M12 4-Pin Plug NPN Dark Off 2 m.	€ 196	A

### Mounting and Connectors

Part Number	Description	List Price	Type
98-500006-01*	Kit Mounting Plate MS-710 MS-820 QX-830 QX-870	€ 24	A
20-610024-01	Trigger Connector 4-Pin Plug (Screw Terminal Field-Wireable) (Self-Wiring)	€ 33	A
61-000166-02	QX Cordset M12 12-Pin Plug (Screw-On)-to-Flying Leads 3 m.	€ 96	A
61-000167-02	QX Cordset M12 12-Pin Socket (Screw-On)-to-Flying Leads 3 m.	€ 96	A
98-000016-01	Kit 6 in. Mounting Arm/Adapter MS-820 QX-830 QX-870	€ 120	A
98-000037-01	Mounting Arm Extension Kit 6 in. All Readers	€ 62	A
98-000054-01	Kit Mounting Stand Base Plate	€ 36	A
98-000148-01	Kit L-Bracket QX Series	€ 46	A

\* Though-hole mounting plate; not for use with mounting arm.

### Software/Manuals

Part Number	Description	List Price	Type
37-000010-01*	Tools Drive, User Documentation, Software	€ 30	A

\* 1 free per order.

### Stand Alone Configurations

#### MS-Connect 210

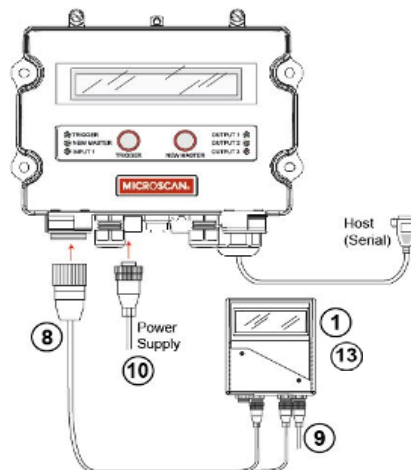
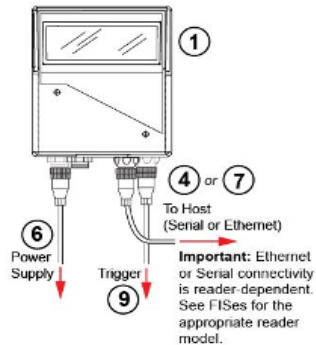

Item	Part Number	Description	List Price
1	FIS-0870-XXXXG	QX-870 Industrial Raster Barcode Reader	Varies
4	61-000152-02*	QX Cordset, Host, Serial, M12 12-Pin Plug (Screw-On)-to-DB-9 Socket, 1 m.	€ 92
6	97-000012-01	Power Supply, 100-240VAC, +24VDC, M12 12-Pin Socket	€ 140
7	61-000160-01*	QX Cordset, Host, Ethernet, M12 8-Pin Plug (Ult.Lock)-to-RJ45, 1 m.	€ 102
8	61-000158-03	QX Cordset, M12 12-Pin Plug & M12 12-Pin Socket-to-MS-Connect 210 (RS-232), 2 m.	€ 374
9	99-000020-02***	QX Photo Sensor, M12 4-Pin Plug, NPN, Dark On, 2 m.	€ 196
10	97-000012-02	Power Supply, 100-240VAC, +24VDC, TRK 3-Pin, U.S./Euro Plug)	€ 154
13	FIS-0210-000XG****	Connectivity Box	Varies
	98-000016-01	Kit, 6 in. Mounting Arm/Adapter, MS-820, QX-830, QX-870	€ 120
	98-000054-01	Kit, Mounting Stand Base Plate	€ 36
	37-000010-01**	Tools Drive, User Documentation, Software	€ 30

\* Cordsets available in multiple lengths

\*\* One free per order.

\*\*\*QX-870 with MS-Connect 210 requires a PNP photo sensor such as IDEX SA1E-NP1 (LO) and -NP2 (DO)

\*\*\*\* Refer to MS-Connection section for complete listing of MS-Connection 210 options

### Daisy Chain Configuration

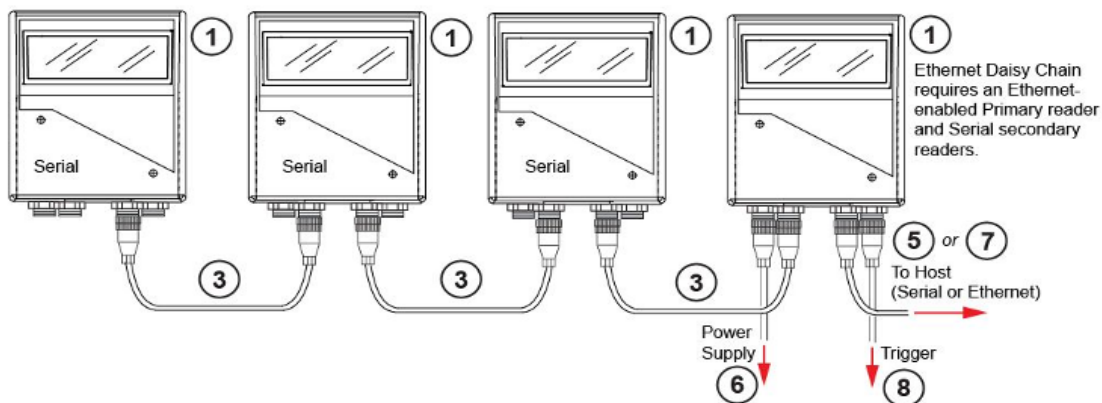

Please also Reference QX-830 section for alternative Daisy Chain configurations

Item	Part Number	Description	List Price
1	FIS-0870-XXXXG	QX-870 Industrial Raster Barcode Reader	Varies
2	98-000103-02	QX-1 Interface Device	€ 196
3	61-000162-02*	QX Cordset, Common, M12 12-Pin Socket (Screw-On)-to-M12 12-Pin Plug (Screw-On), 1m.	€ 92
4	61-000153-02*	QX Cordset, Host, Serial, M12 12-Pin Socket (Screw-On)-to-DB-9 Socket, 1 m.	€ 92
5	61-000152-02*	QX Cordset, Host, Serial, M12 12-Pin Plug (Screw-On)-to-DB-9 Socket, 1 m.	€ 92
6	97-000012-01	Power Supply, 100-240VAC, +24VDC, M12 12-Pin Socket	€ 140
7	61-000160-01*	QX Cordset, Host, Ethernet, M12 8-Pin Plug (Ult.Lock)-to-RJ45, 1 m.	€ 102
8	99-000020-02	QX Photo Sensor, M12 4-Pin Plug, NPN, Dark On, 2 m.	€ 196
	98-000016-01	Kit, 6 in. Mounting Arm/Adapter, MS-820, QX-830, QX-870	€ 120
	98-000054-01	Kit, Mounting Stand Base Plate	€ 36
	37-000010-01**	Tools Drive, User Documentation, Software	€ 30

\* Cordsets available in multiple lengths

\*\* One free per order.

# MICROSCAN

## MS-890 Industrial Barcode Reader

### Read Ranges

Narrow Bar	
7.5 mil (.191 mm)	10" to 35" (254 to 889 mm)
15 mil (.381 mm)	10" to 74" (254 to 1880 mm)
20 mil (.508 mm)	10" to 90" (254 to 2286 mm)
30 mil (.762 mm)	10" to 100" (254 to 2540 mm)
40 mil (1.02 mm)	10" to 110" (254 to 2794 mm)
50 mil (1.27 mm)	10" to 120" (254 to 2048 mm)



Best Seller  
1) FIS-0890-0001G

**\*\*Important Pricing Discount Note\*\*** Product discounts are applied based on the Product TYPE code shown in the TYPE column below.

Product Type codes are defined as: P = PRODUCT Discount, A = ACCESSORY Discount.

A Product Type code modified with L signifies Legacy Status (refer to Legacy section of this catalog).

Refer to your Partner Agreement for the actual discount percentage by Product Type.

### MS-890 Industrial Barcode Reader

Part Number	Description	List Price	Type
FIS-0890-0001G	MS-890 Scanner Long Range Standalone Version RS-232/48510-28VDC	€ 5,400	P
FIS-0890-0002G	MS-890 Scanner Long Range Wiring Box-Ready RS-232/48510-28VDC	€ 5,588	P

### Wiring Box

Part Number	Description	List Price	Type
99-420003-04	Accessory Wiring Box IB-890	€ 352	A
98-000013-04	Relay Module 120VAC 3 Amp Output Series 70 Type SM for MS-Connect 210 + MS-890	€ 56	A
98-000013-05	Relay Module 240VAC 3 Amp Output Series 70 Type SM for MS-Connect 210 + MS-890	€ 56	A
98-000013-06	Relay Module 24VDC 3 Amp Output Series 70 Type SM for MS-Connect 210MS-890	€ 56	A
12-000130-01*	Cable Grommet (Sealed Strain Relief Wire Clamp)	€ 15	A

1 Included with 99-420003-04

### Accessories

Part Number	Description	List Price	Type
FIS-0210-0001G	MS-Connect 210 Connectivity Box with Display	€ 880	A
FIS-0210-0002G	MS-Connect 210 Connectivity Box	€ 600	A
FIS-0210-0003G	MS-Connect 210 Connectivity Box with Display & Ethernet	€ 1,000	A
FIS-0210-0004G	MS-Connect 210 Connectivity Box with Ethernet	€ 880	A
98-000013-04	Relay Module 120VAC 3 Amp Output Series 70 Type SM for MS-Connect 210 + MS-890	€ 56	A
98-000013-05	Relay Module 240VAC 3 Amp Output Series 70 Type SM for MS-Connect 210 + MS-890	€ 56	A
98-000013-06	Relay Module 24VDC 3 Amp Output Series 70 Type SM for MS-Connect 210MS-890	€ 56	A
61-000122-01	Cable to MS-Connect 210 Host RS-422/RS-485 for Multidrop 6 ft.	€ 112	A
61-000123-01	Cable to MS-Connect 210 Host/Aux RS-232 for Daisy Chain 210-to-210 6 ft.	€ 112	A
FIS-0001-0030G	IB-3PC Keyboard Wedge/Interface Box	€ 166	A
98-000040-02	Cable Interface & Reader 6 ft. IB-150	€ 196	A
98-000051-01	IC-3USB Interface Kit USB-to-Serial 15-Pin	€ 94	A
61-000034-02	Cable Communication/Serial 25-Pin Socket-to-9-Pin Socket 6 ft.	€ 32	A
61-100029-03	Cable Daisy Chain IB-131	€ 36	A
61-000010-02	Cable Communication DB-9 Socket-to-DB-9 Socket 6 ft.	€ 36	A
98-000011-01	Kit Glass Window Replacement MS-890	€ 90	A
98-000011-02	Kit Plastic Window Replacement MS-890	€ 144	A
61-000154-01	Adapter Daisy Chain	€ 84	A
98-000090-03*	Demo Kit MS-890	€ 596	A

\* This Demo Kit does not contain a reader and is discounted 25%. The separately purchased reader is discounted 60%.

## Power Supply

Part Number	Description	List Price	Type
97-000012-02	Power Supply 100-240VAC +24VDC TRK 3-Pin U.S./Euro Plug)	€ 154	A

## Mounting and Connectors

Part Number	Description	List Price	Type
98-000017-01	Mounting Arm/Adapter Kit IB-890 6 in.	€ 100	A
98-000018-01	Mounting Arm/Adapter Kit MS-890 6 in.	€ 100	A
98-000046-01	Large Base Plate 12 in.x12 in.	€ 46	A
98-200037-01	Kit Mounting Plate MS-890	€ 46	A
20-610024-01	Trigger Connector 4-Pin Plug (Screw Terminal Field-Wireable) (Self-Wiring)	€ 33	A
20-610020-01	Power Conn.3-Pin Socket (Screw Term.Field-Wireable for Custom IB-131 Wiring)	€ 33	A

## Package Detector/Sensor

Part Number	Description	List Price	Type
99-000004-01	Package Detector Standard Diffuse 120 in. Range 4-Pin Plug	€ 250	A
99-000004-02	Package Detector Standard Diffuse 120 in. Range Unterminated	€ 250	A
99-000017-01	Photo Sensor Visible NPN Dark ON	€ 196	A
99-000017-02	Photo Sensor Visible NPN Light ON	€ 196	A

## Software / Manuals

Part Number	Description	List Price	Type
37-000010-01*	Tools Drive, User Documentation, Software	€ 30	A

\*One free per order

## Tech Reference MS-890

### Stand Alone

This is the basic setup for a single MS-890.

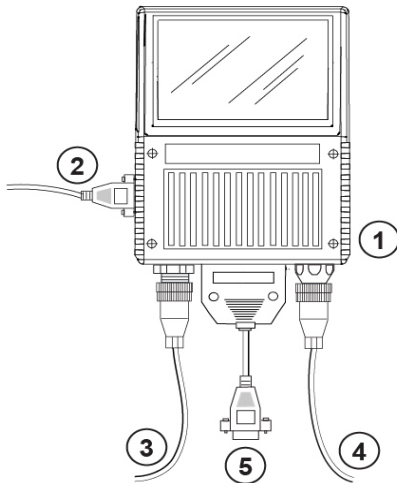

## System Matrix

Product	Reference No.	Description	List Price
1	FIS-0890-0001G	Scanner, Industrial, Long Range	Varies
2	61-000010-02	Cable, Communication, DB-9 Socket-to-DB-9 Socket, 6 ft.	€ 36
3	97-000012-02	Power Supply, 100-240VAC, +24VDC, TRK 3-Pin, U.S./Euro Plug)	€ 154
4	99-000004-01	Package Detector, Standard Diffuse, 120 in. Range, 4-Pin Plug	€ 250
5	61-000034-02	Cable, Communication/Serial, 25-Pin Socket-to-9-Pin Socket, 6 ft.	€ 32
Mounting Arm Kit	98-000018-01	Mounting Arm/Adapter Kit, MS-890, 6 in.	€ 100
Mounting Plate	98-000046-01	Large Base Plate, 12 in.x12 in.	€ 46
User Documentation, Software	37-000010-01*	Tools Drive, User Documentation, Software	€ 30

\* 1 free per order.

## Tech Reference *MS-890*

### Stand Alone

with Wiring Box

This is the basic setup for a single MS-890 with IB-890 Wiring Box.

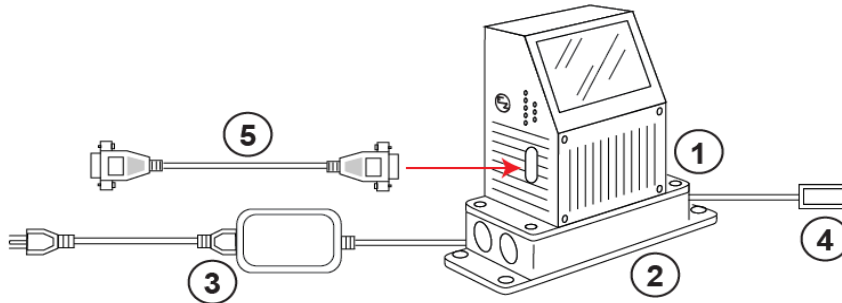

### System Matrix

Product	Reference No.	Description	List Price
1	FIS-0890-0002G	Scanner, Industrial, Wiring Box-Ready	Varies
2	99-420003-04	Accessory, Wiring Box, IB-890	€ 352
3***	97-000012-02	Power Supply, 100-240VAC, +24VDC, TRK 3-Pin, U.S./Euro Plug)	€ 154
4	99-000004-02	Package Detector, Standard Diffuse, 120 in. Range, Unterminated	€ 250
5	61-000010-02	Cable, Communication, DB-9 Socket-to-DB-9 Socket, 6 ft.	€ 36
Mounting Arm/Adapter Kit	98-000017-01	Mounting Arm/Adapter Kit, IB-890, 6 in.	€ 100
Mounting Plate	98-000046-01	Large Base Plate, 12 in.x12 in.	€ 46
User Documentation, Software	37-000010-01*	Tools Drive, User Documentation, Software	€ 30

\* 1 free per order.

\*\*\* Remove connectors before installation.

## Tech Reference *MS-890*

### Stand Alone with MS-Connect 210

This is the basic setup for a single MS-890 and MS-Connect 210.

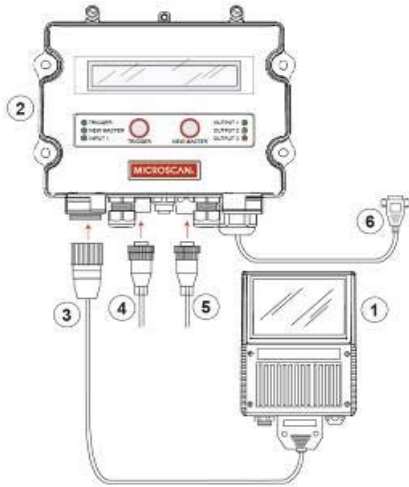

### System Matrix

Product	Reference No.	Description	List Price
1	FIS-0890-0001G	Scanner, Industrial, Long Range	Varies
2	FIS-0210-000XG*	MS-Connect 210 Connectivity Box	Varies
3†	61-000122-01	Cable to MS-Connect 210, Host RS-422/RS-485 for Multidrop, 6 ft.	€ 112
	61-000123-01	Cable to MS-Connect 210, Host/Aux RS-232 for Daisy Chain, 210-to-210, 6 ft.	€ 112
4	97-000012-02	Power Supply, 100-240VAC, +24VDC, TRK 3-Pin, U.S./Euro Plug)	€ 154
5	99-000017-02	Photo Sensor, Visible, NPN, Light ON	€ 196
6	61-000105-01**	Cable, Pre-Stripped-to-9-Pin Host Cable, 6 ft.	€ 32
User Documentation, Software	37-000010-01***	Tools Drive, User Documentation, Software	€ 30

\* See MS-Connect Series section for a complete listing of Accessories

\*\* 1 free host cable is included with each MS-Connect 210

\*\*\* 1 free per order.

† Choose one cable.

## Tech Reference *MS-890*

### Stand Alone

with MS-Connect 210 with Ethernet

This is the basic setup for a single MS-890 and MS-Connect 210 with Ethernet.

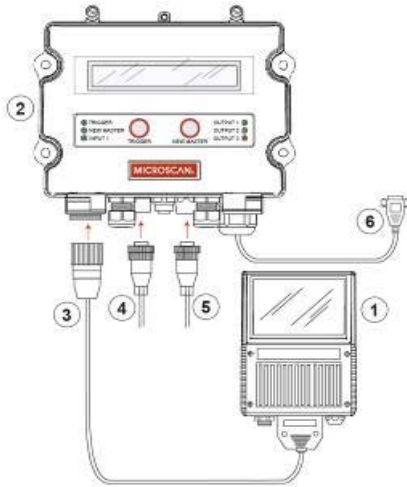

### System Matrix

Product	Reference No.	Description	List Price
1	FIS-0890-0001G	Scanner, Industrial, Long Range	Varies
2	FIS-0210-0004G	MS-Connect 210, Connectivity Box with Ethernet	€ 880
3†	61-000122-01	Cable to MS-Connect 210, Host RS-422/RS-485 for Multidrop, 6 ft.	€ 112
	61-000123-01	Cable to MS-Connect 210, Host/Aux RS-232 for Daisy Chain, 210-to-210, 6 ft.	€ 112
4	97-000012-02	Power Supply, 100-240VAC, +24VDC, TRK 3-Pin, U.S./Euro Plug)	€ 154
5	99-000017-02	Photo Sensor, Visible, NPN, Light ON	€ 196
6	61-000105-01**	Cable, Pre-Stripped-to-9-Pin Host Cable, 6 ft.	€ 32
User Documentation, Software	37-000010-01***	Tools Drive, User Documentation, Software	€ 30

\* See MS-Connect Series section for a complete listing of Accessories

\*\* 1 free host cable is included with each MS-Connect 210

\*\*\* 1 free per order.

† Choose one cable.

## Tech Reference MS-890

### Daisy Chain

A primary scanner is linked directly to the host. Secondary scanners (up to 9) are linked in tandem. Data is sent from the primary scanner directly to the host.

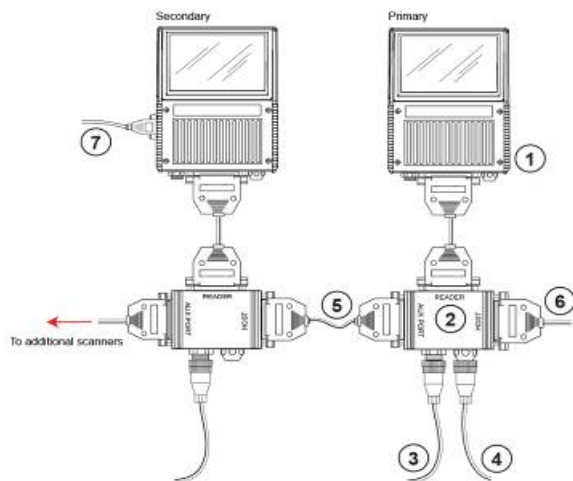

### System Matrix

Product	Reference No.	Description	List Price
1	FIS-0890-0001G	Scanner, Industrial, Long Range	Varies
2	98-000040-02	Cable, Interface & Reader, 6 ft., IB-150	€ 196
3	97-000012-02	Power Supply, 100-240VAC, +24VDC, TRK 3-Pin, U.S./Euro Plug)	€ 154
4	99-000004-01	Package Detector, Standard Diffuse, 120 in. Range, 4-Pin Plug	€ 250
5	61-100029-03	Cable, Daisy Chain, IB-131	€ 36
6	61-000034-02***	Cable, Communication/Serial, 25-Pin Socket-to-9-Pin Socket, 6 ft.	€ 32
7	61-000010-02	Cable, Communication, DB-9 Socket-to-DB-9 Socket, 6 ft.	€ 36
Mounting Arm Kit	98-000018-01	Mounting Arm/Adapter Kit, MS-890, 6 in.	€ 100
Mounting Plate	98-000046-01	Large Base Plate, 12 in.x12 in.	€ 46
User Documentation, Software	37-000010-01*	Tools Drive, User Documentation, Software	€ 30

\* 1 free per order.

\*\*\* If using another communications cable, make sure it does not have RTS/CTS connected to the host.

### Optional Interface Protocols

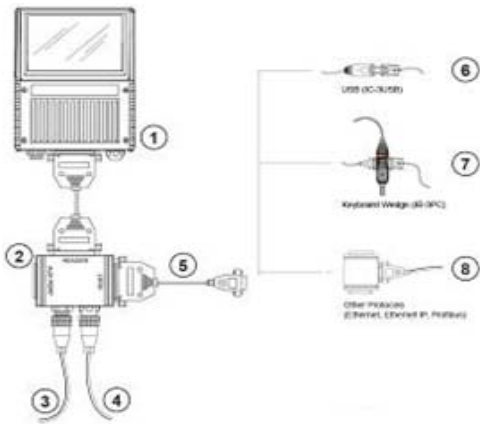

### System Matrix

Product	Reference No.	Description	List Price
1	FIS-0890-0001G	Scanner, Industrial, Long Range	Varies
2	98-000040-02	Cable, Interface & Reader, 6 ft., IB-150	€ 196
3	97-000012-02	Power Supply, 100-240VAC, +24VDC, TRK 3-Pin, U.S./Euro Plug)	€ 154
4	99-000004-01	Package Detector, Standard Diffuse, 120 in. Range, 4-Pin Plug	€ 250
5	61-000034-02	Cable, Communication/Serial, 25-Pin Socket-to-9-Pin Socket, 6 ft.	€ 32
6***	98-000051-01	IC-3USB Interface Kit, USB-to-Serial, 15-Pin	€ 94
7****	FIS-0001-0030G	IB-3PC Keyboard Wedge/Interface Box	€ 166
8	Third Party	Ask your Microscan sales representative which solution is appropriate for your application.	Varies
Mounting Arm Kit	98-000018-01	Mounting Arm/Adapter Kit, MS-890, 6 in.	€ 100
Mounting Plate	98-000046-01	Large Base Plate, 12 in.x12 in.	€ 46
User Documentation, Software	37-000010-01*	Tools Drive, User Documentation, Software	€ 30

\*1 free per order.

\*\*\* Pin Converter is not required for this configuration.

\*\*\*\*Set the IB-3PC to **position 2** in this configuration.

# MICROSCAN.

## MicroHAWK Auto ID Barcode Readers



- World's smallest industrial barcode readers
- Read any code on any surface
- User-friendly barcode reading platform
- Customizable hardware options

To customize your MicroHAWK, please use the MicroHAWK Builder (automated version available on OMS).

Features	ID-20	ID-30	ID-40
1D Omnidirectional Barcodes	•	•	•
1D/2D Barcodes	•	•	•
Damaged Barcodes	•	•	•
Direct Part Mark (DPM)		•	•
Enclosure	IP40	IP54	IP65/67
Ethernet TCP/IP, EtherNet/IP™			•
Ethernet over USB	•	•	
Serial (RS-232)		•	•
USB 2.0 High Speed / HID	•	•	
Power over Ethernet (PoE)			•
Outer Illumination		•	•
Liquid Lens Autofocus		•	•
Standard or High-Density	•	•	•
Color Sensor	•	•	•
High-Speed		•	•
WebLink User Interface	•	•	•

- 3 Sensor Options**
- WVGA 0.3MP
  - SXGA 1.2MP
  - QSXGA 5MP
- 3 Decoder Options**
- 1D Labels Standard
  - 1D/2D Labels Plus
  - 1D/2D Labels+DPM X-Mode
- 2 Speed Options**
- Standard 10 frames/second
  - High Max frame rate of sensor
- 2 Lens Options**
- Standard Density
  - High Density
- 3 Illumination Options**
- Inner
  - Outer Red



**SENSOR:**  
WVGA, SXGA  
or QSXGA



**DECODER:**  
Standard, Plus,  
or X-Mode



**SPEED:**  
Standard or  
High-Speed



**LENS:**  
Standard or  
High-Density



**LIGHTING:**  
Inner/Outer;  
Red or White LEDs

**\*\*Important Pricing Discount Note\*\*** Product discounts are applied based on the Product TYPE code shown in the TYPE column below. Product Type codes are defined as: P = PRODUCT Discount, A = ACCESSORY Discount. A Product Type code modified with L signifies Legacy Status (refer to Legacy section of this catalog). Refer to your Partner Agreement for the actual discount percentage by Product Type.

## ID-20 Series Readers Standard Configurations



IP40 enclosure  
Micro-USB connector (USB only)  
5VDC  
M2 mounting holes

### MicroHAWK ID-20 Series Readers

Part Number	Description	List Price	Type
7211-1102-0000	MICROHAWKID-20WVGASD102MMRED	€ 462	P
7211-1102-0004	MICROHAWKID-20WVGASD 102MMREDHSP	€ 928	P
7211-1102-0005	MICROHAWKID-20WVGASD 102MMREDHSX	€ 1,208	P
7212-1102-0000	MICROHAWKID-20SXGASD102MMRED	€ 742	P
7212-1102-0005	MICROHAWKID-20SXGASD102MMREDHSX	€ 1,488	P
7212-2102-0002	MICROHAWKID-20SXGAHD102MMREDP	€ 836	P

Standard configurations above. Customize ID-20 on the Partner Portal.

Note: Above ID-20 models include 6ft USB 2.0 power cable.

## ID-30 Series Readers Standard Configurations



Compact size, corner cable design  
IP54 enclosure  
DB-15 connector (USB, Serial, I/O)  
5V DC  
Status Indicators  
Added Illumination Option  
M3 Mounting holes

### MicroHAWK ID-30 Series Readers

Part Number	Description	List Price	Type
7311-1000-1005	MICROHAWKID-30WVGASDAUTOFOCUSREDHSX	€ 1,674	P
7311-2000-1005	MICROHAWKID-30WVGAHDAUTOFOCUSREDHSX	€ 1,674	P
7312-1000-1005	MICROHAWKID-30SXGASDAUTOFOCUSREDHSX	€ 1,954	P
7312-2000-1005	MICROHAWKID-30SXGAHDAUTOFOCUSREDHSX	€ 1,954	P
7311-1102-1005	MICROHAWKID-30WVGASD102MMREDHSX	€ 1,488	P
7311-2102-1003	MICROHAWKID-30WVGAGHD102MMREDX	€ 1,116	P
7311-2102-1005	MICROHAWKID-30WVGAGHD102MMREDHSX	€ 1,488	P
7312-1102-1005	MICROHAWKID-30SXGASD102MMREDHSX	€ 1,768	P
7312-2102-1003	MICROHAWKID-30SXGAHD102MMREDX	€ 1,396	P
7312-2102-1005	MICROHAWKID-30SXGAHD102MMREDHSX	€ 1,768	P

Standard configurations above. Customize ID-30 on the Partner Portal.

## ID-40 Series Readers Standard Configurations



Industrial IP65/67 Enclosure  
M12 connectors  
Serial, TCP/IP and Ethernet IP  
Isolated I/O  
5-30VDC  
Side and Bottom M3 Mounting holes

### MicroHAWK ID-40 Series Readers

Part Number	Description	List Price	Type
7411-1000-1005	MICROHAWKID-40WVGASDAUTOFOCUSREDHSX	€ 2,046	P
7411-2000-1005	MICROHAWKID-40WVGAHDAUTOFOCUSREDHSX	€ 2,046	P
7412-1000-1005	MICROHAWKID-40SXGASDAUTOFOCUSREDHSX	€ 2,326	P
7412-2000-1005	MICROHAWKID-40SXGAHDAUTOFOCUSREDHSX	€ 2,326	P
7411-1102-0000	MICROHAWKID-40WVGASD102MM	€ 928	P
7412-1102-0000	MICROHAWKID-40SXGASD102MM	€ 1,208	P
7411-1102-1005	MICROHAWKID-40WVGASD102MMREDHSX	€ 1,768	P
7411-2102-1005	MICROHAWKID-40WVGAGHD102MMREDHSX	€ 1,768	P
7412-1102-1005	MICROHAWKID-40SXGASD102MMREDHSX	€ 2,046	P
7412-2102-1005	MICROHAWKID-40SXGAHD102MMREDHSX	€ 2,046	P

Standard configurations above. Customize ID-40 on the Partner Portal.

# MicroHAWK Smart Part Numbering

To customize your MicroHAWK, please use the Smart Part Numbering table (automated version available on OMS).

18 Standard Configurations; over 1,700 possible options.

## MicroHAWK Smart Part Numbering

Part Number Format: 7ABX-YZZZ-LPPP-CCC  
7 = MicroHAWK

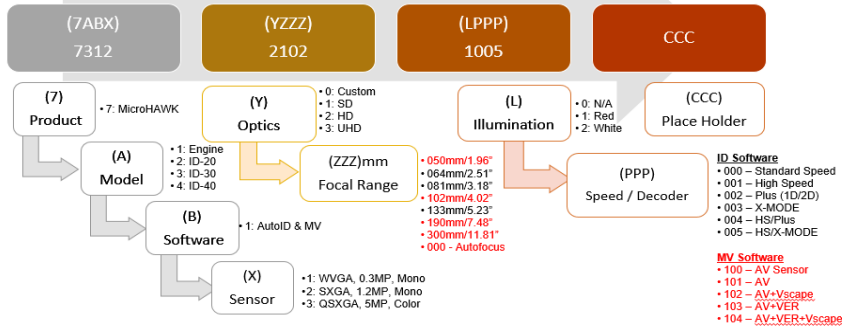

Example Part Number: 7312-2102-1005

Description: ID-30, SXGA, HD, 4" Fixed Focus, Red LEDs, HS, X-Mode

### Notes:

- LED (L): additional LEDs provide extra illumination
  - base level illumination is always included with each model
- Decoder (PPP): basic level decoding is always included with each model
  - Included: 1D (omni-directional)
  - Plus: the standard decoder option includes both 1D and 2D, for printed labels
  - X-Mode: is full decoder package; 1D, 2D, and DPM, and damaged codes
- Field Upgrades: Speed, Decoder and Illumination are field upgradeable via licenses or purchase of illumination kit.

### Part Description Legend

SD= STANDARD DENSITY LENS  
HD= HIGH DENSITY LENS  
RED= RED ILLUM  
WHT= WHITE ILLUM  
HS= HIGH SPEED  
P= PLUS DECODER  
X= X-MODE DECODER

### Sensor Table

	Pixels (HxV), MP	Shutter	Frame Rate (Standard/High)
WVGA	752x480, 0.3MP, Monochrome	Global	10 fps / 60 fps
SXGA	1280x960, 1.2MP, Monochrome	Global	10 fps / 42 fps
QSXGA	2592x1944, 5MP, Color	Rolling	5 fps

Note: Focus Distance (ZZZ) is factory-set and available in 7 standard options.

Note: For Focus Range and Resolution data for each Focus Distance (ZZZ) setting, please refer to Specification Sheet or User Manual.

## MicroHAWK-ID Europe Pricing

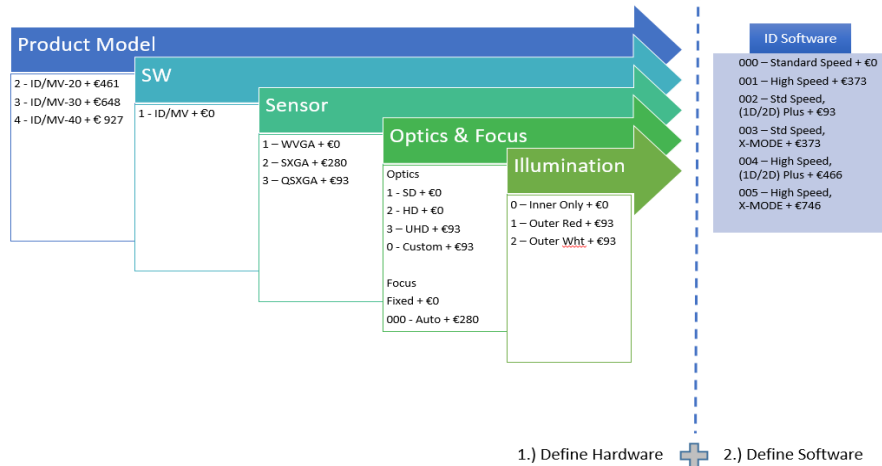

Note: 1.2MP SXGA uses latest sensor technology, with improved sensitivity.

## MicroHAWK Accessories

### MicroHAWK MV License Upgrades

Part Number	Description	List Price	Type
LIC-0701-001	LICENSE AUTOID HIGH SPEED MICROHAWK	€ 374	A
LIC-0701-002	LICENSE AUTOID PLUS DECODER1D/2D MICROHAWK	€ 96	A
LIC-0701-003	LICENSE AUTOID DECODER XMODE MICROHAWK	€ 374	A
LIC-0701-004	LICENSE AUTOID HIGH SPEEDPLUS DECODER 1D/2D MICROHAWK	€ 468	A
LIC-0701-005	LICENSE AUTOID HIGH SPEED X-MODE MICROHAWK	€ 746	A

### MicroHAWK Connectivity Cables

Part Number	Description	List Price	Type
61-9000034-01	ABLE USB A MALE TO MICRO USB B MALE 6FT	€ 20	A
61-9000045-01	CABLE USB A MALE TO MICRO USB B MALE 3 FT	€ 20	A
61-9000037-01	CABLEDB15 to EXT PWR/RS232MICROHAWK-30 (Cable only)	€ 76	A
61-9000038-01	CABLEDB15 to EXT PWR/USBMICROHAWK-30 (Cable only)	€ 76	A
61-9000039-01	CABLEDB15 to EXT PWR/USB/OMICROHAWK-30 (Cable only)	€ 96	A
61-9000043-01	CABLEDB15 to BUS PWR USBMICROHAWK-30	€ 66	A
61-9000102-01	CABLEDB15 TO USB/RS232TRIGGEREDMICROHAWK-30 (CABLE ONLY)	€ 386	A
61-000162-02	QX CordsetCommonM12 12-Pin Socket(Screw-On)-to-M12 12-Pin Plug(Screw-On)1m.	€ 92	A
61-000160-03	QX Cordset Host Ethernet M12 8-Pin Plug (Screw-On)-to-RJ45 1 m.	€ 92	A

Note: ID-40 compatible with QX series Screw-On cables and accessories (with exception to Ultra Lock, quick disconnect cables).

### MicroHAWK Connectivity Cable Kits

Part Number	Description	List Price	Type
98-9000048-01	KIT,CABLE,DB15 to EXT PWR/RS232,W/PWR SUPPLY,MICROHAWK-30 ** INCLUDES PN:61-9000037-01 and PN:97-9000006-01	€ 106	A
98-9000049-01	KIT,CABLE,DB15 to EXT PWR/USB,W/PWR SUPPLY,MICROHAWK-30 ** INCLUDES PN:61-9000038-01 and PN:97-9000006-01	€ 106	A
98-9000050-01	KIT,CABLE,DB15 to EXT PWR/USB,I/O,W/PWR SUPPLY,MICROHAWK-30 ** INCLUDES PN:61-9000039-01 and PN:97-000011-02 ***RECOMMENDED TO PURCHASE SEPARATELY: (Select one of below, not included with Kit) - PN:99-000019-01,PHOTO SENSOR,VIS,NPN,5VDC,LIGHT ON - PN:61-000151-01,FLYING LEAD CABLE	€ 186	A

### MicroHAWK Power Supplies

Part Number	Description	List Price	Type
97-9000006-01	Power Supply 5V for use with 61-9000037-01 & 61-9000038-01 cables	€ 36	A
97-000011-02	Power Supply 100-240VAC +5VDC 2-Pin Plug U.S./Euro Plug	€ 94	A
97-000012-01	Power Supply 100-240VAC +24VDC M12 12-pin Socket	€ 140	A

Note: 97-000011-02 is for ID-30 with cable 61-9000039-01 & kit 98-9000050-01

### MicroHAWK Mounting

Part Number	Description	List Price	Type
98-9000034-01	KITADAPTERMS-4 to MICROHAWK-20	€ 46	A
98-9000041-01	KIT L BRACKET MICROHAWK	€ 46	A
98-9000047-01	KIT1/4-20 CAMERA MOUNTMICROHAWK	€ 26	A
98-9000052-01	KITMOUNTING STANDMS-3MS-4MINIMICROHAWK4	€ 86	A
98-9000053-01	KITMOUNTING STANDMS-3MS-4MINIMICROHAWK3	€ 86	A
98-9000054-01	KITMOUNTINGAPGMS-4MINIMICROHAWK	€ 126	A
98-9000059-01	KIT ADAPTER PLATEMS-4MINI TO MICROHAWK	€ 96	A

### MicroHAWK Accessories

Part Number	Description	List Price	Type
98-9000043-01	KITDIFFUSERMICROHAWK-30/40	€ 76	A
98-9000044-01	KITPOLARIZERMICROHAWK-30/40	€ 126	A
98-9000045-02	KITRED LEDMICROHAWK-30/40	€ 126	A
98-9000046-01	KITWHITE LEDMICROHAWK-30/40	€ 126	A
98-9000051-01	KITWINDOWMICROHAWK-30/40	€ 36	A
98-9000057-01	KIT RA MIRROR MICROHAWK 20	€ 120	A
98-9000058-01	KIT RA MIRROR MICROHAWK 30 & 40	€ 120	A
98-9000064-01	KITISOLATION MOUNTINGM3MICROHAWK ID-30/40	€ 16	A

# Stand Alone Configurations

Note: Daisy-Chain Configurations are currently not available.

## ID-20 Series Imagers

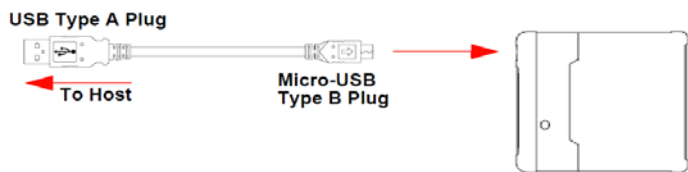

## ID-30 Series Imagers

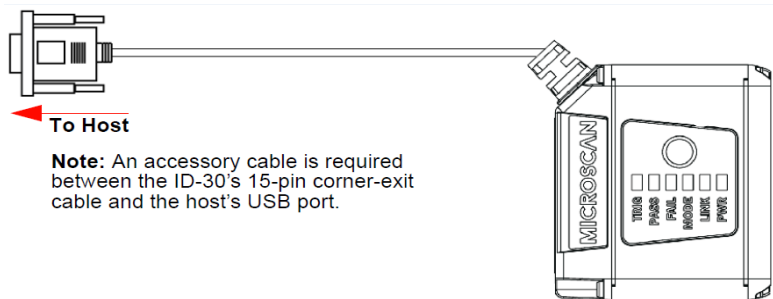

## ID-40 Series Imagers

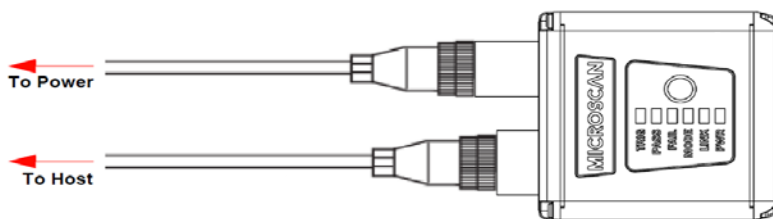

## Tech Reference MicroHAWK ID-20

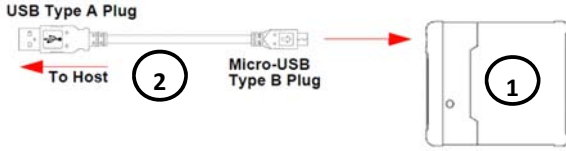

### System Matrix

Product	Reference No. & Description	List Price
1	MicroHAWK ID-20	Varies
2	61-9000034-01, CABLE,USB A to MicroB,6FT,MICROHAWK-20	€ 20
2	61-9000045-01, CABLE,USB A to MicroB,3FT,MICROHAWK-20	€ 20

## Tech Reference MicroHAWK ID-30

### Stand Alone with DB-15 to BUS PWR USB Type A

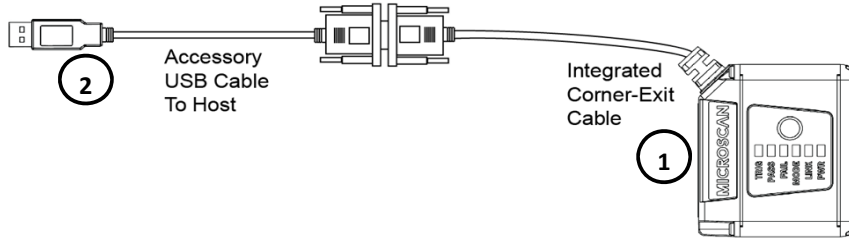

### System Matrix

Product	Reference No. & Description	List Price
1	MicroHAWK ID-30	Varies
2	61-9000043-01, CABLE,DB15 to BUS PWR USB,MICROHAWK-30	€ 66

Note: Bus powered cable delivers reduced illumination... "approximately 30% less brightness"  
 Note: Does not include I/O interface option: trigger cable with photo-sensor, or flying lead cable

### Stand Alone with DB15 to EXT PWR/USB Type A

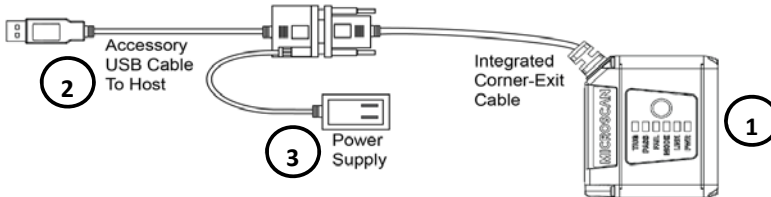

### System Matrix

Product	Reference No. & Description	List Price
1	MicroHAWK ID-30	Varies
2	61-9000038-01, CABLE,DB15 to EXT PWR/USB,MICROHAWK-30	€ 76
3	97-9000006-01, POWER SUPPLY,5V,for PN:61-9000037-01 &	€ 36
	98-9000049-01, KIT,CABLE,DB15 to EXT PWR/USB,W/PWR SUPPLY,MICROHAWK-30	€ 106

Note: Does not include I/O interface option: trigger cable with photo-sensor, or flying lead cable

## Stand Alone with DB15 to EXT PWR/RS232

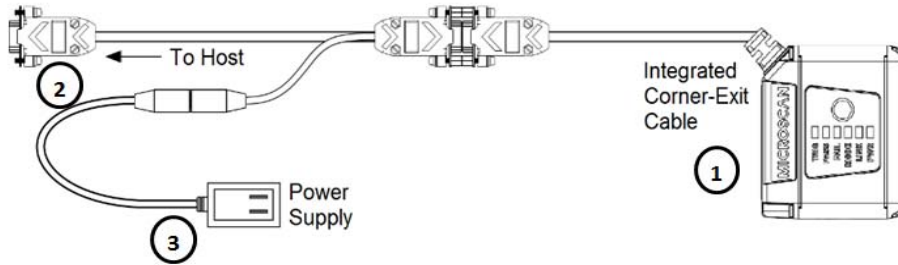

### System Matrix

Product	Reference No. & Description	List Price
1	MicroHAWK ID-30	Varies
2	61-9000037-01, CABLE, DB15 to EXT PWR/RS232, MICROHAWK-30 (Cable only)	€ 76
3	97-9000006-01, POWER SUPPLY, 5V, for PN:61-9000037-01 & PN:61-9000038-01	€ 36
	98-9000048-01, KIT, CABLE, DB15 to EXT PWR/RS232, W/PWR SUPPLY, MICROHAWK-30	€ 106

Note: Does not include I/O interface option: trigger cable with photo-sensor, or flying lead cable  
 Note: RS232 Connector to host is a standard DB-9

## Stand Alone with DB15 to EXT PWR/USB, I/O

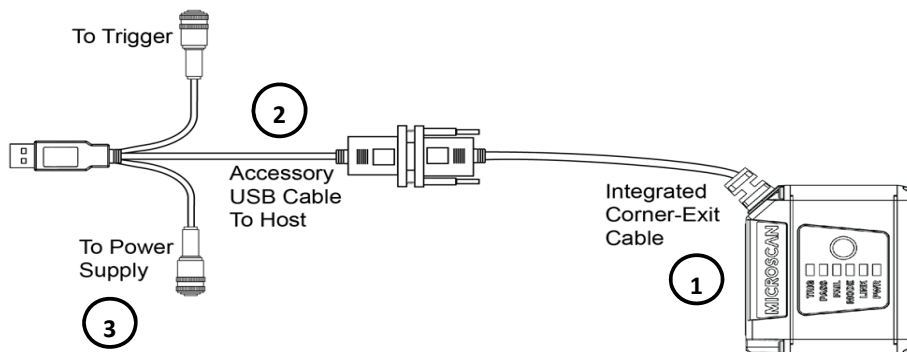

### System Matrix

Product	Reference No. & Description	List Price
1	MicroHAWK ID-30	Varies
2	61-9000039-01, CABLE, DB15 to EXT PWR/USB, I/O,	€ 96
3	97-000011-02, Power Supply, 100-240VAC, +5VDC, 2-Pin Plug, U.S./Euro Plug	€ 94
	98-9000050-01, KIT, CABLE, DB15 to EXT PWR/USB, I/O, W/PWR SUPPLY, MICROHAWK-30	€ 186

# Stand Alone with IB-131 and IC-332

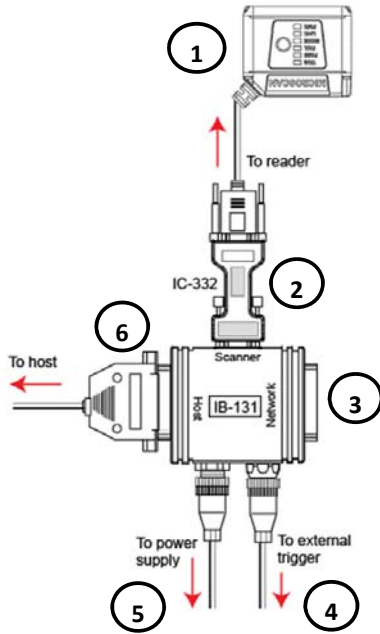

## System Matrix

Product	Reference No. & Description	List Price
1	MicroHAWK ID-30	Varies
2	FIS-0001-0035G, Converter, IC-332, 24V/5V, Opto I/O, for Use with IB-131	€ 184
3	99-000018-01, IB-131 Interface Box	€ 184
4	99-000019-01, Photo Sensor, Visible, NPN, Light On, 5VDC	€ 196
5	97-000012-02, Power Supply, 100-240VAC, +24VDC, TRK 3-Pin, U.S./Euro Plug)	€ 154
6	61-300026-03, Cable, Communication, DB-25 Plug-to-DB-9 Socket, 6 ft.	€ 36

## Tech Reference MicroHAWK ID-40

# Stand Alone with QX-1 Interface

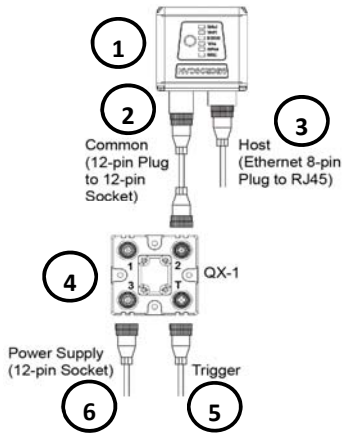

## System Matrix

Product	Reference No. & Description	List Price
1	MicroHAWK ID-40	Varies
2	61-000162-02, QX Cordset, Common, M12 12-Pin Socket(Screw-On)-to-M12 12-Pin Plug(Screw-On), 1m.	€ 92
3	61-000160-03, QX Cordset, Host, Ethernet, M12 8-Pin Plug (Screw-On)-to-RJ45, 1 m.	€ 92
4	98-000103-02, QX-1 Interface Device	€ 196
5	97-000012-01, Power Supply, 100-240VAC, +24VDC, M12 12-Pin Socket	€ 140
6	99-000020-01, QX Photo Sensor, M12 4-Pin Plug, NPN, Dark Off, 2 m.	€ 196
6	99-000020-02, QX Photo Sensor, M12 4-Pin Plug, NPN, Dark, On, 2 m.	€ 196

# MICROSCAN

## MS-2D Scan Engine



MS-2D Scan Engine with Bracket and integrated Decode Board



MS-2D Scan Engine with Tabs and separate Decode Board

Best Sellers
1) FIS-MS2D-0002G
2) FIS-MS2D-0004G

### READ RANGE TABLE

Narrow-Bar	Read Range
<b>STANDARD DENSITY</b>	
<b>1D</b>	
.0050" (.127 mm)	3.7 to 5.0" (94 to 127 mm)
.0075" (.191 mm)	2.2 to 6.5" (56 to 165 mm)
.010" (.254 mm)	1.5 to 8.0" (38 to 203 mm)
.020" (.508 mm)	2.3 to 15.5" (58 to 394 mm)
<b>2D</b>	
.0050" (.127 mm)	3.7 to 4.6" (94 to 117 mm)
.0075" (.191 mm)	1.5 to 6.0" (38 to 152 mm)
.010" (.254 mm)	1.6 to 7.7" (41 to 196 mm)
.020" (.508 mm)	1.6 to 9.4" (41 to 239 mm)

Note: Subject to change. Working ranges are a combination of both wide angle and high density fields

**\*\*Important Pricing Discount Note\*\* Product discounts are applied based on the Product TYPE code shown in the TYPE column below.**

Product Type codes are defined as: P = PRODUCT Discount, A = ACCESSORY Discount.

A Product Type code modified with L signifies Legacy Status (refer to Legacy section of this catalog).

Refer to your Partner Agreement for the actual discount percentage by Product Type.

Note: MS-2D Engines must be ordered in multiples of 10pc. List Price 1pc each.

### MS-2D Scan Engine

Part Number	Description	List Price	Type
FIS-MS2D-0001G	MS-2D Engine USB Tabs 12 in. Ribbon Standard Focus	€ 280	A
FIS-MS2D-0002G	MS-2D Engine USB Bracket 12 in. Ribbon Standard Focus	€ 296	A
FIS-MS2D-0003G	MS-2D Engine Serial Tabs 12 in. Ribbon Standard Focus	€ 280	A
FIS-MS2D-0004G	MS-2D Engine Serial Bracket 12 in. Ribbon Standard Focus	€ 296	A

Note: MS-2D Engines must be ordered in multiples of 10 units.

Note: Ribbon cables must be ordered in multiples of 10pc. List Price 1pc each.

### Accessories

Part Number	Description	List Price	Type
61-000209-01	MS-2D Ribbon Cable Engine-to-Host 2 in.	€ 10	A
61-000209-02	MS-2D Ribbon Cable Engine-to-Host 6 in.	€ 12	A
61-000209-03	MS-2D Ribbon Cable Engine-to-Host 12 in.	€ 14	A
98-000224-01	MS-2D Demo Kit USB	€ 600	A
98-000224-02	MS-2D Demo Kit Serial	€ 600	A

Note: MS-2D Ribbon Cables must be ordered in multiples of 10 units.

### Software / Manuals

Part Number	Description	List Price	Type
37-000010-01*	Tools Drive, User Documentation, Software	€ 30	A

\* One free per order.

# MICROSCAN

MINI Hawk Series of Imagers



## High Resolution (HR) Specification

Narrow-bar-width		Field of View (maximum)	Read Range (with autofocus)
1D	2D		
<b>Ultra High Density</b>			
.0033" (.08 mm)	.005" (.13 mm)	2.2" (56 mm)	2.0 to 4.4" (51 mm to 112 mm)
.0075" (0.19 mm)	.010" (.25 mm)	3.6" (91 mm)	1.9 to 6.7" (48 mm to 170 mm)
.015" (0.38 mm)	.020" (.51 mm)	4.0" (102 mm)	1.9 to 7.7" (48 mm to 196 mm)
<b>High Density</b>			
.005" (0.13 mm)	.0075" (.19 mm)	3.1" (79 mm)	1.5 to 6.0" (38 mm to 152 mm)
.0075" (0.19 mm)	.010" (.25 mm)	4.2" (107 mm)	1.2 to 8.0" (30 mm to 203 mm)
.015" (0.38 mm)	.020" (.51 mm)	5.6" (142 mm)	0.9 to 10.5" (23 mm to 267 mm)
<b>Standard Density</b>			
.005" (0.13 mm)	.0075" (.19 mm)	3.2" (81 mm)	1.8 to 3.5" (46 mm to 89 mm)
.0075" (0.19 mm)	.010" (.25 mm)	4.2" (107 mm)	1.6 to 5.0" (41 mm to 127 mm)
.010" (0.25 mm)	.015" (.38 mm)	6.8" (173 mm)	1.4 to 7.5" (36 mm to 191 mm)
.020" (0.51 mm)	.030" (.76 mm)	9.5" (241 mm)	1.0 to 11.0" (25 mm to 279 mm)

Best Sellers
1) FIS-6300-4009G
2) FIS-6300-4008G
3) FIS-6300-5006G
4) FIS-6300-5005G

## High speed (HS) specification

Narrow-bar-width		Field of View (maximum)	Read Range (with autofocus)
1D	2D		
<b>Ultra-High Density</b>			
.0033" (.08 mm)	.005" (.13 mm)	1.6" (40 mm)	1.9 to 4.4" (47 mm to 110 mm)
.0075" (.19 mm)	.010" (.25 mm)	2.5" (64 mm)	1.7 to 6.7" (42 mm to 170 mm)
.015" (.38 mm)	.020" (.51 mm)	2.9" (74 mm)	1.5 to 8.0" (38 mm to 203 mm)
<b>Standard Density</b>			
.005" (.13 mm)	.0075" (.19 mm)	2.8" (72 mm)	1.6 to 4.4" (41 mm to 112 mm)
.0075" (.19 mm)	.010" (.25 mm)	3.8" (97 mm)	1.5 to 6.2" (38 mm to 157 mm)
.010" (.25 mm)	.015" (.38 mm)	4.7" (118 mm)	1.4 to 7.6" (36 mm to 193 mm)
.020" (.51 mm)	.030" (.76 mm)	6.2" (158 mm)	1.3 to 10.0" (33 mm to 254 mm)

Listed above is the read range chart for MINI Hawk (Xi) Imagers. See MINI Hawk 3MP section for additional specifications  
**\*\*Important Pricing Discount Note\*\* Product discounts are applied based on the Product TYPE code shown in the TYPE column below.**  
 Product Type codes are defined as: P = PRODUCT Discount, A = ACCESSORY Discount.  
 A Product Type code modified with L signifies Legacy Status (refer to Legacy section of this catalog).  
 Refer to your Partner Agreement for the actual discount percentage by Product Type.

### MINI Hawk ESD Safe



Performance specifications match MINI Hawk High Resolution.

#### MINI Hawk ESD Safe Imagers

Part Number	Description	List Price	Type
FIS-6300-1011G	MINI Hawk Imager SD ESD Safe RS-232/RS-422/RS-485 5VDC	€ 2,136	P
FIS-6300-1012G	MINI Hawk Imager HD ESD Safe RS-232/RS-422/RS-485 5VDC	€ 2,136	P
FIS-6300-1013G	MINI Hawk Imager Ultra HD ESD Safe RS-232/RS-422/RS-485 5VDC	€ 2,136	P

# MICROSCAN.

## MINI Hawk 3MP



### 3MP Specification

Narrow-bar-width		Field of View (maximum)	Read Range (using autofocus)
1D	2D		
<b>Micro Density</b>			
.0028" (.07mm)	.0033" (.08 mm)	1.2" (30.4 mm)	1.9 to 2.0" (48.3 mm to 50.8 mm)
.0033" (.08 mm)	.005" (.13 mm)	4" (101.6 mm)	1.9 to 5.1" (48.3 mm to 129.5 mm)
.0075" (.19 mm)	.010" (.25 mm)	4.5" (114.3 mm)	1.7 to 5.6" (43.2 mm to 142.2 mm)
.015" (.38 mm)	.020" (.51 mm)	5.0" (127 mm)	1.7 to 6" (43.2 mm to 152.4 mm)
<b>Standard Density</b>			
.0033" (.08 mm)	.005" (.13 mm)	3.2" (81.3 mm)	1.9 to 3" (48 mm to 76.2 mm)
.005" (.13 mm)	.0075" (.19 mm)	5.0" (127 mm)	1.8 to 4.8" (46 mm to 121.9 mm)
.0075" (.19 mm)	.010" (.25 mm)	6.2" (157.5 mm)	1.6 to 6.5" (41 mm to 165.1 mm)
.010" (.25 mm)	.015" (.38 mm)	8.5" (215.9 mm)	1.4 to 8.5" (36 mm to 215.9 mm)
.020" (.51 mm)	.030" (.76 mm)	9.5" (241 mm)	1.0 to 10" (25 mm to 254 mm)

### MINI Hawk 3MP Imagers

Part Number	Description	List Price	Type
FIS-6300-2013G	MINI Hawk Imager 3 Megapixel Imager Micro Density Serial 5VDC	€ 2,788	P
FIS-6300-2014G	MINI Hawk Imager 3 Megapixel Imager SD Serial 5VDC	€ 2,788	P
FIS-6300-2015G*	MINI Hawk Imager 3 Megapixel Imager Micro Density USB & I/O 5VDC	€ 2,880	P
FIS-6300-2016G*	MINI Hawk Imager 3 Megapixel Imager SD USB & I/O 5VDC	€ 2,880	P

\* Cable terminated with USB type A connector. Includes required power supply.

## MINI Hawk High Resolution



### MINI Hawk High Resolution

Part Number	Description	List Price	Type
FIS-6300-4007G	MINI Hawk Imager High Resolution SD Serial 5VDC	€ 1,856	P
FIS-6300-4008G	MINI Hawk Imager High Resolution HD Serial 5VDC	€ 1,856	P
FIS-6300-4009G	MINI Hawk Imager High Resolution Ultra HD Serial 5VDC	€ 1,856	P
FIS-6300-4010G*	MINI Hawk Imager High Resolution SD USB & I/O 5VDC	€ 1,950	P
FIS-6300-4011G*	MINI Hawk Imager High Resolution HD USB & I/O 5VDC	€ 1,950	P
FIS-6300-4012G*	MINI Hawk Imager High Resolution Ultra HD USB & I/O 5VDC	€ 1,950	P

\* Cable terminated with USB type A connector. Includes required power supply.

## MINI Hawk High Speed



### MINI Hawk High Speed Imagers

Part Number	Description	List Price	Type
FIS-6300-5005G	MINI Hawk Imager High Speed SD Serial 5VDC	€ 1,856	P
FIS-6300-5006G	MINI Hawk Imager High Speed Ultra HD Serial 5VDC	€ 1,856	P
FIS-6300-5007G*	MINI Hawk Imager High Speed SD USB & I/O 5VDC	€ 1,950	P
FIS-6300-5008G*	MINI Hawk Imager High Speed Ultra HD USB & I/O 5VDC	€ 1,950	P

\* Cable terminated with USB type A connector. Includes required power supply.

## MINI Hawk Accessories

### Accessories

Part Number	Description	List Price	Type
FIS-0210-0001G	MS-Connect 210 Connectivity Box with Display	€ 880	A
FIS-0210-0002G	MS-Connect 210 Connectivity Box	€ 600	A
FIS-0210-0003G	MS-Connect 210 Connectivity Box with Display & Ethernet	€ 1,000	A
FIS-0210-0004G	MS-Connect 210 Connectivity Box with Ethernet	€ 880	A
98-000013-04	Relay Module 120VAC 3 Amp Output Series 70 Type SM for MS-Connect 210 + MS-890	€ 56	A
98-000013-05	Relay Module 240VAC 3 Amp Output Series 70 Type SM for MS-Connect 210 + MS-890	€ 56	A
98-000013-06	Relay Module 24VDC 3 Amp Output Series 70 Type SM for MS-Connect 210 MS-890	€ 56	A
61-000127-02	Cable MS-2-to-MS-Connect 210 6 ft.	€ 112	A
FIS-0001-0035G	Converter IC-332 24V/5V Opto I/O for Use with IB-131	€ 184	A
99-000018-01	IB-131 Interface Box	€ 184	A
61-300026-03	Cable Communication DB-25 Plug-to-DB-9 Socket 6 ft.	€ 36	A
61-100029-03	Cable Daisy Chain IB-131	€ 36	A
61-000011-02	Extension Cable Reader-to-IB-131 (MS-2 MS-3 MS-4 MS-9 MS-710 MS-820 MINI)	€ 36	A
61-000151-01	Cable MINI USB I/O Breakout Flying Leads 3 ft.	€ 36	A
98-000098-01	Kit MINI Diffuser	€ 56	A
98-000086-02*	Demo Kit MINI Hawk	€ 656	A

\* This Demo Kit does not contain a reader and is discounted 25%. The separately purchased reader is discounted 60%.

### Power Supply

Part Number	Description	List Price	Type
97-000011-02	Power Supply 100-240VAC +5VDC 2-Pin Plug U.S./Euro Plug	€ 94	A
97-000012-01	Power Supply 100-240VAC +24VDC M12 12-pin Socket	€ 140	A
97-000012-02	Power Supply 100-240VAC +24VDC TRK 3-Pin U.S./Euro Plug)	€ 154	A

### Mounting and Connectors

Part Number	Description	List Price	Type
98-000048-01	Kit Mounting Arm/Adapter 4 in. for MS-2 MS-3	€ 78	A
98-000054-01	Kit Mounting Stand Base Plate	€ 36	A
98-000053-01	Mounting Arm Extension Kit 4 in. for MS-3 MS-4 MINI	€ 40	A
98-000053-02	Mounting Arm Extension Kit 3 in. for MS-2 MS-3 MS-4 MINI	€ 40	A
98-000060-01	Kit Bracket Side Mount MS-2 MS-3 MINI	€ 24	A
98-000059-01	Kit Bracket Angle Mount MS-2 MS-3 MINI	€ 24	A
98-000057-02	Kit Bracket Through-Hole Mount MS-2 MS-3 MINI	€ 24	A
98-000088-01	Kit Right Angle Mirror MS-4/MINI Hawk/Vision MINI	€ 56	A
20-610024-01	Trigger Connector 4-Pin Plug (Screw Terminal Field-Wireable) (Self-Wiring)	€ 33	A
20-610020-01	Power Conn. 3-Pin Socket (Screw Term. Field-Wireable for Custom IB-131 Wiring)	€ 33	A
99-000055-01	Bracket Smart Series DOAL-50 mm-to-Vision MINI & MINI Hawk	€ 256	A
99-000057-01	Bracket Smart Series DOAL-75 mm-to-Vision MINI & MINI Hawk	€ 256	A
99-000059-01	Bracket Smart Series DOAL-100 mm-to-Vision MINI & MINI Hawk	€ 256	A
99-000053-01	Bracket Smart Series Ring-60/70 mm-to-Vision MINI & MINI Hawk	€ 138	A
99-000054-01	Bracket Smart Series Ring-100 mm-to-Vision MINI & MINI Hawk	€ 138	A

### Package Detector/Sensor

Part Number	Description	List Price	Type
99-000017-01	Photo Sensor Visible NPN Dark ON	€ 196	A
99-000017-02	Photo Sensor Visible NPN Light ON	€ 196	A
99-000019-01	Photo Sensor Visible NPN Light On 5VDC	€ 196	A

### Software/Manuals

Part Number	Description	List Price	Type
37-000010-01*	Tools Drive, User Documentation, Software	€ 30	A

\*One free per order

# MICROSCAN.

## Tech Reference *MINI Hawk*

### USB

This is the basic setup for a single USB MINI Hawk.

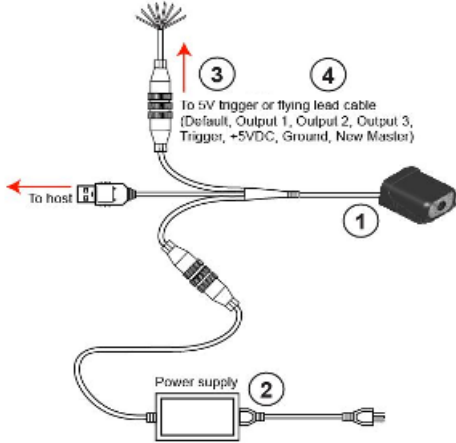

### System Matrix

Product	Reference No.	Description	List Price
1	FIS-6300-XXXXG	MINI Imager, USB	Varies
2	97-000011-02	Power Supply, 100-240VAC, +5VDC, 2-Pin Plug, U.S./Euro Plug	€ 94
3	99-000019-01	Photo Sensor, Visible, NPN, Light On, 5VDC	€ 196
4	61-000151-01	Cable, MINI USB, I/O Breakout, Flying Leads, 3 ft.	€ 36
Mounting Arm/Adapter Kit	98-000048-01	Kit, Mounting Arm/Adapter, 4 in., for MS-2, MS-3	€ 78
Mounting Plate	98-000054-01	Kit, Mounting Stand Base Plate	€ 36
User Documentation, Software	37-000010-01**	Tools Drive, User Documentation, Software	€ 30
Replacement Power Supply	97-000011-02*	Power Supply, 100-240VAC, +5VDC, 2-Pin Plug, U.S./Euro Plug	€ 94

\*Required power supply included with each reader.

\*\* 1 free per order.

#### Note:

**Additional MINI Hawk Tech References are equal to MS-3 Laser with the exception of USB**

**Visit the MS-3 Laser section for configuration references**

# MICROSCAN.

## Tech Reference *MINI Hawk Xi*

### Stand Alone

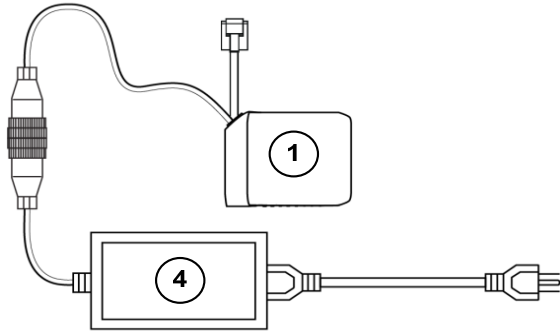

### Stand Alone with QX-1

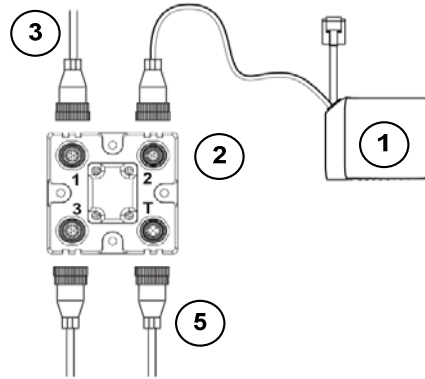

### Stand Alone with Flying Leads

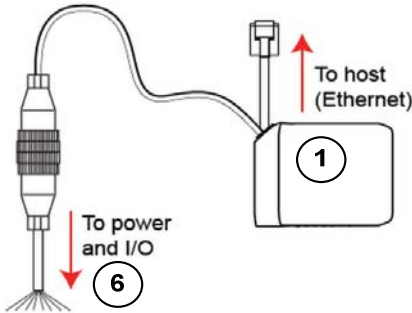

#### Wire Colors

1	WHITE
2	BROWN
3	GREEN
4	YELLOW
5	GRAY
6	PINK
7	BLUE
8	RED
9	BLACK
10	VIOLET
11	GRAY STRIPED PINK
12	RED STRIPED BLUE

#### System Matrix

Product	Reference No.	Description	List Price
1	FIS-6310-1XX0G	MINI Hawk Xi	Varies
2	98-000103-02	QX-1 Interface Device	€ 196
3	61-000153-01	QX Cordset,Host,Serial,M12 12 Pin Socket (Ultralock) to DB9 Socket,1M	€ 53
4	97-000012-01	Power Supply, 100-240VAC, +24VDC, M12 12-Pin Socket	€ 140
5	99-000020-02	QX Photo Sensor, M12 4-Pin Plug, NPN, Dark On, 2 m.	€ 196
6	61-000167-02	QX Cordset, M12 12-Pin Socket (Screw-On)-to-Flying Leads, 3 m.	€ 96
Mounting Arm/Adapter Kit	98-000048-01	Kit, Mounting Arm/Adapter, 4 in., for MS-2, MS-3	€ 78
Mounting Plate	98-000054-01	Kit, Mounting Stand Base Plate	€ 36
User Documentation, Software	37-000010-01**	Tools Drive, User Documentation, Software	€ 30
Replacement Power Supply	97-000012-01*	Power Supply, 100-240VAC, +24VDC, M12 12-Pin Socket	€ 140

\*Required power supply included with each reader.

\*\* 1 free per order.

# MICROSCAN.

**QX Hawk High Performance, Flexible Industrial Imager for Auto ID**



**IP65 INDUSTRIAL CERTIFIED**

**Compact Size  
Fast and Powerful  
X-Mode Algorithms  
Liquid Lens Imaging System  
QX Platform  
Integrated Ethernet  
IP65/67**

**INTEGRATED OPTICS MODEL: CMOS MODULAR ZOOM OPTICS**

Inches (mm)

12°	Narrow-bar-width		Read Range (using autofocus)	Field of View		Depth of Field	
	1D	2D		Inside Edge	Outside Edge	Inside Edge	Outside Edge
	0.0033 (0.08)	0.005 (0.13)	3.4 to 6 (86 to 152)	0.9 (23)	1.42 (36)	0.2 (5)	0.4 (10)
	0.0075 (0.19)	0.010 (0.25)	3.3 to 12.2 (83 to 310)	0.9 (23)	2.62 (66)	0.4 (10)	1.5 (38)
	0.0150 (0.38)	0.020 (0.51)	3.3 to 13 (82 to 330)	0.9 (23)	2.77 (70)	0.5 (13)	3.5 (89)
	0.0350 (0.89)	0.050 (1.27)	4 to 16 (101 to 406)	1.05 (26)	3.34 (85)	0.7 (18)	6.5 (165)

15°	Narrow-bar-width		Read Range (using autofocus)	Field of View		Depth of Field	
	1D	2D		At Inside Edge	At Outside Edge	Inside Edge	Outside Edge
	0.0033 (0.08)	0.005 (0.13)	1.9 to 5 (48 to 127)	0.75 (19)	1.53 (39)	0.3 (6)	0.4 (10)
	0.0075 (0.19)	0.010 (0.25)	1.8 to 8 (46 to 203)	0.83 (21)	3.5 (89)	0.4 (10)	1.8 (46)
	0.0150 (0.38)	0.020 (0.51)	1.75 to 9 (44 to 229)	0.72 (18)	2.52 (64)	0.5 (13)	3 (76)
	0.0350 (0.89)	0.050 (1.27)	3 to 10.8 (76 to 274)	1.03 (26)	2.96 (75)	0.6 (15)	4 (101)

30°	Narrow-bar-width		Read Range (using autofocus)	Field of View		Depth of Field	
	1D	2D		Inside Edge	Outside Edge	Inside Edge	Outside Edge
	0.0033 (0.08)	0.005 (0.13)	1 to 3 (25 to 76)	0.83 (21)	1.8 (46)	0.4 (10)	0.8 (20)
	0.0075 (0.19)	0.010 (0.25)	1 to 6.5 (25 to 165)	0.83 (21)	3.5 (89)	0.5 (13)	1.8 (46)
	0.0150 (0.38)	0.020 (0.51)	1 to 16 (25 to 406)	0.83 (21)	8.3 (211)	2 (51)	8.5 (216)
	0.0350 (0.89)	0.050 (1.27)	2 to 32 (51 to 813)	1.3 (33)	16.4 (417)	3 (76)	21.5 (546)

45°	Narrow-bar-width		Read Range (using autofocus)	Field of View		Depth of Field	
	1D	2D		Inside Edge	Outside Edge	Inside Edge	Outside Edge
	0.0075 (0.19)	0.010 (0.25)	1 to 5 (25 to 127)	1.3 (33)	4.1 (104)	1.5 (38)	2 (51)
	0.0150 (0.38)	0.020 (0.51)	1 to 9.5 (25 to 241)	1.3 (33)	7.5 (191)	2 (51)	6 (152)
	0.0350 (0.89)	0.050 (1.27)	1 to 23.5 (25 to 597)	1.3 (33)	18.3 (465)	3.8 (97)	19 (483)

NOTE: Read ranges are for specific element sizes as listed in the tables.

**INTEGRATED OPTICS MODEL: CCD MODULAR ZOOM OPTICS**

Inches (mm)

12°	Narrow-bar-width		Read Range (using autofocus)	Field of View		Depth of Field	
	1D	2D		Inside Edge	Outside Edge	Inside Edge	Outside Edge
	0.002 (0.05)	0.0033 (0.08)	3.5 to 7 (87 to 178)	0.9 (23)	1.62 (41)	0.1 (3)	0.3 (8)
	0.005 (0.13)	0.0075 (0.19)	3.4 to 12 (86 to 304)	0.9 (23)	2.62 (66)	0.2 (5)	1 (25)
	0.010 (0.25)	0.0150 (0.38)	3.3 to 13 (83 to 330)	0.9 (23)	2.77 (70)	0.4 (10)	2.5 (64)
	0.020 (0.51)	0.0300 (0.76)	4 to 14 (101 to 355)	1.03 (26)	2.96 (75)	0.6 (15)	5 (127)

15°	Narrow-bar-width		Read Range (using autofocus)	Field of View		Depth of Field	
	1D	2D		At Inside Edge	At Outside Edge	Inside Edge	Outside Edge
	0.002 (0.05)	0.0033 (0.08)	2 to 5 (51 to 127)	0.78 (20)	1.53 (39)	0.2 (5)	0.4 (10)
	0.005 (0.13)	0.0075 (0.19)	1.9 to 8.3 (48 to 210)	0.75 (19)	2.35 (60)	0.3 (8)	1 (25)
	0.010 (0.25)	0.0150 (0.38)	1.9 to 9.5 (47 to 241)	0.75 (19)	2.65 (67)	0.5 (13)	3 (76)
	0.020 (0.51)	0.0300 (0.76)	3 to 10.3 (76 to 261)	1.03 (26)	2.84 (72)	0.6 (15)	4.5 (114)

30°	Narrow-bar-width		Read Range (using autofocus)	Field of View		Depth of Field	
	1D	2D		Inside Edge	Outside Edge	Inside Edge	Outside Edge
	0.002 (0.05)	0.0033 (0.08)	1 to 3 (25 to 76)	0.83 (21)	1.8 (46)	0.4 (10)	0.8 (20)
	0.005 (0.13)	0.0075 (0.19)	1 to 6.5 (25 to 165)	0.83 (21)	3.5 (89)	0.5 (13)	1.8 (46)
	0.010 (0.25)	0.0150 (0.38)	1 to 16 (25 to 406)	0.83 (21)	8.3 (211)	2 (51)	8.5 (216)
	0.020 (0.51)	0.0300 (0.76)	2 to 32 (51 to 813)	1.3 (33)	16.4 (417)	3 (76)	21.5 (546)

45°	Narrow-bar-width		Read Range (using autofocus)	Field of View		Depth of Field	
	1D	2D		Inside Edge	Outside Edge	Inside Edge	Outside Edge
	0.005 (0.13)	0.0075 (0.19)	1 to 5 (25 to 127)	1.3 (33)	4.1 (104)	1.5 (38)	2 (51)
	0.010 (0.25)	0.0150 (0.38)	1 to 9.5 (25 to 241)	1.3 (33)	7.5 (191)	2 (51)	6 (152)
	0.020 (0.51)	0.0300 (0.76)	1 to 23.5 (25 to 597)	1.3 (33)	18.3 (465)	3.8 (97)	19 (483)

NOTE: Read ranges are for specific element sizes as listed in the tables.

**\*\*Important Pricing Discount Note\*\*** Product discounts are applied based on the Product TYPE code shown in the TYPE column below.

Product Type codes are defined as: P = PRODUCT Discount, A = ACCESSORY Discount.

A Product Type code modified with L signifies Legacy Status (refer to Legacy section of this catalog).

Refer to your Partner Agreement for the actual discount percentage by Product Type.

**QX Hawk CMOS Readers**

Part Number	Description	List Price	Type
FIS-6801-0410G	QX Hawk Imager WVGA CMOS 12° Lens RS-232/RS-422/RS-485	€ 2,600	P
FIS-6801-1410G	QX Hawk Imager WVGA CMOS 12° Lens RS-232/Ethernet	€ 2,600	P
FIS-6801-0510G	QX Hawk Imager WVGA CMOS 15° Lens RS-232/RS-422/RS-485	€ 2,600	P
FIS-6801-1510G	QX Hawk Imager WVGA CMOS 15° Lens RS-232/Ethernet	€ 2,600	P
FIS-6801-0210G	QX Hawk Imager WVGA CMOS 30° Lens RS-232/RS-422/RS-485	€ 2,600	P
FIS-6801-1210G	QX Hawk Imager WVGA CMOS 30° Lens RS-232/Ethernet	€ 2,600	P
FIS-6801-0310G	QX Hawk Imager WVGA CMOS 45° Lens RS-232/RS-422/RS-485	€ 2,600	P
FIS-6801-1310G	QX Hawk Imager WVGA CMOS 45° Lens RS-232/Ethernet	€ 2,600	P
FIS-6801-0010G	QX Hawk Imager WVGA CMOS C-Mount Lens RS-232/RS-422/RS-485	€ 2,508	P
FIS-6801-1010G	QX Hawk Imager WVGA CMOS C-Mount Lens RS-232/Ethernet	€ 2,508	P

## QX Hawk CCD Readers

Part Number	Description	List Price	Type
FIS-6801-0400G	QX Hawk Imager SXGA CCD 12° Lens RS-232/RS-422/RS-485	€ 2,880	P
FIS-6801-1400G	QX Hawk Imager SXGA CCD 12° Lens RS-232/Ethernet	€ 2,880	P
FIS-6801-0500G	QX Hawk Imager SXGA CCD 15° Lens RS-232/RS-422/RS-485	€ 2,880	P
FIS-6801-1500G	QX Hawk Imager SXGA CCD 15° Lens RS-232/Ethernet	€ 2,880	P
FIS-6801-0200G	QX Hawk Imager SXGA CCD 30° Lens RS-232/RS-422/RS-485	€ 2,880	P
FIS-6801-1200G	QX-Hawk industrial imager SXGA CCD30° lens RS232/Ethernet	€ 2,880	P
FIS-6801-0300G	QX Hawk Imager SXGA CCD 45° Lens RS-232/RS-422/RS-485	€ 2,880	P
FIS-6801-1300G	QX Hawk SXGA CCD 45° Lens RS-232/Ethernet	€ 2,880	P
FIS-6801-0000G	QX Hawk Imager SXGA CCD C-Mount Lens RS-232/RS-422/RS-485	€ 2,788	P
FIS-6801-1000G	QX Hawk Imager SXGA CCD C-Mount Lens RS-232/Ethernet	€ 2,788	P

Note CMOS (WVGA) - 752 x 480 pixels, CCD (SXGA) 1280 x 960 pixels

## QX Hawk Accessories

Part Number	Description	List Price	Type
98-000143-01	Kit Adapter Plate QX Hawk/Vision HAWK	€ 56	A
98-000144-01	Right Angle Mirror Kit QX Hawk/Vision HAWK	€ 86	A
98-000146-01	Kit Window Replacement QX Hawk/Vision HAWK	€ 36	A
98-000147-04	12° Lens QX Hawk	€ 136	A
98-000147-01	15° Lens QX Hawk	€ 136	A
98-000147-02	30° Lens QX Hawk	€ 136	A
98-000147-03	45° Lens QX Hawk	€ 136	A
98-000205-01	Kit Glass Window with IR Coating QX Hawk/Vision HAWK	€ 136	A
98-000206-01	Kit Glass Window QX Hawk/Vision HAWK	€ 72	A
98-000206-02	Kit Lexan Window with Metal Bezel QX Hawk/Vision HAWK	€ 72	A
98-000149-01*	Demo Kit QX Hawk	€ 596	A
98-000262-01	Kit White LED Illumination QX Hawk/Vision HAWK	€ 352	A
98-000262-02	Kit Blue LED Illumination QX Hawk/Vision HAWK	€ 352	A

\* This Demo Kit does not contain a reader and is discounted 25%. The separately purchased reader is discounted 60%.

## QX-1 and Cordsets

Part Number	Description	List Price	Type
98-000103-02	QX-1 Interface Device	€ 196	A
61-000148-01	QX CordsetCommonM12 12-Pin Socket(Ult.Lock)-to-M12 12-Pin Plug(Ult.Lock)3m.	€ 80	A
61-000148-02	QX CordsetCommonM12 12-Pin Socket(Screw-On)-to-M12 12-Pin Plug(Screw-On)3m.	€ 96	A
61-000162-02	QX CordsetCommonM12 12-Pin Socket(Screw-On)-to-M12 12-Pin Plug(Screw-On)1m.	€ 92	A
61-000153-02	QX Cordset Host Serial M12 12-Pin Socket (Screw-On)-to-DB-9 Socket 1 m.	€ 92	A
61-000164-02	QX Cordset Host Serial M12 12-Pin Socket (Screw-On)-to-DB-9 Socket 3 m.	€ 96	A
61-000152-02	QX Cordset Host Serial M12 12-Pin Plug (Screw-On)-to-DB-9 Socket 1 m.	€ 92	A
61-000165-02	QX Cordset Host Serial M12 12-Pin Plug (Screw-On)-to-DB-9 Socket 3 m.	€ 96	A
61-000163-03	QX Cordset Host Ethernet M12 8-Pin Plug (Screw-On)-to-RJ45 3 m.	€ 96	A
61-000160-01	QX Cordset Host Ethernet M12 8-Pin Plug (Ult.Lock)-to-RJ45 1 m.	€ 102	A
61-000160-03	QX Cordset Host Ethernet M12 8-Pin Plug (Screw-On)-to-RJ45 1 m.	€ 92	A
61-000172-02	QX CordsetM12 12-Pin Plug-to-M12 12-Pin Socket-to-DB-25 Plug Turck Connectors	€ 286	A
61-000158-03	QX Cordset M12 12-Pin Plug & M12 12-Pin Socket-to-MS-Connect 210 (RS-232) 2 m.	€ 374	A
61-000158-04	QX Cordset M12 12-Pin Plug & M12 12-Pin Socket-to-MS-Connect 210 (RS-422) 2 m.	€ 250	A
61-000166-02	QX Cordset M12 12-Pin Plug (Screw-On)-to-Flying Leads 3 m.	€ 96	A
61-000167-02	QX Cordset M12 12-Pin Socket (Screw-On)-to-Flying Leads 3 m.	€ 96	A
98-000013-04	Relay Module120VAC3 Amp OutputSeries 70Type SMfor MS-Connect 210 + MS-890	€ 56	A
98-000013-05	Relay Module240VAC3 Amp OutputSeries 70Type SM for MS-Connect 210 + MS-890	€ 56	A
98-000013-06	Relay Module 24VDC 3 Amp Output Series 70 Type SM for MS-Connect 210MS-890	€ 56	A
61-000207-01	QX Cordset Smart Series Light-to-QX-1 Continuous ON/OFF	€ 232	A
61-000204-01	QX Cordset Smart Series Light-to-QX-1 Continuous Power	€ 206	A

## Power Supplies

Part Number	Description	List Price	Type
97-000012-01	Power Supply 100-240VAC +24VDC M12 12-pin Socket	€ 140	A
97-000012-04	QX Power Supply 24V M12 12 pin Plug USA /Euro Plug	€ 136	A

## Package Detector/Sensor

Part Number	Description	List Price	Type
99-000020-02	QX Photo Sensor M12 4-Pin Plug NPN Dark On 2 m.	€ 196	A
99-000020-01	QX Photo Sensor M12 4-Pin Plug NPN Dark Off 2 m.	€ 196	A

## Mounting and Connectors

Part Number	Description	List Price	Type
20-610024-01	Trigger Connector 4-Pin Plug (Screw Terminal Field-Wireable) (Self-Wiring)	€ 33	A
98-000037-01	Mounting Arm Extension Kit 6 in. All Readers	€ 62	A
98-000054-01	Kit Mounting Stand Base Plate	€ 36	A
98-000016-01	Kit 6 in. Mounting Arm/Adapter MS-820 QX-830 QX-870	€ 120	A
99-000056-01	Bracket Smart Series DOAL-50 mm-to-Vision HAWK & QX Hawk	€ 256	A
99-000058-01	Bracket Smart Series DOAL-75 mm-to-Vision HAWK & QX Hawk	€ 256	A
99-000060-01	Bracket Smart Series DOAL-100 mm-to-Vision HAWK & QX Hawk	€ 256	A
99-000061-01	Bracket Smart Series DOAL-50/70/100 mm-to-C-Mount Vision HAWK and QX Hawk	€ 256	A
99-000050-01	Bracket Smart Series Ring-100 mm-to-Vision HAWK & QX Hawk	€ 138	A
99-000052-01	Bracket Smart Series Ring-60/70 mm-to-Vision HAWK & QX Hawk	€ 138	A
99-000049-01	Bracket Smart Series Ring-100 mm-to-C-Mount Vision HAWK & QX Hawk	€ 138	A
99-000051-01	Bracket Smart Series Ring-R-60/70-to-C-Mount Vision HAWK & QX Hawk	€ 138	A
98-000148-01	Kit L-Bracket QX Series	€ 46	A

\* Though-hole mounting plate; not for use with mounting arm.

## Optical Accessories, C-Mount

Part Number	Description	List Price	Type
98-92800471	Lens Extension Tube 5 mm (C-CS Mount Adapter)	€ 40	A
98-CO206	Lens Extension Tube Set 0.5 mm 1 mm 5 mm 10 mm 20 mm 40 mm	€ 146	A
98-92800571	Lens 8mm F/1.4-16 Front thread 25.5mm P 0.5mm 2/3 C-mount	€ 386	A
98-000257-01*	Lens 12.5 mm F/1.4-close Front Thread 40.5 mm P 0.5 mm 1 in. C-Mount	€ 416	A
98-000258-01	Lens 16 mm F/1.4-16 Front Thread 27 mm P 0.5 mm 2/3 in. C-Mount	€ 416	A
98-000259-01	Lens 25 mm F/1.4-16 Front Thread 27 mm P 0.5 mm 2/3 in. C-Mount	€ 416	A
98-92800575	Lens 35 mm F/2.1-22 Front Thread 25.5 mm P 0.5 mm 2/3 in. C-Mount	€ 386	A
98-92800576	Lens 50 mm F/2.8-22 Front Thread 25.5 mm P 0.5 mm 2/3 in. C-Mount	€ 386	A
98-92800577	Lens 75 mm F/3.9-32 Front Thread 25.5 mm P 0.5 mm 2/3 in. C-Mount	€ 386	A
98-92800311	Lens Skylight UV Filter 25.5 mm	€ 76	A
98-92800371	Lens Polarizing Filter 25.5 mm P0.5	€ 102	A
98-92800372	Lens Polarizing Filter 27 mm P0.5	€ 102	A
98-000218-01	Lens Protection Housing Standard Length (to 48 mm)	€ 338	A
98-000226-01	Lens Protection Housing Long (to 72 mm)	€ 356	A

\* This lens cannot be used in combination with the lens protection housings.

## Software/Manuals

Part Number	Description	List Price	Type
37-000010-01*	Tools Drive, User Documentation, Software	€ 30	A

\* 1 free per order.

### Note:

**QX Hawk Tech References are equal to QX-830  
Visit the QX-830 section for configuration references**

# MICROSCAN.

## Verification Kits



Best Sellers
1) SLN-0000005
2) SLN-0000006

**\*\*Important Pricing Discount Note\*\*** Product discounts are applied based on the Product TYPE code shown in the TYPE column below.

Product Type codes are defined as: P = PRODUCT Discount, A = ACCESSORY Discount.

A Product Type code modified with L signifies Legacy Status (refer to Legacy section of this catalog).

Refer to your Partner Agreement for the actual discount percentage by Product Type.

### Verification Kits

Part Number	Description	List Price	Type
SLN-0000004	Dot Peen Verif. Kit (Cables Not Included)	€ 5,182	P
SLN-0000005	1D/2D LABEL Verification Kit	€ 6,486	P
SLN-0000006	Large Linear Verif. Kit (Cables Not Included)	€ 7,288	P
SLN-0000018	Large Linear Verif. Kit with VMI & Accessories	€ 11,182	P

NOTE: Software is included on the TOOLS DRIVE. Order as a separate item.

### Accessories

Part Number	Description	List Price	Type
97-000012-01	Power Supply 100-240VAC +24VDC M12 12-pin Socket	€ 140	A
98-000103-02	QX-1 Interface Device	€ 196	A
61-000148-01	QX CordsetCommonM12 12-Pin Socket(Ult.Lock)-to-M12 12-Pin Plug(Ult.Lock)3m.	€ 80	A
61-000148-02	QX CordsetCommonM12 12-Pin Socket(Screw-On)-to-M12 12-Pin Plug(Screw-On)3m.	€ 96	A
61-000204-01	QX Cordset Smart Series Light-to-QX-1 Continuous Power	€ 206	A
61-000218-01	QX Cordset Smart Series Light-to-QX-1 Strobe NPN	€ 132	A
99-000020-02	QX Photo Sensor M12 4-Pin Plug NPN Dark On 2 m.	€ 196	A

### Software/Manuals

Part Number	Description	List Price	Type
37-000010-01	Tools Drive, User Documentation, Software	€ 30	A
98-000217-05	AV to Verif. & VMI License Upgrade	€ 2,752	A

## Tech Reference Verification Kits

The required accessories are an Ethernet cable for the camera, a power supply,

The minimum set of accessories required to complete a bench-top installation follows.

Hardware Required		
Item	Description	Part Number
1	Power Supply, 100-240VAC, +24 VDC, M12 12-pin Socket (Screw-On)	97-000012-01
2	QX-1 Connection Block	98-000103-02
3	QX Cordset, Host, Ethernet, M12 8-pin Plug (Screw-On) to RJ45, 3m	61-000163-02
4	QX Cordset, Common, M12 12-pin, Socket (Screw-On) to M12 12-pin Plug (Screw-On), 3m	61-000148-02
5	Cable, Power, Smart Series to QX-1	61-000204-01
5	Cable, Smart Series to QX-1, Strobe, NPN	61-000218-01
6	Trigger, M12 4-pin Plug, NPN, Dark On, 2 m	99-000020-02

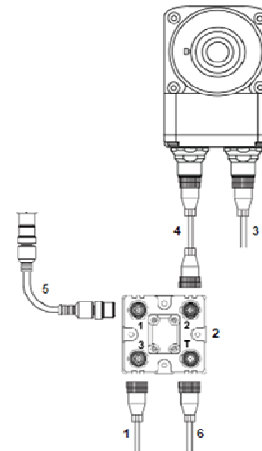

# MICROSCAN.

## PanelScan™ PCB Traceability System

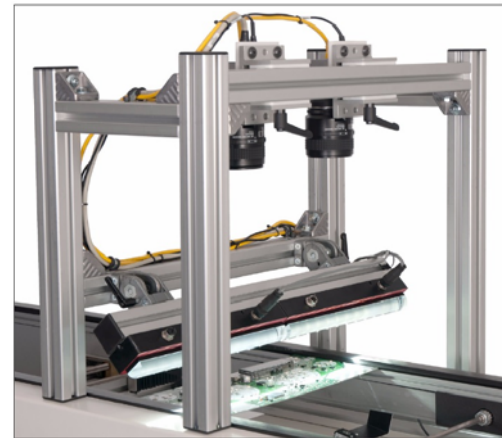

PanelScan Wide Configuration (Two Cameras)

**\*\*Important Pricing Discount Note\*\*** Product discounts are applied based on the Product TYPE code shown in the TYPE column below.

Product Type codes are defined as: P = PRODUCT Discount, A = ACCESSORY Discount.

A Product Type code modified with L signifies Legacy Status (refer to Legacy section of this catalog).

Refer to your Partner Agreement for the actual discount percentage by Product Type.

### PanelScan

Part Number	Description	List Price	Type
SLN-0001010	PanelScan Standard (10 in.x24 in. 254 mmx609 mm Field of View) White Light	NULL	A
SLN-0001011	PanelScan Wide (20 in.x24 in. 508 mmx609 mm Field of View) White Light	NULL	A
SLN-0001110	PanelScan Standard (10 in.x24 in. 254 mmx609 mm Field of View) Red Light	NULL	A
SLN-0001111	PanelScan Wide (20 in.x24 in. 508 mmx609 mm Field of View) Red Light	NULL	A

1) Standard Kit- includes single camera, lens, single line light, PanelScan software interface, Visionscape software, setup guide, power and Ethernet accessories.

2) Wide Kit- includes 2 cameras, 2 lenses, 2 line lights, PanelScan software interface, Visionscape software, setup guide, power and ethernet accessories.

3) PC, conveyor, mounting structure, and encoder not included

# MICROSCAN.

## Auto ID Handhelds

### HS-21 and HS-41X 2D Handheld Readers

#### Read Ranges

1D	
5 mil (.127 mm)	3.7" to 5.0" (94 to 127 mm)
7.5 mil (.191 mm)	2.2" to 6.5" (56 to 165 mm)
10 mil (.254 mm)	1.5" to 8.0" (38 to 203 mm)
20 mil (.508 mm)	2.3 to 15.5" (58 to 394 mm)
2D	
5 mil (.127 mm)	3.7" to 4.6" (94 to 117 mm)
7.5 mil (.191 mm)	1.5" to 6.0" (38 to 152 mm)
15 mil (.381 mm)	1.6" to 7.7" (41 to 196 mm)
20 mil (.508 mm)	1.6" o 9.4" (41 to 239 mm)



Best Seller

FIS-HS41X-0001G

**\*\*Important Pricing Discount Note\*\*** Product discounts are applied based on the Product TYPE code shown in the TYPE column below.

Product Type codes are defined as: P = PRODUCT Discount, A = ACCESSORY Discount.

A Product Type code modified with L signifies Legacy Status (refer to Legacy section of this catalog).

Refer to your Partner Agreement for the actual discount percentage by Product Type.

#### HS-21 Reader

Part Number	Description	List Price	Type
FIS-HS21-0001G	HS-21 Handheld Reader USB 6 ft. Straight Cable	€ 462	P
FIS-HS21-0005G*	HS-21 Handheld Reader RS-232 8 ft. Coiled Cable No Power Supply	€ 462	P

Note: HS-21 is offered in light gray.

#### HS-41X DPM Reader

Part Number	Description	List Price	Type
FIS-HS41X-0001G	HS-41X Handheld DPM Reader USB 6 ft. Straight Cable	€ 928	P
FIS-HS41X-0005G*	HS-41X Handheld DPM Reader RS-232 8 ft. Coiled Cable No Power Supply	€ 928	P
FIS-HS41X-0006G	HS-41X Handheld DPM Reader HD USB 6 ft. Straight Cable	€ 1,488	P

Note: HS-41X is offered in dark gray.

\*Power Supply Sold Separately (see 20-00033X-02 options below)

#### Accessories

Part Number	Description	List Price	Type
98-000264-01*	Demo Kit HS-21 & HS-41X USB 2 6 ft. Strt. USB Cables 1 8 ft. Serial Cable	€ 960	P
98-000270-03	Kit Presentation Stand HS-21/HS-41X	€ 52	A
98-9000026-01	Kit Presentation Mount without Stand HS-21/HS-41X	€ 36	A
61-000224-01	Cable USB HS-21/HS-41X 6 ft. Straight	€ 46	A
61-000224-02	Cable USB HS-21/HS-41X 8 ft. Coiled	€ 46	A
61-000224-03	Cable RS-232 HS-21/HS-41X 8 ft. Coiled	€ 40	A
20-000335-02	Power Supply Handheld Reader Wall Mount 90-264 VAC +5VDC 1.5A U.S. Plug	€ 41	A
20-000336-02	Power Supply Handheld Reader Wall Mount 90-264 VAC +5VDC 1.5A Euro Plug	€ 72	A
20-000337-02	Power Supply Handheld Reader Wall Mount 90-264 VAC +5VDC 1.5A UK Plug	€ 88	A

\*NOTE: This demo kit contains 2 readers and is discounted at 25%

#### Software/Manuals

Part Number	Description	List Price	Type
37-000010-01*	Tools Drive, User Documentation, Software	€ 30	A

\* 1 free per order.

## Tech Reference *HS-21 / HS-41X*

### USB and Serial Configuration

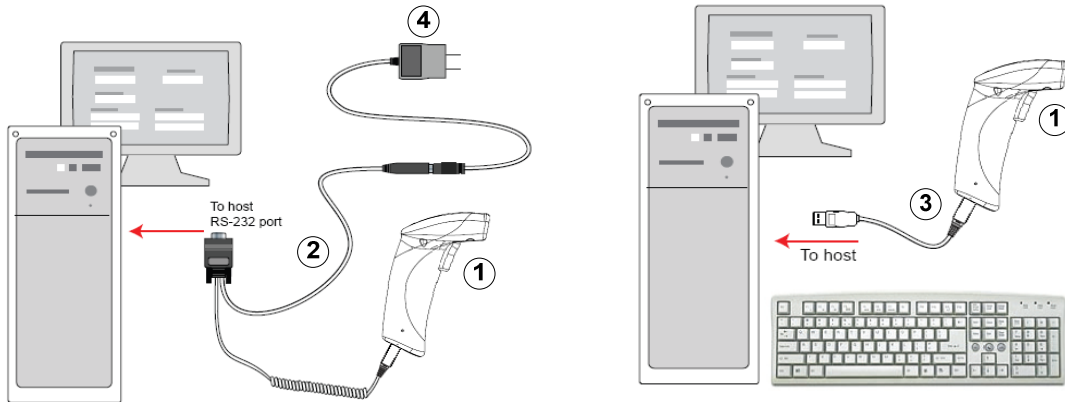

Item	Part Number	Description	List Price
1	FIS-HSX1-0001G	HS-21 / HS-41X Handheld 2D Reader, USB, 6ft Straight Cable	Varies
	OR		
1	FIS-HSX1-0005G	HS-21 / HS-41X Handheld 2D Reader, RS-232, 8ft Coiled Cable	Varies
2	61-000224-03	Cable, RS-232, HS-21/HS-41X, 8 ft., Coiled	
3	61-000224-01	Cable, USB, HS-21/HS-41X, 6 ft., Straight	€ 46
4	20-00033X-02 **	POWER SUPPLY, WALL MOUNT, 90-264 VAC, +5VDC, 1.5A	Varies
	98-000270-03	Kit, Presentation Stand, HS-21/HS-41X	€ 52
	37-000010-01*	Tools Drive, User Documentation, Software	\$ 30

\* One free per order. \*\*Select Supply by Plug type for RS232

# MICROSCAN.

## Auto ID Handhelds

### HS-51 and HS-51X 2D Wireless Handheld Readers

#### Read Ranges

1D	
5 mil (.127 mm)	3.7" to 5.0" (94 to 127 mm)
7.5 mil (.191 mm)	2.2" to 6.5" (56 to 165 mm)
10 mil (.254 mm)	1.5" to 8.0" (38 to 203 mm)
20 mil (.508 mm)	2.3 to 15.5" (58 to 394 mm)
2D	
5 mil (.127 mm)	3.7" to 4.6" (94 to 117 mm)
7.5 mil (.191 mm)	1.5" to 6.0" (38 to 152 mm)
15 mil (.381 mm)	1.6" to 7.7" (41 to 196 mm)
20 mil (.508 mm)	1.6" o 9.4" (41 to 239 mm)



**Best Seller**  
FIS-HS51X-0002G

**\*\*Important Pricing Discount Note\*\*** Product discounts are applied based on the Product TYPE code shown in the TYPE column below.

Product Type codes are defined as: P = PRODUCT Discount, A = ACCESSORY Discount.

A Product Type code modified with L signifies Legacy Status (refer to Legacy section of this catalog).

Refer to your Partner Agreement for the actual discount percentage by Product Type.

#### HS-51X Reader

Part Number	Description	List Price	Type
FIS-HS51X-0002G**	HS-51X Wireless Handheld Reader with Battery Bluetooth Charging Base USB Cable	€ 1,674	P

\*\*Wall mount power supply is not included with reader. Please select the appropriate regional power supply from Accessories below.

#### Accessories

Part Number	Description	List Price	Type
98-9000009-01	HS-51/51X Battery Charger 4-Bay	€ 256	A
98-9000007-01	HS-51/51X Charging Base Station USB Only (No Bluetooth)	€ 136	A
98-9000008-01	HS-51/51X Battery Li-Ion 1300 mAh	€ 126	A
20-000335-02	Power Supply Handheld Reader Wall Mount 90-264 VAC +5VDC 1.5A U.S. Plug	€ 41	A
20-000337-02	Power Supply Handheld Reader Wall Mount 90-264 VAC +5VDC 1.5A UK Plug	€ 88	A
20-000336-02	Power Supply Handheld Reader Wall Mount 90-264 VAC +5VDC 1.5A Euro Plug	€ 72	A

#### Software/Manuals

Part Number	Description	List Price	Type
37-000010-01*	Tools Drive, User Documentation, Software	€ 30	A

\* 1 free per order.

## Tech Reference HS-51 / HS-51X

## USB Configuration

Charging Station with Embedded Modem and Wireless Handheld Reader

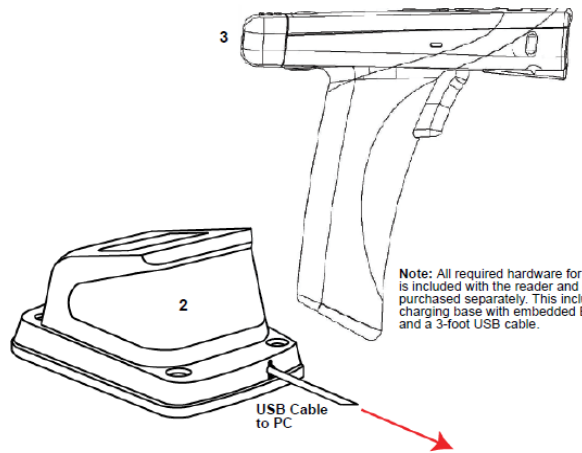

Note: All required hardware for default configuration is included with the reader and does not need to be purchased separately. This includes a battery, a charging base with embedded Bluetooth modem, and a 3-foot USB cable.

Item	Part Number	Description	List Price
1	FIS-HSX1-XXXXG	HS-51 / HS-51X Handheld 2D Reader	Varies
2	98-9000007-01	HS-51/51X Charging Base Station, USB Only (No Bluetooth)	€ 136
3	98-9000008-01	HS-51/51X Battery, Li-Ion, 1300 mAh	€ 126
	20-000335-02	Power Supply, Handheld Reader, Wall Mount, 90-264 VAC, +5VDC, 1.5A,	€ 41
	20-000337-02	Power Supply, Handheld Reader, Wall Mount, 90-264 VAC, +5VDC, 1.5A,	€ 88
	20-000336-02	Power Supply, Handheld Reader, Wall Mount, 90-264 VAC, +5VDC, 1.5A,	€ 72
	37-000010-01*	Tools Drive, User Documentation, Software	€ 30

\* One free per order.

# MICROSCAN

## Auto ID DPM Handhelds

### Mobile Hawk High Performance DPM Handheld Reader

#### Read Ranges

##### High Resolution

5 mil (.127 mm)	.25" to .75" (44 to 64 mm)
10 mil (.254 mm)	.50" to 1.50" (44 to 103 mm)
20 mil (.508 mm)	.50" to 3.50" (44 to 165 mm)



Best Seller

FIS-6170-0002G

**\*\*Important Pricing Discount Note\*\*** Product discounts are applied based on the Product TYPE code shown in the TYPE column below.

Product Type codes are defined as: P = PRODUCT Discount, A = ACCESSORY Discount.

A Product Type code modified with L signifies Legacy Status (refer to Legacy section of this catalog).

Refer to your Partner Agreement for the actual discount percentage by Product Type.

#### Reader

Part Number	Description	List Price	Type
FIS-6170-0002G	Mobile Hawk Handheld DPM Imager USB	€ 1,950	P

#### Accessories

Part Number	Description	List Price	Type
98-000074-04	Interface Kit Handheld Reader RS-232 8 ft. Coiled Cable U.S. Power Supply	€ 78	A
98-000074-05	Interface Kit Handheld Reader RS-232 8 ft. Coiled Cable Euro Power Supply	€ 112	A
98-000074-06	Interface Kit Handheld Reader RS-232 8 ft. Coiled Cable UK Power Supply	€ 122	A
60-000008-02	Cable 8 ft. Coiled RS-232 Interface	€ 52	A
61-9000032-01	USB 2.0 PASSIVE HUB FOR MOBILE HAWK	€ 30	A
60-000009-02	Cable 6 ft. Straight USB Interface	€ 52	A
60-000031-01	Cable 12 ft. Straight USB Interface	€ 78	A

NOTE: Demo kits are not available for the Mobile Hawk. A reader, specifically purchased as a demo unit will be discounted 50%.

NOTE: PS2 cable is not supported by the Mobile Hawk product.

#### Software/Manuals

Part Number	Description	List Price	Type
37-000010-01*	Tools Drive, User Documentation, Software	€ 30	A

\* 1 free per order.

# MICROSCAN

## Auto ID Software, Connectivity, and Accessories

### MS-Connect Series



#### Best Sellers

- 1) FIS-0210-0001G
- 2) FIS-0210-0003G

**\*\*Important Pricing Discount Note\*\*** Product discounts are applied based on the Product TYPE code shown in the TYPE column below.

Product Type codes are defined as: P = PRODUCT Discount, A = ACCESSORY Discount.

A Product Type code modified with L signifies Legacy Status (refer to Legacy section of this catalog).

Refer to your Partner Agreement for the actual discount percentage by Product Type.

#### MS-Connect 210 Options

Part Number	Description	List Price	Type
FIS-0210-0001G	MS-Connect 210 Connectivity Box with Display	€ 880	A
FIS-0210-0002G	MS-Connect 210 Connectivity Box	€ 600	A
FIS-0210-0003G	MS-Connect 210 Connectivity Box with Display & Ethernet	€ 1,000	A
FIS-0210-0004G	MS-Connect 210 Connectivity Box with Ethernet	€ 880	A

#### Accessories

Part Number	Description	List Price	Type
61-000105-01	Cable Pre-Stripped-to-9-Pin Host Cable 6 ft.	€ 32	A
61-000122-01	Cable to MS-Connect 210 Host RS-422/RS-485 for Multidrop 6 ft.	€ 112	A
61-000123-01	Cable to MS-Connect 210 Host/Aux RS-232 for Daisy Chain 210-to-210 6 ft.	€ 112	A
61-000127-02	Cable MS-2-to-MS-Connect 210 6 ft.	€ 112	A
FIS-0001-0035G	Converter IC-332 24V/5V Opto I/O for Use with IB-131	€ 184	A
98-000013-04	Relay Module 120VAC 3 Amp Output Series 70 Type SM for MS-Connect 210 + MS-890	€ 56	A
98-000013-05	Relay Module 240VAC 3 Amp Output Series 70 Type SM for MS-Connect 210 + MS-890	€ 56	A
98-000013-06	Relay Module 24VDC 3 Amp Output Series 70 Type SM for MS-Connect 210 MS-890	€ 56	A
61-000066-01	Cable MS-Connect 210-to-MS-Q (Pre-Strip before Wiring)	€ 90	A
61-000158-03	QX Cordset M12 12-Pin Plug & M12 12-Pin Socket-to-MS-Connect 210 (RS-232) 2 m.	€ 374	A
61-000108-01	Cable RJ12-to-9-Pin D-sub 6 ft.	€ 52	A
61-000112-01	Cable USB Type A Plug-to-Mini-B Plug 10 ft.	€ 36	A
99-000018-01	IB-131 Interface Box	€ 184	A
98-000040-02	Cable Interface & Reader 6 ft. IB-150	€ 196	A
61-000158-04	QX Cordset M12 12-Pin Plug & M12 12-Pin Socket-to-MS-Connect 210 (RS-422) 2 m.	€ 250	A
98-000095-02**	Demo Kit MS-Connect 210	€ 896	A

\*\* This demo kit does not contain the MS-Connect 210 and is discounted 25%. A MS-Connect 210 ordered separately is discounted 60%

#### Power Supply

Part Number	Description	List Price	Type
97-000012-02	Power Supply 100-240VAC +24VDC TRK 3-Pin U.S./Euro Plug)	€ 154	A

#### Mounting

Part Number	Description	List Price	Type
98-000093-01	Kit DIN Rail Mounting MS-Connect 210	€ 52	A

#### Package Detector/Sensor

Part Number	Description	List Price	Type
99-000017-01	Photo Sensor Visible NPN Dark ON	€ 196	A
99-000017-02	Photo Sensor Visible NPN Light ON	€ 196	A

#### Software/Manuals

Part Number	Description	List Price	Type
37-000010-01*	Tools Drive, User Documentation, Software	€ 30	A

\* 1 free per order.

### Stand Alone

These are the setup options for one MS-Connect 210 and one 10-28V or 5V reader.

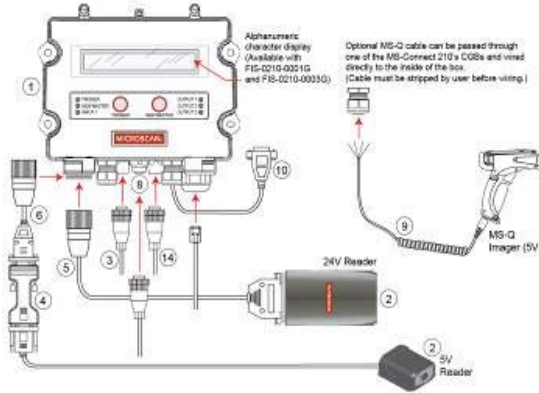

Product	Reference No.	Description	List Price
(1) MS-Connect 210	FIS-0210-0001G	MS-Connect 210, Connectivity Box with Display	€ 880
	FIS-0210-0002G	MS-Connect 210, Connectivity Box	€ 600
	FIS-0210-0003G	MS-Connect 210, Connectivity Box with Display & Ethernet	€ 1,000
	FIS-0210-0004G	MS-Connect 210, Connectivity Box with Ethernet	€ 880
(2) Microscan Reader	FIS-XXXX-XXXXG	Varies	Varies
(3) Power Supply	97-000012-02	Power Supply, 100-240VAC, +24VDC, TRK 3-Pin, U.S./Euro Plug)	€ 154
(4) IC-332 (5V Readers)	FIS-0001-0035G	Converter, IC-332, 24V/5V, Opto I/O, for Use with IB-131	€ 184
(5) Reader Cable (10-28V Readers)	61-000122-01	Cable to MS-Connect 210, Host RS-422/RS-485 for Multidrop, 6 ft.	€ 112
(6) Reader Cable (5V Readers and MS-9)	61-000127-02	Cable, MS-2-to-MS-Connect 210, 6 ft.	€ 112
(7) Reader Cable (5V Readers and MS-9)	61-000139-01	Cable to MS-Connect 210, Host RS-422/RS-485 for Multidrop, 6 ft.	€ 112
(8) Reader Cable (MS-820 only; not shown)	61-000121-02	Cable, MS-820-to-MS-Connect 210, 3 ft.	€ 36
(9) Internal Ethernet Cable (If applicable)	61-000128-01	Cable, External Micro-Change-to-Internal Ethernet Module, MS-Connect 210, 8 in.	€ 56
(10) MS-Q Reader Cable (If applicable)	61-000066-01	Cable, MS-Connect 210-to-MS-Q (Pre-Strip before Wiring)	€ 90
(11) MS-Connect 210 Host Cable	61-000105-01	Cable, Pre-Stripped-to-9-Pin Host Cable, 6 ft.	€ 32
(12) Pluggable Relay Module (If applicable; not shown)	98-000013-04	Relay Mod., 120VAC, 3A Output, Series 70, Type SM, for MS-Connect 210 & MS-890	€ 56
(13) Pluggable Relay Module (If applicable; not shown)	98-000013-05	Relay Mod., 240VAC, 3A Output, Series 70, Type SM, for MS-Connect 210 & MS-890	€ 56
(14) Pluggable Relay Module (If applicable; not shown)	98-000013-06	Relay Module, 24VDC, 3 Amp Output, Series 70, Type SM, for MS-Connect 210, MS-890	€ 56
(15) Object Detector (If applicable)	99-000017-02	Photo Sensor, Visible, NPN, Light ON	€ 196
DIN Rail Mounting Kit	98-000093-01	Kit, DIN Rail Mounting, MS-Connect 210	€ 52

### Daisy Chain

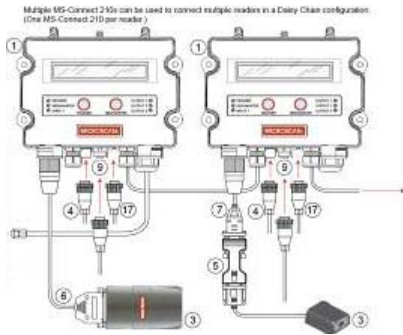

Product	Reference No.	Description	List Price
(1) MS-Connect 210	FIS-0210-0001G	MS-Connect 210, Connectivity Box with Display	€ 880
	FIS-0210-0002G	MS-Connect 210, Connectivity Box	€ 600
	FIS-0210-0003G	MS-Connect 210, Connectivity Box with Display & Ethernet	€ 1,000
	FIS-0210-0004G	MS-Connect 210, Connectivity Box with Ethernet	€ 880
(3) Microscan Reader	FIS-XXXX-XXXXG	Varies	Varies
(4) Power Supply	97-000012-02	Power Supply, 100-240VAC, +24VDC, TRK 3-Pin, U.S./Euro Plug)	€ 154
(5) IC-332	FIS-0001-0035G	Converter, IC-332, 24V/5V, Opto I/O, for Use with IB-131	€ 184
(6) Reader Cable (10-28V)	61-000122-01	Cable to MS-Connect 210, Host RS-422/RS-485 for Multidrop, 6 ft.	€ 112
(7) Reader Cable (5V Readers and MS-9)	61-000127-02	Cable, MS-2-to-MS-Connect 210, 6 ft.	€ 112
(8) Reader Cable (MS-820 only; not shown)	61-000121-02	Cable, MS-820-to-MS-Connect 210, 3 ft.	€ 36
(9) Internal Ethernet Cable (If applicable)	61-000128-01	Cable, External Micro-Change-to-Internal Ethernet Module, MS-Connect 210, 8 in.	€ 56
(11) MS-Connect 210 Host Cable (not shown)	61-000105-01	Cable, Pre-Stripped-to-9-Pin Host Cable, 6 ft.	€ 32
(14) Pluggable Relay Module (If applicable; not shown)	98-000013-04	Relay Mod., 120VAC, 3A Output, Series 70, Type SM, for MS-Connect 210 & MS-890	€ 56
(15) Pluggable Relay Module (If applicable; not shown)	98-000013-05	Relay Mod., 240VAC, 3A Output, Series 70, Type SM, for MS-Connect 210 & MS-890	€ 56
(16) Pluggable Relay Module (If applicable; not shown)	98-000013-06	Relay Module, 24VDC, 3 Amp Output, Series 70, Type SM, for MS-Connect 210, MS-890	€ 56
(17) Object Detector (If applicable)	99-000017-02	Photo Sensor, Visible, NPN, Light ON	€ 196
DIN Rail Mounting Kit	98-000093-01	Kit, DIN Rail Mounting, MS-Connect 210	€ 52

### Right Angle Mirror Kits

1) FIS-0001-0035G

Part Number	Description	List Price	Type
98-200026-02	Kit Right Angle Mirror MS-820/QX-830	€ 84	A
98-200036-01	Kit Right Angle Mirror MS-9	€ 84	A
98-000088-01	Kit Right Angle Mirror MS-4/MINI Hawk/Vision MINI	€ 56	A
98-000058-02	Kit Extended Right Angle Mirror MS-2 MS-3	€ 56	A

### Package Detector/Sensor

Part Number	Description	List Price	Type
99-000017-01	Photo Sensor Visible NPN Dark ON	€ 196	A
99-000017-02	Photo Sensor Visible NPN Light ON	€ 196	A
99-000019-01	Photo Sensor Visible NPN Light On 5VDC	€ 196	A
99-000004-01	Package Detector Standard Diffuse 120 in. Range 4-Pin Plug	€ 250	A
99-000004-02	Package Detector Standard Diffuse 120 in. Range Underminated	€ 250	A
99-000020-02	QX Photo Sensor M12 4-Pin Plug NPN Dark On 2 m.	€ 196	A
99-000020-01	QX Photo Sensor M12 4-Pin Plug NPN Dark Off 2 m.	€ 196	A

### Cable / Connectivity

Part Number	Description	List Price	Type
61-000010-02	Cable Communication DB-9 Socket-to-DB-9 Socket 6 ft.	€ 36	A
61-000011-02	Extension Cable Reader-to-IB-131 (MS-2 MS-3 MS-4 MS-9 MS-710 MS-820 MINI)	€ 36	A
61-000034-02	Cable Communication/Serial 25-Pin Socket-to-9-Pin Socket 6 ft.	€ 32	A
61-100029-03	Cable Daisy Chain IB-131	€ 36	A
61-300026-03	Cable Communication DB-25 Plug-to-DB-9 Socket 6 ft.	€ 36	A
98-000040-02	Cable Interface & Reader 6 ft. IB-150	€ 196	A
61-000112-01	Cable USB Type A Plug-to-Mini-B Plug 10 ft.	€ 36	A
61-000151-01	Cable MINI USB I/O Breakout Flying Leads 3 ft.	€ 36	A

### Connector Kits

Part Number	Description	List Price	Type
20-610024-01	Trigger Connector 4-Pin Plug (Screw Terminal Field-Wireable) (Self-Wiring)	€ 33	A
20-610020-01	Power Conn.3-Pin Socket (Screw Term.Field-Wireable for Custom IB-131 Wiring)	€ 33	A

### Power Supplies

Part Number	Description	List Price	Type
97-000011-02	Power Supply 100-240VAC +5VDC 2-Pin Plug U.S./Euro Plug	€ 94	A
97-000012-02	Power Supply 100-240VAC +24VDC TRK 3-Pin U.S./Euro Plug)	€ 154	A
97-000012-01	Power Supply 100-240VAC +24VDC M12 12-pin Socket	€ 140	A
97-000012-04	QX Power Supply 24V M12 12 pin Plug USA /Euro Plug	€ 136	A

### Interface Boxes

Part Number	Description	List Price	Type
98-000014-02	Kit IB-131/MS-820 Connectivity	€ 214	A
99-000018-01	IB-131 Interface Box	€ 184	A
99-000008-02	IB-150 Interface Box	€ 166	A
99-000009-02	Interconnectivity IB-151 RS-232 Ethernet TCP/IP	€ 112	A
FIS-0001-0035G	Converter IC-332 24V/5V Opto I/O for Use with IB-131	€ 184	A
98-000051-01	IC-3USB Interface Kit USB-to-Serial 15-Pin	€ 94	A
FIS-0001-0030G	IB-3PC Keyboard Wedge/Interface Box	€ 166	A
98-9000022-01	IB-3USB USB Keyboard Wedge 9600 bps 9-Pin	€ 152	A
98-9000022-02	IB-3USB USB Keyboard Wedge 38.4K bps 9-Pin	€ 152	A
99-420003-04	Accessory Wiring Box IB-890	€ 352	A
98-000103-02	QX-1 Interface Device	€ 196	A
61-000204-01	QX Cordset Smart Series Light-to-QX-1 Continuous Power	€ 206	A

## Mounting Components

Part Number	Description	List Price	Type
<b>Mounting Arm Kits</b>			
98-000016-01	Kit 6 in. Mounting Arm/Adapter MS-820 QX-830 QX-870	€ 120	A
98-000017-01	Mounting Arm/Adapter Kit IB-890 6 in.	€ 100	A
98-000018-01	Mounting Arm/Adapter Kit MS-890 6 in.	€ 100	A
98-000019-01	Mounting Stand Kit MS-9 6 in.	€ 100	A
98-000048-01	Kit Mounting Arm/Adapter 4 in. for MS-2 MS-3	€ 78	A
<b>Extension Arm Kits</b>			
98-000037-01	Mounting Arm Extension Kit 6 in. All Readers	€ 62	A
98-000053-01	Mounting Arm Extension Kit 4 in. for MS-3 MS-4 MINI	€ 40	A
98-000053-02	Mounting Arm Extension Kit 3 in. for MS-2 MS-3 MS-4 MINI	€ 40	A
<b>Base Plates</b>			
98-000046-01	Large Base Plate 12 in.x12 in.	€ 46	A
98-000054-01	Kit Mounting Stand Base Plate	€ 36	A
<b>Standard Mounting Plates</b>			
98-000092-01	Kit Mounting Plate MS-9	€ 24	A
98-500006-01	Kit Mounting Plate MS-710 MS-820 QX-830 QX-870	€ 24	A
98-200037-01	Kit Mounting Plate MS-890	€ 46	A
98-000060-01	Kit Bracket Side Mount MS-2 MS-3 MINI	€ 24	A
98-000059-01	Kit Bracket Angle Mount MS-2 MS-3 MINI	€ 24	A
98-000057-02	Kit Bracket Through-Hole Mount MS-2 MS-3 MINI	€ 24	A

\* Through-hole mounting plate; not for use with mounting arm.

## Software / Manuals

Part Number	Description	List Price	Type
37-000010-01*	Tools Drive, User Documentation, Software	€ 30	A

\* 1 free per order.

# MICROSCAN.

## MicroHAWK Machine Vision Smart Cameras



# MICRO HAWK



Features	MV-20	MV-30	MV-40
Barcode Reading (1D/2D)	●	●	●
Complete Machine Vision	●	●	●
Enclosure	<b>IP40</b>	<b>IP54</b>	<b>IP65/67</b>
PROFINET®			●
Ethernet TCP/IP, EtherNet/IP™			●
Ethernet over USB	●	●	
Serial RS-232		●	●
USB 2.0 High Speed / HID	●	●	
Power over Ethernet (PoE)			●
Outer Illumination		●	●
Liquid Lens Autofocus		●	●
Color Sensor	●	●	●
AutoVISION® Sensor Software	●	●	●
AutoVISION® Software	●	●	●
Visionscape® Software	●	●	●

To customize your MicroHAWK, please use the MicroHAWK Builder (automated version available on OMS).

### 3 Sensor Options

- WVGA 0.3MP
- SXGA 1.2MP
- QSXGA 5MP

### 2 Lens Options

- Standard Density
- High Density

### 2 Focus Options

- Fixed Focus
- Autofocus

### 3 Illumination Options

- Inner
- Outer Red
- Outer White

### 5 License Levels

- AutoVISION Sensor
- AutoVISION
- AutoVISION + Verification
- AutoVISION + Visionscape
- AutoVISION + Verification + Visionscape

**\*\*Important Pricing Discount Note\*\*** Product discounts are applied based on the Product TYPE code shown in the TYPE column below.

Product Type codes are defined as: P = PRODUCT Discount, A = ACCESSORY Discount.

A Product Type code modified with L signifies Legacy Status (refer to Legacy section of this catalog).

Refer to your Partner Agreement for the actual discount percentage by Product Type.

## MV-20 Series Smart Cameras Standard Configurations



IP40 enclosure  
Micro-USB connector (USB only)  
5VDC  
M2 mounting holes

### MicroHAWK ID-20 Series Readers

Part Number	Description	List Price	Type
7211-1102-0100	MICROHAWK MV-20 WVGA SD 102MM AV SENSOR	€ 1,116	P
7211-1102-0101	MICROHAWK MV-20 WVGA SD 102MM AV	€ 1,488	P
7211-1102-0102	MICROHAWK MV-20 WVGA SD 102MM AV+VS	€ 1,860	P
7212-2102-0101	MICROHAWK MV-20 SXGA HD 102MM AV	€ 1,768	P
7212-2102-0102	MICROHAWK MV-20 SXGA HD 102MM AV+VS	€ 2,140	P
7212-2102-0103	MICROHAWK MV-20 SXGA HD 102MM AV+VERIF./OCV	€ 2,140	P
7212-2102-0104	MICROHAWK MV-20 SXGA HD 102MM AV+VERIF./OCV+VS	€ 2,418	P
7213-1102-0100	MICROHAWK MV-20 QSXGA SD 102MM AV SENSOR	€ 1,208	P
7213-1102-0101	MICROHAWK MV-20 QSXGA SD 102MM AV	€ 1,580	P
7213-1102-0102	MICROHAWK MV-20 QSXGA SD 102MM AV+VS	€ 1,954	P

Standard configurations above. Customize MV-20 on the Partner Portal.

Note: Above MV-20 models include 6ft USB 2.0 power cable.

## MV-30 Series Smart Cameras Standard Configurations



Compact size, corner cable design  
IP54 enclosure  
DB-15 connector (USB, Serial, I/O)  
5V DC  
Status Indicators  
Added Illumination Option  
M3 Mounting holes

### MicroHAWK ID-30 Series Readers

Part Number	Description	List Price	Type
7311-1102-1100	MICROHAWK MV-30 WVGA SD 102MM RED AV SENSOR	€ 1,396	P
7311-1102-1101	MICROHAWK MV-30 WVGA SD 102MM RED AV	€ 1,768	P
7311-1102-1102	MICROHAWK MV-30 WVGA SD 102MM RED AV+VS	€ 2,140	P
7311-2190-1101	MICROHAWK MV-30 WVGA HD 190MM RED AV	€ 1,768	P
7311-2190-1102	MICROHAWK MV-30 WVGA HD 190MM RED AV+VS	€ 2,140	P
7311-2190-1103	MICROHAWK MV-30 WVGA HD 190MM RED AV+VERIF./OCV	€ 2,140	P
7311-2190-1104	MICROHAWK MV-30 WVGA HD 190MM RED AV+VERIF./OCV+VS	€ 2,418	P
7311-1000-1100	MICROHAWK MV-30 WVGA SD AUTOFOCUS RED AV SENSOR	€ 1,674	P
7311-1000-1101	MICROHAWK MV-30 WVGA SD AUTOFOCUS RED AV	€ 2,046	P
7311-1000-1102	MICROHAWK MV-30 WVGA SD AUTOFOCUS RED AV+VS	€ 2,418	P
7312-1102-1100	MICROHAWK MV-30 SXGA SD 102MM RED AV SENSOR	€ 1,674	P
7312-1102-1101	MICROHAWK MV-30 SXGA SD 102MM RED AV	€ 2,046	P
7312-1102-1102	MICROHAWK MV-30 SXGA SD 102MM RED AV+VS	€ 2,418	P
7312-2190-1101	MICROHAWK MV-30 SXGA HD 190MM RED AV	€ 2,046	P
7312-2190-1102	MICROHAWK MV-30 SXGA HD 190MM RED AV+VS	€ 2,418	P
7312-2190-1103	MICROHAWK MV-30 SXGA HD 190MM RED AV+VERIF./OCV	€ 2,418	P
7312-2190-1104	MICROHAWK MV-30 SXGA HD 190MM RED AV+VERIF./OCV+VS	€ 2,698	P
7312-2000-1101	MICROHAWK MV-30 SXGA HD AUTOFOCUS RED AV	€ 2,326	P
7312-2000-1102	MICROHAWK MV-30 SXGA HD AUTOFOCUS RED AV+VS	€ 2,698	P
7312-2000-1103	MICROHAWK MV-30 SXGA HD AUTOFOCUS RED AV+VERIF./OCV	€ 2,698	P
7312-2000-1104	MICROHAWK MV-30 SXGA HD AUTOFOCUS RED AV+VERIF./OCV + VS	€ 2,978	P
7313-1102-2100	MICROHAWK MV-30 QSXGA SD 102MMWHT AV SENSOR	€ 1,488	P
7313-1102-2101	MICROHAWK MV-30 QSXGA SD 102MMWHT AV	€ 1,860	P
7313-1102-2102	MICROHAWK MV-30 QSXGA SD 102MMWHT AV+VS	€ 2,234	P
7313-2190-2101	MICROHAWK MV-30 QSXGA HD 190MMWHT AV	€ 1,860	P
7313-2190-2102	MICROHAWK MV-30 QSXGA HD 190MMWHT AV+VS	€ 2,234	P
7313-1000-2100	MICROHAWK MV-30 QSXGA SD AUTOFOCUSWHT AV SENSOR	€ 1,768	P
7313-1000-2101	MICROHAWK MV-30 QSXGA SD AUTOFOCUSWHT AV	€ 2,140	P
7313-1000-2102	MICROHAWK MV-30 QSXGA SD AUTOFOCUSWHT AV+VS	€ 2,514	P
7313-2000-2101	MICROHAWK MV-30 QSXGA HD AUTOFOCUSWHT AV	€ 2,140	P
7313-2000-2102	MICROHAWK MV-30 QSXGA HD AUTOFOCUSWHT AV+VS	€ 2,514	P

Standard configurations above. Customize MV-30 on the Partner Portal.

# MV-40 Series Series Smart Cameras Standard Configurations



MicroHAWK ID-40 Series Readers				
Part Number	Description	List Price	Type	
7411-1102-1100	MICROHAWK MV-40 WVGA SD 102MM RED AV SENSOR	€ 1,674	P	
7411-1102-1101	MICROHAWK MV-40 WVGA SD 102MM RED AV	€ 2,046	P	
7411-1102-1102	MICROHAWK MV-40 WVGA SD 102MM RED AV+VS	€ 2,418	P	
7411-2190-1101	MICROHAWK MV-40 WVGA HD 190MM RED AV	€ 2,046	P	
7411-2190-1102	MICROHAWK MV-40 WVGA HD 190MM RED AV+VS	€ 2,418	P	
7411-2190-1103	MICROHAWK MV-40 WVGA HD 190MM RED AV+VERIF./OCV	€ 2,418	P	
7411-2190-1104	MICROHAWK MV-40 WVGA HD 190MM RED AV+VERIF./OCV+VS	€ 2,698	P	
7411-1000-1100	MICROHAWK MV-40 WVGA SD AUTOFOCUS RED AV SENSOR	€ 1,954	P	
7411-1000-1101	MICROHAWK MV-40 WVGA SD AUTOFOCUS RED AV	€ 2,326	P	
7411-1000-1102	MICROHAWK MV-40 WVGA SD AUTOFOCUS RED AV+VS	€ 2,698	P	
7412-1102-1100	MICROHAWK MV-40 SXGA SD 102MM RED AV SENSOR	€ 1,954	P	
7412-1102-1101	MICROHAWK MV-40 SXGA SD 102MM RED AV	€ 2,326	P	
7412-1102-1102	MICROHAWK MV-40 SXGA SD 102MM RED AV+VS	€ 2,698	P	
7412-2190-1101	MICROHAWK MV-40 SXGA HD 190MM RED AV	€ 2,326	P	
7412-2190-1102	MICROHAWK MV-40 SXGA HD 190MM RED AV+VS	€ 2,698	P	
7412-2190-1103	MICROHAWK MV-40 SXGA HD 190MM RED AV+VERIF./OCV	€ 2,698	P	
7412-2190-1104	MICROHAWK MV-40 SXGA HD 190MM RED AV+VERIF./OCV+VS	€ 2,978	P	
7412-2000-1101	MICROHAWK MV-40 SXGA HD AUTOFOCUS RED AV	€ 2,606	P	
7412-2000-1102	MICROHAWK MV-40 SXGA HD AUTOFOCUS RED AV+VS	€ 2,978	P	
7412-2000-1103	MICROHAWK MV-40 SXGA HD AUTOFOCUS RED AV+VERIF./OCV	€ 2,978	P	
7412-2000-1104	MICROHAWK MV-40 SXGA HD AUTOFOCUS RED AV+VERIF./OCV + VS	€ 3,258	P	
7413-1102-2100	MICROHAWK MV-40 QSXGA SD 102MMWHT AV SENSOR	€ 1,768	P	
7413-1102-2101	MICROHAWK MV-40 QSXGA SD 102MMWHT AV	€ 2,140	P	
7413-1102-2102	MICROHAWK MV-40 QSXGA SD 102MMWHT AV+VS	€ 2,514	P	
7413-2190-2101	MICROHAWK MV-40 QSXGA HD 190MMWHT AV	€ 2,140	P	
7413-2190-2102	MICROHAWK MV-40 QSXGA HD 190MMWHT AV+VS	€ 2,514	P	
7413-1000-2100	MICROHAWK MV-40 QSXGA SD AUTOFOCUSWHT AV SENSOR	€ 2,046	P	
7413-1000-2101	MICROHAWK MV-40 QSXGA SD AUTOFOCUSWHT AV	€ 2,418	P	
7413-1000-2102	MICROHAWK MV-40 QSXGA SD AUTOFOCUSWHT AV+VS	€ 2,792	P	
7413-2000-2101	MICROHAWK MV-40 QSXGA HD AUTOFOCUSWHT AV	€ 2,418	P	
7413-2000-2102	MICROHAWK MV-40 QSXGA HD AUTOFOCUSWHT AV+VS	€ 2,792	P	

Standard configurations above. Customize MV-40 on the Partner Portal.

# MicroHAWK Smart Part Numbering

To customize your MicroHAWK, please use the Smart Part Numbering table (automated version available on OMS).

18 Standard Configurations; over 932 possible options.

## MicroHAWK MV Smart Part Numbering

Part Number Format: 7ABX-YZZZ-LPPP-CCC  
7 = MicroHAWK

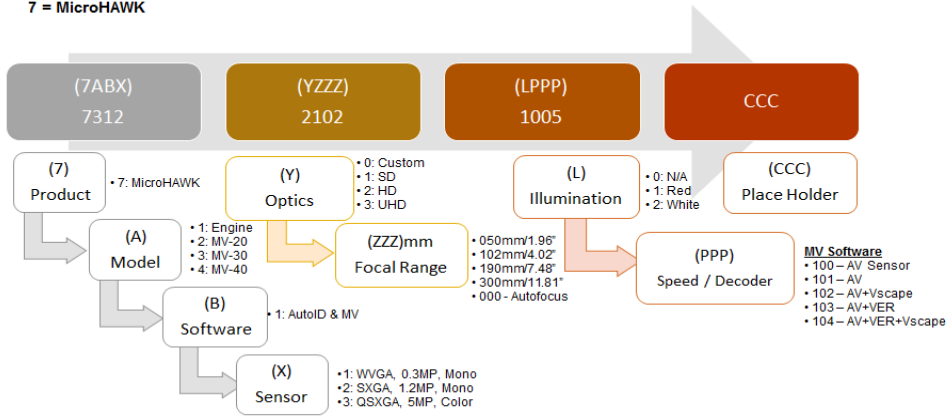

Example Part Number: 7412-2000-1102  
Description: MV-40, SXGA, HD, Autofocus, Red LEDs, AV+Vscope

### Notes:

- LED (L): Additional Outer LEDs provide extra illumination. Base level illumination is always included with each model
- MV License Bundle (PPP): MV Licenses are field upgradable
- Focus Distance (ZZZ): Focus distance is factory settable. 50 mm, 102 mm, 190 mm and 300 mm are standard for MV.

### Part Description Legend

SD= STANDARD DENSITY LENS  
HD= HIGH DENSITY LENS  
RED= RED ILLUM  
WHT= WHITE ILLUM  
AV = AutoVISION  
VER = Verification

### Sensor Table

	<u>Pixels (HxV), MP</u>	<u>Shutter</u>	<u>Frame Rate (Standard/High)</u>
WVGA	752x480, 0.3MP, Monochrome	Global	10 fps / 60 fps
SXGA	1280x960, 1.2MP, Monochrome	Global	10 fps / 42 fps
QSXGA	2592x1944, 5MP, Color	Rolling	5 fps

# MicroHAWK-MV Europe Pricing

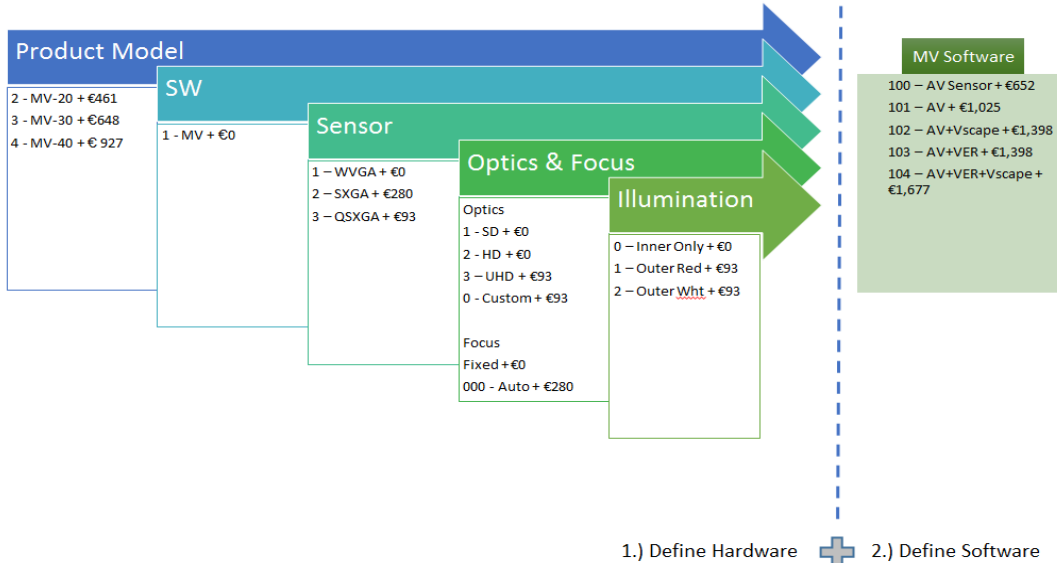

## MicroHAWK Accessories

MicroHAWK MV License Upgrades			
Part Number	Description	List Price	Type
LIC-0700-003	LICENSEMACHINE VISIONAUTOVISION	€ 374	A
LIC-0700-006	LICENSEMACHINE VISIONVISIONSCAPE	€ 374	A
LIC-0700-009	LICENSEMACHINE VISIONVERIFICATION/OCV	€ 374	A
LIC-0700-011	LICENSE MACHINE VISION DUAL BOOT	Call	A
LIC-0700-325	LICENSEMACHINE VISIONMACHINE VISION UNLOCK	€ 654	A

MicroHAWK Connectivity Cables			
Part Number	Description	List Price	Type
61-9000034-01	ABLE USB A MALE TO MICRO USB B MALE 6FT	€ 20	A
61-9000045-01	CABLE USB A MALE TO MICRO USB B MALE 3 FT	€ 20	A
61-9000037-01	CABLEDB15 to EXT PWR/RS232MICROHAWK-30 (Cable only)	€ 76	A
61-9000038-01	CABLEDB15 to EXT PWR/USBMICROHAWK-30 (Cable only)	€ 76	A
61-9000039-01	CABLEDB15 to EXT PWR/USB/OMICROHAWK-30 (Cable only)	€ 96	A
61-9000043-01	CABLEDB15 to BUS PWR USBMICROHAWK-30	€ 66	A
61-9000102-01	CABLEDB15 TO USB/RS232TRIGGEREDMICROHAWK-30 (CABLE ONLY)	€ 386	A
61-000162-02	QX CordsetCommonM12 12-Pin Socket(Screw-On)-to-M12 12-Pin Plug(Screw-On)1m.	€ 92	A
61-000160-03	QX Cordset Host Ethernet M12 8-Pin Plug (Screw-On)-to-RJ45 1 m.	€ 92	A

Note: MV-40 compatible with QX series Screw-On cables and accessories (with exception to Ultra Lock, quick disconnect cables).

MicroHAWK Connectivity Cable Kits			
Part Number	Description	List Price	Type
98-9000048-01	KIT,CABLE,DB15 to EXT PWR/RS232,W/PWR SUPPLY,MICROHAWK-30 ** INCLUDES PN:61-9000037-01 and PN:97-9000006-01	€ 106	A
98-9000049-01	KIT,CABLE,DB15 to EXT PWR/USB,W/PWR SUPPLY,MICROHAWK-30 ** INCLUDES PN:61-9000038-01 and PN:97-9000006-01	€ 106	A
98-9000050-01	KIT,CABLE,DB15 to EXT PWR/USB,I/O,W/PWR SUPPLY,MICROHAWK-30 ** INCLUDES PN:61-9000039-01 and PN:97-000011-02 ***RECOMMENDED TO PURCHASE SEPARATELY: (Select one of below, not included with Kit) - PN:99-000019-01,PHOTO SENSOR,VIS,NPN,5VDC,LIGHT ON - PN:61-000151-01,FLYING LEAD CABLE	€ 186	A

MicroHAWK Power Supplies			
Part Number	Description	List Price	Type
97-900006-01	Power Supply 5V for use with 61-9000037-01 & 61-9000038-01 cables	€ 36	A
97-000011-02	Power Supply 100-240VAC +5VDC 2-Pin Plug U.S./Euro Plug	€ 94	A
97-000012-01	Power Supply 100-240VAC +24VDC M12 12-pin Socket	€ 140	A

Note: 97-000011-02 is for ID-30 with cable 61-9000039-01 & kit 98-9000050-01

MicroHAWK Mounting			
Part Number	Description	List Price	Type
98-9000034-01	KITADAPTERMS-4 to MICROHAWK-20	€ 46	A
98-9000041-01	KIT L BRACKET MICROHAWK	€ 46	A
98-9000047-01	KIT1/4-20 CAMERA MOUNTMICROHAWK	€ 26	A
98-9000052-01	KITMOUNTING STANDMS-3MS-4MINIMICROHAWK4	€ 86	A
98-9000053-01	KITMOUNTING STANDMS-3MS-4MINIMICROHAWK3	€ 86	A
98-9000054-01	KITMOUNTINGAPGMS-4MINIMICROHAWK	€ 126	A
98-9000059-01	KIT ADAPTER PLATEMS-4MINI TO MICROHAWK	€ 96	A

MicroHAWK Accessories			
Part Number	Description	List Price	Type
98-9000043-01	KITDIFFUSERMICROHAWK-30/40	€ 76	A
98-9000044-01	KITPOLARIZERMICROHAWK-30/40	€ 126	A
98-9000045-02	KITRED LEDMICROHAWK-30/40	€ 126	A
98-9000046-01	KITWHITE LEDMICROHAWK-30/40	€ 126	A
98-9000051-01	KITWINDOWMICROHAWK-30/40	€ 36	A
98-9000057-01	KIT RA MIRROR MICROHAWK 20	€ 120	A
98-9000058-01	KIT RA MIRROR MICROHAWK 30 & 40	€ 120	A
98-9000064-01	KITISOLATION MOUNTINGM3MICROHAWK ID-30/40	€ 16	A

## Stand Alone Configurations

Note: Daisy-Chain Configurations are currently not available.

### MV-20 Series Imagers

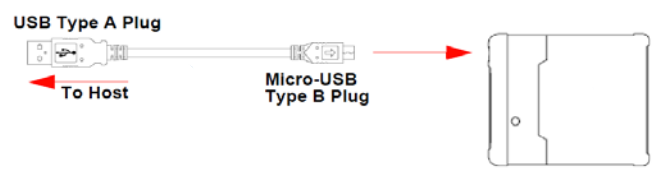

### MV-30 Series Imagers

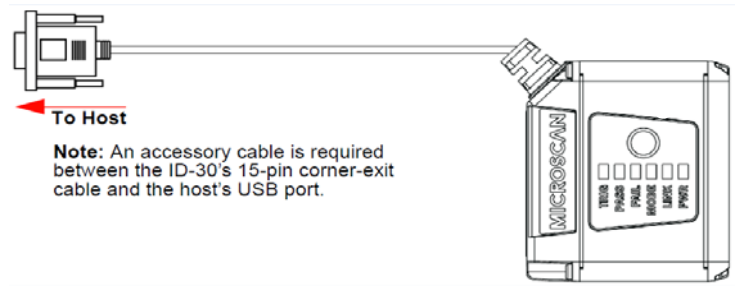

### MV-40 Series Imagers

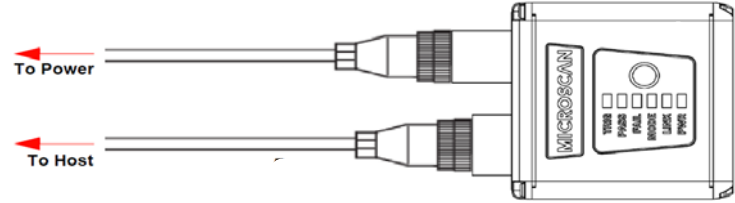

## Tech Reference MicroHAWK MV-20



### System Matrix

Product	Reference No. & Description	List Price
1	MicroHAWK ID-20	Varies
2	61-9000034-01, CABLE,USB A to MicroB,6FT,MICROHAWK-20	€ 20
2	61-9000045-01, CABLE,USB A to MicroB,3FT,MICROHAWK-20	€ 20

## Tech Reference MicroHAWK MV-30

### Stand Alone with DB-15 to BUS PWR USB Type A

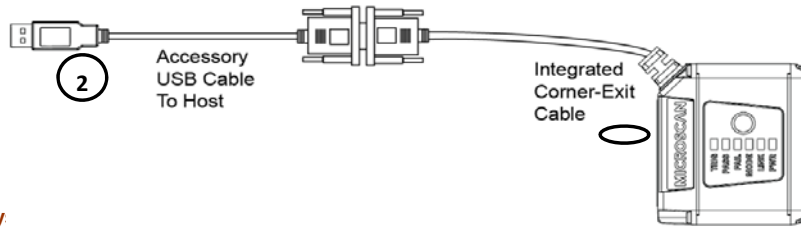

### Sy

Product	Reference No. & Description	List Price
1	MicroHAWK ID-30	Varies
2	61-9000043-01, CABLE,DB15 to BUS PWR USB,MICROHAWK-30	€ 66

Note: Bus powered cable delivers reduced illumination... "approximately 30% less brightness"  
 Note: Does not include I/O interface option: trigger cable with photo-sensor, or flying lead cable

### Stand Alone with DB15 to EXT PWR/USB Type A

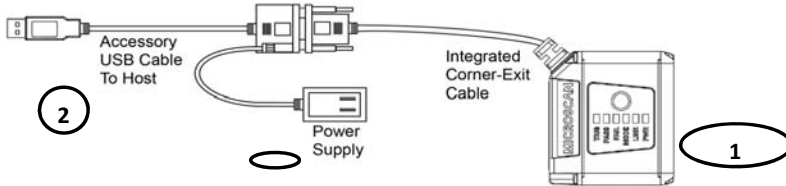

### System Matrix

Product	Reference No. & Description	List Price
1	MicroHAWK ID-30	Varies
2	61-9000038-01, CABLE,DB15 to EXT PWR/USB,MICROHAWK-30	€ 76
3	97-9000006-01, POWER SUPPLY,5V,for PN:61-9000037-01 &	€ 36
	98-9000049-01, KIT,CABLE,DB15 to EXT PWR/USB,W/PWR SUPPLY,MICROHAWK-30	€ 106

Note: Does not include I/O interface option: trigger cable with photo-sensor, or flying lead cable

## Stand Alone with DB15 to EXT PWR/RS232

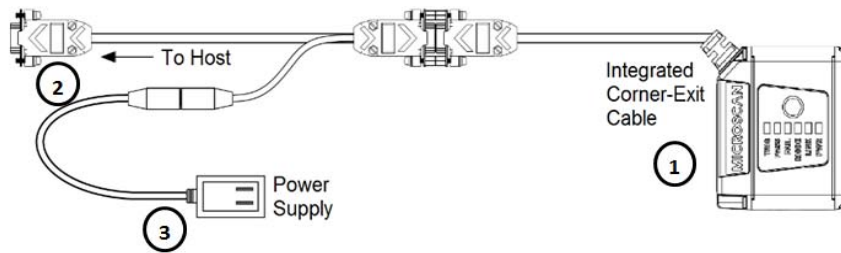

### System Matrix

Product	Reference No. & Description	List Price
1	MicroHAWK ID-30	Varies
2	61-9000037-01, CABLE, DB15 to EXT PWR/RS232, MICROHAWK-30 (Cable only)	€ 76
3	97-9000006-01, POWER SUPPLY, 5V, for PN:61-9000037-01 & PN:61-9000038-01	€ 36
	98-9000048-01, KIT, CABLE, DB15 to EXT PWR/RS232, W/PWR SUPPLY, MICROHAWK-30	€ 106

Note: Does not include I/O interface option: trigger cable with photo-sensor, or flying lead cable

Note: RS232 Connector to host is a standard DB-9

## Stand Alone with DB15 to EXT PWR/USB, I/O

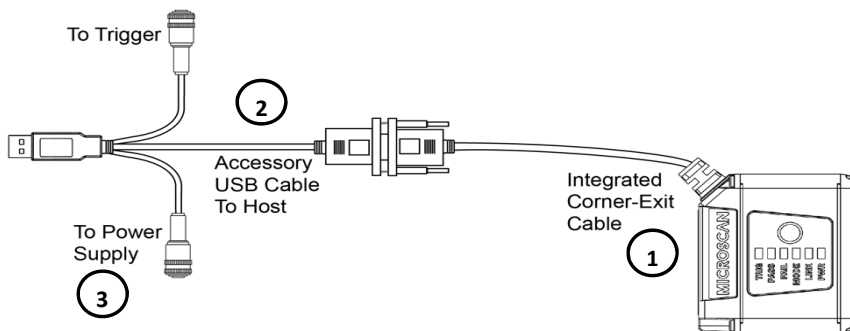

### System Matrix

Product	Reference No. & Description	List Price
1	MicroHAWK ID-30	Varies
2	61-9000039-01, CABLE, DB15 to EXT PWR/USB, I/O.	€ 96
3	97-000011-02, Power Supply, 100-240VAC, +5VDC, 2-Pin Plug, U.S./Euro Plug	€ 94
	98-9000050-01, KIT, CABLE, DB15 to EXT PWR/USB, I/O, W/PWR SUPPLY, MICROHAWK-30	€ 186

## Stand Alone with IB-131 and IC-332

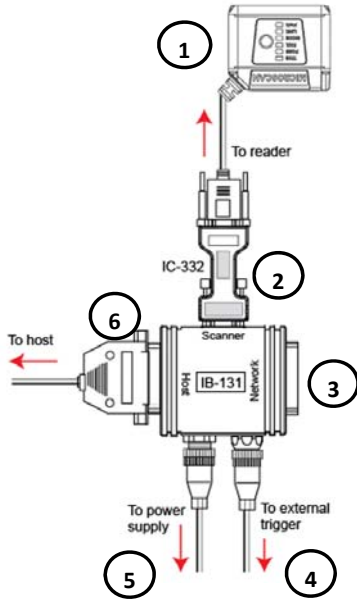

### System Matrix

Product	Reference No. & Description	List Price
1	MicroHAWK ID-30	Varies
2	FIS-0001-0035G, Converter, IC-332, 24V/5V, Opto I/O, for Use with IB-131	€ 184
3	99-000018-01, IB-131 Interface Box	€ 184
4	99-000019-01, Photo Sensor, Visible, NPN, Light On, 5VDC	€ 196
5	97-000012-02, Power Supply, 100-240VAC, +24VDC, TRK 3-Pin, U.S./Euro Plug)	€ 154
6	61-300026-03, Cable, Communication, DB-25 Plug-to-DB-9 Socket, 6 ft.	€ 36

### Tech Reference MicroHAWK MV-40

## Stand Alone with QX-1 Interface

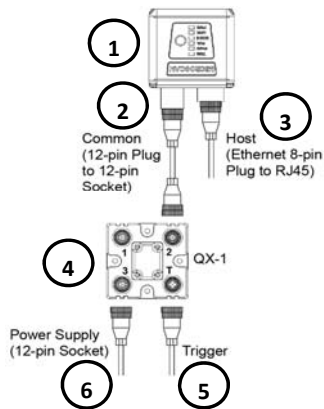

### System Matrix

Product	Reference No. & Description	List Price
1	MicroHAWK ID-40	Varies
2	61-000162-02, QX Cordset, Common, M12 12-Pin Socket(Screw-On)-to-M12 12-Pin Plug(Screw-On), 1m.	€ 92
3	61-000160-03, QX Cordset, Host, Ethernet, M12 8-Pin Plug (Screw-On)-to-RJ45, 1 m.	€ 92
4	98-000103-02, QX-1 Interface Device	€ 196
5	97-000012-01, Power Supply, 100-240VAC, +24VDC, M12 12-Pin Socket	€ 140
6	99-000020-01, QX Photo Sensor, M12 4-Pin Plug, NPN, Dark Off, 2 m.	€ 196
6	99-000020-02, QX Photo Sensor, M12 4-Pin Plug, NPN, Dark, On, 2 m.	€ 196

# MICROSCAN.

## Vision MINI Smart Camera



**Integrated Lighting**  
**Standard and High Density Models**  
**SXGA CMOS 1.3 MP mono**  
**QXGA CMOS 3.0 MP color**  
**WVGA CMOS 0.4 MP mono**  
**USB or Serial\*\***  
**IP-54**  
**+5VDC**



**MICROSCAN.**  
**LINK**

Best Sellers	
1)	GMV-6300-2212G
2)	GMV-6300-2200G
3)	GMV-6300-2210G



\*Color models are only supported by Visionscape

\*\* Serial requires optional adapter

**\*\*Important Pricing Discount Note\*\*** Product discounts are applied based on the Product TYPE code shown in the TYPE column below.

Product Type codes are defined as: P = PRODUCT Discount, A = ACCESSORY Discount.

A Product Type code modified with L signifies Legacy Status (refer to Legacy section of this catalog).

Refer to your Partner Agreement for the actual discount percentage by Product Type.

### Vision MINI Smart Camera - 1.3 MP SXGA (1280 x 1024)

Part Number	Description	List Price	Type
GMV-6300-2110G	Vision MINI SXGA Mono SD AV RS-232/USB	€ 1,856	P
GMV-6300-2210G	Vision MINI SXGA Mono HD AV RS-232/USB	€ 1,856	P
GMV-6300-2112G	Vision MINI SXGA Mono SD VS+AV RS-232/USB	€ 2,322	P
GMV-6300-2212G	Vision MINI SXGA Mono HD VS+AV RS-232/USB	€ 2,322	P
GMV-6300-2114G*	Vision MINI SXGA Mono SD Verif.+AV RS-232/USB	€ 2,228	P
GMV-6300-2214G*	Vision MINI SXGA Mono HD Verif.+AV RS-232/USB	€ 2,228	P
GMV-6300-2116G*	Vision MINI SXGA Mono SD Verif.+AV+VS RS-232/USB	€ 2,696	P
GMV-6300-2216G*	Vision MINI SXGA Mono HD Verif.+AV+VS RS-232/USB	€ 2,696	P

\* Verification calibration card not included in verification license

### Vision MINI Smart Camera - 0.4 MP WVGA (752 x 480)

Part Number	Description	List Price	Type
GMV-6300-2100G	Vision MINI WVGA Mono SD AV RS-232/USB	€ 1,856	P
GMV-6300-2200G	Vision MINI WVGA Mono HD AV RS-232/USB	€ 1,856	P
GMV-6300-2102G	Vision MINI WVGA Mono SD VS+AV RS-232/USB	€ 2,322	P
GMV-6300-2202G	Vision MINI WVGA Mono HD VS+AV RS-232/USB	€ 2,322	P
GMV-6300-2104G*	Vision MINI WVGA Mono SD Verif.+AV RS-232/USB	€ 2,228	P
GMV-6300-2204G*	Vision MINI WVGA Mono HD Verif.+AV RS-232/USB	€ 2,228	P
GMV-6300-2106G*	Vision MINI WVGA Mono SD Verif.+AV+VS RS-232/USB	€ 2,696	P
GMV-6300-2206G*	Vision MINI WVGA Mono HD Verif.+AV+VS RS-232/USB	€ 2,696	P

\* Verification calibration card not included in verification license

### Vision MINI Smart Camera - 3 MP Color QXGA (2048 x 1536)

Part Number	Description	List Price	Type
GMV-6300-2172G	Vision MINI QXGA Color SD VS RS-232/USB	€ 2,788	P
GMV-6300-2272G	Vision MINI QXGA Color HD VS RS-232/USB	€ 2,788	P

The GMV-6300-2272G is a Smart Camera with 3.0 MPixel color sensors. It is not detected and listed as cameras that can be connected and programmed by AutoVISION. It is detected and listed by Visionscape which is required for programming and monitoring.

### Software

Part Number	Description	List Price	Type
98-000217-01	AV to VS License Upgrade	€ 500	A
98-000217-02	AV to VS Verif. & OCV License Upgrade	€ 402	A
98-000217-03	AV to VS Upgrade with Verif. & OCV License	€ 902	A

### Verification Calibration Card

Part Number	Description	List Price	Type
98-000265-01	AV Verif. Calibration Card with NIST-Traceable Measurement Report	€ 476	A
98-000265-02	AV Verif. Calibration Card	€ 226	A

# MICROSCAN

## Accessories

Part Number	Description	List Price	Type
98-000215-01*	Demo Kit AV Supports Vision MINI & Vision HAWK (Cameras Not Included)	€ 596	A
FIS-0210-0001G	MS-Connect 210 Connectivity Box with Display	€ 880	A
FIS-0210-0002G	MS-Connect 210 Connectivity Box	€ 600	A
FIS-0210-0003G	MS-Connect 210 Connectivity Box with Display & Ethernet	€ 1,000	A
FIS-0210-0004G	MS-Connect 210 Connectivity Box with Ethernet	€ 880	A
98-000013-04	Relay Module 120VAC 3 Amp Output Series 70 Type SM for MS-Connect 210 + MS-890	€ 56	A
98-000013-05	Relay Module 240VAC 3 Amp Output Series 70 Type SM for MS-Connect 210 + MS-890	€ 56	A
98-000013-06	Relay Module 24VDC 3 Amp Output Series 70 Type SM for MS-Connect 210 MS-890	€ 56	A
61-000127-02	Cable MS-2-to-MS-Connect 210 6 ft.	€ 112	A
FIS-0001-0035G	Converter IC-332 24V/5V Opto I/O for Use with IB-131	€ 184	A
99-000018-01	IB-131 Interface Box	€ 184	A
61-300026-03	Cable Communication DB-25 Plug-to-DB-9 Socket 6 ft.	€ 36	A
61-100029-03	Cable Daisy Chain IB-131	€ 36	A
61-000208-01	Cable USB 2.0 Type A/Type B with Ferrite	€ 26	A
61-000011-02	Extension Cable Reader-to-IB-131 (MS-2 MS-3 MS-4 MS-9 MS-710 MS-820 MINI)	€ 36	A
98-000098-01	Kit MINI Diffuser	€ 56	A

\* This Demo Kit does not contain a reader and is discounted 25%. The separately purchased reader is discounted 60%.

## Power Supply

Part Number	Description	List Price	Type
97-000012-02	Power Supply 100-240VAC +24VDC TRK 3-Pin U.S./Euro Plug)	€ 154	A

## Mounting and Connectors

Part Number	Description	List Price	Type
98-000048-01	Kit Mounting Arm/Adapter 4 in. for MS-2 MS-3	€ 78	A
98-000054-01	Kit Mounting Stand Base Plate	€ 36	A
98-000053-01	Mounting Arm Extension Kit 4 in. for MS-3 MS-4 MINI	€ 40	A
98-000053-02	Mounting Arm Extension Kit 3 in. for MS-2 MS-3 MS-4 MINI	€ 40	A
98-000060-01	Kit Bracket Side Mount MS-2 MS-3 MINI	€ 24	A
98-000059-01	Kit Bracket Angle Mount MS-2 MS-3 MINI	€ 24	A
98-000057-02	Kit Bracket Through-Hole Mount MS-2 MS-3 MINI	€ 24	A
98-000088-01	Kit Right Angle Mirror MS-4/MINI Hawk/Vision MINI	€ 56	A
20-610024-01	Trigger Connector 4-Pin Plug (Screw Terminal Field-Wireable) (Self-Wiring)	€ 33	A
20-610020-01	Power Conn. 3-Pin Socket (Screw Term. Field-Wireable for Custom IB-131 Wiring)	€ 33	A
99-000055-01	Bracket Smart Series DOAL-50 mm-to-Vision MINI & MINI Hawk	€ 256	A
99-000057-01	Bracket Smart Series DOAL-75 mm-to-Vision MINI & MINI Hawk	€ 256	A
99-000059-01	Bracket Smart Series DOAL-100 mm-to-Vision MINI & MINI Hawk	€ 256	A
99-000053-01	Bracket Smart Series Ring-60/70 mm-to-Vision MINI & MINI Hawk	€ 138	A
99-000054-01	Bracket Smart Series Ring-100 mm-to-Vision MINI & MINI Hawk	€ 138	A

## Package Detector/Sensor

Part Number	Description	List Price	Type
99-000017-01	Photo Sensor Visible NPN Dark ON	€ 196	A
99-000017-02	Photo Sensor Visible NPN Light ON	€ 196	A
99-000019-01	Photo Sensor Visible NPN Light On 5VDC	€ 196	A

## Software/Manuals

Part Number	Description	List Price	Type
37-000010-01*	Tools Drive, User Documentation, Software	€ 30	A

\* 1 free per order.

# MICROSCAN.

## Tech Reference *Vision MINI*

### Stand Alone USB

A single reader is connected directly to the host via USB.

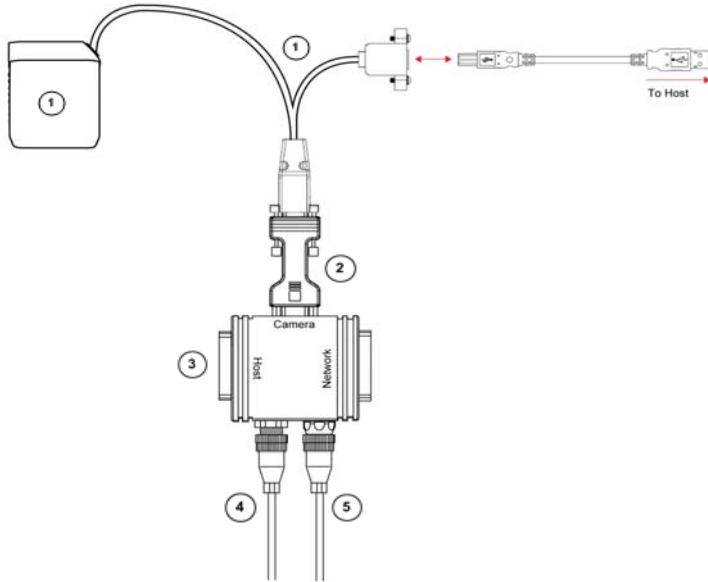

#### System Matrix

Item	Part Number	Description	List Price
1	GMV-6300-2XXXG	Vision MINI Smart Camera and Included Cables	Varies
2	FIS-0001-0035G	Converter, IC-332, 24V/5V, Opto I/O, for Use with IB-131	€ 184
3	99-000018-01	IB-131 Interface Box	€ 184
4	97-000012-02	Power Supply, 100-240VAC, +24VDC, TRK 3-Pin, U.S./Euro Plug)	€ 154
5	99-000017-01	Photo Sensor, Visible, NPN, Dark ON	€ 196
	37-000010-01	Tools Drive, User Documentation, Software	€ 30

# MICROSCAN.

## Vision HAWK Industrial Smart Camera



**Integrated Lighting**  
**WVGA CMOS mono**  
**SXGA CCD mono & color**  
**WUXGA Mono**  
**C-Mount Configurations**  
**Ethernet and Serial Connectivity**  
**Ethernet/IP and ProfiNET I/O via Microscan LINK**  
**IP67**  
**5 - 28 VDC**  
**AutoVISION Software\***  
**Supports AutoVISION and Visionscape Software**  
**CloudLink Dashboard web HMI**

**MICROSCAN.**  
 LINK



**EtherNet/IP**

**PROFI NET**



\*Color models are only supported by Visionscape

\*\*Important Pricing Discount Note\*\* Product discounts are applied based on the Product TYPE code shown in the TYPE column below.

Product Type codes are defined as: P = PRODUCT Discount, A = ACCESSORY Discount.

A Product Type code modified with L signifies Legacy Status (refer to Legacy section of this catalog).

Refer to your Partner Agreement for the actual discount percentage by Product Type.

Best Sellers
1) GMV-6800-1032G
2) GMV-6800-1502G
3) GMV-6800-1002G
4) GMV-6800-1012G

### Vision HAWK Smart Camera WVGA (752 x 480)

Part Number	Description	List Price	Type
GMV-6800-1010G	Vision HAWK WVGA Mono C-Mount AV	€ 3,238	P
GMV-6800-1410G	Vision HAWK WVGA Mono 12° AV	€ 3,436	P
GMV-6800-1510G	Vision HAWK WVGA Mono 15° AV	€ 3,436	P
GMV-6800-1210G	Vision HAWK WVGA Mono 30° AV	€ 3,436	P
GMV-6800-1310G	Vision HAWK WVGA Mono 45° AV	€ 3,436	P
GMV-6800-1012G	Vision HAWK WVGA Mono C-Mount VS+AV	€ 3,612	P
GMV-6800-1412G	Vision HAWK WVGA Mono 12° VS+AV	€ 3,808	P
GMV-6800-1512G	Vision HAWK WVGA Mono 15° VS+AV	€ 3,808	P
GMV-6800-1212G	Vision HAWK WVGA Mono 30° VS+AV	€ 3,808	P
GMV-6800-1312G	Vision HAWK WVGA Mono 45° VS+AV	€ 3,808	P
GMV-6800-1014G*	Vision HAWK WVGA Mono C-Mount AV+Verif./OCV	€ 3,612	P
GMV-6800-1414G*	Vision HAWK WVGA Mono 12° AV+Verif./OCV	€ 3,808	P
GMV-6800-1514G*	Vision HAWK WVGA Mono 15° AV+Verif./OCV	€ 3,808	P
GMV-6800-1214G*	Vision HAWK WVGA Mono 30° AV+Verif./OCV	€ 3,808	P
GMV-6800-1314G*	Vision HAWK WVGA Mono 45° AV+Verif./OCV	€ 3,808	P
GMV-6800-1016G*	Vision HAWK WVGA Mono C-Mount VS+AV+Verif./OCV	€ 3,892	P
GMV-6800-1416G*	Vision HAWK WVGA Mono 12° VS+AV+Verif./OCV	€ 4,088	P
GMV-6800-1516G*	Vision HAWK WVGA Mono 15° AV+Verif./OCV	€ 4,088	P
GMV-6800-1216G*	Vision HAWK WVGA Mono 30° VS+AV+Verif./OCV	€ 4,088	P
GMV-6800-1316G*	Vision HAWK WVGA Mono 45° VS+AV+Verif./OCV	€ 4,088	P

\* Verification calibration card not included in verification license

### Vision HAWK Smart Camera 1.2 MP SXGA (1280 x 960)

Part Number	Description	List Price	Type
GMV-6800-1000G	Vision HAWK SXGA Mono C-Mount AV	€ 3,436	P
GMV-6800-1400G	Vision HAWK SXGA Mono 12° AV	€ 3,630	P
GMV-6800-1500G	Vision HAWK SXGA Mono 15° AV	€ 3,630	P
GMV-6800-1200G	Vision HAWK SXGA Mono 30° AV	€ 3,630	P
GMV-6800-1300G	Vision HAWK SXGA Mono 45° AV	€ 3,630	P
GMV-6800-1002G	Vision HAWK SXGA Mono C-Mount VS+AV	€ 3,808	P
GMV-6800-1402G	Vision HAWK SXGA Mono 12° VS+AV	€ 4,002	P
GMV-6800-1502G	Vision HAWK SXGA Mono 15° VS+AV	€ 4,002	P
GMV-6800-1202G	Vision HAWK SXGA Mono 30° VS+AV	€ 4,002	P
GMV-6800-1302G	Vision HAWK SXGA Mono 45° VS+AV	€ 4,002	P
GMV-6800-1004G*	Vision HAWK SXGA Mono C-Mount AV+Verif./OCV	€ 3,808	P
GMV-6800-1404G*	Vision HAWK SXGA Mono 12° AV+Verif./OCV	€ 4,002	P
GMV-6800-1504G*	Vision HAWK SXGA Mono 15° AV+Verif./OCV	€ 4,002	P
GMV-6800-1204G*	Vision HAWK SXGA Mono 30° AV+Verif./OCV	€ 4,002	P
GMV-6800-1304G*	Vision HAWK SXGA Mono 45° AV+Verif./OCV	€ 4,002	P
GMV-6800-1006G*	Vision HAWK SXGA Mono C-Mount VS+AV+Verif./OCV	€ 4,088	P
GMV-6800-1406G*	Vision HAWK SXGA Mono 12° VS+AV+Verif./OCV	€ 4,282	P
GMV-6800-1506G*	Vision HAWK SXGA Mono 15° VS+AV+Verif./OCV	€ 4,282	P
GMV-6800-1206G*	Vision HAWK SXGA Mono 30° VS+AV+Verif./OCV	€ 4,282	P
GMV-6800-1306G*	Vision HAWK SXGA Mono 45° VS+AV+Verif./OCV	€ 4,282	P

## Vision HAWK Smart Camera 2MP WUXGA (2048 x 1088)

Part Number	Description	List Price	Type
GMV-6800-1030G	Vision HAWK WUXGA Mono C-Mount AV	€ 5,242	P
GMV-6800-1032G	Vision HAWK WUXGA Mono C-Mount VS+AV	€ 5,616	P
GMV-6800-1034G*	Vision HAWK WUXGA Mono C-Mount AV+Verif./OCV	€ 5,616	P
GMV-6800-1036G*	Vision HAWK WUXGA Mono C-Mount VS+AV+Verif./OCV	€ 5,896	P

\* Verification calibration card not included in verification license

## Vision HAWK Smart Camera 1.2MP SXGA (1280 960) Color

Part Number	Description	List Price	Type
GMV-6800-1022G	Vision HAWK SXGA Color C-Mount VS+AV	€ 4,688	P
GMV-6800-1422G	Vision HAWK SXGA Color 12° VS+AV	€ 4,884	P
GMV-6800-1522G	Vision HAWK SXGA Color 15° VS+AV	€ 4,884	P
GMV-6800-1222G	Vision HAWK SXGA Color 30° VS+AV	€ 4,884	P
GMV-6800-1322G	Vision HAWK SXGA Color 45° VS+AV	€ 4,884	P

The Vision HAWK Color Smart Camera is not detected and listed as cameras that can be connected and programmed by AutoVISION.

It is detected and listed by Visionscape which is required for programming and monitoring.

## Software

Part Number	Description	List Price	Type
98-000217-01	AV to VS License Upgrade	€ 500	A
98-000217-02	AV to VS Verif. & OCV License Upgrade	€ 402	A
98-000217-03	AV to VS Upgrade with Verif. & OCV License	€ 902	A
37-9000017-01*	VS I-PAK VH Inspection System Interface for Vision HAWKS	€ 1,925	P

\*Compatible with Vision HAWK Smart Camera models equipped with Visionscape license

## Verification Calibration Card

Part Number	Description	List Price	Type
98-000265-01	AV Verif. Calibration Card with NIST-Traceable Measurement Report	€ 476	A
98-000265-02	AV Verif. Calibration Card	€ 226	A

## Accessories

Part Number	Description	List Price	Type
98-000143-01	Kit Adapter Plate QX Hawk/Vision HAWK	€ 56	A
98-000144-01	Right Angle Mirror Kit QX Hawk/Vision HAWK	€ 86	A
98-000146-01	Kit Window Replacement QX Hawk/Vision HAWK	€ 36	A
98-000147-04	12° Lens QX Hawk	€ 136	A
98-000147-01	15° Lens QX Hawk	€ 136	A
98-000147-02	30° Lens QX Hawk	€ 136	A
98-000147-03	45° Lens QX Hawk	€ 136	A
98-000205-01	Kit Glass Window with IR Coating QX Hawk/Vision HAWK	€ 136	A
98-000206-01	Kit Glass Window QX Hawk/Vision HAWK	€ 72	A
98-000206-02	Kit Lexan Window with Metal Bezel QX Hawk/Vision HAWK	€ 72	A
98-000262-01	Kit White LED Illumination QX Hawk/Vision HAWK	€ 352	A
98-000262-02	Kit Blue LED Illumination QX Hawk/Vision HAWK	€ 352	A
98-000215-01*	Demo Kit AV Supports Vision MINI & Vision HAWK (Cameras Not Included)	€ 596	A

\* This Demo Kit does not contain a reader and is discounted 25%. The separately purchased reader is discounted 60%.

## QX-1 and Cordsets

Part Number	Description	List Price	Type
98-000103-02	QX-1 Interface Device	€ 196	A
61-000148-01	QX CordsetCommonM12 12-Pin Socket(Ult.Lock)-to-M12 12-Pin Plug(Ult.Lock)3m.	€ 80	A
61-000148-02	QX CordsetCommonM12 12-Pin Socket(Screw-On)-to-M12 12-Pin Plug(Screw-On)3m.	€ 96	A
61-000162-02	QX CordsetCommonM12 12-Pin Socket(Screw-On)-to-M12 12-Pin Plug(Screw-On)1m.	€ 92	A
61-000153-02	QX Cordset Host Serial M12 12-Pin Socket (Screw-On)-to-DB-9 Socket 1 m.	€ 92	A
61-000164-02	QX Cordset Host Serial M12 12-Pin Socket (Screw-On)-to-DB-9 Socket 3 m.	€ 96	A
61-000152-02	QX Cordset Host Serial M12 12-Pin Plug (Screw-On)-to-DB-9 Socket 1 m.	€ 92	A
61-000165-02	QX Cordset Host Serial M12 12-Pin Plug (Screw-On)-to-DB-9 Socket 3 m.	€ 96	A
61-000163-03	QX Cordset Host Ethernet M12 8-Pin Plug (Screw-On)-to-RJ45 3 m.	€ 96	A
61-000160-03	QX Cordset Host Ethernet M12 8-Pin Plug (Screw-On)-to-RJ45 1 m.	€ 92	A
61-000172-02	QX CordsetM12 12-Pin Plug-to-M12 12-Pin Socket-to-DB-25 Plug Turck Connectors	€ 286	A
61-000158-03	QX Cordset M12 12-Pin Plug & M12 12-Pin Socket-to-MS-Connect 210 (RS-232) 2 m.	€ 374	A
61-000158-04	QX Cordset M12 12-Pin Plug & M12 12-Pin Socket-to-MS-Connect 210 (RS-422) 2 m.	€ 250	A
61-000166-02	QX Cordset M12 12-Pin Plug (Screw-On)-to-Flying Leads 3 m.	€ 96	A
61-000167-02	QX Cordset M12 12-Pin Socket (Screw-On)-to-Flying Leads 3 m.	€ 96	A
98-000013-04	Relay Module120VAC3 Amp OutputSeries 70Type SMfor MS-Connect 210 + MS-890	€ 56	A
98-000013-05	Relay Module240VAC3 Amp OutputSeries 70Type SM for MS-Connect 210 + MS-890	€ 56	A
98-000013-06	Relay Module 24VDC 3 Amp Output Series 70 Type SM for MS-Connect 210MS-890	€ 56	A
61-000204-01	QX Cordset Smart Series Light-to-QX-1 Continuous Power	€ 206	A
61-000207-01	QX Cordset Smart Series Light-to-QX-1 Continuous ON/OFF	€ 232	A
61-000218-01*	QX Cordset Smart Series Light-to-QX-1 Strobe NPN	€ 132	A

\*Strobe is available on C-Mount Vision HAWK only

## Power Supplies

Part Number	Description	List Price	Type
97-000012-01	Power Supply 100-240VAC +24VDC M12 12-pin Socket	€ 140	A

## Package Detector/Sensor

Part Number	Description	List Price	Type
99-000020-02	QX Photo Sensor M12 4-Pin Plug NPN Dark On 2 m.	€ 196	A
99-000020-01	QX Photo Sensor M12 4-Pin Plug NPN Dark Off 2 m.	€ 196	A

## Mounting and Connectors

Part Number	Description	List Price	Type
20-610024-01	Trigger Connector 4-Pin Plug (Screw Terminal Field-Wireable) (Self-Wiring)	€ 33	A
98-000037-01	Mounting Arm Extension Kit 6 in. All Readers	€ 62	A
98-000054-01	Kit Mounting Stand Base Plate	€ 36	A
98-000016-01	Kit 6 in. Mounting Arm/Adapter MS-820 QX-830 QX-870	€ 120	A
99-000056-01	Bracket Smart Series DOAL-50 mm-to-Vision HAWK & QX Hawk	€ 256	A
99-000058-01	Bracket Smart Series DOAL-75 mm-to-Vision HAWK & QX Hawk	€ 256	A
99-000060-01	Bracket Smart Series DOAL-100 mm-to-Vision HAWK & QX Hawk	€ 256	A
99-000050-01	Bracket Smart Series Ring-100 mm-to-Vision HAWK & QX Hawk	€ 138	A
99-000052-01	Bracket Smart Series Ring-60/70 mm-to-Vision HAWK & QX Hawk	€ 138	A
99-000061-01	Bracket Smart Series DOAL-50/70/100 mm-to-C-Mount Vision HAWK and QX Hawk	€ 256	A
99-000049-01	Bracket Smart Series Ring-100 mm-to-C-Mount Vision HAWK & QX Hawk	€ 138	A
99-000051-01	Bracket Smart Series Ring-R-60/70-to-C-Mount Vision HAWK & QX Hawk	€ 138	A
98-000148-01	Kit L-Bracket QX Series	€ 46	A

\* Though-hole mounting plate; not for use with mounting arm.

## Optical Accessories, C-Mount

Part Number	Description	List Price	Type
98-92800471	Lens Extension Tube 5 mm (C-CS Mount Adapter)	€ 40	A
98-CO206	Lens Extension Tube Set 0.5 mm 1 mm 5 mm 10 mm 20 mm 40 mm	€ 146	A
98-92800571	Lens 8mm F/1.4-16 Front thread 25.5mm P 0.5mm 2/3 C-mount	€ 386	A
98-000257-01*	Lens 12.5 mm F/1.4-close Front Thread 40.5 mm P 0.5 mm 1 in. C-Mount	€ 416	A
98-000258-01	Lens 16 mm F/1.4-16 Front Thread 27 mm P 0.5 mm 2/3 in. C-Mount	€ 416	A
98-000259-01	Lens 25 mm F/1.4-16 Front Thread 27 mm P 0.5 mm 2/3 in. C-Mount	€ 416	A
98-92800575	Lens 35 mm F/2.1-22 Front Thread 25.5 mm P 0.5 mm 2/3 in. C-Mount	€ 386	A
98-92800576	Lens 50 mm F/2.8-22 Front Thread 25.5 mm P 0.5 mm 2/3 in. C-Mount	€ 386	A
98-92800577	Lens 75 mm F/3.9-32 Front Thread 25.5 mm P 0.5 mm 2/3 in. C-Mount	€ 386	A
98-92800311	Lens Skylight UV Filter 25.5 mm	€ 76	A
98-92800371	Lens Polarizing Filter 25.5 mm P0.5	€ 102	A
98-92800372	Lens Polarizing Filter 27 mm P0.5	€ 102	A
98-000218-01	Lens Protection Housing Standard Length (to 48 mm)	€ 338	A
98-000226-01	Lens Protection Housing Long (to 72 mm)	€ 356	A

\* This lens cannot be used in combination with the lens protection housings.

## Software/Manuals

Part Number	Description	List Price	Type
37-000010-01*	Tools Drive, User Documentation, Software	€ 30	A

\*One free per order

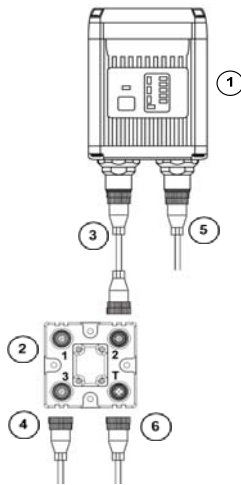

### System Matrix

Item	Part Number	Description	List Price
1	GMV-6800-1XXXG	Vision HAWK Smart Camera	Varies
2	98-000103-02	QX-1 Interface Device	€ 196
3	61-000162-02	QX Cordset, Common, M12 12-Pin Socket(Screw-On)-to-M12 12-Pin Plug(Screw-On), 1m.	€ 92
4	97-000012-01	Power Supply, 100-240VAC, +24VDC, M12 12-Pin Socket	€ 140
5	61-000160-02	QX Cordset, Host, Ethernet, M12 8-Pin Plug (Screw-On)-to-RJ45, 1 m.	€ 90
6	99-000020-02	QX Photo Sensor, M12 4-Pin Plug, NPN, Dark On, 2 m.	€ 196
	37-000010-01	Tools Drive, User Documentation, Software	€ 30

\* Cordsets available in multiple lengths

# MICROSCAN

## Visionscape GigE Solution

### Rapid Application Development

Up to 8 Microscan GigE Cameras  
Consult factory for 3rd party GigE Camera support

### Flexible IO

PC Based discrete IO  
Strobe and Trigger at camera

### Out of Box Experience

Evaluation and Off-Line Programming is license free

### Platforms and Customization

Windows XP and Windows 7  
Microsoft Visual Studio 6 and .NET



Best Sellers
1) GMV-VGL8-1DD1
2) GMV-VGL0-1DD1
3) 98-000222-01
4) 98-000120-01

**\*\*Important Pricing Discount Note\*\* Product discounts are applied based on the Product TYPE code shown in the TYPE column below.**

Product Type codes are defined as: P = PRODUCT Discount, A = ACCESSORY Discount.

A Product Type code modified with L signifies Legacy Status (refer to Legacy section of this catalog).

Refer to your Partner Agreement for the actual discount percentage by Product Type.

### Visionscape Software

Part Number	Description	List Price	Type
GMV-VGL0-1DD1	VS GigE License Key with Intellifind & DIVs	€ 1,860	P
GMV-VGL8-1DD1	VS GigE License Key with Intellifind DIVs Eight Third-Party GigE Cameras	€ 4,004	P

### GigE Cameras

Part Number	Description	List Price	Type
98-000115-01	VS GigE Camera 0.3 MP Mono CMG03 656x494 Pixels CCD	€ 960	A
98-000116-01	VS GigE Camera 0.3 MP Color CMG03c 656x494 Pixels CCD	€ 1,200	A
98-000141-01	VS GigE Camera 0.3 MP Mono CMG04 656x494 Pixels CCD 1/2 in. Sensor	€ 1,602	A
98-000117-01	VS GigE Camera 0.8 MP Mono CMG08 1032x776 Pixels CCD	€ 1,602	A
98-000267-01	VS GigE Camera 0.3 MP Mono CMG04h 640x480 Pixels CCD High Speed	€ 3,596	A
98-000220-01	VS GigE Camera 0.8 MP Color CMG08c 1032x776 Pixels CCD	€ 1,602	A
98-000118-01	VS GigE Camera 1.3 MP Mono CMG13 1392x1040 Pixels CCD	€ 2,096	A
98-000221-01	VS GigE Camera 1.3 MP Color CMG13c 1392x1040 Pixels CCD	€ 2,246	A
98-000191-01	VS GigE Camera 1.4 MP Mono CMG14 1392x1040 Pixels CCD	€ 3,652	A
98-000119-01	VS GigE Camera 2 MP Mono CMG20 1624x1236 Pixels CCD	€ 2,596	A
98-000189-01	VS GigE Camera 2 MP Color CMG20c 1624x1236 Pixels CCD	€ 2,896	A
98-000120-01	VS GigE Camera 5 MP Mono CMG50 2448x2050 Pixels CCD	€ 4,496	A
98-000190-01	VS GigE Camera 5 MP Color CMG50c 2448x2050 Pixels CCD	€ 4,996	A
98-000222-01	VS GigE Camera 5 MP Mono CMGC50 2592x1944 Pixels CMOS	€ 1,696	A
98-000230-01	VS GigE Camera 5 MP Color CMGC50c 2592x1944 Pixels CMOS	€ 1,996	A
98-000260-01	VS GigE Camera 8 MP Mono CMG80 3296x2472 Pixels CCD	€ 12,496	A

### Accessories

Part Number	Description	List Price	Type
98-000130-01	VS GigE PCIe I/O Card 16 Inputs/16 Outputs NPN with Cable & Terminal	€ 796	A
98-000142-01	VS GigE PCIe I/O Card 16 Inputs/16 Outputs PNP with Cable & Terminal	€ 802	A
98-000140-01	Single Port GigE Network Interface Card PCIe	€ 146	A
98-000132-01	Dual Port GigE Network Interface Card PCIe	€ 402	A
98-000138-01	VS GigE Camera Power Supply 24V U.S./Euro/UK	€ 106	A
98-000126-01	Visionscape GigE Camera Trigger & Strobe Cable M8 4-Pin 5 m. Open-End Cable	€ 86	A
98-000129-01	VS GigE Camera Power Cable M8 3-Pin 5 m. Open-End	€ 80	A
98-000133-01	CAT 6 Ethernet Cable Jack Screw-to-RJ45 High Flex 2 m.	€ 92	A
98-000134-01	CAT 6 Ethernet Cable Jack Screws-to-RJ45 High Flex 5 m.	€ 116	A
98-000139-01**	VS GigE Demo Kit License Key CMG03 Power Supply Cables Lens	€ 4,236	A
98-000199-01*	VS GigE Demo Kit License Key Camera Not Included Power Supply Cables Lens	€ 3,506	A

\*\* Demo Kit contains Camera. Kit is discounted 25%.

\* This Demo Kit does not contain a camera and is discounted 25%. The separately purchased camera is discounted 30%.

# MICROSCAN

## Optical Accessories, C-Mount

Part Number	Description	List Price	Type
98-92800471	Lens Extension Tube 5 mm (C-CS Mount Adapter)	€ 40	A
98-CO206	Lens Extension Tube Set 0.5 mm 1 mm 5 mm 10 mm 20 mm 40 mm	€ 146	A
98-92800571	Lens 8mm F/1.4-16 Front thread 25.5mm P 0.5mm 2/3 C-mount	€ 386	A
98-000257-01	Lens 12.5 mm F/1.4-close Front Thread 40.5 mm P 0.5 mm 1 in. C-Mount	€ 416	A
98-000258-01	Lens 16 mm F/1.4-16 Front Thread 27 mm P 0.5 mm 2/3 in. C-Mount	€ 416	A
98-000259-01	Lens 25 mm F/1.4-16 Front Thread 27 mm P 0.5 mm 2/3 in. C-Mount	€ 416	A
98-92800575	Lens 35 mm F/2.1-22 Front Thread 25.5 mm P 0.5 mm 2/3 in. C-Mount	€ 386	A
98-92800576	Lens 50 mm F/2.8-22 Front Thread 25.5 mm P 0.5 mm 2/3 in. C-Mount	€ 386	A
98-92800577	Lens 75 mm F/3.9-32 Front Thread 25.5 mm P 0.5 mm 2/3 in. C-Mount	€ 386	A
98-92800311	Lens Skylight UV Filter 25.5 mm	€ 76	A
98-92800371	Lens Polarizing Filter 25.5 mm P0.5	€ 102	A
98-92800372	Lens Polarizing Filter 27 mm P0.5	€ 102	A
98-000218-01	Lens Protection Housing Standard Length (to 48 mm)	€ 338	A
98-000226-01	Lens Protection Housing Long (to 72 mm)	€ 356	A

## DOAL Camera Mounting Brackets

Part Number	Description	List Price	Type
99-000062-01	Bracket Smart Series Ring-60/70 mm-to-GigE Camera	€ 164	A
99-000063-01	Bracket Smart Series DOAL-to-GigE Camera	€ 312	A
99-000064-01	Bracket Smart Series Ring-100 mm-to-GigE Camera	€ 172	A

## Software/Manuals

Part Number	Description	List Price	Type
37-000010-01*	Tools Drive, User Documentation, Software	€ 30	A

\* 1 free per order.

# MICROSCAN.

## NERLITE® PHARMALITE

**NERLITE® Smart Series Pharmalite uses MAX Light LEDs and feature an integrated strobe controller for easy integration in industrial applications. It can be mounted easily on the QX Hawk, Vision HAWK, Vision MINI, MINI Hawk and GigE Cameras without using an additional bracket.**



Best Seller

98-000228-01

**\*\*Important Pricing Discount Note\*\* Product discounts are applied based on the Product TYPE code shown in the TYPE column below.**

Product Type codes are defined as: P = PRODUCT Discount, A = ACCESSORY Discount.

A Product Type code modified with L signifies Legacy Status (refer to Legacy section of this catalog).

Refer to your Partner Agreement for the actual discount percentage by Product Type.

Pharmalite			
98-000228-01	Smart Series Pharmalite 60° Dark Field White M12 Connector	€ 1,152	P

### Power Supply

Part Number	Description	List Price	Type
NER-011504100	DSP60 24VDC 2.5A DIN Mount Power Supply	€ 210	A
97-000006-01	DSP100 24VDC 4.2A DIN Mount Power Supply	€ 260	A

### Power Supply Cordsets

Part Number	Description	List Price	Type
NER-030028300	AC Power Cord for DSPxx Power Supply U.S.	€ 62	A
NER-030028400	AC Power Cord for DSPxx Power Supply EU	€ 62	A
NER-030028500	AC Power Cord for DSPxx Power Supply UK	€ 62	A
61-000186-01	Cable M12 5-Pin Socket-to-Flying Leads 3 m.	€ 72	A
61-000187-01	Cable M12 5-Pin Socket-to-Flying Leads 5 m.	€ 126	A
61-000204-01	QX Cordset Smart Series Light-to-QX-1 Continuous Power	€ 206	A
61-000207-01	QX Cordset Smart Series Light-to-QX-1 Continuous ON/OFF	€ 232	A
61-000218-01	QX Cordset Smart Series Light-to-QX-1 Strobe NPN	€ 132	A

Strobe is available on C-Mount Vision HAWK only

## Tech Reference *Pharmalite*

Hardware Required		
Item	Description	Part Number
1	Smart Series Pharmalite	98-000228-01
2	Power Supply DSP60 24VDC 2.5A DIN Mount	NER-011504100
2	Power Supply DSP100 24VDC 4.2A DIN Mount	97-000006-01
3	Cable 5 Pin M12 Female To Flying Leads, 3M	61-000186-01
3	Cable 5 Pin M12 Female To Flying Leads, 5M	61-000187-01
4	QX Cordset, Smart Series to QX-1 Continuous	61-000204-01
4	QX Cordset, Smart Series to QX-1, Continuous On/Off	61-000207-01
4	QX Cordset, Smart Series to QX-1 Strobe, NPN	61-000218-01
5	QX-1 Interface Device	98-000103-02

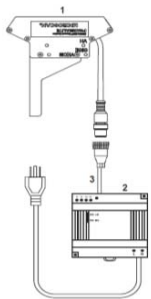

Figure A  
Pharmalite Illuminator  
with power supply

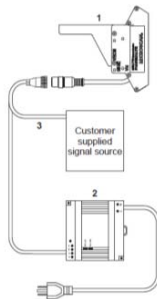

Figure B  
Pharmalite Illuminator  
with customer supplied  
dimming or on/off  
signal source

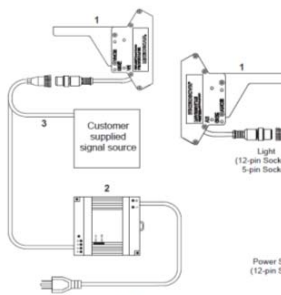

Figure C  
Pharmalite Illuminator  
with customer supplied  
strobe trigger signal source

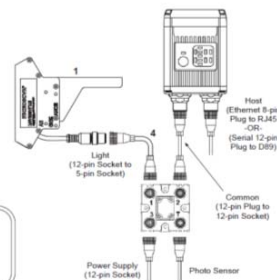

Figure D  
Pharmalite Illuminator with  
QX-1 Interface Device

# MICROSCAN.

## NERLITE® SMART DOAL® LIGHTS

NERLITE® Smart Series DOAL lights use MAX Light LEDs and feature an integrated strobe controller for easy integration in industrial applications.



Best Sellers
1) NER-011660500G
2) NER-011660700G

**\*\*Important Pricing Discount Note\*\*** Product discounts are applied based on the Product TYPE code shown in the TYPE column below.

Product Type codes are defined as: P = PRODUCT Discount, A = ACCESSORY Discount.

A Product Type code modified with L signifies Legacy Status (refer to Legacy section of this catalog).

Refer to your Partner Agreement for the actual discount percentage by Product Type.

25 mm			
Part Number	Description	List Price	Type
NER-011660400G	Smart Series DOAL 25 mm Red M12 Connector	€ 468	P
NER-011660410G	Smart Series DOAL 25 mm White M12 Connector	€ 536	P
NER-011660420G	Smart Series DOAL 25 mm Blue M12 Connector	€ 556	P
NER-011660430G	Smart Series DOAL 25 mm Infrared M12 Connector	€ 668	P
50 mm			
NER-011660500G	Smart Series DOAL 50 mm Red M12 Connector	€ 576	P
NER-011660510G	Smart Series DOAL 50 mm White M12 Connector	€ 812	P
NER-011660520G	Smart Series DOAL 50 mm Blue M12 Connector	€ 846	P
NER-011660530G	Smart Series DOAL 50 mm Infrared M12 Connector	€ 910	P
75 mm			
NER-011660600G	Smart Series DOAL 75 mm Red M12 Connector	€ 1,118	P
NER-011660610G	Smart Series DOAL 75 mm White M12 Connector	€ 1,390	P
NER-011660620G	Smart Series DOAL 75 mm Blue M12 Connector	€ 1,390	P
NER-011660630G	Smart Series DOAL 75 mm Infrared M12 Connector	€ 1,446	P
100 mm			
NER-011660700G	Smart Series DOAL 100 mm Red M12 Connector	€ 1,576	P
NER-011660710G	Smart Series DOAL 100 mm White M12 Connector	€ 2,144	P
NER-011660720G	Smart Series DOAL 100 mm Blue M12 Connector	€ 2,144	P
NER-011660730G	Smart Series DOAL 100 mm Infrared M12 Connector	€ 2,236	P
Power Supply (25mm to 50mm)			
Part Number	Description	List Price	Type
NER-011504100	DSP60 24VDC 2.5A DIN Mount Power Supply	€ 210	A
Power Supply (50mm to 100mm)			
97-000006-01	DSP100 24VDC 4.2A DIN Mount Power Supply	€ 260	A
Power Supply Cordsets and Cables			
Part Number	Description	List Price	Type
NER-030028300	AC Power Cord for DSPxx Power Supply U.S.	€ 62	A
NER-030028400	AC Power Cord for DSPxx Power Supply EU	€ 62	A
NER-030028500	AC Power Cord for DSPxx Power Supply UK	€ 62	A
61-000186-01	Cable M12 5-Pin Socket-to-Flying Leads 3 m.	€ 72	A
61-000218-01	QX Cordset Smart Series Light-to-QX-1 Strobe NPN	€ 132	A
61-000207-01	QX Cordset Smart Series Light-to-QX-1 Continuous ON/OFF	€ 232	A
61-000204-01	QX Cordset Smart Series Light-to-QX-1 Continuous Power	€ 206	A
61-000187-01	Cable M12 5-Pin Socket-to-Flying Leads 5 m.	€ 126	A

## DOAL Camera Mounting Brackets

Part Number	Description	List Price	Type
99-000055-01	Bracket Smart Series DOAL-50 mm-to-Vision MINI & MINI Hawk	€ 256	A
99-000056-01	Bracket Smart Series DOAL-50 mm-to-Vision HAWK & QX Hawk	€ 256	A
99-000057-01	Bracket Smart Series DOAL-75 mm-to-Vision MINI & MINI Hawk	€ 256	A
99-000058-01	Bracket Smart Series DOAL-75 mm-to-Vision HAWK & QX Hawk	€ 256	A
99-000059-01	Bracket Smart Series DOAL-100 mm-to-Vision MINI & MINI Hawk	€ 256	A
99-000060-01	Bracket Smart Series DOAL-100 mm-to-Vision HAWK & QX Hawk	€ 256	A
99-000061-01	Bracket Smart Series DOAL-50/70/100 mm-to-C-Mount Vision HAWK and QX Hawk	€ 256	A
99-000063-01	Bracket Smart Series DOAL-to-GigE Camera	€ 312	A

## Tech Reference DOAL Lights

Hardware Required		
Item	Description	Part Number
1	Smart Series DOAL Lights	NER-011660XXXG
2	Power Supply DSP60 24VDC 2.5A DIN Mount	NER-011504100
2	Power Supply DSP100 24VDC 4.2A DIN Mount	97-000006-01
3	Cable 5 Pin M12 Female To Flying Leads, 3M	61-000186-01
3	Cable 5 Pin M12 Female To Flying Leads, 5M	61-000187-01
4	QX Cordset, Smart Series to QX-1 Continuous	61-000204-01
4	QX Cordset, Smart Series to QX-1, Continuous On/Off	61-000207-01
4	QX Cordset, Smart Series to QX-1 Strobe, NPN	61-000218-01
5	QX-1 Interface Device	98-000103-02

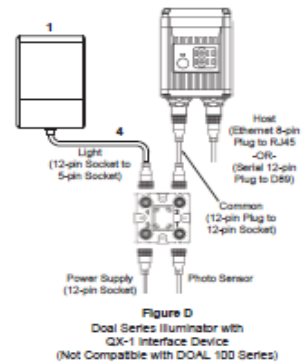
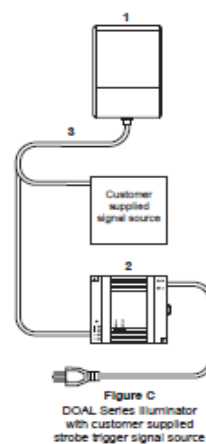
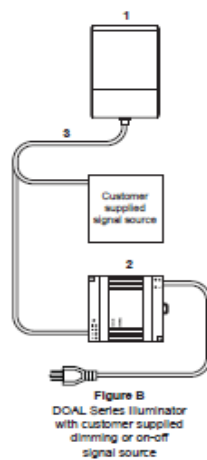
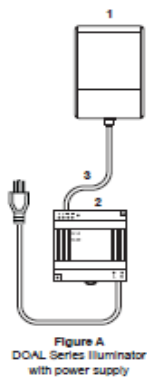
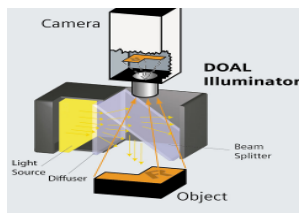

5

## NERLITE® SMART RING LIGHTS

NERLITE® Smart Series Ring Lights use MAX Light LEDs and feature an integrated strobe controller for easy integration in industrial applications.



Best Sellers
1) NER-011660810G
2) NER-011661110G

**\*\*Important Pricing Discount Note\*\*** Product discounts are applied based on the Product TYPE code shown in the TYPE column below.

Product Type codes are defined as: P = PRODUCT Discount, A = ACCESSORY Discount.

A Product Type code modified with L signifies Legacy Status (refer to Legacy section of this catalog).

Refer to your Partner Agreement for the actual discount percentage by Product Type.

60 mm		List Price	Type
Part Number	Description		
NER-011660800G	Smart Series Ring 60 mm Red M12 Connector	€ 420	P
NER-011660810G	Smart Series Ring 60 mm White M12 Connector	€ 496	P
NER-011660820G	Smart Series Ring 60 mm Blue M12 Connector	€ 486	P
NER-011660830G	Smart Series Ring 60 mm Infrared M12 Connector	€ 438	P
NER-011660840G	Smart Series Ring 60 mm Ultraviolet M12 Connector	€ 496	P
70 mm			
NER-011660900G	Smart Series Ring 70 mm Red M12 Connector	€ 448	P
NER-011660910G	Smart Series Ring 70 mm White M12 Connector	€ 522	P
NER-011660920G	Smart Series Ring 70 mm Blue M12 Connector	€ 522	P
NER-011660930G	Smart Series Ring 70 mm Infrared M12 Connector	€ 468	P
NER-011660940G	Smart Series Ring 70 mm Ultraviolet M12 Connector	€ 522	P
100 mm			
NER-011661100G	Smart Series Ring 100 mm Red M12 Connector	€ 596	P
NER-011661110G	Smart Series Ring 100 mm White M12 Connector	€ 700	P
NER-011661120G	Smart Series Ring 100 mm Blue M12 Connector	€ 692	P
NER-011661130G	Smart Series Ring 100 mm Infrared M12 Connector	€ 626	P
NER-011661140G	Smart Series Ring 100 mm Ultraviolet M12 Connector	€ 700	P
Power Supply			
Part Number	Description	List Price	Type
NER-011504100	DSP60 24VDC 2.5A DIN Mount Power Supply	€ 210	A
97-000006-01	DSP100 24VDC 4.2A DIN Mount Power Supply	€ 260	A
Power Supply Cordsets			
Part Number	Description	List Price	Type
NER-030028300	AC Power Cord for DSPxx Power Supply U.S.	€ 62	A
NER-030028400	AC Power Cord for DSPxx Power Supply EU	€ 62	A
NER-030028500	AC Power Cord for DSPxx Power Supply UK	€ 62	A
61-000186-01	Cable M12 5-Pin Socket-to-Flying Leads 3 m.	€ 72	A
61-000187-01	Cable M12 5-Pin Socket-to-Flying Leads 5 m.	€ 126	A
61-000218-01	QX Cordset Smart Series Light-to-QX-1 Strobe NPN	€ 132	A
61-000207-01	QX Cordset Smart Series Light-to-QX-1 Continuous ON/OFF	€ 232	A
61-000204-01	QX Cordset Smart Series Light-to-QX-1 Continuous Power	€ 206	A

# NERLITE® RING LIGHT ACCESSORIES

Note: For mounting and alternate focused optics use the following

60 mm Mounts and Optics			
Part Number	Description	List Price	Type
99-000026-01	R-60 Focusing Lens Focal Length = 70 mm	€ 152	A
99-000026-02	R-60 Focusing Lens Focal Length = 102 mm	€ 152	A
99-000026-03	R-60 Focusing Lens Focal Length = 127 mm	€ 152	A
99-000025-01	R-60 Lens Adapter 25.5 mmx0.50 mm	€ 66	A
99-000025-02	R-60 Lens Adapter 27.0 mmx0.50 mm	€ 66	A
99-000025-03	R-60 Lens Adapter 30.5 mmx0.50 mm	€ 66	A
99-000025-04	R-60 Lens Adapter 40.5 mmx0.50 mm	€ 66	A
99-000025-05	R-60 Lens Adapter 46.0 mmx0.75 mm	€ 66	A
70 mm Mounts and Optics			
99-000028-01	R-70 Focusing Lens Focal Length = 70 mm	€ 152	A
99-000028-02	R-70 Focusing Lens Focal Length = 102 mm	€ 152	A
99-000028-03	R-70 Focusing Lens Focal Length = 127 mm	€ 152	A
99-000027-01	R-70 Lens Adapter 25.5 mmx0.50 mm	€ 66	A
99-000027-02	R-70 Lens Adapter 27.0 mmx0.50 mm	€ 66	A
99-000027-03	R-70 Lens Adapter 30.5 mmx0.50 mm	€ 66	A
99-000027-04	R-70 Lens Adapter 40.5 mmx0.50 mm	€ 66	A
100 mm Mounts and Optics			
99-000030-01	R-100 Focusing Lens Focal Length = 70 mm	€ 152	A
99-000030-02	R-100 Focusing Lens Focal Length = 102 mm	€ 152	A
99-000030-03	R-100 Focusing Lens Focal Length = 127 mm	€ 152	A
99-000030-04	R-100 Focusing Lens Focal Length = 152 mm	€ 152	A
99-000029-01	R-100 Lens Adapter 25.5 mmx0.50 mm	€ 66	A
99-000029-02	R-100 Lens Adapter 27.0 mmx0.50 mm	€ 66	A
99-000029-03	R-100 Lens Adapter 30.5 mmx0.50 mm	€ 66	A
99-000029-04	R-100 Lens Adapter 40.5 mmx0.50 mm	€ 66	A
Ring Light Camera Mounting Brackets			
Part Number	Description	List Price	Type
99-000050-01	Bracket Smart Series Ring-100 mm-to-Vision HAWK & QX Hawk	€ 138	A
99-000052-01	Bracket Smart Series Ring-60/70 mm-to-Vision HAWK & QX Hawk	€ 138	A
99-000053-01	Bracket Smart Series Ring-60/70 mm-to-Vision MINI & MINI Hawk	€ 138	A
99-000054-01	Bracket Smart Series Ring-100 mm-to-Vision MINI & MINI Hawk	€ 138	A
99-000049-01	Bracket Smart Series Ring-100 mm-to-C-Mount Vision HAWK & QX Hawk	€ 138	A
99-000051-01	Bracket Smart Series Ring-R-60/70-to-C-Mount Vision HAWK & QX Hawk	€ 138	A
99-000062-01	Bracket Smart Series Ring-60/70 mm-to-GigE Camera	€ 164	A
99-000064-01	Bracket Smart Series Ring-100 mm-to-GigE Camera	€ 172	A

## Tech Reference *Ring Lights*

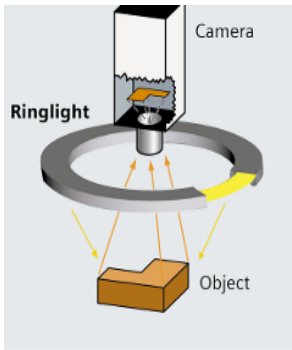

Hardware Required		
Item	Description	Part Number
1	Smart Series Ring Lights	Various
2	Power Supply DSP60 24VDC 2.5A DIN Mount	NER-011504100
2	Power Supply DSP100 24VDC 4.2A DIN Mount	97-000006-01
3	Cable 5 Pin M12 Female To Flying Leads, 3M	61-000186-01
3	Cable 5 Pin M12 Female To Flying Leads, 5M	61-000187-01
4	QX Cordset, Smart Series to QX-1 Continuous	61-000204-01
4	QX Cordset, Smart Series to QX-1, Continuous On/Off	61-000207-01
4	QX Cordset, Smart Series to QX-1 Strobe, NPN	61-000218-01
5	QX-1 Interface Device	98-000103-02

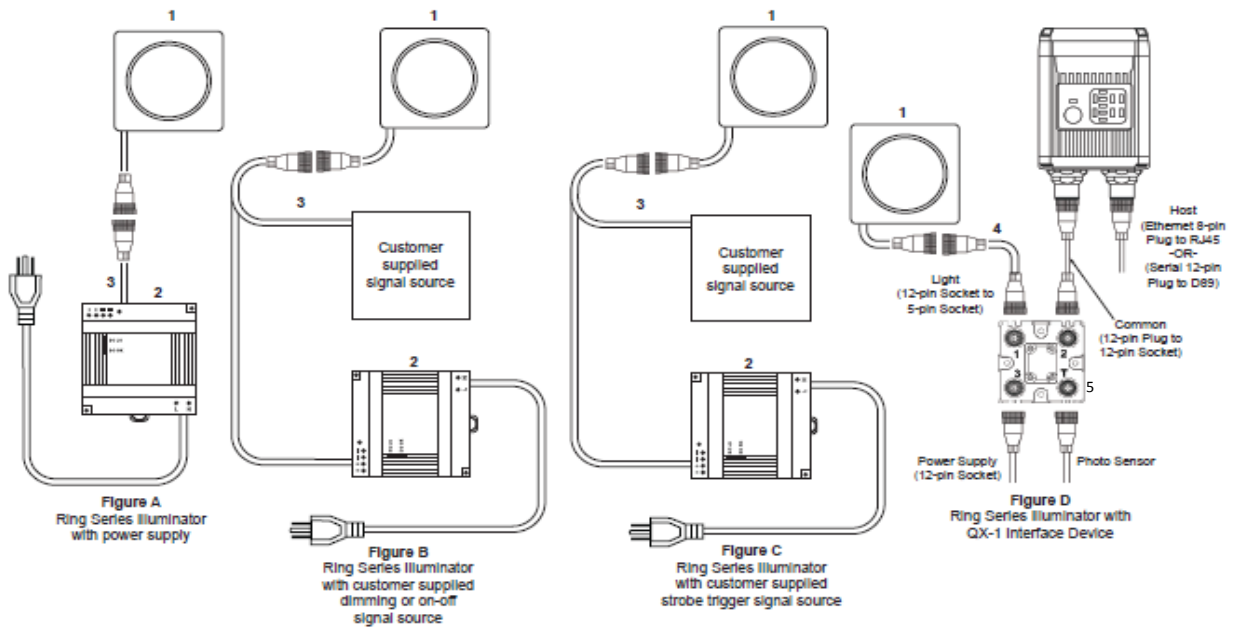

# MICROSCAN.

## MAX Lights

*MAX lights are designed to provide high intensity illumination over a large area. MAX lights have an industrial design with IP67 enclosure and built in controller.*



Best Sellers	
1)	NER-011660211G
2)	NER-011660311G

**\*\*Important Pricing Discount Note\*\*** Product discounts are applied based on the Product TYPE code shown in the TYPE column below.

Product Type codes are defined as: P = PRODUCT Discount, A = ACCESSORY Discount.

A Product Type code modified with L signifies Legacy Status (refer to Legacy section of this catalog).

Refer to your Partner Agreement for the actual discount percentage by Product Type.

### MAX 300 mm

Part Number	Description	List Price	Type
NER-011660300G	Smart Series MAX Narrow 300 mm Red M12 Connector	€ 840	P
NER-011660310G	Smart Series MAX Narrow 300 mm White M12 Connector	€ 886	P
NER-011660301G	Smart Series MAX Wide 300 mm Red M12 Connector	€ 840	P
NER-011660311G	Smart Series MAX Wide 300 mm White M12 Connector	€ 886	P

### MAX 100 mm

Part Number	Description	List Price	Type
NER-011660200G	Smart Series MAX Narrow 100 mm Red M12 Connector	€ 654	P
NER-011660210G	Smart Series MAX Narrow 100 mm White M12 Connector	€ 700	P
NER-011660201G	Smart Series MAX Wide 100 mm Red M12 Connector	€ 654	P
NER-011660211G	Smart Series MAX Wide 100 mm White M12 Connector	€ 700	P

### MAX 45 mm

Part Number	Description	List Price	Type
NER-011660100G	Smart Series MAX Narrow 45 mm Red M12 Connector	€ 374	P
NER-011660110G	Smart Series MAX Narrow 45 mm White M12 Connector	€ 420	P
NER-011660101G	Smart Series MAX Wide 45 mm Red M12 Connector	€ 374	P
NER-011660111G	Smart Series MAX Wide 45 mm White M12 Connector	€ 420	P

### MAX Cables (Not included with light)

Part Number	Description	List Price	Type
61-000184-01	Cable M12 5-Pin Plug-to-M12 5-Pin Socket 1 m. Shielded (for Daisy Chain)	€ 66	A
61-000185-01	Cable M12 5-Pin Plug-to-M12 5-Pin Socket 3 m. Shielded (for Daisy Chain)	€ 76	A
61-000204-01	QX Cordset Smart Series Light-to-QX-1 Continuous Power	€ 206	A
61-000218-01	QX Cordset Smart Series Light-to-QX-1 Strobe NPN	€ 132	A
61-000207-01	QX Cordset Smart Series Light-to-QX-1 Continuous ON/OFF	€ 232	A
61-000186-01	Cable M12 5-Pin Socket-to-Flying Leads 3 m.	€ 72	A
61-000187-01	Cable M12 5-Pin Socket-to-Flying Leads 5 m.	€ 126	A

### Power Supply

Part Number	Description	List Price	Type
NER-011504100	DSP60 24VDC 2.5A DIN Mount Power Supply	€ 210	A
97-000006-01	DSP100 24VDC 4.2A DIN Mount Power Supply	€ 260	A

### Power Supply Cordsets

Part Number	Description	List Price	Type
NER-030028300	AC Power Cord for DSPxx Power Supply U.S.	€ 62	A
NER-030028400	AC Power Cord for DSPxx Power Supply EU	€ 62	A
NER-030028500	AC Power Cord for DSPxx Power Supply UK	€ 62	A

### Camera Mounting Brackets

Part Number	Description	List Price	Type
98-000268-01	Accessory Bracket MAX 300 Smart Light-to-C-Mount Vision HAWK & QX Hawk	€ 596	A

## Tech Reference *MAX Lights*

Hardware Required		
Item	Description	Part Number
1	Smart Series MAX Light	NER-011660XXXG
2	Power Supply DSP60 24VDC 2.5A DIN Mount	NER-011504100
2	Power Supply DSP100 24VDC 4.2A DIN Mount	97-000006-01
3	Cable 5 Pin M12 Female To Flying Leads, 3M	61-000186-01
3	Cable 5 Pin M12 Female To Flying Leads, 5M	61-000187-01
4	Cable, 5P M12 Male to 5P M12 Female, 1M	61-000184-01
4	Cable, 5P M12 Male to 5P M12 Female, 3M	61-000185-01
5	QX Cordset, Smart Series to QX-1 Continuous	61-000204-01
5	QX Cordset, Smart Series to QX-1, Continuous On/Off	61-000207-01
5	QX Cordset, Smart Series to QX-1 Strobe, NPN	61-000218-01
6	QX-1 Interface Device	98-000103-02

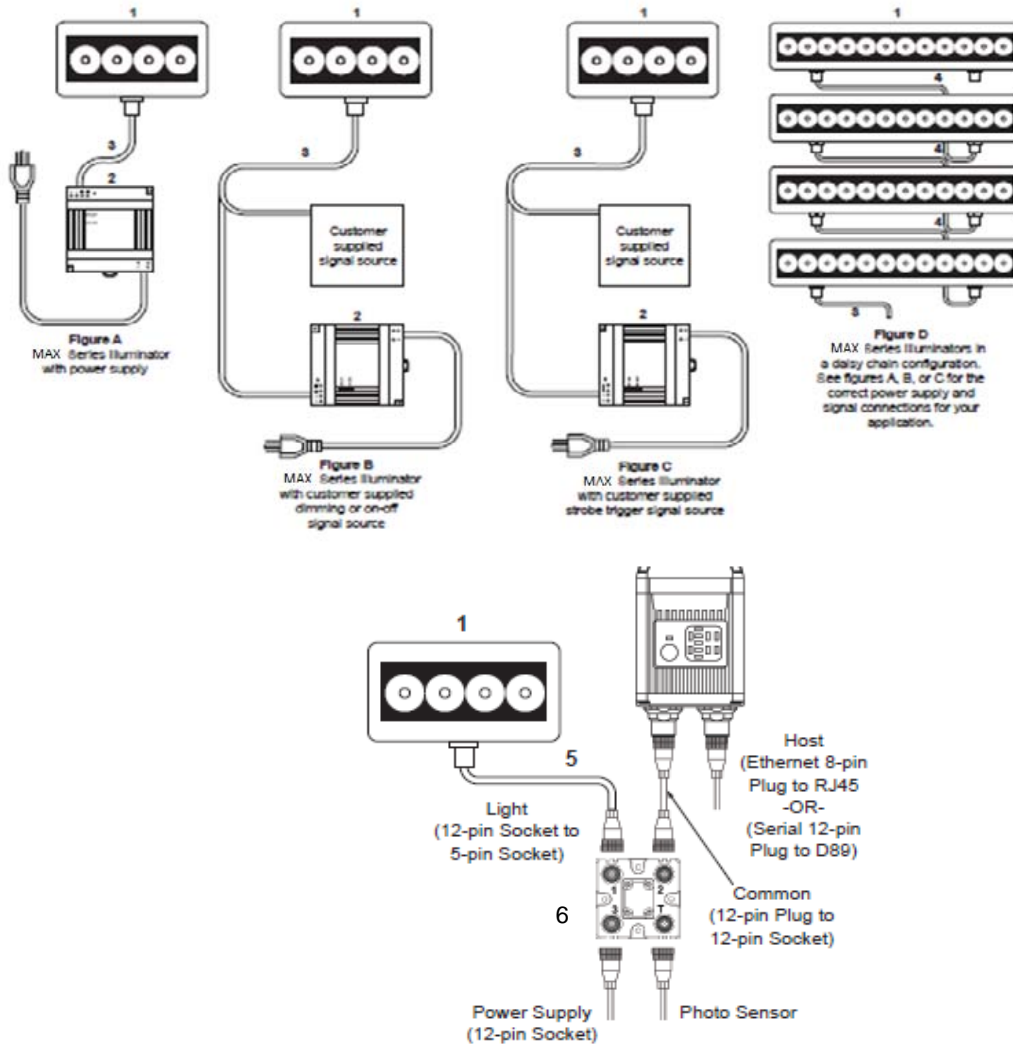

**Figure E**  
MAX Series Illuminators with QX-1 Interface Device  
Note: Figure E is not compatible with daisy chaining. Powering more than one MAX light via the QX-1 will exceed the QX-1's current capability.

# MICROSCAN.

## AREA ARRAYS

Area Arrays are designed for non-specular surface lighting in applications that demand economical solutions.



Best Sellers	
1)	NER-011652115
2)	NER-011904201

**\*\*Important Pricing Discount Note\*\*** Product discounts are applied based on the Product TYPE code shown in the TYPE column below.

Product Type codes are defined as: P = PRODUCT Discount, A = ACCESSORY Discount.

A Product Type code modified with L signifies Legacy Status (refer to Legacy section of this catalog).

Refer to your Partner Agreement for the actual discount percentage by Product Type.

Area Arrays 50X50 Continuous			
NER-011652115	NERLITE AR-50x50-HO Red Non-Diffuse Array 24V Continuous Open-End Cable	€	362 P
NER-011652114	NERLITE AR-50x50-HO White Non-Diffuse Array 24V Continuous Open-End Cable	€	472 P
NER-011652138	NERLITE AR-50x50-HO Ultraviolet Array 24V Continuous Open-End Cable	€	472 P
Area Arrays 75X75 Continuous			
NER-011903401	NERLITE AR-75x75-HO Red Array 24V Continuous Open-End Cable	€	472 P
NER-011903502	NERLITE AR-75x75-HO White Array 24V Continuous Open-End Cable	€	732 P
NER-011652181	NERLITE AR-75x75-HO Ultraviolet Array 24V Continuous Open-End Cable	€	840 P
Area Arrays 100X100 Continuous			
NER-011904101	NERLITE AR-100x100-HO Red Array 24V Continuous Open-End Cable	€	768 P
NER-011904201	NERLITE AR-100x100-HO White Array 24V Continuous Open-End Cable	€	1,061 P
Area Arrays 50X200 Continuous			
NER-011650005	NERLITE AR-50x200-HO Red Non-Diffuse Array 24V Continuous Open-End Cable	€	924 P
NER-011650012	NERLITE AR-50x200-HO White Non-Diffuse Array 24V Continuous Open-End Cable	€	1,646 P
Power Supply/Controllers			
NER-011504100	DSP60 24VDC 2.5A DIN Mount Power Supply	€	210 A
98-000152-01*	NL-200 Lighting Controller (Front Panel Control Only)	€	884 A
98-000152-02*	NL-220 Lighting Controller (Ethernet Control Only)	€	1,274 A
98-000152-03*	NL-220F Lighting Controller (Ethernet Control Only with Fast Strobe Capability)	€	1,622 A
Power Supply Cordsets			
030-028300	AC Power Cord for DSPxx Power Supply U.S.	€	49 A
030-028400	AC Power Cord for DSPxx Power Supply EU	€	49 A
030-028500	AC Power Cord for DSPxx Power Supply UK	€	49 A

\*Note: Can be used to control intensity of continuous lights

### Tech Reference Arrays

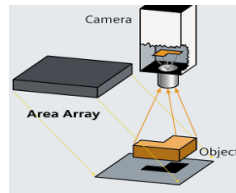
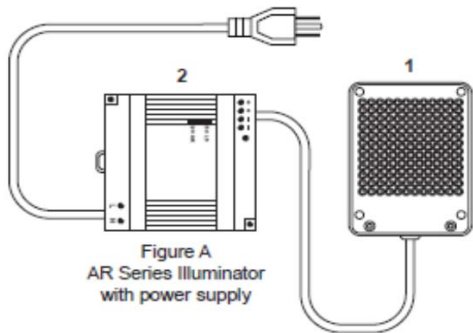

### Hardware Required

Item	Description	Part Number
1	AR Series Illuminators	NER-011XXXXXX
2	Power Supply DSP60 24VDC 2.5A DIN Mount	NER-011504100

## NERLITE® BACKLIGHTS with "Edge-to-Edge" Lighting

Backlights provide sharp contrast to outline a parts shape, hide clear housings, and view openings such as drilled holes.



Best Sellers
1) NER-011659510G
2) NER-011659300G

**\*\*Important Pricing Discount Note\*\*** Product discounts are applied based on the Product TYPE code shown in the TYPE column below.

Product Type codes are defined as: P = PRODUCT Discount, A = ACCESSORY Discount.

A Product Type code modified with L signifies Legacy Status (refer to Legacy section of this catalog).

Refer to your Partner Agreement for the actual discount percentage by Product Type.

**Note: For basic applications continuous lights only require a light + power supply**

### Backlights 47X59 Continuous

Part Number	Description	List Price	Type
NER-011659300G	NERLITE 47x59 mm Red Backlight 24V Continuous 150 mm Cable M12	€ 528	P
NER-011659310G	NERLITE 47x59 mm White Backlight 24V Continuous 150 mm Cable M12	€ 668	P
NER-011659320G	NERLITE 47x59 mm Blue Backlight 24V Continuous 150 mm Cable M12	€ 668	P
NER-011659340G	NERLITE 47x59 mm Infrared Backlight 24V Continuous 150 mm Cable M12	€ 528	P

### Backlights 71X88 Continuous

NER-011659400G	NERLITE 71x88 mm Red Backlight 24V Continuous 150 mm Cable M12	€ 612	P
NER-011659410G	NERLITE 71x88 mm White Backlight 24V Continuous 150 mm Cable M12	€ 756	P
NER-011659420G	NERLITE 71x88 mm Blue Backlight 24V Continuous 150 mm Cable M12	€ 756	P
NER-011659440G	NERLITE 71x88 mm Infrared Backlight 24V Continuous 150 mm Cable M12	€ 612	P

### Backlights 100X100 Continuous

NER-011659500G	NERLITE 100x100 mm Red Backlight 24V Continuous 150 mm Cable M12	€ 654	P
NER-011659510G	NERLITE 100x100 mm White Backlight 24V Continuous 150 mm Cable M12	€ 840	P
NER-011659520G	NERLITE 100x100 mm Blue Backlight 24V Continuous 150 mm Cable M12	€ 840	P
NER-011659540G	NERLITE 100x100 mm Infrared Backlight 24V Continuous 150 mm Cable M12	€ 654	P

### Backlights 50X200 Continuous

NER-011659600G	NERLITE 50x200 mm Red Backlight 24V Continuous 150 mm Cable M12	€ 654	P
NER-011659610G	NERLITE 50x200 mm White Backlight 24V Continuous 150 mm Cable M12	€ 840	P
NER-011659620G	NERLITE 50x200 mm Blue Backlight 24V Continuous 150 mm Cable M12	€ 840	P
NER-011659640G	NERLITE 50x200 mm Infrared Backlight 24V Continuous 150 mm Cable M12	€ 654	P

### Power Supply Backlights Continuous

NER-011504100	DSP60 24VDC 2.5A DIN Mount Power Supply	€ 210	A
---------------	---	-------	---

### Power Supply Cordsets

NER-030028300	AC Power Cord for DSPxx Power Supply U.S.	€ 62	A
NER-030028400	AC Power Cord for DSPxx Power Supply EU	€ 62	A
NER-030028500	AC Power Cord for DSPxx Power Supply UK	€ 62	A

### Backlight Accessories

NER-030029100	Cable NERLITE 4.5M M12 5-Pin-to-Open-End Cable	€ 56	A
---------------	--	------	---

**Note: For high speed or high intensity applications strobed lights require a light + controller + power supply**

<b>Backlights 47X59 Strobed</b>			
Part Number	Description	List Price	Type
NER-011659301G	NERLITE 47x59 mm, Red, Backlight, Current Control, 150 mm, Cable M12	€ 528	P
NER-011659311G	NERLITE 47x59 mm, White, Backlight, Current Control, 150 mm, Cable M12	€ 668	P
NER-011659321G	NERLITE 47x59 mm, Blue, Backlight, Current Control, 150 mm, Cable M12	€ 668	P
NER-011659341G	NERLITE 47x59 mm, Infrared, Backlight, Current Control, 150 mm, Cable M12	€ 528	P
<b>Backlights 71X88 Strobed</b>			
NER-011659401G	NERLITE 71x88 mm, Red, Backlight, Current Control, 150 mm, Cable M12	€ 612	P
NER-011659411G	NERLITE 71x88 mm, White, Backlight, Current Control, 150 mm, Cable M12	€ 756	P
NER-011659421G	NERLITE 71x88 mm, Blue, Backlight, Current Control, 150 mm, Cable M12	€ 756	P
NER-011659441G	NERLITE 71x88 mm, Infrared, Backlight, Current Control, 150 mm, Cable M12	€ 612	P
<b>Backlights 100X100 Strobed</b>			
NER-011659501G	NERLITE 100x100 mm, Red, Backlight, Current Control, 150 mm, Cable M12	€ 654	P
NER-011659511G	NERLITE 100x100 mm, White, Backlight, Current Control, 150 mm, Cable M12	€ 840	P
NER-011659521G	NERLITE 100x100 mm, Blue, Backlight, Current Control, 150 mm, Cable M12	€ 840	P
NER-011659541G	NERLITE 100x100 mm, Infrared, Backlight, Current Control, 150 mm, Cable M12	€ 654	P
<b>Backlights 50X200 Strobed</b>			
NER-011659601G	NERLITE 50x200 mm, Red, Backlight, Current Control, 150 mm, Cable M12	€ 654	P
NER-011659611G	NERLITE 50x200 mm, White, Backlight, Current Control, 150 mm, Cable M12	€ 840	P
NER-011659621G	NERLITE 50x200 mm, Blue, Backlight, Current Control, 150 mm, Cable M12	€ 840	P
NER-011659641G	NERLITE 50x200 mm, Infrared, Backlight, Current Control, 150 mm, Cable M12	€ 654	P
<b>Power Supply/Controllers</b>			
NER-011504100	DSP60 24VDC 2.5A DIN Mount Power Supply	€ 210	A
98-000152-01*	NL-200 Lighting Controller (Front Panel Control Only)	€ 884	A
98-000152-02*	NL-220 Lighting Controller (Ethernet Control Only)	€ 1,274	A
98-000152-03*	NL-220F Lighting Controller (Ethernet Control Only with Fast Strobe Capability)	€ 1,622	A

\*Note: Can also be used to control intensity of continuous lights

<b>Power Supply Cordsets</b>			
030-028300	AC Power Cord for DSPxx Power Supply, U.S.	€ 49	A
030-028400	AC Power Cord for DSPxx Power Supply, EU	€ 49	A
030-028500	AC Power Cord for DSPxx Power Supply, UK	€ 49	A

<b>Backlight Accessories</b>			
NER-030029100	Cable, NERLITE, 4.5M, M12 5-Pin-to-Open-End Cable	€ 56	A

Part Number	Description	Item
NER-011659XXXG	Edge to Edge Backlight Series	1
NER-011504100	DSP60 24VDC 2.5A DIN Mount Power Supply	2
98-000152-0X	NL200 Lighting Controller	3
NER-030029100	Cable, NERLITE, 4.5M, M12 5-Pin-to-Open-End Cable	4

## Tech Reference Backlights

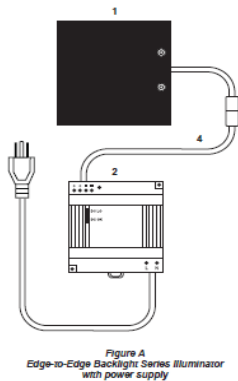
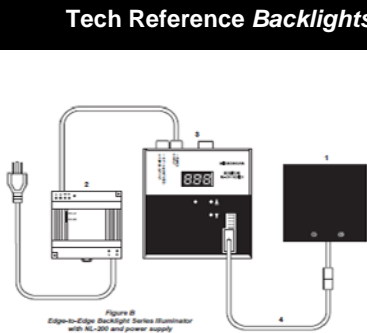

# MICROSCAN.

## NERLITE® LARGE BACKLIGHTS

Backlights provide sharp contrast to outline a parts shape, hide clear housings, and view openings such as drilled holes.

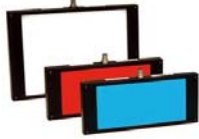

Note: For all applications large backlights require a light + controller + power supply

Backlights 100X200 Continuous/Strobed			List Price	Type
Part Number	Description			
NER-011659700G	NERLITE 100x200 mm, Red, Backlight Current Control, M12 Connector		€ 1,124	P
NER-011659710G	NERLITE 100x200 mm, White, Backlight Current Control, M12 Connector		€ 1,216	P
NER-011659720G	NERLITE 100x200 mm, Blue, Backlight Current Control, M12 Connector		€ 1,216	P
NER-011659740G	NERLITE 100x200 mm, Infrared, Backlight Current Control, M12 Connector		€ 1,124	P
Backlights 150X200 Continuous/Strobed				
NER-011659800G	NERLITE 150x200 mm, Red, Backlight, Current Control, M12 Connector		€ 1,236	P
NER-011659810G	NERLITE 150x200 mm, White, Backlight, Current Control, M12 Connector		€ 1,330	P
NER-011659820G	NERLITE 150x200 mm, Blue, Backlight, Current Control, M12 Connector		€ 1,330	P
NER-011659840G	NERLITE 150x200 mm, Infrared, Backlight, Current Control, M12 Connector		€ 1,236	P
Backlights 200X250 & 150X200 IR Continuous/Strobed				
NER-011659900G	NERLITE 200x250 mm, Red, Backlight, Current Control, M12 Connector		€ 1,488	P
NER-011659910G	NERLITE 200x250 mm, White, Backlight, Current Control, M12 Connector		€ 1,580	P
NER-011659920G	NERLITE 200x250 mm, Blue, Backlight, Current Control, M12 Connector		€ 1,580	P
NER-011659940G	NERLITE 200x250 mm, Infrared, Backlight, Current Control, M12 Connector		€ 1,488	P
Power Supply/Controllers				
NER-011504100	DSP60 24VDC 2.5A DIN Mount Power Supply		€ 210	A
98-000152-01*	NL-200 Lighting Controller (Front Panel Control Only)		€ 884	A
98-000152-02*	NL-220 Lighting Controller (Ethernet Control Only)		€ 1,274	A
98-000152-03*	NL-220F Lighting Controller (Ethernet Control Only with Fast Strobe Capability)		€ 1,622	A
Power Supply Cordsets				
030-028300	AC Power Cord for DSPxx Power Supply, U.S.		€ 49	A
030-028400	AC Power Cord for DSPxx Power Supply, EU		€ 49	A
030-028500	AC Power Cord for DSPxx Power Supply, UK		€ 49	A
Backlight Accessories				
NER-030029100	Cable, NERLITE, 4.5M, M12 5-Pin-to-Open-End Cable		€ 56	A

Part Number	Description	Item
NER-011659XXXG	Large Backlight	1
NER-011504100	DSP60 24VDC 2.5A DIN Mount Power Supply	2
98-000152-0X	NL200 Lighting Controller	3
NER-030029100	Cable, NERLITE, 4.5M, M12 5-Pin-to-Open-End Cable	4

### Tech Reference Backlights

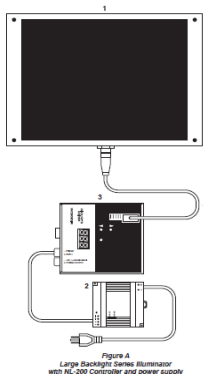

# MICROSCAN.

## NERLITE® DARKFIELD LIGHTS

NERLITE® Darkfield Lights enhance the contrast of surface features (e.g. embossed or engraved marks).



Best Sellers	
1)	NER-011609311
2)	NER-011601521

**\*\*Important Pricing Discount Note\*\*** Product discounts are applied based on the Product TYPE code shown in the TYPE column below.

Product Type codes are defined as: P = PRODUCT Discount, A = ACCESSORY Discount.

A Product Type code modified with L signifies Legacy Status (refer to Legacy section of this catalog).

Refer to your Partner Agreement for the actual discount percentage by Product Type.

Darkfield 50 Continuous			
Part Number	Description	List Price	Type
NER-011609311	NERLITE DF-50 Red Non-Diffuse Dark Field 24V Continuous Open-End Cable	€ 462	P
NER-011609321	NERLITE DF-50 White Non-Diffuse Dark Field 24V Continuous Open-End Cable	€ 530	P
Darkfield 100 Continuous			
NER-011601520	NERLITE DF-100-1 Red Non-Diffuse Dark Field 24V Continuous Open-End Cable	€ 526	P
NER-011601521	NERLITE DF-100-1 Red Diffuse Dark Field 24V Continuous Open-End Cable	€ 526	P
Darkfield 150 Continuous			
NER-011600020	NERLITE DF-150-1 Red Non-Diffuse Dark Field 24V Continuous Open-End Cable	€ 748	P
NER-011600031	NERLITE DF-150-1 White Non-Diffuse Dark Field 24V Continuous Open-End Cable	€ 748	P
NER-011600021	NERLITE DF-150-1 Red Diffuse Dark Field 24V Continuous Open-End Cable	€ 748	P
NER-011600041	NERLITE DF-150-1 White Diffuse Dark Field 24V Continuous Open-End Cable	€ 748	P
NER-011600208	NERLITE DF-150-3 Red Non-Diffuse Dark Field 24V Continuous Open-End Cable	€ 1,026	P
NER-011600206	NERLITE DF-150-3 White Non-Diffuse Dark Field 24V Continuous Open-End Cable	€ 1,306	P
Darkfield 200 Continuous			
NER-011603300	NERLITE DF-200-1 Red Diffuse Dark Field 24V Continuous Open-End Cable	€ 1,492	P
Power Supply Darkfields Continuous			
Part Number	Description	List Price	Type
NER-011504100	DSP60 24VDC 2.5A DIN Mount Power Supply	€ 210	A
Power Supply Cordsets			
Part Number	Description	List Price	Type
NER-030028300	AC Power Cord for DSPxx Power Supply U.S.	€ 62	A
NER-030028400	AC Power Cord for DSPxx Power Supply EU	€ 62	A
NER-030028500	AC Power Cord for DSPxx Power Supply UK	€ 62	A

### Tech Reference Dark Field Lights

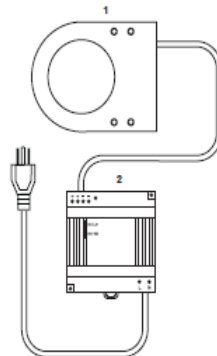
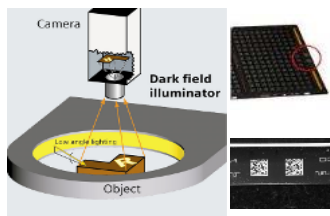

Figure A  
Dark Field Series Illuminator  
with power supply

### Hardware Required

Item	Description	Part Number
1	DF Series Illuminators	NER-01160XXXX
2	Power Supply DSP60 24VDC 2.5A DIN Mount	NER-011504100

# MICROSCAN.

## Product Demonstration Kits



For flexibility, many Microscan Demonstration Kits do not contain scanners, readers or cameras. These are indicated by \* in the part number listing below and require a separate purchase of the desired reader or camera.

Demo Kits - Scanner / Camera Not Included*		
Part Number	Description	List Price
98-000102-01	Demo Kit QX-830/QX-870	€ 596
98-000090-03	Demo Kit MS-890	€ 596
98-000086-02	Demo Kit MINI Hawk	€ 656
98-000149-01	Demo Kit QX Hawk	€ 596
98-000095-02	Demo Kit MS-Connect 210	€ 896
98-000215-01	Demo Kit AV Supports Vision MINI & Vision HAWK (Cameras Not Included)	€ 596
98-000216-01	NERLITE Smart Series Demo Kit (Lights Not Included)	€ 500
98-000199-01*	VS GigE Demo Kit License Key Camera Not Included Power Supply Cables Lens	€ 3,506

Print Quality Inspection Systems

\* GigE cameras purchased in conjunction with a GigE Demo Kit are discounted 30%.

Demo Kits - Scanner / Camera Included**		
Part Number	Description	List Price
98-000097-02	MS-1 Demo Kit (Contains One HD MS-1 & One LD MS-1)	€ 296
98-000139-01	VS GigE Demo Kit License Key CMG03 Power Supply Cables Lens	€ 4,236
98-000207-01	NERLITE Starter Kit (Lights Not Included)	€ 300
98-000224-01	MS-2D Demo Kit USB	€ 600
98-000224-02	MS-2D Demo Kit Serial	€ 600
98-000264-01	Demo Kit HS-21 & HS-41X USB 2 6 ft. Strt. USB Cables 1 8 ft. Serial Cable	€ 960

\*\* No separate reader purchase required. These kits are discounted 25%.

NOTE: Demo kit is not available for Mobile Hawk. A reader, specifically purchased as a demo unit will be discounted 50%.

### MicroHAWK Demo Kit



#### MicroHAWK Demo Kit Contents:

Cables: Micro-USB, PWR-Serial I/O, Ethernet  
 Power Supply, Symbol Card, Setup Guide  
 User chooses the ID or MV Cameras separately at 80% discount  
 1ea, MicroHAWK 20, 30, and 40

# MICRO HAWK

Demo Kits - MicroHAWK		
Part Number	Description	List Price
98-9000039-03	DEMO KIT MICROHAWK (NO UNITS)	€ 632

Software/Manuals		
Part Number	Description	List Price
37-000010-01*	Tools Drive, User Documentation, Software	€ 30

\* 1 free per order.

## Legacy Products

**Note: These products are not recommended for new applications, but are still actively shipping and supported.**

**\*\*Important Pricing Discount Note\*\*** Product discounts are applied based on the Product TYPE code shown in the TYPE column below.

Product Type codes are defined as: P = PRODUCT Discount, A = ACCESSORY Discount.

A Product Type code modified with L signifies Legacy Status (refer to Legacy section of this catalog).

Refer to your Partner Agreement for the actual discount percentage by Product Type.



### MS-4 Ultra-Compact Barcode Imagers

Part Number	Description	List Price	Type
FIS-0004-0001G	MS-4 Imager SD RS-232 5VDC	€ 1,022	LP
FIS-0004-0002G	MS-4 Imager LD RS-232 5VDC	€ 1,022	LP
FIS-0004-0003G	MS-4 Imager SD USB	€ 1,022	LP
FIS-0004-0004G	MS-4 Imager LD USB	€ 1,022	LP

USB cable terminated with USB type A connector.



### MS-4X Ultra-Compact DPM Imagers

Part Number	Description	List Price	Type
FIS-0004-2001G	MS-4X Imager SD X-Mode RS-232 5VDC	€ 1,208	LP
FIS-0004-2002G	MS-4X Imager LD X-Mode RS-232 5VDC	€ 1,208	LP
FIS-0004-2003G	MS-4X Imager SD X-Mode USB 5VDC	€ 1,208	LP
FIS-0004-2004G	MS-4X Imager LD X-Mode USB 5VDC	€ 1,208	LP
FIS-0004-2005G	MS-4X Imager 2D SD DPM X-Mode USB with I/O 5VDC	€ 1,208	LP
FIS-0004-2006G	MS-4X Imager 2D LD DPM X-Mode USB with I/O 5VDC	€ 1,208	LP

USB cable terminated with USB type A connector.



### MS-4Xi Ultra-Compact Ethernet Imagers

Part Number	Description	List Price	Type
FIS-1004-1210G	MS-4Xi Imager SD Ethernet 24VDC	€ 1,488	LP
FIS-1004-1110G	MS-4Xi Imager LD Ethernet 24VDC	€ 1,488	LP



### MINI Hawk Xi Imagers

Part Number	Description	List Price	Type
FIS-6310-1110G	MINI Hawk Xi Imager High Resolution SD Ethernet 24V	€ 2,046	LP
FIS-6310-1210G	MINI Hawk Xi Imager High Resolution HD Ethernet 24V	€ 2,046	LP
FIS-6310-1310G	MINI Hawk Xi Imager High Resolution Ultra HD Ethernet 24V	€ 2,046	LP
FIS-6310-1100G	MINI Hawk Xi Imager High Speed SD Ethernet 24V	€ 2,046	LP
FIS-6310-1300G	MINI Hawk Xi Imager High Speed Ultra HD Ethernet 24V	€ 2,046	LP

## Legacy Products

Note: These products are not recommended for new applications, but are still actively shipping and supported.



### Vision MINI Xi Smart Camera - 1.3 MP SXGA (1280 x 1024)

Part Number	Description	List Price	Type
GMV-6310-1110G	Vision MINI Xi SXGA Mono SD AV Ethernet/24V	€ 2,322	LP
GMV-6310-1210G	Vision MINI Xi SXGA Mono HD AV Ethernet/24V	€ 2,322	LP
GMV-6310-1112G	Vision MINI Xi SXGA Mono SD VS+AV Ethernet/24V	€ 2,788	LP
GMV-6310-1212G	Vision MINI Xi SXGA Mono HD VS+AV Ethernet/24V	€ 2,788	LP
GMV-6310-1114G*	Vision MINI Xi SXGA Mono SD Verif.+AV Ethernet/24V	€ 2,696	LP
GMV-6310-1214G*	Vision MINI Xi SXGA Mono HD Verif.+AV Ethernet/24V	€ 2,696	LP
GMV-6310-1116G*	Vision MINI Xi SXGA Mono SD Verif.+AV+VS Ethernet/24V	€ 3,160	LP
GMV-6310-1216G*	Vision MINI Xi SXGA Mono HD Verif.+AV+VS Ethernet/24V	€ 3,160	LP

\* Verification calibration card not included in verification license

Lens Types are defined as **SD** = Standard Density Wide Angle Optics, and **HD** = High Density Narrow Angle Optics

### Vision MINI Xi Smart Camera - 0.4 MP WVGA (752 x 480)

Part Number	Description	List Price	Type
GMV-6310-1100G	Vision MINI Xi WVGA Mono SD AV	€ 2,136	LP
GMV-6310-1200G	Vision MINI Xi WVGA Mono HD AV Ethernet/24V	€ 2,136	LP
GMV-6310-1102G	Vision MINI Xi WVGA Mono SD VS+AV Ethernet/24V	€ 2,600	LP
GMV-6310-1202G	Vision MINI Xi WVGA Mono HD VS+AV Ethernet/24V	€ 2,600	LP
GMV-6310-1104G*	Vision MINI Xi WVGA Mono SD Verif.+AV Ethernet/24V	€ 2,508	LP
GMV-6310-1204G*	Vision MINI Xi WVGA Mono HD Verif.+AV Ethernet/24V	€ 2,508	LP
GMV-6310-1106G*	Vision MINI Xi WVGA Mono SD Verif.+AV+VS Ethernet/24V	€ 2,974	LP
GMV-6310-1206G*	Vision MINI Xi WVGA Mono HD Verif.+AV+VS Ethernet/24V	€ 2,974	LP

\* Verification calibration card not included in verification license

### Vision MINI Xi Smart Camera - 3 MP Color QXGA (2048 x 1536)

Part Number	Description	List Price	Type
GMV-6310-1172G*	Vision MINI Xi QXGA Color SD VS+AV Ethernet/24V	€ 2,834	LP
GMV-6310-1272G*	Vision MINI Xi QXGA Color HD VS+AV Ethernet/24V	€ 2,834	LP

The GMV-6310-1x72G is a Smart Camera with 3.0 MPixel color sensors. It is not detected and listed as cameras that can be connected and programmed by AutoVISION. It is detected and listed by Visionscape which is required for programming and monitoring.

**\*Color models are only supported by Visionscape**



### Scanners MS-3 Standard

Part Number	Description	List Price	Type
FIS-0003-0009G	MS-3 Barcode ReaderSingle LineLow Density6 Cable	€ 918	LP
FIS-0003-0010G	MS-3 Barcode ReaderSingle LineHigh Density6 Cable	€ 918	LP
FIS-0003-0011G	MS-3 Barcode ReaderRasterLow Density6 Cable	€ 970	LP
FIS-0003-0012G	MS-3 Barcode ReaderRasterHigh Density6 Cable	€ 970	LP
FIS-0003-0013G	MS-3 Barcode ReaderSingle LineLow DensityRight Angle6 Cable	€ 1,032	LP
FIS-0003-0014G	MS-3 Barcode ReaderSingle LineHigh DensityRight Angle6 Cable	€ 1,032	LP
FIS-0003-0015G	MS-3 Barcode ReaderRasterLow DensityRight Angle6 Cable	€ 1,082	LP
FIS-0003-0016G	MS-3 Barcode ReaderRasterHigh DensityRight Angle6 Cable	€ 1,082	LP
FIS-0003-0019G	MS-3 Barcode ReaderRasterLow DensityPDF	€ 1,082	LP
FIS-0003-0020G	MS-3 Barcode ReaderRasterHigh DensityPDF	€ 1,082	LP
FIS-0003-0028G	MS-3 Barcode ReaderRasterHigh Density6 CablePDF	€ 1,082	LP
FIS-0003-0037G	MS-3 Barcode Reader Single Line Low DensityMS-610 Replacement	€ 1,080	LP
FIS-0003-0038G	MS-3 Barcode ReaderRasterLow DensityMS-610 Replacement	€ 1,142	LP

## Legacy Products

Note: These products are not recommended for new applications, but are still actively shipping and supported.



### MS-820 Laser Barcode Scanner

Part Number	Description	List Price	Type
FIS-0820-0001G	MS-820 Scanner Single Line LD	€ 1,796	LP
FIS-0820-0002G	MS-820 Scanner Single Line HD	€ 1,796	LP
FIS-0820-0003G	MS-820 Scanner Raster LD	€ 1,908	LP
FIS-0820-0004G	MS-820 Scanner Raster HD	€ 1,908	LP
FIS-0820-0009G	MS-820 Scanner Single Line MD	€ 1,796	LP
FIS-0820-0010G	MS-820 Scanner Raster MD	€ 1,908	LP
FIS-0820-0011G	MS-820 Scanner Single Line HD	€ 1,796	LP
FIS-0820-0012G	MS-820 Scanner Raster HD	€ 1,908	LP
FIS-0820-0014G	MS-820 Scanner Raster HD	€ 1,908	LP
FIS-0820-0015G	MS-820 Scanner Raster MD Special Software (Pharmacode)	€ 1,908	LP
FIS-0820-0017G	MS-820 Scanner Single Line LD HT	€ 1,908	LP
FIS-0820-0018G	MS-820 Scanner Raster LD HT	€ 2,032	LP



### MS-9 Laser Barcode Scanner

Part Number	Description	List Price	Type
FIS-0911-0001G	MS-9 Scanner Single Line LD RS-232/RS-422/RS-48510-28VDC	€ 2,000	LP
FIS-0911-0002G	MS-9 Scanner Single Line HD RS-232/RS-422/RS-48510-28VDC	€ 2,000	LP
FIS-0911-0003G	MS-9 Scanner Single Line LD OMR RS-232/RS-422/RS-48510-28VDC	€ 2,246	LP
FIS-0911-0004G	MS-9 Scanner Single Line HD OMR RS-232/RS-422/RS-48510-28VDC	€ 2,246	LP
FIS-0911-0005G	MS-9 Scanner Raster Line LD RS-232/RS-422/RS-48510-28VDC	€ 2,122	LP
FIS-0911-0006G	MS-9 Scanner Raster Line HD RS-232/RS-422/RS-48510-28VDC	€ 2,122	LP
FIS-0911-0007G	MS-9 Scanner Single Line LD Pharmacode RS-232/RS-422/RS-48510-28VDC	€ 2,000	LP



### HS-51 Reader

Part Number	Description	List Price	Type
FIS-HS51-0001G	HS-51 Wireless Handheld Reader with Battery Bluetooth Charging Base USB Cable	€ 1,208	LP



### Interface Boxes

Part Number	Description	List Price	Type
98-000039-02	Kit IB-152	€ 138	LA
20-500013-01	Box Interface DeviceNet Brand-Label	€ 655	LA

Note: parts are not RoHS compliant.

DeviceNet protocol box works with IB-131

## Legacy Products

Note: These products are not recommended for new applications, but are still actively shipping and supported.



### NERLITE Legacy Accessories

Part Number	Description	List Price	Type
NER-011503800	NERLITE LC-50 Current Controller 0.35A Input 40VDC Max.	€ 212	LA
NER-011503801	NERLITE LC-50 Current Controller 0.7A Input 40VDC Max.	€ 212	LA
NER-011503802	NERLITE LC-50 Current Controller 1.05A Input 40VDC Max.	€ 212	LA



### CDI (Continuous Diffuse Illuminator)

Part Number	Description	List Price	Type
NER-011252000	NERLITE CDI 200/75 Red CDI Light 24V Continuous Open-End Cable	€ 3,436	LP
NER-011252010	NERLITE CDI 200/75 White CDI Light 24V Continuous Open-End Cable	€ 3,590	LP



### Dome Lights

Part Number	Description	List Price	Type
NER-011600403	NERLITE D150 Red Dome 24V Continuous Open-End Cable	€ 820	LP
NER-011600411	NERLITE D150 White Dome 24V Continuous Open-End Cable	€ 1,398	LP
NER-011600402	NERLITE D150 Red Dome 24V Strobe Open-End Cable	€ 820	LP
NER-011600412	NERLITE D150 White Dome 24V Strobe Open-End Cable	€ 1,398	LP



### Linear Arrays

Part Number	Description	List Price	Type
NER-011654195	NERLITE LA-50-1 Red Linear Array 24V Continuous Open-End Cable	€ 296	LP
NER-011654198	NERLITE LA-50-1 White Linear Array 24V Continuous Open-End Cable	€ 320	LP
NER-011654170	NERLITE LA-50-1 Blue Linear Array 24V Continuous Open-End Cable	€ 320	LP
NER-011654120	NERLITE LA-50-1 Red Linear Array 24V Strobe Open-End Cable	€ 296	LP
NER-011654150	NERLITE LA-50-1 White Linear Array 24V Strobe Open-End Cable	€ 320	LP
NER-011654180	NERLITE LA-50-1 Blue Linear Array 24V Strobe Open-End Cable	€ 320	LP
NER-011654395	NERLITE LA-100-1 Red Linear Array 24V Continuous Open-End Cable	€ 396	LP
NER-011654340	NERLITE LA-100-1 White Linear Array 24V Continuous Open-End Cable	€ 446	LP
NER-011654370	NERLITE LA-100-1 Blue Linear Array 24V Continuous Open-End Cable	€ 446	LP
NER-011654320	NERLITE LA-100-1 Red Linear Array 24V Strobe Open-End Cable	€ 396	LP
NER-011654350	NERLITE LA-100-1 White Linear Array 24V Strobe Open-End Cable	€ 446	LP
NER-011654380	NERLITE LA-100-1 Blue Linear Array 24V Strobe Open-End Cable	€ 446	LP
NER-011654593	NERLITE LA-150-1 Red Linear Array 24V Continuous Open-End Cable	€ 446	LP
NER-011654540	NERLITE LA-150-1 White Linear Array 24V Continuous Open-End Cable	€ 520	LP
NER-011654570	NERLITE LA-150-1 Blue Linear Array 24V Continuous Open-End Cable	€ 520	LP
NER-011654550	NERLITE LA-150-1 White Linear Array 24V Strobe Open-End Cable	€ 520	LP
NER-011654580	NERLITE LA-150-1 Blue Linear Array 24V Strobe Open-End Cable	€ 520	LP

## Legacy Products

Note: These products are not recommended for new applications, but are still actively shipping and supported.



Area Arrays			
Part Number	Description	List Price	Type
NER-011652125	NERLITE AR-50x50-HO Blue Non-Diffuse Array 24V Continuous Open-End Cable	€ 472	LP
NER-011652143	NERLITE AR-50x50-HO Infrared Array 24V Continuous Open-End Cable	€ 472	LP
NER-011652131	NERLITE AR-50x50-HO Red Non-Diffuse Array 24V Strobe Open-End Cable	€ 362	LP
NER-011652133	NERLITE AR-50x50-HO White Non-Diffuse Array 24V Strobe Open-End Cable	€ 472	LP
NER-011652135	NERLITE AR-50x50-HO Blue Non-Diffuse Array 24V Strobe Open-End Cable	€ 472	LP
NER-011652144	NERLITE AR-50x50-HO Infrared Non-Diffuse Array 24V Strobe Open-End Cable	€ 472	LP
NER-011652137	NERLITE AR-50x50-HO Ultraviolet Array 24V Strobe Open-End Cable	€ 472	LP
NER-011903503	NERLITE AR-75x75-HO Blue Array 24V Continuous Open-End Cable	€ 732	LP
NER-011652182	NERLITE AR-75x75-HO Infrared Array 24V Continuous Open-End Cable	€ 840	LP
NER-011652171	NERLITE AR-75x75-HO Red Array 24V Strobe Open-End Cable	€ 542	LP
NER-011652173	NERLITE AR-75x75-HO White Array 24V Strobe Open-End Cable	€ 840	LP
NER-011652175	NERLITE AR-75x75-HO Blue Array 24V Strobe Open-End Cable	€ 840	LP
NER-011904006	NERLITE AR-75x75-HO Infrared Array 24V Strobe Open-End Cable	€ 732	LP
NER-011652180	NERLITE AR-75x75-HO Ultraviolet Array 24V Strobe Open-End Cable	€ 840	LP
NER-011904301	NERLITE AR-100x100-HO Blue Array 24V Continuous Open-End Cable	€ 1,061	LP
NER-011652232	NERLITE AR-100x100-HO Infrared Array 24V Continuous Open-End Cable	€ 1,216	LP
NER-011650004	NERLITE AR-50x200-HO Red Non-Diffuse Array 24V Strobe Open-End Cable	€ 924	LP
NER-011650013	NERLITE AR-50x200-HO, White, Non-Diffuse, Array, 24V Strobe, Open-End Cable	€ 1,435	VLP



Machine Vision Optical Accessories			
Part Number	Description	List Price	Type
98-92800572	Lens 12mm F/1.8-16 Front thread 25.5mm P 0.5mm 2/3 C-mount	€ 386	LA
98-92800573	Lens 16mm F/1.4-16 Front thread 25.5mm P 0.5mm 2/3 C-mount	€ 386	LA
98-92800574	Lens 25 mm F/1.6-16 Front Thread 25.5 mm P 0.5 mm 2/3 in. C-Mount	€ 386	LA

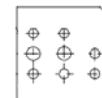

Machine Vision Hardware Accessories			
Part Number	Description	List Price	Type
98-001904091	Calibration Target for 1.87 mmx3.0 mm Field of View	€ 1,396	LA
98-001904092	Calibration Target for 2.80 mmx4.50 mm Field of View	€ 1,396	LA
98-001904093	Calibration Target for 4.20 mmx6.75 mm Field of View	€ 1,396	LA
98-001904094	Calibration Target for 6.34 mmx10.2 mm Field of View	€ 1,396	LA
98-001904095	Calibration Target for 9.33 mmx15.0 mm Field of View	€ 1,396	LA
98-001904096	Calibration Target for 14.0 mmx22.5 mm Field of View	€ 1,396	LA
98-001904097	Calibration Target for 20.5 mmx33.0 mm Field of View	€ 1,396	LA
98-001904098	Calibration Target for 47.3 mmx76.1 mm Field of View	€ 1,396	LA
98-001904099	Calibration Target for 63.1 mmx101 mm Field of View	€ 1,101	LA
98-001904100	Calibration Target for 94.7 mmx152 mm Field of View	€ 1,101	LA
98-001904101	Calibration Target for 158 mmx254 mm Field of View	€ 1,101	LA
98-001904175	Calibration Target for 30.8 mmx49.5 mm Field of View	€ 1,101	LA

## Legacy Products

Note: These products are not recommended for new applications, but are still actively shipping and supported.



### EZ Match Solution Kits

Part Number	Description	List Price	Type
FIS-0004-1000G	EZ Match LD RS-232/RS-422/RS-485 5V	€ 2,564	LP
FIS-0004-1001G	EZ Match 3 MP Color LD RS-232/RS-422/RS-485	€ 3,076	LP



### MS-Connect 5100 Options

Part Number	Description	List Price	Type
FIS-5100-0001G	MS-Connect 5100 Enhanced Multidrop Concentrator	€ 1,096	LA
61-000161-02	QX Cordset M12 12-Pin Plug (Screw-On)-to-MS-Connect 5100 3 m.	€ 80	LA



### PanelScan

Note: Part Numbers replaced with updated model part numbers.

Part Number	Description	List Price	Type
SLN-0001000	PanelScan Standard (10 in.x24 in. 254 mmx609 mm Field of View)	€ 16,625	OBS
SLN-0001001	PanelScan Wide (18 x 24 508mm x 609mm FOV)	€ 21,625	OBS