

MICROSCAN[®]

Quadrus Verifier User's Manual



P/N 83-006702 Rev C

Copyright and Disclaimer

Copyright © 2007

by Microscan Systems, Inc.,
1201 S.W. 7th Street, Renton, Washington, U.S.A. 98057
(425) 226-5700 FAX: (425) 226-8682

ISO 9001:2000 Certification No. 06-1080
Issued by TÜV USA

All rights reserved. The information contained herein is proprietary and is provided solely for the purpose of allowing customers to operate and/or service Microscan manufactured equipment and is not to be released, reproduced, or used for any other purpose without written permission of Microscan.

Throughout this manual, trademarked names might be used. Rather than put a trademark (™) symbol in every occurrence of a trademarked name, we state herein that we are using the names only in an editorial fashion, and to the benefit of the trademark owner, with no intention of infringement.

Disclaimer

The information and specifications described in this manual are subject to change without notice.

Latest Manual Version

For the latest version of this manual, see the Download page on our web site at www.microscan.com.
For technical support email helpdesk@microscan.com.

Microscan Systems, Inc.

1201 S.W. 7th Street
Renton, WA 98057
U.S.A.
Tel: 425 226 5700
Fax: 425 226 8250
helpdesk@microscan.com

Microscan Europe

Tel: 31 172 423360
Fax: 31 172 423366

Microscan Asia Pacific R.O.

Tel: 65 6846 1214
Fax: 65 6846 4641

Microscan Limited Warranty Statement and Exclusions

What Is Covered?

Microscan Systems Inc. warrants to the original purchaser that products manufactured by it will be free from defects in material and workmanship under normal use and service for a period of one year from the date of shipment. This warranty is specifically limited to, at Microscan's sole option, repair or replacement with a functionally equivalent unit and return without charge for service or return freight.

What Is Excluded?

This limited warranty specifically excludes the following: (1) Any products or parts that have been subject to misuse, neglect, accident, unauthorized repair, improper installation, or abnormal conditions or operations; (2) Any products or parts that have been transferred by the original purchaser; (3) Customer mis-adjustment of settings contrary to the procedure described in the Microscan Systems Inc. owners manual; (4) Upgrading software versions at customer request unless required to meet specifications in effect at the time of purchase; (5) Units returned and found to have no failure will be excluded; (6) Claims for damage in transit are to be directed to the freight carrier upon receipt. Any use of the product is at purchaser's own risk. This limited warranty is the only warranty provided by Microscan Systems Inc. regarding the product. Except for the limited warranty above, the product is provided "as is." To the maximum extent permitted by law, this express warranty excludes all other warranties, express or implied, including but not limited to, implied warranties of merchantability and. Technical support questions may be directed to: helpdesk@microscan.com Register your product with Microscan: www.microscan.com/register fitness for a particular purpose. Microscan Systems Inc. does not warrant that the functions contained in the product will meet any requirements or needs purchaser may have, or that the product will operate error free, or in an uninterrupted fashion, or that any defects or errors in the product will be corrected, or that the product is compatible with any particular machinery.

Limitation of Liability

In no event shall Microscan Systems Inc. be liable to you or any third party for any special, incidental, or consequential damages (including, without limitation, indirect, special, punitive, or exemplary damages for loss of business, loss of profits, business interruption, or loss of business information), whether in contract, tort, or otherwise, even if Microscan Systems Inc. has been advised of the possibility of such damages. Microscan Systems Inc.'s aggregate liability with respect to its obligations under this warranty or otherwise with respect to the product and documentation or otherwise shall not exceed the amount paid by you for the product and documentation. Some jurisdictions do not allow the exclusion or limitation of incidental or consequential damages or limitations on an implied warranty, so the above limitation or exclusion may not apply to you. This warranty gives you specific legal rights, and you may also have other rights which may vary from state to state.

Tel: 425.226.5700 | Fax: 425.226.8250 | helpdesk@microscan.com

Table of Contents

Chapter 1	Quick Start	
	Step 1 Check Required Hardware.....	1-2
	Step 2 Connect the System.....	1-3
	Step 3 Install ESP	1-4
	Step 4 Select Model	1-5
	Step 5 Select Communications Protocol	1-6
	Step 6 Position Verifier and Symbol	1-7
	Step 7 Locate Symbol	1-8
	Step 8 Calibrate Reflectance.....	1-9
	Step 9 Set Verification Parameters	1-10
	Step 10 Verify Symbol	1-11
	Step 11 Generate and Save Verification Report	1-14
Chapter 2	Using ESP	
	Verification.....	2-2
	Application Mode.....	2-3
	Menu Toolbar	2-4
	View.....	2-11
	Navigating in ESP	2-12
	Send/Receive Options.....	2-13
Chapter 3	Verification	
	Verification Serial Commands	3-2
	Verification Operational Commands.....	3-2
	Overview of Verification.....	3-3
	ISO/IEC 15415 Evaluation Parameters	3-5
	AS9132 Evaluation Parameters	3-7
	AIM DPM Evaluation Parameters.....	3-10
	General Verification Serial Output.....	3-12
	General Verification Output by ESP	3-17
	ISO/IEC 15415 Verification Setup	3-19
	ISO/IEC 15415 Verification Setup by ESP	3-21
	ISO/IEC 15415 Serial Output	3-23
	ISO/IEC 15415 Output by ESP	3-33
	AIM DPM Verification Setup	3-40
	AIM DPM Verification Setup by ESP.....	3-42
	ISO/IEC 15415 Verification by Serial Command.....	3-44
	AS9132/JES 131 Marking Method	3-49
	AS9132/JES 131 Marking Method by ESP	3-51
	AS9132 Serial Output.....	3-53
	AS9132 Output by ESP	3-62
	AS9132 Verification by Serial Command	3-67
	AIM DPM Verification by Serial Command.....	3-68
	Verification by ESP.....	3-70

Chapter 4	Unique Item Identifiers	
	Overview of IUID and UII	4-2
	Non-UII Characters	4-3
	UII Mode Features	4-4
	Error Messaging	4-6
	Valid Data Qualifier Formats	4-8
	UII Parsing	4-9
Chapter 5	Communications	
	Communications by ESP	5-2
	Communications Serial Commands	5-3
	RS-232/422 Host Port	5-4
	RS-232 Auxiliary Port	5-9
	Network	5-18
	Preamble	5-21
	Postamble	5-22
	Response Timeout	5-23
	LRC Status	5-24
	Aux Port System Data Status	5-25
Chapter 6	Read Cycle	
	Read Cycle by ESP	6-2
	Read Cycle Serial Commands	6-3
	Read Cycle Setup	6-4
	Multisymbol	6-5
	Trigger	6-7
	Serial Trigger	6-13
	End of Read Cycle	6-15
	Active Camera	6-17
	Capture Mode	6-18
	Capture Timing	6-23
	Dual Camera Switching	6-25
	Store No Read Image	6-30
	Setting Up the Verifier for EZ Trax	6-31
Chapter 7	Symbologies	
	Symbologies by ESP	7-2
	Symbologies Serial Commands	7-3
	Data Matrix	7-4
	QR Code	7-6
	Code 39	7-7
	Code 128	7-10
	BC412	7-11
	Interleaved 2 of 5	7-13
	UPC/EAN	7-16
	Pharmacode	7-19
	RSS Expanded	7-21

Table of Contents

RSS Limited	7-22
RSS-14	7-23
PDF417	7-24
MicroPDF417	7-26
Composite	7-27
Narrow Margins	7-28
Symbology ID	7-29
Background Color	7-30
Chapter 8 I/O Parameters	
I/O Parameters by ESP	8-2
I/O Parameters Serial Commands	8-3
Symbol Data Output	8-4
When to Output Symbol Data	8-6
No Read Message	8-7
Bad/No Symbol Qualification	8-9
Read Duration Output	8-16
Output Indicators	8-17
Serial Verification	8-20
Video Output	8-22
Image Output	8-24
Image Captioning	8-26
Synchronous Trigger	8-28
EZ Button	8-30
EZ Button Modes	8-32
Input 1	8-34
Output 1 Parameters	8-35
Output 2 Parameters	8-48
Output 3 Parameters	8-52
Configuring EZ Trax Output	8-56
Chapter 9 Matchcode	
Matchcode by ESP	9-2
Matchcode Serial Commands	9-3
Overview of Matchcode	9-4
Matchcode Type	9-5
Sequential Matching	9-6
Match Start Position	9-7
Match Length	9-8
Wild Card Character	9-9
Sequence On No Read	9-10
Sequence On Mismatch	9-11
Sequence Step	9-12
Match Replace	9-13
Mismatch Replace	9-14
New Master Pin	9-15

Chapter 10	Diagnostics	
	Diagnostics by ESP	10-2
	Diagnostics Serial Commands	10-2
	Counts (Read Only)	10-3
	External Camera Message	10-4
	Over Temperature Message	10-6
	Service Message	10-7
Chapter 11	Camera Setup	
	Camera Setup by ESP	11-2
	Camera Setup Serial Commands	11-3
	Video	11-4
	Evaluation	11-6
	Region of Interest (ROI)	11-10
	IP Database	11-13
	Dynamic Setup	11-14
	Camera	11-16
	Illumination Source	11-17
	Thresholding	11-18
	Image Processing Settings	11-19
	Hollow Mode	11-21
	Mirrored Image	11-22
Chapter 12	IP Database	
	IP Database by ESP	12-2
	IP Database Serial Commands	12-3
	Overview of IP Database	12-4
	IP Database Window in ESP	12-6
	Number of Active Database Settings	12-7
	Image Processing Database	12-8
	Image Processing Database by ESP	12-10
	Save Current Settings to Database	12-11
	Load Current Settings from Database	12-12
	Request Selected Database Settings	12-13
	Request All Database Settings	12-13
Chapter 13	Terminal	
	Terminal Window	13-2
	Find	13-3
	Send	13-4
	Macros	13-5
	Terminal Window Menus	13-6
Chapter 14	Utilities	
	Serial Utility Commands	14-2
	Read Rate	14-3
	Counters	14-4

Table of Contents

Device Control.....	14-6
Differences from Default.....	14-7
Master Database	14-8
Firmware	14-13
Bar Code Configuration	14-16
Defaulting/Saving/Resetting	14-17
Status Requests	14-19
Other Operational Serial Commands	14-21
Chapter 15 Output Format	
Output Format Serial Commands.....	15-2
Output Format Status	15-3
Format Assign	15-4
Format Extract.....	15-5
Format Insert.....	15-7
Output Filter Configuration	15-9
Ordered Output Filter	15-13
Chapter 16 Ethernet	
Step 1 Setup.....	16-2
Step 2 Preliminary Steps.....	16-3
Step 3 Communicating in Ethernet.....	16-7
Step 4 Ethernet Application	16-8
Appendices	
Appendix A General Specifications	A-2
Appendix B Electrical Specifications	A-4
Appendix C Connectivity Accessories.....	A-8
Appendix D Serial Configuration Commands.....	A-11
Appendix E ASCII Table.....	A-17
Appendix F Data Matrix Symbology	A-19
Appendix G Object Detector.....	A-20
Appendix H Operational Tips	A-21
Appendix I Embedded Menus	A-22
Appendix J Interface Standards	A-23
Appendix K Glossary of Terms.....	A-24
Index	

About the Quadrus Verifier

The key features of the Quadrus Verifier are:

- ISO/IEC 15415, AS9132, and AIM DPM verification options
- Self-contained, factory-calibrated optics and lighting for fast, easy integration into a variety of manufacturing processes
- ISO/IEC 15426 certification for Data Matrix verification
- **ESP** Software for configuration and testing

About This Manual

This manual provides complete information on setting up, installing, and configuring the Quadrus Verifier. The sections are presented in the order in which the Verifier might be set up and made ready for industrial operation.

Note: The terms **AS9132** and **AS9132** are used interchangeably throughout this documentation. “AS9132” is the name of a specification, and the suffix “A” denotes the current published version of the specification.

Highlighting

Serial commands and default settings are highlighted in **rust bold**. Cross-references and web links are highlighted in **blue bold**. References to menu items are highlighted in **Bold Initial Caps**.

Host Communications

There are four ways to configure and test the Quadrus Verifier:

1. Several configuration commands can be executed from the **EZ Button** without connection to a host.
2. Microscan’s Windows-based **ESP**, the preferred method, which offers point-and-click ease of use and visual responses to user adjustments.
3. Serial commands, such as **<K100,1>**, can be sent from a terminal program. They can also be sent from a PLC or from **ESP’s Terminal**.
4. Embedded onboard menus are accessed from a terminal window with a **<D>** command.

Statement of Agency Compliance



The Quadrus Verifier has been tested for compliance with CE (Conformité Européenne) standards and guidelines and has been found to conform to applicable CE standards, specifically the following requirements:

- ITE Disturbances: IEC 55022:1998 (radiated and conducted) Class A
- General Immunity: IEC 55024:1998 (residential)
- Heavy Industrial Immunity: IEC 61000-6-2:1999
- LED Radiation: IEC 60825-1

Warning and Caution Summary

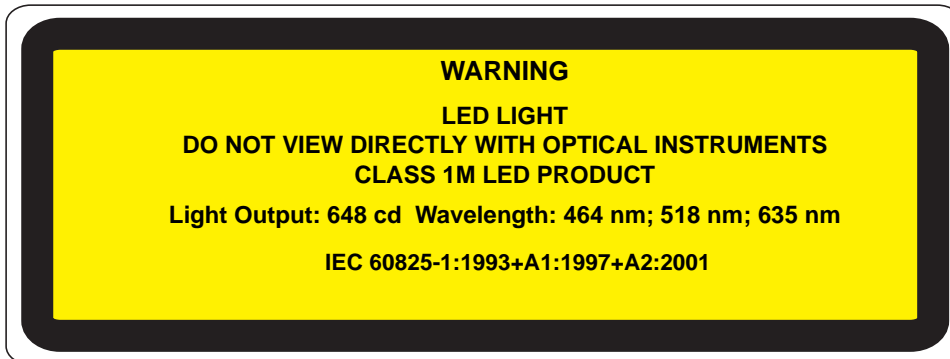

- Viewing the Quadrus Verifier's LED output with optical instruments such as magnifiers, eye loupes, or microscopes within a distance of 100 mm could cause serious eye injury.
- Maximum LED light output: 648 cd
- Wavelength: 464 nm; 518 nm; 635 nm
- Location of the Quadrus Verifier's LED aperture window:

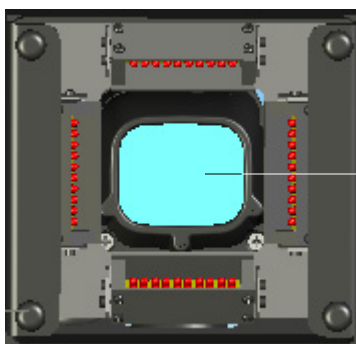

LED Aperture Window

- **CAUTION:** Use of controls or adjustments or performance of procedures other than those specified herein may result in hazardous radiation exposure.

Warning and Caution Summary (cont.)

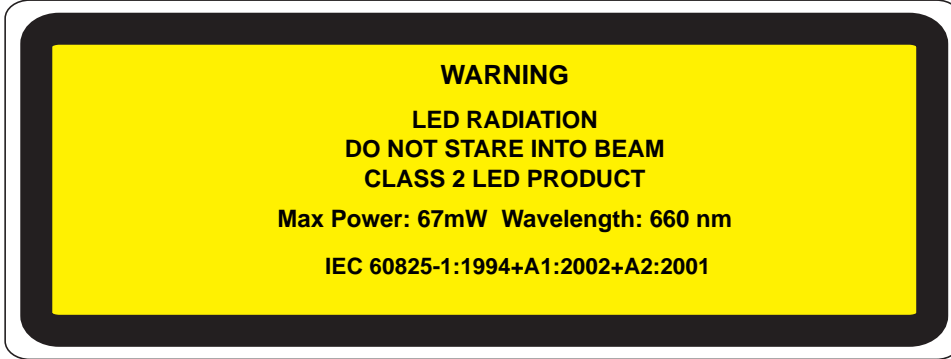

- Max Power: 67 mW
- Wavelength: 660 nm
- Location of the Quadrus Verifier's LED array:

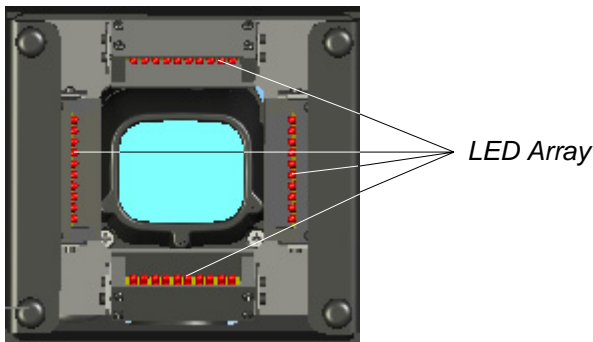

- **CAUTION:** Use of controls or adjustments or performance of procedures other than those specified herein may result in hazardous radiation exposure.

1 Quick Start

Contents

Step 1 Check Required Hardware.....	1-2
Step 2 Connect the System.....	1-3
Step 3 Install ESP.....	1-4
Step 4 Select Model	1-5
Step 5 Select Communications Protocol	1-6
Step 6 Position Verifier and Symbol.....	1-7
Step 7 Locate Symbol	1-8
Step 8 Calibrate Reflectance.....	1-9
Step 9 Set Verification Parameters	1-10
Step 10 Verifiy Symbol	1-11
Step 11 Generate and Save Verification Report	1-14

This section is designed to get your Verifier up and running quickly so you can get a sense of its capabilities and test sample symbols.

Detailed setup information for installing the Verifier in your application can be obtained in the subsequent sections.

Step 1 — Check Required Hardware

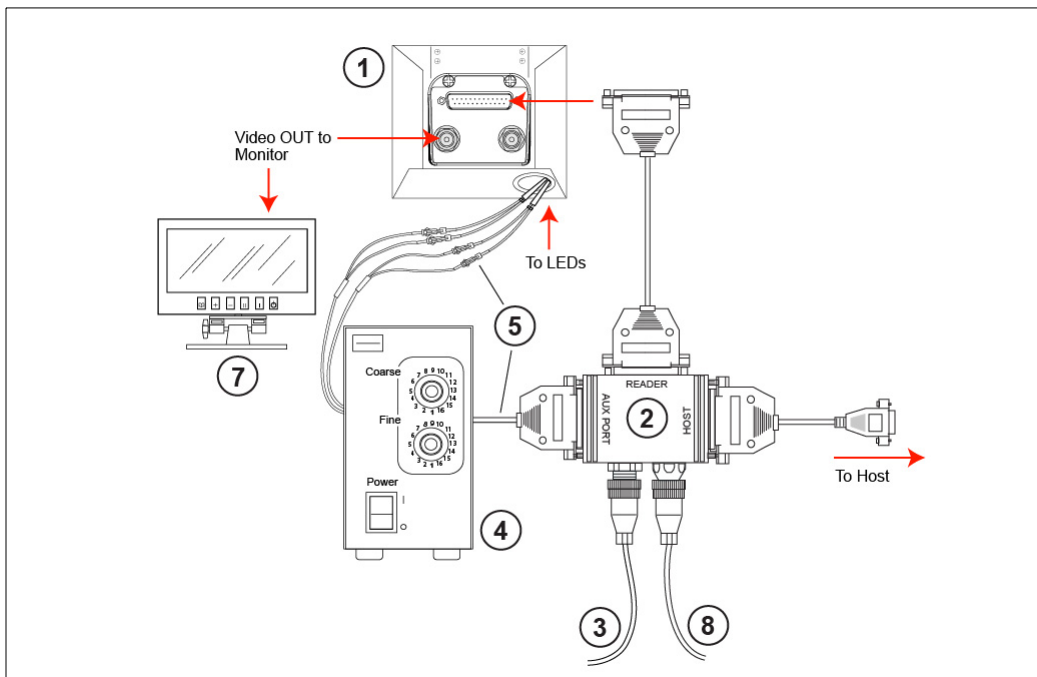

Hardware Required

Caution: Be sure that all cables are connected BEFORE applying power to the system. Always power down BEFORE disconnecting any cables.

Item	Description	Part Number
1	Quadrus Verifier	FIS-6700-100XG
2	IB-150 Kit	Included with Verifier
3	Power Supply	Included with Verifier
4	Illumination Power Supply	Included with Verifier
5	Light Control Cable	Included with Verifier
6	Quadrus EZ Stand (not shown)	Included with Verifier
7	Monitor Kit	98-000096-01
8	Object Detector	99-000017-01

Step 2 – Connect the System

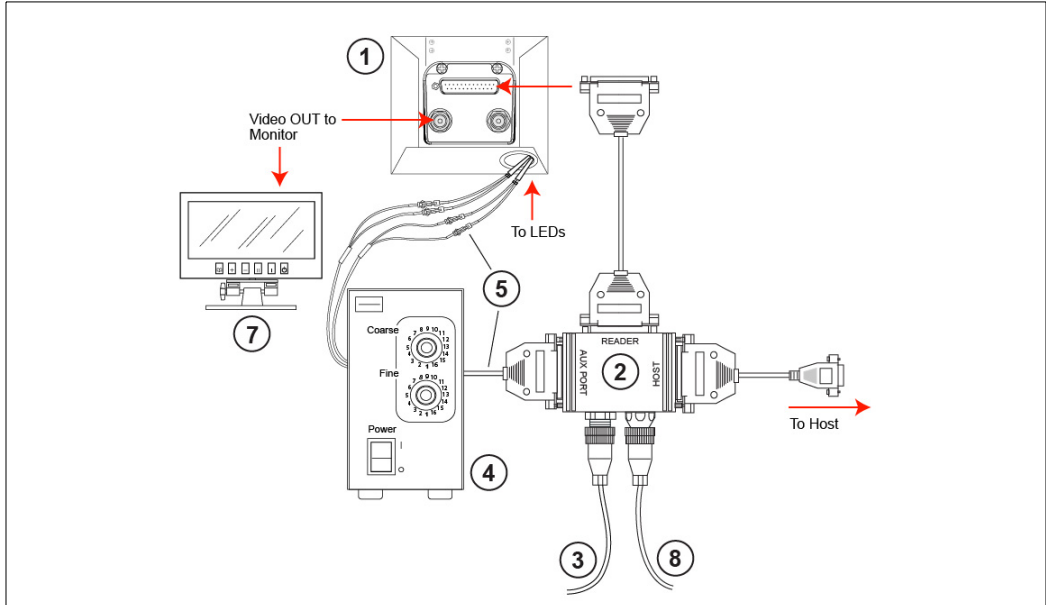

Hardware Configuration

Caution: Be sure that all cables are connected BEFORE applying power to the system. Always power down BEFORE disconnecting any cables.

Connecting to a Host by RS-232

1. Connect the Verifier to the IB-150 Kit.
2. Connect the IB-150 Kit host cable to the host.
3. Connect the Lighting Power Supply to the lighting chamber.
4. Connect the main power supply and cycle power to the Verifier.

Note: When wiring the IB-150 Kit to a host with a 25-pin host connector, cross pins 2 and 3. When wiring the interface box to a host with a 9-pin host connector, do NOT cross pins 2 and 3.

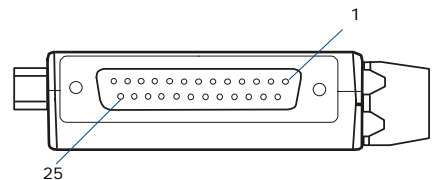

Side View of IB-150 showing Host 25-pin Socket Connection

Connecting to a Host by TCP/IP

See Chapter 16, [Ethernet](#).

Step 3 — Install ESP

Easy Setup Program (ESP) is Microscan's proprietary setup and testing application. The purpose of **ESP** is to provide a quick and easy way to set up and configure Microscan products.

When the Quadrus Verifier is connected to a host computer (Windows Vista, XP, or 2000), **ESP** can be used to set up communication with a host, configure various firmware settings, and control verification processes.

If installing from a Microscan Tools CD:

1. Insert the Microscan Tools CD in your computer's CD drive.
2. Choose **ESP Software** from the main menu.
3. Select the **Current Version** of **ESP** and follow the file download prompts.

If downloading from the web:

1. Go to <http://www.microscan.com/downloadcenter>
2. Create a new "myMicroscan" member account or, if you are already a member, enter your user name and password.
3. Click the **Download Software** link and extract the latest version of **ESP** to a directory of your choice. *Note where your **ESP.exe** file is stored on your hard drive.*
4. At the end of the installation process, the following icon will appear on your desktop:



5. Click the **ESP** icon to start the program.

System Requirements for ESP

- 166 MHz Pentium processor (recommended)
- Windows Vista, XP, or 2000 operating system
- Internet Explorer 5.0 or higher
- 64 MB minimum RAM
- 40 MB minimum disk space

Step 4 — Select Model

When you start **ESP**, the following menu will appear:



1. Click the button showing the Quadrus Verifier.
2. Click **OK**.
3. **Note:** You can also simply double-click the Quadrus Verifier button to make your selection.
4. Click **Yes** when the following dialog box appears:

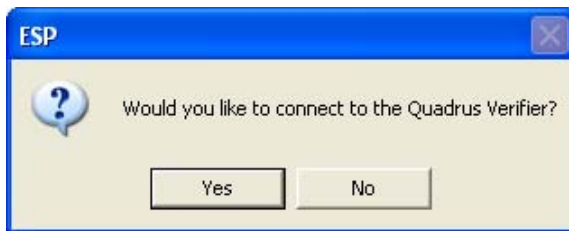

Note: If you need to select another model later, you can find it in **Application Mode** under **Model** on the menu toolbar.

Step 5 — Select Communications Protocol

When the following dialog appears, make your selection and click **Next**.

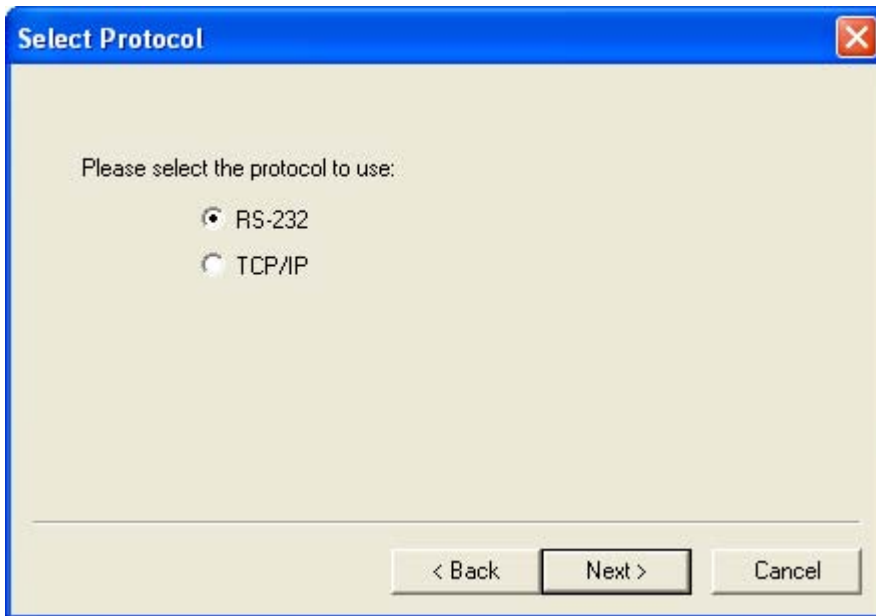

RS-232

1. In the RS-232 dialog, if your communications port is not the default **COM1**, use the dropdown menu to change your communications port.
2. Click **Connect**.
3. If the connection fails, click the **Autoconnect** button, select a different communications port, and try again.



Note: If your host settings cannot be changed to match the Verifier's settings, check the **Force Connect** box.

TCP/IP

See Chapter 16, [Ethernet](#).

Step 6 — Position Verifier and Symbol

When you connect to **ESP**, the first thing you will see is the **Report** tab of the **Verification** view.

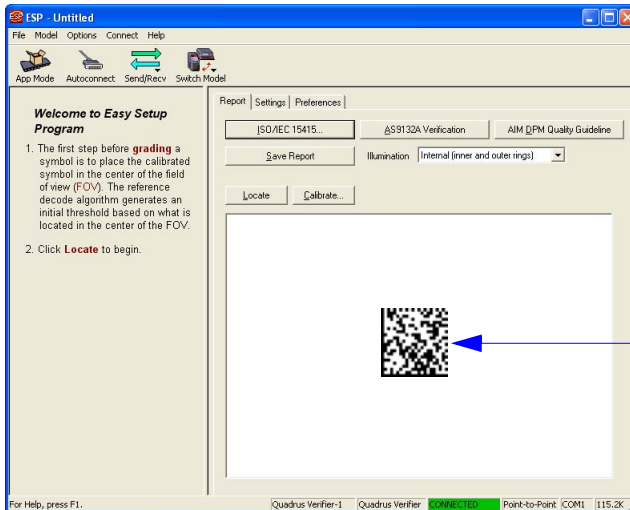

This view allows the user to center the symbol before calibrating.

The Quadrus Verifier comes with a reference card that features a **Verifier Calibration Symbol** and two numbers--the minimum and maximum reflectance values for **ISO/IEC 15415** and **AIM DPM** Reflectance Calibration. **Keep this card in a safe place!** It is the Verifier's most critical setup tool.

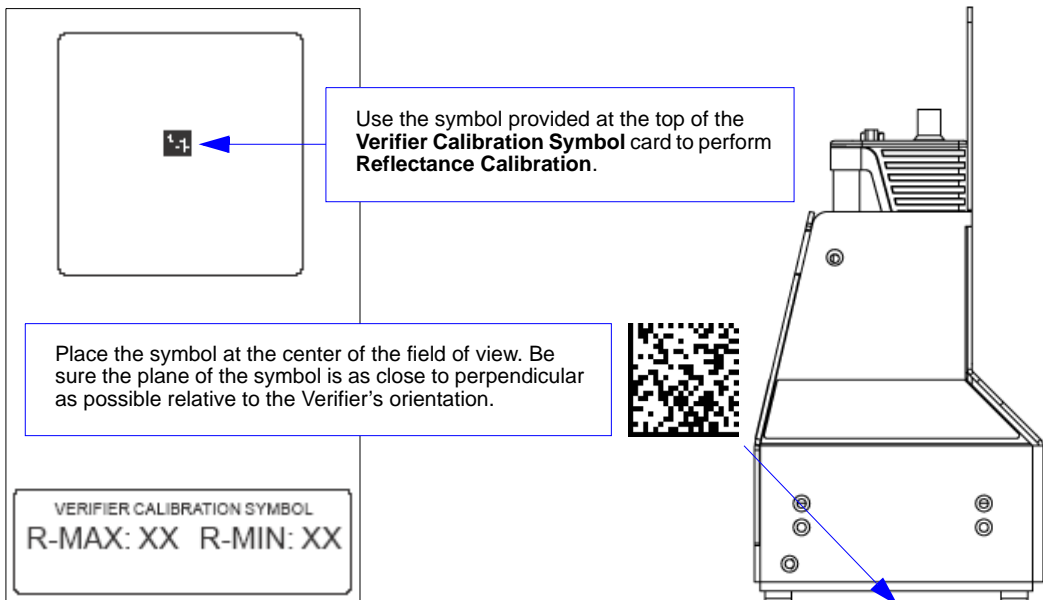

Step 7 — Locate Symbol

After you place the **Verifier Calibration Symbol** beneath the Verifier's lighting chamber, click the **Locate** button. You will see a video representation of the Verifier's field of view.

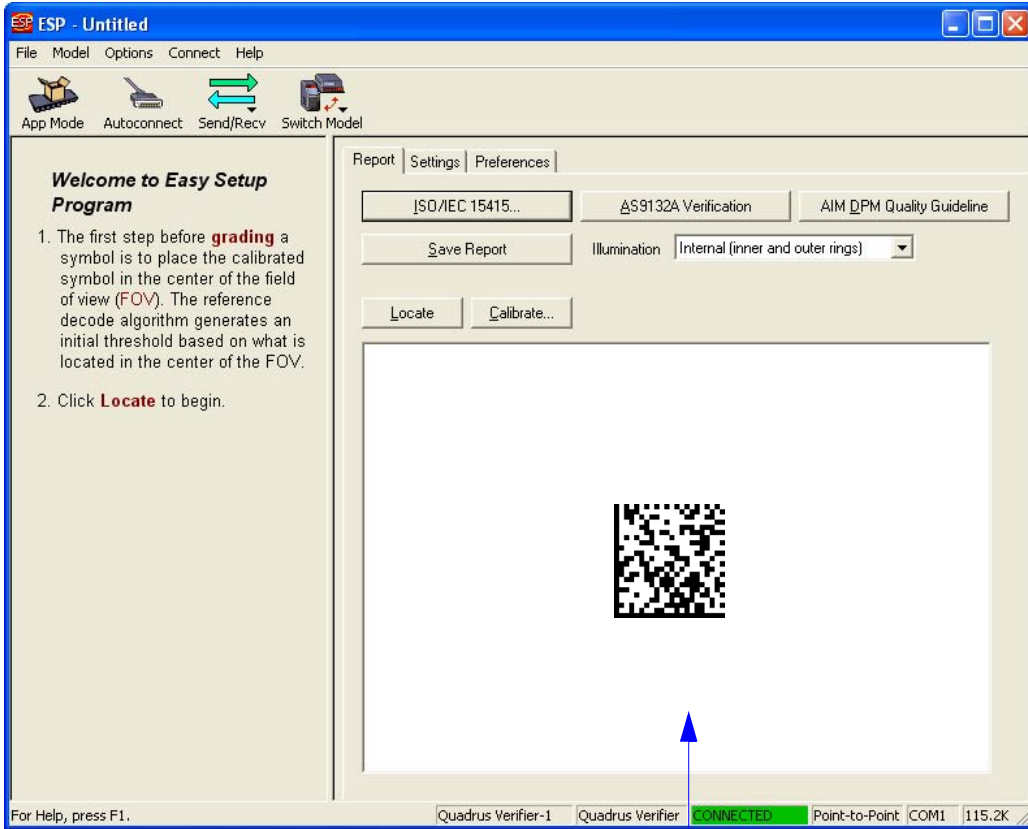

This view allows the user to center the symbol before calibrating.

Step 8 – Calibrate Reflectance

Move the symbol to the approximate center of the field of view before beginning calibration.

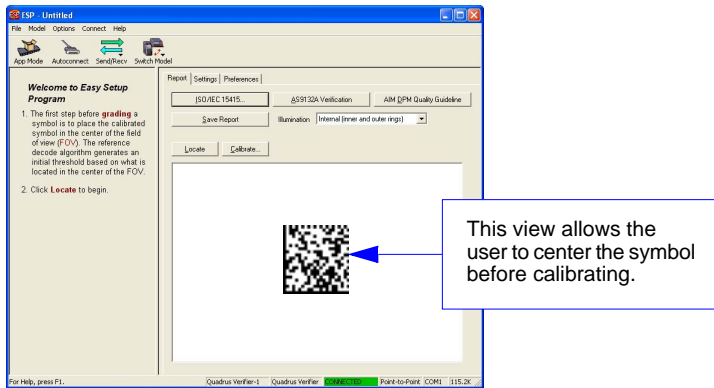

ISO/IEC 15415 Verification

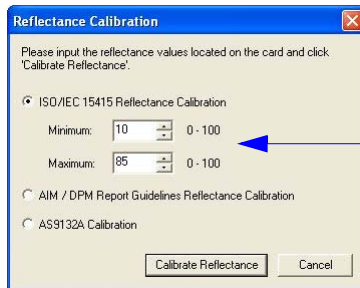

For ISO/IEC 15415 Reflectance Calibration, use the spin boxes in the **Reflectance Calibration** dialog to set a min. and max. value that match those on the reference card and then click **Calibrate Reflectance**.

AS9132 Verification

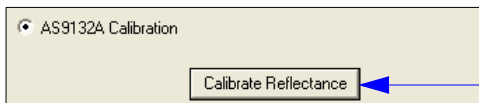

For AS9132 calibration, select the corresponding radio button and click **Calibrate Reflectance**. A green border will appear around the symbol after calibration.

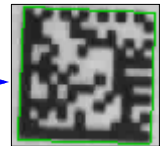

AIM DPM Verification

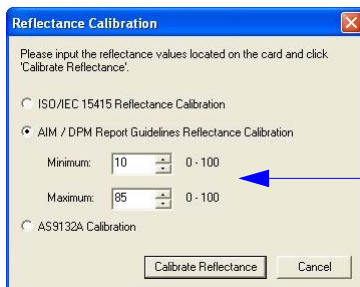

For AIM DPM Reflectance Calibration, use the spin boxes in the **Reflectance Calibration** dialog (as you would for ISO/IEC 15415) to set a min. and max. value that match those on the reference card and then click **Calibrate Reflectance**.

Step 9 – Set Verification Parameters

Once the Verifier is calibrated, you will need to set the parameters for your chosen verification process. To set these parameters, click the **Settings** tab in the Verification view.

Configure each setting as appropriate for your application before you begin verification.

Parameters	
[-] Symbol Verification	
[-] Data Matrix	
[-] General	
Separator	,
ISO Grade Type	Alpha
Symbol Type	Disabled
Symbol Dimension / Size	Disabled
[-] AS9132A Parameters	
Element Shape	Round
Marking Method	Inkjet / Dot Peen
JES 131	Disabled
Dot Center Offset	Disabled
Percentage Failed Offset	Disabled
Cell Fill	Disabled
Percentage Failed Cell Fill	Disabled
Dot Ovality	Disabled
Percentage Failed Ovality	Disabled
Angle of Distortion	Disabled
Symbol Contrast	Disabled
Quiet Zone Grade	Disabled
Pixels Per Element	Disabled*
[-] ISO/IEC 15415 Parameters	
Grade Output	Disabled*
Aperture	Value
Wavelength	Disabled
Light Angle	Disabled
Decode	Disabled
Symbol Contrast	Disabled
Fixed Pattern Damage	Disabled
Axial Non-uniformity	Disabled
Grid Non-uniformity	Disabled
Modulation	Disabled
Unused ECC	Disabled
Print Growth	Disabled
Pixels Per Element	Disabled
[-] ISO/IEC 15415 Setup	
Aperture	50
Wavelength	660
Angle	45
Reflectance Max	85
Reflectance Min	10
[-] AIM / DPM Setup	
Minimum Element Size	10
Maximum Element Size	15
Wavelength	660
Lighting	45Q

Data Matrix symbol verification settings.

Choose report output characteristics using the **Preferences** dialog (shown below).

Report Settings Preferences

Fields for report:

Operator Name:

Company Name:

defined:

Saved Options:

Show Report Options dialog during 'Save Report'.

Default Report Type:

Autofit Content Low Graphic HTML Append to file (.csv)

Store Report without file path prompt

Use symbol data for file name

Automatically open generated report Print after saving

Include Image Bitmap JPEG

JPEG Image Quality: 1 - 100

ISO/IEC 15415 Options:

Enable MIL-STD-130M

Check type each time for ISO/IEC 15415 Verification

ISO/IEC 15415 Single Capture

ISO/IEC 15415 Multi-Capture

Enable UII Parsing

Step 10 — Verify Symbol

When you have finished setting and saving verification parameters and output preferences, move to the **Report** tab and click the button that corresponds to the type of verification routine you need to perform.

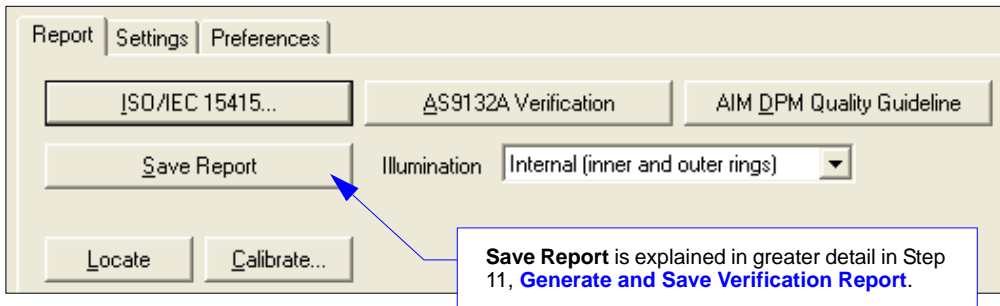

- For ISO/IEC 15415 Verification, click **ISO/IEC 15415...** and then select **Single Capture** or **Multi-Capture** when the **ISO 15415 Single or Multi-Capture** dialog appears.

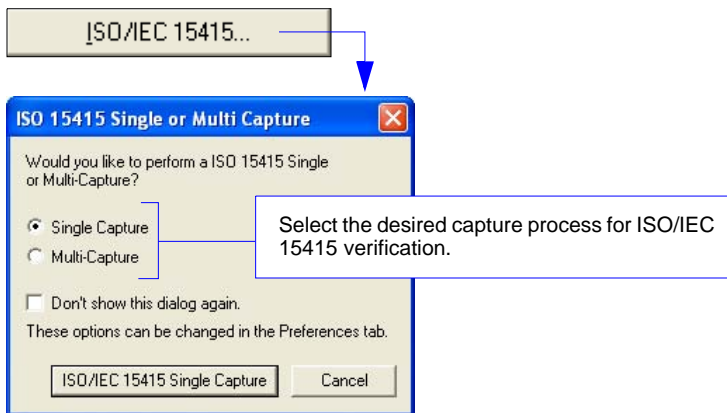

- For AS9132 Verification, click **AS9132A Verification**.

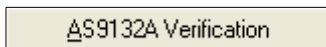

- For AIM DPM Verification, click **AIM DPM Quality Guideline**.

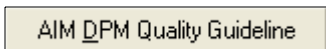

Verification results are displayed in the viewing area at the lower right of the **Verification** view.

ISO/IEC 15415 Single Capture Verification Results

The ISO/IEC 15415 Single Capture results show data concerning the reference decode algorithm, symbol contrast, fixed pattern damage, axial and grid non-uniformity, modulation, unused error correction capacity, print growth, symbology type, symbol size, element size, and pixels per element. All but the last four parameters are given a numeric and alphabetical grade.

```

---/05/660
-----
ISO/IEC 15415 Verification Report
-----
PARAMETER          RESULTS          GRADE
REFERENCE DECODE:  PASS          4 (A)
SYMBOL CONTRAST:   82%          4 (A)
FIXED PATTERN DAMAGE:  -----    4 (A)
AXIAL NON-UNIFORMITY:  0.01        4 (A)
GRID NON-UNIFORMITY:  0.01        4 (A)
MODULATION:        -----    4 (A)
UNUSED ECC:        100%        4 (A)
-----
FINAL GRADE:      4 (A)
NON-GRADED PARAMETERS:
PRINT GROWTH:     0.02
SYMBOL TYPE:      ECC200
SYMBOL SIZE:      10x10
ELEMENT SIZE:     0.019"
PIXELS/ELEMENT:  18.5
-----
SYMBOL DATA:     Y
    
```

ISO/IEC 15415 Multi-Capture Verification Results

The ISO/IEC Multi-Capture parameters are the same as those for ISO/IEC Single Capture, but Multi-Capture results are determined only after the symbol is read at five 72° intervals throughout a full 360° rotation. The overall symbol grade is based on an arithmetic mean of the results from the five reads.

```

-----
ISO/IEC 15415 VERIFICATION REPORT
-----
PARAMETER          SINGLE RESULTS          MEAN VALUES
REFERENCE DECODE:  4 (A) | 4 (A) | 4 (A) | 4 (A) | 4 (A) |  PASS
SYMBOL CONTRAST:   4 (A) | 4 (A) | 4 (A) | 4 (A) | 4 (A) |  82%
FIXED PATTERN DAMAGE:  4 (A) | 4 (A) | 4 (A) | 4 (A) | 4 (A) |  -----
AXIAL NON-UNIFORMITY:  4 (A) | 4 (A) | 4 (A) | 4 (A) | 4 (A) |  0.00
GRID NON-UNIFORMITY:  4 (A) | 4 (A) | 4 (A) | 4 (A) | 4 (A) |  0.00
MODULATION:        4 (A) | 4 (A) | 4 (A) | 4 (A) | 4 (A) |  -----
UNUSED ECC:        4 (A) | 4 (A) | 4 (A) | 4 (A) | 4 (A) |  100%
-----
FINAL GRADES :    4 (A) | 4 (A) | 4 (A) | 4 (A) | 4 (A) |
OVERALL GRADE:    4.0 (A)
-----
NON-GRADED PARAMETERS:
PRINT GROWTH:     0.01
SYMBOL TYPE:      ECC200
SYMBOL SIZE:      10x10
ELEMENT SIZE:     0.019"
PIXELS/ELEMENT:  18.6
-----
SYMBOL DATA:     Y
    
```

AS9132 Verification Results

The **AS9132** results show data concerning marking method, element shape, quiet zone, contrast, cell fill, cell size, dot ovality, dot shape, dot center offset, dot spacing, angle of distortion, symbology type, matrix size, and pixels per element. Symbol assessment is on a pass/fail basis.

AS9132A Verification Report				
MARKING METHOD: LASER/ELECTO-CHEM ETCH				
ELEMENT SHAPE: SQUARE				
PARAMETER	REQUIREMENT PER ELEMENT	RESULTS	FAIL IF 2% OF ELEMENTS FAIL	PASS/FAIL
QUIET ZONE:	=> One element			PASS
CONTRAST:	> 20%	85 %		PASS
CELL FILL/SIZE:	60% < size < 105%	101 %		PASS
ANGLE OF DISTORTION:	< +/- 7 Degrees	-0.13 degree		PASS
SYMBOL TYPE:	ECC200	ECC200		PASS
MATRIX SIZE:	10x10			
ELEMENT SIZE:	0.018"			
PIXELS/ELEMENT:	18.4			
SYMBOL DATA:	Y			

AIM DPM Verification Results

The **AIM DPM** results show data concerning reference decode algorithm, cell contrast, fixed pattern damage, axial and grid non-uniformity, cell modulation, unused error correction capacity, minimum reflectance, print growth, symbol type, symbol size, element size, and pixels per element. All but the last five parameters are given a numeric and alphabetical grade.

DPM/4.0/15/660/45Q			
AIM DPM Quality GuideLine			
PARAMETER	RESULTS	GRADE	
REFERENCE DECODE:	PASS	4	<A>
CELL CONTRAST:	85%	4	<A>
FIXED PATTERN DAMAGE:	----	4	<A>
AXIAL NON-UNIFORMITY:	0.00	4	<A>
GRID NON-UNIFORMITY:	0.01	4	<A>
CELL MODULATION:	----	4	<A>
UNUSED ECC:	100%	4	<A>
MINIMUM REFLECTANCE:	100%	4	<A>
FINAL GRADE:		4	<A>
NON-GRADED PARAMETERS:			
PRINT GROWTH:	-0.03		
SYMBOL TYPE:	ECC200		
SYMBOL SIZE:	10x10		
ELEMENT SIZE:	0.018"		
PIXELS/ELEMENT:	18.4		
SYMBOL DATA:	Y		

Step 11 — Generate and Save Verification Report

To generate a report containing your verification results, click the **Save Report...** button.



The **Grade Report Options** dialog will appear, unless you have disabled it in the **Preferences** dialog.

After report options are chosen, determine where the report will be stored on the host hard drive in the **Save As** dialog. Once you have specified a file name and clicked **Save**, **ESP** will begin transferring report data to the chosen directory location.

When the data transfer is complete, the verification report will appear in the chosen location on your hard drive. Open the folder and click on the report file. You can choose PDF, HTML, RTF, or CSV format for report output.

ISO/IEC 15415 Single Capture Verification Report

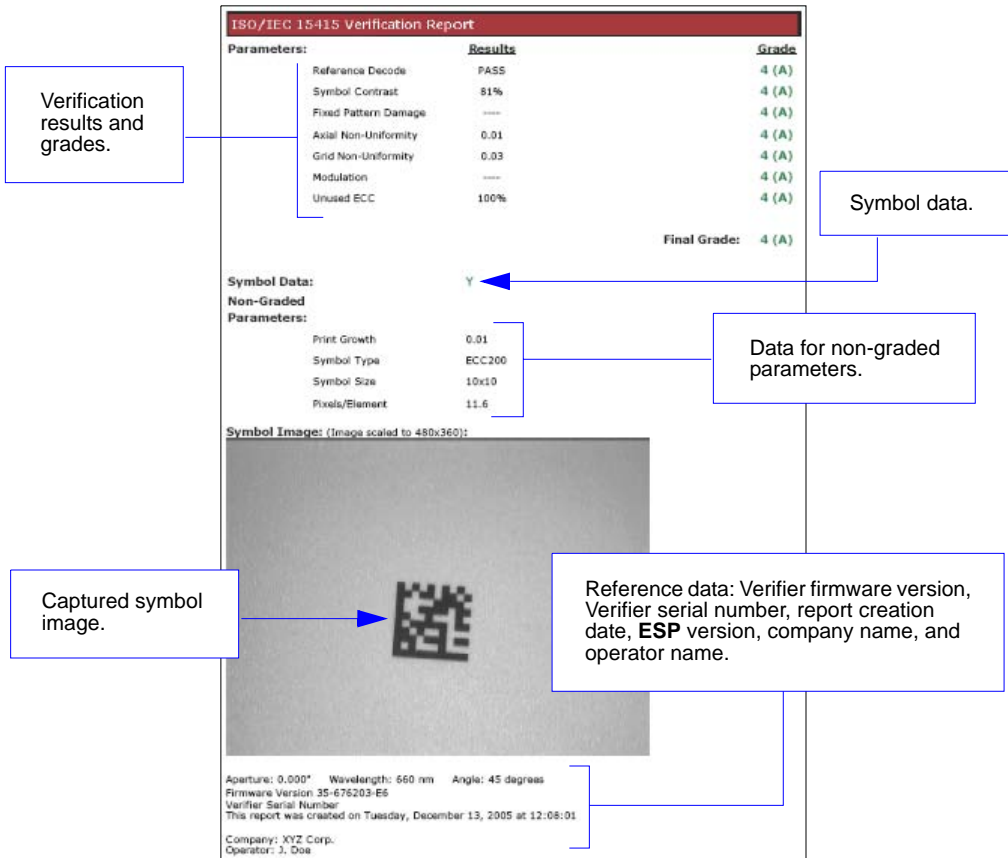

The screenshot shows a verification report window titled "ISO/IEC 15415 Verification Report". It is divided into several sections:

- Parameters:** A table with three columns: Parameters, Results, and Grade. The results are all "PASS" or "100%", and the grades are all "4 (A)".
- Symbol Data:** A section with a "Non-Graded" parameter "Y".
- Non-Graded Parameters:** A table with four rows: Print Growth (0.01), Symbol Type (ECC200), Symbol Size (10x10), and Pixels/Element (11.6).
- Symbol Image:** A grayscale image of a QR code, scaled to 480x360 pixels.
- Reference Data:** A section at the bottom containing technical details like Aperture, Wavelength, Angle, Firmware Version, Verifier Serial Number, creation date, Company, and Operator.

Callout boxes point to various parts of the report:

- "Verification results and grades." points to the Parameters table.
- "Symbol data." points to the Symbol Data section.
- "Data for non-graded parameters." points to the Non-Graded Parameters table.
- "Captured symbol image." points to the Symbol Image.
- "Reference data: Verifier firmware version, Verifier serial number, report creation date, ESP version, company name, and operator name." points to the Reference Data section.

Note: PDF version shown here.

ISO/IEC 15415 Multi-Capture Verification Report

ISO/IEC 15415 Verification Report

Parameters:	<u>Single Results</u>					<u>Mean Values</u>
Reference Decode	4 (A)	4 (A)	4 (A)	4 (A)	4 (A)	PASS
Symbol Contrast	4 (A)	4 (A)	4 (A)	4 (A)	4 (A)	80%
Fixed Pattern Damage	4 (A)	4 (A)	4 (A)	4 (A)	4 (A)	----
Axial Non-Uniformity	4 (A)	4 (A)	4 (A)	4 (A)	4 (A)	0.01
Grid Non-Uniformity	4 (A)	4 (A)	4 (A)	4 (A)	4 (A)	0.04
Modulation	4 (A)	4 (A)	4 (A)	4 (A)	4 (A)	----
Unused ECC	4 (A)	4 (A)	4 (A)	4 (A)	4 (A)	100%
Final Grades	4 (A)	4 (A)	4 (A)	4 (A)	4 (A)	
Overall Grade						4 (A)

Symbol Data:
Non-Graded
Parameters:

Print Growth	0.01
Symbol Type	ECC200
Symbol Size	10x10
Pixels/Element	11.6

Symbol Image: (Image scaled to 480x360):

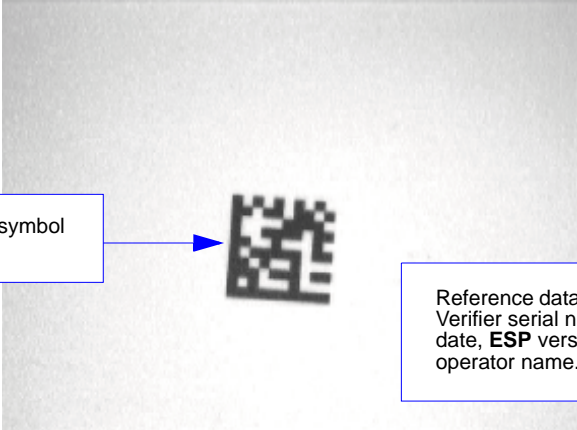

Aperture: 0.000* Wavelength: 660 nm Angle: 45 degrees
 Firmware Version 35-676203-E6
 Verifier Serial Number
 This report was created on Tuesday, December 13, 2005 at 12:14:49
 Company: XYZ Corp.
 Operator: J. Doe

Grades for individual captures.

Overall grade.

Symbol data.

Data for non-graded parameters.

Captured symbol image.

Reference data: Verifier firmware version, Verifier serial number, report creation date, **ESP** version, company name, and operator name.

Note: PDF version shown here.

AS9132 Verification Report

MICROSCAN AS9132A Verification Report

Working Method: 007 (None)
Element: 80000

Parameters	Requirement Per Element	Results	Fail if 2% of Element Fail	Pass/Fail
Spot Size	40 (Per Element)	---	---	Pass
Contrast	1.0%	8.7%	---	Pass
Full FOV Area	60% (1 spot = 100%)	100%	---	Pass
Def. Resoln./Elem.	1.0%	17% avg	1.7% failed	Pass
Def. Center Offset/Spacing	1.0%	8.7% avg	1.7% failed	Pass
Angle of Reflection	1 to 7 Degrees	1.88 degrees	---	Pass
Symbol Type	ES200	ES200	---	Pass

Non-Graded Parameters

Matrix Size: 25x25
Pixel/Element: 100 Pixel (800x)

Symbol Data: (S) (P) (M) (T) (C) (R) (S) (P) (M) (T) (C) (R) (S) (P) (M) (T) (C) (R)

SN: 01700012000000000000
Format: 2D
R/W (P): 12000000
R/W (S): 8000
SN: 0
R/W (P): 11000

Reference Data: Verifier firmware version, Verifier serial number, report creation date, ESP version, company name, and operator name.

Other Callouts: Verification results and pass / fail grades; Data for non-graded parameters; Symbol data; Captured symbol image; Parsed UII data. UII Parsing must be enabled in Preferences for parsed UII data to appear in verification reports.

Note: PDF version shown here.

AIM DPM Verification Report

MICROSCAN.
Bar Code Scanners | 2D Imagers
AIM DPM Quality Guideline

Parameters:	Results	Grade
Reference Decode:	PASS	4 (A)
Cell Contrast:	80%	4 (A)
Fixed Pattern Damage:	----	4 (A)
Axial Non-Uniformity:	0.07	3 (B)
Grid Non-Uniformity:	0.22	4 (A)
Cell Modulation:	----	4 (A)
Unused ECC:	100%	4 (A)
Minimum Reflectance:	100%	4 (A)
Final Grade:		3 (B)

DPM/3.0/04/660/45Q

Non-Graded Parameters:

Print Growth:	-0.06	Symbol Size:	16x16
Symbol Type:	ECC200	Element Size:	8.5 Pixels
			0.009*

Symbol Data: 123

Symbol Image: (scaled to 328x248)

Aperture: 0.004* Wavelength: 660 nm Lighting: 45Q

Firmware Version 35-676201-12
 Verifier Serial Number 0420383
 Wednesday, November 22, 2006 at 11:27:58
 Microscan ESP Version 3.4.1.6
 Company: AAA Acme Readers
 Operator: Joe Operator
 Any Label: Any Data

Verification results and pass / fail grades.

Data for non-graded parameters.

Symbol data.

Captured symbol image.

Reference data: Verifier firmware version, Verifier serial number, report creation date, ESP version, company name, and operator name.

Note: PDF version shown here.

2 Using ESP

Contents

Verification	2-2
Application Mode.....	2-3
Menu Toolbar.....	2-4
View	2-11
Navigating in ESP	2-12
Send/Receive Options	2-13

This section is designed to help you understand the structure, elements, and application of **ESP**.

When you open **ESP**, unless otherwise specified in the **ESP Preferences** dialog accessible from the **Options** heading on the menu toolbar, you will enter **EZ Mode** for initial setup. From there, you can enter **Application Mode (App Mode)** and access several configuration menus (**Verification**, **Communications**, **Read Cycle**, **Symbologies**, **I/O Parameters**, **Symbol Quality**, **Matchcode**, and **Diagnostics**), a **Camera** setup interface, a **Terminal** interface, a **Utilities** interface, and an **Output Format** interface.

ESP can be used to configure the Quadrus Verifier in three different ways:

- **Tree Controls:** Each configuration menu contains a list of all option settings that pertain to that specific element of Verifier operation. For example, the **Communications** menu shows a **Host Port Connections** option, and then a list of the sub-options **Baud Rate**, **Parity**, **Stop Bits**, and **Data Bits**. Each of these sub-options is configurable by using dropdown menus.
- **Graphic User Interfaces:** Settings can be configured using such point-and-click tools as radio buttons, zoom in/zoom out sliders, spin boxes, check boxes, and drag-and-drop functions.
- **Terminal:** **ESP's Terminal** interface allows you to send serial configuration and utility commands directly to the Verifier by typing them in the provided text field.

For **ESP** system requirements, see [System Requirements for ESP](#) in [Quick Start](#).

Verification

In the **Verification** view you are presented with the **Locate** and **Calibrate** options. After connecting to the Verifier, **Verification** is the first view you will see. You will be provided with on-screen instructions that will help you with symbol positioning, location, and calibration.

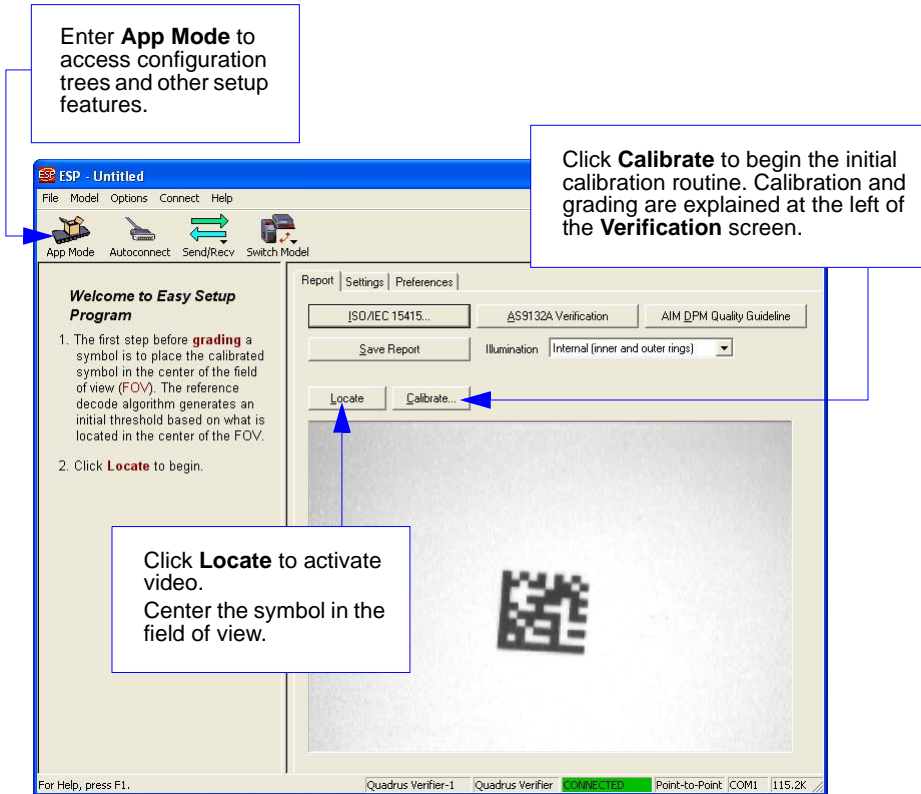

Locate

When you click **Locate**, the video view be activated. This allows you to center the candidate symbol in the Verifier's field of view before beginning the calibration routine.

Calibrate

Reflectance Calibration is required for ISO/IEC 15415 verification.

Illumination

The **Illumination** dropdown menu allows you to configure LED behavior from the **Verification** view. See [Illumination Source](#) for further detail about LED illumination options.

Application Mode

The Quadrus Verifier can be used as a reader as well as a verifier. **ESP's App Mode** offers complete control of configuration parameters.

From **Verification**, you can click on the **App Mode** button to access specific configuration menus, **Utilities** tools, **Camera** setup, **Output Format** options, and a **Terminal** window where serial commands can be entered.

Note: The **App Mode** and **EZ Mode** buttons appear in the same position to allow easy switching between these primary modes.

The screenshot shows the ESP software interface with several callouts:

- Click this icon to return to Verification.** (Points to the Verification icon in the toolbar)
- Menu toolbar.** (Points to the File, Model, Options, Connect, View, Help menu bar)
- Camera Setup, Evaluation, Region of Interest, IP Database, Dynamic Setup.** (Points to the Camera icon in the toolbar)
- Click here to open the Terminal view.** (Points to the Terminal icon in the toolbar)
- Click here for Ordered Output and Output Format features.** (Points to the Output Format icon in the toolbar)
- Click on icons in this row to access configuration trees like the one at left.** (Points to the row of icons below the toolbar)
- Click the Configuration icon to return to full App Mode view from Verification, Camera, Terminal, Utilities, or Output Format.** (Points to the Configuration icon in the toolbar)
- Decoded symbol data is shown in this table.** (Points to the Attribute/Value table)
- Click Capture and Decode to read the symbol in the field of view, and to see a high resolution image capture of the symbol.** (Points to the Capture and Decode button)

The interface includes a menu bar (File, Model, Options, Connect, View, Help), a toolbar with icons for Verification, Autoconnect, Send/Recv, Switch Model, Configuration, Camera, Terminal, Utilities, and Output Format. Below the toolbar are icons for Communication, Read Cycle, Symbolics, I/O, Matchcode, and Diagnostics. The main window displays a tree view of configuration parameters for the RS232/422 Host Port, including Host 422 Status, RS232 Auxiliary Port, Aux Port Connections (Baud Rate, Parity, Stop Bits, Data Bits), Aux Port Settings, Network, Ethernet, Preamble, Postamble, Response Timeout, LRC Status, and Aux Port System Data Status. A table at the bottom right shows decoded symbol data with columns for Attribute and Value. The status bar at the bottom indicates 'Quadrus Verifier-1', 'Quadrus Verifier', 'CONNECTED', 'Point-to-Point', 'COM1', and '115.2K'.

Menu Toolbar

File > New

Whenever **New** is selected, the default configuration of **ESP** is loaded.

Open/Save

When **Save** or **Save As** is selected, the **ESP** configuration is saved to the host computer's hard drive and available whenever the same file is selected under **Open**.

Important: When you save menu changes to your hard drive, these changes are not saved to your Verifier. The illustration below shows how settings can be saved and received between **ESP** and the Verifier, and **ESP** and the host hard drive.

File	
New	Ctrl+N
Open...	Ctrl+O
Save	Ctrl+S
Save As...	
Print...	Ctrl+P
Import...	
Export...	
Recent File	
Exit	

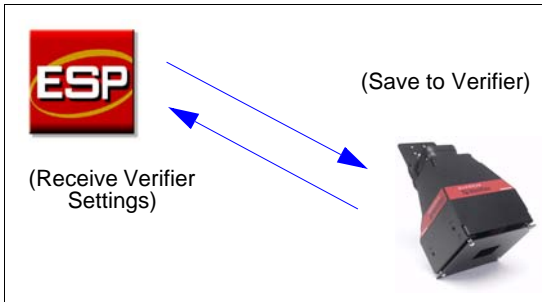

Import/Export

Import converts the ASCII settings from a text file to **ESP** configuration settings.

Export converts the active **ESP** configuration settings to an ASCII text file.

Model

In **Model** you can select any of the models shown in **ESP's** model menu. When you choose another model, your current connection to your present model will be terminated.

To connect to another model, select **New Model**, choose a new model from the menu, and click **OK**.

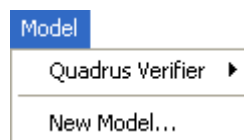

Note: All the models you have enabled by selecting will continue to appear in the Model menu and that the same menu is repeated when clicking the **Switch Model** icon.



When you save your **ESP** file, you will be saving the settings of all the models defined in a single **ESP** file.

Options

The **Options** menu allows you to save memos and set up **ESP Preferences**.

Note: Preferences will be saved and loaded into **ESP** when **ESP** is opened next, whether or not you save the **ESP** file.

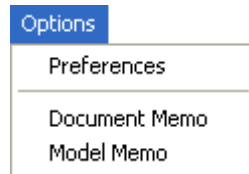

Preferences

General Tab

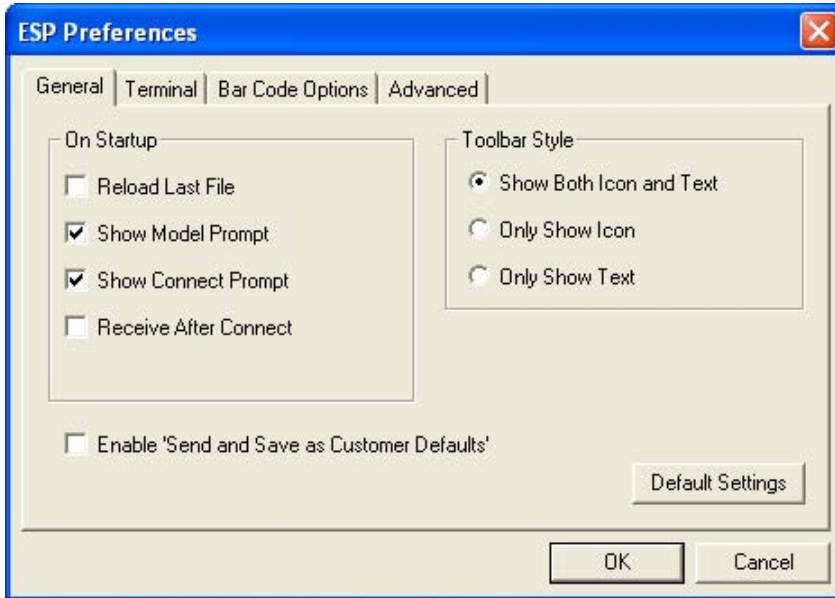

Reload Last File

At startup, reloads the last file saved to the host computer's hard drive.

Show Model Prompt

At startup, remembers the last connected model and displays it in the **Connecting...** dialog whenever you attempt to connect.

Show Connect Prompt

At startup, displays the **Would you like to connect...?** prompt.

Receive After Connect

At startup, loads the Verifier's settings into **ESP**. (This is not recommended if you want to preserve your **ESP** settings for future use.)

Enable 'Send and Save as Customer Defaults'

At startup, enables the **Send and Save as Customer Defaults** option in the **Send/Recv** command.

Terminal Tab

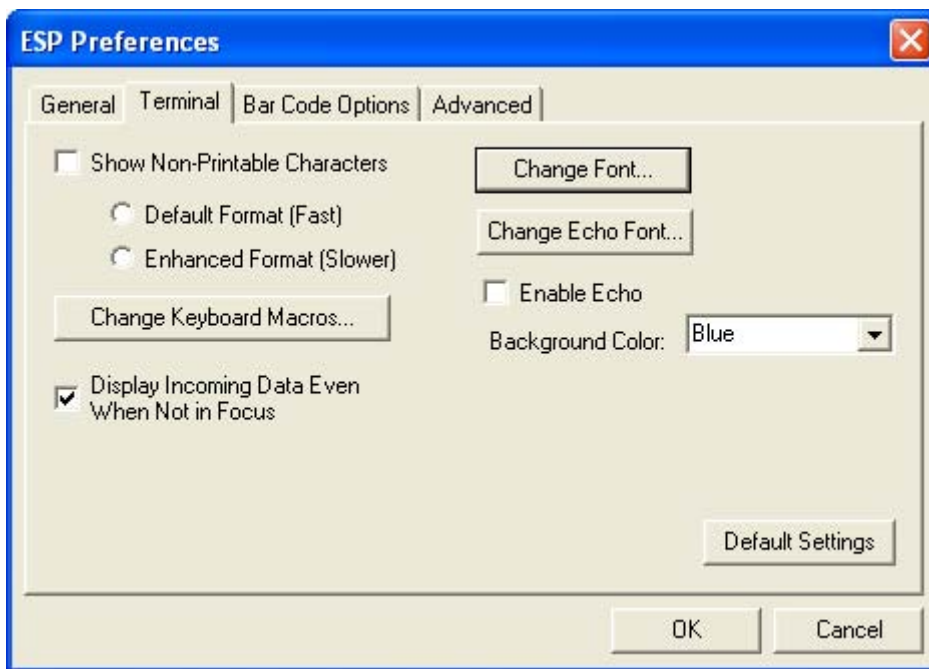

When **Show Non-Printable Characters** is checked, characters such as “CRLF” will be displayed in the **Terminal** window. When **Enhanced Format** is checked, the characters are displayed with more detailed formatting.

Change Keyboard Macros

In this dialog you can first select the function key and then enter your macro keystrokes in the associated key map. For example, to make **Ctrl-F5** the keystroke to enable, send a trigger character, select **F5**, and then in the **Ctrl** row, enter **<trigger character>** and click **OK**. Then whenever the **Ctrl-F5** keystroke is pressed, the trigger character will start the read cycle.

Change Font

Allows you to modify the font used for decode data received from the Verifier on the **Terminal** screen.

Change Echo Font

Allows you to modify the font used for command characters typed into the **Terminal** view.

Bar Code Options Tab

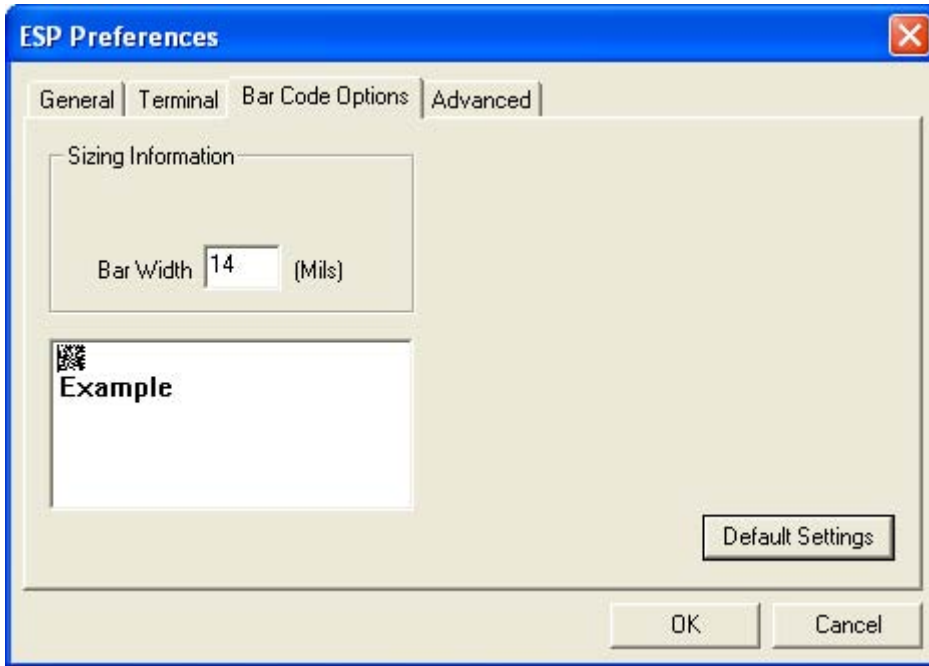

The **Bar Code Options** dialog allows you to set the size (in mils) of user-created symbols.

Sizing Information

Sets the bar width (in thousands of an inch) of user-created symbols. A bar width of 14 is 0.014 inches.

Advanced Tab

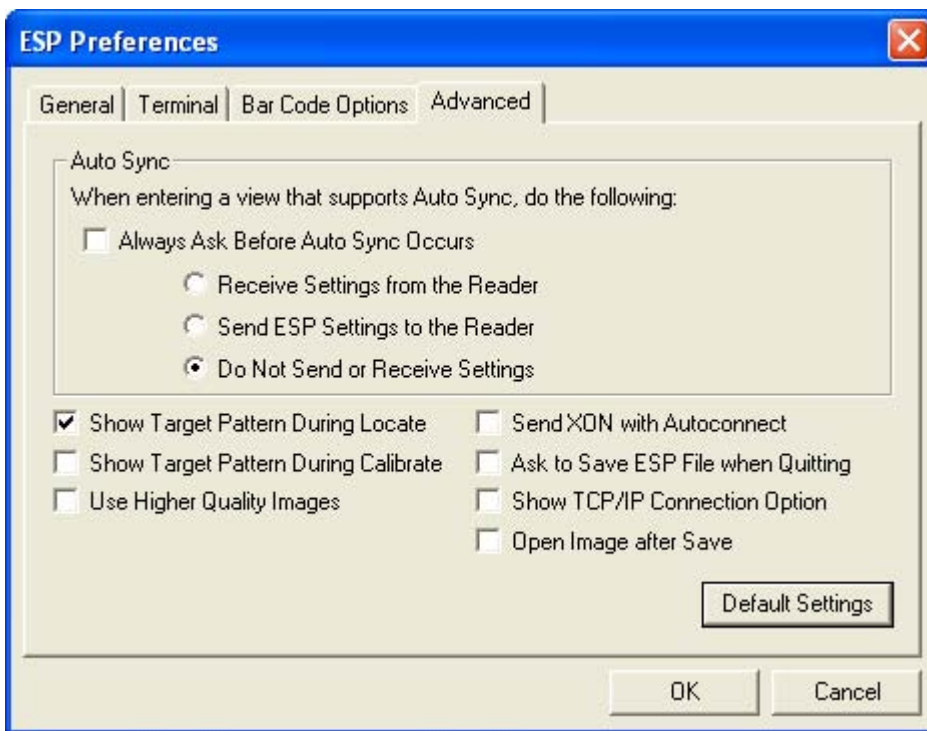

The **Auto Sync** dialog at the top of the **Advanced** tab allows you to determine whether **Auto Sync** will be automatically enabled in sections of **ESP** where it is used, or if it will ask you before it enables **Auto Sync** functions.

Always Ask Before Auto Sync Occurs

If you check this option box, you are then able to determine what specific Auto Sync functions will be enabled. **Receive Settings from the Reader** will automatically send the Verifier's settings to **ESP** when Auto Sync is enabled. **Send ESP Settings to the Reader** will automatically send all Verifier configuration settings chosen in **ESP** to the Verifier. **Do Not Send or Receive Settings** creates a condition in which Auto Sync will not send Verifier settings to **ESP**, or send **ESP** settings to the Verifier.

Send XON with Autoconnect

Sends an **XON (Begin Transmission)** command to the Verifier before starting the **Autoconnect** routine.

Document Memo

The information you type in the **Document Memo** field will appear in a context-sensitive text box whenever your cursor hovers over the **Document Memo** item on the **Options** menu.

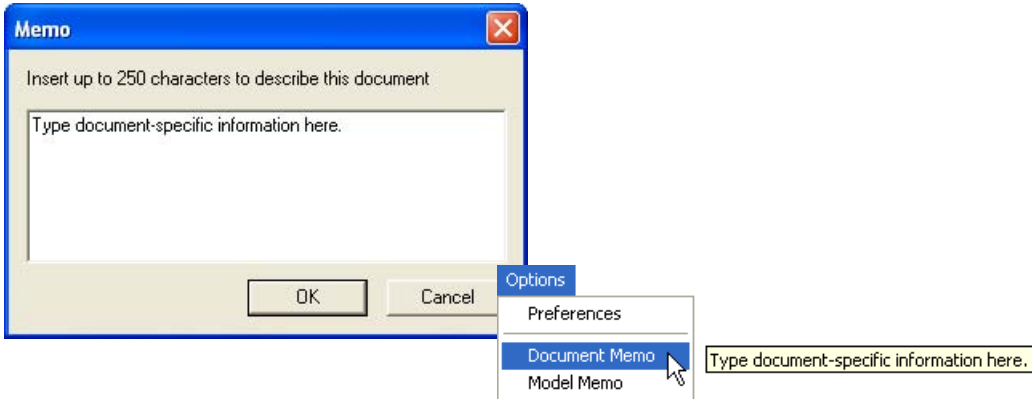

Model Memo

Similar to **Document Memo**, the information you type in the **Model Memo** field will appear in a context-sensitive text box whenever your cursor hovers over the **Model Memo** item on the **Options** menu. Memos created in **Model Memo** are specific to the model enabled when the message was created.

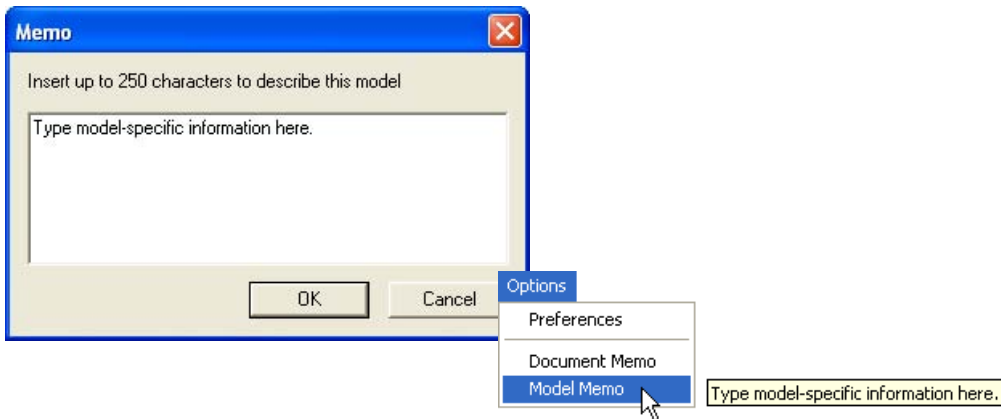

Note: Memos must be saved in a **.esp** file if you want them to be available in your next session. If you do not save your current session, any memos that you have entered during the session will be discarded, and will be unavailable in your next session.

View

The **View** menu allows you to move quickly between interfaces without using the icon buttons on the **App Mode** toolbar. It also allows you to access the **Bar Code Dialog**.

Bar Code Dialog

In the **Bar Code Dialog** you can create symbols by typing the text you wish to encode. This is a useful tool for creating configuration symbols, allowing you to configure your Verifier by reading the symbols you create.

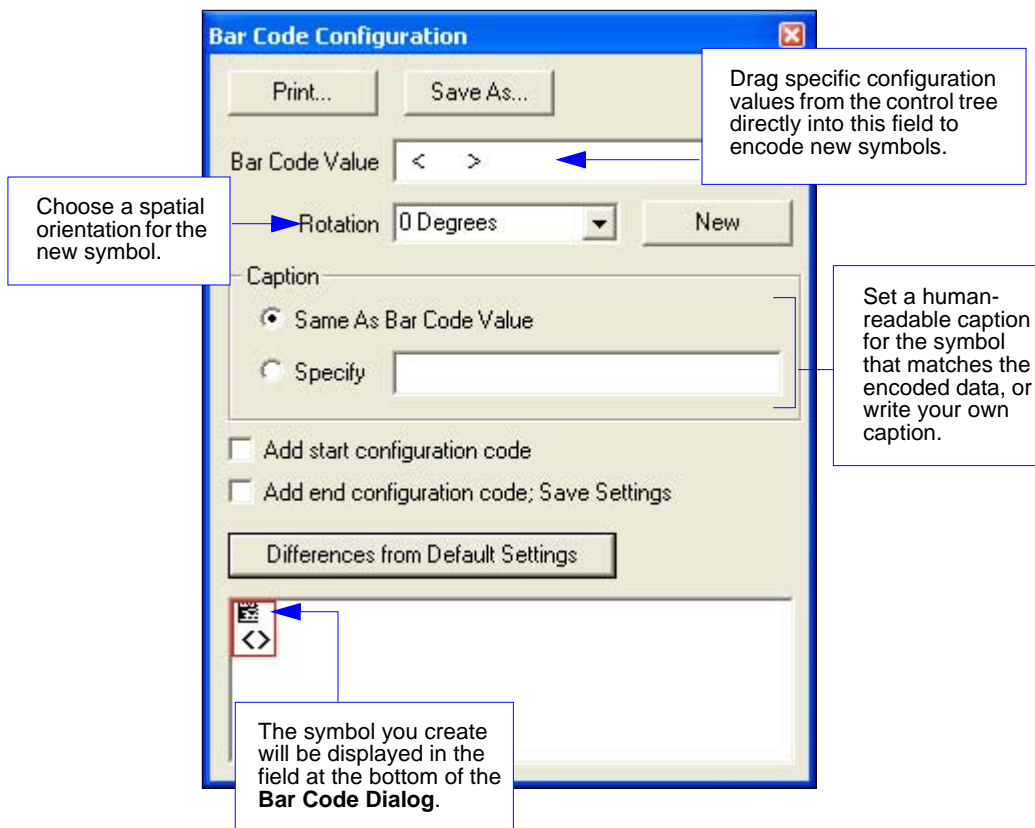

Navigating in ESP

To change Verifier settings, or to access the **Configuration**, **Camera**, **Terminal**, **Utilities**, or **Output Format** views, click the **App Mode** button.



To return to **Verification**, click the **Verification** button.



To make changes to configuration settings in the control trees:

Open or close the full contents of a control tree by holding down the **Alt** key and **single-clicking** here.

- **Left click** on the **+** to expand menu items.
- **Double-click** the desired parameter and **single-click** in the selection box to view options.
- Place your cursor in the selection box, scroll down to the setting you want to change, and **single-click** the setting.
- **Left click** again on the open screen to complete the selection.

The **X** denotes the default option setting.

- **Right click** on the open screen and select **Save to Reader** to implement the command in the Verifier. You can send the command without saving it, or you can send and save the command simultaneously.

Send/Receive Options

To access **Receive**, **Save** and **Default** options, click the **Send/Recv** button. You can also access these options by right-clicking in any of the configuration views.



Receiving

From the **Send/Recv** menu, select **Receive Reader Settings**.

Caution: Do not select this option if you do not want to upload the Verifier's settings. For example, if your **ESP** file has a number of custom settings that you want to maintain and download into the Verifier, these settings would be lost by choosing **Yes**.

This is useful if you want to receive (upload) the Verifier's settings and save them as a file for future use. For example, if your Verifier has settings that you do not want to change, choosing **Yes** would allow you to load those settings to **ESP** and save them in a **ESP** file for later retrieval.

Receiving the Verifier's settings will also assure that you will not be subsequently saving any unwanted changes that you or someone else has made previously in **ESP**.

Saving

- **Send, No Save (<A>)**

Saves **ESP** settings to *current* memory.

- **Send and Save (<Z>)**

Activates all changes in current memory *and* saves settings for power-on.

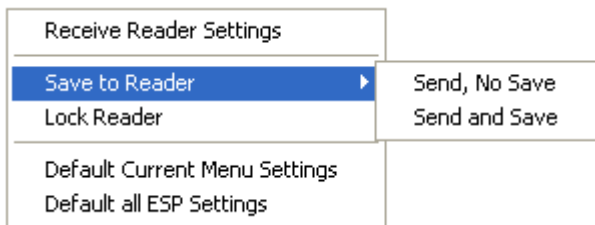

- **Send and Save as Customer Defaults (<Zc>)**

Saves your own default settings for quick retrieval with a **<Zrc>** command.

This option will be visible only if you have checked **Enable 'Send and Save as Customer Defaults'** in the **ESP Preferences** dialog.

Defaulting

When you select **Default Current Menu Settings** or **Default all Settings**, you are only defaulting the **ESP** settings.

Advanced Options

Send Current View

This is the same as **Save to Reader > Send No Save** except that only the commands in the current configuration tree are sent.

Send Current Command

This is the same as **Send Current View** , except that it saves only the command that is currently selected.

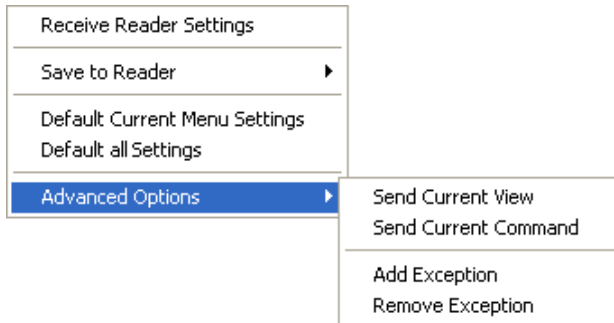

Add / Remove Exception

After you perform a **Receive Reader Settings** command¹ and you click on the **Add Exception** option, you may see a list of serial commands. These are commands that may be in your Verifier’s firmware, but not included in, or different from, your current version of **ESP**.

You can edit these commands by double-clicking on them and changing them as needed.

It is important to note that these commands will be saved to your Verifier whenever you send a **Save to Reader** command, or an **<A>** or a **<Z>** command.

Also, if there is a corresponding **ESP** menu item, the **ESP Value** column for that item will be blank following a **Receive Reader Settings** command.

1. From the Send/Recv button or by right-clicking from within the configuration trees.



3 Verification

Contents

Verification Serial Commands	3-2
Verification Operational Commands	3-2
Overview of Verification	3-3
ISO/IEC 15415 Evaluation Parameters	3-5
AS9132 Evaluation Parameters	3-7
AIM DPM Evaluation Parameters	3-10
General Verification Serial Output	3-12
General Verification Output by ESP	3-17
ISO/IEC 15415 Verification Setup	3-19
ISO/IEC 15415 Verification Setup by ESP	3-21
ISO/IEC 15415 Serial Output	3-23
ISO/IEC 15415 Output by ESP	3-33
AIM DPM Verification Setup	3-40
AIM DPM Verification Setup by ESP	3-42
ISO/IEC 15415 Verification by Serial Command	3-44
AS9132/JES 131 Marking Method	3-49
AS9132/JES 131 Marking Method by ESP	3-51
AS9132 Serial Output	3-53
AS9132 Output by ESP	3-62
AS9132 Verification by Serial Command	3-67
AIM DPM Verification by Serial Command	3-68
Verification by ESP	3-70

This section describes the verification process, including specification requirements, software configuration, step-by-step procedures, and report output.

Verification Serial Commands

ISO/IEC 15415 Verification Setup	< K531 ,aperture,wavelength,angle,reflectance maximum,reflectance minimum>
AIM DPM Verification Setup	< K532 ,minimum element size,maximum element size,wavelength,lighting>
General Verification Serial Output	< K708 ,separator character,unused (0),ISO grade type,symbol type,symbol dimension/size>
AS9132/JES 131 Marking Method	< K711 ,element shape,marking method,JES 131>
AS9132 Serial Output	< K712 ,dot center offset,percentage failed offset,cell fill,percentage failed cell fill,dot ovality,percentage failed ovality,angle of distortion,symbol contrast,quiet zone grade,pixels per element value>
ISO/IEC 15415 Serial Output	< K756 ,grade,aperture value,wavelength value,light angle value,decode grade,symbol contrast,fixed pattern damage grade,axial non-uniformity,grid non-uniformity,modulation grade,unused error correction,print growth value,pixels per element value>

Verification Operational Commands

ISO/IEC 15415 Reflectance Calibration	< @VER >
ISO/IEC 15415 Single Capture Verification	< V1 >
ISO/IEC 15415 Multi-Capture Verification	< V2 >
AS9132 Verification	< V3 >
AIM DPM Reflectance Calibration	< @AIMDPM,R-max,R-min >
AIM DPM Verification	< V4 >

Overview of Verification

The use of Data Matrix symbols in ID automation applications requires high-quality marks. The purpose of verification is to ensure reliability and consistency of symbols, based on the strict criteria outlined in the AS9132 and ISO/IEC 15415 standards and the AIM DPM quality guideline. The Quadrus Verifier is designed to evaluate marks based on the specific parameters in AS9132, ISO/IEC 15415, and AIM DPM.

AS9132

The AS9132 standard specifies uniform quality and technical requirements for direct part marking with Data Matrix symbols. Direct part marking can be achieved by a variety of means, including ink jet, dot peen, laser etch, and chemical etch.

Note: **AS9132** and **AS9132A** are used interchangeably throughout this documentation. “AS9132” is the name of the specification, and the suffix “A” denotes the current published version of the specification.

ISO/IEC 15415

The ISO/IEC 15415 standard specifies the methodologies for measuring, evaluating, and grading 2D symbol characteristics in order to provide an overall symbol grade.

AIM DPM

The AIM DPM quality guideline assesses direct part mark quality for a number of parameters, including cell contrast, fixed pattern damage, axial and grid non-uniformity, cell modulation, unused error correction capacity, and minimum reflectance. Direct part marking can be achieved by a variety of means, including ink jet, dot peen, laser etch, and chemical etch.

AIM DPM is called out in **MIL-STD-130N** as the preferred guide for ensuring symbol quality and reliability.

MIL-STD-130N

MIL-STD-130N is a standard for implementing ID automation processes to track United States Department of Defense property.

The DoD’s primary means of parts traceability is the IUID initiative. IUID, which stands for “Item Unique Identification”, is a system of establishing unique item identifiers (UIIs) by assigning a machine-readable character string or number to an item (a single hardware component or grouping of subassemblies), thereby distinguishing it from other items.

Tracing items in this way requires the use of reliable symbols, whether in the form of printed labels or marks applied directly to parts. MIL-STD-130N calls out AIM DPM as the preferred standard for ensuring symbol quality and reliability.

ISO/IEC 15426-2 Verifier Certification

ISO/IEC 15426-2 is a verifier conformance standard that is referenced in the introduction to the ISO/IEC 15415 specification. Conformance to ISO/IEC 15426-2 is required for certification as a true Data Matrix verifier.

Why is Verifier re-calibration important?

Like any measurement device, the Quadrus Verifier requires regular maintenance and calibration to ensure reliable and accurate operation over time.

How often does the Verifier need to be re-calibrated / re-certified?

Microscan recommends that the Quadrus Verifier be re-calibrated and re-certified once every year.

Important: Even if the Verifier has not been used during the first year of ownership, it should still be sent to Microscan for re-calibration one year from the date of original factory calibration.

What is the process for Verifier re-calibration / re-certification?

Schedule a return under the **SRO** (Service Return Order) process. Contact the **Microscan Service Department** at 425.226.5700 to initiate the SRO process.

ISO/IEC 15415 Evaluation Parameters

Symbol Contrast

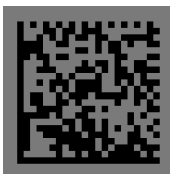

Symbol Contrast is the value difference between light and dark symbol elements, and between the quiet zone and perimeter elements.

This example shows a low-contrast symbol. The light and dark elements are too close in value, which undermines readability.

Fixed Pattern Damage

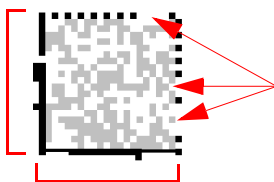

Fixed Pattern Damage refers to finder pattern and clock pattern damage.

Notice the missing elements in the clock pattern and the damaged L-pattern in the example symbol.

Axial Non-Uniformity

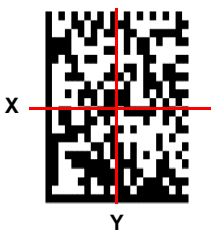

Axial Non-Uniformity is the amount of deviation along the symbol's major axes. In this example, the symbol's Y-axis dimension is clearly greater than its X-axis dimension.

Grid Non-Uniformity

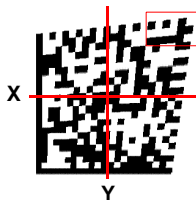

Grid Non-Uniformity refers to a symbol's cell deviation from the ideal grid of a theoretical "perfect symbol".

The Data Matrix reference decode algorithm is applied to a binarized image of the symbol, comparing its grid intersections to ideal grid intersections. The greatest distance from an actual to a theoretical grid intersection determines the Grid Non-Uniformity grade.

The reference decode algorithm plots the symbol's grid intersections and compares them to an ideal grid.

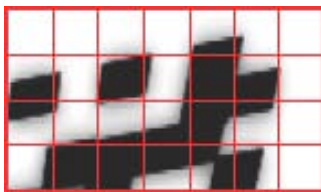

Symbol Detail

Actual grid intersection

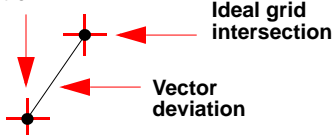

The largest vector deviation on the grid determines the Grid Non-Uniformity grade.

Modulation



Modulation refers to the reflectance uniformity of a symbol's light and dark elements. In this example, notice that the light/dark values of some elements are inconsistent.

Unused Error Correction



Unused Error Correction indicates the amount of available error correction in a symbol. Error Correction is a method of reconstructing or replacing data that is lost through symbol damage. 100% Unused Error Correction is ideal. The example at left is an ECC 200 Data Matrix symbol in good condition. "ECC 200" indicates the error correction level of the symbology. A higher number indicates more robust error correction capacity.

Print Growth

Print Growth refers to the deviation (larger or smaller) of actual element size from intended element size due to printing problems. When a symbol is printed, the ink may "bleed" when it comes in contact with the substrate, causing an **Overprint**. If there is not enough ink, or if there is some other problem with printing equipment, the result may be an **Underprint**.



Overprint



Underprint

Pixels Per Element

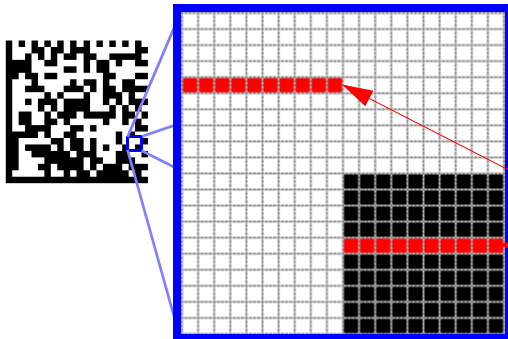

Pixels Per Element refers to the number of pixels in each individual symbol element.

10 pixels

This magnified symbol detail contains 4 elements, each with a width of 10 pixels.

AS9132 Evaluation Parameters

Dot Center Offset

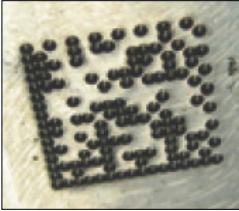

A symbol's **Dot Center Offset** value indicates the deviation of actual dot centers from theoretical or "ideal" dot centers.



The difference between the ideal and actual dot centers is the **Dot Center Offset** value.

Cell Fill

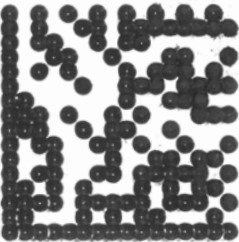

Cell Fill is the percentage of the ideal cell size that the module or element fills.

The example at left shows dot peen elements that overfill the ideal cell size. The elements of the dots exceed the cell boundaries.

Dot Ovality

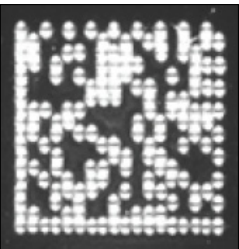

Dot Ovality is the extent to which round elements deviate from a perfect circle.

The example at left shows a symbol that would receive an unfavorable Dot Ovality evaluation.

Ideal dot shape

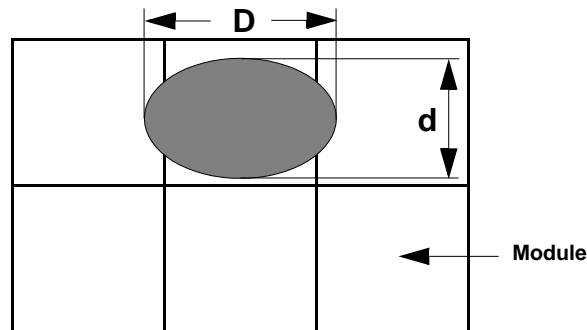
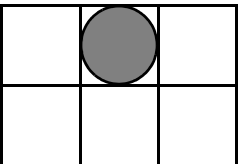

If $D - d > 20\%$ of nominal module size, then dot ovality is out of spec with AS9132 requirements.

Angle of Distortion

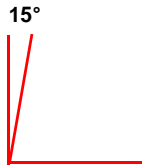
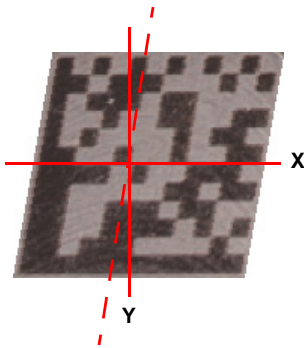

The **Angle of Distortion** is the symbol's deviation from a 90° relation between row and column.

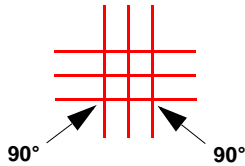

Ideal: 90° Row/Column

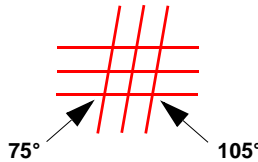

15° Deviation from Ideal Row/Column

Symbol Contrast

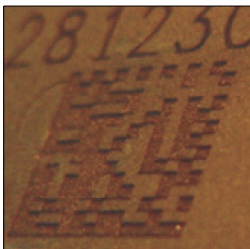

Symbol Contrast is the value difference between light and dark symbol elements, and between the quiet zone and perimeter elements.

This example shows a low-contrast symbol. The dark elements (etched) and the light elements (the substrate's surface) are too close in value, which undermines readability.

Quiet Zone

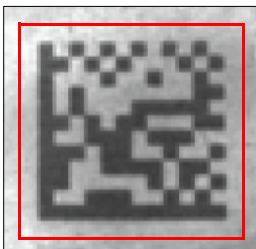

The **Quiet Zone** is an unmarked space of at least one element in width surrounding the symbol, required for symbol readability.

The red box in the example represents the outer perimeter of the *minimum* Quiet Zone requirement. The Quiet Zone can be any amount greater than one element in width, but any Quiet Zone width less than one element will make the symbol difficult or impossible to read.

Pixels Per Element

Pixels Per Element refers to the number of pixels in each individual symbol element.

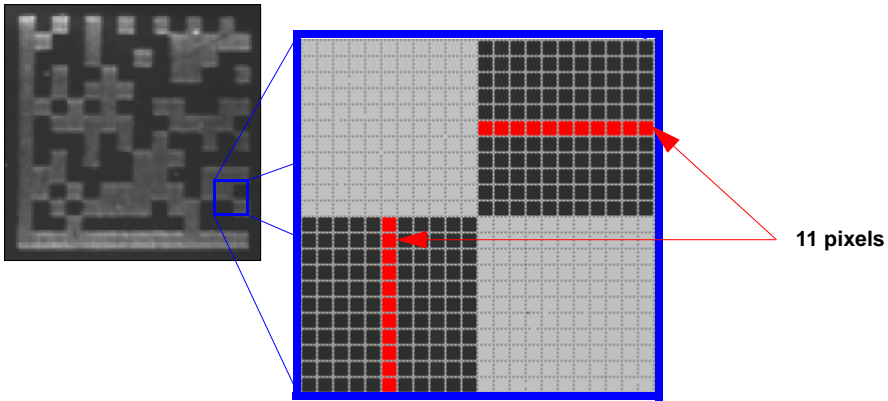

This magnified symbol detail contains **4** elements, each with a width of **11** pixels.

AIM DPM Evaluation Parameters

Cell Contrast

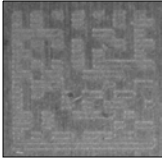

Cell Contrast is the value difference between light and dark symbol elements, and between the quiet zone and perimeter elements. This example shows a low-contrast direct part mark symbol. The light and dark elements are too close in value, which undermines readability.

Fixed Pattern Damage

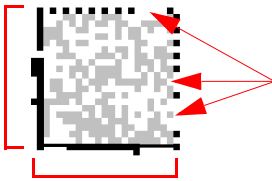

Fixed Pattern Damage refers to finder pattern and clock pattern damage. Notice the missing elements in the clock pattern and the damaged L-pattern in the example symbol.

Axial Non-Uniformity

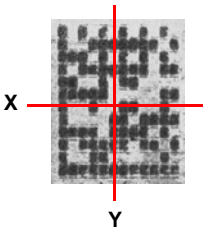

Axial Non-Uniformity is the amount of deviation along the symbol's major axes. In this example, the symbol's Y-axis dimension is clearly greater than its X-axis dimension.

Grid Non-Uniformity

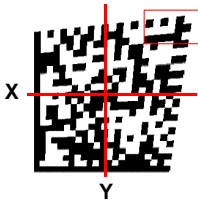

Grid Non-Uniformity refers to a symbol's cell deviation from the ideal grid of a theoretical "perfect symbol". The Data Matrix reference decode algorithm is applied to a binarized image of the symbol, comparing its grid intersections to ideal grid intersections. The greatest distance from an actual to a theoretical grid intersection determines the Grid Non-Uniformity grade.

The reference decode algorithm plots the symbol's grid intersections and compares them to an ideal grid.

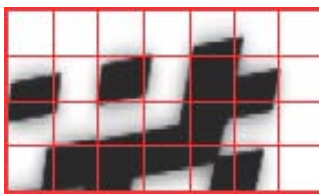

Symbol Detail

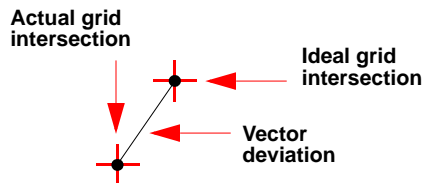

The largest vector deviation on the grid determines the Grid Non-Uniformity grade.

Cell Modulation



Modulation refers to the reflectance uniformity of a symbol's light and dark elements.

In this example of a dot peen mark, notice that the light/dark values of some of the elements are inconsistent.

Unused Error Correction



Unused Error Correction indicates the amount of available error correction in a symbol. 100% Unused Error Correction is ideal.

Print Growth

Print Growth refers to the deviation (larger or smaller) of actual element size from intended element size due to printing problems. When a symbol is printed or chemical etched, the ink or etching agent may "bleed" when it comes in contact with the substrate, causing an **Overprint**. If there is not enough ink, or if there is some other problem with printing or etching equipment, the result may be an **Underprint**.



Overprint



Underprint

Pixels Per Element

Pixels Per Element refers to the number of pixels in each individual symbol element.

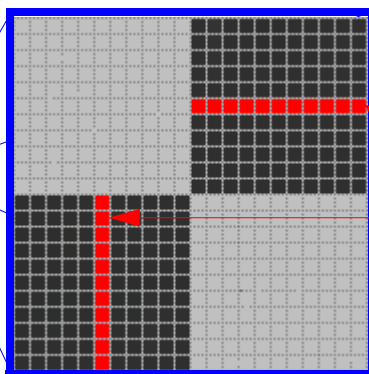
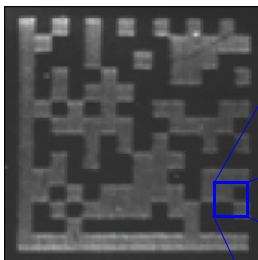

11 pixels

This magnified symbol detail contains 4 elements, each with a width of 11 pixels.

General Verification Serial Output

This command allows the user to determine the specific output settings for **Separator Character**, **ISO Grade Type**, **Symbol Type**, and **Symbol Dimension/Size** as they appear in ISO/IEC 15415 and AS9132 verification output.

Separator Character

Definition: Inserts a separator between each field of verification report output.

Serial Cmd: `<K708,separator character,unused (0),ISO grade type,symbol type,symbol dimension/size>`

Default: `,` (comma)

Options: Any ASCII character except **NULL**, `<`, or `>`.

ISO/IEC 15415 Output Example: Default **Separator Character** (comma) highlighted below.

```
symbol_data,2,005,660,45,4,4,075,3,1,0.11,3,0.43,3,2,057,-0.82,08.7,ECC200,032x032
```

AS9132 Output Example: Default **Separator Character** (comma) highlighted below.

```
symbol_data,,P,F,045,057,,P,002,001,,F,-08.20,,P,034,,P,12.4,ECC200,018x018
```

ISO Grade Type

Definition: Determines whether ISO/IEC 15415 grades are in alphabetical or numeric form.

Note: This setting does not affect AS9132 output, because AS9132 symbol evaluations are on a pass/fail basis.

Serial Cmd: `<K708,separator character,unused (0),ISO grade type,symbol type,symbol dimension/size>`

Default: **Alpha**

Options: **0 = Alpha**
1 = Numeric

Alpha (ISO Grade Type)

If alphabetical grading is chosen, ISO/IEC 15415 grades will be represented by the letters **A** (best), **B**, **C**, **D**, or **F** (fail).

Output Example: All **Alpha** grades highlighted below.

```
symbol_data , C , 005 , 660 , 45 , A , A , 075 , B , D , 0.11 , B , 0.43 , B , C , 057 , -0.82 ,
08.7 , ECC200 , 032x032
```

Output	Command Field
2 / C	Grade
005	Aperture Value
660	Wavelength Value
45	Light Angle Value
4 / A	Decode Grade
4 / A	Symbol Contrast Grade
075	Symbol Contrast Value
3 / B	Fixed Pattern Damage Grade
1 / D	Axial Non-Uniformity Grade
0.11	Axial Non-Uniformity Value
3 / B	Grid Non-Uniformity Grade
0.43	Grid Non-Uniformity Value
3 / B	Modulation Grade
2 / C	Unused Error Correction Capacity Grade
057	Unused Error Correction Capacity Value
-0.82	Print Growth Value
08.7	Pixels Per Element Value
ECC200	Symbol Type
032x032	Symbol Dimensions

Numeric (ISO Grade Type)

If numeric grading is chosen, ISO/IEC 15415 grades will be represented by **0** (fail), **1**, **2**, **3**, or **4** (best) for Single-Capture verification, or by the decimal values **0.0** to **4.0** for Multi-Capture verification.

Output Example: All **Numeric** grades highlighted below.

symbol_data, **2**, 005, 660, 45, **4**, **4**, 075, **3**, **1**, 0.11, **3**, 0.43, **3**, **2**, 057, -0.82, 08.7, ECC200, 032x032

Output	Command Field
2 / C	Grade
005	Aperture Value
660	Wavelength Value
45	Light Angle Value
4 / A	Decode Grade
4 / A	Symbol Contrast Grade
075	Symbol Contrast Value
3 / B	Fixed Pattern Damage Grade
1 / D	Axial Non-Uniformity Grade
0.11	Axial Non-Uniformity Value
3 / B	Grid Non-Uniformity Grade
0.43	Grid Non-Uniformity Value
3 / B	Modulation Grade
2 / C	Unused Error Correction Capacity Grade
057	Unused Error Correction Capacity Value
-0.82	Print Growth Value
08.7	Pixels Per Element Value
ECC200	Symbol Type
032x032	Symbol Dimensions

Symbol Type

Definition: When enabled, identifies the symbology of the mark being evaluated in the verification report output.

Serial Cmd: <**K708**,separator character,unused (0),ISO grade type,**symbol type**,symbol dimension/size>

Default: **Disabled**

Options: **0 = Disabled** 1 = Enabled

ISO/IEC 15415
Output Example: **Symbol Type** highlighted below.

```
symbol_data,2,005,660,45,4,4,075,3,1,0.11,3,0.43,3,2,057,-0.82,
08.7,ECC200,032x032
```

AS9132 Output
Example: **Symbol Type** highlighted below.

```
symbol_data,P,004,003,F,045,057,P,002,001,F,-08.20,P,034,P,12.4,
ECC200,018x018
```

ISO/IEC 15415 Output	Command Field	AS9132 Output	Command Field
2 / C	Grade	P	Dot Center Offset Grade
005	Aperture Value	004	Dot Center Offset Worst Case Value
660	Wavelength Value	003	Dot Center Offset Average Value
45	Light Angle Value	F	Cell Fill Grade
4 / A	Decode Grade	045	Cell Fill Worst Case Value
4 / A	Symbol Contrast Grade	057	Cell Fill Average Value
075	Symbol Contrast Value	P	Dot Ovality Grade
3 / B	Fixed Pattern Damage Grade	002	Dot Ovality Worst Case Value
1 / D	Axial Non-Uniformity Grade	001	Dot Ovality Average Value
0.11	Axial Non-Uniformity Value	F	Angle of Distortion Grade
3 / B	Grid Non-Uniformity Grade	-08.20	Angle of Distortion Value
0.43	Grid Non-Uniformity Value	P	Symbol Contrast Grade
3 / B	Modulation Grade	034	Symbol Contrast Value
2 / C	Unused ECC Grade	P	Quiet Zone Grade
057	Unused ECC Value	12.4	Pixels Per Element Value
-0.82	Print Growth Value	ECC200	Symbol Type
08.7	Pixels Per Element Value	018x018	Symbol Dimensions
ECC200	Symbol Type		
032x032	Symbol Dimensions		

Symbol Dimension/Size

Definition: When enabled, states the dimensions (row value x column value) of the mark being evaluated in the verification report output.

Serial Cmd: <**K708**,separator character,unused (0),ISO grade type,symbol type,**symbol dimension/size**>

Default: **Disabled**

Options: **0 = Disabled**
1 = Enabled

ISO/IEC 15415 Output Example: **Symbol Dimensions** highlighted below.

symbol_data,2,005,660,45,4,4,075,3,1,0.11,3,0.43,3,2,057,-0.82,08.7,ECC200,**032x032**

AS9132 Output Example: **Symbol Dimensions** highlighted below.

symbol_data,P,004,003,F,045,057,P,002,001,F,-08.20,P,034,P,12.4,ECC200,**018x018**

ISO/IEC 15415 Output	Command Field	AS9132 Output	Command Field
2 / C	Grade	P	Dot Center Offset Grade
005	Aperture Value	004	Dot Center Offset Worst Case Value
660	Wavelength Value	003	Dot Center Offset Average Value
45	Light Angle Value	F	Cell Fill Grade
4 / A	Decode Grade	045	Cell Fill Worst Case Value
4 / A	Symbol Contrast Grade	057	Cell Fill Average Value
075	Symbol Contrast Value	P	Dot Ovality Grade
3 / B	Fixed Pattern Damage Grade	002	Dot Ovality Worst Case Value
1 / D	Axial Non-Uniformity Grade	001	Dot Ovality Average Value
0.11	Axial Non-Uniformity Value	F	Angle of Distortion Grade
3 / B	Grid Non-Uniformity Grade	-08.20	Angle of Distortion Value
0.43	Grid Non-Uniformity Value	P	Symbol Contrast Grade
3 / B	Modulation Grade	034	Symbol Contrast Value
2 / C	Unused ECC Grade	P	Quiet Zone Grade
057	Unused ECC Value	12.4	Pixels Per Element Value
-0.82	Print Growth Value	ECC200	Symbol Type
08.7	Pixels Per Element Value	018x018	Symbol Dimensions
ECC200	Symbol Type		
032x032	Symbol Dimensions		

General Verification Output by ESP

General verification output parameters allow the user choose specific output settings for **Separator Character**, **ISO Grade Type**, **Symbol Type**, and **Symbol Dimension/Size** as they appear in ISO/IEC 15415 and AS9132 verification output.

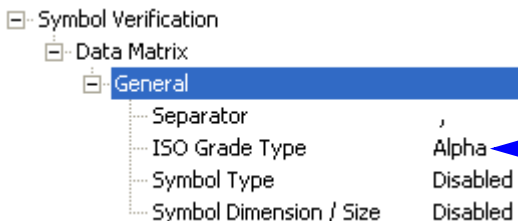

Note: The **Alpha** or **Numeric** parameter only affects ISO/IEC 15415 output.

Separator Character

The separator you choose will appear between each field of data output.

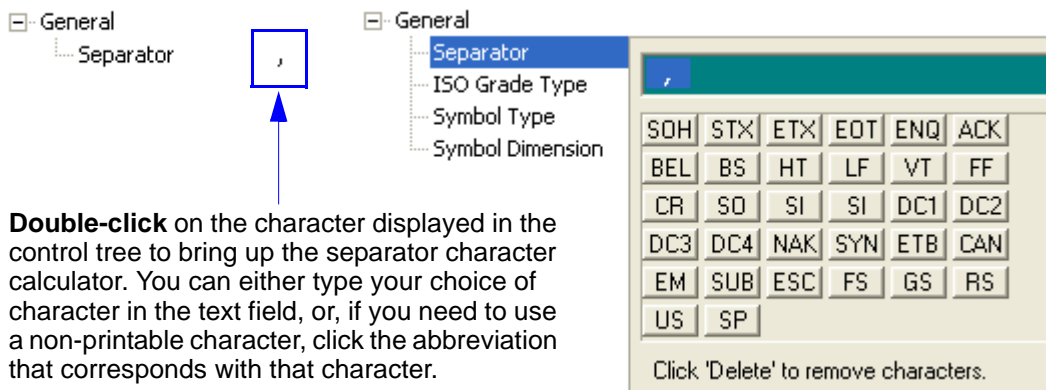

Double-click on the character displayed in the control tree to bring up the separator character calculator. You can either type your choice of character in the text field, or, if you need to use a non-printable character, click the abbreviation that corresponds with that character.

ISO Grade Type

This parameter only affects ISO/IEC 15415 verification output.

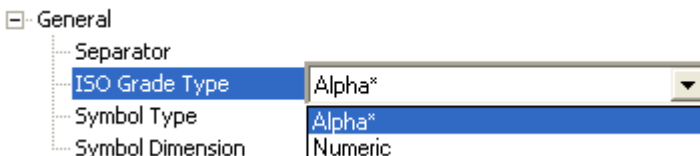

If you choose **Alpha**, ISO grades will be in alphabetical format (**A, B, C, D, F**).

If you choose **Numeric**, ISO grades will be in numeric format.

Symbol Type

When enabled, **Symbol Type** identifies the symbology of the mark being evaluated in the verification report output.



Symbol Dimension / Size

When enabled, **Symbol Dimensions** states the dimensions (row value x column value) of the mark being evaluated in the verification report output.

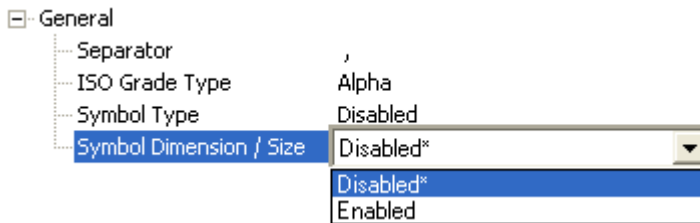

ISO/IEC 15415 Verification Setup

This command allows the user to fine-tune lighting and camera settings to comply with ISO/IEC 15415's optical requirements for 2D verification.

Aperture

Definition: The physical size of the synthetic aperture that will be applied to the captured symbol image by the Verifier's software.

This parameter is in units of 1/10000 of one inch, or 10x the mil size.

Serial Cmd: <**K531**,*aperture*,*wavelength*,*angle*,*reflectance maximum*,*reflectance minimum*>

Default: **50**

Options: 10 to 160

Wavelength

Definition: Expresses the wavelength of LED illumination that will be directed at the candidate symbol during verification.

Wavelength values are in nanometers (nm).

Serial Cmd: <**K531**,*aperture*,**wavelength**,*angle*,*reflectance maximum*,*reflectance minimum*>

Default: **660**

Options: 400 to 700

Angle

Definition: The degree angle at which the candidate symbol will be illuminated in the lighting chamber during verification.

Serial Cmd: <**K531**,*aperture*,*wavelength*,**angle**,*reflectance maximum*,*reflectance minimum*>

Default: **45**

Options: 30 to 90

Reflectance Maximum

Definition: This setting represents the maximum reflectance value (percent) of the symbol used to calibrate the Verifier. The calibration symbol is described in **Step 6** of the **Quick Start** procedure.

Serial Cmd: <K531,aperture,wavelength,angle,**reflectance maximum**,reflectance minimum>

Default: **85**

Options: 0 to 100

Reflectance Minimum

Definition: This setting represents the minimum reflectance value (percent) of the symbol used to calibrate the Verifier. The calibration symbol is described in **Step 6** of the **Quick Start** procedure.

Serial Cmd: <K531,aperture,wavelength,angle,reflectance maximum,**reflectance minimum**>

Default: **10**

Options: 0 to 100

ISO/IEC 15415 Verification Setup by ESP

ISO/IEC 15415 Verification Setup allows the user to fine-tune lighting and camera settings to comply with ISO/IEC 15415's optical requirements for 2D verification.

Aperture

Aperture expresses the radius of the synthetic aperture that will be applied to the captured symbol image by the Verifier's software.

Radius values are in units of 1/10th of one pixel.

ISO/IEC 15415 Setup

Aperture	5.0	(1.0 - 16.0) mils
Wavelength	660	
Angle	45	
Reflectance Max	85	
Reflectance Min	10	

Wavelength

Wavelength is the LED illumination wavelength that will be directed at the candidate symbol during verification.

Wavelength values are in nanometers (nm).

ISO/IEC 15415 Setup

Aperture	25	
Wavelength	660	(400 - 700) nm
Angle	45	
Reflectance Max	85	
Reflectance Min	10	

Angle

Angle is the degree angle at which the candidate symbol will be illuminated in the lighting chamber during verification.

ISO/IEC 15415 Setup

Aperture	25	
Wavelength	660	
Angle	45	(30 - 90) degrees
Reflectance Max	85	
Reflectance Min	10	

Reflectance Max

Reflectance Max represents the maximum reflectance value (percent) of the symbol used to calibrate the Verifier.

ISO/IEC 15415 Setup

Aperture	25
Wavelength	660
Angle	45
Reflectance Max	85 (0 - 100)
Reflectance Min	10

Reflectance Min

This setting represents the minimum reflectance value (percent) of the symbol used to calibrate the Verifier.

ISO/IEC 15415 Setup

Aperture	25
Wavelength	660
Angle	45
Reflectance Max	85
Reflectance Min	10 (0 - 100)

ISO/IEC 15415 Serial Output

This command allows the user to determine which ISO/IEC 15415 grades and/or values will be represented in the verification output string.

Grade

Definition: **Note:** The grade type (**Alpha** or **Numeric**) is determined by the “ISO Grade Type” field in the **General Verification Serial Output** command **<K708>**.

Serial Cmd: **<K756,grade,aperture value,wavelength value,light angle value,decode grade,symbol contrast,fixed pattern damage grade,axial non-uniformity,grid non-uniformity,modulation grade,unused error correction,print growth value,pixels per element value>**

Default: **Disabled**

Options: **0 = Disabled**
1 = Grade

Output Example: Overall **Grade** highlighted below (shown in numeric form).

```
symbol_data, 2, 005, 660, 45, 4, 4, 075, 3, 1, 0.11, 3, 0.43, 3, 2, 057, -0.82,
08.7, ECC200, 032x032
```

Aperture Value

Definition: Expresses the **Synthetic Aperture Value** in the verification output string.

Serial Cmd: **<K756,grade,aperture value,wavelength value,light angle value,decode grade,symbol contrast,fixed pattern damage grade,axial non-uniformity,grid non-uniformity,modulation grade,unused error correction,print growth value,pixels per element value>**

Default: **Disabled**

Options: **0 = Disabled**
1 = Value

Output Example: **Synthetic Aperture Value** highlighted below.

```
symbol_data, 2, 005, 660, 45, 4, 4, 075, 3, 1, 0.11, 3, 0.43, 3, 2, 057, -0.82,
08.7, ECC200, 032x032
```

Wavelength Value

Definition: When enabled, appends the LED illumination **Wavelength Value** to the verification output string.

Wavelength Value expresses the peak wavelength of LED light output, measured in nanometers (nm).

Serial Cmd: <K756,grade,aperture value,wavelength value,light angle value,decode grade,symbol contrast,fixed pattern damage grade,axial non-uniformity,grid non-uniformity,modulation grade,unused error correction,print growth value,pixels per element value>

Default: Disabled

Options: 0 = Disabled

1 = Value

Output Example: **Wavelength Value** highlighted below.

```
symbol_data,2,005,660,45,4,4,075,3,1,0.11,3,0.43,3,2,057,-0.82,08.7,ECC200,032x032
```

Light Angle Value

Definition: Defines the angle of incidence of LED illumination.

When enabled, appends the LED **Light Angle Value** (in degrees) to the verification output string.

Serial Cmd: <K756,grade,aperture value,wavelength value,light angle value,decode grade,symbol contrast,fixed pattern damage grade,axial non-uniformity,grid non-uniformity,modulation grade,unused error correction,print growth value,pixels per element value>

Default: Disabled

Options: 0 = Disabled

1 = Value

Output Example: **Light Angle Value** highlighted below.

```
symbol_data,2,005,660,45,4,4,075,3,1,0.11,3,0.43,3,2,057,-0.82,08.7,ECC200,032x032
```

Decode Grade

Definition: To receive a passing **Decode Grade**, a symbol must be successfully decoded using the Verifier's reference decode algorithm.

When enabled, appends the symbol's **Decode Grade** to the verification output string.

A symbol will receive a **0 (F)** if it cannot be decoded using the specified reference decode algorithm. It will receive a **4 (A)** if it can be decoded using the specified reference decode algorithm.

Serial Cmd: <K756,grade,aperture value,wavelength value,light angle value,decode grade,symbol contrast,fixed pattern damage grade,axial non-uniformity,grid non-uniformity,modulation grade,unused error correction,print growth value,pixels per element value>

Default: **Disabled**

Options: **0 = Disabled**
1 = Grade

Output Example: **Decode Grade** highlighted below (shown in numeric form).

```
symbol_data, 2, 005, 660, 45, 4, 4, 075, 3, 1, 0.11, 3, 0.43, 3, 2, 057, -0.82, 08.7, ECC200, 032x032
```

Symbol Contrast

Definition: Measures the difference between light and dark symbol elements. This measurement also includes the symbol's **Quiet Zone**.

When enabled, appends the **Symbol Contrast** grade and/or value to the verification output string.

Grading Scale:

4 (A) if $\geq 70\%$

3 (B) if $\geq 55\%$

2 (C) if $\geq 40\%$

1 (D) if $\geq 20\%$

0 (F) if $< 20\%$

Serial Cmd: <K756,grade,aperture value,wavelength value,light angle value,decode grade,symbol contrast,fixed pattern damage grade,axial non-uniformity,grid non-uniformity,modulation grade,unused error correction,print growth value,pixels per element value>

Default: **Disabled**

Options: **0 = Disabled**
1 = Grade
2 = Value
3 = Grade and Value

Grade (Symbol Contrast)

Output **Symbol Contrast Grade** highlighted below (shown in numeric form).
Example:

```
symbol_data,2,005,660,45,4,4,3,1,0.11,3,0.43,3,2,057,-0.82,  
08.7,ECC200,032x032
```

Value (Symbol Contrast)

Output **Symbol Contrast Value** is a percentage, and is shown in the output string
Example: as a three-digit value from **000** to **100**. For example, "075" = 75%.

```
symbol_data,2,005,660,45,4,075,3,1,0.11,3,0.43,3,2,057,-0.82,  
08.7,ECC200,032x032
```

Grade and Value (Symbol Contrast)

Output **Symbol Contrast Grade** and **Value** highlighted below (grade shown in
Example: numeric form).

```
symbol_data,2,005,660,45,4,4,075,3,1,0.11,3,0.43,3,2,057,-0.82,  
08.7,ECC200,032x032
```

Fixed Pattern Damage Grade

Definition: Assesses damage to the symbol's finder pattern and clock pattern. When enabled, appends the symbol's **Fixed Pattern Damage Grade** to the verification output string.

Serial Cmd: <**K756**,grade,aperture value,wavelength value,light angle value,decode grade,symbol contrast,**fixed pattern damage grade**,axial non-uniformity,grid non-uniformity,modulation grade,unused error correction,print growth value,pixels per element value>

Default: **Disabled**

Options: **0 = Disabled**
1 = Grade

Output Example: **Fixed Pattern Damage Grade** highlighted below (shown in numeric form).

```
symbol_data,2,005,660,45,4,4,075,3,1,0.11,3,0.43,3,2,057,-0.82,
08.7,ECC200,032x032
```

Axial Non-Uniformity

Definition: Measures deviation along the symbol's major axes. When enabled, appends the symbol's **Axial Non-Uniformity** grade and/or value to the verification output string.

Grading Scale:

4 (A) if ≤ 0.06

3 (B) if ≤ 0.08

2 (C) if ≤ 0.10

1 (D) if ≤ 0.12

0 (F) if > 0.12

Serial Cmd: <**K756**,grade,aperture value,wavelength value,light angle value,decode grade,symbol contrast,**fixed pattern damage grade**,**axial non-uniformity**,grid non-uniformity,modulation grade,unused error correction,print growth value,pixels per element value>

Default: **Disabled**

Options: **0 = Disabled**
1 = Grade
2 = Value
3 = Grade and Value

Grade (Axial Non-Uniformity)

Output
Example: **Axial Non-Uniformity Grade** highlighted below (shown in numeric form).

```
symbol_data,2,005,660,45,4,4,075,3,1,3,0.43,3,2,057,-0.82,  
08.7,ECC200,032x032
```

Value (Axial Non-Uniformity)

Output
Example: **Axial Non-Uniformity Value** highlighted below.

```
symbol_data,2,005,660,45,4,4,075,1,0.11,3,0.43,3,2,057,-0.82,  
08.7,ECC200,032x032
```

Grade and Value (Axial Non-Uniformity)

Output
Example: **Axial Non-Uniformity Grade** and **Value** highlighted below (grade shown in numeric form).

```
symbol_data,2,005,660,45,4,4,075,3,1,0.11,3,0.43,3,2,057,-0.82,  
08.7,ECC200,032x032
```

Grid Non-Uniformity

Definition: Measures cell deviation from the theoretical or “ideal” grid intersections as determined by the reference decode algorithm.

When enabled, appends the symbol’s **Grid Non-Uniformity** grade and/or value to the verification output string.

Grading Scale:

4 (A) if ≤ 0.38

3 (B) if ≤ 0.50

2 (C) if ≤ 0.63

1 (D) if ≤ 0.75

0 (F) if > 0.75

Serial Cmd: <**K756**,grade,aperture value,wavelength value,light angle value,decode grade,symbol contrast,fixed pattern damage grade,axial non-uniformity,**grid non-uniformity**,modulation grade,unused error correction,print growth value,pixels per element value>

Default: **Disabled**

Options: **0 = Disabled**

1 = Grade

2 = Value

3 = Grade and Value

Grade (Grid Non-Uniformity)

Output Example: **Grid Non-Uniformity Grade** highlighted below (shown in numeric form).

```
symbol_data,2,005,660,45,4,4,075,3,1,0.11,3,3,2,057,-0.82,08.7,ECC200,032x032
```

Value (Grid Non-Uniformity)

Output Example: **Grid Non-Uniformity Value** highlighted below.

```
symbol_data,2,005,660,45,4,4,075,3,1,0.11,0.43,3,2,057,-0.82,08.7,ECC200,032x032
```

Grade and Value (Grid Non-Uniformity)

Output Example: **Grid Non-Uniformity Grade** and **Value** highlighted below (grade shown in numeric form).

```
symbol_data,2,005,660,45,4,4,075,3,1,0.11,3,0.43,3,2,057,-0.82,08.7,ECC200,032x032
```

Modulation Grade

Definition: Assesses the reflectance uniformity of the symbol's light and dark elements. When enabled, appends the symbol's **Modulation Grade** to the verification output string.

Grading Scale:

4 (A) if ≥ 0.50

3 (B) if ≥ 0.40

2 (C) if ≥ 0.30

1 (D) if ≥ 0.20

0 (F) if < 0.20

Serial Cmd: <K756,grade,aperture value,wavelength value,light angle value,decode grade,symbol contrast,fixed pattern damage grade,axial non-uniformity,grid non-uniformity,**modulation grade**,unused error correction,print growth value,pixels per element value>

Default: **Disabled**

Options: **0 = Disabled**

1 = Grade

Output Example: **Modulation Grade** highlighted below (shown in numeric form).

symbol_data,2,005,660,45,4,4,075,3,1,0.11,3,0.43,**3**,2,057,-0.82,08.7,ECC200,032x032

Unused Error Correction

Definition: Determines the amount of error correction capacity that was used to decode the symbol, and indicates the remaining amount of available error correction.

When enabled, appends the symbol's **Unused Error Correction** grade and/or value to the verification output string.

Grading Scale:

4 (A) if ≥ 0.62

3 (B) if ≥ 0.50

2 (C) if ≥ 0.37

1 (D) if ≥ 0.25

0 (F) if < 0.25

Serial Cmd: <**K756**,*grade,aperture value,wavelength value,light angle value,decode grade,symbol contrast,fixed pattern damage grade,axial non-uniformity,grid non-uniformity,modulation grade,unused error correction,print growth value,pixels per element value*>

Default: **Disabled**

Options: **0 = Disabled**

1 = Grade

2 = Value

3 = Grade and Value

Grade

Output Example: **Unused Error Correction Grade** highlighted below (shown in numeric form).

```
symbol_data,2,005,660,45,4,4,075,3,1,0.11,3,0.43,3,2,-0.82,
08.7,ECC200,032x032
```

Value

Output Example: **Unused Error Correction Value** highlighted below.

```
symbol_data,2,005,660,45,4,4,075,3,1,0.11,3,0.43,3,057,-0.82,
08.7,ECC200,032x032
```

Grade and Value

Output Example: **Unused Error Correction Grade** and **Value** highlighted below (grade shown in numeric form).

```
symbol_data,2,005,660,45,4,4,075,3,1,0.11,3,0.43,3,2,057,-0.82,
08.7,ECC200,032x032
```

Print Growth Value

Definition: Determines the degree to which a symbol is overprinted or underprinted. When enabled, appends the symbol's **Print Growth Value** to the verification output string.

Serial Cmd: <K756,grade,aperture value,wavelength value,light angle value,decode grade,symbol contrast,fixed pattern damage grade,axial non-uniformity,grid non-uniformity,modulation grade,unused error correction,**print growth value**,pixels per element value>

Default: Disabled

Options: 0 = Disabled
1 = Value

Output Example: **Print Growth Value** highlighted below.

```
symbol_data , 2 , 005 , 660 , 45 , 4 , 4 , 075 , 3 , 1 , 0 . 11 , 3 , 0 . 43 , 3 , 2 , 057 , -0 . 82 ,  
08 . 7 , ECC200 , 032x032
```

Pixels Per Element Value

Definition: Counts the number of pixels in each symbol element. The higher the **Pixels Per Element** count, the more readable the symbol. When enabled, appends the symbol's **Pixels Per Element Value** to the verification output string.

Serial Cmd: <K756,grade,aperture value,wavelength value,light angle value,decode grade,symbol contrast,fixed pattern damage grade,axial non-uniformity,grid non-uniformity,modulation grade,unused error correction,print growth value,**pixels per element value**>

Default: Disabled

Options: 0 = Disabled
1 = Value

Output Example: **Pixels Per Element Value** highlighted below.

```
symbol_data , 2 , 005 , 660 , 45 , 4 , 4 , 075 , 3 , 1 , 0 . 11 , 3 , 0 . 43 , 3 , 2 , 057 , -0 . 82 ,  
08 . 7 , ECC200 , 032x032
```

ISO/IEC 15415 Output by ESP

Grade Output

Note: Grade type (**Alpha** or **Numeric**) is determined by the “ISO Grade Type” parameter.

ISO 15415 Parameters	
Grade Output	Disabled*
Aperture	Disabled*
Wavelength	Grade
Light Angle	Disabled
Decode	Disabled
Symbol Contrast	Disabled
Fixed Pattern Damage	Disabled
Axial Non-uniformity	Disabled
Grid Non-uniformity	Disabled
Modulation	Disabled
Unused ECC	Disabled
Print Growth	Disabled
Pixels Per Element	Disabled

Aperture

Expresses the **Synthetic Aperture Value** in the verification report.

ISO 15415 Parameters	
Grade Output	Disabled
Aperture	Disabled*
Wavelength	Disabled*
Light Angle	Value
Decode	Disabled
Symbol Contrast	Disabled
Fixed Pattern Damage	Disabled
Axial Non-uniformity	Disabled
Grid Non-uniformity	Disabled
Modulation	Disabled
Unused ECC	Disabled
Print Growth	Disabled
Pixels Per Element	Disabled

Wavelength

Wavelength Value expresses the peak wavelength of LED light output, measured in nanometers (nm).

ISO 15415 Parameters	
Grade Output	Disabled
Aperture	Disabled
Wavelength	Disabled*
Light Angle	Disabled*
Decode	Value
Symbol Contrast	Disabled
Fixed Pattern Damage	Disabled
Axial Non-uniformity	Disabled
Grid Non-uniformity	Disabled
Modulation	Disabled
Unused ECC	Disabled
Print Growth	Disabled
Pixels Per Element	Disabled

Light Angle

Defines the angle of incidence of LED illumination.

ISO 15415 Parameters	
Grade Output	Disabled
Aperture	Disabled
Wavelength	Disabled
Light Angle	Disabled*
Decode	Disabled*
Symbol Contrast	Value
Fixed Pattern Damage	Disabled
Axial Non-uniformity	Disabled
Grid Non-uniformity	Disabled
Modulation	Disabled
Unused ECC	Disabled
Print Growth	Disabled
Pixels Per Element	Disabled

Decode

To receive a passing **Decode Grade**, a symbol must be successfully decoded using the Verifier's reference decode algorithm.

When enabled, includes the symbol's **Decode Grade** in the verification report.

A symbol will receive a **0 (F)** if it cannot be decoded using the specified reference decode algorithm. It will receive a **4 (A)** if it can be decoded using the specified reference decode algorithm.

ISO 15415 Parameters	
Grade Output	Disabled
Aperture	Disabled
Wavelength	Disabled
Light Angle	Disabled
Decode	Disabled*
Symbol Contrast	Disabled*
Fixed Pattern Damage	Grade
Axial Non-uniformity	Disabled
Grid Non-uniformity	Disabled
Modulation	Disabled
Unused ECC	Disabled
Print Growth	Disabled
Pixels Per Element	Disabled

Symbol Contrast

Measures the difference between light and dark symbol elements. This measurement also includes the symbol's **Quiet Zone**.

When enabled, includes the **Symbol Contrast** grade and/or value in the verification report.

ISO/IEC 15415 Parameters	
Grade Output	Disabled
Aperture	Disabled
Wavelength	Disabled
Light Angle	Disabled
Decode	Disabled
Symbol Contrast	Disabled*
Fixed Pattern Damage	Disabled*
Axial Non-uniformity	Grade
Grid Non-uniformity	Value
Modulation	Both
Unused ECC	Disabled
Print Growth	Disabled
Pixels Per Element	Disabled

Fixed Pattern Damage

Assesses damage to the symbol's finder pattern and clock pattern.

When enabled, includes the symbol's **Fixed Pattern Damage Grade** in the verification report.

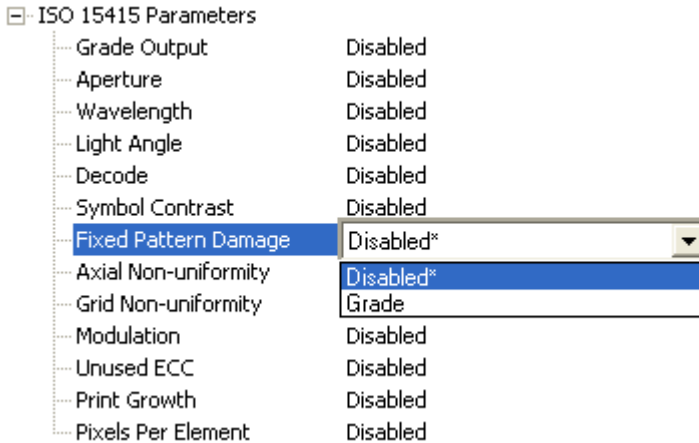

Axial Non-Uniformity

Measures deviation along the symbol's major axes.

When enabled, includes the symbol's **Axial Non-Uniformity** grade and/or value in the verification report.

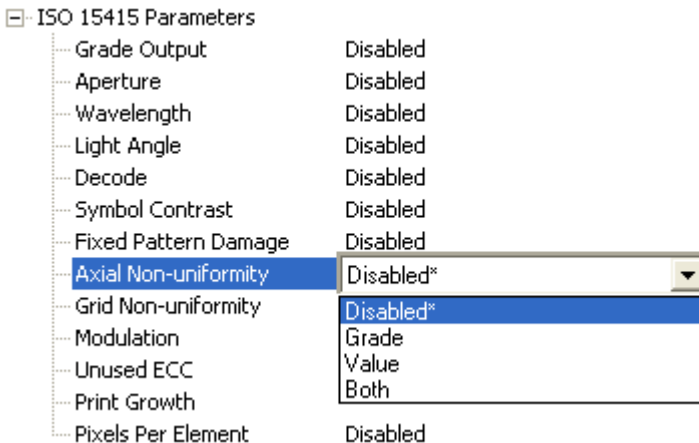

Grid Non-Uniformity

Measures cell deviation from the theoretical or “ideal” grid intersections as determined by the reference decode algorithm.

When enabled, includes the symbol’s **Grid Non-Uniformity** grade and/or value in the verification report.

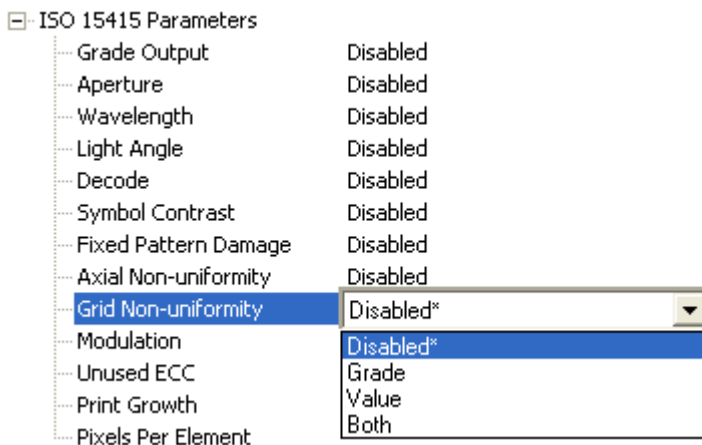

Modulation

Assesses the reflectance uniformity of the symbol’s light and dark elements.

When enabled, includes the symbol’s **Modulation Grade** in the verification report.

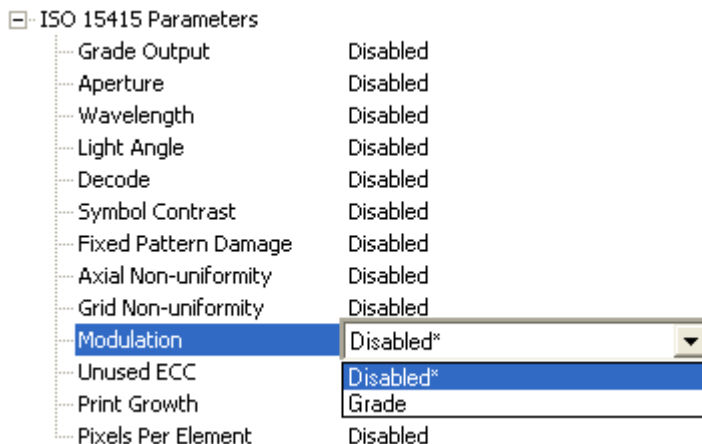

Unused ECC

Determines the amount of error correction capacity that was used to decode the symbol, and indicates the remaining amount of available error correction.

When enabled, includes the symbol's **Unused Error Correction** grade and/or value in the verification report.

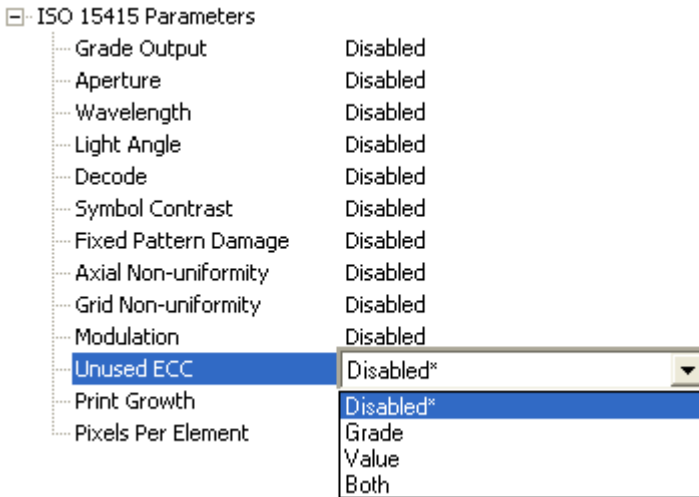

Print Growth

Determines the degree to which a symbol is overprinted or underprinted.

When enabled, includes the symbol's **Print Growth Value** in the verification report.

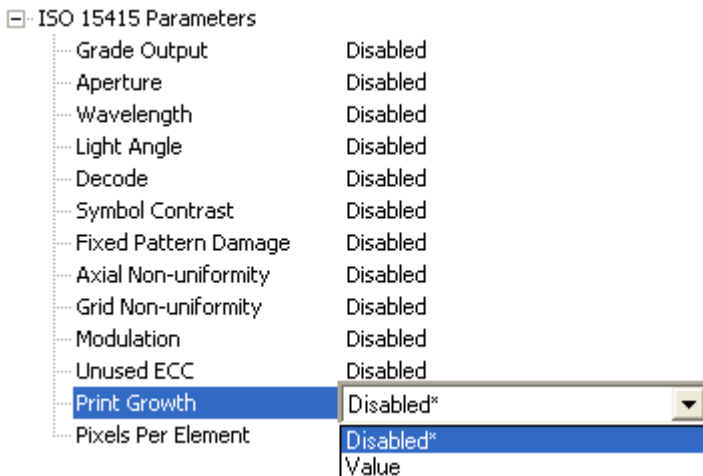

Pixels Per Element

Counts the number of pixels in each symbol element. The higher the **Pixels Per Element** count, the more readable the symbol.

When enabled, includes the symbol's **Pixels Per Element Value** in the verification report.

[-] ISO/IEC 15415 Parameters	
Grade Output	Disabled
Aperture	Disabled
Wavelength	Disabled
Light Angle	Disabled
Decode	Disabled
Symbol Contrast	Disabled
Fixed Pattern Damage	Disabled
Axial Non-uniformity	Disabled
Grid Non-uniformity	Disabled
Modulation	Disabled
Unused ECC	Disabled
Print Growth	Disabled
Pixels Per Element	Disabled*
	Value

AIM DPM Verification Setup

This command allows the user to fine-tune lighting and camera settings to comply with AIM DPM's optical requirements for 2D verification.

Minimum Element Size

Definition: The minimum expected element size of the candidate symbol in 1/1000 of an inch, or the symbol's mil size. The minimum and maximum element size values define the range for calibration.

Note: A larger minimum-to-maximum range of element size may slow down the calibration phase of the symbol grading process.

Once the candidate symbol is identified, the AIM DPM procedure will use and report the actual aperture size used for verification.

Serial Cmd: <**K532**,*minimum element size*,*maximum element size*,*wavelength*,*lighting*>

Default: **10**

Options: 7 to 50

Maximum Element Size

Definition: The maximum expected element size of the candidate symbol in 1/1000 of an inch, or the symbol's mil size. The minimum and maximum element size values define the range for calibration.

Note: A larger minimum-to-maximum range of element size may slow down the calibration phase of the symbol grading process.

Once the candidate symbol is identified, the AIM DPM procedure will use and report the actual aperture size used for verification.

Serial Cmd: <**K532**,*minimum element size*,**maximum element size**,*wavelength*,*lighting*>

Default: **15**

Options: 7 to 50

Wavelength

Definition: The wavelength of illumination in the lighting environment used for verification.

Important: The operator must ensure that this setting matches that of the illumination source being used.

Serial Cmd: <**K532**,*minimum element size*,*maximum element size*,**wavelength**,*lighting*>

Default: **660**

Options: 400 to 700

Lighting

Definition: A string of ASCII characters that represents the angle and configuration of illumination used in the verification environment.

Important: For reliable Direct Part Mark verification results, Microscan recommends setting the **Lighting** parameter to **90**. This is because diffuse perpendicular (or “on axis/bright field”) illumination—in which the symbol plane is parallel to the plane of the Verifier’s sensor and the symbol is uniformly illuminated at a 90° angle of incidence—is most effective for reading Direct Part Marks.

Note: Details about other lighting configurations and their corresponding ASCII representations can be found in AIM Global’s “Direct Part Mark (DPM) Quality Guideline”, available at www.aimglobal.org.

Serial Cmd: <**K532**,*minimum element size*,*maximum element size*,*wavelength*,**lighting**>

Default: **45Q**

Options: Any ASCII string up to 15 characters

AIM DPM Verification Setup by ESP

AIM DPM Verification Setup allows the user to fine-tune lighting and camera settings to comply with AIM DPM's optical requirements for 2D verification.

Minimum Element Size

Minimum Element Size is the minimum expected element size of the candidate symbol in 1/1000 of an inch, or the symbol's mil size. The minimum and maximum element size values define the range for calibration.

Note: A larger minimum-to-maximum range of element size may slow down the calibration phase of the symbol grading process.

Once the candidate symbol is identified, the AIM DPM procedure will use and report the actual aperture size used for verification.

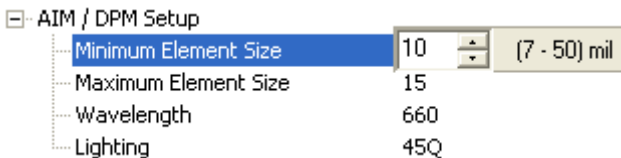

Maximum Element Size

Maximum Element Size is the maximum expected element size of the candidate symbol in 1/1000 of an inch, or the symbol's mil size. The minimum and maximum element size values define the range for calibration.

Note: A larger minimum-to-maximum range of element size may slow down the calibration phase of the symbol grading process.

Once the candidate symbol is identified, the AIM DPM procedure will use and report the actual aperture size used for verification.

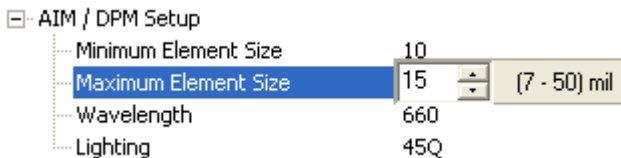

Wavelength

Wavelength represents the wavelength of illumination in the lighting environment used for verification.

Important: The operator must ensure that this setting matches that of the illumination source being used.

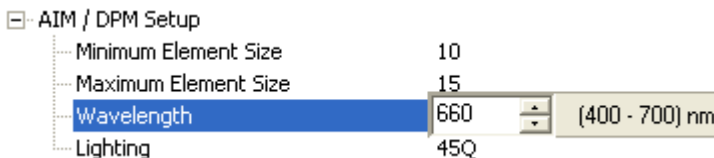

Lighting

Lighting is represented by a combination of ASCII characters (up to 15) signifying the angle and configuration of illumination used in the verification environment.

Important: For reliable Direct Part Mark verification results, Microscan recommends setting the **Lighting** parameter to **90**. This is because diffuse perpendicular (or “on axis/bright field”) illumination—in which the symbol plane is parallel to the plane of the Verifier’s sensor and the symbol is uniformly illuminated at a 90° angle of incidence—is most effective for reading Direct Part Marks.

Note: Details about other lighting configurations and their corresponding ASCII representations can be found in AIM Global’s “Direct Part Mark (DPM) Quality Guideline”, available at www.aimglobal.org.

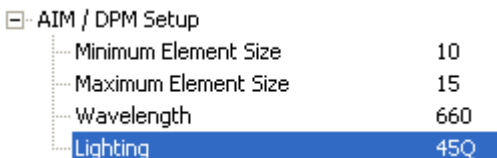

ISO/IEC 15415 Verification by Serial Command

Reflectance Calibration

Definition: The **Reflectance Calibration** command initiates a calibration process with the minimum and maximum reflectance values that are already configured in the Verifier (default minimum: **<K531,,,10>** default maximum: **<K531,,,85>**).

Note: If the minimum and maximum reflectance values configured in the Verifier correspond with a different calibration symbol, the results after calibration may be incorrect.

Serial Cmd: **<@VER>**

- Place the calibration symbol provided in the approximate center of the Verifier's field of view before entering the **Reflectance Calibration** command.

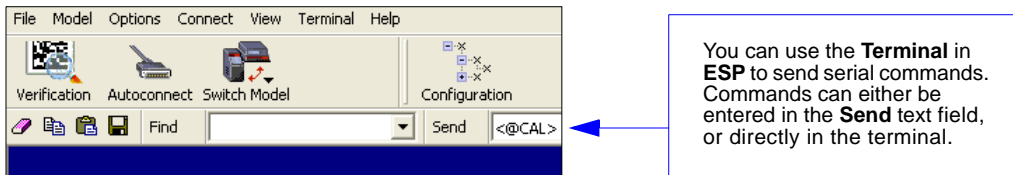
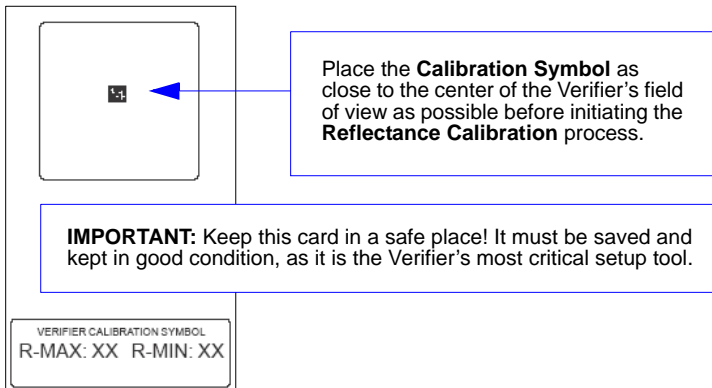

Important: After the Verifier is calibrated, you must allow 15 minutes of warmup time in **Live Video Mode**, **<K760,2>**, before starting a verification process. The LEDs must reach a steady output state for verification results to be valid.

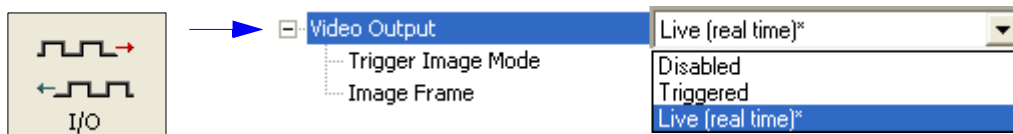

ISO/IEC 15415 Single Capture Verification

Serial Cmd: <V1>

Single Capture Verification Process

- Once the reflectance calibration process is complete, place the candidate symbol as close to the center of the Verifier's field of view as possible.
- When the candidate symbol is in position, initiate the **Single Capture Verification** command <V1>.
- The **Single Capture Verification Report** will then appear, detailing the symbol's adherence to ISO/IEC 15415 requirements.

Single Capture Verification Report

The **ISO/IEC 15415 Single Capture** results show data concerning the reference decode algorithm, symbol contrast, fixed pattern damage, axial and grid non-uniformity, modulation, unused error correction, print growth, symbol type, symbol size, element size, and pixels per element. All but the last five parameters are given a numeric and alphabetical grade.

```

---/05/660
-----
                        ISO/IEC 15415 Verification Report
-----
PARAMETER                RESULTS                                GRADE
-----
REFERENCE DECODE:        PASS                                4 (A)
SYMBOL CONTRAST:         82%                                4 (A)
FIXED PATTERN DAMAGE:    ----                                4 (A)
AXIAL NON-UNIFORMITY:    0.01                               4 (A)
GRID NON-UNIFORMITY:     0.01                               4 (A)
MODULATION:              ----                                4 (A)
UNUSED ECC:              100%                               4 (A)
-----
FINAL GRADE:                                4 (A)
NON-GRADED PARAMETERS:
PRINT GROWTH:            0.02
SYMBOL TYPE:             ECC200
SYMBOL SIZE:             10x10
ELEMENT SIZE:            0.019"
PIXELS/ELEMENT:         18.5
SYMBOL DATA:           Y

```

ISO/IEC 15415 Multi-Capture Verification

Serial Cmd: <V2>

Multi-Capture Verification Process

- Once the reflectance calibration process is complete, place the candidate symbol as close to the center of the Verifier's field of view as possible.
Important: Multi-Capture Verification requires five captures at 72° intervals throughout a 360° rotation. When the symbol is placed in the Verifier's field of view, its position should be considered its default position -- 0°. ISO/IEC 15415 requires that the symbol's orientation for the first capture be 45°. This means 45° from the default symbol position, 0°.
- When the candidate symbol is in position, initiate the **Multi-Capture Verification** command <V2>.
- The first rotation prompt, shown below, will appear.

Step 1: 45° Rotation

```
Starting Multiple Image Verification...  
Step 1: Place symbol with 45 degree rotation then initiate trigger.
```



Default
Position: 0°



45°

Step 2: 117° Rotation

```
Step 2: Rotate 72 degrees then initiate trigger.
```



Default
Position: 0°



117°

Step 3: 189° Rotation

Step 3: Rotate 72 degrees then initiate trigger.



Default
Position: 0°



189°

Step 4: 261° Rotation

Step 4: Rotate 72 degrees then initiate trigger.



Default
Position: 0°



261°

Step 5: 333° Rotation

Step 5: Rotate 72 degrees then initiate trigger.



Default
Position: 0°



333°

Multi-Capture Verification Report

After the final rotation and trigger, the Verifier will output the **ISO/IEC 15415 Multi-Capture Verification Report**, shown below.

The **ISO/IEC 15415 Multi-Capture** parameters are the same as those for **ISO/IEC 15415 Single Capture**, but multi-capture results are determined only after the symbol is read at five 72° intervals throughout a full 360° rotation. The overall symbol grade is based on an arithmetic mean of the results from the five reads.

```
Starting Multiple Image Verification...
Step 1: Place symbol with 45 degree rotation then initiate trigger.
Step 2: Rotate 72 degrees then initiate trigger.
Step 3: Rotate 72 degrees then initiate trigger.
Step 4: Rotate 72 degrees then initiate trigger.
Step 5: Rotate 72 degrees then initiate trigger.
4.0/05/660
```

ISO/IEC 15415 VERIFICATION REPORT						
PARAMETER	SINGLE RESULTS					MEAN VALUES
REFERENCE DECODE:	4 (A)	4 (A)	4 (A)	4 (A)	4 (A)	PASS
SYMBOL CONTRAST:	4 (A)	4 (A)	4 (A)	4 (A)	4 (A)	82%
FIXED PATTERN DAMAGE:	4 (A)	4 (A)	4 (A)	4 (A)	4 (A)	----
AXIAL NON-UNIFORMITY:	4 (A)	4 (A)	4 (A)	4 (A)	4 (A)	0.00
GRID NON-UNIFORMITY:	4 (A)	4 (A)	4 (A)	4 (A)	4 (A)	0.00
MODULATION:	4 (A)	4 (A)	4 (A)	4 (A)	4 (A)	----
UNUSED ECC:	4 (A)	4 (A)	4 (A)	4 (A)	4 (A)	100%
FINAL GRADES:	4 (A)	4 (A)	4 (A)	4 (A)	4 (A)	
OVERALL GRADE:						4.0 (A)
NON-GRADED PARAMETERS:						
PRINT GROWTH:	0.01					
SYMBOL TYPE:	ECC200					
SYMBOL SIZE:	10x10					
ELEMENT SIZE:	0.019"					
PIXELS/ELEMENT:	18.6					
SYMBOL DATA:	Y					

AS9132 /JES 131 Marking Method

Element Shape

Definition: The shape of the symbol's printed, **dot peen**, or Etch markings.
Each symbol element represents one bit ('0' or '1') of binary data. Symbol elements can be either round or square, provided that they are consistent in size and spacing throughout the symbol.
Choice of **Element Shape** setting should be based on the actual element shape used in the symbol being verified.

Serial Cmd: <K711, **element shape**, marking method, JES 131>

Default: **Round**

Options: **0 = Round**
1 = Square

Marking Method

Definition: The marking method used to create the symbol.
Choice of **Marking Method** setting should be based on the method used to create the symbol being verified.

Serial Cmd: <K711, element shape, **marking method**, JES 131>

Default: **Dot Peen**

Options: **0 = Dot Peen**
1 = Laser or Chemical Etch

Dot Peen

Dot peen is a percussive marking method that uses changes in depth to create the contrast between light and dark elements. Dot peen marks are imprinted directly on parts. This method is recommended for applications in which marks must last the entire life cycle of the part.

Laser or Chemical Etch

Laser etch marks are applied directly to parts using a YAG, CO₂, or YVO₄ laser. Laser etch marks are ideal for high-volume automated environments, and they can be used on a wide variety of substrates.

Chemical etch marks are created using an electro-chemical process by which a low voltage electrical current passes through a stencil and onto a part's surface. This process only works with conductive metal substrates. Chemical etch marks are best suited to low-volume product runs because of the complexity and time-intensive nature of the marking process.

JES 131

Definition: When enabled, sets verification parameters to the **JES 131** specification rather than the AS9132 specification.

JES 131 specifies a Cell Fill upper threshold of 110% instead of AS9132's 105%.

JES 131 verification reports will display the heading "JES 131 Verification Report", as shown in the example below.

JES 131 Verification Report				
MARKING METHOD: LASER/ELECTO-CHEM ETCH				
ELEMENT SHAPE: SQUARE				
PARAMETER	REQUIREMENT PER ELEMENT	RESULTS	FAIL IF 2% OF ELEMENTS FAIL	PASS/FAIL
QUIET ZONE:	=> One element			PASS
CONTRAST:	> 20%	82 %		PASS
CELL FILL/SIZE:	60% < size < 110%	102 %		PASS
ANGLE OF DISTORTION:	< +/- 7 Degrees	-0.8 degree		PASS
SYMBOL TYPE:	ECC200	ECC200		PASS
MATRIX SIZE:	10x10			
ELEMENT SIZE:	0.016"			
PIXELS/ELEMENT:	16.2			
SYMBOL DATA:	Y			

Serial Cmd: <K711, element shape, marking method, **JES 131**>

Default: **Disable**

Options: **0 = Disabled**

1 = Enabled

AS9132 /JES 131 Marking Method by ESP

Element Shape

The shape of the symbol's printed, dot peen, or etch markings.

Each symbol element represents one bit ('0' or '1') of binary data. Symbol elements can be either round or square, provided that they are consistent in size and spacing throughout the symbol.

Choice of **Element Shape** setting should be based on the actual element shape used in the symbol being verified.

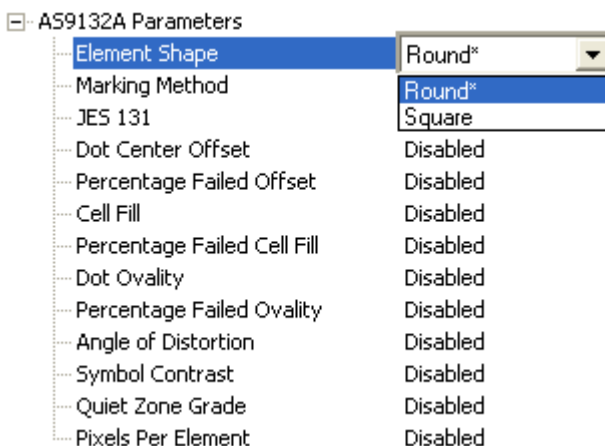

Marking Method

The marking method used to create the symbol (inkjet, dot peen, laser or electro-chemical etch, etc.).

Choice of **Marking Method** setting should be based on the method used to create the symbol being verified.

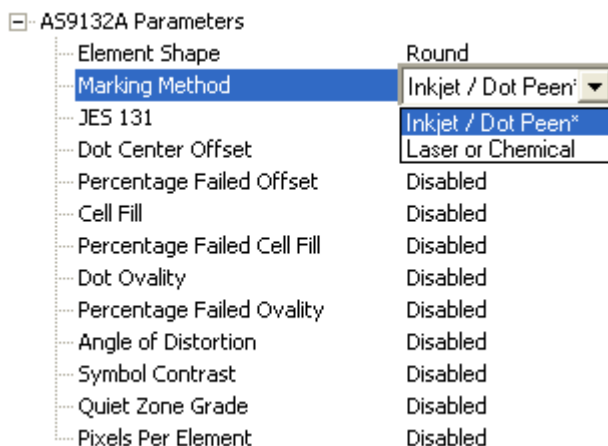

JES 131

When enabled, sets verification parameters to the **JES 131** specification rather than the AS9132 specification.

JES 131 specifies a Cell Fill upper threshold of 110% instead of AS9132's 105%.

JES 131 verification reports will display the heading "JES 131 Verification Report".

AS9132A Parameters	
Element Shape	Round
Marking Method	Inkjet / Dot Peen
JES 131	Disabled*
Dot Center Offset	Disabled*
Percentage Failed Offset	Enabled
Cell Fill	Disabled
Percentage Failed Cell Fill	Disabled
Dot Ovality	Disabled
Percentage Failed Ovality	Disabled
Angle of Distortion	Disabled
Symbol Contrast	Disabled
Quiet Zone Grade	Disabled
Pixels Per Element	Disabled

AS9132 Serial Output

Dot Center Offset

Definition: Measures the deviation of actual dot centers from theoretical or “ideal” dot centers.

Worst Case Value output shows the quality of the worst dot, expressed as a percentage of that particular dot center’s deviation from the ideal. **Average Value** output shows the average quality of all dots, expressed as a percentage of average dot center deviation from the ideal.

Important: Dot Center Offset is available only if **Element Shape** is set to **Round <K711,0>**. It cannot evaluate square elements.

Serial Cmd: *<K712, dot center offset, percentage failed offset, cell fill, percentage failed cell fill, dot ovality, percentage failed ovality, angle of distortion, symbol contrast, quiet zone grade, pixels per element value>*

Default: **Disabled**

Options:

0 = Disabled	1 = Worst Case Value
2 = Average Value	3 = Worst Case and Average Values
4 = Grade	5 = Grade and Worst Case Value
6 = Grade and Average Value	7 = Grade, Worst Case and Average Values

Worst Case Value (Dot Center Offset)

Definition: **Worst Case Value** is a percentage, and is shown in the output string as a three-digit value from **000** to **100**. For example, “004” = 4%.

Output Example: **Dot Center Offset Worst Case Value** highlighted below.

symbol_data, **004**, F, 045, 057, P, 002, 001, F, -08.20, P, 034, P, 12.4, ECC200, 018x018

Average Value (Dot Center Offset)

Definition: **Average Value** is a percentage, and is shown in the output string as a three-digit value from **000** to **100**. For example, “003” = 3%.

Output Example: **Dot Center Offset Average Value** highlighted below.

```
symbol_data, 003, F, 045, 057, P, 002, 001, F, -08.20, P, 034, P, 12.4, ECC200, 018x018
```

Worst Case and Average Values (Dot Center Offset)

Output Example: **Dot Center Offset Worst Case Value** and **Average Value** highlighted below.

```
symbol_data, 004, 003, F, 045, 057, P, 002, 001, F, -08.20, P, 034, P, 12.4, ECC200, 018x018
```

Grade (Dot Center Offset)

Definition: Grades take into account both the worst case and average values. A passing grade is represented by ‘P’, and a failing grade is represented by ‘F’.

Output Example: **Dot Center Offset Grade** highlighted below.

```
symbol_data, P, F, 045, 057, P, 002, 001, F, -08.20, P, 034, P, 12.4, ECC200, 018x018
```

Grade and Worst Case Value (Dot Center Offset)

Output Example: **Dot Center Offset Grade** and **Worst Case Value** highlighted below.

```
symbol_data, P, 004, F, 045, 057, P, 002, 001, F, -08.20, P, 034, P, 12.4, ECC200, 018x018
```

Grade and Average Value (Dot Center Offset)

Output Example: **Dot Center Offset Grade** and **Average Value** highlighted below.

```
symbol_data, P, 003, F, 045, 057, P, 002, 001, F, -08.20, P, 034, P, 12.4, ECC200, 018x018
```

Grade, Worst Case, and Average Values (Dot Center Offset)

Output Example: **Dot Center Offset Grade, Worst Case Value, and Average Value** highlighted below.

```
symbol_data, P, 004, 003, F, 045, 057, P, 002, 001, F, -08.20, P, 034, P, 12.4, ECC200, 018x018
```

Percentage Failed Offset

Definition: When enabled, reports the percentage of dots that failed **Dot Center Offset** evaluation.

Serial Cmd: <**K712**, dot center offset, **percentage failed offset**, cell fill, percentage failed cell fill, dot ovality, percentage failed ovality, angle of distortion, symbol contrast, quiet zone grade, pixels per element value>

Default: **Disabled**

Options: **0 = Disabled** 1 = Enabled

Cell Fill

Definition: Measures the percentage of the ideal cell size that the module or element fills. **Worst Case Value** output shows the quality of the worst element, expressed as a percentage of the ideal cell size filled by that particular element. **Average Value** output shows the average quality of all elements, expressed as a percentage of the ideal cell size filled by the average element.

Serial Cmd: <**K712**, dot center offset, percentage failed offset, **cell fill**, percentage failed cell fill, dot ovality, percentage failed ovality, angle of distortion, symbol contrast, quiet zone grade, pixels per element value>

Default: **Disabled**

Options: **0 = Disabled** 1 = Worst Case Value
 2 = Average Value 3 = Worst Case and Average Values
 4 = Grade 5 = Grade and Worst Case Value
 6 = Grade and Average Value 7 = Grade, Worst Case and Average Values

Worst Case Value (Cell Fill)

Definition: **Worst Case Value** is a percentage, and is shown in the output string as a three-digit value from **000** to **100**. For example, "045" = 45%.

Output Example: **Cell Fill Worst Case Value** highlighted below.

```
symbol_data, P, 004, 003, 045, P, 002, 001, F, -08.20, P, 034, P, 12.4, ECC200,
018x018
```

Average Value (Cell Fill)

Definition: **Average Value** is a percentage, and is shown in the output string as a three-digit value from **000** to **100**. For example, "057" = 57%.

Output Example: **Cell Fill Average Value** highlighted below.

```
symbol_data, P, 004, 003, 057, P, 002, 001, F, -08.20, P, 034, P, 12.4, ECC200,
018x018
```

Worst Case and Average Values (Cell Fill)

Output Example: **Cell Fill Worst Case Value** and **Average Value** highlighted below.

```
symbol_data,P,004,003,045,057,P,002,001,F,-08.20,P,034,P,12.4,  
ECC200,018x018
```

Grade (Cell Fill)

Definition: Grades take into account both the worst case and average values. A passing grade is represented by 'P', and a failing grade is represented by 'F'.

Output Example: **Cell Fill Grade** highlighted below.

```
symbol_data,P,004,003,F,P,002,001,F,-08.20,P,034,P,12.4,ECC200,  
018x018
```

Grade and Worst Case Value (Cell Fill)

Output Example: **Cell Fill Grade** and **Worst Case Value** highlighted below.

```
symbol_data,P,004,003,F,045,P,002,001,F,-08.20,P,034,P,12.4,  
ECC200,018x018
```

Grade and Average Value (Cell Fill)

Output Example: **Cell Fill Grade** and **Average Value** highlighted below.

```
symbol_data,P,004,003,F,057,P,002,001,F,-08.20,P,034,P,12.4,  
ECC200,018x018
```

Grade, Worst Case, and Average Values (Cell Fill)

Output Example: **Cell Fill Grade, Worst Case Value, and Average Value** highlighted below.

```
symbol_data,P,004,003,F,045,057,P,002,001,F,-08.20,P,034,P,12.4,  
ECC200,018x018
```

Percentage Failed Cell Fill

Definition: When enabled, reports the percentage of elements that failed **Cell Fill** evaluation.

Serial Cmd: <**K712**,dot center offset,percentage failed offset,cell fill,**percentage failed cell fill**,dot ovality,percentage failed ovality,angle of distortion,symbol contrast, quiet zone grade,pixels per element value>

Default: **Disabled**

Options: **0 = Disabled** 1 = Enabled

Dot Ovality

Definition: Measures the extent to which round elements deviate from a perfect circle. **Worst Case Value** output shows the quality of the worst element, expressed as a percentage of the deviation of the actual dot from the ideal. **Average Value** output shows the average quality of all elements, expressed as a percentage of the deviation of the average dot from the ideal.

For a symbol to achieve a passing grade, **Dot Ovality** must not exceed 20%, and no more than 2% of the symbol's dots can exceed 20% ovality.

Important: **Dot Ovality** is available only if **Element Shape** is set to **Round** <**K711,0**>. It cannot evaluate square elements.

Serial Cmd: <**K712**,dot center offset,percentage failed offset,cell fill,percentage failed cell fill,**dot ovality**,percentage failed ovality,angle of distortion,symbol contrast, quiet zone grade,pixels per element value>

Default: **Disabled**

Options: **0 = Disabled** 1 = Worst Case Value
 2 = Average Value 3 = Worst Case and Average Values
 4 = Grade 5 = Grade and Worst Case Value
 6 = Grade and Average Value 7 = Grade, Worst Case and Average Values

Worst Case Value (Dot Ovality)

Definition: **Worst Case Value** is a percentage, and is shown in the output string as a three-digit value from **000** to **100**. For example, "002" = 2%.

Output Example: **Dot Ovality Worst Case Value** highlighted below.

```
symbol_data,P,004,003,F,045,057,002,-08.20,P,034,P,12.4,ECC200,  
018x018
```

Average Value (Dot Ovality)

Definition: **Average Value** is a percentage, and is shown in the output string as a three-digit value from **000** to **100**. For example, “001” = 1%.

Output Example: **Dot Ovality Average Value** highlighted below.

```
symbol_data,P,004,003,F,045,057,001,F,-08.20,P,034,P,12.4,ECC200,018x018
```

Worst Case and Average Values (Dot Ovality)

Output Example: **Dot Ovality Worst Case Value** and **Average Value** highlighted below.

```
symbol_data,P,004,003,F,045,057,002,001,F,-08.20,P,034,P,12.4,ECC200,018x018
```

Grade (Dot Ovality)

Definition: Grades take into account both the worst case and average values. A passing grade is represented by ‘**P**’, and a failing grade is represented by ‘**F**’.

Output Example: **Dot Ovality Grade** highlighted below.

```
symbol_data,P,004,003,F,045,057,P,F,-08.20,P,034,P,12.4,ECC200,018x018
```

Grade and Worst Case Value (Dot Ovality)

Output Example: **Dot Ovality Grade** and **Worst Case Value** highlighted below.

```
symbol_data,P,004,003,F,045,057,P,002,F,-08.20,P,034,P,12.4,ECC200,018x018
```

Grade and Average Value (Dot Ovality)

Output Example: **Dot Ovality Grade** and **Average Value** highlighted below.

```
symbol_data,P,004,003,F,045,057,P,001,F,-08.20,P,034,P,12.4,ECC200,018x018
```

Grade, Worst Case, and Average Values (Dot Ovality)

Output Example: **Dot Ovality Grade, Worst Case Value,** and **Average Value** highlighted below.

```
symbol_data,P,004,003,F,045,057,P,002,001,F,-08.20,P,034,P,12.4,ECC200,018x018
```

Percentage Failed Ovality

Definition: When enabled, reports the percentage of dots that failed for **Dot Ovality**.

Serial Cmd: <K712, dot center offset, percentage failed offset, cell fill, percentage failed cell fill, dot ovality, **percentage failed ovality**, angle of distortion, symbol contrast, quiet zone grade, pixels per element value>

Default: **Disabled**

Options: **0 = Disabled** 1 = Enabled

Angle of Distortion

Definition: Measures the symbol's deviation from a 90° relation between row and column.

To receive a passing grade, the symbol's **Angle of Distortion** must not exceed $\pm 7^\circ$.

Serial Cmd: <K712, dot center offset, percentage failed offset, cell fill, percentage failed cell fill, dot ovality, percentage failed ovality, **angle of distortion**, symbol contrast, quiet zone grade, pixels per element value>

Default: **Disabled**

Options: **0 = Disabled** 1 = Grade
2 = Value 3 = Grade and Value

Grade

Definition: A passing grade is represented by 'P', and a failing grade is represented by 'F'.

Output Example: **Angle of Distortion Grade** highlighted below.

symbol_data, P, 004, 003, F, 045, 057, P, 002, 001, **F**, P, 034, P, 12.4, ECC200, 018x018

Value

Definition: **Angle of Distortion** shows the row/column angle deviation from 90°.

Output Example: **Angle of Distortion Value** highlighted below.

symbol_data, P, 004, 003, F, 045, 057, P, 002, 001, **-08.20**, P, 034, P, 12.4, ECC200, 018x018

Grade and Value

Output Example: **Angle of Distortion Grade** and **Value** highlighted below.

symbol_data, P, 004, 003, F, 045, 057, P, 002, 001, **F**, **-08.20**, P, 034, P, 12.4, ECC200, 018x018

Symbol Contrast

Definition: Measures the difference in the light and dark values of the symbol's elements. To receive a passing grade, the difference in value between the mark (dark value) and the substrate (light value) must be 20% or greater.

Important: **Symbol Contrast** output is only available when **Marking Method** is set to **Laser or Chemical Etch <K711,,1>**.

Serial Cmd: *<K712,dot center offset,percentage failed offset,cell fill,percentage failed cell fill,dot ovality,percentage failed ovality,angle of distortion,**symbol contrast**,quiet zone grade,pixels per element value>*

Default: **Disabled**

Options: **0 = Disabled** 1 = Grade (Laser/Chemical Etch Only)
 2 = Value 3 = Grade and Value (Laser/Chemical Etch Only)

Grade

Definition: A passing grade is represented by 'P', and a failing grade is represented by 'F'.

Output Example: **Symbol Contrast Grade** highlighted below.

```
symbol_data,P,004,003,F,045,057,P,002,001,F,-08.20,P,P,12.4,  
ECC200,018x018
```

Value

Definition: **Symbol Contrast Value** is a percentage, and is shown in the output string as a three-digit value from **000** to **100**. For example, "034" = 34%.

Output Example: **Symbol Contrast Value** highlighted below.

```
symbol_data,P,004,003,F,045,057,P,002,001,F,-08.20,034,P,12.4,  
ECC200,018x018
```

Grade and Value

Output Example: **Symbol Contrast Grade** and **Value** highlighted below.

```
symbol_data,P,004,003,F,045,057,P,002,001,F,-08.20,P,034,P,12.4,  
ECC200,018x018
```

Quiet Zone Grade

Definition: The **Quiet Zone** is a clear space of at least one module/element surrounding the symbol, required for symbol readability.

When enabled, this feature outputs a pass ('P') or fail ('F') grade for **Quiet Zone**.

Serial Cmd: <K712,dot center offset,percentage failed offset,cell fill,percentage failed cell fill,dot ovality,percentage failed ovality,angle of distortion,symbol contrast, **quiet zone grade**,pixels per element value>

Default: Disabled

Options: 0 = Disabled 1 = Grade

Output Example: Quiet Zone Grade highlighted below.

```
symbol_data,P,004,003,F,045,057,P,002,001,F,-08.20,P,034,P,12.4,
ECC200,018x018
```

Pixels Per Element Value

Definition: The number of pixels in each symbol element. The higher the **Pixels Per Element** count, the more readable the symbol.

When enabled, this feature outputs the pixels per element value.

Serial Cmd: <K712,dot center offset,percentage failed offset,cell fill,percentage failed cell fill,dot ovality,percentage failed ovality,angle of distortion,symbol contrast, quiet zone grade,**pixels per element value**>

Default: Disabled

Options: 0 = Disabled 1 = Value

Output Example: Pixels Per Element Value highlighted below.

```
symbol_data,P,004,003,F,045,057,P,002,001,F,-08.20,P,034,P,12.4,
ECC200,018x018
```

AS9132 Output by ESP

Dot Center Offset

Measures the deviation of actual dot centers from theoretical or “ideal” dot centers.

Ideal dot centers are based upon a prior grid-mapping calculation. It is not assumed that the cells are evenly placed, and they are adjusted if they are skewed.

Important: **Dot Center Offset** is available only if **Element Shape** is set to **Round**.

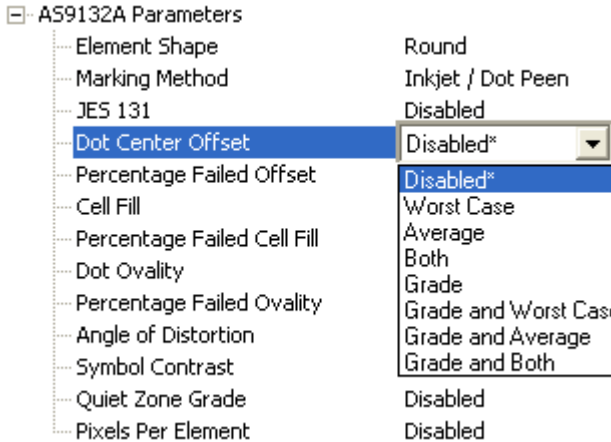

Percentage Failed Offset

When enabled, reports the percentage of dots that failed **Dot Center Offset** evaluation.

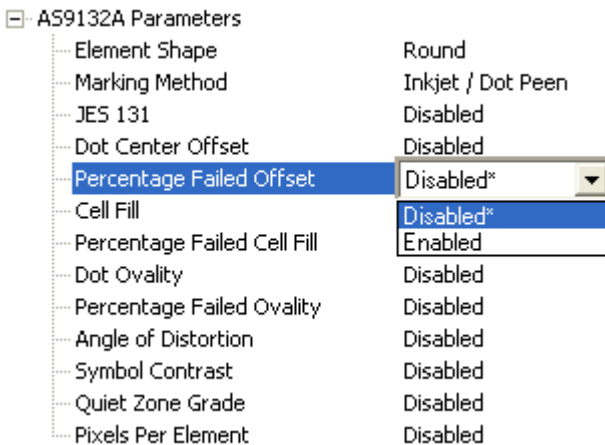

Cell Fill

Measures the percentage of the ideal cell size that the module or element fills.

Worst Case Value output shows the quality of the worst element, expressed as a percentage of the ideal cell size filled by that particular element. **Average Value** output shows the average quality of all elements, expressed as a percentage of the ideal cell size filled by the average element.

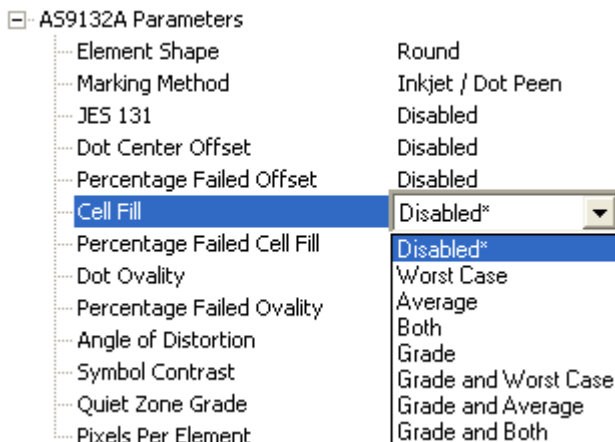

Percentage Failed Cell Fill

When enabled, reports the percentage of elements that failed **Cell Fill** evaluation.

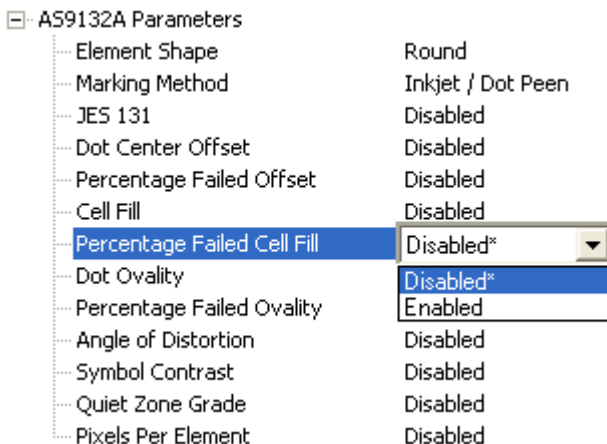

Dot Ovality

Measures the extent to which round elements deviate from a perfect circle.

For a symbol to achieve a passing grade, **Dot Ovality** must not exceed 20%, and no more than 2% of the symbol's dots can exceed 20% ovality.

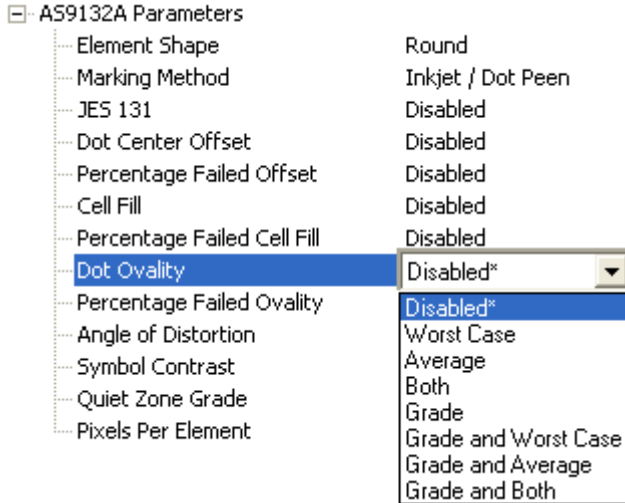

Percentage Failed Ovality

When enabled, reports the percentage of dots that failed **Dot Ovality** evaluation.

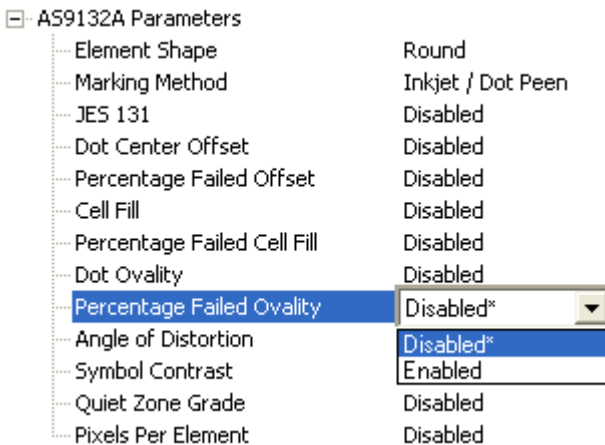

Angle of Distortion

Measures the symbol's deviation from a 90° relation between row and column.

To receive a passing grade, the symbol's **Angle of Distortion** must not exceed $\pm 7^\circ$.

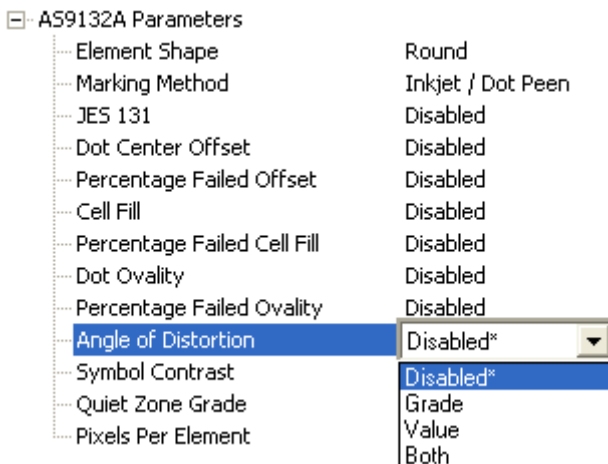

Symbol Contrast

Measures the difference in the light and dark values of the symbol's elements.

To receive a passing grade, the difference in value between the mark (dark value) and the substrate (light value) must be 20% or greater.

Important: Symbol Contrast output is only available when **Marking Method** is set to **Laser or Chemical Etch**.

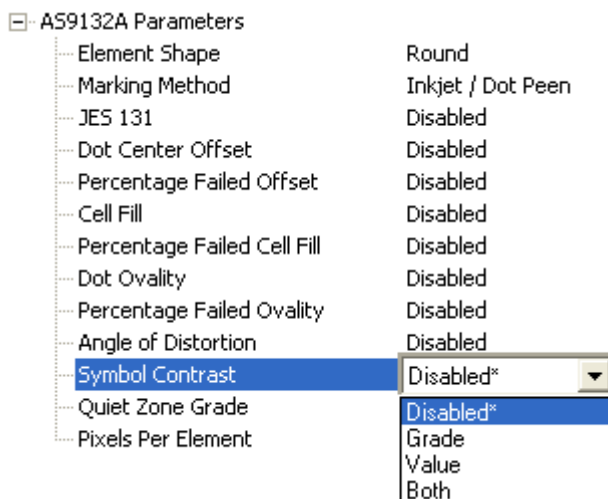

Quiet Zone Grade

The **Quiet Zone** is an unmarked space surrounding a symbol, required for symbol readability. To receive a passing grade, the Quiet Zone must be at least one element in width.

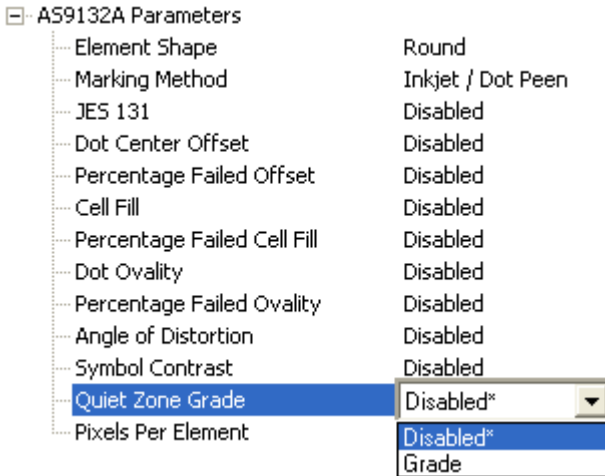

Pixels Per Element

The number of pixels in each symbol element. The higher the **Pixels Per Element** count, the more readable the symbol.

When enabled, this feature outputs the Pixels Per Element value.

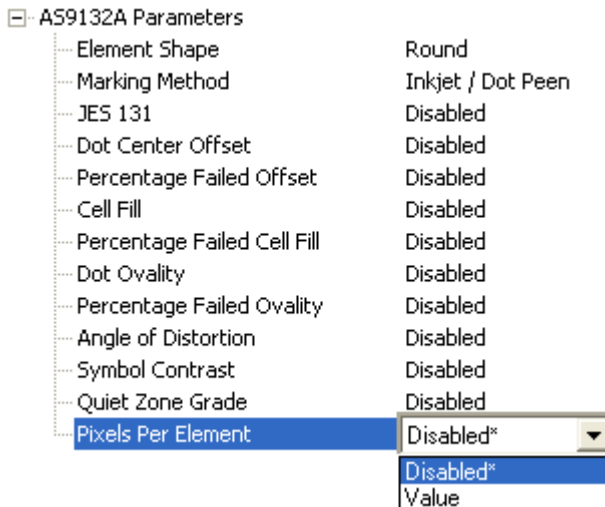

AS9132 Verification by Serial Command

Serial Cmd: <V3>

AS9132 Verification Process

- Place the candidate symbol as close to the center of the Verifier's field of view as possible.
- When the candidate symbol is in position, initiate the **AS9132 Verification** command <V3>.
- The **AS9132 Verification Report** will appear, detailing the symbol's adherence to AS9132 requirements.

AS9132 Verification Report

The **AS9132** results show data concerning marking method, element shape, quiet zone, contrast, cell fill, cell size, dot ovality, dot shape, dot center offset, dot spacing, angle of distortion, symbol type, matrix size, element size, and pixels per element. Symbol assessment is on a pass/fail basis.

```

-----
                        AS9132A Verification Report
-----
MARKING METHOD: DOT PEEN
ELEMENT SHAPE:  ROUND
PARAMETER          REQUIREMENT          RESULTS          FAIL IF 2% OF          PASS/FAIL
                   PER ELEMENT
QUIET ZONE:        => One element                PASS
CONTRAST:          > 20%                          36 %             N/A
CELL FILL/SIZE:    60% < size < 105%             105 %            PASS
DOT QUALITY/SHAPE: < 20%                          15 % avg.        0 % failed        PASS
DOT CENTER
OFFSET/SPACING:    < 20%                          10 % avg.        1 % failed        PASS
ANGLE OF
DISTORTION:        < +/- 7 Degrees                -1.93 degree     PASS
SYMBOL TYPE:       ECC200                          ECC200           PASS
MATRIX SIZE:       22x22
ELEMENT SIZE:      0.011"
PIXELS/ELEMENT:    10.5
SYMBOL DATA:      [ ]>>.06.17U77245.1P13209766.S1031..

```

AIM DPM Verification by Serial Command

Reflectance Calibration

Definition: The **Reflectance Calibration** command initiates a calibration process with the minimum and maximum reflectance values that are already configured in the Verifier.

Note: If the minimum and maximum reflectance values configured in the Verifier correspond with a different calibration symbol, the results after calibration may be incorrect.

Serial Cmd: `<@AIMDPM,R-min,R-min>`

- Place the calibration symbol provided in the approximate center of the Verifier's field of view before entering the **Reflectance Calibration** command.

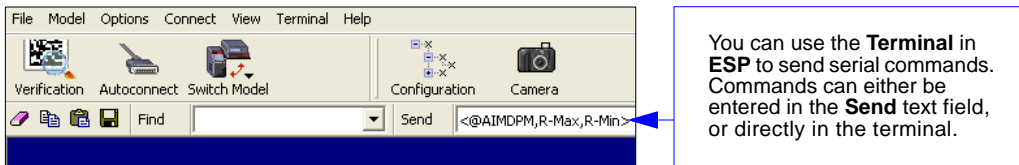
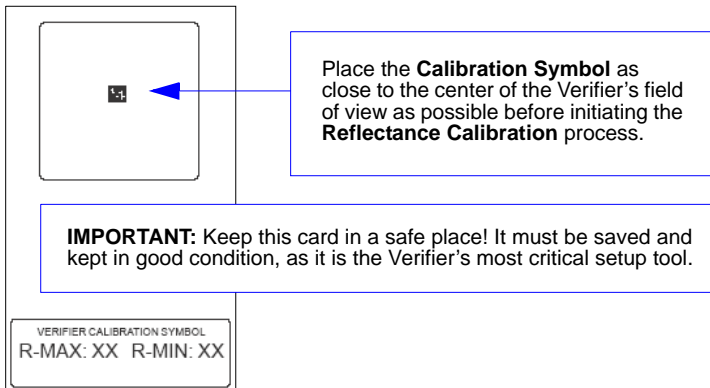

Important: After the Verifier is calibrated, you must allow 15 minutes of warmup time in **Live Video Mode**, `<K760,2>`, before starting a verification process. The LEDs must reach a steady output state for verification results to be valid.

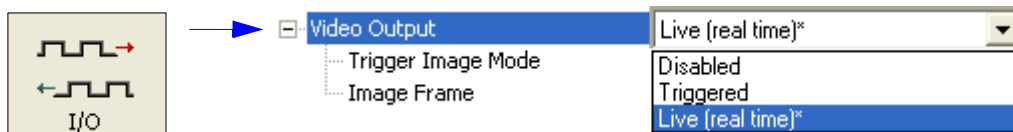

AIM DPM Verification Process

Serial Cmd: <V4>

- Once the reflectance calibration process is complete, place the candidate symbol as close to the center of the Verifier's field of view as possible.
- When the candidate symbol is in position, initiate the **AIM DPM Verification** command <V4>.
- The **AIM DPM Verification Report** will then appear, detailing the symbol's adherence to AIM DPM guidelines.

AIM DPM Verification Report

The **AIM DPM** results show data concerning the reference decode algorithm, cell contrast, fixed pattern damage, axial and grid non-uniformity, cell modulation, unused error correction, reflectance, print growth, symbol type, symbol size, element size, and pixels per element. All but the last five parameters are given a numeric and alphabetical grade.

```

DPM/4.0/15/660/45Q
-----
                        AIM DPM Quality Guideline
-----
PARAMETER                RESULTS                                GRADE
-----
REFERENCE DECODE:        PASS                                4 (A)
CELL CONTRAST:           85%                                4 (A)
FIXED PATTERN DAMAGE:    ----                                4 (A)
AXIAL NON-UNIFORMITY:    0.00                                4 (A)
GRID NON-UNIFORMITY:    0.01                                4 (A)
CELL MODULATION:         ----                                4 (A)
UNUSED ECC:              100%                                4 (A)
MINIMUM REFLECTANCE:    100%                                4 (A)
-----
FINAL GRADE:                                     4 (A)
NON-GRADED PARAMETERS:
PRINT GROWTH:            -0.03
SYMBOL TYPE:             ECC200
SYMBOL SIZE:             10x10
ELEMENT SIZE:            0.018"
PIXELS/ELEMENT:         18.4
SYMBOL DATA:           Y

```

Verification by ESP

The Quadrus Verifier's verification functionality can be controlled using **ESP's** graphic interfaces and tree controls.

Report Tab

The **Report** tab allows the user to initiate **ISO/IEC 15415 Verification**, **AS9132 Verification**, and **AIM DPM Verification**.

Verification reports appear in the viewing area underneath the verification buttons. To save the report as a PDF file, an HTML file, a CSV file, or an RTF file, click the **Save Report** button.

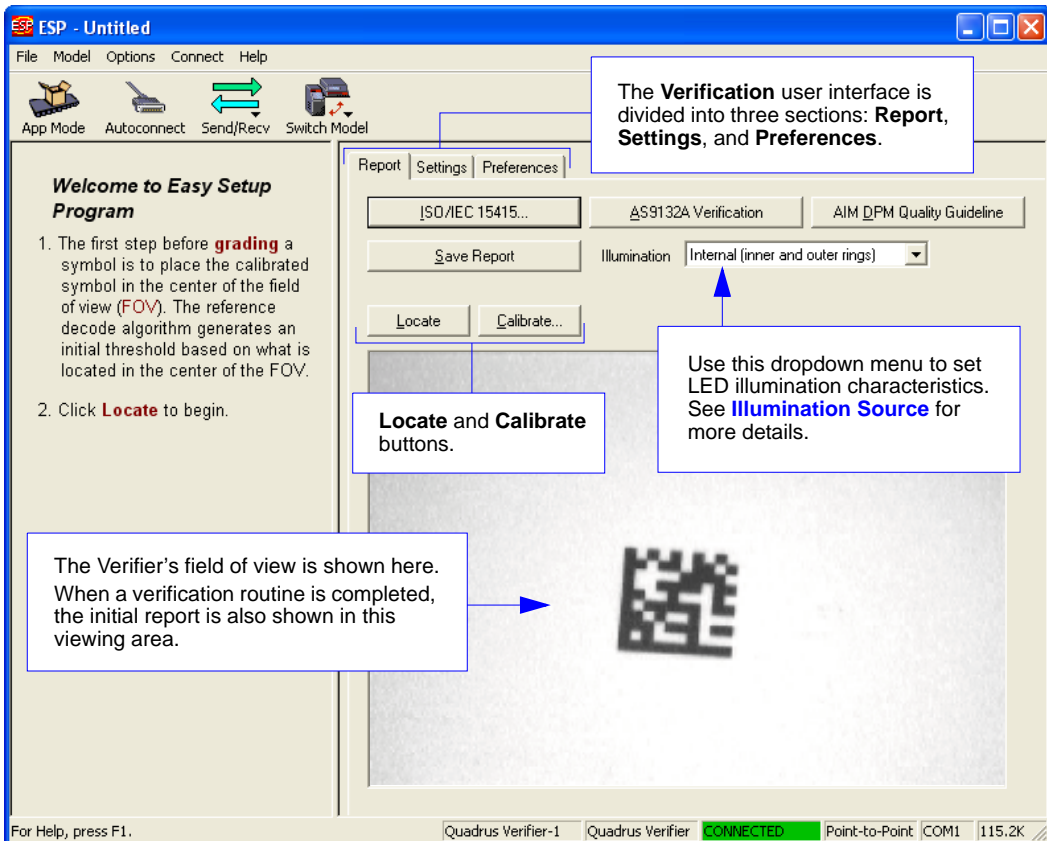

Settings Tab

The **Settings** tab allows users to view the candidate symbol in the Verifier's field of view using live video; to calibrate the Verifier for ISO/IEC 15415, AS9132, and AIM DPM verification; to set the desired image capture number; and, if using a Triggered mode, to determine the method of triggering.

Note: The **Live (real time)** setting is intended for applications in which an external video monitor is used. The video view in **ESP** is frame-by-frame, and is not "real-time" in the same sense as an external monitor.

The screenshot shows the 'Settings' tab with the following components:

- Video (External Monitor) Section:**
 - Status: Live (real time)* (dropdown menu)
 - Trigger Mode: Last Capture* (dropdown menu)
- Parameters Section:**
 - Tree control: Symbol Verification (expanded), Data Matrix, General.
 - Parameter list:
 - Symbol Contrast: Disabled
 - Fixed Pattern Damage: Disabled
 - Axial Non-uniformity: Disabled* (dropdown menu)
 - Grid Non-uniformity: Disabled*
 - Modulation: Disabled
 - Unused ECC: Disabled
 - Print Growth: Disabled
 - Pixels Per Element: Disabled
 - ISO/IEC 15415 Setup: +
 - AIM / DPM Setup: -
 - Minimum Element Size: 10
 - Maximum Element Size: 15
 - Wavelength: 660

To open the entire contents of the tree control, hold down the **Alt** key and single-click the **+** next to the first-level heading **Symbol Verification**.
To close the entire contents of the tree control, hold down the **Alt** key and single-click the **-**.

Preferences Tab

The **Preferences** tab allows the user to set defaults that are automatically activated when verification processes are completed. For this reason, the user is advised to set preferences before performing verification.

Report | Settings | Preferences

Fields for report

Operator Name: J. Doe

Company Name: XYZ Corp.

This information is appended at the bottom of the verification report.

Choose the default report type to be generated when you click **Save Report** on the **Report** tab. Check **Autofit Content** to ensure that saved PDF report content will fit on a single page.

Saved Options

Show Report Options dialog during 'Save Report'.

Default Report Type PDF Files (*.pdf)

PDF Files (*.pdf)
PDF Files (*.pdf)
HTML Files (*.htm)
CSV Files (*.csv)
Rich Text Edit Files (*.rtf)

Autofit Content Low Graphic HTML Append to file (.csv)

Store Report without file path prompt

Use symbol data for file name

C:\Documents and Settings\symbol grades Default Path

Automatically open generated report Print after saving

Include Image Bitmap JPEG

JPEG Image Quality 100 1 - 100

Typically you will be asked where you wish to store your verification report. If you do not want to be prompted to choose a file path, click **Store Report without file path prompt**.

Click the **Include Image** check box to output the captured symbol image with your saved report as a Bitmap or JPEG image file.

ISO/IEC 15415 Options

Enable MIL-STD-130M

Check type each time for ISO/IEC 15415 Verification

ISO/IEC 15415 Single Capture

ISO/IEC 15415 Multi-Capture

Enable UII Parsing

Default Settings Revert Settings

Returns all settings to default.

Returns all settings to most recent.

ISO/IEC 15415 Single Capture Verification

Single Capture Verification Process

Reflectance Calibration

The Quadrus Verifier comes with a calibration symbol on a card like the one shown below. A maximum and minimum reflectance value will be printed at the bottom of the card. These are the values you will enter in the **Minimum** and **Maximum** spin boxes in the **Reflectance Calibration** dialog.

Place the **Calibration Symbol** as close to the center of the Verifier's field of view as possible before initiating the **Reflectance Calibration** process.

IMPORTANT:
Keep this card in a safe place! It is the Verifier's most critical setup tool.

VERIFIER CALIBRATION SYMBOL
R-MAX: XX R-MIN: XX

Reflectance Calibration

Please input the reflectance values located on the card and click 'Calibrate Reflectance'.

ISO/IEC 15415 Reflectance Calibration

Minimum: 10 0 - 100

Maximum: 85 0 - 100

AIM / DPM Report Guidelines Reflectance Calibration

AS9132A Calibration

Calibrate Reflectance Cancel

When the R-min and R-min values are entered, click **Calibrate Reflectance**.

Once reflectance calibration is complete, **Single Capture Verification** can be performed and a report generated.

Single Capture Verification Report

The **ISO/IEC 15415 Single Capture** results show data concerning the reference decode algorithm, symbol contrast, fixed pattern damage, axial and grid non-uniformity, modulation, unused error correction, print growth, symbol type, symbol size, element size, and pixels per element. All but the last five parameters are given a numeric and alphabetical grade.

```
---/05/660
```

ISO/IEC 15415 Verification Report

PARAMETER	RESULTS	GRADE
REFERENCE DECODE:	PASS	4 (A)
SYMBOL CONTRAST:	82%	4 (A)
FIXED PATTERN DAMAGE:	----	4 (A)
AXIAL NON-UNIFORMITY:	0.01	4 (A)
GRID NON-UNIFORMITY:	0.01	4 (A)
MODULATION:	----	4 (A)
UNUSED ECC:	100%	4 (A)

FINAL GRADE: 4 (A)

NON-GRADED PARAMETERS:

PRINT GROWTH:	0.02
SYMBOL TYPE:	ECC200
SYMBOL SIZE:	10x10
ELEMENT SIZE:	0.019"
PIXELS/ELEMENT:	18.5

SYMBOL DATA: Y

Save Single Capture Verification Report

There are several possible ways to save your verification report, depending on what works best for your application.

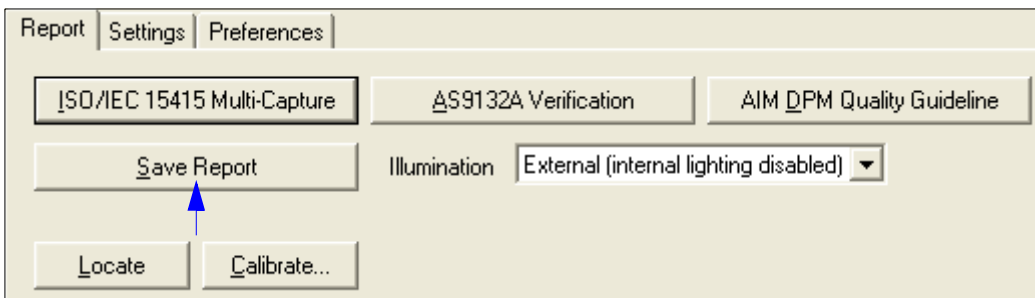

Save Single Capture Verification Report as a PDF

If you have already chosen PDF in the **Preferences** dialog, the report will be saved as a PDF file.

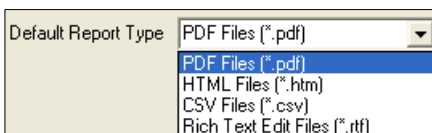

ISO/IEC 15415 Verification Report		
Parameters:	Results	Grade
Reference Decode	PASS	4 (A)
Symbol Contrast	75%	4 (A)
Fixed Pattern Damage	----	4 (A)
Axial Non-Uniformity	0.02	4 (A)
Grid Non-Uniformity	0.18	4 (A)
Modulation	----	4 (A)
Unused ECC	100%	4 (A)
Final Grade:		4 (A)

Symbol data.	Symbol Data:	123	Data for non-graded parameters.
	Non-Graded Parameters:		
	Print Growth	-0.04	
	Symbol Type	ECC200	
	Symbol Size	16x16	
	Pixels/Element	10.3	

Captured symbol image.

Reference data: Verifier firmware version, Verifier serial number, report creation date, ESP version, company name, and operator name.

Aperture: 0.000" Wavelength: 660 nm Angle: 45 degrees
 Firmware Version 35-676201-E2
 Verifier Serial Number
 This report was created on Saturday, February 04, 2006 at 22:00:33
 Software Version 3.2.1.0
 Company: XYZ Corp.
 Operator: J. Doe

Note: See [Preferences Tab](#) for information about how to “autofit” PDF reports to a single page.

Save Single Capture Verification Report as an HTML File

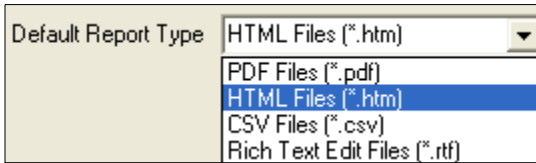

If you have already chosen HTML format in the **Preferences** dialog, the report will be saved as an HTML file.

ISO/IEC 15415 Verification Report		
Parameters:	Results	Grade
Reference Decode	PASS	4 (A)
Symbol Contrast	71%	4 (A)
Fixed Pattern Damage	----	4 (A)
Axial Non-Uniformity	0.09	4 (A)
Grid Non-Uniformity	0.06	4 (A)
Modulation	----	4 (A)
Unused ECC	84%	4 (A)
		Final Grade: 4 (A)

Symbol data. — **Symbol Data:** — 123

Non-Graded Parameters:	
Print Growth	-0.10
Symbol Type	ECC200
Symbol Size	16x16
Pixels/Element	6.1

Data for non-graded parameters.

Symbol Image: (Image scaled to 480x360):

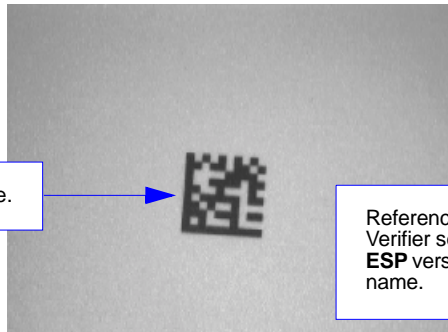

Captured symbol image. —

Reference data: Verifier firmware version, Verifier serial number, report creation date, **ESP** version, company name, and operator name.

Aperture: 0.000" Wavelength: 660 nm Angle: 45 degrees
 Firmware Version 35-676201-E2
 Verifier Serial Number
 This report was created on Wednesday, February 01, 2006 at 14:57:02
 Software Version 3.2.1.0
 Company: XYZ Corp.
 Operator: J. Doe

Save Single Capture Verification Report as a CSV File

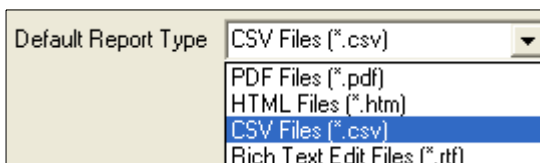

If you have already chosen CSV format in the **Preferences** dialog, the report will be saved as a CSV file.

CSV output is in a spreadsheet format, with all parameters listed in a horizontal orientation.

Columns A - I:

- Symbol Data
- Reference Decode Grade
- Symbol Contrast
- Fixed Pattern Damage
- Axial Non-Uniformity

	A	B	C	D	E	F	G	H	I
1	Sym_Data	Ref_Dec		Sym_Con		Fixed_Pat_Dam		Axial_Nu	
2		123 PASS	4 (A)	81% 4 (A)	----		4 (A)	0.01	4 (A)

Columns J - P:

- Grid Non-Uniformity
- Modulation
- Unused ECC
- Final Grade

	J	K	L	M	N	O	P
1	Grid_Nu		Modulation		Unused_ECC		Final_Grade
2	0.03	4 (A)	----	4 (A)	100% 4 (A)	4 (A)	

Columns Q - W:

- Print Growth
- Symbol Type
- Pixels Per Element
- Aperture
- Wavelength
- Angle

	Q	R	S	T	U	V	W
1	Print_Growth	Sym_Type	Sym_Size	Pix_Element	Aperture	Wavelength	Angle
2	-0.01	ECC200	10x10		11.6 0x000"	660 nm	45 degrees

Columns X - AC:

- Firmware Version
- Verifier Serial Number
- Date/Time
- ESP Version
- Company
- Operator

	X	Y	Z	AA	AB	AC
1	Firmware_Vers	Verifier Ser_Num	Report_Created	Vers	Company	Operator
2			0 2/4/2006 22:08	3.2.1.0	XYZ Corp.	J. Doe

Save Single Capture Verification Report as an RTF

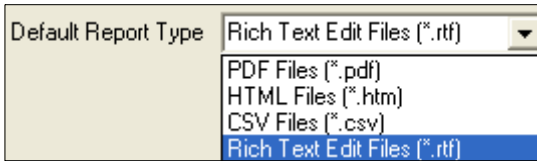

If you have already chosen RTF in the **Preferences** dialog, the report will be saved as an RTF file.

ISO/IEC 15415 Verification Report		
PARAMETER	RESULTS	GRADE
REFERENCE DECODE:	PASS	4 (A)
SYMBOL CONTRAST:	71%	4 (A)
FIXED PATTERN DAMAGE:	----	4 (A)
AXIAL NON-UNIFORMITY:	0.09	4 (A)
GRID NON-UNIFORMITY:	0.12	4 (A)
MODULATION:	----	4 (A)
UNUSED ECC:	50%	4 (A)
FINAL GRADE:		4 (A)
NON-GRADED PARAMETERS:		
PRINT GROWTH:	-0.08	
SYMBOL TYPE:	ECC200	
SYMBOL SIZE:	16x16	
PIXELS/ELEMENT:	6.1	
SYMBOL DATA: 123		
Aperture: 0.000" Wavelength: 660 nm		
Firmware Version		
Serial Number		
This report was created on Wednesday, February 01, 2006 at 15:09:37		
Company: XYZ Corp.		
Operator: J. Doe		

Verification results and grades.

Non-graded parameters and symbol data.

Note: Image captures are output simultaneously with the RTF. The format (JPG or BMP) is determined in the **Preferences** dialog.

Reference data: Verifier firmware version, Verifier serial number, report creation date, **ESP** version, company name, and operator name.

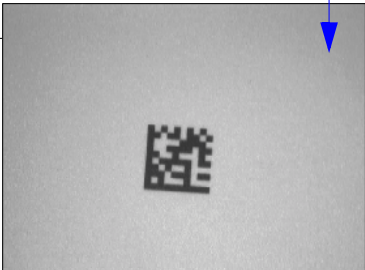

ISO/IEC 15415 Multi-Capture Verification

Multi-Capture Verification Process

Reflectance Calibration

The Quadrus Verifier comes with a calibration symbol on a card like the one shown below. A maximum and minimum reflectance value will be printed at the bottom of the card. These are the values you will enter in the **Minimum** and **Maximum** spin boxes in the **Reflectance Calibration** dialog.

Place the **Calibration Symbol** as close to the center of the Verifier's field of view as possible before initiating the **Reflectance Calibration** process.

IMPORTANT:
Keep this card in a safe place! It is the Verifier's most critical setup tool.

VERIFIER CALIBRATION SYMBOL
R-MAX: XX R-MIN: XX

Reflectance Calibration

Please input the reflectance values located on the card and click 'Calibrate Reflectance'.

ISO/IEC 15415 Reflectance Calibration

Minimum: 10 0 - 100

Maximum: 85 0 - 100

AIM / DPM Report Guidelines Reflectance Calibration

AS9132A Calibration

Calibrate Reflectance Cancel

When the **R-min** and **R-min** values are entered, click **Calibrate Reflectance**.

Once reflectance calibration is complete, **Multi-Capture Verification** can be performed and a report generated.

Multi-Capture Sequence

- Once the reflectance calibration process is complete, place the candidate symbol as close to the center of the verifier's field of view as possible.

Important: Multi-Capture Verification requires five captures at 72° intervals throughout a 360° rotation. When the symbol is placed in the Verifier's field of view, its position should be considered its default position -- 0°. ISO/IEC 15415 requires that the symbol's orientation for the first capture be 45°. This means 45° from the default symbol position, 0°.

- When you see the first rotation prompt, trigger the first capture. The prompts that follow will guide you through the sequence.

Step 1: 45° Rotation



Default Position: 0°



45°

Step 2: 117° Rotation

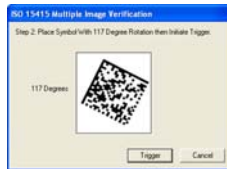

Default Position: 0°



117°

Step 3: 189° Rotation



Default Position: 0°



189°

Step 4: 261° Rotation



Default Position: 0°



261°

Step 5: 333° Rotation



Default Position: 0°



333°

Multi-Capture Verification Report

After the final rotation and trigger, the Verifier will output the **ISO/IEC 15415 Multi-Capture Verification Report**, shown below.

The **ISO/IEC Multi-Capture** parameters are the same as those for **ISO/IEC Single Capture**, but **Multi-Capture** results are determined only after the symbol is read at five 72° intervals throughout a full 360° rotation. The overall symbol grade is based on an arithmetic mean of the results from the five reads.

```
Starting Multiple Image Verification...
Step 1: Place symbol with 45 degree rotation then initiate trigger.
Step 2: Rotate 72 degrees then initiate trigger.
Step 3: Rotate 72 degrees then initiate trigger.
Step 4: Rotate 72 degrees then initiate trigger.
Step 5: Rotate 72 degrees then initiate trigger.
4.0/05/660
```

ISO/IEC 15415 VERIFICATION REPORT						
PARAMETER	SINGLE RESULTS					MEAN VALUES
REFERENCE DECODE:	4 <A>	4 <A>	4 <A>	4 <A>	4 <A>	PASS
SYMBOL CONTRAST:	4 <A>	4 <A>	4 <A>	4 <A>	4 <A>	82%
FIXED PATTERN DAMAGE:	4 <A>	4 <A>	4 <A>	4 <A>	4 <A>	----
AXIAL NON-UNIFORMITY:	4 <A>	4 <A>	4 <A>	4 <A>	4 <A>	0.00
GRID NON-UNIFORMITY:	4 <A>	4 <A>	4 <A>	4 <A>	4 <A>	0.00
MODULATION:	4 <A>	4 <A>	4 <A>	4 <A>	4 <A>	----
UNUSED ECC:	4 <A>	4 <A>	4 <A>	4 <A>	4 <A>	100%
FINAL GRADES:	4 <A>	4 <A>	4 <A>	4 <A>	4 <A>	
OVERALL GRADE:						4.0 <A>
NON-GRADED PARAMETERS:						
PRINT GROWTH:	0.01					
SYMBOL TYPE:	ECC200					
SYMBOL SIZE:	10x10					
ELEMENT SIZE:	0.019"					
PIXELS/ELEMENT:	18.6					
SYMBOL DATA:	Y					

Save Multi-Capture Verification Report

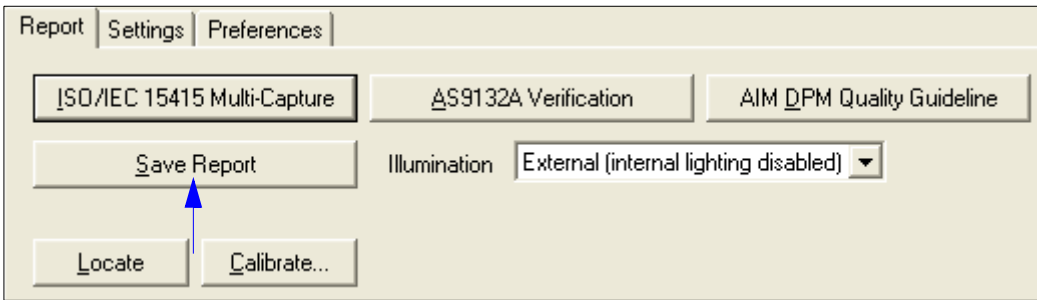

Save Multi-Capture Verification Report as a PDF

If you have already chosen PDF in the **Preferences** dialog, the report will be saved as a PDF file.

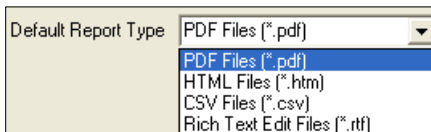

Verification results and mean values.

ISO/IEC 15415 Verification Report						
Parameters:	Single Results					Mean Values
Reference Decode	4 (A)	4 (A)	4 (A)	4 (A)	4 (A)	PASS
Symbol Contrast	4 (A)	4 (A)	4 (A)	4 (A)	4 (A)	74%
Fixed Pattern Damage	4 (A)	4 (A)	4 (A)	4 (A)	4 (A)	----
Axial Non-Uniformity	4 (A)	4 (A)	4 (A)	4 (A)	4 (A)	0.02
Grid Non-Uniformity	4 (A)	4 (A)	4 (A)	4 (A)	4 (A)	0.18
Modulation	4 (A)	4 (A)	4 (A)	4 (A)	4 (A)	----
Unused ECC	4 (A)	4 (A)	4 (A)	4 (A)	4 (A)	100%
Final Grades	4 (A)	4 (A)	4 (A)	4 (A)	4 (A)	
Overall Grade						4 (A)

Symbol Data:
Non-Graded Parameters:

Print Growth	-0.04
Symbol Type	ECC200
Symbol Size	16x16
Pixels/Element	10.3

Symbol data.

123

Data for non-graded parameters.

Symbol Image: (Image scaled to 480x360):

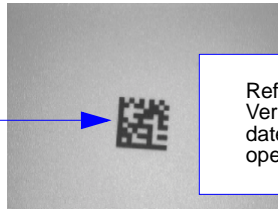

Captured symbol image.

Reference data: Verifier firmware version, Verifier serial number, report creation date, **ESP** version, company name, and operator name.

Aperture: 0.000" Wavelength: 660 nm Angle: 45 degrees
 Firmware Version
 Verifier Serial Number
 This report was created on Saturday, February 04, 2006 at 20:01:52
 Company: XYZ Corp.
 Operator: J. Doe

Note: See [Preferences Tab](#) for information about how to “autofit” PDF reports to a single page.

Save Multi-Capture Verification Report as an HTML File

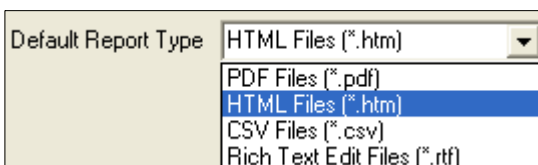

If you have already chosen HTML format in the **Preferences** dialog, the report will be saved as an HTML file.

ISO/IEC 15415 Verification Report

Parameters:

	Single Results					Mean Values
Reference Decode	4 (A)	4 (A)	4 (A)	4 (A)	4 (A)	PASS
Symbol Contrast	4 (A)	4 (A)	4 (A)	4 (A)	4 (A)	74%
Fixed Pattern Damage	4 (A)	4 (A)	4 (A)	4 (A)	4 (A)	----
Axial Non-Uniformity	4 (A)	4 (A)	4 (A)	4 (A)	4 (A)	0.02
Grid Non-Uniformity	4 (A)	4 (A)	4 (A)	4 (A)	4 (A)	0.18
Modulation	4 (A)	4 (A)	4 (A)	4 (A)	4 (A)	----
Unused ECC	4 (A)	4 (A)	4 (A)	4 (A)	4 (A)	100%
Final Grades	4 (A)	4 (A)	4 (A)	4 (A)	4 (A)	
Overall Grade						4 (A)

Verification results and mean values.

Symbol Data:
Non-Graded Parameters:

Symbol data. 123

Print Growth	-0.04
Symbol Type	ECC200
Symbol Size	16x16
Pixels/Element	10.3

Data for non-graded parameters.

Symbol Image: (Image scaled to 480x360):

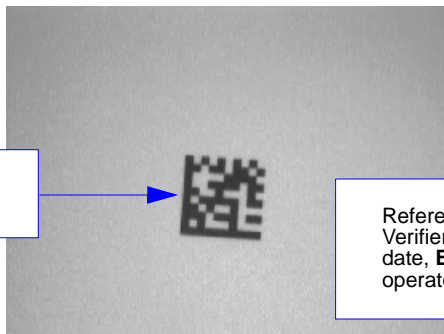

Captured symbol image.

Reference data: Verifier firmware version, Verifier serial number, report creation date, **ESP** version, company name, and operator name.

Aperture: 0.000" Wavelength: 660 nm Angle: 45 degrees
 Firmware Version 35-676201-E2
 Verifier Serial Number
 This report was created on Saturday, February 04, 2006 at 20:14:22
 Software Version 3.2.1.0
 Company: XYZ Corp.
 Operator: J. Doe

Save Multi-Capture Verification Report as a CSV File

CSV output is in a spreadsheet format, with all parameters listed in a horizontal orientation.

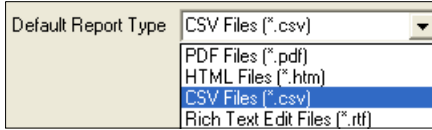

If you have already chosen CSV format in the **Preferences** dialog, the report will be saved as a CSV file.

Columns A - M:

- Symbol Data
- Reference Decode Grade
- Symbol Contrast

A screenshot of a spreadsheet application window. The menu bar includes File, Edit, View, Insert, Format, Tools, Data, Window, and Help. The active cell is A31. The spreadsheet shows two rows of data:

	A	B	C	D	E	F	G	H	I	J	K	L	M
1	Sym_Data	Ref_Dec						Sym_Con					
2	123	PASS	4 (A)	4 (A)	4 (A)	4 (A)	4 (A)	74%	4 (A)	4 (A)	4 (A)	4 (A)	4 (A)

Columns N - Y:

- Fixed Pattern Damage
- Axial Non-Uniformity

A screenshot of a spreadsheet application window. The menu bar includes File, Edit, View, Insert, Format, Tools, Data, Window, and Help. The active cell is A31. The spreadsheet shows two rows of data:

	N	O	P	Q	R	S	T	U	V	W	X	Y
1	Fixed_Pat_Dam						Axial_Nu					
2	----		4 (A)	4 (A)	4 (A)	4 (A)	0.02	4 (A)	4 (A)	4 (A)	4 (A)	4 (A)

Columns Z - AK:

- Grid Non-Uniformity
- Modulation

A screenshot of a spreadsheet application window. The menu bar includes File, Edit, View, Insert, Format, Tools, Data, Window, and Help. The active cell is AN34. The spreadsheet shows two rows of data:

	Z	AA	AB	AC	AD	AE	AF	AG	AH	AI	AJ	AK
1	Grid_Nu						Modulation					
2	0.18	4 (A)	4 (A)	4 (A)	4 (A)	4 (A)	----	4 (A)	4 (A)	4 (A)	4 (A)	4 (A)

Columns AL - AW:

- Unused ECC
- Overall Grade
- Final Grade

A screenshot of a spreadsheet application window. The menu bar includes File, Edit, View, Insert, Format, Tools, Data, Window, and Help. The active cell is BC38. The spreadsheet shows two rows of data:

	AL	AM	AN	AO	AP	AQ	AR	AS	AT	AU	AV	AW
1	Unused_ECC						Overall_Grade	Final_Grade				
2	100%	4 (A)	4 (A)	4 (A)	4 (A)	4 (A)	4.0	4 (A)	4 (A)	4 (A)	4 (A)	4 (A)

Columns AX - BC:

- Print Growth
- Symbol Type
- Symbol Size
- Pixels Per Element
- Aperture
- Wavelength

A screenshot of a spreadsheet application window. The menu bar includes File, Edit, View, Insert, Format, Tools, Data, Window, and Help. The active cell is BE26. The spreadsheet shows two rows of data:

	AX	AY	AZ	BA	BB	BC
1	Print_Growth	Sym_Type	Sym_Size	Pix_Element	Aperture	Wavelength
2	0	ECC200	14x14		9.9 0x000"	660 nm

Columns BD - BJ:

- Angle
- Firmware
- Serial Number
- Date/Time
- ESP Version
- Company
- Operator

A screenshot of a spreadsheet application window. The menu bar includes File, Edit, View, Insert, Format, Tools, Data, Window, and Help. The active cell is BQ23. The spreadsheet shows two rows of data:

	BD	BE	BF	BG	BH	BI	BJ
1	Angle	Firmware	Verifier_Ser	Created		Company	Operator
2	45 degrees			0 2/4/2006 20:23		XYZ Corp.	J. Doe

Save Multi-Capture Verification Report as an RTF

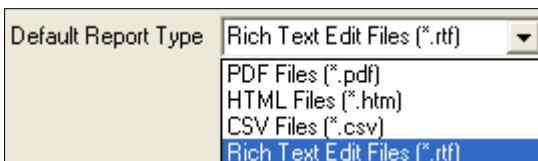

If you have already chosen RTF in the **Preferences** dialog, the report will be saved as an RTF file.

ISO/IEC 15415 VERIFICATION REPORT

PARAMETER	SINGLE RESULTS					MEAN VALUES
REFERENCE DECODE:	4 (A)	4 (A)	4 (A)	4 (A)	4 (A)	PASS
SYMBOL CONTRAST:	4 (A)	4 (A)	4 (A)	4 (A)	4 (A)	74%
FIXED PATTERN DAMAGE:	4 (A)	4 (A)	4 (A)	4 (A)	4 (A)	----
AXIAL NON-UNIFORMITY:	4 (A)	4 (A)	4 (A)	4 (A)	4 (A)	0.02
GRID NON-UNIFORMITY:	4 (A)	4 (A)	4 (A)	4 (A)	4 (A)	0.18
MODULATION:	4 (A)	4 (A)	4 (A)	4 (A)	4 (A)	----
UNUSED ECC:	4 (A)	4 (A)	4 (A)	4 (A)	4 (A)	100%
FINAL GRADES:	4 (A)	4 (A)	4 (A)	4 (A)	4 (A)	
OVERALL GRADE:						4.0 (A)

NON-GRADED PARAMETERS:

PRINT GROWTH:	-0.04
SYMBOL TYPE:	ECC200
SYMBOL SIZE:	16x16
PIXELS/ELEMENT:	10.3
SYMBOL DATA:	123

Aperture: 0.000" Wavelength: 660 nm
 Firmware Version
 Serial Number
 This report was created on Saturday, February 04, 2006 at 19:54:43
 Company: XYZ Corp.
 Operator: J. Doe

Verification results, grades, and mean values.

Non-graded parameters and symbol data.

Note: Image captures are output simultaneously with the RTF. The format (JPG or BMP) is determined in the **Preferences** dialog.

Reference data: Verifier firmware version, Verifier serial number, report creation date, **ESP** version, company name, and operator name.

AS9132 Verification

AS9132 Calibration

Select **AS9132A Calibration** on the **Reflectance Calibration** dialog and click **Calibrate AS9132A**.

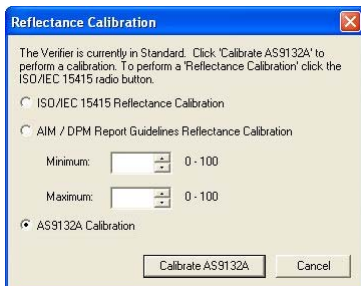

Once calibration is complete, **AS9132 Verification** can be performed and a report generated.

AS9132 Verification Process

- Be sure that the candidate symbol as close to the center of the verifier's field of view as possible.
- When the symbol is in position, click the **AS9132A Verification** button.

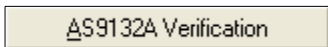

- The **AS9132A Verification Report** will appear, detailing the symbol's adherence to AS9132 requirements.

```
-----
                        AS9132A Verification Report
-----
MARKING METHOD: DOT PEEN
ELEMENT SHAPE: ROUND

PARAMETER      REQUIREMENT      RESULTS      FAIL IF 2% OF      PASS/FAIL
                PER ELEMENT
QUIET ZONE:    => One element          PASS
CONTRAST:      > 20%                36 %
CELL FILL/SIZE: 60% < size < 105%    105 %
DOT QUALITY/SHAPE: < 20%            15 % avg.      0 % failed      PASS
DOT CENTER
OFFSET/SPACING: < 20%            10 % avg.      1 % failed      PASS
ANGLE OF
DISTORTION:    < +/- 7 Degrees      -1.93 degree   PASS
SYMBOL TYPE:   ECC200                ECC200         PASS
MATRIX SIZE:   22x22
ELEMENT SIZE:   0.011"
PIXELS/ELEMENT: 10.5
SYMBOL DATA:  [>>.06.17U77245.1P13209766.S1031..
```

Save AS9132 Verification Report

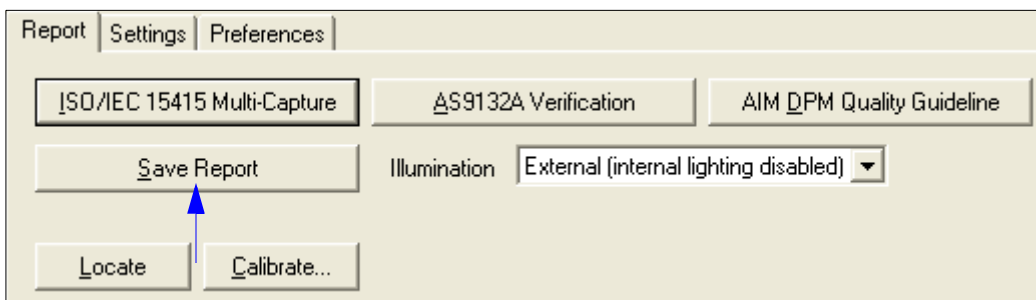

Save AS9132 Verification Report as a PDF

If you have already chosen PDF in the **Preferences** dialog, the report will be saved as a PDF file.

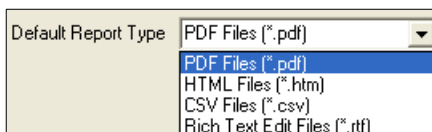

Marking Method: DOT PEEN
Element Shape: ROUND

Parameters:

Requirement Per Element	Results	Fail if 2% of Element Fail	Pass/Fail
Quiet Zone: => One element			PASS
Contrast: > 20%	96 %		N/A
Cell Fill/Size: 60% < size < 105%	95 % avg.	0 % failed	
Dot			PASS
Ovality/Shape: < 20%	3 % avg.	0 % failed	PASS
Dot Center			PASS
Offset/Spacing: < 20%	5 % avg.	0 % failed	PASS
Angle of Distortion: < +/- 7 Degrees	-0.90 degree		PASS
Symbol Type: ECC200	ECC200		PASS

Non-Graded Parameters:

Matrix Size: 16x16
Pixels/Element: 10.2
Symbol Data: 123

Verification results and pass / fail grades.

Symbol data.

Data for non-graded parameters.

Captured symbol image.

Symbol Image: (Image scaled to 480x360):

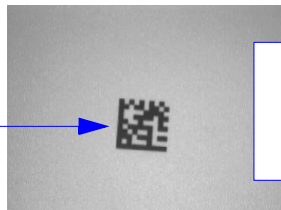

Verifier firmware version, Verifier serial number, report creation date, ESP version, company name, and operator name.

Firmware Version
Verifier Serial Number
This report was created on Saturday, February 04, 2006 at 21:30:46
Company: XYZ Corp.
Operator: J. Doe

Note: See [Preferences Tab](#) for information about how to “autofit” PDF reports to a single page.

Save AS9132 Verification Report as an HTML File

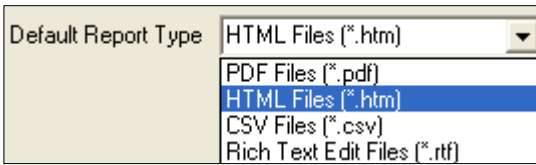

If you have already chosen HTML format in the **Preferences** dialog, the report will be saved as an HTML file.

AS 9132A Verification Report

Marking Method: DOT PEEN

Element Shape: ROUND

Parameters:

	<u>Requirement Per Element</u>	<u>Results</u>	<u>Fail if 2% of Element Fail</u>	<u>Pass/Fail</u>
Quiet Zone:	=> One element			PASS
Contrast:	> 20%	96 %		N/A
Cell Fill/Size:	60% < size < 105%	95 % avg.	0 % failed	PASS
Dot Ovality/Shape:	< 20%	3 % avg.	0 % failed	PASS
Dot Center Offset/Spacing:	< 20%	5 % avg.	0 % failed	PASS
Angle of Distortion:	< +/- 7 Degrees	-0.90 degree		PASS
Symbol Type:	ECC200	ECC200		PASS

Verification results and pass / fail grades.

Non-Graded Parameters:

Matrix Size:	16x16
Pixels/Element:	10.2
Symbol Data:	123

Symbol data.

Data for non-graded parameters.

Symbol Image: (Image scaled to 480x360):

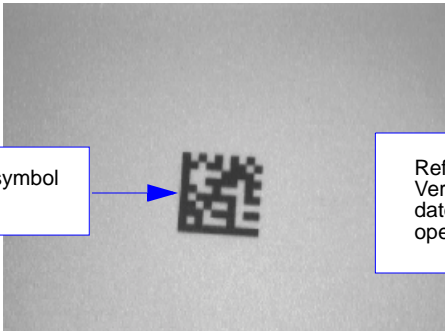

Captured symbol image.

Reference data: Verifier firmware version, Verifier serial number, report creation date, **ESP** version, company name, and operator name.

Firmware Version 35-676201-E2
 Verifier Serial Number
 This report was created on Saturday, February 04, 2006 at 21:35:19
 Software Version 3.2.1.0
 Company: XYZ Corp.
 Operator: J. Doe

Save AS9132 Verification Report as a CSV File

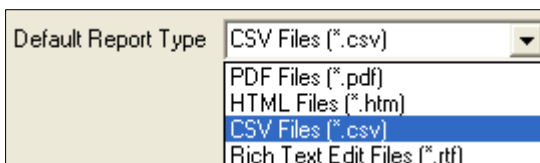

If you have already chosen CSV format in the **Preferences** dialog, the report will be saved as a CSV file.

CSV output is in a spreadsheet format, with all parameters listed in a horizontal orientation.

Columns A - G:

- Symbol Data
- Marking Method
- Element Shape
- Quiet Zone

	A	B	C	D	E	F	G
1	Sym_Data	Mark_Meth	Elem_Shape	Quiet_Zone			
2	123	DOT	PEENROUND	=> One element	----	----	PASS

Columns H - O:

- Contrast
- Cell Fill

	H	I	J	K	L	M	N	O
1	Contrast				Cell_Fill			
2	> 20%	84%	----	N/A	60%	< size < 105%	100%	avg.0% failed PASS

Columns P - W:

- Dot Ovality
- Dot Center Offset

	P	Q	R	S	T	U	V	W
1	Dot_Ovality				Dot_Center			
2	< 20%	1%	avg.0% failed PASS	< 20%	2%	avg.0%	failed PASS	

Columns X - AE:

- Angle of Distortion
- Symbol Type

	X	Y	Z	AA	AB	AC	AD	AE
1	Angle_Distortion				Sym_Type			
2	< +/- 7 Degrees	-0.7	----	PASS	ECC200	ECC200	----	PASS

Columns AF - AI:

- Matrix Size
- Pixels Per Element
- Firmware Version
- Verifier Serial Number

	AF	AG	AH	AI
1	Matrix_Size	Pix_Element	Firmware_Vers	Verifier_Ser_Num
2	14x14	9.5		0

Columns AJ - AM:

- Date/Time
- ESP Version
- Company
- Operator

	AJ	AK	AL	AM
1	Report_Created	Vers	Company	Operator
2	2/4/2006 21:12		XYZ Corp.	J. Doe

Save AS9132 Verification Report as an RTF

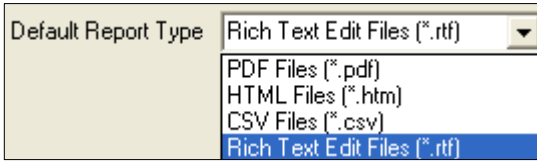

If you have already chosen RTF format in the **Preferences** dialog, the report will be saved as an RTF file.

AS9132A Verification Report

MARKING METHOD: DOT PEEN
ELEMENT SHAPE: ROUND

PARAMETER	REQUIREMENT PER ELEMENT	RESULTS	FAIL IF 2% OF ELEMENTS FAIL	PASS/FAIL
QUIET ZONE:	=> One element			PASS
CONTRAST:	> 20%	96 %		N/A
CELL FILL/SIZE:	60% < size < 105%	95 % avg.	0 % failed	PASS
DOT OVALITY/SHAPE:	< 20%	3 % avg.	0 % failed	PASS
DOT CENTER OFFSET/SPACING:	< 20%			PASS
ANGLE OF DISTORTION:	< +/- 7 Degrees			PASS
SYMBOL TYPE:	ECC200			PASS
MATRIX SIZE:	16x16			
PIXELS/ELEMENT:	10.2			
SYMBOL DATA:	123			

Firmware Version
Serial Number
This report was created on Saturday, February 04, 2006 at 21:40:11
Company: XYZ Corp.
Operator: J. Doe

Verification results and pass/fail grades.

Non-graded parameters and symbol data.

Note: Image captures are output simultaneously with the RTF. The format (JPG or BMP) is determined in the **Preferences** dialog.

Reference data: Verifier firmware version, Verifier serial number, report creation date, **ESP** version, company name, and operator name.

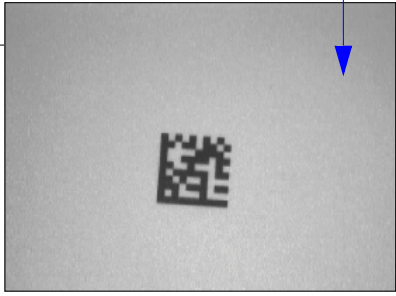

AIM DPM Verification

Reflectance Calibration

The Quadrus Verifier comes with a calibration symbol on a card like the one shown below. A maximum and minimum reflectance value will be printed at the bottom of the card. These are the values you will enter in the **Minimum** and **Maximum** spin boxes in the **Reflectance Calibration** dialog.

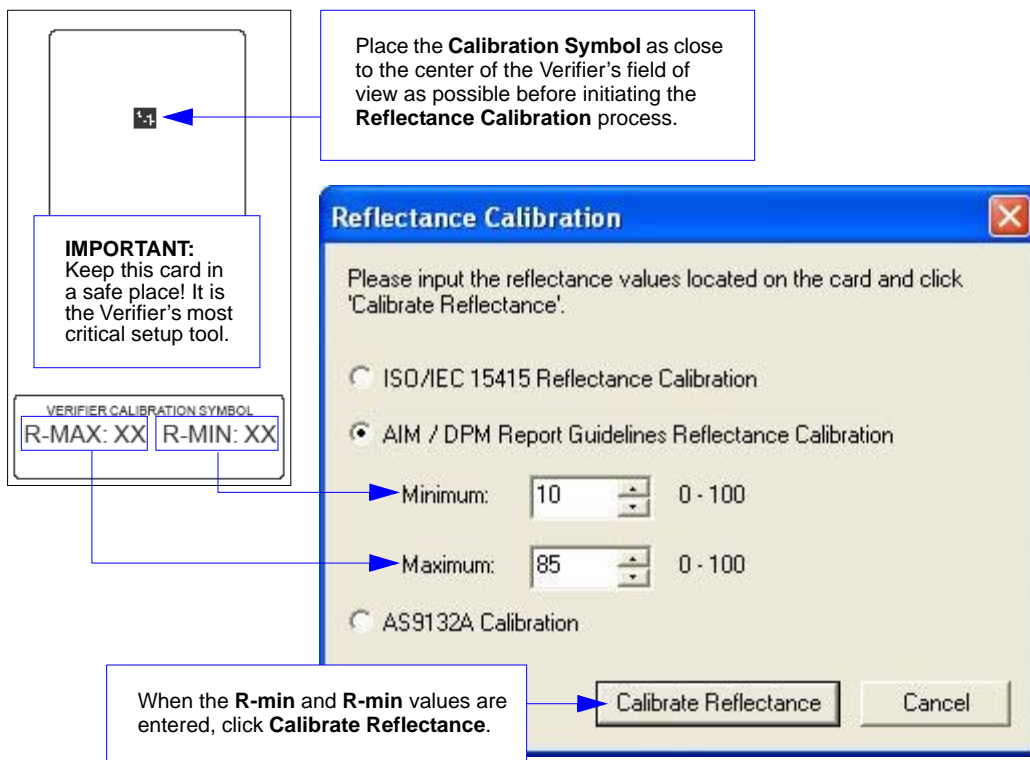

Once reflectance calibration is complete, **AIM DPM Verification** can be performed and a report generated.

AIM DPM Verification Report

The **AIM DPM** results show data concerning the reference decode algorithm, cell contrast, fixed pattern damage, axial and grid non-uniformity, cell modulation, unused error correction, minimum reflectance, print growth, symbol type, symbol size, element size, and pixels per element. All but the last five parameters are given a numeric and alphabetical grade.

```
DPM/4.0/15/660/45Q
```

AIM DPM Quality Guideline		
PARAMETER	RESULTS	GRADE
REFERENCE DECODE:	PASS	4 (A)
CELL CONTRAST:	85%	4 (A)
FIXED PATTERN DAMAGE:	----	4 (A)
AXIAL NON-UNIFORMITY:	0.00	4 (A)
GRID NON-UNIFORMITY:	0.01	4 (A)
CELL MODULATION:	----	4 (A)
UNUSED ECC:	100%	4 (A)
MINIMUM REFLECTANCE:	100%	4 (A)
FINAL GRADE:		4 (A)
NON-GRADED PARAMETERS:		
PRINT GROWTH:	-0.03	
SYMBOL TYPE:	ECC200	
SYMBOL SIZE:	10x10	
ELEMENT SIZE:	0.018"	
PIXELS/ELEMENT:	18.4	
SYMBOL DATA:	Y	

Save AIM DPM Verification Report

There are several possible ways to save your verification report, depending on what works best for your application.

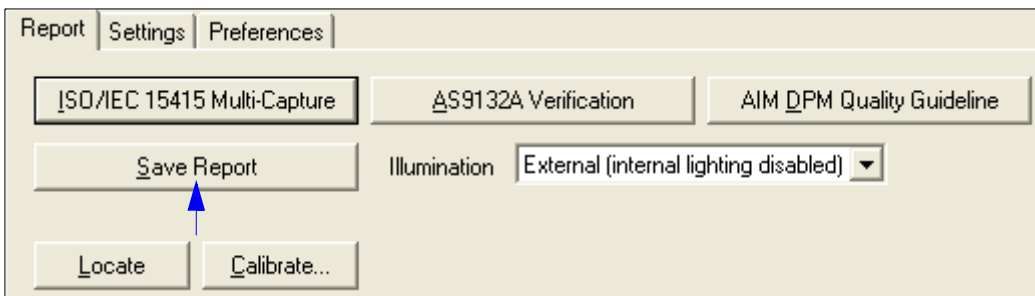

Save AIM DPM Verification Report as a PDF

If you have already chosen PDF in the **Preferences** dialog, the report will be saved as a PDF file.

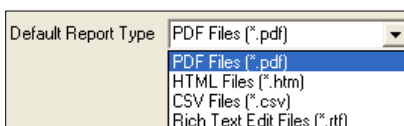

Verification results and grades.

Results	Grade
PASS	4 (A)
80%	4 (A)
----	4 (A)
0.07	3 (B)
0.22	4 (A)
----	4 (A)
100%	4 (A)
100%	4 (A)
	3 (B)

Symbol data.

Symbol Data: 123

Captured symbol image.

Data for non-graded parameters.

Reference data: Verifier firmware version, Verifier serial number, report creation date, ESP version, company name, and operator name.

Final Grade: 3 (B)
DPM/ 3.0/04/660/45Q

Non-Graded Parameters:
Print Growth: -0.06 Symbol Size: 16x16
Symbol Type: ECC200 Element Size:

Symbol Image: (scaled to 328x248)

Aperture: 0.004" Wavelength: 660 nm Lighting: 45Q

Firmware Version 35-676201-12
Verifier Serial Number 0420383
Wednesday, November 22, 2006 at 11:27:58
Microscan ESP Version 3.4.1.6
Company: AAA Acme Readers
Operator: Joe Operator
Any Label: Any Data

Note: See [Preferences Tab](#) for information about how to “autofit” PDF reports to a single page.

Save AIM DPM Verification Report as an HTML File

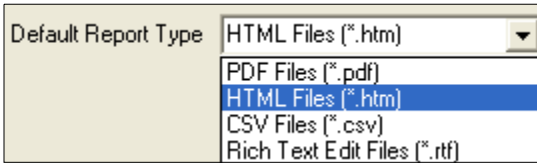

If you have already chosen HTML format in the **Preferences** dialog, the report will be saved as an HTML file.

MICROSCAN. AIM DPM Quality Guideline

Bar Code Scanners | 2D Imagers

Parameters:	Results	Grade
Reference Decode:	PASS	4 (A)
Cell Contrast:	80%	4 (A)
Fixed Pattern Damage:	----	4 (A)
Axial Non-Uniformity:	0.07	3 (B)
Grid Non-Uniformity:	0.22	4 (A)
Cell Modulation:	----	4 (A)
Unused ECC:	100%	4 (A)
Minimum Reflectance:	100%	4 (A)
Final Grade:		3 (B)

DPM/3.0/04/660/45Q

Non-Graded Parameters:

Print Growth:	-0.06	Symbol Size:	16x16
Symbol Type:	ECC200	Element Size:	8.5 Pixels 0.009*

Symbol Data: 123

Symbol Image: (scaled to 328x248)

Aperture: 0.004* Wavelength: 660 nm Lighting: 45Q

Firmware Version 35-676201-12
Verifier Serial Number 0420383
Wednesday, November 22, 2006 at 11:27:58
Microscan ESP Version 3.4.1.6
Company: AAA Acme Readers
Operator: Joe Operator
Any Label: Any Data

Verification results and grades.

Data for non-graded parameters.

Symbol data.

Reference data: Verifier firmware version, Verifier serial number, report creation date, **ESP** version, company name, and operator name.

Save AIM DPM Verification Report as a CSV File

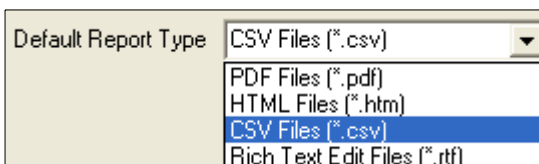

If you have already chosen CSV format in the **Preferences** dialog, the report will be saved as a CSV file.

CSV output is in a spreadsheet format, with all parameters listed in a horizontal orientation.

Columns A - I:

- Symbol Data
- Reference Decode Grade
- Cell Contrast
- Fixed Pattern Damage
- Axial Non-Uniformity

A screenshot of a spreadsheet application window. The spreadsheet has columns labeled A through I. The data in the spreadsheet is as follows:

	A	B	C	D	E	F	G	H	I
1	Sym_Data	Ref_Dec	Cell_Contr	Fixed_Pat_Dam	Axial_Nu				
2	123	PASS	4 (A)	71% 4 (A)	----		4 (A)		0 4 (A)

Columns J - P:

- Grid Non-Uniformity
- Cell Modulation
- Unused ECC
- Final Grade

A screenshot of a spreadsheet application window. The spreadsheet has columns labeled J through P. The data in the spreadsheet is as follows:

	J	K	L	M	N	O	P
1	Grid_NU	Cell_Mod	Unused_ECC	Final_Grade			
2	0.08	4 (A)	----	4 (A)	100% 4 (A)	4 (A)	

Columns Q - X:

- Print Growth
- Symbol Type
- Symbol Size
- Pixels Per Element
- Element Size
- Aperture
- Wavelength
- Lighting

A screenshot of a spreadsheet application window. The spreadsheet has columns labeled Q through X. The data in the spreadsheet is as follows:

	Q	R	S	T	U	V	W	X
1	Print_Growth	Sym_Type	Sym_Size	Pix_Element	Elmt_Size	Aperture	Wavelength	Lighting
2	-0.07	ECC200	16x16		10.8 0.010"	0x008"	660 nm	45Q

Columns Y - AG:

- Firmware Version
- Verifier Serial Number
- Date/Time
- ESP Version
- Company
- Operator

A screenshot of a spreadsheet application window. The spreadsheet has columns labeled Y through AG. The data in the spreadsheet is as follows:

	Y	Z	AA	AB	AC	AD	AE	AF	AG
1	Firmware_Vers	Verifier Ser_Num	Report_Created	Vers	Company	Operator	Copyright	User_Defined	
2		420383	2/26/2007 15:22		AAA Acme	Joe Operator		Any Label	Any Data

Save AIM DPM Verification Report as an RTF

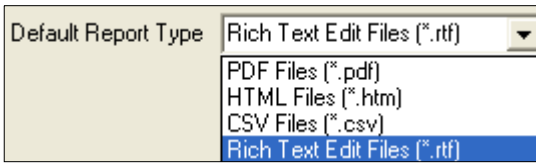

If you have already chosen RTF in the **Preferences** dialog, the report will be saved as an RTF file.

AIM DPM Quality Guideline

PARAMETER	RESULTS	GRADE
REFERENCE DECODE:	PASS	4 (A)
CELL CONTRAST:	71%	4 (A)
FIXED PATTERN DAMAGE:	----	4 (A)
AXIAL NON-UNIFORMITY:	0.00	4 (A)
GRID NON-UNIFORMITY:	0.08	4 (A)
CELL MODULATION:	----	4 (A)
UNUSED ECC:	100%	4 (A)
MINIMUM REFLECTANCE:	100%	4 (A)
FINAL GRADE:		4 (A)

Verification results and grades.

NON-GRADED PARAMETERS:

PRINT GROWTH:	-0.07
SYMBOL TYPE:	ECC200
SYMBOL SIZE:	16x16
ELEMENT SIZE:	0.010"
PIXELS/ELEMENT:	10.8

Non-graded parameters and symbol data.

SYMBOL DATA: 123

Note: Image captures are output simultaneously with the RTF. The format (JPG or BMP) is determined in the **Preferences** dialog.

Aperture: 0.008" Wavelength: 660 nm Lighting: 45Q
 Firmware Version
 Serial Number 0420383
 This report was created on Monday, February 26, 2007
 Company: AAA Acme Readers
 Operator: Joe Operator
 Any Label: Any Data

Reference data: Verifier firmware version, Verifier serial number, report creation date, **ESP** version, company name, and operator name.

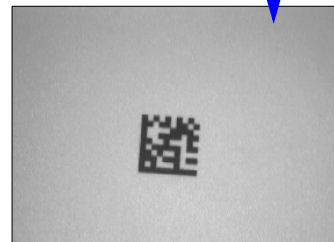

■ 4 *Unique Item Identifiers*

Contents

Overview of IUID and UII.....	4-2
Non-UII Characters	4-3
UII Mode Features.....	4-4
Error Messaging	4-6
Valid Data Qualifier Formats	4-8
UII Parsing.....	4-9

This section explains the structure and purpose of Item Unique Identification (IUID) and Unique Item Identifiers (UIIs), and how to configure the Quadrus Verifier to read UIIs.

Overview of IUID and UII

The Department of Defense (DoD) now requires “Item Unique Identification” (IUID) for all products sold to the DoD by private vendors. A Unique Item Identifier (UII) is like a Social Security number for each part. The UII must be encoded in a Data Matrix ECC 200 symbol that conforms to the data structure defined in the DoD’s [Guide for Uniquely Identifying Items](#).

UII Constructs

UIIs come in two forms, called **Construct 1** and **Construct 2**. The following is an example of Construct 2. Construct 1 is identical, except that it doesn’t include a part number. Construct 2 is composed of three basic elements:

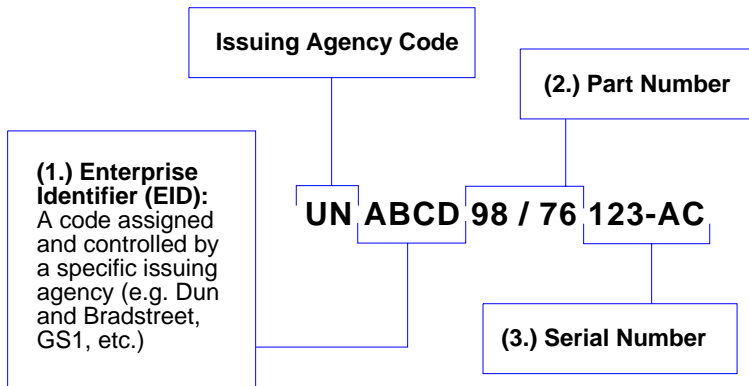

Encoding a UII

The information encoded in a UII mark includes a compliance indicator, data qualifiers, and data element separators. These elements are not part of the final concatenated UII. When **UII-Only** is enabled in the Quadrus Verifier, the characters that are not part of the final concatenated UII are removed from the decoded symbol data. Only characters that comprise the UII are passed on to the host. Otherwise, the symbol is rejected.

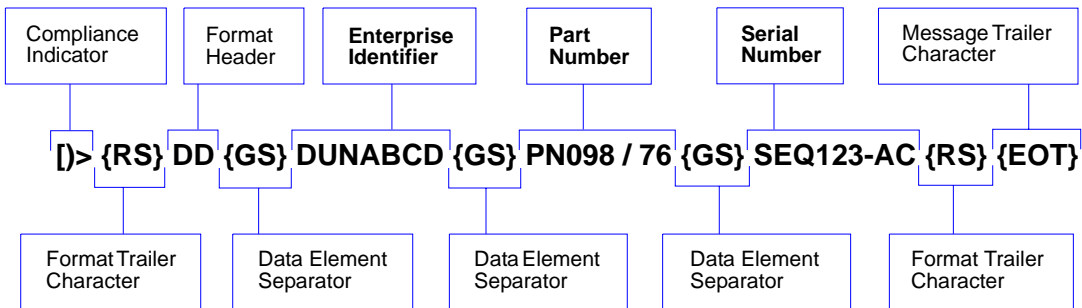

Non-UII Characters

The table below identifies and describes all characters in a UII data string that are not part of the final concatenated UII sent to the host.

Non-UII Characters in a Data String

<i>Compliance Indicator</i>	Identifies to the Verifier that the data string contains a UII.
<i>Format Header</i>	Describes the type of data qualifier used. These qualifiers include AI (format 05), DI (format 06), and TEI (format DD).
<i>Trailer Character</i>	An ASCII character that separates the compliance indicator from the format header information, and also appears at the end of the data string.
<i>Data Element Separator</i>	An ASCII character used to separate data fields.
<i>Message Trailer Character</i>	Identifies the end of the message within the data string.
<i>Data Qualifier</i>	Defines each data element placed in the UII data string.

When a data string in any of the three available formats is read by the Verifier, non-UII characters are removed and the UII is sent to the host.

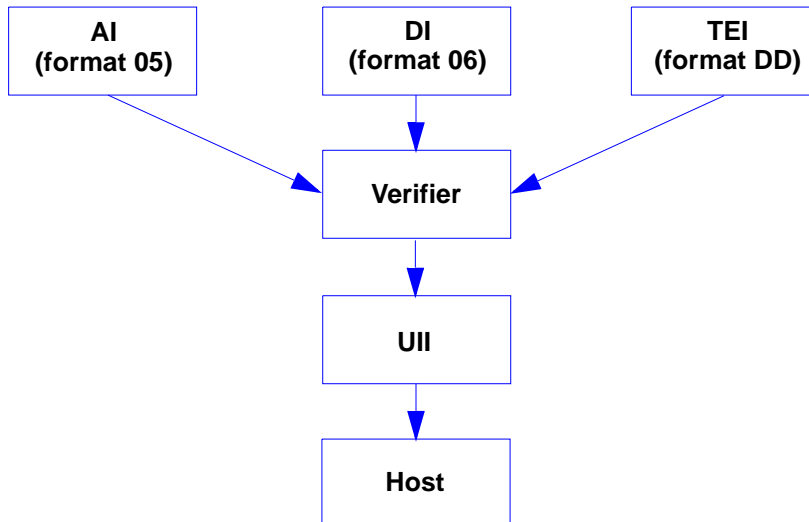

UII Mode Features

<i>UII-Only Enabled</i>	Allows the Quadrus Verifier to read <i>only</i> UII data strings encoded in ECC 200 Data Matrix symbols and to send the UII output to the host computer. The Verifier will not read any other symbol data when UII-Only is enabled.
<i>UII-Only Enabled with Error Messaging</i>	Allows the Quadrus Verifier to read <i>only</i> UII data strings encoded in ECC 200 Data Matrix symbols and to send the UII output to the host computer. In addition, the Verifier will send an error message to the host if the UII data string is invalid.
<i>UII Enabled with Pass Through</i>	Allows both UII-encoded symbols and non-UII symbols to be decoded and sent to the host.
<i>UII Enabled with Error Messaging and Pass Through</i>	Allows the Quadrus Verifier to decode UII symbols and non-UII symbols, and to provide error messages if the UII data string is invalid.

UII Mode by ESP

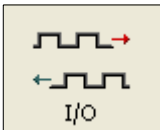

Click this button to bring up the **I/O Parameters** menu.

Open the nested **Unique Item Identifier** option in the **I/O Parameters** tree control.

To change settings, **double-click** the setting and use your cursor to scroll through the options.

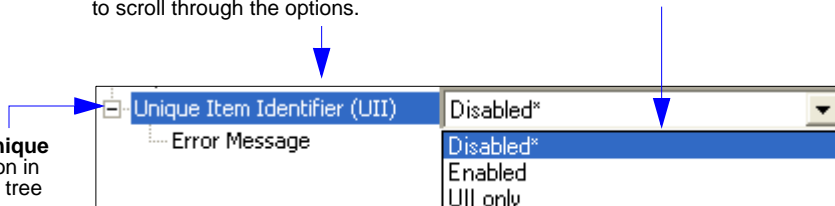

Note: The setting **Enabled** in ESP's UII tree controls is functionally identical to **UII Enabled with Pass Through** in the table at the top of this page. Therefore, the combination of **UII Enabled** and **Error Message Enabled** is functionally identical to the **UII Enabled with Error Messaging and Pass Through** condition in the table at the top of the page.

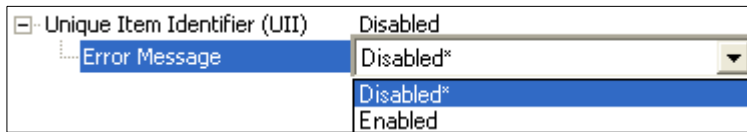

UII Mode by Serial Command

<i>Serial Cmd:</i>	< K455 , <i>status</i> , <i>errstatus</i> >
<i>Default:</i>	Disabled
<i>Options:</i>	0 = Disabled 1 = UII Enabled with Pass Through 2 = UII-Only Enabled

UII Disabled

No UII is constructed when symbol data is read.

UII Enabled with Pass Through

<i>Usage:</i>	Use when symbols may contain either non-UII data or UII data.
<i>Definition:</i>	Data strings with valid UII compliance indicators will be evaluated as UIIs. All other data will be processed in the normal manner.

UII-Only Enabled

<i>Usage:</i>	Use when symbols will contain only UII data, or when symbols with non-UII data are to be rejected.
<i>Definition:</i>	All data will be treated as potential UII data and symbols that do not comply with DoD UII guidelines will be rejected.

UII Mode Error Messaging







<i>Serial Cmd:</i>	< K455 , <i>status</i> , <i>errstatus</i> >
<i>Default:</i>	Disabled
<i>Options:</i>	0 = Disabled 1 = Enabled
<i>Usage:</i>	Identifies problems with data in UII format.
<i>Definition:</i>	Evaluates the UII elements and returns an error message if invalid UII elements are found.

Important: When **Error Messaging** is disabled, any symbol with data that does not conform to UII format will be treated as a No Read.







Error Messaging

This feature is used to determine if ULL data strings are in the correct format. When **Error Messaging** is enabled, the Quadrus Verifier sends a message to the host indicating an error every time a bad symbol is read. The table below shows examples of error messages.

Examples of Error Messages

<p><i>Invalid Format Header</i></p>	<p>[]>{RS}15{GS}800406141411A0B9C3D6{RS}{EOT} Error message: "Invalid ULL Format Header"</p>	
<p><i>Invalid AI</i></p>	<p>(01 + 21) >[]>{RS}05{GS}0100061414199999{GS}311A0B9C3D6{RS}{EOT} Error message: "Invalid AI"</p>	
<p><i>Invalid DI</i></p>	<p>(UN + 12V + 1P + S) >[]>{RS}06{GS}12X077991289{GS}1P4202435{GS}S10936{RS}{EOT} Error message: "Invalid DI"</p>	
<p><i>Invalid TEI</i></p>	<p>(D + CAG + SER) >[]>{RS}DD{GS}CAX987654{GS}SERMKLJHUIYD{RS}{EOT} Error message: "Invalid TEI"</p>	
<p><i>Space in Data Qualifier</i></p>	<p>[]>{RS}05{GS}8 0040614 1411 A0 B9 C3D6{RS}{EOT} Error message: "Invalid AI (or DI or TEI, depending on format in use)"</p>	
<p><i>Lower Case Characters</i></p>	<p>[]>{RS}05{GS}800406141411a0B9C3d6{RS}{EOT} Error message: "Invalid Characters in Data"</p>	



Examples of Error Messages (cont.)

<p><i>Invalid Characters</i></p>	<p>[>{RS}05{GS}800406141411#0B9C3D6{RS}{EOT} Error message: "Invalid Characters in Data"</p>	
<p><i>UII Too Long</i></p>	<p>(Character limit:78) [>{RS}05{GS}80021234567891123456789212345678931234567894123456789512345678961234567897123456789{RS}{EOT} Error message: "UII Too Long"</p>	
<p><i>Part Number Too Long</i></p>	<p>(Character limit: 32) [>{RS}DD{GS}DUNABCD{GS}PNO1234567891123456789212345678931234{GS}SEQ123-AC{RS}{EOT} Error message: "UII Part Number Too Long"</p>	
<p><i>Serial Number Too Long</i></p>	<p>(Character limit: 30) [>{RS}DD{GS}DUN-ABCD{GS}PNO09876{GS}SEQ1234567891123456789212345678931{RS}{EOT} Error message: "UII Serial Number Too Long"</p>	
<p><i>EID Too Long</i></p>	<p>(Character limit: 13) [>{RS}DD{GS}DUN12345678911234211{GS}PNO98/76{GS}SEQ123-AC{RS}{EOT} Error message: "UII EID Too Long"</p>	
<p><i>Invalid Compliance Indicator</i></p>	<p>D>{RS}05{GS}800406141411A0B9C3D6{RS}{EOT} Error message: "Invalid UII Compliance Indicator" The following symbol <i>will read</i> in UII with Pass Through mode, because the invalid compliance indicator suggests that the encoded characters form a non-UII data string.</p>	

Valid Data Qualifier Formats

The table below shows examples of correctly applied data qualifiers and the decoded UII output.

Examples of Valid Data Qualifiers and Concatenated UIIs

<p><i>Application Identifier AI (Format 05)</i></p>	<p>Encoded data string: []>{RS}05{GS}0100061414199999{GS}211A0B9C3D6{RS}{EOT}</p> <p>Concatenated UII: 000614141999991A0B9C3D6</p>	
<p><i>Data Identifier DI (Format 06)</i></p>	<p>Encoded data string: []>{RS}06{GS}18SOCVA5674A36458{RS}{EOT}</p> <p>Concatenated UII: DOCVA5674A36458</p>	
<p><i>Text Element Identifier TEI (Format DD)</i></p>	<p>Encoded data string: []>{RS}DD{GS}CAG987654{GS}SERMKJHUIYD{RS}{EOT}</p> <p>Concatenated UII: D987654MKLJHUIYD</p>	

UII Parsing

When **UII Parsing** is enabled and a UII mark is verified, the verification report shows the concatenated UII as well as the elements of the raw decoded symbol data.

If the symbol does not contain a valid UII, an **error message** will appear.

To enable UII Parsing, click the **Enable UII Parsing** box at the bottom of the **Preferences** view.

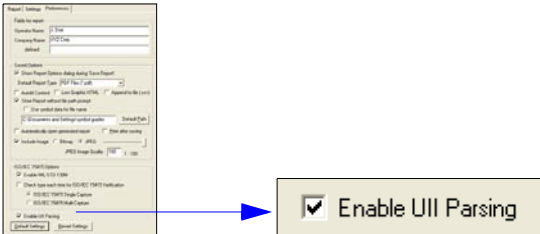

UII Elements

The raw data string, concatenated UII, and the parsed UII elements are shown at the bottom half of the verification report.

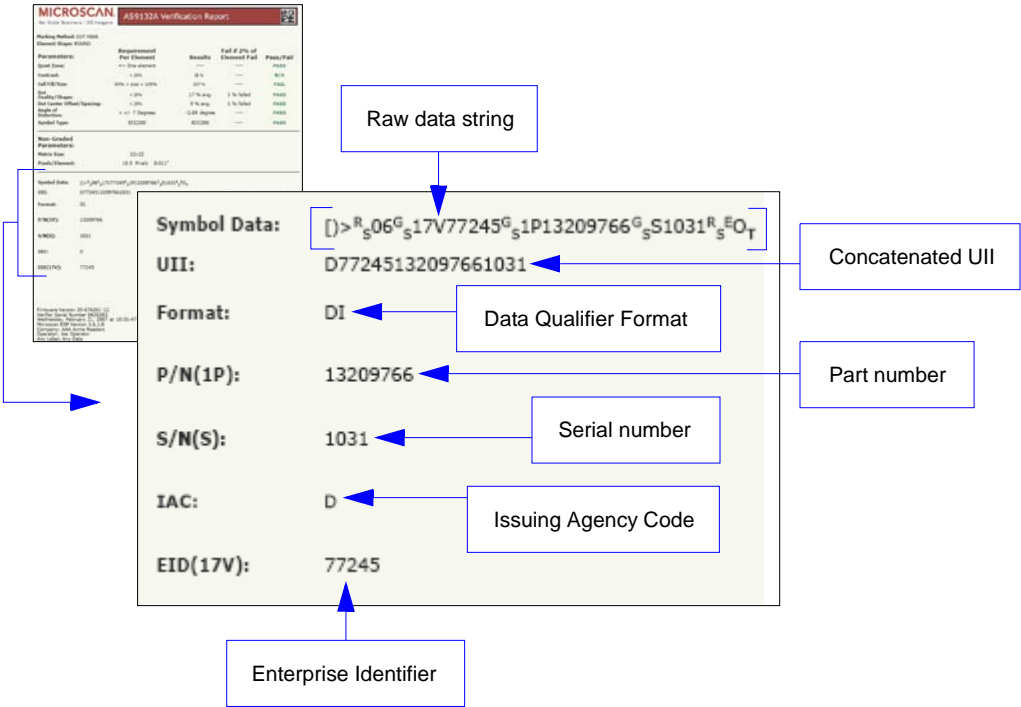

Reader Setup

The Quadrus Verifier is equipped with a full feature set that enables it to be used as a reader in a wide variety of applications. The following sections describe how to set up and operate the Quadrus Verifier as a reader.

5 *Communications*

Contents

Communications by ESP	5-2
Communications Serial Commands.....	5-3
RS-232/422 Host Port.....	5-4
RS-232 Auxiliary Port.....	5-9
Network.....	5-18
Preamble.....	5-21
Postamble.....	5-22
Response Timeout.....	5-23
LRC Status.....	5-24
Aux Port System Data Status	5-25

This section tells how to set up communications parameters with the host and an auxiliary terminal.

With Microscan's **ESP**, configuration changes can be made in the **ESP** menus, then sent and saved to your reader. You can also send serial commands to the reader via **ESP's Terminal** window.

Communications by ESP



Click this button to enter **Application Mode**.



Click this button to bring up the **Communications** tree control.

To **open** the entire contents of the tree control, hold down the **Alt** key and **single-click** the **+**.
To **close** the entire contents of the tree control, hold down the **Alt** key and **single-click** the **-**.

To open nested options, **single-click** the **+**.

To change a setting, **double-click** the setting and use your cursor to scroll through the options.

Parameters	
[-] Communications	
[-] RS232/422 Host Port	
[-] Host Port Connections	
Baud Rate	115.2K
Parity	None
Stop Bits	One
Data Bits	Eight
Host Protocol	Point-to-Point
Host 422 Status	Disabled
[-] RS232 Auxilliary Port	
[-] Aux Port Connections	
Baud Rate	115.2K
Parity	None
Stop Bits	One
Data Bits	Eight
[+] Aux Port Settings	
[+] Network	
[-] Preamble	Disabled
Preamble Characters	CR
[-] Postamble	Enabled
Postamble Characters	CR LF
Response Timeout	2
LRC Status	Disabled
Aux Port System Data Status	Disabled*
	Disabled*
	Enabled

Communications Serial Commands

Host Port Connections	< K100 , baud rate, parity, stop bits, data bits>
Host Port Protocol	< K140 , protocol>
Host 232/422 Status	< K102 , host 422>
Auxiliary Port	< K101 , aux port mode, baud rate, parity, stop bits, data bits, daisy chain ID status, daisy chain ID>
Daisy Chain Autoconfigure.	< K150 DAISY>
Daisy Chain ID	< K151 , daisy chain reader #, daisy chain reader ID>
Ethernet Configuration	< K125 , IP address, subnet address, gateway address, IP address mode, primary TCP port, video TCP port>
Preamble	< K141 , status, preamble characters>
Postamble	< K142 , status, postamble characters>
Response Timeout	< K143 , response timeout>
LRC	< K145 , status>
Aux Port System Data Status	< K146 , aux port system data>

RS-232/422 Host Port

The host port can be configured with RS-232 and RS-422 connections.

Host Port Connections

These settings define the basic transmission speeds and digital standards that ensure common formatting.

Baud Rate, Host Port

Usage: Can be used to transfer data faster or to match host port settings.

Definition: The rate at which the reader and host transfer data back and forth.

Serial Cmd: <**K100,baud rate,parity,stop bits,data bits**>

Default: **115.2K**

Options:

0 = 600	1 = 1200	2 = 2400
3 = 4800	4 = 9600	5 = 19.2K
6 = 38.4K	7 = 57.6K	8 = 115.2K

Parity, Host Port

Definition: An error detection routine in which one data bit in each character is set to 1 or 0 so that the total number of 1 bits in the data field is even or odd.

Serial Cmd: <**K100,baud rate,parity,stop bits,data bits**>

Default: **None**

Options: **0 = None** 1 = Even 2 = Odd

Stop Bits, Host Port

Definition: One or two bits added to the end of each character to indicate the end of the character.

Serial Cmd: <**K100,baud rate,parity,stop bits,data bits**>

Default: **One**

Options: **0 = One** 1 = Two

Data Bits, Host Port

Definition: One or two bits added to the end of each character to indicate the end of the character.

Serial Cmd: <**K100,baud rate,parity,stop bits,data bits**>

Default: **8**

Options: 0 = Seven **1 = Eight**

Host Port Protocol

Usage: In general, the point-to-point protocols will work well in most applications. They require no address and must use RS-232 or RS-422 communications standards.

Definition: Protocols define the sequence and format in which information is transferred between the reader and the host, or in the case of **Multidrop**, between multiple readers and a concentrator.

Serial Cmd: **<K140,protocol>**

Default: **Point-to-Point**

Options: **0 = Point-to-Point**

1 = Point-to-Point with RTS/CTS

2 = Point-to-Point with XON/XOFF

3 = Point-to-Point with RTS/CTS and XON/XOFF

4 = Polling Mode D

6 = User Defined

Point-to-Point (Standard)

Usage: Used only with RS-232 or RS-422.

Definition: Standard **Point-to-Point** requires no address and sends data to the host whenever it is available, without a request or handshake from the host.

Serial Cmd: **<K140,0>**

Point-to-Point with XON/XOFF

Usage: If an XOFF has been received from the host, data will not be sent to the host until the host sends an XON. During the XOFF phase, the host is free to carry on other chores and accept data from other devices.
Used only with RS-232.

Definition: This option enables the host to send the XON and XOFF command as a single byte transmission command of start (^Q) or stop (^S).

Serial Cmd: **<K140,1>**

Point-to-Point with RTS/CTS

Usage: A reader initiates a data transfer with an RTS (request-to-send) transmission. The host, when ready, responds with a CTS (clear-to-send) and the data is transmitted. CTS and RTS signals are transmitted over two dedicated wires as defined in the RS-232 standard.

Used only with RS-232.

Definition: **Point-to-Point with RTS/CTS** (request-to-send/clear-to-send) is a simple hardware handshaking protocol that allows a reader to initiate data transfers to the host.

Serial Cmd: <K140,2>

Point-to-Point with RTS/CTS and XON/XOFF

Usage: Used only with RS-232.

Definition: This option is a combination of **Point-to-Point with RTS/CTS** and **Point-to-Point with XON/XOFF**.

Serial Cmd: <K140,3>

Polling Mode D

Usage: When in **Polling Mode D**, an address of 1 is automatically displayed on the configuration menu. However, during transmission, a 1C hex poll address (FS) and a 1D hex select address (GS) are substituted for the 1.

Definition: Like **Point-to-Point**, **Polling Mode D** requires a dedicated connection to the host; but unlike **Point-to-Point**, it requires an address and must wait for a poll from the host before sending data.

Serial Cmd: <K140,4>

User-Defined Point-to-Point

Usage: Useful for developing custom protocols in polled or unpolled mode.

Definition: Allows the user to customize the point-to-point protocol.

Serial Cmd: <K140,6,RES,address,REQ,EOT,STX,ETX,ACK,NAK,from host>

User-Defined Address

Definition: **User Defined** is considered to be in a polled mode only if an address has been assigned.

Serial Cmd: <K140,6RES,address,REQ,EOT,STX,ETX,ACK,NAK,from host>

Default: No address

Options: Any ASCII character except **NULL**, **<**, **,** or **>**.

User-Defined Example

Definition: Example: ACK/NAK protocol can be configured using **User Defined**. The reader will transmit data to the host, when an **ACK** is received, it will carry on with its business. If a **NAK** or response timeout occurs, the reader will re-send the data to the host up to 3 more times before aborting.

Tip: To use **User Defined Point-to-Point**, first select **Point-to-Point <K140,0>** and then **User Defined <K140,6>**.

Example: To select an unpolled ACK/NAK **User Defined** protocol with LRC disabled, send **<K140,0><K140,6,,,,,,,^F,^U><K145,0>**. ACK and NAK will be displayed in the menu.

Serial Cmd: **<K140,6,RES,address,REQ,EOT,STX,ETX,ACK,NAK,from host>**

Default: **No assignment**

Options: Any ASCII character except **NULL**. Control characters can be used to define RES through NAK in serial commands.

From Host

Definition: This option allows the handshaking protocol to be initiated from the host, if not configured in an unpolled mode. Messages sent to the host will include the reader's defined protocol. The status of **From Host** determines if messages sent from the host to the reader must include the defined protocol. If **From Host** is disabled, the defined protocol is not included. If **From Host** is enabled, the defined protocol must be included.

Serial Cmd: **<K140,6,RES,address,REQ,EOT,STX,ETX,ACK,NAK,from host>**

Default: **Disabled**

Options: **0 = Disabled** 1 = Enabled

Multidrop

Usage: A concentrator can be used to connect up to 50 devices to a single host port connection.

Definition: **Multidrop** allows up to 50 devices to be connected to a single RS-485 host, with the reader assigned an unique address (from 01 to 50).

Multidrop Addresses: Each address has its own separate poll and select address (from 1C to 7F hex).

Options: 01 through 50

Serial Cmd: If selecting **Multidrop** (K140,5) an address must be defined and appended to the command string.

Format: **<K140,5,address>**

When **Multidrop** is selected, the protocol characters for RES, REQ, etc. are assigned automatically.

User-Defined Multidrop

Usage: This option is used when connecting to a concentrator or other device that does not match standard multidrop protocol.

If selecting **User Defined Multidrop** (7), complete the format by either choosing new parameters or place commas where unchanged data fields occur.

Definition: **User Defined Multidrop** allows the user to customize the polling protocol.

Serial Cmd: **<K140,7,RES,address,REQ,EOT,STX,ETX,ACK,NAK>**

For **User Defined Multidrop**, first select **Multidrop <K140,5>**, then **User Defined Multidrop <K140,7...>**.

Address: Any single character (**02** to **7E** in hex) in the ASCII table can be assigned as the address character. The character chosen is used as the poll character and the subsequent ASCII character becomes the select character. For example, if a **^B (02)** is selected as the address, **^C (03)** becomes the select address that the host will use in sending host select commands.

Note: Any ASCII character except **NULL (00)** and a **^A (01)** can be assigned as an address. Control characters can be used to define RES through NAK in serial commands.

Note: Definitions of commands in **User Defined** and **User Defined Multidrop** must be duplicated in host applications to enable poll and select sequences to execute correctly during transmission.

Note: Typically, parameters in **User Defined Multidrop** are defined by first enabling **Multidrop**, then enabling **User Defined Multidrop**. This pre-loads multidrop characters into the parameters. Then changes are made to individual characters to match the host or other requirements.

Host 422 Status

Usage: RS-232 is an industry standard. RS-422 is used where greater cable lengths are required and/or where noise interference is an issue.

Definition: Host 422 if enabled allows communication through the 422 I/O lines. When Host 422 is enabled, RS-232 is disabled. When Host 422 is disabled, RS-232 is enabled.

Serial Cmd: **<K102,host 422>**

Default: **Disabled**

Options: **0 = Disabled** 1 = Enabled

RS-232 Auxiliary Port

The auxiliary port offers an alternative port that can be configured to communicate in RS-232 in several modes including Daisy Chain.

Auxiliary Port Connections

As with the host port parameters, the auxiliary port settings (baud rate, parity, stop bits, and data bits) must be identical with those of the auxiliary device.

Note: Aux port connections are not available when Ethernet is enabled.

Usage: An auxiliary port connects the reader to a remote display or to other readers that can display or transfer data.

Definition: These commands set the communication parameters with the auxiliary port which can be used to configure menus, send data to the host, display data transmissions originating from the host, and relay data from other readers set in tandem (daisy chained).

Baud Rate, Aux Port

Usage: Can be used to transfer data faster or match an auxiliary device.

Definition: The rate at which the reader and host transfer data back and forth.

Serial Cmd: <**K101**,aux port mode,**baud rate**,parity,stop bits,data bits,daisy chain ID status,daisy chain ID>

Default: **115.2K**

<i>Options:</i>	0 = 600	1 = 1200	2 = 2400
	3 = 4800	4 = 9600	5 = 19.2K
	6 = 38.4K	7 = 57.6K	8 = 115.2K

Parity, Aux Port

Usage: Only changed if necessary to match host setting.

Definition: An error detection routine in which one data bit in each character is set to 1 or 0 so that the total number of 1 bits in the data field is even or odd.

Serial Cmd: <**K101**,aux port mode,baud rate,**parity**,stop bits,data bits,daisy chain ID status,daisy chain ID>

Default: **None**

<i>Options:</i>	0 = None	1 = Even	2 = Odd
-----------------	-----------------	----------	---------

Stop Bits, Aux Port

Usage: Only changed if necessary to match host setting.

Definition: Allows the user to select the last one or two bits in each character to indicate the end of the character.

Serial Cmd: <**K101**,aux port mode,baud rate,parity,**stop bits**,data bits,daisy chain ID status,daisy chain ID>

Default: **One**

Options: **0 = One** 1 = Two

Data Bits, Aux Port

Usage: Only changed if necessary to match host setting.

Definition: Number of bits in each character.

Serial Cmd: <**K101**,aux port mode,baud rate,parity,stop bits,**data bits**,daisy chain ID status,daisy chain ID>

Default: **Eight**

Options: 0 = Seven **1 = Eight**

Auxiliary Port Mode

Definition: Determines the flow of data between the auxiliary port device(s), the reader, and the host.

Serial Cmd: <**K101**,aux port mode,baud rate,parity,stop bits,data bits,daisy chain ID status,daisy chain ID>

Default: **Disabled**

Options: **0 = Disabled** 1 = Transparent 2 = Half duplex
3 = Full duplex 4 = Daisy chain 5 = Command Processing

Note: RS-232 host and aux port are available with full functionality.

Transparent (Auxiliary Port Mode)

Usage: A common application, in conjunction with handheld readers, is one that employs an auxiliary readout to detect mis-applied symbols.

Definition: In **Transparent** mode data is passed between the auxiliary port and the host. The reader buffers data from the auxiliary port and echoes the keyed data on the auxiliary port.

- Auxiliary port data is passed through to the host whenever a return key is pressed at the auxiliary port or whenever symbol data is sent. If sent with symbol data, it is processed on a first-in/first-out basis.
- Auxiliary port data to the host is always sent with a preamble and a postamble.
- If the reader is in a polled mode to the host, auxiliary port data will still pass through.
- **<D>** is the only command accepted by the reader from the auxiliary port. All other commands will pass through to the host.

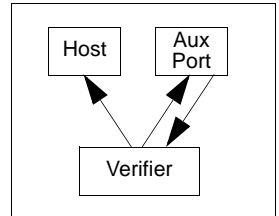

Data initiated from the Verifier

- Transmission to the auxiliary port occurs immediately upon a good read.
- Data sent to the auxiliary port does not include a preamble or a postamble.
- Communications with the auxiliary port is always in Point-to-Point protocol, even if the host is in a polled protocol mode.

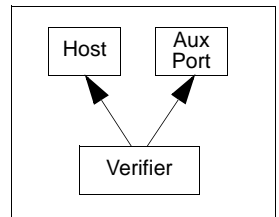

Data initiated from the Host

- All host data is echoed to the auxiliary port in unpolled mode.

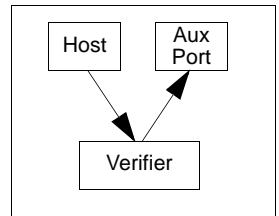

Serial Cmd: **<K101,aux port mode,baud rate,parity,stop bits,data bits,daisy chain ID status,daisy chain ID>**

1 = Transparent

Half Duplex (Auxiliary Port Mode)

Usage: Useful when the user wants symbol data displayed on an auxiliary menu close to the reader.

Definition: In **Half Duplex** mode all auxiliary port data and symbol data is sent directly to the host. Symbol data is displayed on the auxiliary port menu at the same time the data is sent to the host.

Data initiated from the Auxiliary Port

- Auxiliary port data to the host is ignored if the reader is in a polled mode.
- Auxiliary port data or read data is sent to the host whenever it is received.
- Auxiliary port data is not echoed.
- Auxiliary port data to the host is always sent without a preamble or a postamble.
- **<D>** is the only command that is accepted by the reader from the auxiliary port. All other commands are passed through to the host.

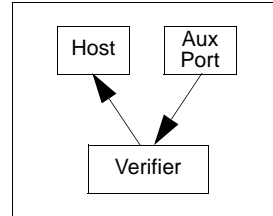

Data initiated from the Verifier

- Data is transmitted to the auxiliary port at the same time it is transmitted to the host.
- Data transmission conforms with all parameters specified in the configuration menu (e.g., **Preamble**, **Postamble**, **End of Read Cycle**).

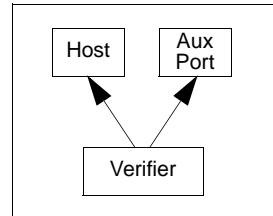

Data initiated from the Host

- All host data is echoed to the auxiliary port in unpolled mode.

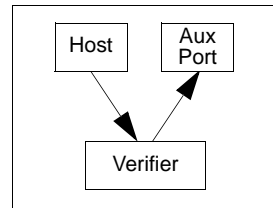

Serial Cmd: **<K101,aux port mode,baud rate,parity,stop bits,data bits>**
2 = Half Duplex

Full Duplex (Auxiliary Port Mode)

Usage: When communication to and from the auxiliary port is required.

Definition: In **Full Duplex** mode all auxiliary port data and symbol data is sent directly to the host. Symbol data is not displayed on the auxiliary port menu.

Data initiated from the Auxiliary Port

- Auxiliary port data to the host is ignored if the reader is in a polled mode.
- Auxiliary port data or read data is sent to the host whenever it is received.
- Auxiliary port data is not echoed.
- Auxiliary port data to the host is always sent without a preamble or a postamble.
- **<D>** is the only command that is accepted by the reader from the auxiliary port. All other commands are passed through to the host.

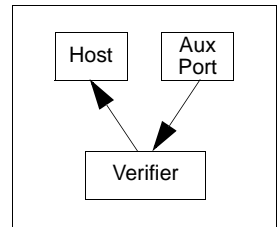

Data initiated from the Verifier

- Data is not sent to the auxiliary port.

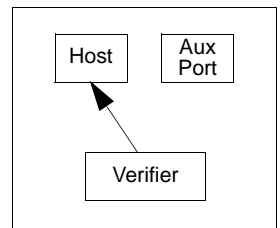

Data initiated from the Host

- All host data is echoed to the auxiliary port in unpolled mode.

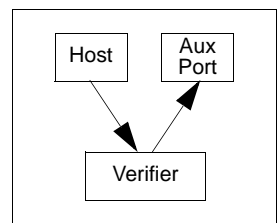

Serial Cmd: **<K101,aux port mode,baud rate,parity,stop bits,data bits,daisy chain ID status,daisy chain ID>**

3 = Full duplex

Daisy Chain (Auxiliary Port Mode)

Usage: Useful in applications where:

- More than one symbol type is present.
- A symbol may be present on multiple sides of a package.
- Symbols are presented at different depths.

Definition: In a daisy chain application, readers are connected in tandem or “daisy chain” and decoded data is relayed from one reader to another on up to the host.

A master reader has its host port linked to the host computer and its auxiliary port linked to the host port of the first secondary reader in the chain. Thereafter, each secondary reader’s auxiliary port is linked to the host port of the secondary reader that is further from the host in the daisy chain.

Each reader in the daisy chain can be assigned an ID that accompanies any data that it sends.

Serial Cmd: *<K101,aux port mode,baud rate,parity,stop bits,data bits,daisy chain ID status,daisy chain ID>*

Options: **4 = Daisy chain**

Function: Before the master reader times out, it checks its auxiliary port for data. It should be set to wait at least **30 mS** for each secondary reader in the daisy chain. If no data is received within the read cycle timeout, the master sends a No Read message to the host. Otherwise the complete data is sent.

If for example the master reader is set to timeout in 120 mS, the first secondary reader downstream might be set to 90 mS, the next to 30 mS, and so on, thus assuring that at least 30 ms elapses between transmissions.^a

Daisy-chained readers can send a series of symbols by enabling **Multisymbol** and a common multisymbol separator. If the master reader does not receive the expected number of symbols, No Read messages are appended to the data string to make up the difference between the number of symbols enabled in **Multisymbol** and the number of symbols read.

For example, a master and two secondary readers have **Number of Symbols** set to 3 and **Multisymbol Separator** defined as %. If the master and the first secondary reader do not find symbols, but the next secondary reader registers a good read, the transmitted results would be:

symbol data % No Read % No Read

a. The above example is based on the best case. Other factors such as baud rate, dynamic focus timing, number of characters in a given symbol, and the number of secondary readers in the daisy chain can affect timing and may need to be included in your calculations for complete accuracy.

Command Processing Mode (Auxiliary Port Mode)

- Usage:** Allows user to send configuration from the Host port or the auxiliary port.
- Definition:** When enabled, **Command Processing** allows commands to be entered via the aux port and direct externally triggered read cycle data in one of two ways:
1. Bar code data, including the serial trigger if used, will be transmitted to the last port from which a command was sent.
 2. If the last command came from the host port, then externally triggered read cycle data will only be output to the host port.
- Serial Cmd:** <**K101,aux port mode,baud rate,parity,stop bits,data bits,daisy chain ID status,daisy chain ID**>
- Options:** **5 = Command Processing**

Daisy Chain ID Status

- Usage:** Used in a daisy chain setup in cases where the host needs to know which reader in a daisy chain setup sent the data.
- Definition:** Each reader in a daisy chain can be assigned a one or two character ID that will appear in front of decoded data and identify its source.
- Serial Cmd:** <**K101,aux port mode,baud rate,parity,stop bits,data bits,daisy chain ID status,daisy chain ID**>
- Default:** **Disabled**
- Options:** **0 = Disabled** 1 = Enabled

Note: Enable/disable and length must be the same in all readers.

Daisy Chain ID

- Usage:** Used in a daisy chain setup in cases where the host needs to know which reader sent the data.
- Definition:** A one or two character prefix which identifies the particular daisy chain reader from which the data is being sent.
- Serial Cmd:** <**K101,aux port mode,baud rate,parity,stop bits,data bits,daisy chain ID status,daisy chain ID**>
- Default:** **1/**
- Options:** Any one or two ASCII characters.

Daisy Chain Autoconfigure

Usage: For quick setup and configuration of the daisy chain network.

Definition: **Daisy Chain Autoconfigure** is issued to the master reader in the daisy chain and the software responds as follows:

- Counts the number of secondary readers in the daisy chain.
- Assigns an internal ID number (1...n) to each secondary reader, where the first secondary reader is number **1** (and its own ID being a **0**).
- Propagates the communications settings and the relevant operating modes of the master reader to the host and auxiliary ports of each secondary reader.
- Resets each secondary reader.
- Ensures that each secondary reader has acquired the new settings.

Serial Cmd: **<K150DAISY>**

Note: All secondary readers must be set to **Serial** for **Daisy Chain** to function.

When setting up a daisy chain operation, perform the following steps:

1. Set the master reader (the reader connected to the host) to **Serial**.

This sets all the readers in the daisy chain to **Serial** when the command is carried out.

Before **Autoconfigure** you must set the master reader to **Serial (S)**:

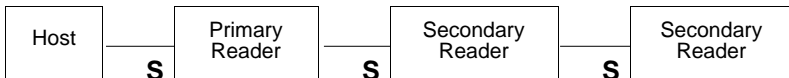

2. Send **<K150DAISY>** command.
3. If necessary, set the master reader to **Edge**.

After **Autoconfigure** you may set the master reader to **Edge (E)** but the other readers must remain in **Serial (S)**:

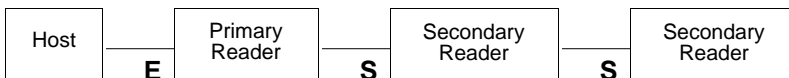

Daisy Chain Remote Secondary Reader ID

Usage: This command provides a handy way to assign custom daisy chain IDs to specific readers that were assigned during the daisy chain autoconfigure process.

Definition: Assigns a new daisy chain ID to a daisy chain secondary reader. The command is sent to the master reader to configure the other secondary readers.

Daisy Chain Reader Number

Definition: Specifies the target reader (by sequential number) which will be receiving the new Daisy Chain ID. The master reader is always 0 (zero). All secondary readers are numbered 1...n in the order that they are connected.

Note: These numbers are for assigning IDs only and are not changeable.

Serial Cmd: <**K151,daisy chain reader #,daisy chain reader ID**>

Options: 1....n (0 for the master)

Daisy Chain Reader ID

Definition: A two-character user-defined ASCII message identifying a reader in the daisy chain.

Serial Cmd: <**K151,daisy chain reader #,daisy chain reader ID**>

Default: Sequential numbering of reader units resulting from the Daisy Chain Autoconfigure <**K150**> command; for example: ID Master = **1/**; ID reader 1 = **2/**; ID reader 2 = **3/**; etc.

Options: Any two characters except **NULL**, <, or >.

Note: After a secondary reader accepts a new ID, it automatically invokes a reset-with-save command.

Network

These port options are mutually exclusive and predetermined according to the FIS type associated with the unit. For example, if you have an **Ethernet** enabled unit, you will not be able to use **USB** or **RS-485 Multidrop** commands.

Network connections are made through the Ethernet/USB connector, but setup is done through RS-232 connections.

Ethernet

See Chapter 16, [Ethernet](#), for a more detailed discussion of Ethernet connections.

IP Address

Definition: The 32-bit address defined by the Internet Protocol in RFC 791 (version 4). The Internet Protocol is the network layer for the TCP/IP Protocol Suite. It is a connectionless, best-effort packet switching protocol.

Usage: Use this to configure the reader with an IP address compatible with the host network. Note that this only takes effect when **IP Address** mode is configured for **Static** mode.

Serial Cmd: *<K125, IP address, subnet address, gateway address, IP address mode, primary TCP port, video TCP port>*

Default: **192.168.0.100**

Options: 0.0.0.0 to 255.255.255.255

Subnet

Definition: The subnet portion of an IP address. In a subnetted network, the IP address is split into a subnet portion and a host portion using an address (subnet) mask. A bit mask is used to identify which bits in an IP address correspond to the network and subnet portions of the address.

Usage: Use this to configure a subnet mask that is compatible with the host network and the reader's IP address.

Serial Cmd: *<K125, IP address, subnet address, gateway address, IP address mode, primary TCP port, video TCP port>*

Default: **255.255.255.0**

Options: 0.0.0.0 to 255.255.255.255

Gateway Address

- Definition: AA gateway is a communications device/program which passes data between networks having similar functions but dissimilar implementations. This should not be confused with a protocol converter.
- Usage: This parameter is currently unused by the reader.
- Serial Cmd: <**K125**, *IP address,subnet address,gateway address,IP address mode,primary TCP port,video TCP port*>
- Default: **0.0.0.0**
- Options: 0.0.0.0 to 255.255.255.255

IP Address Mode

- Definition: Configures the method the reader will use to acquire its IP address.
- Usage: If host network has a DHCP server, then DHCP mode can be used to assign the reader an IP address from a central location. Typically, the DHCP server can be configured with the reader's MACID so a known IP can be assigned. If the host network does not have a DHCP server, then the reader must be programmed with a "Static" IP address.
- Serial Cmd: <**K125**, *IP address,subnet address,gateway address,IP address mode,primary TCP port,video TCP port*>
- Default: **Static**
- Options: **0 = Static** (The reader uses IP address configured via K command, **ESP**, or embedded menu.)
1 = DHCP (The reader acquires an IP address from a DHCP/BOOTP)

Primary TCP Port

- Definition: TCP port in which the reader receives commands and sends symbol data.
- Usage: The port number is configured for the convenience/preference of the host system.
- Note:** The primary TCP port and the video TCP must be different.
- Serial Cmd: <**K125**, *IP address,subnet address,gateway address,IP address mode,primary TCP port,video TCP port*>
- Default: **2001**
- Options: 1024 to 65535

Video TCP Port

Definition: TCP port in which the reader sends responses to **ESP**-related commands (video, symbol information, histogram) from the Primary TCP port. Note that if the Video TCP port is unconnected, the reader will respond to the Primary TCP port instead.

Note: The primary TCP port and the video TCP must be different.

Usage: The port number is configured for the convenience/preference of the host system.

Serial Cmd: <**K125**, *IP address, subnet address, gateway address, IP address mode, primary TCP port, **video TCP port***>

Default: **2002**

Options: 1024 to 65535

Preamble

Preamble Status

- Usage:* Useful for identifying and controlling incoming data. For example, defining the preamble as a carriage return and a line feed causes each decoded message to be displayed on its own line.
- Definition:* Define a one-to-four character data string that can be added to the front of the decoded data.
- Serial Cmd:* **<K141,status,preamble character(s)>**
- Default:* **Disabled**
- Options:* **0 = Disabled** 1 = Enabled (within any protocol)

Preamble Character(s)

- Serial Cmd:* **<K141,status,preamble character(s)>**
- Default:* **^M** corresponding to: **carriage return/NULL/NULL/NULL.**
- Options:* **Within a Serial Command**
- To enter control characters within a serial command, hold down the control key while typing the desired character.
- Example:* **<K141,1,CNTL-m>** to enter **^M**
- Within an Embedded Menu**
- Control characters entered on the command line are displayed in the menu as mnemonic characters, such as: **<CR><NULL><NULL><NULL>**.
- To enter a control character from within an embedded menu, first type in a space (with the space key). This has the effect of allowing the control key to be recognized as a part of the control character. Next hold down the control key while typing the desired character.
- Example:* **Space CNTL-m** to enter **^M**

Postamble

Postamble Status

Usage: Useful for identifying and controlling incoming data. For example, defining the postamble as a carriage return and a line feed causes each decoded message to be displayed of on its own line.

Definition: Allows the user to enable or disable up to four postamble character(s) that can be added to the end of the decoded data.

Serial Cmd: <K142,status,postamble character(s)>

Default: **Enabled**

Options: 0 = Disabled **1 = Enabled** (within any protocol)

Postamble Character(s)

Serial Cmd: <K142,status,postamble character(s)>

Default: **^M^J**. Corresponds to **carriage return/line feed/NULL/NULL**, as displayed in the menu.

Options: Up to four user-defined ASCII character, including control characters.

Within a Serial Command

To enter control characters within a serial command, hold down the control key while typing the desired character.

Example: <K142,1,CNTL-m CNTL-j> to enter **^M^J**

Within an Embedded Menu

Control characters entered on the command line are displayed in the menu as mnemonic characters, such as: <CR><LF><NULL><NULL>

To enter a control character from within an embedded menu, first type in a space (with the space key). This has the effect of allowing the control key to be recognized as a part of the control character. Next hold down the control key while typing the desired character.

Example: **Space CNTL-m Space CNTL-j** to enter **^M^J**

Response Timeout

- Usage:* Only used when a response is required from the host. While in **Multidrop**, if the reader does not receive an **ACK** or **NAK** from the host after sending polled data, it will act on a fault. The reader can be set to wait indefinitely by setting **Response Timeout** to zero.
- Definition:* Time the reader will wait before timing out if **ACK**, **NAK**, and **ETX** are enabled, and a host response is expected.
- Serial Cmd:* **<K143,response timeout>**
- Default:* **2** (in 10mS increments = 20mS)
- Options:* 0 to 255 (A zero (0) setting causes an indefinite wait.)

LRC Status

(Longitudinal Redundancy Check)

Usage: Used when extra data integrity is required.

Definition: An error-checking routine that verifies the accuracy of transmissions. It is the exclusive OR of all characters following the **STX** (start of text) up to and including the **ETX** (end of text). What this means is that the binary representation of all the characters in a transmissions are cumulatively added in a column and each resulting odd integer is assigned a 1 and each even integer a 0 (two 1s = 0, two 0s = 0, a 1 and a 0 = 1). The extra **LRC** character is then appended to the transmission and the receiver (usually the host) performs the same addition and compares the results.

Serial Cmd: **<K145,status>**

Default: **Disabled**

Options: **0 = Disabled** 1 = Enabled

Aux Port System Data Status

Definition: When enabled, directs data from the reader to the auxiliary port.

Serial Cmd: <**K146,aux port system data**>

Default: **Disabled**

Options: **0 = Disabled** 1 = Enabled



6 Read Cycle

Contents

- Read Cycle by ESP 6-2
- Read Cycle Serial Commands 6-3
- Read Cycle Setup..... 6-4
- Multisymbol..... 6-5
- Trigger 6-7
- Serial Trigger 6-13
- End of Read Cycle..... 6-15
- Active Camera 6-17
- Capture Mode..... 6-18
- Capture Timing..... 6-23
- Dual Camera Switching..... 6-25
- Store No Read Image..... 6-30
- Setting Up the Verifier for EZ Trax 6-31

After you've established communications and completed basic read rate testing, you will need to address the spatial and timing parameters associated with your application.

Read Cycle by ESP

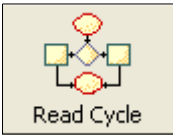

Click this button to bring up the **Read Cycle** menu.

To **open** the entire contents of the tree control, hold down the **Alt** key and **single-click** the **+**.
To **close** the entire contents of the tree control, hold down the **Alt** key and **single-click** the **-**.

To open nested options, **single-click** the **+**.

To change a setting, **double-click** the setting and use your cursor to scroll through the options.

Parameters	
<input type="checkbox"/> Read Cycle	
<input type="checkbox"/> Multisymbol	
<input type="checkbox"/> Trigger	
Mode	External Edge
Trigger Filter Duration	313
External Trigger State	Active Closed
<input type="checkbox"/> Serial Trigger	
<input type="checkbox"/> End of Read Cycle	
Mode	Timeout
Read Cycle Timeout	100
Active Camera	Internal Camera
<input type="checkbox"/> Capture Mode	Rapid Capture
Number of Captures	1
Rapid Capture Mode	Timed Capture
<input type="checkbox"/> Capture Time	
<input type="checkbox"/> Dual Camera Switching	
<input type="checkbox"/> Store Noread Image	
Image Storage Type	Disabled
Image Storage Mode	First Image*
	First Image*
	Last Image

Read Cycle Serial Commands

Multisymbol	< K222 ,number of symbols,multisymbol separator>
Trigger Mode/Duration	< K200 ,trigger mode,trigger filter duration>
External Trigger State	< K202 ,external trigger state>
Serial Trigger Character	< K201 ,serial trigger character>
Start Trigger Character	< K229 ,start character>
Stop Trigger Character	< K230 ,stop character>
End of Read Cycle	< K220 ,end of read cycle,read cycle timeout>
Active Camera	< K240 ,active camera>
Captures	< K241 ,capture mode,number of captures,rapid capture mode>
Capture Timing	< K242 ,time before 1st capture,time between capture 1 and 2,,,,,,time between capture 7 and 8>
Dual Camera Operations	< K243 ,switching mode,number of internal camera captures,number of external camera captures,internal camera timeout,external camera timeout>
Store No Read Image	< K244 ,image storage type,image storage mode>

Read Cycle Setup

Based on your application, setting up read cycle and triggering parameters will involve a series of decisions, as follows:

1. Select the number of symbols to be read in a read cycle (must not exceed **Number Of Captures**).
2. Decide the trigger type to be used: if serial, the serial character; if external, **Level** or **Edge**.
3. Designate how the read cycle should end (**Timeout, New Trigger, Last Frame**).
4. Calculate the maximum and minimum field of view (FOV).
5. Consider the speed of the transport in inches per second.
6. Select **Capture** mode, **Continuous** or **Rapid**.
7. Select **Number Of Captures**.
8. Set the **Time Before First Capture** and **Time Between Captures**, if any.
9. If using an external camera, select the active camera(s).
10. Decide if you need to alternate between cameras, with **Switching Mode**.
11. Save settings to the **IP Database**.

Note: Images can be captured at a rate of 60/second.

Note: If you need to set up your Quadrus Verifier for use with **EZ Trax** software, see [Setting Up the Verifier for EZ Trax](#).

Multisymbol

- Usage:** **Multisymbol** is commonly used in shipping applications where a shipping symbol contains individual symbols for part number, quantity, etc. This feature allows one trigger to pick up all the symbols.
- Definition:** **Multisymbol** allows the user to define up to 6 symbols that can be read in a single read cycle.
- Conditions:** The following conditions apply:
1. Each symbol must be different to be read.
 2. The maximum number of characters in a read cycle is 32,520 for all symbols.
 3. The maximum number of characters the reader can transmit is calculated by: Preamble + maximum number of symbols * (aux id + symbology id + maximum symbol length + ((number of insertion cells x cell length)+ separator) + postamble + LRC = 37,425.
 4. All No Read messages are posted at the end of the data string.
 5. If more than one symbol is within the field of view at the same time, symbol data may not be displayed in the order of appearance.
 6. If **Matchcode Type** is set to **Sequential** or if **Trigger** is set to **Continuous Read 1 Output**, **Number of Symbols** will default to **1** (if set to any number greater than 1).

Number of Symbols

- Definition:** **Number of Symbols** is the number of different symbols that can be read in a single read cycle.
- Serial Cmd:** <**K222**, *number of symbols*, multisymbol separator>
- Default:** **1**
- Options:** 1 to 6

Multisymbol Separator

Usage: Used to delimit or separate data fields with a user defined character.

Definition: Any valid ASCII character, inserted between each symbol read when **Multisymbol** is set to any number greater than 1.

Serial Cmd: <K222,number of symbols,multisymbol separator>

Note: If **Multisymbol Separator** has been changed to any other character than the default comma and you wish to re-define the separator as a comma, use **ESP** or the embedded menus.

Default: , (comma)

Options: Any available ASCII character, except < or > (if used as delimiters).

Note: If a **NULL** is entered for the multisymbol separator, the multisymbol separator output will be disabled.

Note: If No Read messages are disabled and there are No Reads occurring, separators will only be inserted between symbol data outputs.

Trigger

Definition: The type of trigger event that will initiate the read cycle.

Note: When performing calibration or read rate testing, the current trigger setting will be disregarded.

Trigger Mode

Serial Cmd: <**K200**, *trigger mode*, *trigger filter duration*>

Default: **External Edge**

Options:

0 = Continuous Read	1 = Continuous Read 1 Output
2 = External Level	3 = External Edge
4 = Serial Data	5 = Serial Data and External Edge

Continuous Read

Usage: **Continuous Read** is useful in testing symbol readability or reader functions. It is not recommended for normal operations.

Definition: In **Continuous Read**, trigger input options are disabled, the reader is always in the read cycle, and it will attempt to decode and transmit every capture.

When To Output and **No Read** options have no effect on **Continuous Read**.

Serial Cmd: <**K200**, **0**>

Continuous Read 1 Output

Usage: **Continuous Read 1 Output** can be useful in applications where it is not feasible to use a trigger and all succeeding symbols contain different information. It is also effective in applications where the objects are presented by hand.

Definition: In **Continuous Read 1 Output** the reader self-triggers whenever it decodes a new symbol or a timeout occurs.

If **End Of Read Cycle** is set to **Timeout** and the symbol doesn't change, the output is repeated at the end of each timeout period. For example, if **Timeout** is set to one second, the reader sends the symbol data immediately and repeats the output at intervals of one second for as long as the symbol continues to be captured.

If **End Of Read Cycle** is set to **New Trigger**, the reader will send the current symbol data immediately, but send it only once. A new symbol appearing in the reader's range will be read and sent immediately provided it is not identical to the previous symbol read.

Serial Cmd: **<K200,1>**

Caution: In automated environments, **Continuous Read 1 Output** is not recommended because there is no one to verify that a symbol was missed.

Note: If **Trigger Mode** is set to **Continuous Read 1 Output**, **Number of Symbols** will default to 1 (if set to any number greater than 1).

External Level

Usage: This mode is effective in an application where the speeds of the conveying apparatus are variable and the time the reader spends reading each object is not predictable. It also allows the user to determine if a No Read has occurred.

Definition: **External Trigger Level** allows the read cycle (active state) to begin when a trigger (change of state) from an external sensing device is received. The read cycle endures until the object moves out of the sensor range and the active trigger state changes again.

Serial Cmd: <K200,2>

Important: **Level** and **Edge** apply to the active logic state (Active Off (I_{OFF}) or Active On (I_{ON})) that exists while the object is in a read cycle, between the rising edge and falling edge. *Rising edge* is the trigger signal associated with the appearance of an object. *Falling edge* is the trigger signal associated with the subsequent disappearance of the object.

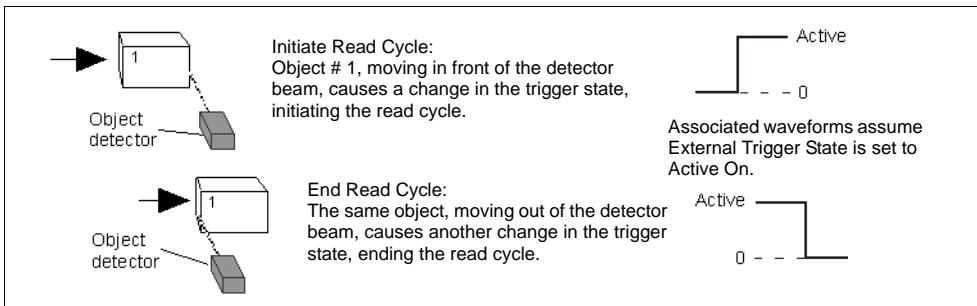

Trigger Level

External Edge

Usage: This mode is highly recommended in any application where conveying speed is constant or if spacing, object size, or timeouts are consistent.

Definition: **External Trigger Edge**, as with Level, allows the read cycle (active state) to begin when a trigger (change of state) from an external sensing device is received. However, the passing of an object out of sensor range does not end the read cycle. The read cycle ends with a good read output or, depending on **End of Read Cycle** setting, a timeout or new trigger occurs.

Serial Cmd: <K200,3>

Important: Level and Edge apply to the active logic state (**Active Off** (I_{OFF}) or **Active On** (I_{ON})) that exists while the object is in a read cycle, between the rising edge and falling edge. *Rising edge* is the trigger signal associated with the appearance of an object. *Falling edge* is the trigger signal associated with the subsequent disappearance of the object.

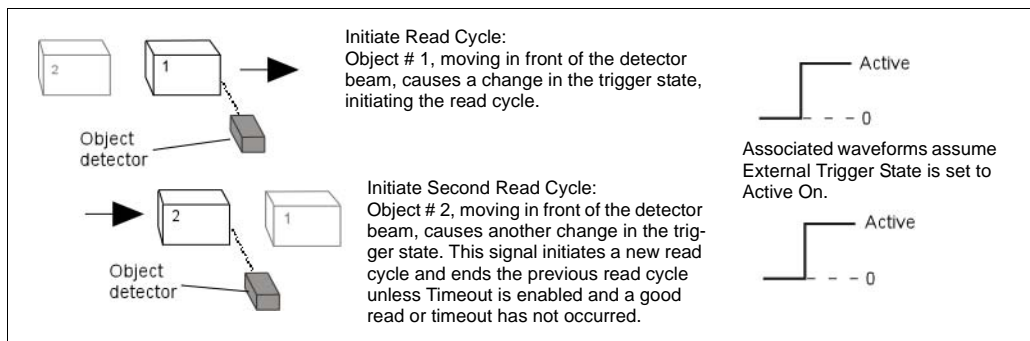

Trigger Edge

Serial Data

Usage: **Serial Data** is effective in a highly controlled environment where the host knows precisely when the object is in the field of view. It is also useful in determining if a No Read has occurred.

Definition: In **Serial Data**, the reader accepts an ASCII character from the host or controlling device as a trigger to start a read cycle. A **Serial Data** trigger behaves the same as an **External Edge** trigger.

Serial commands are entered inside corner brackets, such as <>.

Serial Cmd: <K200,4>

Note: In **Serial Data**, sending a non-delimited start serial character will start a read cycle; however a non-delimited stop serial character has no effect.

Serial Data or External Edge

Usage: **Serial Data or External Edge** is seldom used but can be useful in an application that primarily uses an external sensing device but occasionally needs to be manually triggered.

An auxiliary terminal can be connected to the aux port so the user can send the serial trigger character through the reader to the host.

Definition: In this mode the reader accepts either a serial ASCII character or an external trigger pulse to start the read cycle.

Serial Cmd: <K200,5>

Note: In **Serial Data or External Edge**, sending a non-delimited start serial character will start a read cycle; however a non-delimited stop serial character has no effect.

Trigger Filter Duration

Usage: **Trigger Filter Duration** can be used to help the unit trigger more consistently with an unstable external trigger.

Definition: **Trigger Filter Duration** can prevent trigger bounce from falsely triggering the reader by limiting the time during which trigger pulses can be received.

Serial Cmd: <K200,trigger mode,trigger filter duration>

Default: **313** (x 32 μ s = 10.24mS)

Options: 0 to 65535 (corresponding to 0 to 2.097seconds in 32 μ s steps)

If the unit is in **External Edge** trigger mode, then **Trigger Filter Duration** specifies the time following an edge that the reader will not consider another edge as a valid trigger.

If the unit is in **External Level** mode, then **Trigger Filter Duration** specifies the time following the active edge that the trigger must be sampled once again as active before considering it a valid level trigger.

External Trigger State

Usage: Allows users to select the trigger state that will operate with their systems. (If using an object detector, use **Active Off**.)

Definition: When enabled for **Active On (I_{ON})** the triggering device imposes a current on the optoisolator to activate the read cycle. When enabled for **Active Off (I_{OFF})** the triggering device interrupts the current to the optoisolator to activate the read cycle.

Serial Cmd: <K202,external trigger state>

Default: **Active On**

Options: 0 = Active Off **1 = Active On**

Note: **External Level**, **External Edge**, or **Serial Data or Edge** triggering mode must be enabled for **External Trigger** to take effect.

Serial Trigger

Usage: Allows the user to define the trigger character and delimiters that start and stop the read cycle.

Definition: A serial trigger is considered an online host command and requires the same command format as all host commands: that is, to be entered within angle brackets delimiters < and > or in the case of non-delimited triggers, define individual start and stop characters.

Serial Trigger Character (Delimited)

Usage: Allows the user to define the trigger character that initiates the read cycle.

Definition: A single ASCII host serial trigger character that initiates the read cycle. A delimited trigger character is one that either starts or ends the read cycle and is enclosed by delimiters such as < and >.

Serial Cmd: <**K201, serial trigger character**>

Default: **Spacebar** (corresponds to <**SP**> displayed in the embedded menu)

Options: Any single ASCII character, including control characters, except **NULL (00)**, an existing host command character, or an on-line protocol character. Control characters entered on the command line are displayed in the menu as mnemonic characters.

Note: **Serial Data** or **Serial Data or Edge** triggering mode must be enabled for **Serial Trigger Character** to take effect.

Start and Stop Trigger Characters (Non-Delimited)

Usage: It is useful in applications where different characters are required to start and end a read cycle.

Definition: A non-delimited trigger character is one that either starts or ends the read cycle and is NOT enclosed by delimiters such as < and >.

Both **Start** and **Stop** non-delimited characters can be defined and will function according to the trigger event, as follows:

When defining **Start** and **Stop** trigger characters, the following rules apply:

- In **External Edge** the reader looks only for the start trigger character and ignores any end trigger character that may be defined.
- In **External Level**, the start trigger character begins the read cycle and end trigger character ends it. Note that even after a symbol has been decoded and the symbol data transmitted, the reader remains in **External Level** trigger read cycle until a **Stop** character is received.
- In **Serial Data and Edge** trigger mode, command, either a start trigger character or a hardware trigger can start an edge trigger read cycle.

Start Character (Non-Delimited)

Definition: A single ASCII host serial trigger character that starts the read cycle and is not enclosed by delimiters such as < and >.

Serial Cmd: <**K229**, *start character*>

Default: **NULL (00)** (disabled)

Options: Two hex digits representing an ASCII character except <, >, **XON**, and **XOFF**.

Stop Character (Non-Delimited)

Usage: It is useful in applications where different characters are required to start and end a read cycle.

Definition: A single ASCII host serial trigger character that ends the read cycle and is not enclosed by delimiters such as < and >.

Serial Cmd: <**K230**, *stop character*>

Default: **NULL (00)** (disabled)

Options: Two hex digits representing an ASCII character except <, >, **XON**, and **XOFF**.

End of Read Cycle

Definition: The read cycle is the time during which the reader will attempt to capture and decode a symbol. A read cycle can be ended by a timeout, a new trigger, or by the last frame in a capture sequence or a combination of the above.

End of Read Cycle Mode

Note: When operating in **Continuous Read** or **Continuous Read 1 Output**, the reader is always in the read cycle.

Serial Cmd: <**K220**,*end of read cycle*,read cycle timeout>

Default: **Last Frame**

Options: 0 = Timeout 1 = New Trigger
2 = Timeout or New Trigger **3 = Last Frame**
4 = Last Frame or New Trigger

Timeout

Usage: Typically used with **Serial Data** or **Edge Trigger** and **Continuous One Output**.

Effective in highly controlled applications when the maximum length of time between objects can be predicted. It assures that a read cycle ends before the next bar-coded object appears, giving the system extra time to decode and transmit the data to the host.

Definition: **Timeout** ends the read cycle, causing the reader to stop reading symbols and send the symbol data or No Read message when the time set in **Timeout** elapses (times out), if **When to Output** is set to **End of Read Cycle**.

If in **Continuous Read 1 Output**, a timeout initiates a new read cycle and allows the same symbol to be read again.

With either **External Edge**, **Serial Data**, or **Serial Data and Edge** enabled, a timeout ends the read cycle and symbol data or a No Read message is sent to the host.

With **External Level** enabled, the read cycle does not end until the falling edge trigger or a timeout occurs. The next read cycle does not begin until the next rising edge trigger.

New Trigger

Usage: **New Trigger** is an effective way to end a read cycle when objects move past the reader at irregular intervals (not timing dependent).

Definition: New Trigger ends the current read cycle and initiates a new one when a new trigger occurs. New Trigger refers only to a “rising edge” trigger.

With either **External Edge**, **Serial**, or **Serial or Edge** enabled, an edge or serial trigger ends a read cycle and initiates the next read cycle.

In the case of **External Level**, a falling edge trigger ends the read cycle but the next read cycle does not begin until the occurrence of the next rising edge trigger.

Timeout or New Trigger

Usage: Useful in applications that require an alternative way to end the read cycle. For example, if an assembly line should stop completely or the intervals between objects are highly irregular.

Definition: **Timeout or New Trigger** is identical to **Timeout** except that a timeout or a new trigger (whichever occurs first) ends the read cycle.

Last Frame

Usage: Useful in applications in which the number of captures needed can be defined but the timeout duration varies.

Definition: **Last Frame** only applies to **Rapid Capture** mode.

Last Frame or New Trigger

Usage: Useful in applications in which line speeds are irregular and a new labeled object could appear before the last frame in a **Rapid Capture** sequence.

Definition: **New Trigger or Last Frame** is identical to **New Trigger** except that a new trigger or last frame (whichever occurs first) ends the read cycle.

Read Cycle Timeout

Definition: **Read Cycle Timeout** is the duration of the read cycle.

Serial Cmd: **<K220, end of read cycle, read cycle timeout>**

Default: **100** (x 10mS)

Options: 0 to 65535

Active Camera

Usage: **External** and **Dual** options are useful where in applications where the reader cannot be located near the symbol or where both the internal and external cameras are required for products such as circuit boards that might have two symbols in different locations.

Definition: The Quadrus Verifier has its own internal camera complete with illumination and led sensor circuitry for capturing static or moving symbols at various camera settings including shutter, contrast, etc.

The Quadrus Verifier can also accept images from a remote (external) camera using the RS-170 communications protocol.

Serial Cmd: **<K240,active camera>**

Default: **Internal**

Options: **0 = Internal Camera**

1 = External Camera

2 = Dual Camera

Important: The Quadrus Verifier does not control the timing of external cameras. Captures from external cameras are streamed into the Quadrus Verifier. To be sure to receive a complete first capture, allow an extra 33mS delay before the first external capture.

Capture Mode

Definition: **Capture Mode** relates to the way that multiple captures are processed by the Quadrus Verifier.

Serial Cmd: **<K241,capture mode,number of captures,rapid capture mode>**

Default: **Rapid Capture**

Options: **0 = Rapid Capture** 1 = Continuous Capture

Number of Captures

Usage: Used to increase the opportunities for good reads and to “extend” the field of view in dynamic applications.

Definition: Sets the total number of captures that are processed during a read cycle in the **Rapid Capture** mode when **Switching Mode** is set to **Number of Captures**.

Serial Cmd: **<K241,capture mode,number of captures,rapid capture mode>**

Default: **1**

Options: 0 to 5

Note: When processing in **Rapid Capture** mode and **Dual Capture** mode, the number of captures set for each camera will be limited by the number of captures set here. For example, if **Number Of Captures** is set to 4, and the individual camera captures are set for 2 and 3 respectively, the last capture will be omitted.

Rapid Capture Mode

Usage: **Rapid Capture** is useful in fast moving applications in which symbols are only in the field of view a short time or precise timing between captures is relevant or when dual camera mode is enabled. A single capture with **Last Frame** ending the read cycle is the same as “single shot”.

Definition: In **Rapid Capture**, decoding occurs independent of and simultaneous with capturing, thus allowing precise timing or no delay at all between captures. The downside is that the number of captures is limited to 8 so that processing buffers are not overloaded.

Serial Cmd: **<K241,capture mode,number of captures,rapid capture mode>**

Default: **Timed Capture**

Options: **0 = Timed Capture** 1 = Triggered Capture

Timed Capture

Usage: **Timed Rapid Capture** is useful in fast moving applications in which symbols are only in the field of view a short time and precise timing is required.

Definition: In **Timed Rapid Capture**, decoding occurs independent of and simultaneous with capturing, thus allowing precise timing (Diagram B) or no delay (Diagram A) at all between captures.

Also, consecutive captures are regarded as the same symbol if the output data is the same.

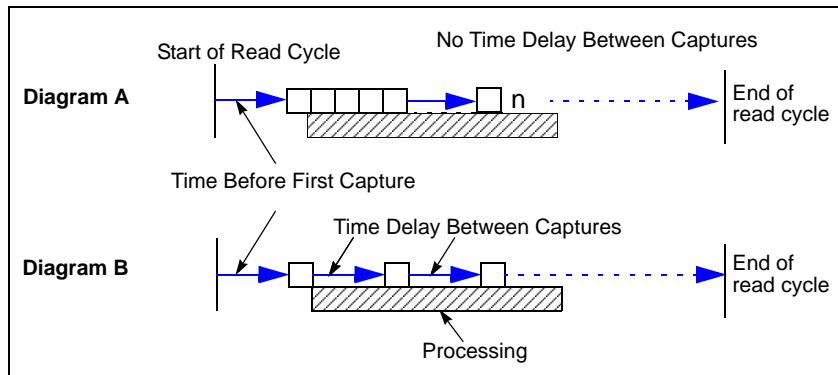

Rapid Capture Mode, Single Camera

Calculating Number of Captures in a Rapid Capture Application

1. First calculate the distance between multiple captures.

For multiple captures in **Rapid Capture** mode, you can calculate the distance between successive symbols by multiplying the line speed by the capture time.

TRAVEL DISTANCE = Line Speed X 15mS

Note: For **Dual Camera** operations, add 33mS to the overhead time for the first external capture.

Example:

A symbol moving at 10 ips (inches per second) past a CCD reader travels $0.010"/mS * 15mS = 0.15$ inches between captures.

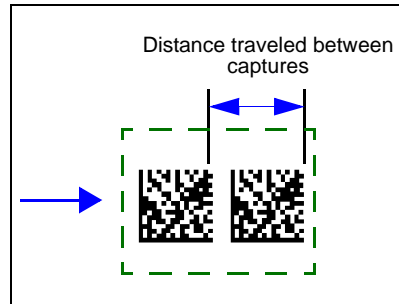

2. Next calculate number of captures.

Once the travel time is known, you can easily calculate the number of captures you can expect to occur inside a FOV by subtracting the symbol size from the FOV and dividing the result by the travel time.

NUMBER OF CAPTURES = (FOV-Symbol Size)/Travel Distance

Following up on the example from Step 1:

$$0.78" - 0.4"/0.15" = 2.5 \text{ captures}$$

If a required number of captures has been determined, you can also work the formula backwards and determine the minimum FOV by:

FOV = (Number Of Captures * Travel Time) + Symbol Size

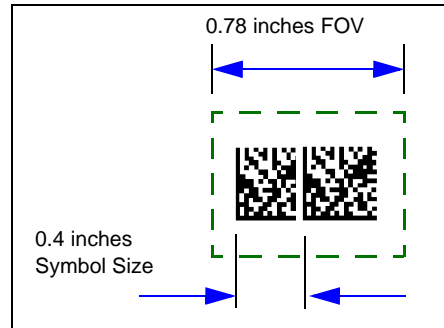

Triggered Capture

Usage: Useful in applications where delays between captures can be controlled by triggers rather than preset time delays.

Definition: When enabled the reader will stay in the read cycle until either the user-defined number of captures has been met or, if configured, a timeout occurs.

Notes on Triggered Capture Mode

1. **Trigger Mode <K200>** must be set to **Edge**, **Serial**, or **Serial and Edge**. If set to **Level**, **Triggered Capture Mode** will operate the same as **Timed Rapid Capture** mode.
2. For **End of Read Cycle** settings **<K220>**:
 - a) If set to **Timeout** or **New Trigger and Timeout** and a timeout occurs before number of capture have been met, it will abort the read cycle and disregard the remaining number of triggers.
 - b) If set to **New Trigger**, the reader remains in the read cycle until the number of captures is satisfied and an additional trigger is received indicating both the end of the read cycle and the start and first capture of the next read cycle.

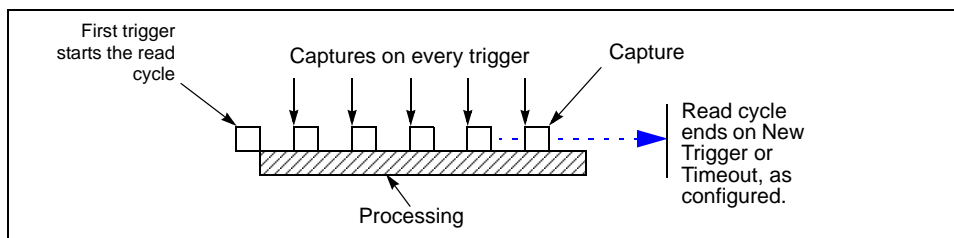

Triggered Captures, Typical

Continuous Capture

Usage: **Continuous Capture** is useful in applications with slower line speeds or where symbol spacing may be random or not time-dependent.

Definition: In **Continuous Capture** a capture is followed sequentially by processing, as shown below. Since processing is completed before another capture can occur (this usually takes about 30mS), a large number of captures can take place throughout a read cycle.

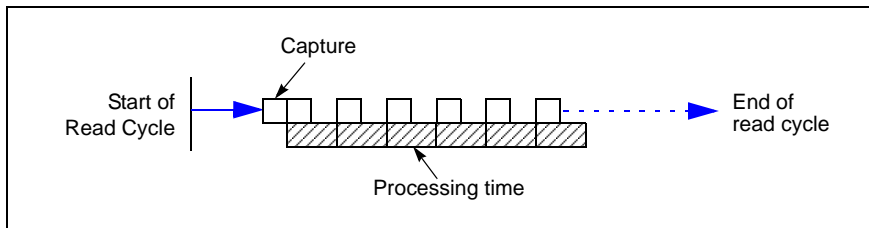

Continuous Capture

Capture Timing

Note: Capture Timing applies only to **Rapid Capture** mode.

Time Before First Capture

Usage: In almost any moving line application, a time delay is needed to ensure that a symbol will be in the reader's field of view at the beginning of the capture sequence.

Definition: **Time Before 1st Capture** in a moving line application is the time between an external trigger event and the occurrence of the first capture.

Serial Cmd: <**K242, time before 1st capture**,time between capture 1 and 2,,,,,,time between capture 7 and 8>

Default: **0**

Options: 0 to 65535 (2.097seconds, in 32 μ S increments)

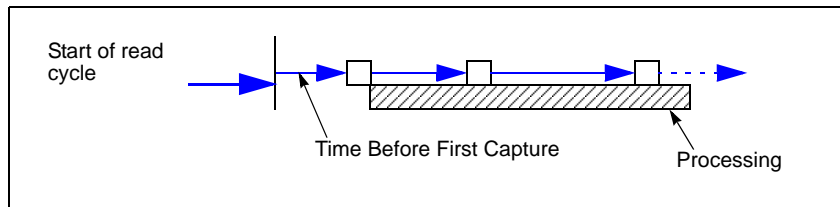

Time Before First Capture

Time Between Captures

Usage: This is useful in applications where more than one symbol can appear during a single read cycle (multisymbol), or where line speeds are slow enough that captured frames might overlap or miss a symbol.

Definition: A time delay can be inserted between individual frame captures in the **Rapid Capture** mode.

Serial Cmd: <K242,time before 1st capture,time between captures [time1,time2,...time7]>

Entering 0's will result in no time between captures (Diagram A).

Entering a different value in each field will vary the time delays accordingly (Diagram B).

Note: You must enter time values along with comma separators for each field you want to change. If you omit fields, or enter only commas, the fields will remain as previously set.

Default: 0

Options: 0 to 65535 (2.097seconds, in 32µS increments)

Note: Number of Captures and number of delays (**Time Between Captures**) must be the same.

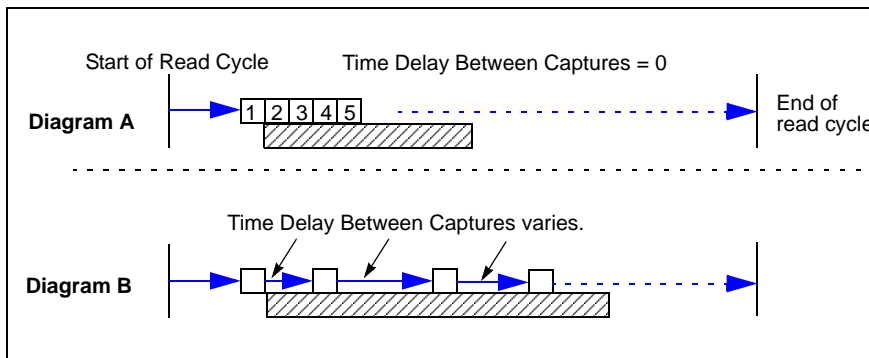

Dual Camera Switching

Note: The following options are only available when **Active Camera** is set to **Dual**.

Usage: Useful where different symbols can appear within a single read cycle.

Definition: When **Active Camera** is set to **Dual**, captures will alternate between the internal and external cameras, starting with the internal camera.

Important: The Quadrus Verifier does not control the timing of external cameras. Captures from external cameras are streamed into the Quadrus Verifier. To be sure to receive a complete first capture, allow up to 33 mS delay before the first external capture.

Switching Mode

When **Switching Mode** is set to **Number of Captures**, the combined internal and external camera captures can not exceed the total number set in **Number of Captures**; however if the combined total is less than the total, then the capture pattern will be repeated until the total number of captures has been met.

Definition: Captures can be set to alternate between the internal and external cameras by the number of captures or by camera timeouts.

Serial Cmd: <**K243**,*switching mode*,*number of internal captures*,*number of external captures*,*internal camera timeout*,*external camera timeout*>

Default: **Number of Captures**

Options: **0 = Number Of Captures**
1 = Timeout

Switching by Number of Captures

Number of Internal Camera Captures

Definition: The number of captures taken by the internal camera before switching to the external camera.

Serial Cmd: <**K243**,*switching mode*,**number of internal captures**,*number of external captures*,*internal camera timeout*,*external camera timeout*>

Default: **1**

Options: 1 to 8

Number of External Camera Captures

Usage: Useful where two cameras can expect different symbols within a given read cycle.

Definition: The number of captures taken by the external camera before switching to the external camera.

Serial Cmd: `<K243,switching mode,number of internal captures,number of external captures,internal camera timeout,external camera timeout>`

Default: 1

Options: 1 to 8

Rapid Capture Mode Examples

Since examples 1 and 2 are in **Rapid Capture** mode, the cameras will continue to switch until the **Number Of Captures** setting has been met.

Example # 1

Time Between Captures = 0, Active camera: **Dual**

Capture mode: **Rapid**, Number of captures = 7

Number of internal camera captures = 5

Number of external camera captures = 3

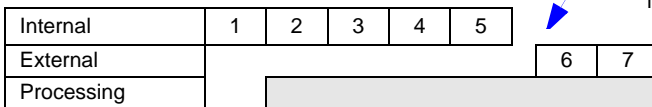

Note: The third capture for the external camera does not occur because the total number of captures (7) has been met.

Note: In this mode, the first capture from an external camera (#6 is the above example) could be delayed for up to 33mS until the external camera synchronizes with the reader.

Example # 2

Time Between Captures = 0, Active Camera: **Dual**

Capture Mode: **Rapid**, Number of captures = 8

Number of internal camera captures = 2

Number of external camera captures = 3

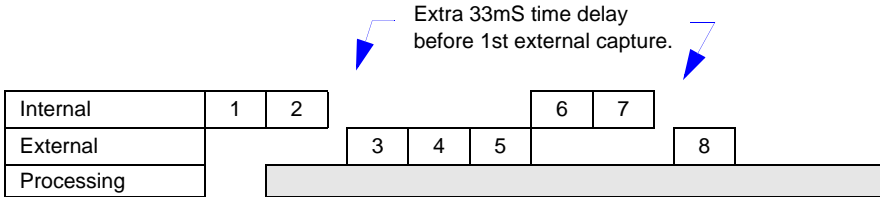

Note: Since the total number of captures is greater than the combined number of captures of both cameras, capture source will oscillate between the two cameras until the total number (8) has been met.

Continuous Capture Mode Examples

Continuous Capture mode is more involved due to the double buffering. The cameras will continue to switch for the duration of the read cycle in a double-buffered format, so that we start processing the first image while we are capturing the second. The third image will then start when both the first one is completely processed and the second is completely transferred.¹

Example # 3

Time Between Captures = 0, Capture Mode: **Dual Camera**

Number of internal camera captures = 5

Number of external camera captures = 3

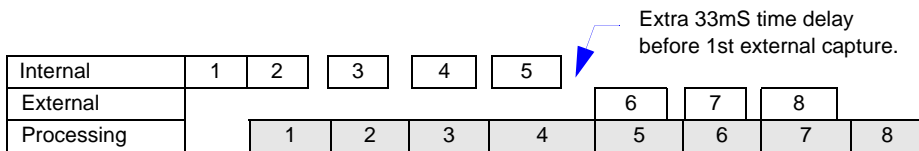

Example # 4

Time Between Captures = 0, Capture Mode: **Dual Camera**

Number of internal camera captures = 1

Number of external camera captures = 1

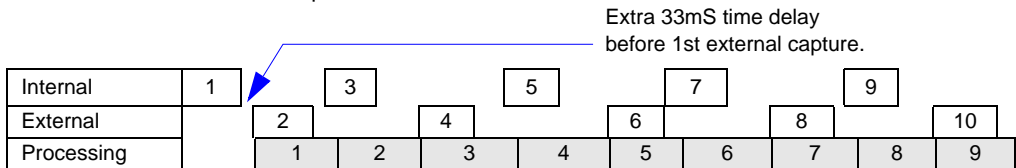

1. Because of space limitations, a limited number of captures are shown in the Continuous examples.

Switching by Timeout

The timeout mode specifies the time each camera is active before switching to the other camera. The read cycle will start with the internal camera and switch to the external camera after the specified time period has expired.

Internal Camera Timeout

Usage: It is useful in many tightly controlled applications which require a read cycle to end before the next object appears and therefore need the flexibility of a timeout adjustment.

Definition: **Internal Camera Switching Time** is the time span of the read cycle and is represented in 10mS increments. It is used in conjunction with **External Edge** or **Serial Trigger**.

Serial Cmd: <**K243**,switching mode,number of internal captures,number of external captures,**internal camera timeout**,external camera timeout>

Default: **100** (x 10mS = 1 second)

Options: 0 to 65535 (Divide any positive number entered by 100 to determine the time in seconds.)

External Camera Timeout

Usage: It is useful in many tightly controlled applications which require a read cycle to end before the next object appears and therefore need the flexibility of a timeout adjustment.

Definition: **External Camera Timeout** is the time allotted to the external camera and is represented in 10mS increments.

Serial Cmd: <**K243**,switching mode,number of internal captures,number of external captures,internal camera timeout,**external camera timeout**>

Default: **100** (x 10mS = 1 second)

Options: 0 to 65535 (Divide any positive number entered by 100 to determine the time in seconds.)

Note: A minimum setting of **2** is recommended.

Note: **Timeout** or **Timeout** or **New Trigger** under **End of Read Cycle** must be enabled for **Timeout Duration** to take effect.

Example of Timeout in Rapid Capture Mode

Since examples 5 is in **Rapid Capture** mode, the cameras will continue to switch until the **Number Of Captures** setting has been met.

Example # 5

Time Between Captures = 0

Capture Mode: **Dual Camera**

Number of captures = 6

Internal camera timeout = **170mS**

External camera timeout = **160mS**

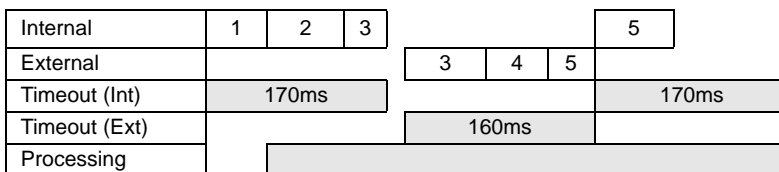

Note: The third and fifth captures were never completed since the active camera's timeout occurred during the capture. When this occurs the capture is aborted and the active camera is switched.

Example of Timeout in Continuous Capture Mode

Continuous Capture mode is a little more involved due to the double buffering. The cameras will continue to switch for the duration of the read cycle in a double-buffered format, so that we start processing the first image while we are capturing the second. The third image will then start when both the first one is completely processed and the second is completely transferred.

Example # 6

Time Between Captures = 0

Capture Mode: **Dual Camera**

Internal camera timeout = **100mS**

External camera timeout = **160mS**

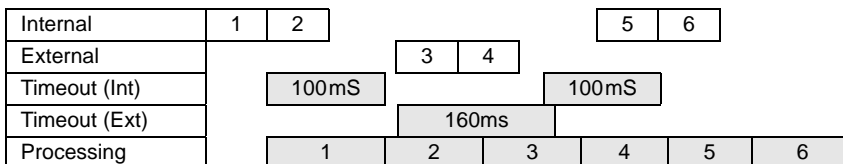

Store No Read Image

Note: Stored images will be lost whenever RAM is reset by re-powering or reset/save sequences, the capture mode is changed, or a read rate mode is initiated.

Usage: Useful for evaluating symbols and visually comparing images captured at various settings and conditions.

Definition: Images that are captured and processed but are not decoded may be stored for subsequent evaluation.

Image Storage Type

Usage: Useful for evaluating symbols and visually comparing images captured at various settings.

Definition: When **Disabled** is selected, all saved images will be cleared and no further images will be stored unless **Store on No Read** is selected.

Serial Cmd: `<K244,image storage type,image storage mode>`

Default: **Disabled/Clear**

Options: **0 = Disabled/Clear** 1 = Store on No Read

Image Storage Mode

Definition: Outputs the first or last No Read images, as selected.

In **First** mode, images will be stored until the available image memory has been filled. At this point the unit will stop storing additional images and the first images stored will be available.

In **Last** mode, the last images stored will be available. After the available memory has been filled, images will continue to be stored by purging the oldest image in the storage memory.

Serial Cmd: `<K244,image storage type,image storage mode>`

Default: **First Images**

Options: **0 = First Images** 1 = Last Images

Setting Up the Verifier for EZ Trax

If you are using **EZ Trax** software, it is important to set up the Quadrus Verifier correctly before beginning.

Click the **Read Cycle** button to display the Read Cycle tree control.

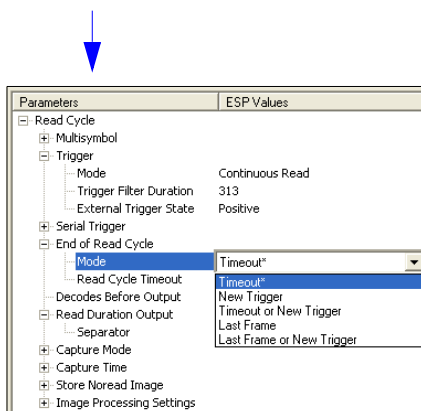
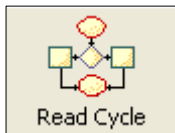

Set **Trigger Mode**, **<K200>**, to **External Edge**.

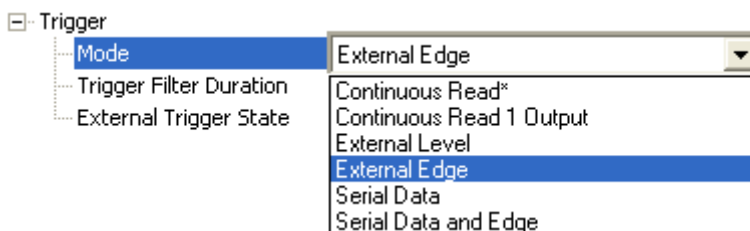

Set **Capture Mode**, **<K241>**, to **Rapid Capture**.

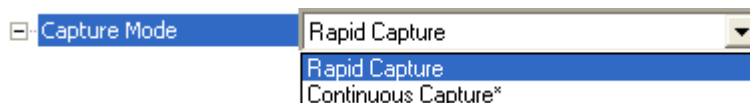

Once these Read Cycle parameters are set, you will be ready to connect to **EZ Trax**.

For more detailed information about using **EZ Trax**, refer to the Help menu in EZ Trax software, or the *EZ Trax Quick Start Guide*, available on the Microscan Tools CD.



7 Symbologies

Contents

Symbologies by ESP	7-2
Symbologies Serial Commands	7-3
Data Matrix	7-4
QR Code.....	7-6
Code 39.....	7-7
Code 128.....	7-10
BC412.....	7-11
Interleaved 2 of 5.....	7-13
UPC/EAN.....	7-16
Pharmacode	7-19
RSS Expanded.....	7-21
RSS Limited.....	7-22
RSS-14.....	7-23
PDF417	7-24
MicroPDF417.....	7-26
Composite	7-27
Narrow Margins	7-28
Symbology ID	7-29
Background Color.....	7-30

The Quadrus Verifier conforms to ISO/IEC 15415 2D verification requirements (Data Matrix), AS9132 verification requirements (dot peen and laser-etch / chemical etch Data Matrix), and the AIM DPM Quality Guideline.

This section describes the Data Matrix symbology, and also the other symbologies that can be read by the Quadrus Verifier when it is being used as a reader.

See <http://www.aimglobal.org/standards/aimpubs.asp> for additional information about symbologies.

Symbologies by ESP



Click this button to bring up the **Symbologies** menu.

To **open** the entire contents of the tree control, hold down the **Alt** key and **single-click** the **+**.
To **close** the entire contents of the tree control, hold down the **Alt** key and **single-click** the **-**.

To open nested options, **single-click** the **+**.

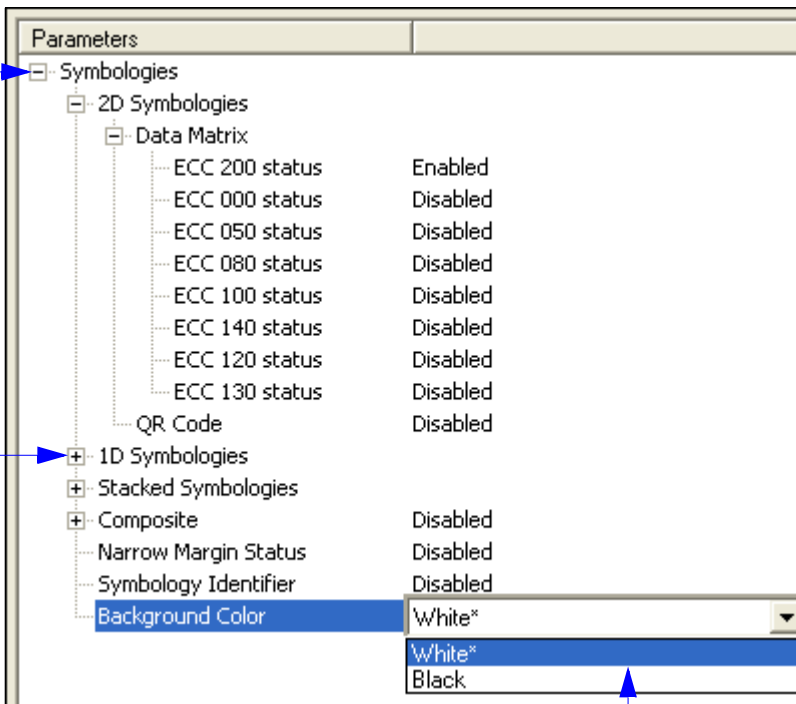

The screenshot shows a 'Parameters' dialog box with a tree view under 'Symbologies'. The tree is expanded to show '1D Symbologies'. The 'Background Color' setting is selected, and its dropdown menu is open, showing 'White*' and 'Black' options. A blue arrow points to the '+' icon next to '1D Symbologies', and another blue arrow points to the 'Background Color' dropdown menu.

Setting	Status
2D Symbologies	
Data Matrix	
ECC 200 status	Enabled
ECC 000 status	Disabled
ECC 050 status	Disabled
ECC 080 status	Disabled
ECC 100 status	Disabled
ECC 140 status	Disabled
ECC 120 status	Disabled
ECC 130 status	Disabled
QR Code	Disabled
1D Symbologies	
Stacked Symbologies	
Composite	Disabled
Narrow Margin Status	Disabled
Symbology Identifier	Disabled
Background Color	White*

To change a setting, **double-click** the setting and use your cursor to scroll through the options.

Symbologies Serial Commands

Data Matrix	< K479 , <i>ECC 200 status,ECC 000 status,ECC 050 status,ECC 080 status,ECC100 status,ECC140 status,ECC 120 status,ECC 130 status</i> >
QR Code	< K480 , <i>status</i> >
Code 39	< K470 , <i>status,check digit status,check digit output status,large intercharacter gap,fixed symbol length status,fixed symbol length,full ASCII set</i> >
Code 128	< K474 , <i>status,fixed symbol length status,fixed symbol length</i> >
BC412	< K481 , <i>status,check digit output,fixed symbol length status,fixed symbol length</i> >
Interleaved 2 of 5	< K472 , <i>status,check digit status,check digit output,symbol length #1,symbol length #2,guard bar</i> >
UPC/EAN	< K473 , <i>UPC status,EAN status,supplementals status,separator status,separator character,supplemental type</i> >
Pharmacode	< K477 , <i>status,fixed symbol length status,fixed symbol length,min. no. of bars,bar width status,direction,fixed threshold value</i> >
RSS Expanded	< K484 , <i>status,fixed symbol length status,fixed symbol length</i> >
RSS Limited	< K483 , <i>status</i> >
RSS-14	< K482 , <i>status</i> >
PDF417	< K476 , <i>status,[unused],fixed symbol length status,fixed symbol length,[unused],codeword collection</i> >
Micro PDF417	< K485 , <i>status,[unused],fixed symbol length status,fixed symbol length</i> >
Composite	< K453 , <i>mode,separator status,separator</i> >
Narrow Margins/ Symbology ID	< K450 , <i>narrow margins,symbology identifier status</i> >
Background Color	< K451 , <i>background color</i> >

Data Matrix

The Quadrus Verifier is certified for verification of Data Matrix ECC 200 symbols, per the ISO/IEC 15415 and AS9132 standards.

Usage: Useful when information needs to be packed into a small area and/or when symbols need to be applied directly to the substrate with etching, dot peen, or other methods.

Definition: Data Matrix is a type of Matrix symbology and has subsets ECC 000 — 200. ECC 200 symbols have an even number of rows and an even number of columns. Most of the symbols are square with sizes from 10 x 10 to 144 x 144. Some symbols however are rectangular with sizes from 8 x 18 to 16 x 48. All ECC 200 symbols can be recognized by the upper right corner module being light (binary 0).

ECC 200

Definition: When enabled, will decode ECC 200 symbols.

Serial Cmd: <**K479,ECC 200 status**,ECC 000 status,ECC 050 status,ECC 080 status,ECC 100 status,ECC 140 status,ECC 120 status,ECC 130 status>

Default: **Enabled**

Note: This is the only symbol type enabled by default.

Options: 0 = Disabled **1 = Enabled**

ECC 000

Definition: When enabled, will decode ECC 000 symbols

Serial Cmd: <**K479,ECC 200 status,ECC 000 status**,ECC 050 status,ECC 080 status,ECC 100 status,ECC 140 status,ECC 120 status,ECC 130 status>

Default: **Disabled**

Options: **0 = Disabled** 1 = Enabled

ECC 050

Definition: When enabled, will decode ECC 050 symbols.

Serial Cmd: <**K479,ECC 200 status,ECC 000 status,ECC 050 status**,ECC 080 status,ECC 100 status,ECC 140 status,ECC 120 status,ECC 130 status>

Default: **Disabled**

Options: **0 = Disabled** 1 = Enabled

ECC 080

Definition: When enabled, will decode ECC 080 symbols.

Serial Cmd: <**K479**,ECC 200 status,ECC 000 status,ECC 050 status,**ECC 080 status**,
ECC 100 status,ECC 140 status,ECC 120 status,ECC 130 status>

Default: **Disabled**

Options: **0 = Disabled** 1 = Enabled

ECC 100

Definition: When enabled, will decode ECC 100 symbols.

Serial Cmd: <**K479**,ECC 200 status,ECC 000 status,ECC 050 status,ECC 080 status,
ECC 100 status,ECC 140 status,ECC 120 status,ECC 130 status>

Default: **Disabled**

Options: **0 = Disabled** 1 = Enabled

ECC 140

Definition: When enabled, will decode ECC 140 symbols.

Serial Cmd: <**K479**,ECC 200 status,ECC 000 status,ECC 050 status,ECC 080 status,
ECC 100 status,**ECC 140 status**,ECC 120 status,ECC 130 status>

Default: **Disabled**

Options: **0 = Disabled** 1 = Enabled

ECC 120

Definition: ECC 120 is a legacy symbol and NOT part of the ISO/IEC 15415 standard.

Serial Cmd: <**K479**,ECC 200 status,ECC 000 status,ECC 050 status,ECC 080 status,
ECC 100 status,ECC 140 status,**ECC 120 status**,ECC 130 status>

Default: **Disabled**

Options: **0 = Disabled** 1 = Enabled

ECC 130

Definition: ECC 130 is a legacy symbol and NOT part of the ISO/IEC 15415 standard.

Serial Cmd: <**K479**,ECC 200 status,ECC 000 status,ECC 050 status,ECC 080 status,
ECC 100 status,ECC 140 status,ECC 120 status,**ECC 130 status**>

Default: **Disabled**

Options: **0 = Disabled** 1 = Enabled

QR Code

Usage: Widely implemented in the automotive industry in Japan and throughout their worldwide supply chain.

Definition: The QR Code is capable of handling numeric, alphanumeric, byte data as well as Japanese kanji and kana characters. Up to 7,366 characters (numeric data) can be encoded using this symbol. Therefore, less space is required to encode the same amount of data in the QR Code than in a conventional symbol, helping to reduce the size of a symbol and lower the paper costs.

Three position detection patterns in the symbol make omnidirectional, ultra-fast reading possible.

QR Code has error correction capability. Data can be frequently be restored even if a part of the symbol has become dirty or been damaged.

Serial Cmd: **<K480,status>**

Default: **Disabled**

Options: **0 = Disabled** 1 = Enabled

Code 39

- Usage:** **Code 39** is considered the standard for non-retail symbology.
- Definition:** An alphanumeric symbology with unique start/stop code patterns, composed of 9 black and white elements per character, of which 3 are wide.
- Serial Cmd:** <**K470**, **status**, *check digit status*, *check digit output status*, *large intercharacter gap*, *fixed symbol length status*, *fixed symbol length*, *full ASCII set*>
- Default:** **Disabled**
- Options:** **0 = Disabled** 1 = Enabled

Check Digit Status (Code 39)

- Serial Cmd:** <**K470**, *status*, **check digit status**, *check digit output*, *large intercharacter gap*, *fixed symbol length status*, *fixed symbol length*, *full ASCII set*>
- Default:** **Disabled**
- Options:** **0 = Disabled** 1 = Enabled

Check Digit Output Status (Code 39)

- Usage:** **Check digit Output**, added to the symbol, provides additional security.
- Definition:** When enabled, the check digit character is read and compared along with the symbol data. When disabled, symbol data is sent without the check digit.
- Note:** With **Check Digit Output** and an **External** or **Serial** trigger option enabled, an invalid check digit calculation will cause a No Read message to be transmitted at the end of the read cycle.
- Serial Cmd:** <**K470**, *status*, *check digit status*, **check digit output**, *large intercharacter gap*, *fixed symbol length status*, *fixed symbol length*, *full ASCII set*>
- Default:** **Disabled**
- Options:** **0 = Disabled** 1 = Enabled

Large Intercharacter Gap (Code 39)

Usage: **Large Intercharacter Gap** is helpful for reading symbols that are printed out of specification.

Caution: Do not use **Large Intercharacter Gap** with **Narrow Margins** enabled since a large intercharacter gap (over 3x) could cause a narrow margins (5x) to be interpreted as an intercharacter gap.

Definition: When enabled, the reader can read symbols with gaps between symbol characters that exceed three times (3x) the narrow element width.

Serial Cmd: <**K470**, status, check digit status, check digit output, **large intercharacter gap**, fixed symbol length status, fixed symbol length, full ASCII set>

Default: **Disabled**

Options: **0 = Disabled** 1 = Enabled

Fixed Symbol Length Status (Code 39)

Definition: When enabled the reader will check the symbol length against the symbol length field. If disabled any length would be considered a valid symbol.

Serial Cmd: <**K470**, status, check digit status, check digit output, large intercharacter gap, **fixed symbol length status**, fixed symbol length, full ASCII set>

Default: **Disabled**

Options: **0 = Disabled** 1 = Enabled

Fixed Symbol Length (Code 39)

Usage: **Fixed Symbol Length** helps prevent truncations and increases data integrity by ensuring that only one symbol length will be accepted.

Definition: Specifies the exact number of characters that the reader will recognize (this does not include start and stop and check digit characters). The reader ignores any symbology not having the specified length.

Serial Cmd: <**K470**, status, check digit status, check digit output, large intercharacter gap, fixed symbol length status, **fixed symbol length**, full ASCII set>

Default: **10**

Options: 1 to 128

Full ASCII Set (Code 39)

- Usage:** Must be enabled when reading characters outside the standard character set (0-9, A-Z, etc.)
User must know in advance whether or not to use **Full ASCII Set** option. Since **Full ASCII Set** requires two code words to encode one character, it is less efficient.
- Definition:** Standard Code 39 encodes 43 characters; zero through nine, capital “A” through capital “Z”, minus symbol, plus symbol, forward slash, space, decimal point, dollar sign and percent symbol. When **Full ASCII Set** is enabled, the reader can read the full ASCII character set, from 0 to 255.
- Serial Cmd:** *<K470, status, check digit status, check digit output, large intercharacter gap, fixed symbol length status, fixed symbol length, full ASCII set>*
- Default:** **Disabled**
- Options:** **0 = Disabled** 1 = Enabled

Code 128

Usage: **Code 128** is a smaller symbology useful in applications with tight spots and high security needs.

Definition: A very dense alphanumeric symbology. It encodes all 128 ASCII characters, it is continuous, has variable length, and uses multiple element widths measured edge to edge.

Serial Cmd: **<K474,status,fixed symbol length status,fixed symbol length>**

Default: **Disabled**

Options: **0 = Disabled** 1 = Enabled

Fixed Symbol Length Status (Code 128)

Definition: When enabled the reader will check the symbol length against the symbol length field. If disabled any length would be considered a valid symbol.

Serial Cmd: **<K474, status,fixed symbol length status,fixed symbol length>**

Default: **Disabled**

Options: **0 = Disabled** 1 = Enabled

Fixed Symbol Length (Code 128)

Usage: **Fixed Symbol Length** helps prevent truncations and increases data integrity by ensuring that only one symbol length will be accepted.

Definition: It specifies the exact number of characters that the reader will recognize (this does not include start and stop and check digit characters). The reader ignores any symbol not having the specified length.

Serial Cmd: **<K474, status,fixed symbol length status,fixed symbol length>**

Default: **10**

Options: 1 to 128

Note: **Fixed Symbol Length Status** must be enabled for **Fixed Symbol Length** to take effect.

BC412

- Usage:** It is widely used in the semi-conductor manufacturing and is particularly useful where speed, accuracy, and ease of printing are required.
- Definition:** BC412 (Binary Code 412), a proprietary IBM symbology since 1988, is an alphanumeric symbol with a set of 35 characters, each encoded by a set of 4 bars in 12 module positions. All bars have a single width and it is the presence or absence of bars in each of the 12 module positions that make's it a binary code (hence the prefix "BC").
The symbology is bi-directional and self-clocking with a start and stop character.
- Serial Cmd:** <**K481,status,check digit output,fixed symbol length status,fixed symbol length**>
- Default:** **Disabled**
- Options:** **0 = Disabled** 1 = Enabled

Check Digit Output (BC412)

- Usage:** **Check digit Output**, added to the symbol, provides additional security.
- Definition:** When enabled, the check digit character is read and compared along with the symbol data. When disabled, symbol data is sent without the check digit.
Note: With **Check Digit Output** and an **External** or **Serial** trigger option enabled, an invalid check digit calculation will cause a No Read message to be transmitted at the end of the read cycle.
- Serial Cmd:** <**K481,status,check digit output,fixed symbol length status,fixed symbol length**>
- Default:** **Disabled**
- Options:** **0 = Disabled** 1 = Enabled

Fixed Symbol Length Status (BC412)

- Definition:** When enabled the reader will check the symbol length against the symbol length field. If disabled any length would be considered a valid symbol.
- Serial Cmd:** <**K481,status,check digit output,fixed symbol length status,fixed symbol length**>
- Default:** **Disabled**
- Options:** **0 = Disabled** 1 = Enabled

Fixed Symbol Length (BC412)

Usage: **Fixed Symbol Length** helps prevent truncations and increases data integrity by ensuring that only one symbol length will be accepted.

Definition: Specifies the exact number of characters that the reader will recognize (this does not include start and stop and check digit characters). The reader ignores any symbology not having the specified length.

Serial Cmd: **<K481, status, check digit output, fixed symbol length status, fixed symbol length>**

Default: **10**

Options: 1 to 64

Interleaved 2 of 5

- Usage:** It is has been popular because it is the most dense symbology for printing numeric characters less than 10 characters in length; however, Microscan does not recommend this symbology for any new applications because of inherent problems such as truncation.
- Definition:** A dense, continuous, self-checking, numeric symbology. Characters are paired together so that each character has five elements, two wide and three narrow, representing numbers **0** through **9**, with the bars representing the first character and the interleaved spaces representing the second character. (A check digit is highly recommended.)
- Important:** You must set **Symbol Length** in order to decode I 2/5 symbols.
- Serial Cmd:** <**K472,status,check digit status,check digit output,symbol length #1,symbol length #2**>
- Default:** **Disabled**
- Options:** **0 = Disabled** 1 = Enabled

Check Digit Status (Interleaved 2 of 5)

- Usage:** It is typically not used but can be enabled for additional security in applications where the host requires redundant check digit verification.
- Definition:** An error correcting routine in which the check digit character is added.
- Serial Cmd:** <**K472,status,check digit status,check digit output,symbol length #1,symbol length #2**>
- Default:** **Disabled**
- Options:** **0 = Disabled** 1 = Enabled

Check Digit Output Status (Interleaved 2 of 5)

- Definition:** When enabled, a check digit character is sent along with the bar symbol data for added data security.
- Serial Cmd:** <**K472,status,check digit status,check digit output,symbol length #1,symbol length #2**>
- Default:** **Disabled**
- Options:** **0 = Disabled** 1 = Enabled

Symbol Length #1 (Interleaved 2 of 5)

Usage: With I 2/5, two symbol lengths can be defined. When using only one symbol length in an application, setting **Symbol Length # 2** to **0** (zero) to ensure data integrity is recommended.

Definition: Allows user to define the symbol length. Because I 2/5 is a continuous symbology, it is prone to substitution errors. Hence, a symbol length must be defined and a bar code symbol must contain an even number of digits.

Note: If a start, stop or check digits are used, they are not included in the symbol length count.

Serial Cmd: <K472, status, check digit status, check digit output, **symbol length #1**, symbol length #2>

Default: **10**

Options: 2 to 128, even only

Since I 2/5 characters are paired, symbol length must be set to an even number. If **Check Digit** is enabled, add 2 to your symbol length. For example, if your symbol is 10 characters plus a check digit, then enable **Symbol Length # 1** for **12**.

Note: Typically, when printing an I 2/5 symbol with an odd number of digits, a 0 will be added as the first character.

Note: If both **Symbol Length #1** and **Symbol Length #2** are set to **0**, then I-2/5 will be variable.

Symbol Length #2 (Interleaved 2 of 5)

Usage: If using a second symbol, a zero or any even symbol length from **2** to **64** may be specified. If not using a second symbol, set **Symbol Length #2** to **0** to ensure data integrity.

Definition: Allows user to define a second symbol length for I-2 of 5.

Serial Cmd: <K472, status, check digit status, check digit output, symbol length #1, **symbol length # 2**>

Default: **6**

Options: 2 to 128, even only

Since I 2/5 characters are paired, symbol length must be set to an even number. If **Check Digit** is enabled, add 2 to your symbol length. For example, if your symbol is 10 characters plus a check digit, then enable **Symbol Length** for **12**.

Note: Typically, when printing an I 2/5 symbol with an odd number of digits, a **0** will be added as the first character.

Note: If both **Symbol Length #1** and **Symbol Length # 2** are set to **0**, then I 2/5 will be variable.

Guard Bar (Interleaved 2 of 5)

Note: Whenever Guard Bar is enabled, the presence of guard bars is required for decoding to take place.

Usage: It is useful when I 2 of 5 multisymbols are enabled to prevent false data output. This typically occurs with highly tilted or skewed symbols.

Definition: A guard bar is a heavy bar, at least 2 times the width of the wide bar, surrounding the printed I 2 of 5 symbol and helping to prevent false reads.

Serial Cmd: <**K472**, status, check digit status, check digit output status, symbol length #1, symbol length #2, **guard bar**>

Default: **Disabled**

Options: **0 = Disabled** 1 = Enabled

UPC/EAN

Usage: Used primarily in POS application in the retail industry. It is commonly used with Microscan readers in applications in combination with **Matchcode** when there is a need to verify that the right product is being placed in the right packaging.

Definition: UPC (Universal Product Code) is a fixed length numeric, continuous symbology. UPC can have two- or five-digit supplemental bar code data following the normal code. The U.P.C., Version A (U.P.C., A) symbol is used to encode a 12 digit number. The first digit is the number system character, the next five are the manufacturer number, the next five are the product number, and the last digit is the checksum character.

When enabled, the Verifier will read UPC version A and UPC version E only.

Serial Cmd: <**K473**,**UPC status**,*EAN status*,*supplementals status*,*separator status*,*separator character*,*supplemental type*>

Default: **Disabled**

Options: **0 = Disabled** 1 = Enabled

EAN Status (UPC/EAN)

Usage: **EAN** is the European version of the UPC symbology and is used in European market applications.

Note: **UPC** must be enabled for **EAN** to take effect.

Definition: EAN is a subset of UPC. When enabled, the Verifier will read UPC version A, UPC version E, EAN 13, and EAN 8. It also appends a leading zero to UPC version A symbol information and transmits 13 digits. If transmitting 13 digits when reading UPC version A symbols is not desired, disable **EAN**.

Note: The extra character identifies the country of origin.

Serial Cmd: <**K473**,*UPC status*,**EAN status**,*supplementals status*,*separator status*,*separator character*,*supplemental type*>

Default: **Disabled**

Options: **0 = Disabled** 1 = Enabled

Supplementals Status (UPC/EAN)

Usage: Reads **Supplementals** typically used in publications and documentation.

Definition: A supplemental is a 2 or 5 digit symbol appended to the main symbol. When set to **Enabled** or **Required**, the Verifier reads supplemental bar code data that has been appended to the standard UPC or EAN codes.

Serial Cmd: <**K473**,UPC status,EAN status,**supplementals status**,separator status,separator character,supplemental type>

Default: **Disabled**

Options: **0 = Disabled** 1 = Enabled 2 = Required

Disabled

UPC **Supplementals** will not be decoded.

Enabled

When enabled, the Verifier will try to decode a main and a supplemental. However, if a supplemental is not decoded, at the end of the read cycle, the main will be sent by itself.

Required

When set to **Required**, both the main and the supplemental symbols must be read or a single No Read condition results.

For example, if **Supplementals** is set to **Required**, **Separator** is enabled, and an asterisk is defined as the UPC separator character, then the data will be displayed as: MAIN * SUPPLEMENTAL.

Note: Under no circumstances will the supplemental symbol data be sent without a main symbol.

Note: If additional symbols—other than the main or supplemental—will be read in the same read cycle, **Number of Symbols** should be set accordingly.

Separator Status (UPC/EAN)

Usage: Allows user to distinguish between the main and **Supplemental** symbols.

Definition: Allows the user to insert a character between the standard UPC or EAN symbology and the supplemental symbology when **Supplementals** is set to **Enabled** or **Required**.

Serial Cmd: <**K473**,UPC status,EAN status,supplementals status,**separator status**,separator character,supplemental type>

Default: **Disabled**

Options: **0 = Disabled** 1 = Enabled

Separator Character (UPC/EAN)

Note: If **Separator Character** has been changed to any other character and you wish to re-define the separator as a comma, you will need to use **ESP** or the embedded menu.

Usage: As required by the application.

Definition: Allows the user to change the separator character from a comma to a new character.

Serial Cmd: <**K473**,UPC status,EAN status,supplementals status,separator status,**separator character**,supplemental type>

Default: , (comma)

Options: Any ASCII character

Note: Whenever **Separator Character** is defined as a comma (,) sending a <**K473,s?**> command will return the current settings including the separator character comma which appears after the separator status comma.

Supplemental Type (UPC/EAN)

Usage: As required by symbology used in application.

Definition: Allows the user to select 2 character or 5 character supplements, or both.

Serial Cmd: <**K473**,UPC status,EAN status,supplementals status,separator status,**separator character**,**supplemental type**>

Default: **Both**

Options: **0 = Both** 1 = 2 char only 2 = 5 char only

Both

Either 2 character or 5 character supplementals will be considered valid.

2 Characters Only

Only two character supplementals will be considered valid.

5 Characters Only

Only five character supplementals will be considered valid.

Pharmacode

- Usage:** Used mostly with packaging for the pharmaceuticals industry.
- Definition:** Encodes up to five different numbers, each with its own color which may be entered in decimal or “binary” format with a 1 represented by a thick bar and a 0 represented by a thin bar. Bar width is independent of height.
In decimal format, each part can be up to 999999.
In binary format, each input have up to 19 ones and zeros.
- Serial Cmd:** *<K477,status,fixed symbol length status,fixed symbol length,min. no. of bars,bar width status,direction,fixed threshold value>*
- Default:** **Disabled**
- Options:** **0 = Disabled** 1 = Enabled

Fixed Symbol Length Status (Pharmacode)

- Definition:** When enabled, the reader will check the symbol length against the symbol length field. If disabled, any length would be considered a valid symbol.
- Serial Cmd:** *<K477,status,fixed symbol length status,fixed symbol length,min. no. of bars,bar width status,direction,fixed threshold value>*
- Default:** **Disabled**
- Options:** **0 = Disabled** 1 = Enabled

Fixed Symbol Length (Pharmacode)

- Definition:** This specifies the exact number of characters that the reader will recognize (this does not include start and stop and check digit characters). The reader ignores any symbology not having the specified length.
- Serial Cmd:** *<K477,status,fixed symbol length status,fixed symbol length,min. no. of bars,bar width status,direction,fixed threshold value>*
- Default:** **10**
- Options:** 4 to 16

Minimum Number of Bars (Pharmacode)

- Definition:** Sets the minimum number of bars that a pharmacode symbol must have to be considered as a valid symbol.
- Serial Cmd:** *<K477,status,fixed symbol length status,fixed symbol length,min. no. of bars,bar width status,direction,fixed threshold value>*
- Default:** **4**
- Options:** 4 to 16

Bar Width Status (Pharmacode)

Definition: If set to **Mixed**, it will autodiscriminate between narrow bars and wide bars. If set to **All Narrow**, all bars will be considered as narrow bars. If set to **All Wide**, all bars will be considered as wide bars. If set to **Fixed Threshold**, it will use the **Fixed Threshold** value to determine whether the bars are narrow or wide. The **Bar Width Status** setting will be ignored when the reader is able to tell the difference between the narrow and the wide bars.

Serial Cmd: *<K477,status,fixed symbol length status,fixed symbol length,min. no. of bars, bar width status,direction,fixed threshold value>*

Default: **Mixed**

Options: **0 = Mixed** 1 = All Narrow
 2 = All Wide 3 = Fixed Threshold

Decode Direction (Pharmacode)

Definition: Specifies the direction that a symbol can be read.

Serial Cmd: *<K477,status,fixed symbol length status,fixed symbol length,min. no. of bars, bar width status,direction,fixed threshold value>*

Default: **Forward**

Options: **0 = Forward** 1 = Reverse

Fixed Threshold Value (Pharmacode)

Definition: Used when **Bar Width Status** is set to **Fixed Threshold**. Defines the minimum difference in pixels that will distinguish a narrow bar from a wide bar.

Serial Cmd: *<K477,status,fixed symbol length status,fixed symbol length,min. no. of bars,bar width status,direction,fixed threshold value>*

Default: **10**

Options: 1 to 65535

RSS Expanded

- Usage:** Used to encode primary and supplementary data in retail point-of-sale and other applications.
- Definition:** RSS Expanded is a variable length symbology that can encode supplementary information in addition to the 14-digit EAN.UCC item identification number and is capable of encoding up to 74 numeric or 41 alphabetic characters.
- Serial Cmd:** <**K484, status, fixed symbol length status, fixed symbol length**>
- Default:** **Disabled**
- Options:** **0 = Disabled**
 1 = Enabled (non-stacked)
 2 = Enabled (stacked and non-stacked)

Where appropriate, use 1 (non-stacked) instead of 2 (stacked and non-stacked).

Fixed Symbol Length Status (RSS Expanded)

- Definition:** When enabled, the reader will check the symbol length against the symbol length field, minus the embedded check digit. If disabled, any length would be considered a valid symbol.
- Serial Cmd:** <**K484, status, fixed symbol length status, fixed symbol length**>
- Default:** **Disabled**
- Options:** **0 = Disabled** 1 = Enabled

Fixed Symbol Length (RSS Expanded)

- Usage:** **Fixed Symbol Length** helps prevent truncations and increases data integrity by ensuring that only one symbol length will be accepted.
- Definition:** Specifies the exact number of characters that the reader will recognize (this does not include start and stop and check digit characters). The reader ignores any symbol not having the specified length.
- Serial Cmd:** <**K484, status, fixed symbol length status, fixed symbol length**>
- Default:** **10**
- Options:** 1 to 74

RSS Limited

- Usage:* RSS Limited is designed to be read by laser and CCD readers. It is not recommended for omnidirectional slot readers.
- Definition:* Encodes a smaller 14-digit symbol (74 modules wide) that is not omnidirectional.
- Serial Cmd:* **<K483, status>**
- Default:* **Disabled**
- Options:* **0 = Disabled**
1 = Enabled

RSS-14

Usage: Used in the grocery retail and prescription drug industries where full 14-digit EAN.UCC item identification may be needed.

Definition: RSS-14 (Reduced Space Symbology) is a fixed length symbology that encodes 14-digits, including a 1 digit indicator digit and is 96 modules wide. It can be stacked into two rows, read omnidirectional if printed in full height, or not if height-truncated for small marking.

Serial Cmd: **<K482, status>**

Default: **Disabled**

Options: **0 = Disabled**

1 = Enabled (non-stacked)

2 = Enabled (stacked and non-stacked)

Where appropriate, use **1** (non-stacked) instead of **2** (stacked and non-stacked).

PDF417

Usage: Used in applications where a large amount of information (over 32 characters) needs to be encoded within a symbol, typically where the symbol is transported from one facility to another. For example, an automobile assembly line might use a single symbol with multiple fields of information that will be read at several stations along the way, without reference to a database.

Definition: A two-dimensional, multi-row (3 to 90), continuous, variable length symbology that has high data capacity for storing up to 2700 numeric characters, 1800 printable ASCII characters, or 1100 binary character per symbol. Each symbol character consists of 4 bars and 4 spaces in a 17-module structure.

Serial Cmd: `<K476,status,[unused],fixed symbol length status,fixed symbol length,[unused],codeword collection>`

Default: **Disabled**

Options: **0 = Disabled** 1 = Enabled

Note: Sending `<a1>` will cause PDF417 data to be prefaced with information consisting of error correction level (ECC Level *n*), number of rows (*n* Rows), number of columns (*n* Columns), number of informative code words (*n* Info Code Words) and the number of data characters (*n* Data Bytes). This feature can be disabled by re-sending `<a1>`.

Fixed Symbol Length Status (PDF417)

Serial Cmd: `<K476,status,[unused],fixed symbol length status,fixed symbol length,[unused],codeword collection>`

Default: **Disabled**

Options: **0 = Disabled** 1 = Enabled

Fixed Symbol Length (PDF417)

Usage: Used to increase data integrity by ensuring that only one symbol length will be accepted.

Definition: When enabled, the PDF symbol must contain the same number of characters as the symbol length setting before it can be considered a good read. The reader will ignore any symbol not having the specified length.

Serial Cmd: `<K476,status,[unused],fixed symbol length status,fixed symbol length,[unused],codeword collection>`

Default: **10**

Options: 1 to 2710

Note: **Fixed Symbol Length Status** must be enabled for **Fixed Symbol Length** to take effect.

Codeword Collection (PDF417)

Usage: **Multiple Codeword Collection** is useful in applications where portions of subsequent images can be read and pieced together so that no opportunity or time is lost to assemble codewords for decoding.

Definition: When set to **Multiple**, PDF codewords is collected from multiple images and assembled throughout the read cycle until the read cycle ends or the symbol is fully decoded. It is important to note that when this feature is enabled, only one PDF symbol should be presented to the reader per read cycle.

Serial Cmd: <**K476**,status,[unused],fixed symbol length status,fixed symbol length,[unused],**codeword collection**>

Default: **Single Image**

Options: **0 = Single Image** 1 = Multiple Image

Note: **Fixed Symbol Length Status** must be enabled for **Fixed Symbol Length** to take effect.

MicroPDF417

- Usage:* Used for labeling small items that need large capacity.
- Definition:* A variant of PDF417, a very efficient and compact stacked symbology that can encode up to 250 alphanumeric characters or 366 numeric characters per symbol.
- Serial Cmd:* **<K485,status,[unused],fixed symbol length status,fixed symbol length>**
- Default:* **Disabled**
- Options:* **0 = Disabled** 1 = Enabled

Fixed Symbol Length Status (MicroPDF417)

- Serial Cmd:* **<K485,status,[unused],fixed symbol length status,fixed symbol length>**
- Default:* **Disabled**
- Options:* **0 = Disabled** 1 = Enabled

Fixed Symbol Length (MicroPDF417)

- Usage:* Used to increase data integrity by ensuring that only one symbol length will be accepted.
- Definition:* When enabled, the Micro PDF symbol must contain the same number of characters as the symbol length setting before it can be considered a good read. The reader will ignore any symbol not having the specified length.
- Serial Cmd:* **<K485,status,[unused],fixed symbol length status,fixed symbol length>**
- Default:* **10**
- Options:* 1 to 2710

Note: **Fixed Symbol Length Status** must be enabled for **Fixed Symbol Length** to take effect.

Composite

When set to **Enabled** or **Required**, will attempt to decode the composite component of a linear symbol. The linear symbol can be RSS14, RSS Expanded, RSS Limited, UCC/EAN-128, UPC-A, EAN-13, EAN-8, and UPC-E.

Usage: Allows reading by both linear and 2D readers.

Definition: Combines 2D and linear width modulated symbology on the same symbol where different messages can be read by each reader type.

Serial Cmd: <**K453**,*mode*,*separator status*,*separator*>

Default: **Disabled**

Options: **0 = Disabled** 1 = Enabled Required

Enabled

If set to **Enabled** it only decodes the linear component, it will output only the linear component.

Required

If set to **Required**, it must decode both the linear and the composite components; otherwise it outputs a No Read.

Separator Status (Composite)

Usage: Allows user to distinguish between the main and **Supplemental** symbols.

Definition: This separator separates the linear symbol and the composite component.

Serial Cmd: <**K453**,*mode*,**separator status**,*separator*>

Default: **Disabled**

Options: **0 = Disabled** 1 = Enabled

Separator Character (Composite)

Note: If **Separator Character** has been changed to any other character and you wish to re-define the separator as a comma, you will need to use **ESP** or the embedded menu.

Usage: As required by the application.

Definition: Allows the user to change the separator character from a comma to a new character.

Serial Cmd: <**K453**,*mode*,*separator status*,**separator**>

Default: , (comma)

Options: Any ASCII character

Narrow Margins

Note: **Narrow Margins** is only used for linear symbology types. Do not use with PDF.

Usage: Used when the leading and trailing edges of the symbols are smaller than the standard margin or other objects encroach into the margins.

Definition: Allows the reader to read symbols with quiet zones less than 8 times the width of the narrow bar element. "Quiet zone" is the space at the leading and trailing ends of a symbol. Each quiet zone can be as narrow as only five times the width of the narrow bar element when **Narrow Margins** is enabled.

Serial Cmd: <**K450, narrow margins**, symbology identifier status>

Default: **Disabled**

Options: **0 = Disabled** 1 = Enabled

Note: Do not use **Narrow Margins** with **Large Intercharacter Gap** enabled in Code 39.

Symbology ID

Usage: Used when the symbology type and how it's decoded needs to be known.

Definition: Symbology ID is an ISO/IEC 15415 standard prefix set of characters that identifies the symbol type.

When enabled, the reader analyzes and identifies the symbology and adds a three character identifying prefix to the data:

3.] (closed bracket character) indicating the presence of a symbology ID.

4. **A, C, E, I, L, Q, b, d, p**

A = Code 39; **C** = Code 128; **E** = UPC/EAN; **I** = I-2/5; **L** = PDF417; **Q** = QR Code; **b** = BC412; **d** = Data Matrix; **p** = Pharmacode

5. Modifier

Serial Cmd: <**K450**, narrow margins, **symbology identifier status**>

Default: **Disabled**

Options: **0 = Disabled** 1 = Enabled

Explanation of Modifiers for Code 39, Codabar, and Interleaved 2 of 5

- For Code 39, Codabar and I 2/5, the modifier indicates **Check Digit** and **Check Digit Output** status.
- For Code 39 only, **Full ASCII** needs to be enabled to see modifiers **4, 5**, and **7**.

Modifier	Check Digit	Check Digit Output	Full ASCII conversion performed (Code 39 only)
0	Disabled	N/A	No
1	Enabled	Enabled	No
3	Enabled	Disabled	No
4	Disabled	N/A	Yes
5	Enabled	Enabled	Yes
7	Enabled	Disabled	Yes

Example: **JA5** indicates a Code 39 symbol with **Check Digit** and **Check Digit Output** enabled and Full ASCII conversion performed.

Explanation of Modifiers for Other Symbologies

- For Code 128, a **1** indicates ECC/EAN-128; otherwise the modifier is a **0**.
- For QR Code, a **0** indicates Model 1; a **1** indicates Model 2.
- For all other codes, the modifier is **0**.

Background Color

Usage: If the background is darker than the symbol, then enable black background. Typically the background is white; but on PCBs for example, they can be black.

Definition: Allows the user to choose which symbol background (white or black) the reader can read.

Serial Cmd: **<K451, background color>**

Default: **White**

Options: **0 = White** 1 = Black



8 I/O Parameters

Contents

- I/O Parameters by ESP 8-2
- I/O Parameters Serial Commands 8-3
- Symbol Data Output 8-4
- When to Output Symbol Data 8-6
- No Read Message 8-7
- Bad/No Symbol Qualification 8-9
- Read Duration Output 8-16
- Output Indicators 8-17
- Serial Verification 8-20
- Video Output 8-22
- Image Output 8-24
- Image Captioning 8-26
- Synchronous Trigger 8-28
- EZ Button 8-30
- EZ Button Modes 8-32
- Input 1 8-34
- Output 1 Parameters 8-35
- Output 2 Parameters 8-48
- Output 3 Parameters 8-52
- Configuring EZ Trax Output 8-56

This section includes instructions on setting up conditions for changing input/output electrical transitions for control of internal and external devices. A discrete I/O (in/out) signal is an electrical transition from one voltage level to another so that digital switching can occur.

I/O Parameters by ESP

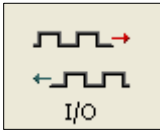

Click this button to bring up the **I/O Parameters** menu.

To **open** the entire contents of the tree control, hold down the **Alt** key and **single-click** the **+**.
To **close** the entire contents of the tree control, hold down the **Alt** key and **single-click** the **-**.

To open nested options, **single-click** the **+**.

Parameters	ESP Values
<input type="checkbox"/> I/O Parameters	
<input type="checkbox"/> Symbol Data Output	Good Read
<input type="checkbox"/> Noread Message	Enabled
<input type="checkbox"/> Bad / No Symbol Qualification	
<input type="checkbox"/> Read Duration Output	Disabled
<input type="checkbox"/> Output Object Info	Disabled
<input type="checkbox"/> Output Indicators	
<input type="checkbox"/> Serial Verification	
<input type="checkbox"/> Video Output	
<input type="checkbox"/> Image Output	
<input type="checkbox"/> EZ Trax Output	
<input type="checkbox"/> Image Captioning	
<input type="checkbox"/> Synchronous Trigger	
<input type="checkbox"/> EZ Button	Enabled
<input type="checkbox"/> Input 1	Disabled
<input checked="" type="checkbox"/> Unique Item Identifier (UII)	Disabled*
<input type="checkbox"/> Error Message	Disabled*
<input type="checkbox"/> Output 1 Parameters	Enabled
<input type="checkbox"/> Output 2 Parameters	UII only
<input type="checkbox"/> Output 3 Parameters	

To change a setting, **double-click** the setting and use your cursor to scroll through the options.

I/O Parameters Serial Commands

Symbol Data Output	< K705 ,symbol data output status,when to output>
No Read Message	< K714 ,no read message status,no read message>
Bad Symbol Message	< K715 ,[unused],message>
No Symbol Message	< K716 ,[unused],message>
1D/Stacked Symbology Qualification	< K717 ,minimum number of bars,minimum number of qualified scans,start/stop status>
2D Symbology Qualification	< K718 ,finder pattern status,symbol size mode,symbol size 1,symbol size 2,symbol size tolerance,dimension mode,dimension 1,dimension 2,dimension tolerance,orientation mode,orientation value>
Read Duration Output	< K706 ,status,separator>
LED Indicators	< K750 ,green flash mode,target pattern status,green flash duration>
Beeper	< K702 ,beeper status>
LED Configuration	< K737 ,LED mode,ISO/IEC 15415 grade,DPM grade>
Serial Verification	< K701 ,serial command echo status,serial command beep status,control/hex output>
Video Output	< K760 ,video output status,trigger image mode,image frame>
Image Output	< K739 ,image output status,com port,file format,JPEG quality>
EZ Trax Output	< K757 ,comm port,image mode,image format,jpeg quality,object info output>
Image Captioning	< K762 ,mode>
Synchronous Trigger	< K761 ,synchronous trigger mode>
EZ Button	< K770 ,global status,default on power-on,load IP database,save for power-on>
EZ Button Modes	< K771 ,position 1 mode,position 2 mode,position 3 mode,position 4 mode>
Input 1	< K730 ,input mode,active state>
Output 1 Parameters	< K810 ,output on,active state,pulse width,output mode>
Trend Analysis Output 1	< K780 ,trend analysis mode,number of triggers,number to output on>
Diagnostic Warnings Output 1	< K790 ,over temp,service unit,external camera disconnect>
ISO/IEC 15415 Verification Output 1	< K830 ,grade,decode,symbol contrast,fixed pattern damage,axial non-uniformity,grid non-uniformity,modulation,unused error correction,print growth value>
AS9132 Verification Output 1	< K840 ,dot center offset,cell fill,dot ovality,angle of distortion,symbol contrast,quiet zone>
Output 2 Parameters	< K811 ,output on,active state,pulse width,output mode>
Trend Analysis Output 2	< K781 ,trend analysis mode,trigger evaluation period,number to output on>
Diagnostic Warnings Output 2	< K791 ,over temp,service unit,external camera disconnect>
ISO/IEC 15415 Verification Output 2	< K831 ,grade,decode,symbol contrast,fixed pattern damage,axial non-uniformity,grid non-uniformity,modulation,unused error correction,print growth value>
AS9132 Verification Output 2	< K841 ,dot center offset,cell fill,dot ovality,angle of distortion,symbol contrast,quiet zone>

Note: The Quadrus Verifier does not have an **Output 3** option by default. If your application requires an Output 3, contact your Microscan sales representative for more information.

Good Read

Usage: **Good Read** is used when an application requires all symbol data to be transmitted. It's typically used in tracking applications in which each object is uniquely identified.

Definition: With **Good Read** enabled, the reader transmits symbol data on any good read regardless of **Matchcode Type** setting.

Note: A No Read can still be transmitted if enabled.

When to Output Symbol Data

Definition: This command allows the user to choose when symbol data can be sent to the host.

Serial Cmd: <**K705**,symbol data output status,**when to output**>

Default: **As Soon As Possible**

Options: **0 = As Soon As Possible** 1 = End of Read Cycle

As Soon As Possible

Usage: **As Soon As Possible** is useful in applications in which symbol data needs to be moved quickly to the host, typically when the host is making decisions based on symbol data.

Definition: Enabling **As Soon As Possible** causes symbol data to be sent to the host immediately after a symbol has been successfully decoded.

Note: More than one decode might in fact be required to qualify as a good read, depending on how **Decodes Before Output** is set.

End of Read Cycle

Usage: **End of Read Cycle** is useful in timing-based systems in which the host is not ready to accept data at the time it is decoded.

Definition: Enabling **End of Read Cycle** means that symbol data does not get sent to the host until the read cycle ends with a timeout or new trigger.

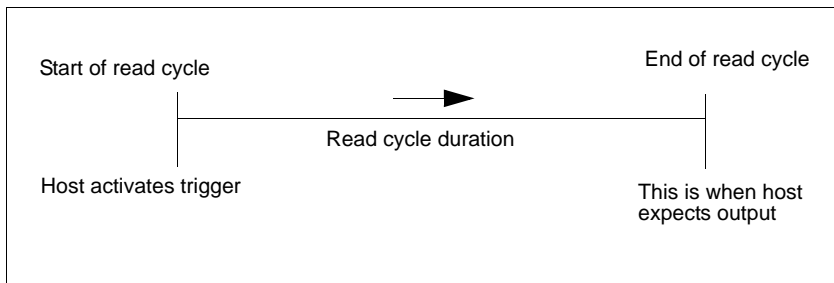

Read Cycle

No Read Message

Usage: Used in applications where the host needs serial verification that a symbol has not been read and especially useful in new print verification.

Definition: When enabled, and if no symbol has been decoded before timeout or the end of the read cycle, the No Read message will be transmitted to the host.

No Read Message Mode

Serial Cmd: <K714,**no read message status**,no read message>

Default: **Enabled**

Options: 0 = Disabled **1 = Enabled** 2 = Detailed No Read Message

Disabled

No message is output when a No Read condition occurs.

Enabled

The user-defined No Read message is output whenever a No Read condition occurs.

Detailed No Read Message

Important: In the case where the conditions set in **Bad/No Symbol Qualification** are met, then the **Bad Symbol** or **No Symbol** message output will override the **No Read Message** or the **Detailed No Read Message**, if either is enabled.

Usage: Use this option to cover more detailed reasons for decode failures.

Definition: Outputs a **No Read** message followed by an additional message (an Image Processing Results Code) indicating the reason a symbol failed to decode.

For example, in the following output: “No Read d_1, E_2” d and E are symbology ids for Datamatrix and UPC respectively. The message means that Datamatrix and UPC are enabled (and other symbologies are not), and that both failed to decode. The reason for the failing Datamatrix is 1 and the reason for the failing UPC is 2. The first part of these numbers (preceding the dot) is the relevant number and interpreted here:

2D Symbologies:

1. Failed to locate symbol (no finder pattern).
2. Failed to locate four corners or failed to qualify user-defined dimension (in pixels).
3. Failed to locate clocks or failed to qualify user-defined orientation (0-359 degree).
4. Failed to validate clocks or failed to qualify user-defined symbol size (clock element count).
5. Failed to decode symbol.

No Read Message

Linear Symbologies:

1. Failed user-defined minimum number of bars.
2. Failed to decode start/stop character (doesn't apply to UPC, RSS, MicropDF417 and Pharmacode).
3. Failed user-defined minimum number of scan lines that qualify for the minimum number of bars.
4. Failed to decode.
5. Failed to decode UPC supplemental.

No Read Message

Definition: Any combination of ASCII characters can be defined as the No Read message.

Serial Cmd: <**K714**,no read message status,**no read message**>

Default: **No Read**

Options: 0 to 128 ASCII characters.

Note: No Read Message will only be transmitted if **Symbol Data Output** is set to **Match**, **Mismatch** or **Good Read**.

No Read Message can be set to any ASCII characters except **NULL**, **<**, **,** or **>**.

Bad Symbol/No Symbol Qualification

Usage: Useful in determining if a symbol is present and if user-defined requirements for that symbol are met.

Definition: Sets the requirements that will qualify an object or a symbol before outputting a decode or message.

Bad Symbol Message

Usage: Can tell the user if a qualified symbol is present but not decodable.

Definition: When enabled, send a message to the host whenever an object meets the qualifications setup in **1D/Stacked Symbology Qualification** or **2D Symbology Qualification** but is not decoded.

Serial Cmd: <**K715**,[unused],**message**>

Default: **BAD_SYMBOL**

Options: Up to 128 ASCII characters (except **NULL**)

No Symbol Message

Usage: Can tell the user if a object does not qualify as a symbol.

Definition: When enabled, send a message to the host whenever an object meets the qualifications setup in **1D/Stacked Symbology Qualification** or **2D Symbology Qualification** but is not decoded.

Serial Cmd: <**K716**,[unused],**message**>

Default: **NO_SYMBOL**

Options: Up to 128 ASCII characters (except **NULL**)

1D/Stacked Symbology Qualification

Minimum Number of Bars

Definition: Sets the minimum number of bars to qualify linear symbols.

Serial Cmd: <**K717**,**minimum number of bars**,*minimum number of qualified scans,start/stop status*>

Default: **0**

Options: 0 to 255 (0 is disabled)

Minimum Number of Qualified Scan Lines

Definition: Sets the minimum number of scans that have the required number of bars set in **Minimum Number of Bars**.

Serial Cmd: <K717,minimum number of bars,**minimum number of qualified scans**,start and stop status>

Default: 0

Options: 0 to 11 (0 is disabled)

Start/Stop Status

Definition: When enabled, both **Start** and **Stop** characters need to be present to qualify as a decodable symbol. In the case of PDF417, only a **Stop or Stop** needs to be present.

Note: This parameter does not apply to UPC, Pharmacode, RSS and Micro-PDF417.

Serial Cmd: <K717,minimum number of bars,minimum number of qualified scans,**start and stop status**>

Default: Disabled

Options: 0 = Disabled 1 = Enabled

2D Symbology Qualification

Note: in the cases where **Symbol Size Status**, **Dimension Status**, or **Orientation Status** is enabled, the reader will always check the finder pattern regardless of **Finder Pattern Status** setting.

Finder Pattern Status

Definition: Checks for the presence of finder pattern.

Serial Cmd: <K718,**finder pattern status**,symbol size mode,symbol size 1,symbol size 2,symbol size tolerance,dimension mode,dimension 1,dimension 2,dimension tolerance,orientation mode,orientation value>

Default: Disabled

Options: 0 = Disabled 1 = Enabled

Symbol Size Mode (2D Symbology Qualification)

Note: if **Symbol Size 1** is larger than **Symbol Size 2**, it will be automatically reversed in the algorithm.

Definition: Specifies the outputs resulting from the results of searches for **Symbol Size 1** and **Symbol Size 2**.

Serial Cmd: <**K718**,finder pattern status,**symbol size mode**,symbol size 1,symbol size 2,symbol size tolerance,dimension mode,dimension 1,dimension 2,dimension tolerance,orientation mode,orientation value>

Default: **Disabled**

Options: **0 = Disabled**

1 = Bad/No Symbol Output

2 = Object Qualification

3 = Enable Both

Disabled

Decoded messages are output, but no attempt to qualify symbols or output **Bad** or **No Symbol** messages is undertaken.

Bad Symbol/No Symbol Output

Checks first for decodes. If no symbol is decoded, checks for symbol size. If both **Symbol Size 1** and **Symbol Size 2** requirement are met, a **Bad Symbol** message is output. If both are not met, outputs a **No Symbol** message.

Object Qualification

Checks first for matches to symbol size. If qualified, attempts to decode. If no decodes are found within the specified read cycle parameters, outputs a **No Read** message.

Enable Both

Same as **Object Qualification**, except that if no objects qualify, then a **No Symbol** message is output; if at least one object qualifies, then a **Bad Symbol** message is output.

Symbol Size 1 (2D Symbology Qualification)

Definition: Checks for symbol sizes for a specified number of elements. In the case of rectangular symbols, checks the longer side.

Serial Cmd: <**K718**,finder pattern status,symbol size status,**symbol size 1**,symbol size 2,symbol size tolerance,dimension mode,dimension 1,dimension 2,dimension tolerance,orientation mode,orientation value>

Default: **10**

Options: 8 to 88 elements

Symbol Size 2 (2D Symbology Qualification)

Definition: Checks for symbol sizes for a specified number of elements. In the case of rectangular symbols, checks the shorter side.

Serial Cmd: <**K718**,finder pattern status,symbol size status,symbol size 1,**symbol size 2**,symbol size tolerance,dimension mode,dimension 1,dimension 2,dimension tolerance,orientation mode,orientation value>

Default: **10**

Options: 8 to 88 elements

Symbol Size Tolerance (2D Symbology Qualification)

Definition: Sets the allowable deviation, up or down, for symbol sizes specified in **Symbol Size 1** and **Symbol Size 2**.

Serial Cmd: <**K718**,finder pattern status,symbol size status,symbol size 1,symbol size 2,**symbol size tolerance**,dimension mode,dimension 1,dimension 2,dimension tolerance,orientation mode,orientation value>

Default: **2**

Options: 0 to 10

Dimension Mode (2D Symbology Qualification)

Definition: Enables the searches for symbol **Dimension 1** and **Dimension 2**.

Serial Cmd: <**K718**,finder pattern status,symbol size status,symbol size 1,symbol size 2,symbol size tolerance,**dimension mode**,dimension 1,dimension 2,dimension tolerance,orientation mode,orientation value>

Default: **Disabled**

Options: **0 = Disabled**

1 = Bad/no symbol output

2 = Object qualification

3 = Enable both

Disabled

Decoded messages are output, but no attempt to qualify symbols or output **Bad** or **No Symbol** messages is undertaken.

Bad/No Symbol Output

Checks first for decodes. If no symbol is decoded, checks for symbol dimension. If both **Dimension 1** and **Dimension 2** requirements are met, a **Bad Symbol** message is output. If both are not met, outputs a **No Symbol** message.

Object Qualification

Checks first for matches to symbol dimension. If qualified, attempts to decode. If no decodes are found within the specified read cycle parameters, outputs a **No Read** message.

Enable Both

Same as **Object Qualification**, except that if neither **Dimension 1** nor **Dimension 2** qualifies, then a **No Symbol** message is output; if either **Dimension 1** or **Dimension 2** qualifies, then a **Bad Symbol** message is output.

Dimension 1 (2D Symbology Qualification)

Definition: Checks symbol dimension for a specified number of pixels. In the case of rectangular symbols, checks the longer side.

Serial Cmd: <**K718**,finder pattern status,symbol size status,symbol size 1,symbol size 2,symbol size tolerance,dimension mode,**dimension 1**,dimension 2,dimension tolerance,orientation mode,orientation value>

Default: **0**

Options: 0 to 656 pixels

Dimension 2 (2D Symbology Qualification)

Definition: Checks symbol dimension for a specified number of pixels. In the case of rectangular symbols, checks the shorter side.

Serial Cmd: <**K718**,finder pattern status,symbol size status,symbol size 1,symbol size 2,symbol size tolerance,dimension mode,dimension 1,**dimension 2**,dimension tolerance,orientation mode,orientation value>

Default: **0**

Options: 0 to 656 pixels

Dimension Tolerance (2D Symbology Qualification)

Definition: Sets the allowable deviation, in percentage, for symbol sizes specified in **Dimension 1** or **Dimension 1**.

Serial Cmd: <**K718**,finder pattern status,symbol size status,symbol size 1,symbol size 2,symbol size tolerance,dimension mode,dimension 1,dimension 2,**dimension tolerance**,orientation mode,orientation value>

Default: **10**

Options: 0 to 100

Orientation Mode (2D Symbology Qualification)

Definition: Sets the orientation value.

Serial Cmd: <**K718**,finder pattern status,symbol size status,symbol size 1,symbol size 2,symbol size tolerance,dimension mode,dimension 1,dimension 2,dimension tolerance,**orientation mode**,orientation value>

Default: **Disabled**

Options: **0 = Disabled**

1 = Bad/no symbol output

2 = Object qualification

3 = Enable both

Disabled

Decoded messages are output, but no attempt to qualify symbols or output **Bad** or **No Symbol** messages is undertaken.

Bad/No Symbol Output

Checks first for decodes. If no symbol is decoded, checks for symbol orientation. If **Orientation Value** is satisfied, a **Bad Symbol** message is output. If not satisfied, outputs a **No Symbol** message.

Object Qualification

Checks first for matches to symbol **Orientation Value**. If qualified, attempts to decode. If no decodes are found within the specified read cycle parameters, outputs a **No Read** message.

Enable Both

Same as **Object Qualification**, except that if **Orientation Value** is satisfied but the symbol is not decoded, then a **Bad Symbol** message is output; if **not** satisfied, outputs a **Bad Symbol** message.

Orientation Value

Usage: Instructs the reader to ignore symbols not in the specified orientation.

Definition: Sets the orientation of the symbol, in degrees clockwise from the default **0** orientation.

For Data Matrix symbols, sets the finder "L" pattern, with the adjacent being an example of the default **0** orientation.

For QR Code, sets the locator pattern (three squares), with the adjacent being an example of the default **0** orientation.

The other position settings will rotate clockwise from the defaults shown above.

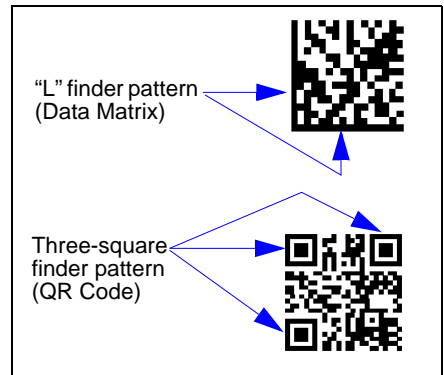

Serial Cmd: **<K718,finder pattern status,symbol size status,symbol size 1,symbol size 2,symbol size tolerance,dimension mode,dimension 1,dimension 2,dimension tolerance,orientation mode,orientation value>**

Default: **0**

Options: 0 to 359

Note: A symbol's orientation can miss the precise **Orientation Value** by several degrees and still be qualified. To be certain of the extent of the allowable tolerance, you should experiment with symbols in various orientations. In no case can they be more than 45° from the assigned orientation value and still be qualified.

Read Duration Output

Usage: Useful in evaluating actual read cycle timing results, especially when initially setting up an application to determine maximum line speed that can be obtained based on the spacing between symbols.

Definition: When enabled, the duration of the read cycle (in milliseconds) is appended to the symbol data.

The read duration is the time from the beginning of the read cycle until data is output.

Read Duration Output Mode

Serial Cmd: <K706, **status**, separator>

Default: **Disabled**

Options: **0 = Disabled**

1 = Enabled

Important: To measure the entire read cycle when in **External Level** trigger mode, set **When to Output Symbol Data** to **End of Read Cycle**.

This output can measure over **49** days worth of duration; if exceeded, the **OVERFLOW** message will be output in place of the duration.

Options: 0 = Disabled 1 = Enabled

Read Duration Output Separator

Definition: User-defined character that separates the symbol information from the **Read Duration Output**.

Serial Cmd: <K706, status, **separator**>

Default: **[space character]**

Options: Any ASCII character

Output Indicators

The Quadrus Verifier has a beeper and LED arrays, arranged as follows.

Target Pattern

- Usage:** Assists users in positioning and locating symbols in the center of the reader's FOV.
- Definition:** The user can control when the targeting system is **ON** or **OFF** and save this condition for power-on.
- Serial Cmd:** `<K750,green flash mode,target pattern status,green flash duration>`
- Default:** **Always OFF**
- Options:** **0 = Always OFF**
 1 = ON when NOT in the read cycle
 2 = ON when in the read cycle
 3 = Always ON

Important: The targeting system actuated by the **EZ** button or operational command overrides this setting.

Always OFF

The target pattern will remain **OFF** at all times unless overridden by the **EZ** button or operational command.

On When NOT In Read Cycle

The target pattern is always **ON** except during the read cycle. If the **EZ** button or operational command overrides this setting, the target pattern will remain on at all times.

On When in the Read Cycle

The target pattern will remain **OFF** except during the read cycle. If the **EZ** button or operational command overrides this setting, the target pattern will remain on at all times.

Always ON

The target pattern is always **ON**.

Green Flash Mode

Usage: Used as a visual verification that a good read has occurred.

Definition: An array of green LEDs in the front of the Quadrus Verifier can be programmed to flash briefly in response to user-defined conditions, or if in **Static Presentation** mode, illuminate for a set period of time.

Serial Cmd: `<K750,green flash mode,target pattern status,green flash duration>`

Default: **Good Read**

Options: 0 = Disabled **1 = Good Read**
2 = Static Presentation **3 = Match**
4 = Mismatch

Disabled

Green flash LEDs are disabled.

Good Read (Green Flash)

Green flash LEDs will flash for less than one second when a good read condition is met or when matchcode is enabled and a match occurs.

Static Presentation (Green Flash)

Static Presentation is used in conjunction with **Continuous Read** mode.

When operating in **Static Presentation** mode, the red LEDs will illuminate while the Quadrus Verifier is searching for a symbol in **Continuous Read** mode. When a symbol is placed in the FOV and a good read occurs, the green LEDs will illuminate and stay on for the duration of time set in **Green Flash Duration**. Only one read will occur during that time unless more than one symbol is enabled in **Number of Symbols**.

Note: If **Static Presentation** mode is selected but the reader is not in **Continuous Read**, the **Green Flash** will revert to **Good Read** mode.

To use Static Presentation:

1. Enable **Continuous Read**.
2. Select the number of symbols.
3. Enable **Static Presentation** in **Green Flash Mode**.
4. Select the read time in **Green Flash Duration**.

Note: **Green Flash Duration** values only take effect in **Static Presentation Mode**.

Match (Green Flash)

Green flash LEDs will flash for less than 1 second when a match condition is met. If multisymbol is enabled, then green flash LEDs will illuminate only if all symbols qualify as a match. If matchcode is disabled, then this mode will activate the LED's on a good read.

Mismatch (Green Flash)

Same as **On Match** except it illuminates on a mismatch.

Green Flash Duration

- Usage:** A visual verification that a good read has occurred.
- Definition:** When a good read occurs, the Green flash LED's will illuminate and stay on for the time set for the **Green Flash Duration** value.
- Serial Cmd:** **<K750,green flash mode,target pattern status,green flash duration>**
- Default:** **100** (1 second)
- Options:** 0 to 65535 (in 10mS increments)
- Note:** Green Flash Duration values only take effect in Static Presentation Mode.

Beeper

- Usage:** An audible verification that either a good read or a No Read has occurred.
- Definition:** A beep is emitted either after each good read or No Read.
- Serial Cmd:** **<K702,beeper status>**
- Default:** **Good Read**
- Options:** 0 = Disabled
1 = Good Read
 2 = No Read

Note: Beeper will also sound if any of the following occur:

- The reader is defaulted.
- A send/save command from **ESP** or an **Exit** command from any embedded menu.
- A calibration routine is completed.
- A **<Z>**, **<Zp>**, **<Zd>**, or **<K701,1>** command is sent.

Serial Verification

Allows the user to verify configuration command status.

Serial Command Echo Status

Usage: This command is useful in removing any doubt about the reader's interpretation of any configuration command.

For example, if the current preamble is "SOM" and **<K701,1,START>** is entered, the reader will echo back **<K701, SOM>** since the attempted entry "START" exceeds the four character limit for that command. Therefore it is rejected and the existing "SOM" message is echoed back and remains the preamble message.

Definition: When enabled, a configuration command received from the host is echoed back to the host with the resultant settings.

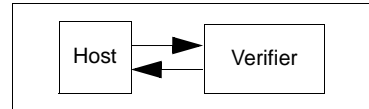

Function: If a command with multiple fields is processed, some of the fields may have been processed properly while others were not. The changes will appear in the string echoed back so that the user will know which fields did or did not change.

Serial Cmd: **<K701, serial command echo status, serial command beep status, control/ hex output>**

Default: **Disabled**

Options: **0 = Disabled** 1 = Enabled

Serial Command Beep Status

Usage: Used to audibly verify the acceptance and validity of a command.

Definition: Causes the reader to beep once whenever a K command is entered to indicate that the command was accepted and processed.

Function: If an invalid command is entered, the reader beeps 5 times to indicate an invalid entry. However, this does not necessarily mean that all data fields have been entered incorrectly. Only one bad field needs to be found in order to activate the 5 beep response.

Serial Cmd: **<K701, serial command echo status, serial command beep status, control/ hex output>**

Default: **Disabled**

Options: **0 = Disabled** 1 = Enabled

Control/Hex Output

- Usage:** Useful for viewing settings with binary characters when using serial command on a terminal.
- Definition:** Determines the response to an **Serial Command Echo** or status request command.
When set to **Control**, two characters are transmitted to represent a non-displayable character. For example, a carriage return will be shown as the two characters: **^M**.
When set to **Hex**, the output is the hex character.
- Serial Cmd:** *<K701, serial command echo status, serial command beep status, **control/hex output**>*
- Default:** **Control**
- Options:** **0 = Control** 1 = Hex

Video Output

Usage: Useful for remote visual confirmation and review of images.

Definition: Configures the operation of video output of RS170 standard video monitors. Video source is configured via the **Active Camera** command **<K240>**.

The video output can be confined to a single event such as a good read or can be fed as continuous live video.

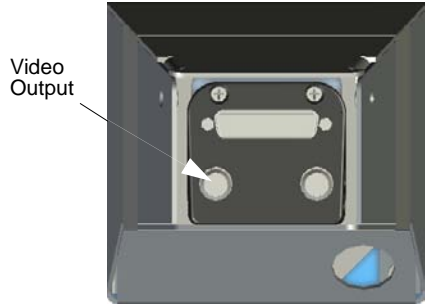

Video Output Status

Serial Cmd: **<K760,video output status,trigger image mode,image frame>**

Default: **Live (Real Time)**

Options: 0 = Disabled 1 = Triggered **2 = Live (Real Time)**

Disabled

When selected the video output is disabled.

Triggered

Usage: Ideal for dynamic applications.

Definition: Outputs specific capture to the video output port as per the setting in **Trigger Image Mode**.

Live (Real Time)

Note: Whenever the **Locate** mode (target pattern) is activated by the **EZ** button, **Live** video will automatically be enabled.

Usage: **Live** output is useful during initial setup in locating symbols in the field of view in real time.

Definition: The video output is configured for a real-time operating mode and is refreshed with every video frame. If used in conjunction with **Dual Camera** mode, video will only output from the internal camera.

Note: When **Live** video mode is active, in order to synchronize with the video format, a shutter time of 1/1000 is the slowest shutter speed setting that can be applied to the camera settings. Slower shutter speeds will disable the video output.

Trigger Image Mode (Video Output)

Definition: Event which triggers a video output.

Serial Cmd: <K760, video output status, **trigger image mode**, image frame>

Default: **Last Capture**

Options: **0 = Last Capture**
1 = Good Read
2 = No Read
3 = Slide Show
4 = Selected Capture

Last Capture

At the end of a triggered read cycle, the video output will be the last capture.

Good Read

At the end of a triggered read cycle, the video output will be the last good read capture.

Note: If a good read does not occur, there is no video output.

No Read

At the end of a triggered read cycle, the video output will be the last No Read capture.

Slide Show

At the end of a triggered read cycle, all of the captures taken in the read cycle will be output at a rate of 350mS between captures. The last capture will be held for 700mS and then the cycle will be repeated.

Note: This only functions in a triggered mode.

Selected Capture

At the end of a triggered read cycle, the video output will be the capture specified in the **Capture Number** field.

Image Frame (Video Output)

Definition: Specifies the image frame that will be output at the end of the read cycle.

Serial Cmd: <K760, video output status, trigger image mode, **image frame**>

Default: **1**

Options: 1 to 5

Image Output

- Usage:* Useful for remote visual examination and review of images.
- Definition:* Outputs an image file when a specified condition (good read or No Read) is met. The video output can be confined to a single event such as a good read or can be fed as continuous live video.
- Serial Cmd:* **<K739,image output status,com port,file format,JPEG quality>**
- Default:* **Disabled**
- Options:* **0 = Disabled**
1 = Good Read
2 = No Read
3 = Good Read and No Read

Disabled

No image file will be output at the end of the read cycle.

Good Read (Image Output)

- Usage:* Provides a visual record for comparison.
- Definition:* If a **Good Read** condition is met, the image file of the first good read image will be output, immediately following the read cycle output + postamble. In order for a good read condition to occur all symbols must qualify in the read cycle.

No Read (Image Output)

- Usage:* Provides visual representation to identify quality issues with No Read images.
- Definition:* If a **No Read** occurs, the image file of the first No Read image will be output, immediately following the read cycle output + postamble.

Conditions where an image will not be output:

- The Verifier was expecting two symbols in the same image capture but only one was read.
- The image had a good read present and therefore would not be considered a No Read image.

Good Read and No Read (Image Output)

- Usage:* Provides a visual record for comparison and allows the user to identify quality issues with No Read images.
- Definition:* The image file of the first **Good Read** image and the first **No Read** image will be output immediately following the read cycle output + postamble.

Communications Port (Image Output)

Definition: The communications port to which the image will be sent.

Serial Cmd: <**K739**, image output mode, **com port**, file format, JPEG quality>

Default: **Host**

Options: **0 = Host** 1 = Aux 2 = Network

File Format (Image Output)

Definition: File format of the output image.

Serial Cmd: <**K739**, image output mode, com port, **file format**, JPEG quality>

Default: **JPEG**

Options: 0 = Bitmap **1 = JPEG** 2 = Binary

Bitmap

Outputs the image in a bitmap format.

JPEG

Outputs the image in a JPEG format.

Binary

Outputs the image in a raw binary format.

JPEG Quality (Image Output)

Definition: Determines the relative quality of the JPEG image sent, with 100 being the highest quality.

Serial Cmd: <**K739**, image output mode, com port, file format, **JPEG quality**>

Default: **90**

Options: 1 to 100 (where 100 is the highest quality)

Image Captioning

Usage: Useful in verifying data output visually in real time.

Definition: Overlays text onto the specified image. The text displayed is dependent on the captioning mode that is enabled. The text captioning is overlaid onto the image frame that is output to the video port, and will be displayed on the uploaded image for that image frame as well. If more than one image frame is available in a read cycle, the image frame selected by the triggered video mode will be displayed. When the **Slide Show** video mode is enabled the text is overlaid onto every image frame prior to being output to the video port, so every image will have overlay text when uploaded.

Serial Cmd: **<K762,mode>**

Default: **Disabled**

Options: **0 = Disabled**

- 1 = Read Cycle Results
- 2 = Statistic Mode 1 (counts)
- 3 = Statistic Mode (timing)

Important Notes:

- If triggered video is not enabled this feature is disabled regardless of the mode setting.
- Only 26 characters can be displayed per line, and only 2 lines of data will be displayed. If the data string is longer than this, it will be truncated.
- 1 line of captioning takes approximately 125ms to complete overlay. Therefore, for 2 lines of overlay an additional 250ms of overhead will have to be added to the read cycle duration.

Disabled

Image captioning is disabled.

Read Cycle Results (Image Captioning)

When enabled the results of the read cycle will be overlaid onto the triggered video image in the upper left hand corner. This will include Symbol data, No Read message(s) (if enabled), and any displayable formatting such as pre-amble, postamble, and Symbol ID.

Statistic Mode 1 (counts) (Image Captioning)

Outputs trigger count, image frame number, decode status, running read rate, good read/match count, No Read count, and mismatch count. Count values are total number since reset.

Format:

DECODE **T/XXXXX V/XXXXX**
XXX% **F/X** **N/XXXXX**

Where:

DECODE = Decode status: "DECODE" or "NOREAD"
 T/ = Trigger count 0 - 65535 (5 digits)
 V/ = Good read / Match
 count 0 - 65535 (5 digits)
 % = Read rate 0 - 100 (3 digits)
 F/ = Image frame number 0 - 7 (1 digit)
 N/ = No Read count 0 - 65535 (5 digits)
 X/ = Mismatch count 0 - 65535 (5 digits)

Important:

- If **Match Code** is disabled, the **Mismatch** count will not be displayed.
- Read rate is calculated as a running average.

Statistic Mode 2 (timing) (Image Captioning)

Indicates timing information including processing time required for displayed image and total read cycle time. Also included is Decode status and image frame number.

Format:

TOTAL READ TIME = XXXXX ms (if decoded) or **STATUS** (if a No Read)
F/X READ CYCLE = XXXXX ms

Where:

Total Read Time = Processing time required for displayed image (1ms resolution).
 1 to 65535ms (up to 5 digits)
 Status = Decode status is a No Read
 F/ = Image frame number 0 - 7 (1 digit)
 Read Cycle = Total read cycle time (1ms resolution).
 1 to 65535ms (5 digits)

Synchronous Trigger

- Usage:* Helps center the image on the video display.
- Definition:* Configures the image capture trigger to be synchronous with the video frame to allow for stable video during image capture events.
- Serial Cmd:* **<K761,synchronous trigger mode>**
- Default:* **Disabled**
- Options:* **0 = Disabled**
1 = Enabled

Disabled

When disabled, the trigger event for an image capture is asynchronous with the video frame. This means that when a trigger occurs, the video timing is reset and an image capture occurs immediately. This causes flickering in an output monitor during image captures because video timing needs to resync every time the video signal is reset.

Enabled (Synchronous Trigger)

When enabled, the trigger event for an image capture is synchronous with the video frame. This means that when a trigger occurs the image captured is not released until the start of the next video frame, which occurs every 16.68ms. The video timing never changes and no effect is seen during image captures on the video monitor.

Restrictions

When the **Synchronous Trigger** mode is enabled, it will not take effect unless the following conditions are met:

1. Shutter selection is 1/1200 or faster.
2. Live Video Mode is in effect.

Application Notes

1. If a **Rapid Capture** trigger mode is enabled, the timing on the trigger will change when **Synchronous Trigger** mode is enabled, and will probably not be sufficient for most applications. This is because the trigger can have up to a 16ms delta from the time the trigger is issued until the image capture occurs. Thus the trigger timing will not be stable and should not be used in a dynamic applications.
2. If the IP database is being used in a **Continuous Capture** mode, the capture sequence is sequential and no longer double buffered. Thus a capture cannot occur until the previous frame has been processed and up to a 16ms delay can be introduced between image captures.
3. In a **Continuous** trigger, **Continuous Capture**, or read rate mode, the decode speed should not be affected (while using the synchronous trigger mode) since a double buffer format is used for image capturing. The only time a slow down should be noticed in these modes is when the decode time is less than the capture time. Capture time = 16ms.

EZ Button

The **EZ** button has four positions, selectable by the length of time that the button is held down and indicated by one, two, three, and four beeps in succession. Each position can be programmed for any of eight options.

Definition: Serves as a master switch to enable/disable the **EZ** button status.

Serial Cmd: **<K770,global status,default on power-on,load IP database,save for power-on>**

Default: **Enabled**

Options: 0 = Disabled **1 = Enabled** 2 = Trigger

Disabled

When set to **Disabled**, the **EZ** button is disabled.

Enabled

When selected, the **EZ** button is enabled and the function of each button position is selected by the **EZ Button Mode** command.

Trigger Mode (EZ Button)

When selected, the **EZ** button acts as a trigger for the reader to start and end read cycles. All other button operations are inactive.

In External Level: The read cycle endures for as long as the **EZ** button is pressed, unless a timeout occurs and **Timeout** is enabled for **End Of Read Cycle**.

In External Edge: As with Level, Edge allows a read cycle to be initiated by pressing the button, but unlike level mode, the read cycle ends with a good read output, a timeout, or a new trigger.

Default on Power-On (EZ Button)

Definition: When enabled, if the **EZ** button is held down on power-on the reader will default to customer defaults and saved for power-on. This is the same as sending a **<Zrc>** command.

Serial Cmd: **<K770,global status,default on power-on,load IP database,save for power-on>**

Default: **Enabled**

Options: 0 = Disabled **1 = Enabled**

Load IP Database (EZ Button)

Definition: Allows the user to load the IP database with calibration results. When the user performs a calibration using the **EZ** button, all the database entries are moved down one index and the results of the calibration are saved to index **0**. Note the results will be saved as current settings as well.

Serial Cmd: <**K770**,global status,default on power-on,**load IP database**,save for power-on>

Default: **Enabled**

Options: 0 = Disabled **1 = Enabled**

Save for Power-On (EZ Button)

Definition: If enabled, after calibration is complete, all parameters will be saved for power-on.

Serial Cmd: <**K770**,global status,default on power-on,load ip database,**save for power-on**>

Default: **Disabled**

Options: **0 = Disabled** 1 = Enabled

EZ Button Modes

Usage: Useful for performing multiple, repetitive tasks at the work site.

Definition: Allows user to program each of **EZ** button's 4 positions from a selection of 8 modes.

Serial Cmd: <**K771**, position 1 mode, position 2 mode, position 3 mode, position 4 mode>

Options:

Single Beep	Two Beeps	Three Beeps	Four Beeps
0 = Disabled	0 = Disabled	0 = Disabled	0 = Disabled
1 = Read rate	1 = Read rate	1 = Read rate	1 = Read rate
2 = Calibrate	2 = Calibrate	2 = Calibrate	2 = Calibrate
3 = Save for power on	3 = Save for power on	3 = Save for power on	3 = Save for power on
4 = Unused	4 = Unused	4 = Unused	4 = Unused
5 = Load new master	5 = Load new master	5 = Load new master	5 = Load new master
6 = Unused	6 = Unused	6 = Unused	6 = Unused
7 = Target system	7 = Target system	7 = Target system	7 = Target system
8 = Live Video	8 = Live Video	8 = Live Video	8 = Live Video
9 = Bar Code Config.	9 = Bar Code Config.	9 = Bar Code Config.	9 = Bar Code Config.

Disabled

When set to disabled, the associated button position will have no function associated with it, and the position will be skipped over.

Read Rate

Read rate will be initiated when the associated button position is selected. Read rate will perform decodes/second and is the same as sending a <**C**> from the terminal. To exit read rate mode quickly press and release the **EZ** button.

Calibrate

Calibration will be initiated when the associated button position is selected. To abort calibration, quickly press and release the **EZ** button.

Save for Power On

All reader settings will be saved to non-volatile memory to be recalled on power-on whenever the associated button position is selected. This is the same as sending the <**Z**> in the terminal.

Load New Master

Functions the same as new master pin input whenever the associated button position is selected. The new master pin's **Consecutive Decode** requirement holds true for this function.

Target System

Turns on the targeting system (target pattern) whenever the associated button position is selected. To disable, quickly press and release the **EZ** button.

Note: This mode is the only one that does not require that the button be released before taking effect. Thus, as soon as the Verifier beeps the appropriate number of times for the position, it will take effect. If it is necessary to have the target system on before another operation such as calibration or read rate is performed, ensure that the target system mode is assigned a lower position so that it will be activated first.

Live Video

Enables live video mode when the associated button position is selected. To disable, quickly press and release the **EZ** button.

Important: If the user has a non-video unit and this mode is selected, it will behave the same as if the mode was disabled.

Bar Code Configuration

Enables bar code configuration mode whenever the associated button position is selected. When enabled, the reader can accept configuration commands from symbols. To disable, quickly press and release the **EZ** button.

EZ Button Operation

To execute **EZ** button commands,

Single Beep (Position #1)

Hold down button until a single beep is heard (and the 20% LED illuminates).

Two Beeps (Position #2)

Hold down button until two quick beeps are heard (and the 20% and 40% LEDs illuminate).

Three Beeps (Position #3)

Hold down button until three quick beeps are heard (and the 20%, 40% and 60% LEDs illuminate).

Four Beeps (Position #4)

Hold down button until four quick beeps are heard (and the 20%, 40%, 60% and 80% LEDs illuminate).

Input 1

Usage: For example, an application is set up so that a mismatch stops the production line by using outputs in a latch mode. A push button switch can be connected to the input pin so that when pressed, it unlatches the output, allowing the line to resume operations.

Definition: A programmable, discrete input used to reset counters, outputs or control optoelectrical settings.

Serial Cmd: <K730, **input mode**, active state>

Default: **Disabled**

Options: **0 = Disabled** 1 = Reset Counts 2 = Unlatch Output

Disabled

Definition: When set to **Disabled** there is no effect on operation.

Reset Counts

Usage: Primarily used in test mode. Can also be used to reset counters daily.

Definition: When set to **Reset Counts**, a transition to the active state of the input will cause the reader to reset the internal counters.

Unlatch Output

Definition: This setting is used in combination with any of the three discrete outputs that are in **Unlatch Mode 1**. A transition to the active state will clear any of the three outputs that were previously latched.

Active State (Input)

Definition: Sets the active level of the input pin.

Serial Cmd: <K730, input mode, **active state**>

Default: **Active Off**

Options: 0 = Active On (same as active closed)
1 = Active Off (same as active open)

Output 1 Parameters

[-] Output 1 Parameters	
Output On	Diagnostic Warning
Output State	Normally Open
Pulse Width	5
Output Mode	Pulse
+ Trend Analysis	
+ Symbol Quality (ISO 15415)	
+ Symbol Quality (A59132A)	
+ Diagnostics	

Usage: This option provides switching to host software to control external devices such as PLCs and relays. It is useful for routing and sorting and to prevent mis-packaging and mis-routing.

Definition: Sets the discrete output functions for specific user-selected conditions.

Output On (Output 1)

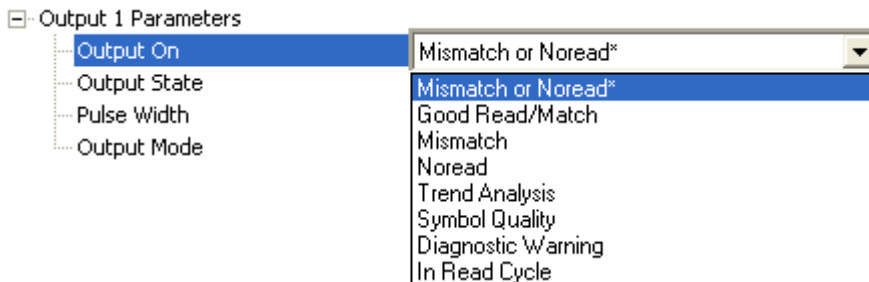

Definition: Allows the user to set the conditions under which an output (or outputs) will be activated.

Serial Cmd: <K810, **output on**, output state, pulse width, output mode>

Default: **Mismatch or No Read**

Options:

0 = Mismatch Or No Read	1 = Good Read/Match
2 = Mismatch	3 = No Read
4 = Trend Analysis	5 = Symbol Quality
6 = Diagnostic Warning	7 = In Read Cycle

Note: If **Output On** is set to **Mismatch Or No Read**, **Match**, or **Mismatch**, a transition (switching) will not occur unless **Matchcode Type** is enabled and a master symbol is loaded into memory.

Mismatch or No Read (Output On)

Activates discrete output when the data does not match that of the master symbol or the symbol has not been decoded before the end of the read cycle.

Good Read/Match (Output On)

Activates a discrete output when the symbol data matches the master symbol.

Note: If you want to output for a good read and **Matchcode** is not enabled, you can enable any output for **Match**.

Mismatch (Output On)

Activates a discrete output when the symbol data does not match that of the master symbol.

No Read (Output On)

Activates a discrete output whenever the symbol data is not decoded before the end of the read cycle.

Trend Analysis (Output On)

Activates discrete output when a trend analysis condition is met, depending on the trend analysis option enabled.

Symbol Quality (Output On)

Activates discrete output when a symbol quality condition is met, depending on the symbol quality option enabled.

Diagnostic Warning (Output On)

Activates discrete output when a trend analysis condition is met, depending on the trend analysis option enabled.

In Read Cycle (Output On)

Output is active while reader is operating in the read cycle.

Output State (Output 1)

[-] Output 1 Parameters

Output On	Mismatch or Noread
Output State	Normally Open*
Pulse Width	Normally Open*
Output Mode	Normally Closed

Definition: Sets the active electrical state of the discrete output.

Serial Cmd: <**K810**,output on,output state,pulse width,output mode>

Default: **Normally Open**

Options: **0 = Normally Open** 1 = Normally Closed

Pulse Width (Output 1)

[-] Output 1 Parameters

Output On	Mismatch or Noread
Output State	Normally Open
Pulse Width	0.050 Seconds
Output Mode	Pulse

Definition: Sets the time in 10 ms increments that the discrete output remains active.

Serial Cmd: <**K810**,output on,output state,pulse width,output mode>

Default: **5** (Corresponds to .05 seconds)

Options: 0 to 255 (0 to 2.55 seconds). Divide the number entered on the command line by 100 for time in seconds.

Output Mode (Output 1)

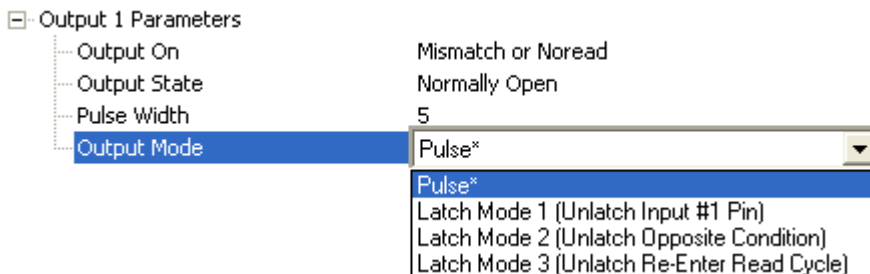

Definition: Sets the condition in which the discrete output is de-activated.

Serial Cmd: <K810,output on,output state,pulse width,**output mode**>

Default: **Pulse**

Options: **0 = Pulse**

1 = Latch Mode 1 (Unlatch Input # 1 Pin)

2 = Latch Mode 2 (Unlatch Opposite Condition)

3 = Latch Mode 3 (Unlatch Re-Enter Read Cycle)

Pulse

This is the default mode of operation in which the programmable output is activated when the **Output On** condition has been met and held active for the duration of the selected pulse width.

Latch Mode 1 (Unlatch Input # 1 Pin)

The programmable output is active when the **Output On** condition has been met and held active until the discrete **Input 1** has been activated.

Latch Mode 2 (Unlatch Opposite Condition)

The programmable output is activated when the **Output On** condition has been met and held active until the opposite condition selected under **Output On** has been met.

For example, if **No Read** is enabled under **Output On**, the programmable output will go active upon a No Read and remain active until the opposite condition, a good read, occurs.

Latch Mode 3 (Unlatch Re-Enter Read Cycle)

The programmable output is active when the **Output On** condition has been met and is held active until a new read cycle begins.

Trend Analysis (Output 1)

Note: **Output On** under **Output 1 Parameters** must be set to **Trend Analysis** for this output to function.

[-] Output 1 Parameters	
[-] Output On	Trend Analysis
↓	
[-] Output 1 Parameters	
[-] Output On	Trend Analysis
[-] Output State	Normally Open
[-] Pulse Width	5
[-] Output Mode	Pulse
[-] Trend Analysis	
[-] Trend Analysis Mode	Noread
[-] Number of Triggers	0
[-] Number to Output On	0

Usage: Useful in cases in which the user doesn't want to shut down for one condition but wants to monitor quality and read conditions.

Definition: Applies **Trend Analysis** settings to **Output 1**.

With **Trend Analysis**, the user can track the occurrences and frequency of mismatches, No Reads, and the number of reads per trigger and output the results to any of three outputs.

Example: Trend analysis mode = No Read

Number of Triggers = 25

Number to Output On = 4

In this example, the reader would activate an output when 4 No Reads occurred within a period of 25 triggers (read cycles).

Trend Analysis Mode (Trend Analysis)

Definition: Sets the trend condition (**Mismatch**, **No Read**, or **Reads/Trigger**) that will activate the output.

Serial Cmd: <**K780**, *trend analysis mode*, number of triggers, number to output on>

Default: **No Read**

Options: 0 = Mismatch **1 = No Read** 2 = Unused
3 = Bad Symbol 4 = No Symbol

Mismatch

Output will be activated when the number of **Mismatches** equals the value entered for **Number to Output On** within the trigger window selected in **Number of Triggers**.

No Read

Output will be activated when the number of No Reads equals the value entered for **Number to Output On** within the trigger window selected in **Number of Triggers**.

Bad Symbol

Output will be activated when the number of **Bad Symbol** occurrences equals the value entered for **Number to Output On** within the trigger window selected in **Number of Triggers**.

No Symbol

Output will be activated when the number of **No Symbol** occurrences equals the value entered for **Number to Output On** within the trigger window selected in **Number of Triggers**.

Number of Triggers (Trend Analysis)

Definition: The number of triggers to examine for the trend analysis condition.

Serial Cmd: <**K780**,trend analysis mode,**number of triggers**,number to output on>

Default: **0**

Options: 0 to 255

Number to Output On (Trend Analysis)

Definition: Sets the number of **Trend Analysis Mode** events (mismatches, No Reads or reads/trigger as configured by **Trend Analysis Mode**) to occur within the trigger evaluation time period before activating the associated output.

For example, if **Number to Output On** is set to 3 and **Trend Analysis Mode** is set to **No Read**, then the output will not be activated until 3 No Reads have occurred.

Serial Cmd: <**K780**,trend analysis mode,number of triggers,**number to output on**>

Default: **0**

Options: 0 to 255

ISO/IEC 15415 Symbol Quality (Output 1)

Note: Output On under Output 1 Parameters must be set to Symbol Quality for this output to function.

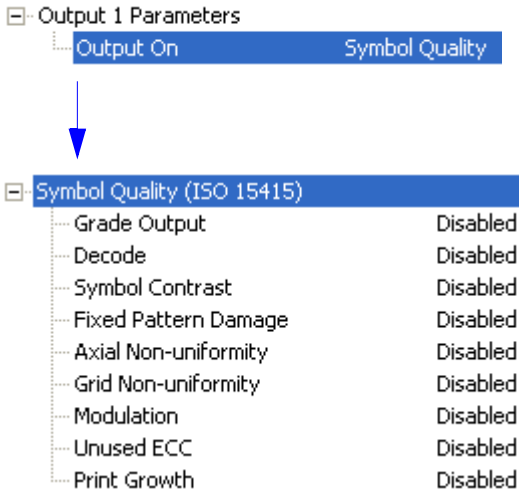

All ISO/IEC 15415 Symbol Quality parameters except **Print Growth** feature the alphanumeric grade options shown below. If the decoded symbol's grade falls below the selected threshold grade, the output will activate.

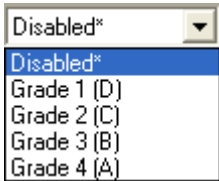

Grade (ISO/IEC 15415 Symbol Quality)

Serial Cmd: `<K830,grade,decode,symbol contrast,fixed pattern damage,axial non-uniformity,grid non-uniformity,modulation,unused error correction capacity,print growth>`

Default: **Disabled**

Options: **0 = Disabled**
1 = Grade 1 (D)
2 = Grade 2 (C)
3 = Grade 3 (B)
4 = Grade 4 (A)

Decode (ISO/IEC 15415 Symbol Quality)

Serial Cmd: `<K830,grade,decode,symbol contrast,fixed pattern damage,axial non-uniformity,grid non-uniformity,modulation,unused error correction capacity,print growth>`

Default: **Disabled**

Options: **0 = Disabled**
1 = Grade 1 (D)
2 = Grade 2 (C)
3 = Grade 3 (B)
4 = Grade 4 (A)

Symbol Contrast (ISO/IEC 15415 Symbol Quality)

Serial Cmd: <**K830**,grade,decode,**symbol contrast**,fixed pattern damage,axial non-uniformity,grid non-uniformity,modulation,unused error correction capacity,print growth>

Default: **Disabled**

Options: **0 = Disabled**
 1 = Grade 1 (D)
 2 = Grade 2 (C)
 3 = Grade 3 (B)
 4 = Grade 4 (A)

Fixed Pattern Damage (ISO/IEC 15415 Symbol Quality)

Serial Cmd: <**K830**,grade,decode,symbol contrast,**fixed pattern damage**,axial non-uniformity,grid non-uniformity,modulation,unused error correction capacity,print growth>

Default: **Disabled**

Options: **0 = Disabled**
 1 = Grade 1 (D)
 2 = Grade 2 (C)
 3 = Grade 3 (B)
 4 = Grade 4 (A)

Axial Non-Uniformity (ISO/IEC 15415 Symbol Quality)

Serial Cmd: <**K830**,grade,decode,symbol contrast,fixed pattern damage,**axial non-uniformity**,grid non-uniformity,modulation,unused error correction capacity,print growth>

Default: **Disabled**

Options: **0 = Disabled**
 1 = Grade 1 (D)
 2 = Grade 2 (C)
 3 = Grade 3 (B)
 4 = Grade 4 (A)

Grid Non-Uniformity (ISO/IEC 15415 Symbol Quality)

Serial Cmd: <**K830**,grade,decode,symbol contrast,fixed pattern damage,axial non-uniformity,**grid non-uniformity**,modulation,unused error correction capacity,print growth>

Default: **Disabled**

Options: **0 = Disabled**
 1 = Grade 1 (D)
 2 = Grade 2 (C)
 3 = Grade 3 (B)
 4 = Grade 4 (A)

Modulation (ISO/IEC 15415 Symbol Quality)

Serial Cmd: <**K830**,grade,decode,symbol contrast,fixed pattern damage,axial non-uniformity,grid non-uniformity,**modulation**,unused error correction capacity,print growth>

Default: **Disabled**

Options: **0 = Disabled**
1 = Grade 1 (D)
2 = Grade 2 (C)
3 = Grade 3 (B)
4 = Grade 4 (A)

Unused Error Correction Capacity (ISO/IEC 15415 Symbol Quality)

Serial Cmd: <**K830**,grade,decode,symbol contrast,fixed pattern damage,axial non-uniformity,grid non-uniformity,modulation,**unused error correction capacity**,print growth>

Default: **Disabled**

Options: **0 = Disabled**
1 = Grade 1 (D)
2 = Grade 2 (C)
3 = Grade 3 (B)
4 = Grade 4 (A)

Print Growth (ISO/IEC 15415 Symbol Quality)

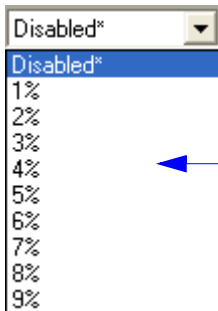

The **Print Growth** dropdown menu shows percentage values of 1% - 9%. The output will activate if the absolute value calculated by the verification algorithm exceeds the selected percentage value parameter.

Serial Cmd: <**K830**,grade,decode,symbol contrast,fixed pattern damage,axial non-uniformity,grid non-uniformity,modulation,unused error correction capacity,**print growth**>

Default: **0 (Disabled)**

Options: 0 to 9 (0 = Disabled; 1% - 9%)

AS9132 Symbol Quality (Output 1)

Note: Output On under Output 1 Parameters must be set to **Symbol Quality** for this output to function.

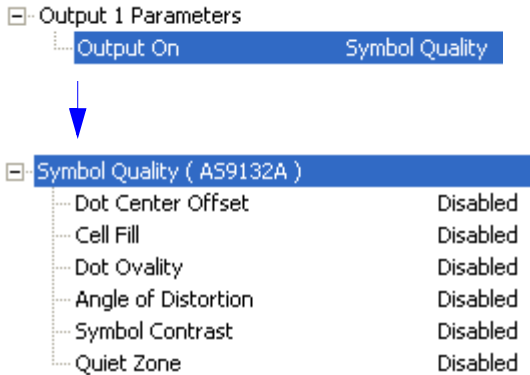

All **AS9132 Symbol Quality** parameters feature the dropdown menu shown below. When set to **Enabled**, a failing grade will activate output.

Note: The **Symbol Contrast** parameter only takes effect when **Marking Method** is set to **Laser or Chemical Etch <K711,,1>**.

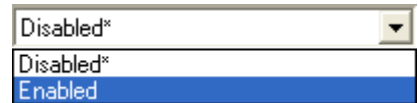

Dot Center Offset (AS9132 Symbol Quality)

Serial Cmd: <K840,dot center offset,cell fill,dot ovality,angle of distortion,symbol contrast,quiet zone>

Default: **Disabled**

Options: **0 = Disabled** 1 = Enabled

Cell Fill (AS9132 Symbol Quality)

Serial Cmd: <K840,dot center offset,cell fill,dot ovality,angle of distortion,symbol contrast,quiet zone>

Default: **Disabled**

Options: **0 = Disabled** 1 = Enabled

Dot Ovality (AS9132 Symbol Quality)

Serial Cmd: <K840,dot center offset,cell fill,dot ovality,angle of distortion,symbol contrast,quiet zone>

Default: **Disabled**

Options: **0 = Disabled** 1 = Enabled

Angle of Distortion (AS9132 Symbol Quality)

Serial Cmd: <K840,dot center offset,cell fill,dot ovality,**angle of distortion**,symbol contrast,quiet zone>

Default: **Disabled**

Options: **0 = Disabled** 1 = Enabled

Symbol Contrast (AS9132 Symbol Quality)

Serial Cmd: <K840,dot center offset,cell fill,dot ovality,angle of distortion,**symbol contrast**,quiet zone>

Default: **Disabled**

Options: **0 = Disabled** 1 = Enabled

Quiet Zone (AS9132 Symbol Quality)

Serial Cmd: <K840,dot center offset,cell fill,dot ovality,angle of distortion,symbol contrast,**quiet zone**>

Default: **Disabled**

Options: **0 = Disabled** 1 = Enabled

Diagnostics (Output 1)

Note: When **Diagnostic Warning** is enabled under **Output 1 Parameters**, **Output Mode** configuration has no effect.

Note: **Output On** under **Output 1 Parameters** must be set to **Diagnostic Warning** for this output to function.

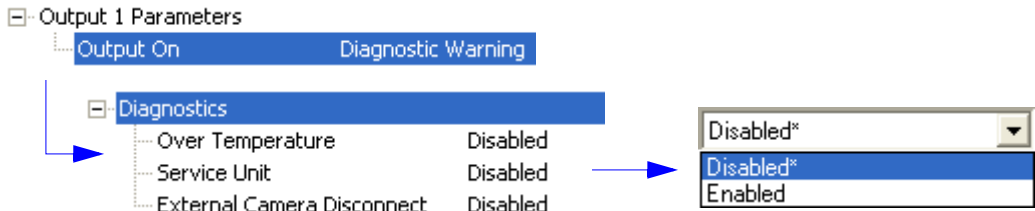

Usage: Alerts user to critical conditions.

Definition: Sets up specific warnings that will cause activation on output 1. The output will remain active as long as one of the diagnostic conditions is met. The output will go inactive as soon as it detects no active diagnostic warning.

Over Temperature

Definition: Sets the output to toggle to active when an over-temperature condition is detected.

Serial Cmd: <K790,over temp,service unit,external camera disconnect>

Default: Disabled

Options: 0 = Disabled 1 = Enabled

Service Unit

Definition: Sets the output to toggle to active when the service timer has expired. This condition will only be held for one service timer tick.

Serial Cmd: <K790,over temp,service unit,external camera disconnect>

Default: Disabled

Options: 0 = Disabled 1 = Enabled

External Camera Disconnect

Note: This feature cannot be used if in a **Continuous Read** mode.

Definition: Sets the output to toggle to active if the external camera goes off-line.

Serial Cmd: <K790,over temp,service unit,external camera disconnect>

Default: Disabled

Options: 0 = Disabled 1 = Enabled

Output 2 Parameters

Note: Output 2 has the same parameters and default settings as Output 1.

[-] Output 2 Parameters	
Output On	Symbol Quality
Output State	Normally Open
Pulse Width	5
Output Mode	Pulse
+ Trend Analysis	
+ Symbol Quality (ISO 15415)	
+ Symbol Quality (AS9132A)	
+ Diagnostics	

Output On (Output 2)

[-] Output 2 Parameters	
Output On	Mismatch or Noread*
Output State	Mismatch or Noread*
Pulse Width	Good Read/Match
Output Mode	Mismatch
	Noread
	Trend Analysis
	Symbol Quality
	Diagnostic Warning
	In Read Cycle

Serial Cmd: <K811,output on,output state,pulse width,output mode>

See Output On (Output 1) for command structure and options.

Output State (Output 2)

[-] Output 2 Parameters	
Output On	Mismatch or Noread
Output State	Normally Open*
Pulse Width	Normally Open*
Output Mode	Normally Closed

Serial Cmd: <K811,output on,output state,pulse width,output mode>

See Output State (Output 1) for command structure and options.

Pulse Width (Output 2)

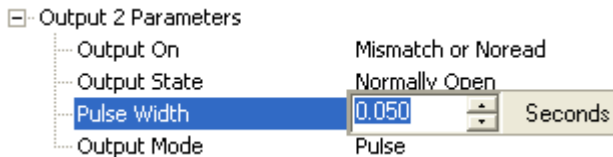

Serial Cmd: <K811,output on,output state,**pulse width**,output mode>

See **Pulse Width (Output 1)** for command structure and options.

Output Mode (Output 2)

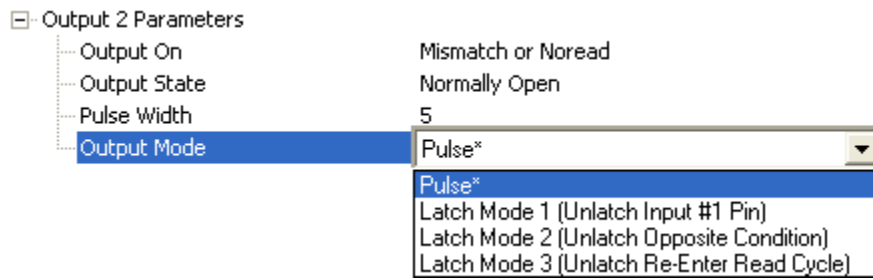

Serial Cmd: <K811,output on,output state,pulse width,**output mode**>

See **Output Mode (Output 1)** for command structure and options.

Trend Analysis (Output 2)

Note: **Output On** under **Output 2 Parameters** must be set to **Trend Analysis** for this output to function.

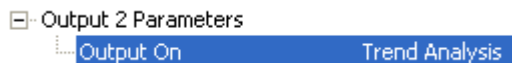

Serial Cmd: <K781,trend analysis mode,number of triggers,number to output on>

See **Trend Analysis (Output 1)** for command structure and options.

ISO/IEC 15415 Symbol Quality (Output 2)

Note: Output On under Output 2 Parameters must be set to Symbol Quality for this output to function.

All ISO/IEC 15415 Symbol Quality parameters except **Print Growth** feature the alphanumeric grade options shown below. If the decoded symbol's grade falls below the selected threshold grade, the output will activate.

Grade Output	Disabled
Decode	Disabled
Symbol Contrast	Disabled
Fixed Pattern Damage	Disabled
Axial Non-uniformity	Disabled
Grid Non-uniformity	Disabled
Modulation	Disabled
Unused ECC	Disabled
Print Growth	Disabled

Serial Cmd: *<K831,grade,decode,symbol contrast,fixed pattern damage,axial non-uniformity,grid non-uniformity,modulation,unused error correction capacity,print growth value>*

See ISO/IEC 15415 Symbol Quality (Output 1) for command structure and options.

AS9132 Symbol Quality (Output 2)

Note: Output On under Output 2 Parameters must be set to Symbol Quality for this output to function.

All AS9132 Symbol Quality parameters feature the dropdown menu shown below. When set to **Enabled**, a failing grade will activate output.
Note: The **Symbol Contrast** parameter only takes effect when **Marking Method** is set to **Laser** or **Chemical Etch** *<K711,,1>*.

Dot Center Offset	Disabled
Cell Fill	Disabled
Dot Ovality	Disabled
Angle of Distortion	Disabled
Symbol Contrast	Disabled
Quiet Zone	Disabled

Serial Cmd: *<K841,dot center offset,cell fill, dot ovality,angle of distortion,symbol contrast,quiet zone>*

See AS9132 Symbol Quality (Output 1) for command structure and options.

Diagnostics (Output 2)

Note: Output On under Output 2 Parameters must be set to Diagnostic Warning for this output to function.

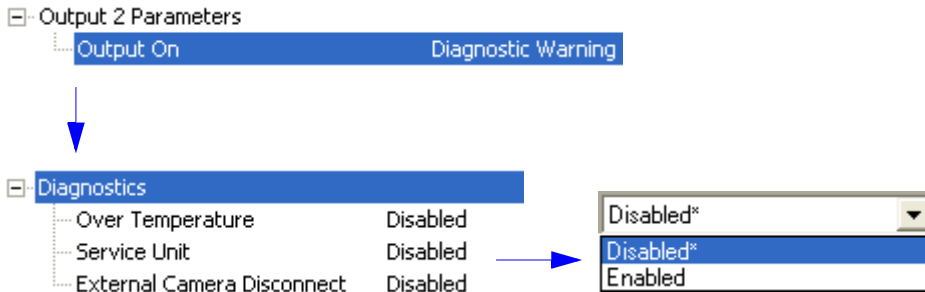

Serial Cmd: **<K791,over temp,service unit,external camera disconnect>**

See **Diagnostics (Output 1)** for command structure and options.

Output 3 Parameters

Note: The Quadrus Verifier does not have an **Output 3** option by default. If your application requires an Output 3, contact your Microscan sales representative for more information.

Output 3 has the same parameters and default settings as **Output 1** and **Output 2**.

[-] Output 3 Parameters	
Output On	Symbol Quality
Output State	Normally Open
Pulse Width	5
Output Mode	Pulse
+ Trend Analysis	
+ Symbol Quality (ISO 15415)	
+ Symbol Quality (A59132A)	
+ Diagnostic Settings	

Serial Cmd: <**K812**,output on,active state,pulse width,output mode>

Output On (Output 3)

[-] Output 3 Parameters	
Output On	Mismatch or Noread*
Output State	Mismatch or Noread*
Pulse Width	Good Read/Match
Output Mode	Mismatch
	Noread
	Trend Analysis
	Symbol Quality
	Diagnostic Warning
	In Read Cycle

Serial Cmd: <**K812**,**output on**,output state,pulse width,output mode>

See **Output On (Output 1)** for command structure and options.

Output State (Output 3)

[-] Output 3 Parameters	
Output On	Mismatch or Noread
Output State	Normally Open*
Pulse Width	Normally Open*
Output Mode	Normally Closed

Serial Cmd: <**K812**,output on,**output state**,pulse width,output mode>

See **Output State (Output 1)** for command structure and options.

Pulse Width (Output 3)

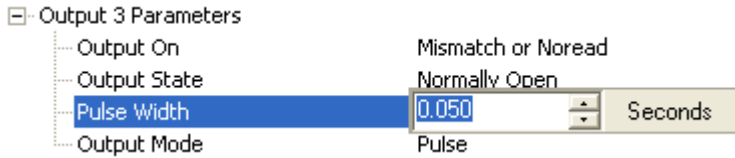

Serial Cmd: <**K812**,output on,output state,**pulse width**,output mode>

See **Pulse Width (Output 1)** for command structure and options.

Output Mode (Output 3)

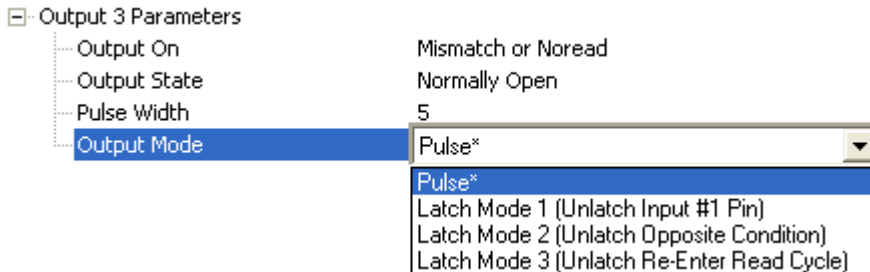

Serial Cmd: <**K812**,output on,output state,pulse width,**output mode**>

See **Output Mode (Output 1)** for command structure and options.

Trend Analysis (Output 3)

Note: **Output On** under **Output 3 Parameters** must be set to **Trend Analysis** for this output to function.

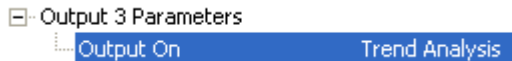

Serial Cmd: <**K782**,trend analysis mode,number of triggers,number to output on>

See **Trend Analysis (Output 1)** for command structure and options.

ISO/IEC 15415 Symbol Quality (Output 3)

Note: Output On under Output 3 Parameters must be set to Symbol Quality for this output to function.

[-] Output 3 Parameters

- [-] Output On Symbol Quality

↓

[-] Symbol Quality (ISO 15415)

Grade Output	Disabled
Decode	Disabled
Symbol Contrast	Disabled
Fixed Pattern Damage	Disabled
Axial Non-uniformity	Disabled
Grid Non-uniformity	Disabled
Modulation	Disabled
Unused ECC	Disabled
Print Growth	Disabled

All ISO/IEC 15415 Symbol Quality parameters except **Print Growth** feature the alphanumeric grade options shown below. If the decoded symbol's grade falls below the selected threshold grade, the output will activate.

Serial Cmd: <K832,grade,decode,symbol contrast,fixed pattern damage,axial non-uniformity,grid non-uniformity,modulation,unused error correction capacity,print growth value>

See ISO/IEC 15415 Symbol Quality (Output 1) for command structure and options.

AS9132 Symbol Quality (Output 3)

Note: Output On under Output 3 Parameters must be set to Symbol Quality for this output to function.

[-] Output 3 Parameters

- [-] Output On Symbol Quality

↓

[-] Symbol Quality (AS9132A)

Dot Center Offset	Disabled
Cell Fill	Disabled
Dot Ovality	Disabled
Angle of Distortion	Disabled
Symbol Contrast	Disabled
Quiet Zone	Disabled

All AS9132 Symbol Quality parameters feature the dropdown menu shown below. When set to **Enabled**, a failing grade will activate output. **Note:** The **Symbol Contrast** parameter only takes effect when **Marking Method** is set to **Laser or Chemical Etch** <K711,,1>.

Serial Cmd: <K842,dot center offset,cell fill,dot ovality,angle of distortion,symbol contrast,quiet zone>

See AS9132 Symbol Quality (Output 1) for command structure and options.

Diagnostics (Output 3)

Note: Output On under Output 3 Parameters must be set to Diagnostic Warning for this output to function.

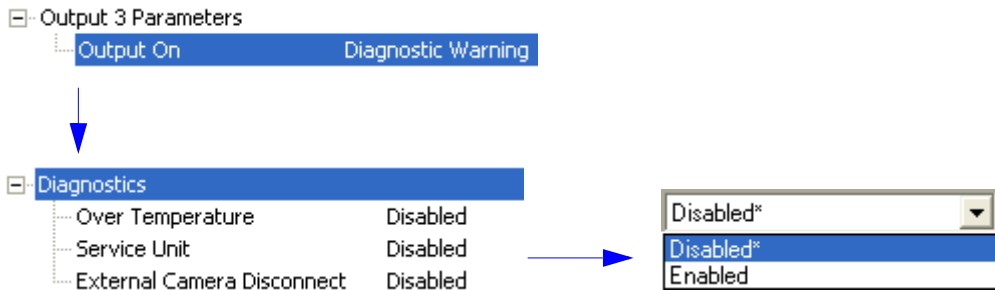

Serial Cmd: <K792,over temp,service unit,external camera disconnect>

See **Diagnostics (Output 1)** for command structure and options.

Configuring EZ Trax Output

If you intend to use the Quadrus Verifier with **EZ Trax** Software, you can configure the software in three different ways: using the EZ Trax interface, using the tree controls in **ESP**, and using serial commands.

For detailed information about how to use the EZ Trax user interface for configuration, refer to the Help menu in EZ Trax software, or the *EZ Trax Quick Start Guide*, available on the Microscan Tools CD.

Configuring EZ Trax Output by ESP

To configure **EZ Trax** using **ESP**, first click the **I/O** button in **App Mode** to display the I/O Parameters tree control.

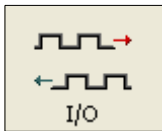

Parameters	ESP Values
<input type="checkbox"/> I/O Parameters	
<input type="checkbox"/> Symbol Data Output	Good Read
<input type="checkbox"/> Noread Message	Enabled
<input type="checkbox"/> Bad / No Symbol Qualification	
<input type="checkbox"/> Read Duration Output	Disabled
<input type="checkbox"/> Output Object Info	Disabled
<input type="checkbox"/> Output Indicators	
<input type="checkbox"/> Serial Verification	
<input type="checkbox"/> Video Output	Live (real time)
<input type="checkbox"/> Image Output	Disabled
<input checked="" type="checkbox"/> EZ Trax Output	Disabled
... Comm Port	Host
... Image Mode	Disabled
... Image Format	Compressed
... JPEG Quality	90
... Object Info Output	Disabled
... Image Captioning	Disabled
... Synchronous Trigger	Disabled
<input type="checkbox"/> EZ Button	Enabled
<input type="checkbox"/> Input 1	Disabled
<input type="checkbox"/> Unique Item Identifier (UII)	Disabled
<input type="checkbox"/> Output 1 Parameters	
<input type="checkbox"/> Output 2 Parameters	
<input type="checkbox"/> Output 3 Parameters	

EZ Trax Output

EZ Trax Output	Enabled
Comm Port	Disabled*
Image Mode	Enabled
Image Format	Compressed
JPEG Quality	90
Object Info Output	Disabled

When EZ Trax output is enabled, the Imager will attempt to output all enabled EZ Trax options. EZ Trax will not function unless enabled.

Comm Port

EZ Trax Output	Enabled
Comm Port	Host*
Image Mode	Host*
Image Format	Aux
JPEG Quality	USB
Object Info Output	Disabled

Selects the communication port that will be used to transfer image files.

Image Mode

EZ Trax Output	Disabled
Comm Port	Host
Image Mode	Both Noread and Good Read
Image Format	Disabled*
JPEG Quality	Good Read
Object Info Output	Noread
	Both Noread and Good Read
	Mismatch

Determines which read cycle condition triggers image file output.

Image Format

EZ Trax Output	Enabled
Comm Port	Host
Image Mode	Disabled
Image Format	Compressed*
JPEG Quality	Lossless
Object Info Output	Compressed*

Selects the format of the image output file.

JPEG Quality

EZ Trax Output	Enabled
Comm Port	Host
Image Mode	Disabled
Image Format	Compressed
JPEG Quality	90 (1 - 100) %
Object Info Output	Disabled

Sets the amount of JPEG image compression. A value of **1** represents the highest compression and lowest image quality, and **100** represents the lowest compression and highest image quality.

Object Info Output

[-] EZ Trax Output	Enabled
Comm Port	Host
Image Mode	Disabled
Image Format	Compressed
JPEG Quality	90
Object Info Output	Disabled*

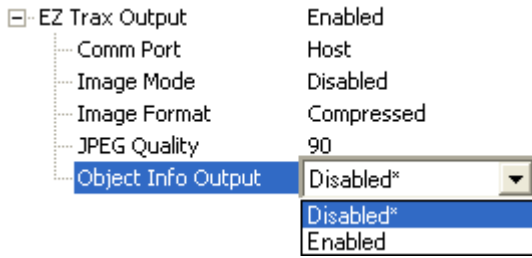

If a symbol is decoded during an image capture, the symbol type and other supplementary symbol information is also included.

Configuring EZ Trax Output by Serial Command

Usage: Useful for when you want to configure EZ Trax output using serial commands instead of the EZ Trax graphic interface.

Definition: When EZ Trax output is enabled, the Imager will attempt to output all enabled EZ Trax options. EZ Trax will not function unless enabled.

Serial Cmd: <**K757,status,comm port,image mode,image format,jpeg quality,object info output**>

Default: **Disabled**

Options: **0 = Disabled** 1 = Enabled

Comm Port

Definition: Selects the communication port that will be used to transfer image files.

Serial Cmd: <**K757,status,comm port,image mode,image format,jpeg quality,object info output**>

Default: **Host**

Options: **0 = Host** 1 = Aux 2 = USB

Host Port

Sends output using the current Host Port.

Aux Port

Sends output using the Auxiliary Port.

USB

Sends output using a USB connection.

Image Mode

Definition: Determines which read cycle condition triggers image file output.

Serial Cmd: <**K757,status,comm port,image mode,image format,jpeg quality,object info output**>

Default: **Disabled**

Options: **0 = Disabled** 1 = Good Read 2 = No Read
3 = No Read and Good Read 4 = Mismatch

Good Read

Outputs the first Good Read image in the read cycle. The image file will immediately follow the symbol data.

No Read

Outputs the first No Read image in the read cycle. The image file will immediately follow the symbol data.

Note: If two symbols are present in the same image capture and one of them is successfully decoded, no image will be output.

No Read and Good Read

Outputs the first No Read or Good Read image in the read cycle.

Mismatch

Outputs the image of the first mismatch condition.

Image Format

Definition: Selects the format of the image output file.

Serial Cmd: `<K757,status,comm port,image mode,image format,jpeg quality,object info output>`

Default: **Compressed**

Options: 0 = Lossless **1 = Compressed**

Lossless

A “lossless” image is one that is in a high resolution format, and that will not lose resolution even when manipulated and saved multiple times. When Lossless is enabled, the JPEG Quality setting has no effect.

Compressed

Outputs the image in JPEG format. Image quality is determined by the JPEG Quality setting.

JPEG Quality

Definition: Sets the amount of JPEG image compression. A value of **1** represents the highest compression and lowest image quality, and **100** represents the lowest compression and highest image quality.

Serial Cmd: `<K757,status,comm port,image mode,image format,jpeg quality,object info output>`

Default: **90**

Options: 1 to 100 (percent)

Object Info Output

Definition: If a symbol is decoded during an image capture, the symbol type and other supplementary symbol information is also included.

Serial Cmd: <**K757**,comm port,image mode,image format,jpeg quality,**object info output**>

Default: **Disabled**

Options: **0 = Disabled** 1 = Enabled

9 Matchcode

Contents

Matchcode by ESP	9-2
Matchcode Serial Commands	9-3
Overview of Matchcode	9-4
Matchcode Type	9-5
Sequential Matching	9-6
Match Start Position	9-7
Match Length	9-8
Wild Card Character	9-9
Sequence On No Read	9-10
Sequence On Mismatch	9-11
Sequence Step	9-12
Match Replace.....	9-13
Mismatch Replace.....	9-14
New Master Pin	9-15

This section explains the matchcode output functions and the master symbol database setup.

Matchcode by ESP



Click this button to bring up the **Matchcode** menu.

To **open** the entire contents of the tree control, hold down the **Alt** key and **single-click** the **+**.
To **close** the entire contents of the tree control, hold down the **Alt** key and **single-click** the **-**.

To open nested options, **single-click** the **+**.

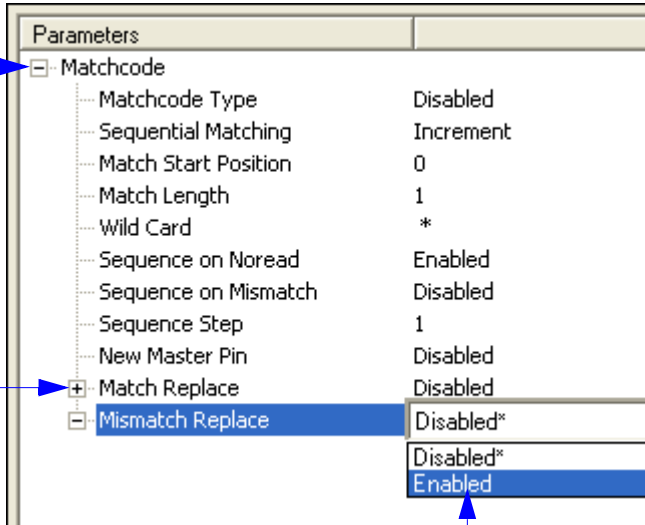

Parameters	
<input type="checkbox"/> Matchcode	
Matchcode Type	Disabled
Sequential Matching	Increment
Match Start Position	0
Match Length	1
Wild Card	*
Sequence on Noread	Enabled
Sequence on Mismatch	Disabled
Sequence Step	1
New Master Pin	Disabled
<input type="checkbox"/> Match Replace	Disabled
<input type="checkbox"/> Mismatch Replace	Disabled*
	Disabled*
	Enabled

To change a setting, **double-click** the setting and use your cursor to scroll through the options.

Matchcode Serial Commands

Matchcode Type	< K223 , type, sequential matching, match start position, match length, wild card character, sequence on no read, sequence on mismatch>
Sequence Step	< K228 , sequence step>
Match Replace	< K735 , status, replacement string>
Mismatch Replace	< K736 , status, replacement string>
New Master Pin	< K225 , status>
Number of Master Symbols	< K224 , number of master symbols>
Enter Master Symbol Data	< K231 , master symbol number, data>
Read Next Symbol as Master Symbol	< G master symbol number>
Request Master Symbol Data	< K231? ,>[for all] or < K231? , master symbol number>
Delete Master Symbol Data	< K231 , master symbol number,>

Overview of Matchcode

Definition: With **Matchcode** you can store master symbol data in the reader's memory, compare this data against the read symbols, and define how symbol data and/or discrete signal output will be directed.

A master symbol database can be set up for up to 10 master symbols.

Note: **Matchcode** will function with multiple symbols. However, if **Matchcode Type** is set to **Sequential**, or if **Triggering Mode** is set to **Continuous Read 1 Output**, **Number of Symbols** will default back to **1** (if set to any number greater than 1).

Usage: **Matchcode** is used in applications to sort, route, or verify data based on matching the specific symbol in a variety of ways as defined in this section. For example, a manufacturer might sort a product based on dates that are embedded in the symbol.

Steps for Entering and Using Master Symbols

1. Set **Triggering Mode** to **External** or **Serial**.
2. Chose the method of symbol comparison that fits your application.
3. Define the output you want to achieve with your matchcode setup:
 - a) Symbol data output.
 - b) Discrete output.
4. Select the number of master symbols you want to create.
5. Decide which of 4 ways you want enter your master symbol(s):
 - a) Use **ESP** to send master symbol data directly.
 - b) Send a serial command with symbol data in the form of **<M231, master symbol#, data>**.
 - c) Send a **<G>** (**Read Next Symbol as Master Symbol**) command.
 - d) Enable the **New Master Pin** command and activate a discrete input to store the in the next symbol read as master symbol.
6. Enter master symbol data using the method determined in step 4.

Matchcode Type

Definition: Allows the user to choose the way that master symbols will be compared with subsequently read symbols.

Note: First set **Triggering Mode** to **External** or **Serial**.

ESP:

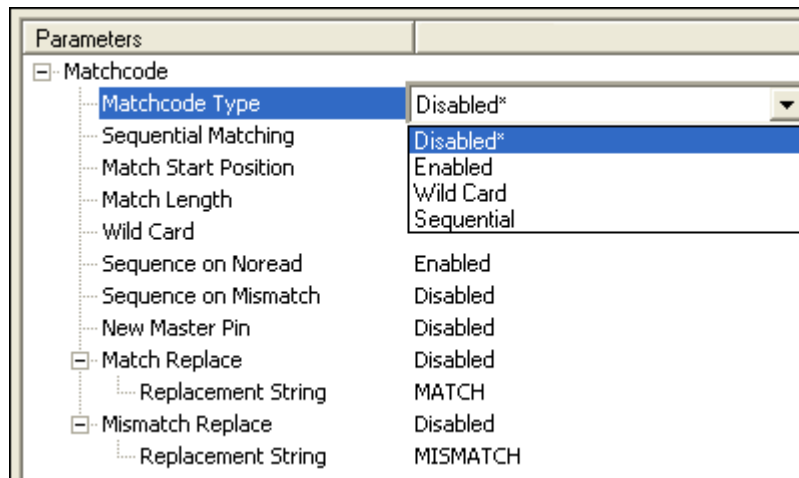

Serial Cmd: <**K223,matchcode type,sequential matching,match start position,match length,wild card character,sequence on no read,sequence on mismatch**>

Default: **Disabled**

Options: **0 = Disabled** 1 = Enabled
2 = Sequential 3 = Wild Card

Disabled: Has no effect on operations.

Enabled: Instructs the reader to compare symbols or portions of symbols with the master symbol.

Sequential: Instructs the reader to sequence after each match (numeric only) and compare symbols or portions of symbols for sequential numbers.

Note: If **Matchcode Type** is set to **Sequential**, **Number of Symbols** will default back to **1** (if set to any number greater than 1).

Wild Card: Allows the user to enter user defined wild card characters in the master symbol.

Sequential Matching

- Usage:* Useful in tracking product serial numbers that increment or decrement sequentially.
- Definition:* With **Sequential** enabled, **Sequential Matching** determines if a count is in ascending (incremental) or descending (decremental) order.
- Serial Cmd:* <**K223**, matchcode type, **sequential matching**, match start position, match length, wild card character, sequence on no read, sequence on mismatch>
- Default:* **Increment**
- Options:* **0 = Increment** 1 = Decrement

Match Start Position

- Usage:** **Match Start Position** is useful in defining specific portions of a symbol for comparisons. For example, if a symbol contains a part number, manufacturing date, and lot code info but the user is only interested in the part number information. With **Match Start Position** the reader can be set to only sort on the part number and ignore the rest of the characters.
- Definition:** **Match Start Position** determines the portions of symbols that will be matched by defining the first character in the symbol (from left to right) that will be compared with those of the master symbol, when **Matchcode Type** is set to **Enabled** or **Sequential**.
- Function:** For example, if **Match Start Position** is set to 3, the first 2 characters read in the symbol will be ignored and only the 3rd and subsequent characters to the right will be compared, up to the number of characters specified by **Match Length**.
- Serial Cmd:** *<K223,matchcode type,sequential matching,match start position,match length,wild card character,sequence on no read,sequence on mismatch>*
- Default:** **0**
- Options:** 0 to 2710

Note: **Match Start Position** must be set to **1** or greater to enable this feature. A **0** setting will disable this feature.

Match Length

- Usage:* For example, if **Match Length** is set to **6** in a 10 character symbol, and **Match Start Position** is set for **2**, only the 2nd through 7th characters (from left to right) will be compared.
- Definition:* Defines the length of the character string that will be compared with that of the master symbol when **Match Start Position** is set to **1** or greater. when **Match Start Position** is set to **0**, no comparison will occur.
- Serial Cmd:* **<K223,matchcode type,sequential matching,match start position,match length,wild card character,sequence on no read,sequence on mismatch>**
- Default:* **1**
- Options:* 1 to 2710

Wild Card Character

- Usage:* For example, with **Wild Card Character** defined as the default asterisk, defining **CR*34** as the master symbol will result in matches for CR134, CR234, but not CR2345. Entering the wild card at the end of the master symbol as in **CR*** will result in matches for variable symbol lengths such as CR1, CR23, CR358, etc.
- Definition:* **Wild Card Character** allows a user to define a wild card character as part of the master symbol.
- Serial Cmd:* <**K223**,matchcode type,sequential matching,match start position,match length,**wild card character**,sequence on no read,sequence on mismatch>
- Default:* * (asterisk)
- Options:* Any valid ASCII character.

Sequence On No Read

Usage: **Sequence On No Read** is useful when the reader needs to stay in sequence even if no decode occurs.

Definition: When **Sequence On No Read** is **Enabled** and **Matchcode** is set to **Sequential**, the reader sequences the master symbol on every match or No Read. When disabled, it does not sequence on a No Read.

Serial Cmd: *<K223, matchcode type, sequential matching, match start position, match length, wild card character, **sequence on no read**, sequence on mismatch>*

Default: **Enabled**

Options: 0 = Disabled **1 = Enabled**

An example of **Sequence on No Read Enabled:**

<i>Master symbol</i>	<i>Decoded symbol</i>	<i>Master symbol after decode</i>
001	001	002
002	002	003
003	No Read	004 (sequenced on No Read)
004	004	005
005	No Read	006 (sequenced on No Read)
006	No Read	007 (sequenced on No Read)
007	007	008

An example of **Sequence on No Read Disabled:**

<i>Master symbol</i>	<i>Decoded symbol</i>	<i>Master symbol after decode</i>
001	001	002
002	002	003
003	No Read	003 (not sequenced)
003	003	004
004	No Read	004 (not sequenced)
004	No Read	004 (not sequenced)
004	004	005

Sequence On Mismatch

Note: Matchcode must be set to **Sequential** for this command to function.

Usage: Enable this parameter if every trigger event should have a decode *and* more than one consecutive mismatch may occur.
Disable this parameter if every trigger event should have a decode but no more than one consecutive mismatch may occur.

Definition: When set to **Enabled**, the master symbol sequences on every decode, match or mismatch.
When set to **Disabled**, the master symbol will not sequence whenever consecutive mismatches occur.

Serial Cmd: <**K223**, matchcode type, sequential matching, match start position, match length, wild card character, sequence on no read, **sequence on mismatch**>

Default: **Disabled**

Options: **0 = Disabled** 1 = Enabled

The reader will sequence the master to one more/less than the decoded symbol.

An example of **Sequence On Mismatch Enabled**:

<i>Master symbol</i>	<i>Decoded symbol</i>	<i>Master symbol after decode</i>
001	001	002
002	002	003
003	abc	004 (sequenced on mismatch)
004	004	005
005	def	006 (sequenced on mismatch)
006	ghi	007 (sequenced on mismatch)
007	007	008

An example of **Sequence On Mismatch Disabled**:

<i>Master symbol</i>	<i>Decoded symbol</i>	<i>Master symbol after decode</i>
001	001	002
002	002	003
003	abc	004 (sequenced because of previous match)
004	004	005
005	def	006 (sequenced because of previous match)
006	ghi	006 (not sequenced because of previous mismatch)
006	006	007

Sequence Step

Usage: Useful in applications in which it is desirable to count by intervals other than 1.

Definition: Sequencing in **Matchcode** operations can occur in steps from 1 to 32,768. Sequencing performs like a mechanical counter by displaying positive integers and a specific number of digits after roll-overs. For example, $000 - 3 = 997$ (not -3) and $999 + 3 = 002$ (not 1002).

Serial Cmd: <**K228**, sequence step>

Default: **1**

Options: 1 to 32768

Note: See <**K223**> command for more information.

An example of **Sequence Step**, if **Sequence Step** is set to **3** and **Sequential Matching** is set to **Increment**:

<i>Master symbol</i>	<i>Decoded symbol</i>	<i>Master symbol after decode</i>
003	001	003
003	002	003
003	003	006
006	004	006
006	005	006
006	006	009

Match Replace

- Usage:* Provides a convenient shortcut for applications that need to output a pre-defined text string whenever a symbol matches a master symbol.
- Definition:* Outputs a user-defined data string whenever a match occurs and **Matchcode** is enabled.
- Serial Cmd:* <**K735**, **status**, *replacement string*>
- Default:* **Disabled**
- Options:* **0 = Disabled** 1 = Enabled

Replacement String

- Definition:* User-defined string that when enabled will replace the matchcode data.
- Serial Cmd:* <**K735**, **status**, ***replacement string***>
- Default:* **MATCH**
- Options:* Any ASCII string up to 128 characters.

Mismatch Replace

Usage: Provides a convenient shortcut for applications that need to output a pre-defined text string whenever a symbol does not match a master symbol.

Definition: Outputs a user-defined data string whenever a mismatch occurs and **Matchcode** is enabled.

Serial Cmd: <**K736**, *status*, *replacement string*>

Default: **Disabled**

Options: **0 = Disabled** 1 = Enabled

Replacement String

Definition: User-defined string that when enabled will be output whenever a mismatch occurs.

Serial Cmd: <**K736**, *status*, *replacement string*>

Default: **MISMATCH**

Options: Any ASCII string up to 128 characters.

New Master Pin

Usage: Some applications require the line worker to change the master symbol. This can be done by installing a switch at the location of the reader. It is very common to have a keyed switch so that accidental switching does not occur.

Definition: After **New Master Pin** is enabled, a pulse can be received on the new master pin that will cause the reader to record the next decoded symbol(s) as the new master symbol(s).

It is important to note that the enabling **New Master Pin** does not in itself cause a master symbol to be recorded. The master pin must then be activated momentarily (for a minimum of 10 ms) before a master symbol can be read into memory.

Serial Cmd: <**K225,status**>

Default: **Disabled**

Options: **0 = Disabled** 1 = Enabled

After **New Master Pin** has been enabled and the pin activated, decodes will be saved in the master database beginning with master symbol #1. If the reader is configured for a multisymbol read cycle (**Number of Symbols** is greater than 1), the remaining decodes will be saved in each consecutive master symbol location. For example, if **Number of Symbols** is set to **3** and **New Master Pin** is then activated, at the end of the next read cycle, the decoded symbols will be saved as master symbols 1, 2, and 3.



10 Diagnostics

Contents

- Diagnostics by ESP 10-2
- Diagnostics Serial Commands 10-2
- Counts (Read Only)..... 10-3
- External Camera Message 10-4
- Over Temperature Message 10-6
- Service Message 10-7

This section describes warning and operating messages and their settings.

Diagnostics by ESP



Click this button to bring up the **Diagnostics** menu.

To **open** the entire contents of the tree control, hold down the **Alt** key and **single-click** the **+**.
 To **close** the entire contents of the tree control, hold down the **Alt** key and **single-click** the **-**.

The screenshot shows a 'Parameters' window with a tree view. The 'Diagnostics' folder is expanded, showing sub-folders like 'Counts (Read Only)', 'External Camera Message', 'Over Temperature Message', and 'Service Message'. The 'Resolution' setting is selected, and its options are shown in a scrollable list: 'Seconds*', 'Seconds*', and 'Minutes'. A blue arrow points to the 'Minutes' option.

To open nested options, **single-click** the **+**.

To change a setting, **double-click** the setting and use your cursor to scroll through the options.

Diagnostics Serial Commands

Power-on/Reset Counts	< K406 , power-on, resets, power-on saves, customer default saves>
External Camera Message	< K410 , disconnect msg status, disconnect message, connect msg status, control message>
Over Temperature Message	< K402 , over temperature status, warning message>
Service Message	< K409 , status, service message, threshold, resolution>

Counts (Read Only)

Counts for Power-on/Reset/Saves are stored in the reader and can be displayed at any time in response to serial commands listed here, in the embedded **Diagnostic** menu, or in **ESP** by requesting reader settings. If you did not choose to receive reader settings upon connection in **ESP**, you can right-click anywhere in the **Diagnostic** window and select **Receive Reader Settings**.

Power-On

Definition: Displays a count of the number of times power to the reader is recycled.

Serial Cmd: <**K406**,**power-on**,**resets**,**power-on saves**,**customer default saves**>

Resets

Definition: Displays a count of the number of times the reader is reset.

Serial Cmd: <**K406**,**power-on**,**resets**,**power-on saves**,**customer default saves**>

Power-On Saves

Definition: Displays a count of the number of power-on saves <**Z**> command.

Serial Cmd: <**K406**,**power-on**,**resets**,**power-on saves**,**customer default saves**>

Custom Default Saves

Definition: Displays a count of the number of power-on saves (customer defaults) to flash memory (<**Zc**> command)

Serial Cmd: <**K406**,**power-on**,**resets**,**power-on saves**,**customer default saves**>

External Camera Message

Note: This feature cannot be used if in a **Continuous Read** mode.

Disconnect Status

Definition: When enabled, a message is sent when the system detects that the external camera is not connected.

Conditions: On power-on, if enabled and the external camera is not connected, the “disconnect message” will be output. The message will not be output again unless power is cycled or a “disconnect” condition occurs after a “connect” condition with connect message enabled.

Note: If the external camera is configured in “Interlaced” mode instead of “Progressive,” this will be detected as a Disconnect condition.

Serial Cmd: <**K410, disconnect msg status, disconnect message, connect msg status, connect message**>

Default: **Disabled**

Options: **0 = Disabled** 1 = Enabled

Disconnect Message

Serial Cmd: <**K410, disconnect msg status, disconnect message, connect msg status, connect message**>

Default: EX_CAM_OFF

Options: Any 1 to 10 ASCII characters except **NULL, <, or >**.

Connect Status

Definition: When enabled, a message is sent when the system detects that the external camera is connected.

Conditions: On power-on, if enabled and the external camera is connected, the “connect message” will be output. The message will not be output again unless power is cycled or a “connect” condition occurs after a “disconnect” condition with connect message enabled.

Note: If the external camera is configured in “Interlaced” mode instead of “Progressive,” this will not be detected as a connect condition.

Serial Cmd: <**K410, disconnect msg status, disconnect message, connect msg status, connect message**>

Default: **Disabled**

Options: **0 = Disabled** 1 = Enabled

Connect Message

Serial Cmd: <**K410**, disconnect msg status, disconnect message, connect msg status, **connect message**>

Default: EX_CAM_ON

Options: Any 1 to 10 ASCII characters except **NULL**, < or >.

Over Temperature Message

Over Temperature Status

Usage: Helps ensure that the reader is being used within its temperature specification.

Definition: When enabled, a message is sent whenever the system detects that the internal temperature has exceeded its specified operating temperature.

Serial Cmd: <**K402,over temperaturestatus,warning message**>

Default: **Disabled**

Options: **0 = Disabled** 1 = Enabled

Warning Message

Serial Cmd: <**K402,over temperature status,warning message**>

Default: **OVER_TEMP**

Options: Any 1 to 10 ASCII characters except **NULL, <, or >**.

Service Message

Service Message Status

Definition: When enabled, a message is sent whenever the system detects that a user-set service time has expired.
 The service timer is reset on power-on, thus the timer only records the time that has elapsed since the last reset.
 The message is sent every time the timer expires.

Serial Cmd: <**K409,status,service message,threshold,resolution**>

Default: **Disabled**

Options: **0 = Disabled** 1 = Enabled

Service Message

Serial Cmd: <**K409,status,service message,threshold,resolution**>

Default: **SERVICE**

Options: Any 1 to 10 ASCII characters except **NULL, <, or >**.

Threshold

Definition: Sets the number of hours or minutes that will transpire before the service message is output.

Serial Cmd: <**K409,status,service message,threshold,resolution**>

Default: **300** (5 minutes)

Options: 1 to 65535

Resolution

Definition: Records time in seconds or minutes.

Serial Cmd: <**K409,status,service message,threshold,resolution**>

Default: **Seconds**

Options: **0 = Seconds** 1 = Minutes

Service Message



11 Camera Setup

Contents

- Camera Setup by ESP 11-2
- Camera Setup Serial Commands..... 11-3
- Video 11-4
- Evaluation..... 11-6
- Region of Interest (ROI) 11-10
- IP Database..... 11-13
- Dynamic Setup 11-14
- Camera..... 11-16
- Illumination Source..... 11-17
- Thresholding..... 11-18
- Image Processing Settings..... 11-19
- Hollow Mode..... 11-21
- Mirrored Image 11-22

This section explains the physical controls of the internal camera, image acquisition, database settings, and image diagnostics.

Note: Camera Setup only applies to the Quadrus Verifier internal camera. If using an external camera, images are received on an as-ready basis. Allow a 33mS delay for the first image to appear from an external camera.

Camera Setup by ESP



Click this button to bring up the **Camera Setup** menu.

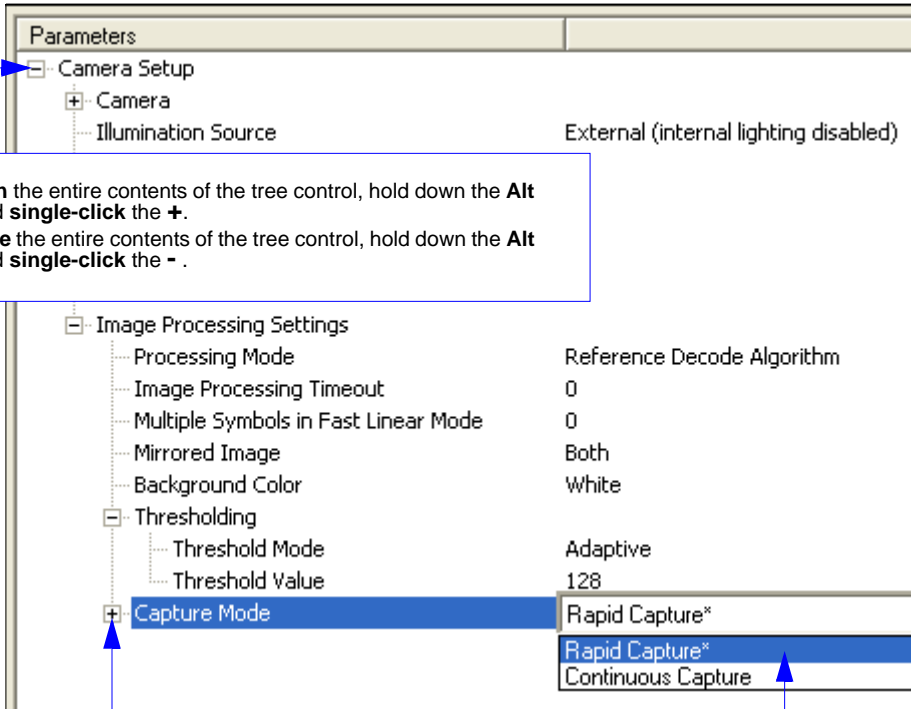

The screenshot shows a 'Parameters' dialog box with a tree control on the left and a list of settings on the right. The tree control is expanded to show 'Capture Mode' selected. A dropdown menu is open for 'Capture Mode', showing 'Rapid Capture*' and 'Continuous Capture'. A blue arrow points to the '+' icon next to 'Capture Mode' in the tree. Another blue arrow points to the 'Rapid Capture*' option in the dropdown menu.

Setting	Value
Camera Setup	
Camera	
Illumination Source	External (internal lighting disabled)
Image Processing Settings	
Processing Mode	Reference Decode Algorithm
Image Processing Timeout	0
Multiple Symbols in Fast Linear Mode	0
Mirrored Image	Both
Background Color	White
Thresholding	
Threshold Mode	Adaptive
Threshold Value	128
Capture Mode	Rapid Capture*

To **open** the entire contents of the tree control, hold down the **Alt** key and **single-click** the **+**.
To **close** the entire contents of the tree control, hold down the **Alt** key and **single-click** the **-**.

To open nested options, **single-click** the **+**.

To change a setting, **double-click** the setting and use your cursor to scroll through the options.

Camera Setup Serial Commands

Region of Interest	<K516,top,left,height,width>
Camera	<K540,shutter speed,gain>
Illumination Source	<K535,illumination source>
Thresholding	<K512,threshold mode,threshold value>
Processing Mode	<K513,processing mode>
Multiple Symbols in Fast Linear Mode	<K518,number of symbols>
Image Processing Timeout	<K245,image processing timeout>
Hollow Mode	<K517,hollow status>
Mirrored Image	<K514,mirrored image>

Video

In the **Camera** menu you can locate and capture images just as in **EZ Mode** when first starting **ESP**.

Locate

Activates the target pattern and the video view in **ESP** to help you center the symbol in the field of view.

Calibrate

If you haven't already calibrated the symbol,

1. Click the **Locate** button and center the target pattern over the symbol.
2. Click the **Calibrate** button to optimize read rate.

The Verifier will search through various IP (image processing) settings to determine the best configuration for verifying symbols.

A successful calibration will display the calibrated symbol image a message, "Calibrated successfully".

3. Click **Close** on the **Calibration** dialog.

The symbol's data and related features will be presented below the image display window.

Calibrate by Serial Command

Send **<@CAL>** to begin calibration.

Capture and Decode

After calibration, click the **Capture and Decode** button.

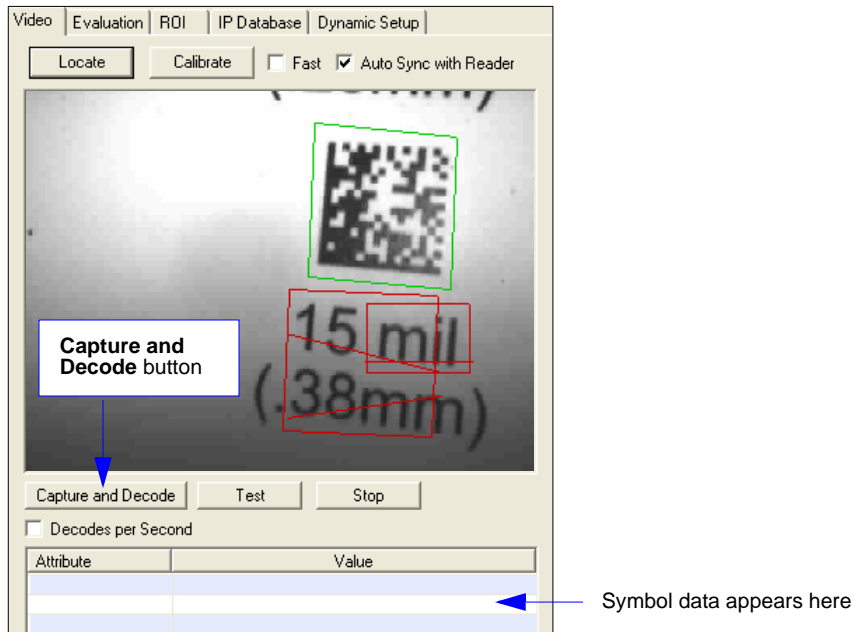

Capture and Decode View

Notice that following a capture and successful decode:

- 1D symbols have a green line through them.
- 2D symbols are surrounded by green boxes.

The new settings are uploaded to **ESP** and displayed in the **Symbol Information** box below the **Video** screen.

Test (Video Capture)

1. With your calibrated symbol in the recommended position, click the **Test** button.

Notice that the **Number Of Symbols** decoded is posted and **Percent/Decode** is dynamically updated. You can also click the **Decodes per Second** checkbox which shifts the output from **Percent Decode** to **Decodes/Second**. Un-clicking it returns the output to **Percent Decode**.

2. Click **Stop** to end the read rate test.

Evaluation

In **Evaluation**, you can view images currently in the Verifier, capture and decode a symbol, save it as a digital file, and perform histogram and line scan evaluations.

When you click on the **Evaluation** tab, you will see the images that are currently stored in the Verifier.

Click **Receive** to refresh this view.

Click **Capture/Decode** to display the current stored image. Only one capture/decode event will occur, regardless of read cycle settings.

Click **Read** to trigger a read cycle. If there is enough time in the read cycle, up to 32 good reads (or 6 full-scale images) can be captured and displayed, depending on the size of the images, and depending on the number enabled in **Number of Captures** under **Capture Mode** in the **Camera Setup** menu tree to the left of the tabs.

If you click **Save**, the current image will be saved to the location of your choice.

Note: An image can only be saved in the format in which it was uploaded to **ESP**. JPEG images will be saved as **.jpg**, and bitmaps will be saved as **.bmp**.

When you click the **JPEG Image** box, notice that the **Line Scan** button is grayed out.

The JPEG option allows faster captures and transfers, but since the JPEG standard compresses image data, it is not suitable for the more rigorous demands of line scan evaluation.

JPEG also allows you to adjust the image quality (resolution) by adjusting the sliding tab between 1 and 100, 1 being the lowest quality and 100 being the highest.

When possible, use the highest quality; when image transfer speed must be increased, use a lower image quality setting. Adjustments for this setting will depend on your specific hardware and software limitations.

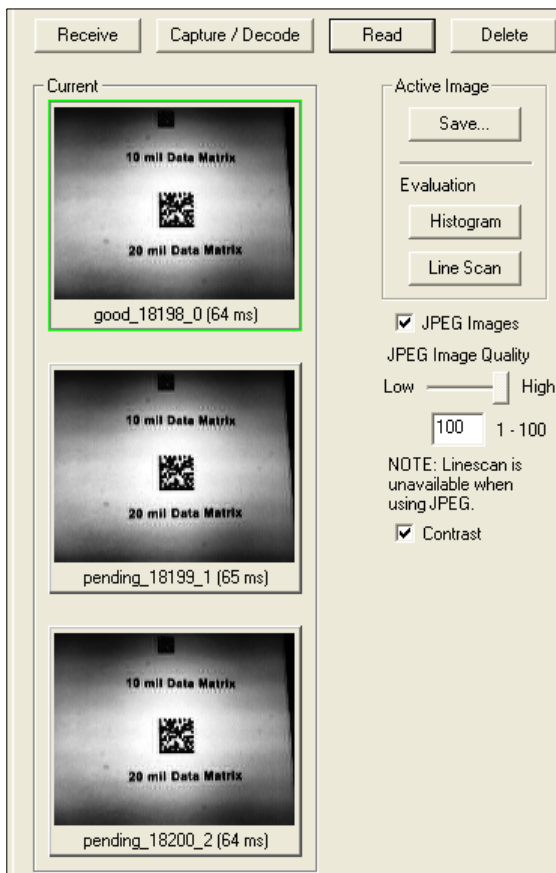

Histogram

Usage: Useful in determining quality and contrast of symbols.

Definition: A histogram is a graphical presentation of the numeric count of the occurrence of each intensity (gray level) in an image. The horizontal axis is the values of gray levels and the vertical axis is the number of pixels for each gray level.

Note: Since histograms are performed in the Verifier, the results will be save regardless of whether the image was captured as a BMP or JPEG.

1. From the **Evaluation** window, click the **Histogram** button.

The current image is transferred into the histogram operation. This may take a moment since all relevant pixels are being evaluated intensively.

2. When the **Histogram** window opens, you might need to expand the window and/or adjust the scroll bars in order to bring the image into view.
3. To generate a histogram, click and drag your mouse pointer diagonally across the symbol or a portion of it.

An area of interest box is a dashed blue line that can be selected and moved by placing a cursor inside the box, or resized by clicking and dragging the handles.

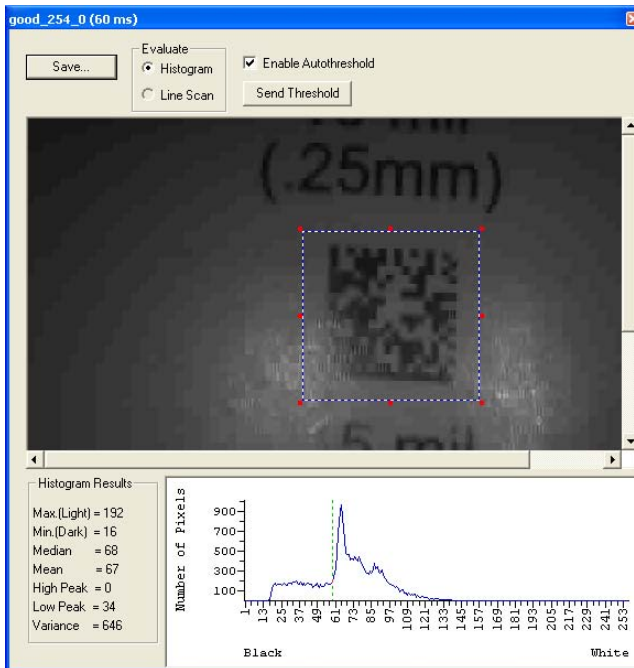

Histogram

Threshold (Histogram)

Enable Autothreshold is checked by default.

To manually adjust the threshold,

1. Uncheck the **Enable Autothreshold** checkbox.
2. Move the threshold marker (vertical green dashed line) in the Histogram chart.
Hint: This should be midway between the maximum and minimum curves.
3. Click on the **Send Threshold** button to adopt the new threshold position.

Histogram Evaluation

In the histogram shown below, the first peak (from the left) is the “Low Peak”. Its highest point occurs at the **20** in the dark to light range. The next peak is the “High Peak”, which occurs at **141**.

The minimum (dark) and maximum (light) represent the entire range of pixels that are derived from the capture.

Threshold is the mean setting (**81** on this graph) and represented by the vertical dashed green line. In practical terms, the threshold represents the point at which all pixels on the left are regarded as dark and all pixels on the right are regarded as light.

You can adjust the threshold by unchecking the **Enable Autothreshold** checkbox, moving the threshold, and clicking **Send Threshold** to save the new setting.

Line Scan

1. From the **Evaluation** tab, click the **Line Scan** button.

The window shown in the figure below appears.

Hint: When the **Histogram** window opens, you might need to expand the window and/or adjust the scroll bars in order to bring the image into view.

2. Drag your mouse pointer across the image, horizontally.

It will create a dashed horizontal line. Pixel information and a visual representation of the dark and light pixels will be displayed below the image.

When you center your cursor over the dashed line, it becomes a double arrow cross. This will allow you to move this line anywhere in the window. You can also use your keyboard arrows to move this line incrementally in any direction.

As with the histogram, the line scan compares light and dark pixels, but in a spacial distribution. On the Y axis of the graph, **0** is black and **255** is white; the X axis represents the horizontal axis of the symbol as described by the line scan.

When you click anywhere on the graph, a vertical red line appears at that point and its position and value (in terms of black to white) are updated in the **Pixel Info** table to the left of the graph, in this case **237**. In addition, a horizontal, dashed red line is displayed that indicates the average value.

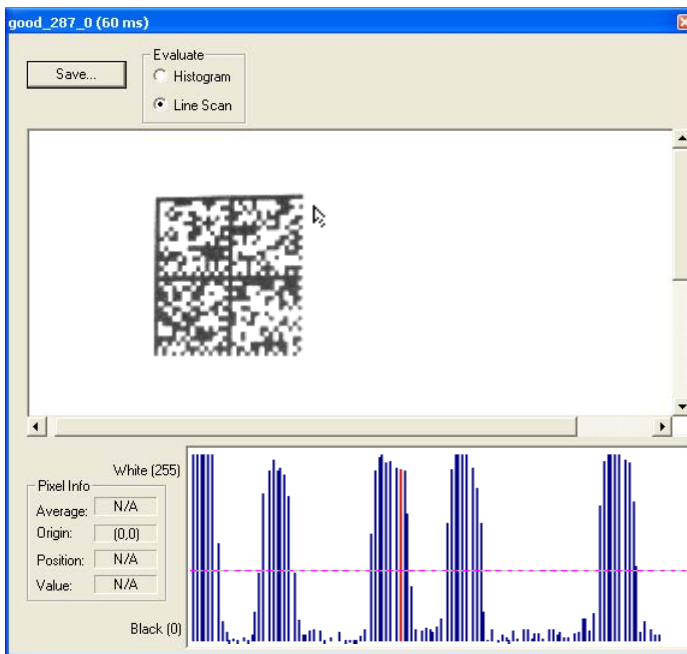

Line Scan

Region of Interest (ROI)

You can narrow the active image area (field of view) by defining a specific area or region of interest.

This is especially useful for increasing decode speed, improving threshold, and selecting the desired symbol from multiple symbols the FOV.

Notes:

1. When using video output, the **Region of Interest** image will only be shown in triggered video mode. When in live video mode, the entire image from the image sensor will be shown.
2. If external camera is in use, the command will range check for the camera and will allow a larger row and column size than the sensor has. The overall operation of the Window of Interest will not be effected if a larger row or column size is selected.
3. The **Region of Interest** can be disabled by setting all values to **0** or setting the **Region of Interest** area to equal the image sensor area.

Region of Interest	
Top	0
Left	0
Height	0
Width	0

Caution: **Region of Interest** will shrink the field of view and therefore could cause symbols to be missed in dynamic applications.

Region of Interest by ESP

1. From the **Camera** menu, click the **ROI** tab to bring up **Region of Interest**.

If you haven't already captured an image, click the **Capture and Decode** button to decode the present image. If successful, the **Good Read** indicator on the **ROI** tab will be green and the symbol will appear in the pane below.

Note: You can resize the image by clicking and dragging the **ESP** window from the lower right corner. This is useful where very small symbols are being read.

2. Click and drag your cursor over the symbol that you want to isolate for reading.

Notice that the surrounding area goes black.

You can use the handles on the image area that you have just drawn to resize the region of interest. You can also click on the center of the region of interest and move it about.

3. Test the new settings in **Read Rate Mode**.

Note: to remove the region of interest, click the **Reset** button or just click anywhere in the ROI pane.

Notice that all pixels not in the ROI are defined as black.

Because the Quadrus Verifier has much less processing to do in a smaller window, read rates typically increase dramatically. One possible downside is that the chance of missing a symbol increases with the smaller window. Always verify that your ROI will be large enough to allow for any random movement of symbols in your FOV.

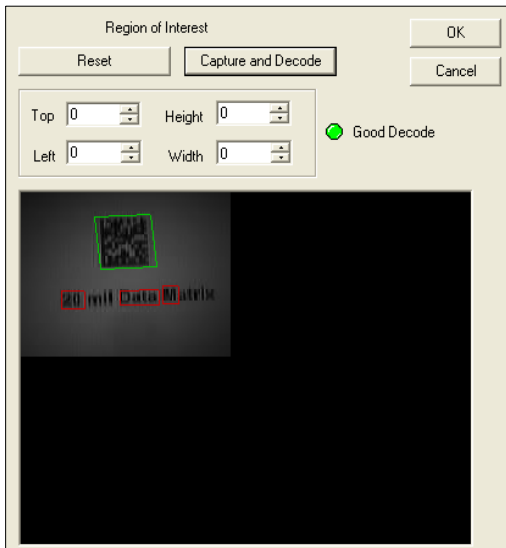

Region of Interest View

Region of Interest by Serial Command

The exact size and position of the ROI within the image area can be defined numerically in terms of pixels.

Region of Interest Parameters shows where to locate the start position of the row and column pointers and how to measure the column depth and row width dimensions.

Top (Row Pointer)

Definition: Defines the row position of the upper-left starting point of the window.

Serial Cmd: <K516, **top**, left, height, width>

Default: **0**

Options: 0 to 496

Left (Column Pointer)

Definition: Defines the column position of the upper-left starting point of the window.

Serial Cmd: <K516, top, **left**, height, width>

Default: **0**

Options: 0 to 656

Height (Row Depth)

Definition: Defines the size, in rows, of the window. Maximum value is defined as the maximum row size of image sensor minus the Top value.

Serial Cmd: <K516, top, left, **height**, width>

Default: **0**

Options: 0 to 496

Width (Column Width)

Definition: Defines the size, in columns, of the window. Maximum value is defined as the maximum column size of Image sensor minus the Left value.

Serial Cmd: <K516, top, left, height, **width**>

Default: **0**

Options: 0 to 656

IP Database

The Image Processing Database allows users to save multiple collections of camera and IP settings, and to apply them sequentially during a read cycle.

(See Chapter 12, [IP Database](#).)

Index	Shutter Speed	Gain	Processing Mode	Narrow Margins	Background Color	Threshold Mode	Fixed Threshold Value
Current	1000	550	Reference	Disabled	White	Adaptive	128
1	1000	550	Standard	Disabled	White	Adaptive	0
2	1000	550	Standard	Disabled	White	Adaptive	0
3	1000	550	Standard	Disabled	White	Adaptive	0
4	1000	550	Standard	Disabled	White	Adaptive	0
5	1000	550	Standard	Disabled	White	Adaptive	0
6	1000	550	Standard	Disabled	White	Adaptive	0
7	1000	550	Standard	Disabled			
8	1000	550	Standard	Disabled	White	Adaptive	0
9	1000	550	Standard	Disabled	White	Adaptive	0

Calibrate

5 Number of Active Indexes

Load Index To Current

Receive Send Settings Load Current To Index

Dynamic Setup

You can visually determine where moving symbols will appear in the FOV during a read cycle by adjusting the delay time before capture.

Note: If not already in **Edge** and **Rapid** modes, the reader will automatically change to those settings when you open the **Dynamic** window.

1. First set the **Capture #**.
2. Next set the **Number of Captures** and **Number of Symbols** that will be read during the read cycle.
3. Set **Delay** time.

If **Number of Captures** is set to **1**, **Delay** time will be the time between the start of a read cycle and the first capture. If set to any number other than **1**, **Delay** time will be the time between the capture set in **Capture #** and the previous capture.

4. Start the moving application and trigger the read cycle.
5. Adjust the **Delay** setting so that the symbol appears near the center of the window.

For example, if **Number of Symbols** is set to **3** and **Capture #** is set to **1**, the **Delay** time will represent the time before the capture. You can change the number by manually sliding the bar tab back and forth or by typing in a number. Numbers in the **Delay** box are rounded to the nearest value in $\pm 32\mu\text{S}$ increments.

Note: If a read cycle trigger occurs before **ESP** has finished processing/receiving an image from the previous read cycle, the trigger will be ignored. This is done to ensure that **ESP** remains in sync with the reader.

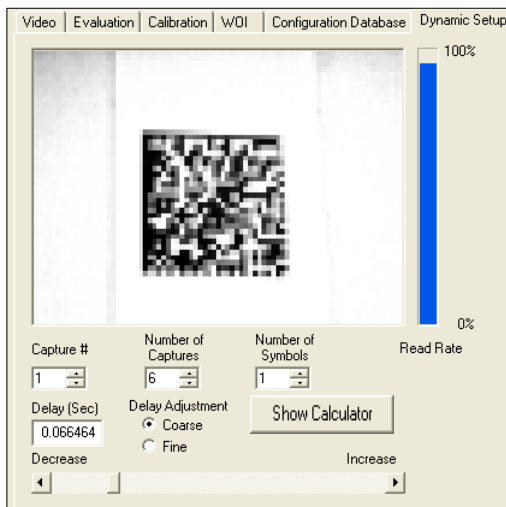

Dynamic Setup View

Calculator

The Calculator is a convenient tool to help visualize and control the spacing of rapid captures. To use the calculator:

1. From the **Dynamic** window, click **Show Calculator**.

The Calculator window will appear with the number of captures shown.

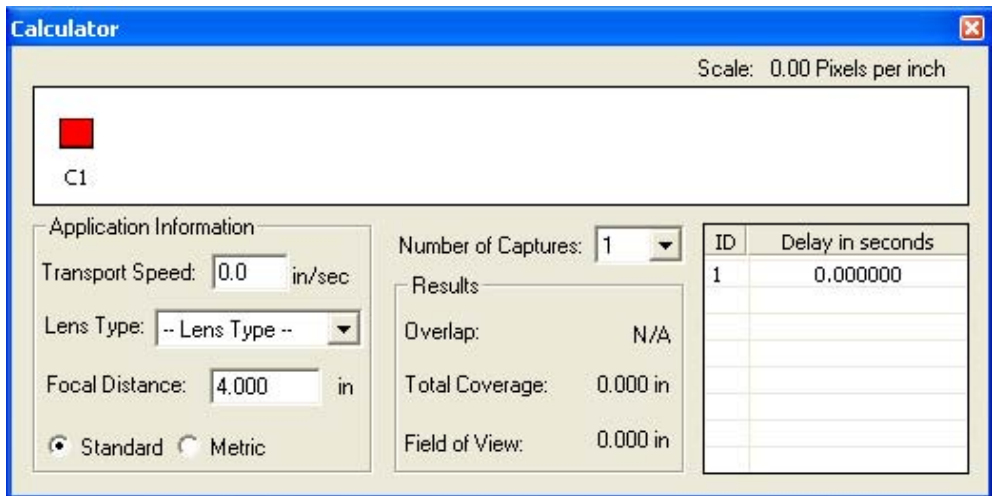

2. Enter the line speed under **Transport Speed**.
3. Select **Lens Type** and **Focal Distance**.
4. You can now enter in delays individually before each capture. (**Delay 1** is the same as the **Delay (Sec)** entered in the Dynamic window.)

You can change the delay before the first capture by moving the sliding horizon bar in the **Dynamic** window and clicking **Show Calculator**.

You can also click on any of the delays (including the first) and directly type in the delay time into any of the delays.

The spacing of the captures (C1 through Cn) represents the number of captures that will fall within the reader's FOV during the captures taken in the rapid capture burst.

Camera

Configures the operation of the CCD image sensor. Typically most of these parameters will be adjusted during the calibration process and do not need to be modified directly by the user.

Gain

Usage: Can be used to adjust pixel gray scale values for readability.

Definition: The CCD has a programmable gain amplifier that controls the amount of gain applied to the pixel gray scale value, prior to output. This value can vary depending on lighting conditions and shutter speed.

Serial Cmd: <**K540**,shutter speed,**gain**>

Default: **550**

Options: 0 to 1023

Shutter Speed

Usage: Faster shutter speeds reduce blurring in faster applications.

Slower shutter speeds are useful in slower and lower contrast applications.

Definition: Shutter speed is the time, in fractions of a second, that the CCD sensor is exposed to light.

Serial Cmd: <**K540**,shutter speed,**gain**>

Default: **1000** (1/1000 second)

Options: 50 to 50,000

Note: When **Live** video mode is active, in order to synchronize with the video format, a shutter time of 1/1000 is the lowest shutter speed setting that can be applied to the camera settings. Slower shutter speeds will disable the video output.

Illumination Source

Usage: Allows different intensities of light or external lighting to be applied to a variety of symbols in various environments.

Definition: Configures the illumination source. When external lighting is configured, then the on-board illumination LEDs are disabled. Internal illumination is provided by two sets of LEDs. This allows for three levels of illumination intensity and three different illumination patterns.

Serial Cmd: <**K535,illumination source**>

Default: **External, internal lighting disabled**

Options: **0 = External, internal lighting disabled**

1 = Internal, both inner and outer LED rings

2 = Internal, inner LED ring only

3 = Internal, outer LED ring only

Thresholding

Threshold Mode

Usage: **Fixed** works better when decode time must be as short as possible and the reflectance and illumination of the symbol area is uniform and unchanging. Otherwise **Adaptive** is the preferred mode.

Definition: This value switches the image processing threshold mode between the **Adaptive** and **Fixed** modes.
An adaptive routine sets the light/dark threshold from data acquired from the current read. A fixed mode applies the same gray scale threshold value to each and every symbol.
Generally, **Adaptive** gives better results than **Fixed**.
Unlike **Adaptive**, **Fixed** applies the same value consistently to each and every symbol.

Serial Cmd: <K512,threshold mode,threshold value>

Default: **Adaptive**

Options: **0 = Adaptive** 1 = Fixed

Threshold Value

Usage: A higher value will increase the threshold for distinguishing between light and dark elements.

Definition: Determines how the Verifier will distinguish light from dark pixels.
This value is used for the **Fixed Mode** only. When **Adaptive Mode** is set, this value is ignored.

Serial Cmd: <K512,threshold mode,threshold value>

Default: **128**

Options: 0 to 255

Image Processing Settings

Image Processing Settings control the amount of processing that occurs before an image is displayed.

Image Processing Settings	
Processing Mode	Standard
Multiple Symbols in Fast Linear Mode	0
Image Processing Timeout	0
Hollow Mode	Disabled

Processing Mode

Usage: **Standard** mode should decode over 90% of symbologies.
Mode 1 is useful for QR code and narrow-margined symbols.
Mode 2 and **Mode 3** are intended for multiple symbols in the same FOV.
Mode 3 can also be used for narrow-margined symbols and large QR code with large position detection patterns.
Mode 4 applies to Data Matrix only and is used in rare cases to improve readability.
Mode 5 is used to increase decode rates of linear symbols that are presented in the picket fence direction.
Reference Decode Algorithm is used for symbol verification.

Definition: Processing modes can affect processing time and image quality. Typically **Standard** mode should perform quickly and adequately in most cases where the Verifier is being used as a reader.

Serial Cmd: <**K513,processing mode**>

Default: **Reference Decode Algorithm**

Options: 0 = Standard 1 = Mode 1 2 = Mode 2
 3 = Mode 3 4 = Mode 4 5 = Fast Linear Mode
6 = Reference Decode Algorithm

Multiple Symbols in Fast Linear Mode

Applies to For **Fast Linear** processing mode only.

Usage: Used to process more than one symbol appearing in the FOV

Definition: Searches for one or two symbols in the FOV, as defined.

Serial Cmd: <**K518,number of symbols**>

Default: **0**

Options: 0 to 2

Image Processing Timeout

Caution: Image Processing Timeout, if not properly set, can have a negative impact on good reads. If you do not see improvements after experimenting with various timeouts, re-apply the default **0** value.

Usage: Useful in higher speed applications where image processing time is long enough that not all captures have an opportunity to be processed.

Definition: Specifies the maximum amount of time to process a captured image. When the timeout expires, the image processing is aborted. This timeout works in both **Rapid Capture** and **Continuous Capture** modes, as well as with the IP database.

Serial Cmd: **<K245,image processing timeout>**

Default: **0**

Options: 0 to 65535 (in 1mS increments)

Notes:

1. If set to 0, then there is no timeout.
2. The timeout period does not include capture time.
3. If a timeout occurs during processing, the image will be recorded as a No Read. For this reason a longer timeout might be tried to remove uncertainty.

Hollow Mode

Usage: Used to determine which kind of data matrix elements will be processed.

Definition: When set to **Regular Elements**, the reader will decode data matrix symbols with solid elements but will not decode data matrix symbols with hollow elements. When set to **Hollow Elements**, the reader will decode data matrix symbols with outlined, hollow elements but will not decode data matrix symbols with solid elements.

Serial Cmd: **<K517,hollow mode status>**

Default: **Regular Elements**

Options: **0 = Regular Elements** 1 = Hollow Elements

The image below is an example of a Data Matrix symbol with hollow elements.

Mirrored Image

Usage: When the reader is getting a mirrored image, for example with an attached right-angled mirror, enable this setting.

Definition: When enabled, outputs a mirrored image of the symbol.

Serial Cmd: **<K514,mirrored image>**

Default: **Regular Image**

Options: **0 = Regular Image** 1 = Mirrored Image

Regular Image

When **Regular Image** is enabled, images will be processed as they appear upon capture.

Mirrored Image

When **Mirrored Image** is enabled, images will be processed as a reverse of the captured image.



12 IP Database

Contents

- IP Database by ESP 12-2
- IP Database Serial Commands 12-3
- Overview of IP Database 12-4
- IP Database Window in ESP 12-6
- Number of Active Database Settings 12-7
- Image Processing Database 12-8
- Image Processing Database by ESP 12-10
- Save Current Settings to Database 12-11
- Load Current Settings from Database 12-12
- Request Selected Database Settings 12-13
- Request All Database Settings 12-13

ESP's Image Processing Database allows the user to save up to **10** sets of multiple image processing settings.

IP Database by ESP



Click this button to bring up the **Camera Setup** tree control.

You will see these tabs to the left of the **Camera Setup** tree control. Click the **IP Database** tab to bring up the database view.

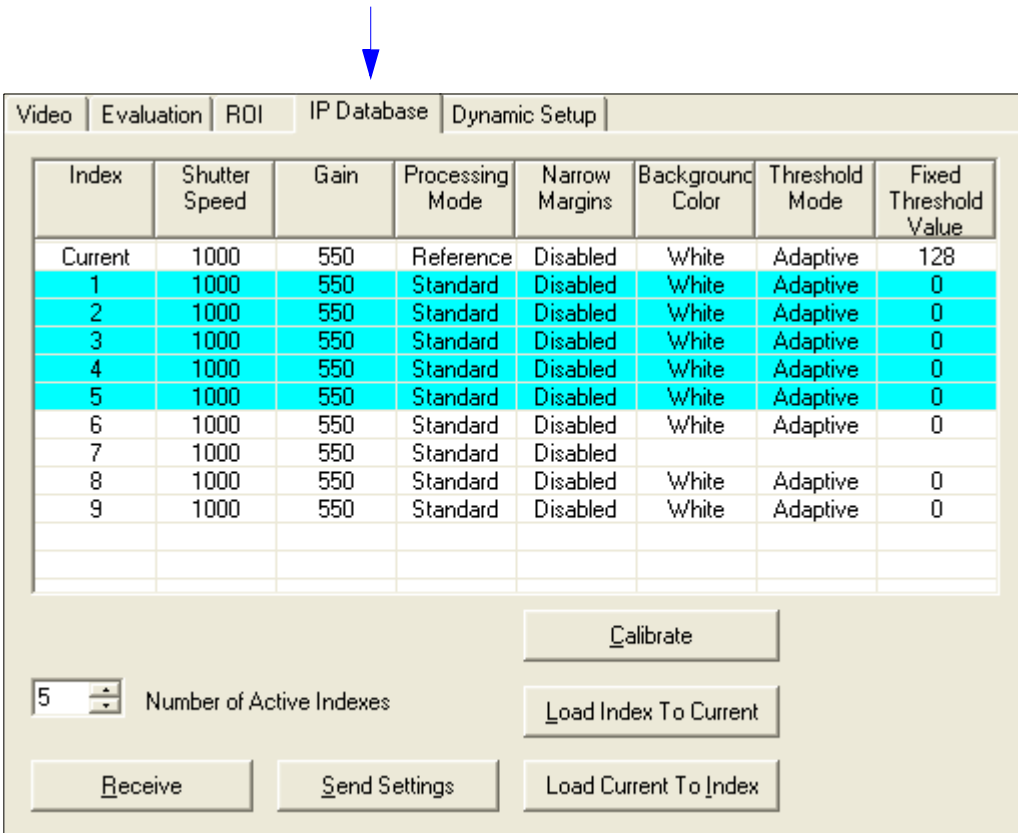
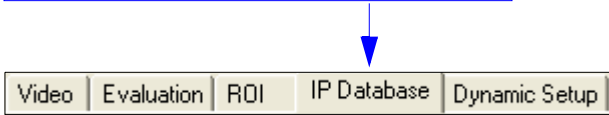
A screenshot of the software interface showing the "IP Database" tab selected. It contains a table with 8 columns: Index, Shutter Speed, Gain, Processing Mode, Narrow Margins, Background Color, Threshold Mode, and Fixed Threshold Value. Below the table are several control buttons and a spinner box.

Index	Shutter Speed	Gain	Processing Mode	Narrow Margins	Background Color	Threshold Mode	Fixed Threshold Value
Current	1000	550	Reference	Disabled	White	Adaptive	128
1	1000	550	Standard	Disabled	White	Adaptive	0
2	1000	550	Standard	Disabled	White	Adaptive	0
3	1000	550	Standard	Disabled	White	Adaptive	0
4	1000	550	Standard	Disabled	White	Adaptive	0
5	1000	550	Standard	Disabled	White	Adaptive	0
6	1000	550	Standard	Disabled	White	Adaptive	0
7	1000	550	Standard	Disabled	White	Adaptive	0
8	1000	550	Standard	Disabled	White	Adaptive	0
9	1000	550	Standard	Disabled	White	Adaptive	0

5

IP Database Serial Commands

Database Size	< K252 , number of active database settings>
Database Index	< K250 , database index, shutter speed, gain, threshold mode, fixed threshold value, processing mode, background color, narrow margins>
Save Current Settings to Database	< K250+ , database index>
Load Current Settings to Database	< K250- , database index>
Request Database Settings	< K250? , database index >
Request all Database Settings	< K250? >

Overview of IP Database

Usage: Useful in applications in which a variety of symbol conditions require different settings that can be applied in real time.

Definition: Up to **10** multiple camera/image processing settings can be saved to a database and be applied sequentially during operations.

IP Database Operation

Once **IP Database** is enabled, the reader's current settings for **Shutter Speed, Gain, Threshold Mode, Fixed Threshold Value, Processing Mode, Background Color, and Narrow Margins** will no longer impact reader operation. For those parameters, only settings that are in the database will be used for image capture and processing.

When in **IP Database** mode and at the end of a read cycle or a calibration routine, if a decode has occurred, the settings that were applied to that decode will move to the top of the database. For example if a decode occurred using the **4th** configuration index, it would be moved to index # **1** and the configurations preceding index **4** would be moved down one slot as illustrated below:

Index	Moved to
1	2
2	3
3	4
4	1
5	5

When changing database settings, it is not always necessary to re-capture an image. If the new configuration changes a camera parameter, then it is necessary to re-capture an image. The capture mode selected (**Rapid** or **Continuous**) also has an impact on whether a new image needs to be captured. The following summarizes the operation of the reader for the two different capture modes when **IP Database** is enabled.

Rapid Capture Mode

In **Rapid Capture** mode, a capture can occur during image processing. For this reason it is not possible to modify any image processing or decode parameters in this mode and only camera configuration settings in the database will take effect. The following database settings are not applied while in **Rapid Capture** mode: **Threshold mode, Fixed Threshold Value, Processing Mode, Background Color** and **Narrow Margins**.

In **Rapid Capture** mode, when the reader enters the read cycle, it uses index **0** settings of the **IP Database** for the first image capture. For each successive capture the database index is incremented and the new settings are applied to the new capture. A new capture is acquired for each database configuration. When the last active database index is filled and there are more captures to take, the index will start back at **0**.

Continuous Capture Mode

When **IP Database** is enabled (whenever **Database Size** is *not* equal to **0**), **Continuous Capture** no longer works in a double-buffered format. When the read cycle begins, the reader enters the **IP Database** at index **0** for the first image capture. The reader will capture and decode the image, increment the database index, and apply the new configuration. If the new configuration does not change camera settings, then a new image is not acquired and the reader will try to decode the current captured image with the new image processing settings. If the camera settings have changed from the previous settings, then a new capture is required. When the end of the active database configuration has been reached, the index will start back at **0**.

IP Database Window in ESP

When you click on the **IP Database** tab you will see the following view:

The screenshot shows the IP Database window with the following tabs: Video, Evaluation, ROI, IP Database (selected), and Dynamic Setup. The main table contains the following data:

Index	Shutter Speed	Gain	Processing Mode	Narrow Margins	Background Color	Threshold Mode	Fixed Threshold Value
Current	1000	550	Reference	Disabled	White	Adaptive	128
1	1000	550	Standard	Disabled	White	Adaptive	0
2	1000	550	Standard	Disabled	White	Adaptive	0
3	1000	550	Standard	Disabled	White	Adaptive	0
4	1000	550	Standard	Disabled	White	Adaptive	0
5	1000	550	Standard	Disabled	White	Adaptive	0
6	1000	550	Standard	Disabled	White	Adaptive	0
7	1000	550	Standard	Disabled	White	Adaptive	0
8	1000	550	Standard	Disabled	White	Adaptive	0
9	1000	550	Standard	Disabled	White	Adaptive	0

Below the table are several controls and callouts:

- Number of Active Indexes:** A spinner control set to 5. Callout: "Number of Active Indexes determines how many database indexes will be configured and applied to the reader. The corresponding number of index rows in the database view will be highlighted as shown."
- Calibrate:** A button. Callout: "Begins calibration routine."
- Receive:** A button. Callout: "Uploads the reader's image processing settings to the IP Database."
- Send Settings:** A button. Callout: "Sends IP Database settings to the reader."
- Load Index To Current:** A button. Callout: "Load Index to Current loads configuration settings contained in the selected database index to current, active settings. Load Current to Index loads current, active settings to the selected database index."
- Load Current To Index:** A button. Callout: "Load Index to Current loads configuration settings contained in the selected database index to current, active settings. Load Current to Index loads current, active settings to the selected database index."

Additional callout: "To make changes to index settings, **double-click** the desired index row and use the popup dialog."

Number of Active Database Settings

Usage: It is important to remember that **IP Database Size** must be set for the number of indexes you are planning to define for your database.

Definition: This determines the number of active database indexes. Whenever the number of active database indexes is something other than **0**, **IP Database** is enabled.

Serial Cmd: <**K252**,number of active database settings>

Default: **0**

Options: 1 to 10

By ESP

The screenshot shows the 'IP Database' tab in a configuration window. It contains a table with 10 rows and 8 columns: Index, Shutter Speed, Gain, Processing Mode, Narrow Margins, Background Color, Threshold Mode, and Fixed Threshold Value. The first five rows (Index 1-5) are highlighted in cyan. Below the table is a spin box labeled 'Number of Active Indexes' with the value '5' selected. To the right of the spin box are three buttons: 'Calibrate', 'Load Index To Current', and 'Load Current To Index'. A blue callout box points to the spin box and contains the following text:

Use this spin box to set the number of database indexes you intend to configure and apply to the reader. Notice that the first five index rows in the table are highlighted, because **Number of Active Indexes** is set to 5 in the spin box.

Index	Shutter Speed	Gain	Processing Mode	Narrow Margins	Background Color	Threshold Mode	Fixed Threshold Value
Current	1000	550	Reference	Disabled	White	Adaptive	128
1	1000	550	Standard	Disabled	White	Adaptive	0
2	1000	550	Standard	Disabled	White	Adaptive	0
3	1000	550	Standard	Disabled	White	Adaptive	0
4	1000	550	Standard	Disabled	White	Adaptive	0
5	1000	550	Standard	Disabled	White	Adaptive	0
6	1000	550	Standard	Disabled	White	Adaptive	0
7	1000	550	Standard	Disabled	White	Adaptive	0
8	1000	550	Standard	Disabled	White	Adaptive	0
9	1000	550	Standard	Disabled	White	Adaptive	0
10	1000	550	Standard	Disabled	White	Adaptive	0

Image Processing Database

The **Image Processing Database** is the sequentially-applied collection of camera settings that are sent to the reader during operation, but only when one or more database indexes are made active.

Database Index

Definition: Defines the specific database index (1 to 10) of settings that will be applied during operations. Each index (1 to 10) will have its own settings, for example **<K250,1...>**, **<K250,2...>**, etc.

Serial Cmd: **<K250,database index,shutter speed,gain,threshold mode,threshold value,processing mode,background color,narrow margins>**

Default: **0**

Options: 1 to 10

Gain

Serial Cmd: **<K250,database index,shutter speed,gain,threshold mode,threshold value,processing mode,background color,narrow margins>**

Default: **0**

Options: 0 to 1023

Shutter Speed

Serial Cmd: **<K250,database index,shutter speed,gain,threshold mode,threshold value,processing mode,background color,narrow margins>**

Default: **0**

Options: 50 to 50000

Threshold Mode

Serial Cmd: **<K250,database index,shutter speed,gain,threshold mode,threshold value,processing mode,background color,narrow margins>**

Default: **Adaptive**

Options: **0 = Adaptive** 1 = Fixed

Threshold Value

Serial Cmd: <**K250**,database index,shutter speed,gain,threshold mode,**threshold value**,processing mode,background color,narrow margins>

Default: **0**

Options: 0 to 255

Processing Mode

Serial Cmd: <**K250**,database index,shutter speed,gain,threshold mode,threshold value,**processing mode**,background color,narrow margins>

Default: **Standard**

Options: **0 = Standard**

1 = Mode 1

2 = Mode 2

3 = Mode 3

4 = Mode 4

5 = Fast Linear Mode

6 = Reference Decode Algorithm

Background Color

Serial Cmd: <**K250**,database index,shutter speed,gain,threshold mode,threshold value,processing mode,**background color**,narrow margins>

Default: **White**

Options: **0 = White** 1 = Black

Narrow Margin Status

Serial Cmd: <**K250**,database index,shutter speed,gain,threshold mode,threshold value,processing mode,background color,**narrow margins**>

Default: **Disabled**

Options: **0 = Disabled** 1 = Enabled

Image Processing Database by ESP

The Image Processing command **<K250>** is functionally the most central element of the **IP Database**. Each column of the **IP Database** table corresponds to a feature of the **<K250>** command.

Each image processing setting corresponds to a field in the **<K250>** command. Changes to these settings can be made by double-clicking on the desired index row and then making the necessary changes in the popup dialog that appears.

The screenshot shows the 'IP Database' tab in a software interface. It contains a table with 8 columns: Index, Shutter Speed, Gain, Processing Mode, Narrow Margins, Background Color, Threshold Mode, and Fixed Threshold Value. The table has three rows: 'Current', '1', and '2'. Row '1' is selected. A 'Database #1' dialog box is open, showing configuration options for the selected row. The dialog includes spinners for Shutter Speed (1000, range 50-50000) and Gain (550, range 0-1023), dropdowns for Narrow Margins (Disabled*) and Background Color (White*), and a dropdown for Processing Mode (Standard). The Processing Mode dropdown is open, showing options: Standard, Mode 1, Mode 2, Mode 3, Mode 4, Fast Linear Mode, and Reference Decode AI. OK and Cancel buttons are at the bottom.

Index	Shutter Speed	Gain	Processing Mode	Narrow Margins	Background Color	Threshold Mode	Fixed Threshold Value
Current	1000	550	Reference	Disabled	White	Adaptive	128
1	1000	550	Standard	Disabled	White	Adaptive	0
2	1000	550	Standard	Disabled	White	Adaptive	0

Database #1

Shutter Speed: 1000 (50 - 50000) | Gain: 550 (0 - 1023) | Processing Mode: Standard

Narrow Margins: Disabled* | Background Color: White*

Processing Mode options: Standard, Mode 1, Mode 2, Mode 3, Mode 4, Fast Linear Mode, Reference Decode AI

Buttons: OK, Cancel

The settings in this popup dialog correspond with the different elements of the **<K250>** command. This intuitive user interface format allows you to make all the necessary configuration changes to the selected database index. When you are finished, click **OK**. Your changes will be reflected in the index row on the **IP Database** table.

Save Current Settings to Database

Definition: Allows current, active configuration settings to be saved to a selected database index.

Serial Cmd: <**K250+**,database index>

By ESP

The screenshot shows the 'IP Database' tab in a software interface. It contains a table with 8 columns: Index, Shutter Speed, Gain, Processing Mode, Narrow Margins, Background Color, Threshold Mode, and Fixed Threshold Value. The table lists 10 indices, with index 1 being the 'Current' profile. Below the table is a scroll bar, a 'Calibrate' button, a spinner box set to '5' labeled 'Number of Active Indexes', and three buttons: 'Receive', 'Send Settings', and 'Load Current To Index'. A blue arrow points to the 'Load Current To Index' button.

Index	Shutter Speed	Gain	Processing Mode	Narrow Margins	Background Color	Threshold Mode	Fixed Threshold Value
Current	1000	550	Reference	Disabled	White	Adaptive	128
1	1000	550	Standard	Disabled	White	Adaptive	0
2	1000	550	Standard	Disabled	White	Adaptive	0
3	1000	550	Standard	Disabled	White	Adaptive	0
4	1000	550	Standard	Disabled	White	Adaptive	0
5	1000	550	Standard	Disabled	White	Adaptive	0
6	1000	550	Standard	Disabled	White	Adaptive	0
7	1000	550	Standard	Disabled	White	Adaptive	0
8	1000	550	Standard	Disabled	White	Adaptive	0
9	1000	550	Standard	Disabled	White	Adaptive	0
10	1000	550	Standard	Disabled	White	Adaptive	0

Click **Load Current to Index** to save current, active reader configuration settings to a database index of your choice. When these settings are saved to a specific index, they can be applied to the reader as part of a sequence of configuration profiles during operation.

Load Current Settings from Database

Definition: Allows the configuration settings contained in a selected database index to be loaded to current, active configuration settings.

Serial Cmd: <K250-,database index>

By ESP

The screenshot shows a software interface with several tabs: Video, Evaluation, ROI, IP Database (selected), and Dynamic Setup. Below the tabs is a table with 8 columns: Index, Shutter Speed, Gain, Processing Mode, Narrow Margins, Background Color, Threshold Mode, and Fixed Threshold Value. The table contains 10 rows of data. Below the table is a scroll bar. At the bottom of the window are several buttons: Calibrate, Load Index To Current (highlighted with a blue arrow), Load Current To Index, Receive, and Send Settings. A numeric spinner is set to 5, labeled 'Number of Active Indexes'.

Index	Shutter Speed	Gain	Processing Mode	Narrow Margins	Background Color	Threshold Mode	Fixed Threshold Value
Current	1000	550	Reference	Disabled	White	Adaptive	128
1	1000	550	Standard	Disabled	White	Adaptive	0
2	1000	550	Standard	Disabled	White	Adaptive	0
3	1000	550	Standard	Disabled	White	Adaptive	0
4	1000	550	Standard	Disabled	White	Adaptive	0
5	1000	550	Standard	Disabled	White	Adaptive	0
6	1000	550	Standard	Disabled	White	Adaptive	0
7	1000	550	Standard	Disabled	White	Adaptive	0
8	1000	550	Standard	Disabled	White	Adaptive	0
9	1000	550	Standard	Disabled	White	Adaptive	0
10	1000	550	Standard	Disabled	White	Adaptive	0

Click **Load Index to Current** to download the configuration settings from a selected database index to the reader for use as the current, active configuration settings. This command essentially allows you to remove a single group of settings from the **IP Database** sequence and make those settings the reader's current configuration profile, to be applied to the reader independent of the **IP Database**.

Request Selected Database Settings

Definition: Returns configuration settings for the selected database index.

Serial Cmd: <K250?,database index>

Example:

<K250?,5>

This command phrase returns the configuration settings for database index 5.

Request All Database Settings

Definition: Returns configuration settings for all indexes in the database.

Serial Cmd: <K250?>

Example:

<K250?>

This command phrase returns the configuration settings for all database indexes.

13 Terminal

Contents

Terminal Window	13-2
Find	13-3
Send.....	13-4
Macros	13-5
Terminal Window Menus.....	13-6

This section describes the **Terminal** window and macro functions.

Note: You can learn the current setting of any parameter by inserting a question mark after the number, as in **<K100?>**. To see all K commands, send **<K?>**.

Terminal Window



To use the **Terminal** interface, click the **Terminal** button.

You will see this window:

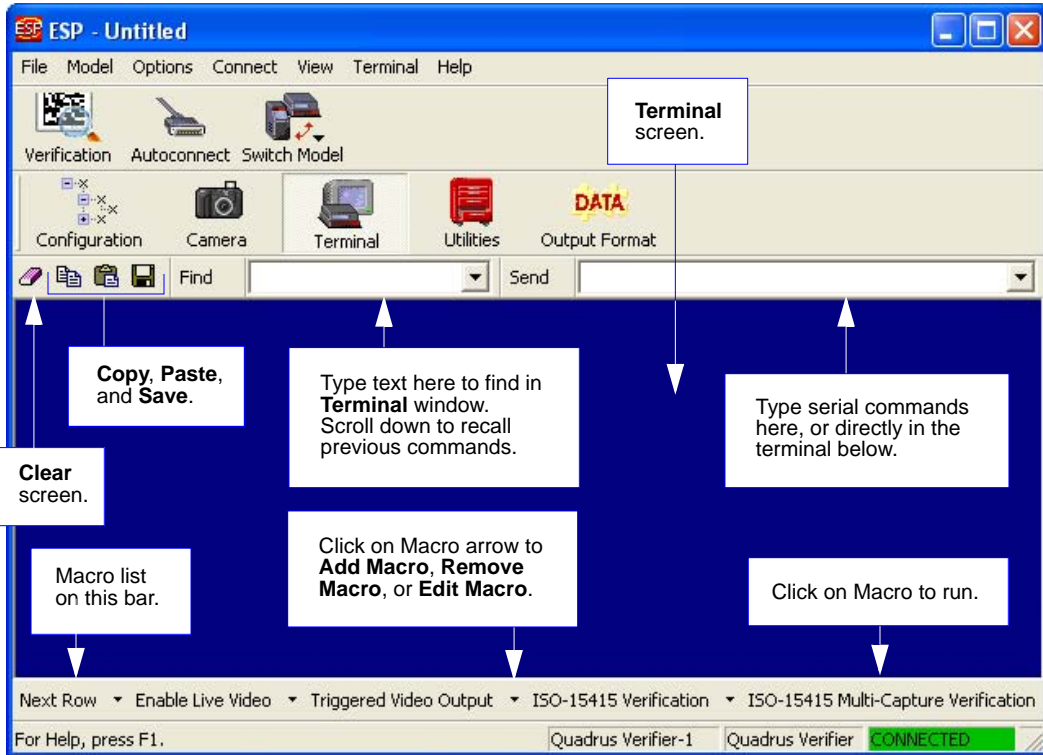

The **Terminal** screen allows you to enter serial commands from the macro box, by copying and pasting, or directly from your keyboard.

The **Terminal** screen also displays symbol data or other information from the Verifier. You can also right click in the **Terminal** screen to bring up a menu of further options.

Find

The **Find** function allows you to enter text strings to be searched for in the **Terminal** window. For example, a series of symbols have been scanned into the **Terminal** view and you want to determine if a particular symbol whose data begins with “ABC” has been read.

1. Type “ABC” into the **Find** box.

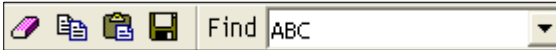

2. Press **Enter**.

The first instance of “ABC” will be highlighted in the **Terminal** window.

3. Click the **Find** button to the right of the text field to locate additional instances of “ABC”.

Send

The **Send** function allows you to enter serial commands and then send them to the Verifier. For example, you need to perform a single capture verification routine on a symbol.

1. Type the single capture command **<V1>** into the **Send** box.

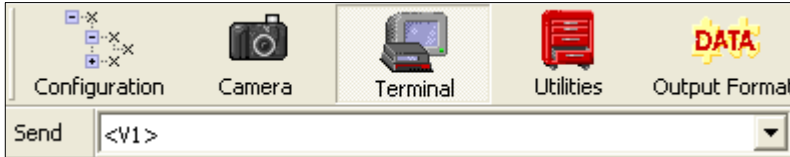

2. Press **Enter**.
Single capture verification will occur and a report will be generated in the **Terminal** window.
3. Click the **Send** button to the left of the text field to initiate additional single capture verification routines.

Macros

Macros can be stored in a macro selection bar, edited in a separate window, and executed by clicking on the macro name.

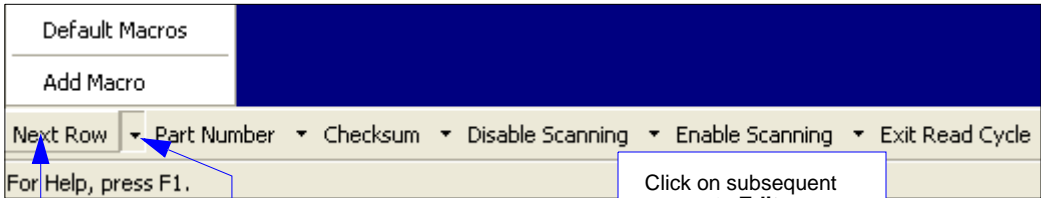

Click on **Next Row** to see the next row of macros.

Click on the first arrow here to see **Add Macro** or **Default Macros**. When you default macros, the entire macros set is restored to original commands.

Click on subsequent arrows to **Edit** macros.

When you click on the macro name, the macro is executed in the **Terminal** window. If this is a command, the command is also sent to the Verifier at the same time it is displayed.

Editing a Macro

When you click the arrow next to any macro and select **Edit**, the following appears:

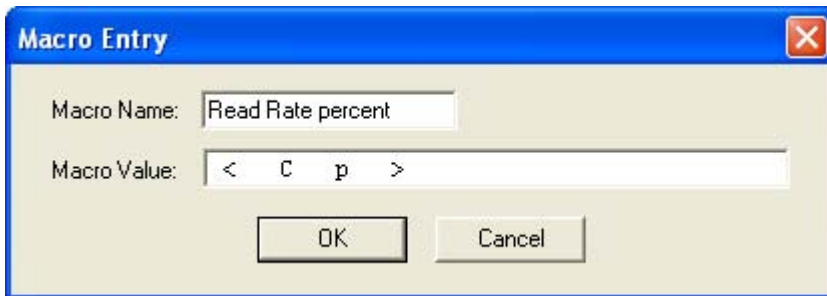

You can edit an existing macro or type in the **Macro Name** text box and define it in the **Macro Value** text box. Click **OK**.

Terminal Window Menus

Right click on the **Terminal** window to display the following menu:



- **Copy** selected text to clipboard.
- **Paste** from **Terminal** or computer text.
- **Clear** all text in **Terminal** window.
- **Select All** text in the **Terminal** window.
- **Save...** brings up a save as dialog box.
- **Change Font...** of data text, brings up a text dialog.
- **Change Echo Font...** to change typed in text or commands.
- **Change Background Color** of **Terminal** window.
- **Default Settings** changes all the above back to default settings.

Terminal Dropdown Menu

The dropdown **Terminal** menu has **Capture Text** and **Save Current Text** functions, as well as the functions defined above.

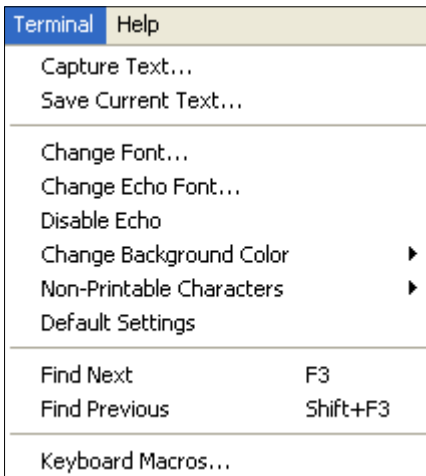

- **Capture** lets you append data in real time to a text file of your choice. While in operation, the text file cannot be opened. You can select **Pause** to interrupt the capture flow or **Stop** to end the flow and open the file.
- **Save Current Text...** saves all text in the **Terminal** window to a text file of your choice.

14 Utilities

Contents

Serial Utility Commands	14-2
Read Rate	14-3
Counters	14-4
Device Control	14-6
Differences from Default	14-7
Master Database	14-8
Firmware	14-13
Bar Code Configuration	14-16
Defaulting/Saving/Resetting	14-17
Status Requests	14-19
Other Operational Commands	14-20

Utility commands are generally commands that are performed during reader operations to check read rates, determine read rates or perform miscellaneous operations on reader hardware. Serial utility commands are not prefaced with a 'K' and a numeric code. Nor do they require an initialization command (<A> and <Z>). They can be entered from within any terminal program or from within **ESP** in the **Terminal** window or the window adjacent to the **Utilities** menu.

Serial Utility Commands

Read Rate	<C>	Enter Decode Rate Test
	<Cp>	Enter Percent Rate Test
	<J>	Exit Decode Rate and Percent Rate Test
Counter Request and Clear	<N>	No Read Counter
	<O>	No Read Counter Reset
	<T>	Trigger Counter
	<U>	Trigger Counter Reset
	<V>	Good Read/Match Counter
	<W>	Good Read/Match Counter Reset
	<X>	Mismatch Counter
	<Y>	Mismatch Counter Reset
Master Database	<E>	Enable Master Symbol *
	<F>	Disable Master Symbol*
	<G>	Store next Symbol read to Database.
	<M?>	Request Master Symbol Information
Part Number and Checksum	<#>	Display Software Code Part Numbers
	<#a>	Display Application Code Part Number
	<#b>	Display Boot Code Part Number
	<#d>	Display DSP Part Number
	<#f>	Display FPGA Part Number
	<!>	Display all 3 Checksums of Flash memory
	<!a>	Display Application Code Checksum
	<!b>	Display Boot Code Checksum
	<!d>	Display DSP Code Checksum
<!f>	Display FPGA Code Checksum	
Device Control	<L1>	Programmable Output 1
	<L2>	Programmable Output 2
	<L3>	Programmable Output 3
Default/Reset/Save	<A>	Reset (does not save for power-on)
	<Ard>	Reset and recall Microscan defaults
	<Arp>	Reset and recall power-on parameters
	<Arc>	Reset and recall customer default parameters
	<Z>	Save current settings for power-on
	<Zc>	Save current settings as customer default parameters
	<Zrd>	Recall Microscan default parameters and save
<Zrc>	Recall customer default parameters and save	
Status Commands	<K?>	All Configuration Commands Status
	<->	Input Status
	<?>	Reader Status
	<?1>	Extended Reader Status
Operational Commands	<@VER>	ISO/IEC 15415 Reflectance Calibration
	<V1>	ISO/IEC 15415 Single Capture Verification
	<V2>	ISO/IEC 15415 Multi-Capture Verification
	<V3>	AS9132 Verification
	<@AIMDPM,R-max,R-min>	AIM DPM Reflectance Calibration
<V4>	AIM DPM Verification	

Read Rate

Read Rate by ESP

You can access **Read Rate** from the **Utilities** menu.

To see the number of decodes per second, click the **Decodes/sec** radio button and click the **Start** button.

To see the percentage of decodes, click the **Percent** radio button and **Start** button.

To end a read rate routine, click the **Stop** button (in the same position as the **Start** button).

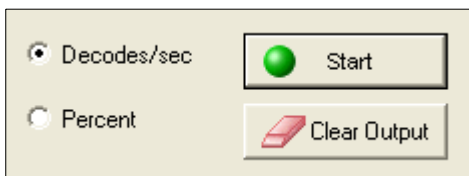

Read Rate by Serial Command

Enter Decodes/Second Test

Sending **<C>** instructs the reader to transmit the decodes per second and symbol data (if any). The decode rate can vary dramatically due to the angle and location of the symbol in relation to the field of view. This test is very useful in aligning and positioning the reader during setup.

Enter Percent Test

Sending **<Cp>** instructs the reader to transmit the percentage of decodes and any read symbol data.

Enable PDF Information

Sending **<a1>** will cause PDF417 data to be prefaced with information consisting of error correction level (ECC Level *n*), number of rows (*n* Rows), number of columns (*n* Columns), number of informative code words (*n* Info Code Words) and the number of data characters (*n* Data Bytes).

This feature can be disabled by re-sending **<a1>**.

End Read Rate Test

Sending **<J>** ends both the **Percent** test and the **Decodes/Second** test.

Counters

Counter commands can be a numeric value from 00000 to 65,535. After reaching the maximum numeric limit of 65,535, an error message will be displayed and the counter will automatically roll-over and start counting again at 00000. To obtain the cumulative total of counts after the roll-over has occurred, add 65,536 per each roll-over (the reader does not keep track of the number of roll-overs) to the current count.

Note: All counter values will be lost if power is recycled to the reader or the reader receives a reset or save command.

Counters by ESP

You can access **Counters** from the **Utilities** menu.

Click the **Request** button to display the appropriate count or **Clear** to set counter to zero.

The screenshot shows a software interface for managing counters. At the top, there are two large buttons: "Request All" and "Clear All". Below these, there are four rows of controls, each corresponding to a different counter type: "Trigger", "Good Read", "Noread", and "Mismatch". Each row contains a "Request" button, a "Clear" button, and a text input field for setting a value. The "Request" and "Clear" buttons are smaller and positioned to the left of the input field.

Counters by Serial Command

No Read Counter

Sending **<N>** displays the total number of No Reads that have occurred since the last reset.

No Read Counter Reset

Sending **<O>** sets No Read Counter to 00000.

Trigger Counter

Sending **<T>** displays the total number of triggers since the last reset.

Trigger Counter Reset

Sending **<U>** sets the trigger counter to 00000.

Good Read/Match Counter (or Good Read Counter)

Sending **<V>** displays the total number of good reads matching the master symbol or, if Master Symbol is not enabled, the number of good reads since the last reset. This counter is always enabled, but will only work as a match count when Master Symbol is enabled. If Master Symbol is not enabled, this counter records the number of good reads. This count can be requested at any time.

Good Read/Match Counter Reset

Sending **<W>** sets the Match Counter to 00000.

Mismatch Counter

Sending **<X>** displays the number of decoded symbols since the last reset that do not match the master symbol.

Mismatch Counter Reset

Sending **<Y>** sets the Mismatch Counter to zero.

Device Control

Device Control by ESP

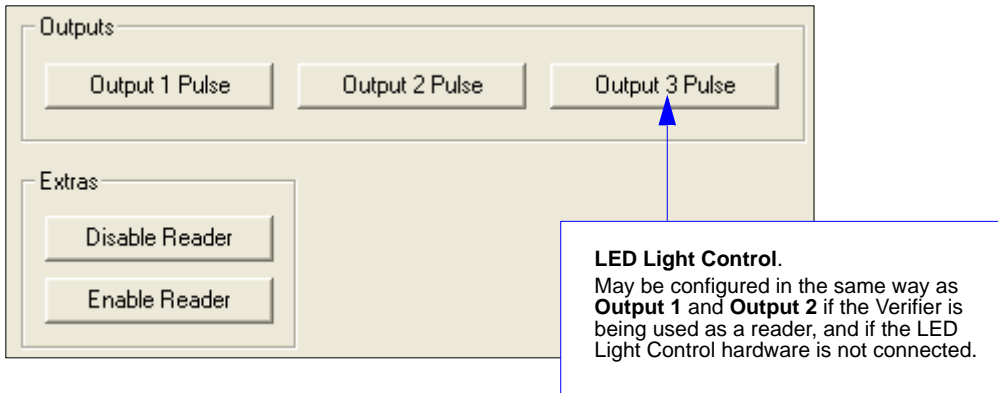

Device Control By Serial Command

Output 1 Pulse

Sending **<L1>** pulses activates the link between **Output 1(+)** and **Output 1(-)** of the host connector (regardless of **Master Symbol** or **Output 1** status).

Output 2 Pulse

Sending **<L2>** pulses activates the link between **Output 2(+)** and **Output 2(-)** of the host connector (regardless of **Master Symbol** or **Output 2** status).

Output 3 Pulse

Important: **Output 3** is used for the LED Light Control in the Verifier's default hardware configuration. However, if the Verifier is being used as a reader and the LED Light Control is *not* connected, **Output 3** can be configured in the same way as **Output 1** and **Output 2**.

Sending **<L3>** activates the link between **Output 3(+)** and **Output 3(-)** of the host connector (regardless of **Master Symbol** or **Output 3** status).

Disable Reader

Sending **<I>** will turn the reader **OFF**, end the current read cycle and not allow the reader to enter a read cycle until turned **ON**. This feature is useful during extended periods of time when no symbols are being scanned or the reader is being configured. Disabling the reader will not affect any downloaded commands to the reader.

Enable Reader

Sending **<H>** will turn the reader **ON** and allow it to enter read cycles.

Differences from Default

Clicking the **Differences from Default** button will cause **ESP** to check all stored configuration settings and compare them to default settings. All settings that are different than default will appear in the left column (shown below), and descriptions of those settings will appear in the right column.

Click this button for a list of **ESP** configuration settings that are different than default settings.

Click **Generate Barcode** to bring up the **Bar Code Dialog**. Then create configuration symbols containing the configuration commands of your choice.

<K200,4>	Mode (Serial Data)
<K201h,52>	Character (Delimited) (R)
<K220,,1000>	Read Cycle Timeout (1000)
<K470,0>	Code 39 (Disabled)
<K525,435>	Focus Distance (435)
<K529,,,1.0,,,,2>	Focus Position (Calibrate)
	Symbol Type (Don't Calibrate)
	Processing (High)
<K541,,30>	Gain (30)
<K714h,,5a5a5a5a>	Message (ZZZZ)
<K715h,,5a5a5a5a>	Bad Symbol Message (ZZZZ)
<K716h,,5a5a5a5a>	No Symbol Message (ZZZZ)

Send configuration settings to the reader without saving by clicking **Send to Reader**.

Click **Save As** to save the report as plain text or a tab-delimited text file.

Send configuration settings to the reader and save in ESP by clicking **Send and Save**.

- To create a symbol containing any of the command settings in the table, click **Generate Barcode**. This will bring up the **Bar Code Dialog**.
- To save the **Differences from Default** report, either as plain text or as a tab-delimited text file, click **Save As**.
- Click **Send and Save** to send the settings to the reader and save them, or **Send to Reader** to send the settings without saving them.

Important: The use the **Differences from Default** feature, you must connect to the reader and **Receive Reader Settings** via the **Send/Recv** button on the toolbar.



Master Database

Important: Master Database is used only for comparing entire symbols, when **Sequential** and **Wild Card** are NOT enabled, and **Start Position** is equal to **0**.

Master Database Overview

Usage: Used where more than one master symbol is required, as in a **Multisymbol** setup, for matching and other matchcode operations.

Definition: Allows you to define up to **10** master symbols as the master symbol database, which can be entered by keyboard, scanned in, displayed, or deleted by serial or **ESP** commands.

1. Click the **Master Database** tab.
2. Set the **Master Symbol Database Size**.
3. Select database index you want to enter the master symbol.
4. Do one of the following to enter master symbol data.
 - a) Double-click the index row to type data directly into index.
 - b) Click the **Read Symbol into Selected Index** to enter the next decoded symbol.

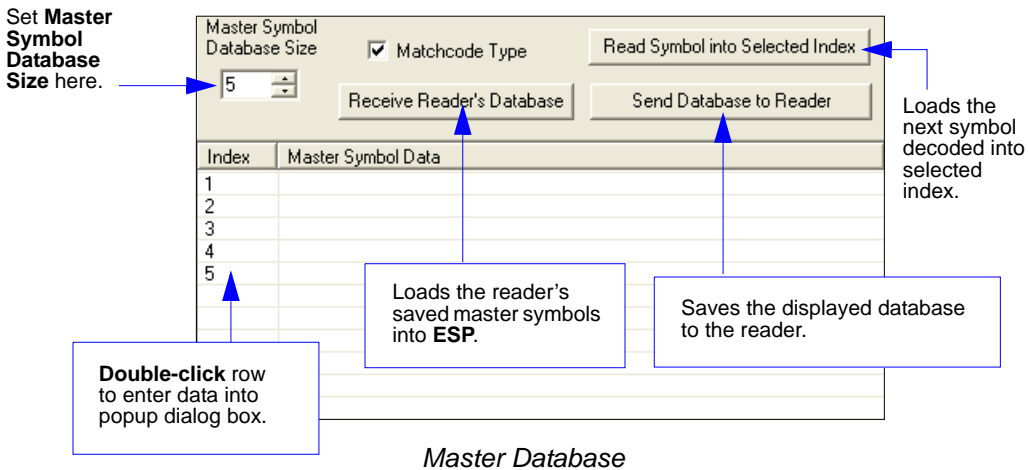

Important: Master Symbol Database is used only for comparing entire symbols, when **Sequential** and **Wild Card** are NOT enabled, and **Start Position** is equal to **0**.

Master Symbol Database Size

Definition: **Number of Master Symbols** allows you to select **1 to 10** master symbols for the master symbol database.

Serial Cmd: **<K231, master symbol database size>**

Note: You must follow this command with a save command **<A>** or **<Z>**.

Default: **1**

Options: 1 to 10

Use arrows to set
**Master Symbol
Database Size.**

Caution: Since the total number of characters available for the master symbol data base is **2710**, changes to the **Master Symbol Data Base Size** will re-allocate the number of characters available for each master symbol and could cause existing master symbols to be deleted (except master symbol # **1** unless it also exceeds the size limitation).

The table below specifies the maximum number of characters available to each symbol according to the number of master symbols defined, from **1** through **10**.

Maximum Characters for Master Symbol

Master Symbol Number	Maximum Characters	Master Symbol Number	Maximum Characters
#1	2710	#6	451
#2	1355	#7	387
#3	903	#8	338
#4	677	#9	301
#5	542	#10	271

Enter Master Symbol Data

Definition: Allows you to enter master symbol data for any enabled master symbol index number (1 to 10), provided the total number of characters does not exceed the maximum indicated in the **Maximum Characters for Master Symbol** table.

Serial Cmd: <K231, master symbol number, master symbol data>

Options: Enter data for 1 to 10 symbols (any combination of ASCII text up to the maximum indicated in **Maximum Characters for Master Symbol**). For example, to enter data for master symbol 5, after making certain that **Master Symbol Database Size** is enabled for 5 or more symbols (see **Master Symbol Database Size** table), send <K231,9,data>.

Caution: If no data is entered, the existing data will be deleted.

- ESP:**
1. Open the **Utilities** menu.
 2. Set the number of master symbols you want to create in **Master Symbol Database Size**.
 3. Double-click on each symbol number you want to set up and copy or type your data in the popup dialog and click **OK**.

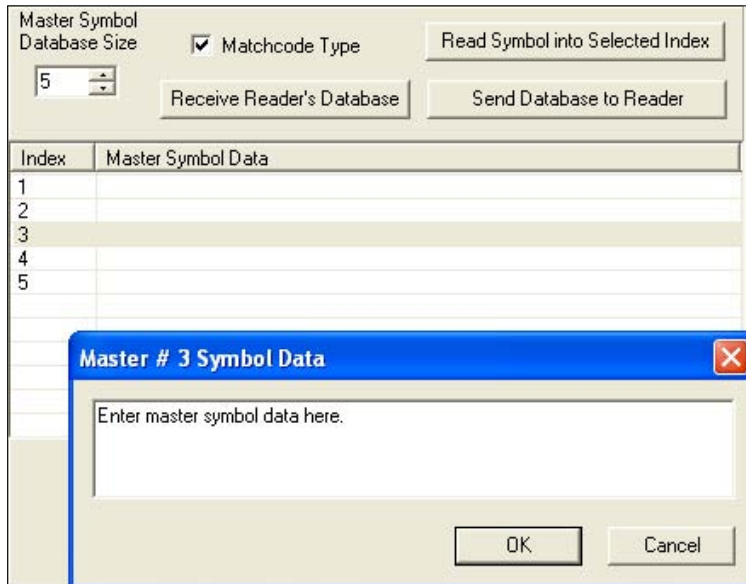

4. When all your data has been entered, click **Send Database to the Reader**.

Request Master Symbol Data

Definition: Returns master symbol data for any enabled master symbols from **1** to **10**. For example, to request master symbol # **5**, enter **<K231 ?,5>**. The reader transmits master symbol # **5** data in brackets in the following format: **<5/ data>**.

If no master symbol data is available, the output will be: **<5/>**.

Serial Cmd: **<K231 ?,master symbol number>**

Caution: Be sure to add the **?** or you will delete the master symbol.

Returns the number of master symbols if no number is included.

ESP:

1. Click the **Utilities** button and the **Master Database** tab.
2. Click on the **Receive Reader's Database** button.

Request All Master Symbol Data

Serial Cmd: **<K231 ?>**

This command will return master symbol data for all symbols enabled (up to 10).

Read Next Symbol as Master Symbol

Definition: After you've set the size in the database, you can set the reader to read the next symbol as the master symbol for any given master symbol number.

Serial Cmd: **<G master symbol number>**

To store the next symbol read as master symbol #1, send:

<G> or **<G1>**.

To store next symbol read as the master symbol for any other master symbol database number, send:

<G master symbol number [1-10]>.

For example, **<G5>** will cause the next symbol read to be entered as master symbol # **5**.

ESP:

In the **Master Database** tab:

1. Select the master symbol index number in which you want to store the symbol data.
2. Click on **Read Symbol into Selected Index**.

Caution: If you've selected an index which has existing data, that data will be copied over by scanned data when you use this command.

Request New Master Status

Usage: Informs the user when a new master symbol is pending and which position it is in.

Definition: Returns the position in the master symbol database that will be loaded on the next read.

Serial Cmd: **<NEWM>**

The reader returns: **<NEWM/next master to load>**

Once a symbol has been read and loaded, the status will be cleared and the response will be **<NEWM/0>**.

Delete Master Symbol Data

Definition: You can directly delete the master symbol data by serial command or **ESP**.

1. Click the **Utilities** button to access the master symbol:
2. Click the **Master Database** tab and double-click the symbol number you want to delete.
3. Delete text and click **OK**.

ESP:

Serial Cmd: **<K231, master symbol number,>**

To delete a master symbol, enter the database number and a comma, but leave the data field empty. For example, to delete master symbol # **5**, send the following **<K231,5,>**. The command is entered with a blank master symbol data field which tells the reader to delete the selected master symbol from the database.

Firmware

Firmware by ESP

The screenshot shows a software utility window with two main sections: "Firmware Update" and "Firmware Verification".

- Firmware Update:** Contains a dropdown menu labeled "App Code" and a "Start..." button.
- Firmware Verification:** Contains two rows of controls:
 - Row 1: A dropdown menu labeled "App Code", a "Request Part No." button, and an empty text input field.
 - Row 2: A dropdown menu labeled "App Code", a "Request Checksum" button, and an empty text input field.

Firmware Update

Application code versions are specific to your Verifier. Consult with your sales representative before downloading application code. If needed, an application code will be sent to you in the form of a ***.mot** file.

To download application code:

1. First, be sure that your Verifier is connected to the host.
2. Apply power to the Verifier.
3. Before updating, you should verify the current firmware.
4. Click in the Firmware Update text box and select the file type you want to download. This will open a file locator box.
5. Navigate to the appropriate file (it will be a ***.mot** file) and open the file.

Caution: Do not interrupt power or disconnect the host cable while download is in progress. Be sure that each download is complete before moving on to the next.

Important: When updating firmware, be sure that the application code and boot code versions are mutually compatible.

Firmware Verification

Request Part Number

You can send a request to the Verifier for part numbers, checksums, boot code, and application code.

By ESP

You can access **Part Numbers** from the **Utilities** menu.

1. Click the **Firmware** tab.
2. From the pulldown selection box to the left of the **Request Part No.** button, make your selection.
3. Select the code type to see its part number displayed in the text field to the right of the **Request Part No.** button.

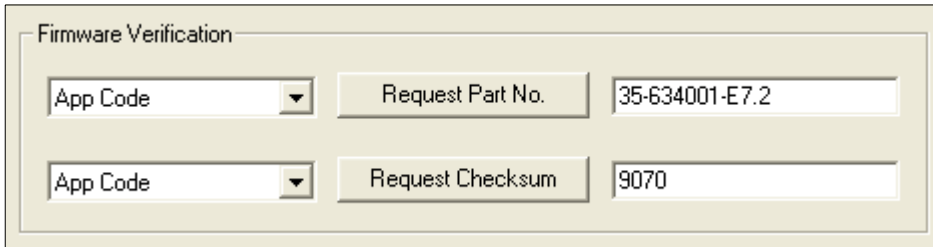

The screenshot shows a software interface titled "Firmware Verification". It features two rows of controls. The first row includes a dropdown menu labeled "App Code", a button labeled "Request Part No.", and a text input field containing the value "35-634001-E7.2". The second row includes another "App Code" dropdown menu, a button labeled "Request Checksum", and a text input field containing the value "9070".

By Serial Command

- When you send **<#>** (a request for all product part numbers), the Verifier returns:
<#b/BOOT_P/N><#a/APP_P/N><#p/PROFILE_P/N>.
- When you send **<#a>** (a request for the application code part number), the Verifier returns:
<#a/APP_P/N>.
- When you send **<#b>** (a request for the boot code part number), the Verifier returns:
<#b/BOOT_P/N>.
- When you send **<#p>** (a request for profile module part numbers), the Verifier returns:
<#p/PROFILE_P/N>.

Request Checksum

You can send a request to the Verifier for part numbers, checksums, boot code, and application code.

By ESP

You can access **Checksum** from the **Utilities** menu.

1. Click the **Firmware** tab.
2. From the pulldown selection box to the left of the **Request Checksum** button, make your selection.
3. Select the code type to see its checksum displayed in the text field to the right of the **Request Checksum** button.

The screenshot shows a dialog box titled "Firmware Verification". It contains two rows of controls. The top row has a dropdown menu labeled "App Code", a button labeled "Request Part No.", and a text field containing "35-634001-E7.2". The bottom row has a dropdown menu labeled "App Code", a button labeled "Request Checksum", and a text field containing "9070".

By Serial Command

- When you send **<!>** (a request for all available firmware checksums), the Verifier returns: **<!b/BOOT_CHECKSUM><!a/APP_CHECKSUM><!p/PROFILE_CHECKSUM>**
- When you send **<!a>** (a request for the application code checksum), the Verifier returns: **<!a/APP_CHECKSUM>**
- When you send **<!b>** (a request for the boot code checksum), the Verifier returns: **<!b/BOOT_CHECKSUM>**
- When you send **<!p>** (a request for profile module checksum), the Verifier returns: **<!p/PROFILE_CHECKSUM>**

Bar Code Configuration

Definition: Bar code configuration is a way of programming the reader by using Data Matrix ECC 200 symbols.

Serial Cmd: **<BCCFG>**

Bar code configuration can be entered three different ways:

1. By forcing the reader into bar code configuration mode by serial command **<BCCFG>**.
2. By configuring one of the 4 **EZ** button positions to **Bar Code Configuration Mode**.
3. By reading a Data Matrix symbol with a special codeword used by ISO/IEC 15415 to signify reader programming. This can be either in a regular read cycle or in read rate routine. Reading this symbol in the calibration routine will have no effect.

Once **Bar Code Configuration** mode has been entered, the Data Matrix symbols can be thought of as serial data. You can configure the reader by printing labels in Microscan's serial command format. Commands are processed as if the data were streamed in through the serial port. The reader will acknowledge the symbol with a beep, green flash, and echo the serial data to the host. If the command causes the reader to produce more serial output such as serial verification or counter requests, the data will be routed to the host port.

The **Bar Code Configuration** mode can be exited by any reset **<A>** or **<Z>** command, as well as a **<J>** or a quick press and release of the **EZ** button.

The command to exit bar code configuration can be included as part of the bar code, for example, encoding **<K200,4><K220,1><J>** into a Data Matrix symbol. This would configure the reader to serial trigger mode, program a new trigger to end the read cycle, and exit the bar code configuration mode with the **<J>**.

To end all **EZ** button functions, press the **EZ** button and quickly release.

Defaulting/Saving/Resetting

Understanding and controlling your reader's active, saved, and default settings is critical to the operation of your reader.

Software Reset/Save/Recall Commands

	<i>Function</i>	<i>Serial Cmd</i>	<i>ESP (first, right click in any menu tree)^a</i>	<i>EZ Button</i>
Resets (not saved for power-on)	Reset	<A>	Save to Reader, Send No Save	No
	Reset and recall Microscan defaults	<Ard>	No	No
	Reset and recall power-on parameters	<Arp>	No	No
	Reset and recall customer default parameters	<Arc>	No	No
Saved for Power-on	Save current settings for power-on	<Z>	Save to Reader, Send and Save	No
	Save current settings as customer default parameters	<Zc>	Save to Reader, Send and Save Customer Defaults ^b	No
	Recall Microscan default parameters and save for power-on	<Zrd>	No	No
	Recall customer default parameters and save for power-on	<Zrc>	No	Press and hold while powering on Reader

a. When you right click in a menu tree and select **Default Current Menu Settings** or **Default All ESP Settings**, it is important to note that only **ESP** settings are defaulted. To save these defaults to the reader itself, you need to follow up with a <Z> or **Save to Reader, Send and Save** command.

b. Only available in **ESP** if enabled under the **Options** pulldown menu.

Resets

Resets (<A> commands) affect only the current settings (active memory) and are not saved for power-on.

Saved for Power-On

Power-on parameters (<Z> commands) are saved to NOVRAM and recalled and loaded into current parameters when power is cycled or the <Arp> command is issued.

Defaults

Defaults are Microscan firmware settings or saved customer settings that can be recalled, either by software or hardware reset.

Customer Default Parameters

Customer default parameters (saved by **<Zc>**) are the same set of parameters as power-on parameters but are saved in a different, isolated section of NOVRAM. This allows a user to essentially create a backup set of parameters that can be recalled in the event that the current parameters or power-on parameters have been accidentally changed or no longer desired.

It is important to note that a hardware default does not affect customer default parameters. For example, a user that has inadvertently changed communication settings and saved them with a **<Z>** command, may not know the correct settings or doesn't have the capability to communicate at those settings. By first doing an **EZ** button or hardware default to restore the known Microscan defaults, the user can then recall the previously customer saved settings with an **<Arc>** or **<Zrc>** command.

Microscan Default Parameters

Microscan default parameters are contained in the firmware and cannot be changed.

Software Defaults

Microscan default parameters can be recalled (loaded into current settings) with **<Ard>** command or recalled and saved for power-on with the **<Zrd>** command.

Hardware Default

If a software default reset is not possible, it may be necessary to reset the reader by shorting (connecting) specific pins. This procedure has the same effect as the **<Zrd>** software command.

Important: For this reset to occur, this command must be executed within **60** seconds after a power-on or a reset.

1. Apply power to the reader.
2. If using an IB-150 Interface Kit, locate pins **7** and **11** on the host connector.
Caution: Be certain that the correct pins are located. Connecting the wrong pins could cause serious damage to the unit.
3. Momentarily connect these wires (or pins) and listen for a series of short beeps.
4. Within **3** seconds, connect them again. A longer beep should be heard. If not, repeat the process.

Default on Power-On

You can also use the **EZ** button to default the reader by holding down the **EZ** button while applying power to the reader, provided that this feature is enabled in **Default on Power-On (EZ Button)**.

Status Requests

<?> Status Byte

The Verifier responds to a status request <?> with a two character hex value, such as <?/22>. To determine status:

1. Look up the binary conversion in the table below.

For example, the first hex **2** would be **0 0 1 0** in binary, as read from binary digits 3 through 0; the second hex **2** is also **0 0 1 0** as read from binary digits 7 through 4.

2. Next, enter your binary values from the table below in the “Binary” column next to the appropriate bit.

Bit	Binary	Verifier Status
0	0	Command error detected
1	1	Command received
2	0	Communication error detected
3	0	Flash sector unprotect failure
4	0	Host/Aux port buffer overflow
5	1	Verifier is in a read cycle

3. Under “Binary,” interpret **1s** as true and **0s** as not true. For example, bit 1 has a **1** in the “Binary” column, indicating “Command Received”. Bit 5 is also a **1**, indicating that the “Verifier is in a read cycle”.

Hex Value	Binary Bit Digits			
	7	6	5	4
	3	2	1	0
0	0	0	0	0
1	0	0	0	1
2	0	0	1	0
3	0	0	1	1
4	0	1	0	0
5	0	1	0	1
6	0	1	1	0
7	0	1	1	1
8	1	0	0	0
9	1	0	0	1
A	1	0	1	0
B	1	0	1	1
C	1	1	0	0
D	1	1	0	1
E	1	1	1	0
F	1	1	1	1

<K?> All Status Request

This is the fastest way to learn the Verifier’s current configuration. Sending this request will return the current settings of all commands, starting with the lowest K command value and ending with the highest K command value.

<K??> All Descriptor Status Request

This request will return all current descriptors for every K command, starting with the lowest K command value and ending with the highest K command value.

<K?#> All Range Status Request

This request will return the current settings of all commands within the user-defined range, starting with the lowest user-defined K command value and ending with the highest user-defined K command value.

<Knnn?> Single Status Request

This request will return the value of the variables associated with the requested K command. The request of a single entry of a database command cannot exceed the number of database slots for the specific command.

<Knnn??> Single Descriptor Status Request

This request returns the basic functional description of all fields in the requested K command.

<Knnn?#> Single Range Status Request

This request will return the value range and storage type description of all fields in the requested K command.

Other Operational Serial Commands

The following serial utility commands can be entered from **ESP's Terminal** window or a PLC:

Y-Modem Upload Transfer Options

<uy,path,filename>

Y-Modem Download Transfer Options

<dy,path,filename>

Image Library Request

<op,9> Manages files in a selected directory.

File Source	Explanation
(Nothing)	All files in "root" directory
/	All files in "root" directory
/saved	All files in "saved" directory
.	All files in all directories
/del	Deletes all files in the root director
/saved/del	Deletes all files in the saved directory
del*.*	Deletes files in all directories

15 Output Format

Contents

- Output Format Serial Commands..... 15-2
- Output Format Status..... 15-3
- Format Assign 15-4
- Format Extract..... 15-5
- Format Insert 15-7
- Output Filter Configuration 15-9
- Ordered Output Filter 15-13

This section explains how to control the formatting and filtering of decoded symbol data for output.

Output Format Serial Commands

Format Extract	< K740 , <i>output index,start location,length</i> >
Format Insert	< K741 , <i>output index,length,hex string</i> >
Format Assign	< K742 , <i>symbol number,status</i> >
Format Status	< K743 , <i>output format status</i> >
Output Filter Configuration	< K744 , <i>filter number,symbology,length,wildcard character,placeholder,data,unused,database index</i> >
Ordered Output Filter	< K745 , <i>number of filters</i> >

Output Format Status

Definition: This is a global enable/disable parameter. In order to use formatting you must set up the format using the insert and extract commands, and you must also assign a symbol to format using the **Format Assign** command.

Serial Cmd: <K743,output format status>

Default: **Disabled**

Options: **0 = Disabled**
1 = Enabled

Output Format Status Disabled

When **Format Status** is set to **Disabled**, output formatting is globally disabled.

Output Format Status Enabled

When **Format Status** is set to **Enabled**, output formatting is enabled. However, **Format Assign**, **Format Insert**, and **Format Extract** must be properly set up as well.

Output Format Status by ESP

On the **Output Format** tab, check the **Enable Output Format** box.

Ordered Output Output Format

Enable Output Format Auto Sync with Reader

Set Number of Symbols: 1

Output Phrase

Preamble: CR Symbol #1 [QR code] Postamble: CR LF

Enable Parse Enable

Parse Symbols Send and Save Receive

Show Parse Table

Format Assign

Symbol Number

Definition: **Symbol Number** refers to the number of the symbol to which output formatting will apply. For example, if you wish to enable user-defined formatting to symbol # 2 in a multisymbol read cycle, you would send the command **<K742,2,1>**. Note that the number of symbols may exceed the format capabilities

Serial Cmd: **<K742, symbol number, status>**

- Options:** 1 to 10
- 1 = Formatted output status for symbol # 1.
 - 2 = Formatted output status for symbol # 2.
 - ...
 - 10 = Formatted output status for symbol # 10.

Status

Definition: **Status** refers to the user-defined formatting of a selected symbol position in the read cycle result. Note that there is also a global formatting “enable” command that must be set for the formatting to be applied.

Serial Cmd: **<K742, symbol number, status>**

Default: **Disabled**

Options: **0 = Disabled** 1 = Enabled (Assign parameters to specified symbol.)

Format Assign by ESP

The screenshot shows the 'Format Assign by ESP' dialog box. At the top, there is a checked checkbox for 'Enable Output Format'. Below it is a 'Set Number of Symbols' spin box set to 5. A blue callout box points to this spin box with the text: 'Use the **Set Number of Symbols** spin box to determine the number of symbols to be included in the output phrase.' Below this is the 'Output Phrase' section, which includes a 'Preamble' field with 'CR', a 'Symbol Separator' field with a comma, and a 'Postamble' field with 'CR LF'. There are five symbol positions: Symbol #1, Symbol #2, Symbol #3, Symbol #4, and Symbol #5. Each position has a QR code icon and a 'Parse' checkbox. Symbol #1, #2, and #3 have their 'Parse' checkboxes checked. Symbol #4 and #5 have theirs unchecked. A blue callout box points to the 'Parse' checkboxes with the text: 'Then check the **Parse** boxes beneath the symbols that you wish to format for user-defined output.' At the bottom, there is an 'Enable' checkbox which is checked.

Format Extract

Output Index

Definition: **Output Index** refers to the database entry you wish to modify with this command. A formatted output is built by *extracting data from a symbol's original data output* and/or inserting user-defined characters.

It may be helpful to think of individual indexes as positions in the final formatted output you wish to build. Starting with index # 1, enter either an extract or insert command to begin building your desired output string. Then, with the next index number, enter either an extract or insert command to continue building the output string. Continue this process until you are finished building the string.

Serial Cmd: <**K740,output index,start location,length**>

Options: 1 to 100

Start Location

Definition: Defines the location within the symbol data where the character extraction will begin. The first character extracted will also be the first character in the sequence displayed in user-defined output.

Serial Cmd: <**K740,output index,start location,length**>

Default: **0**

Options: 1 to *n* (maximum number of characters in the symbol data).

Length

Definition: Defines the length (in consecutive characters) that will be extracted and placed in user-defined output.

Serial Cmd: <**K740,output index,start location,length**>

Default: **0** (disabled; end of format cell array)

Options: 1 to *n* (maximum number of characters in the symbol data).

Format Extract by ESP

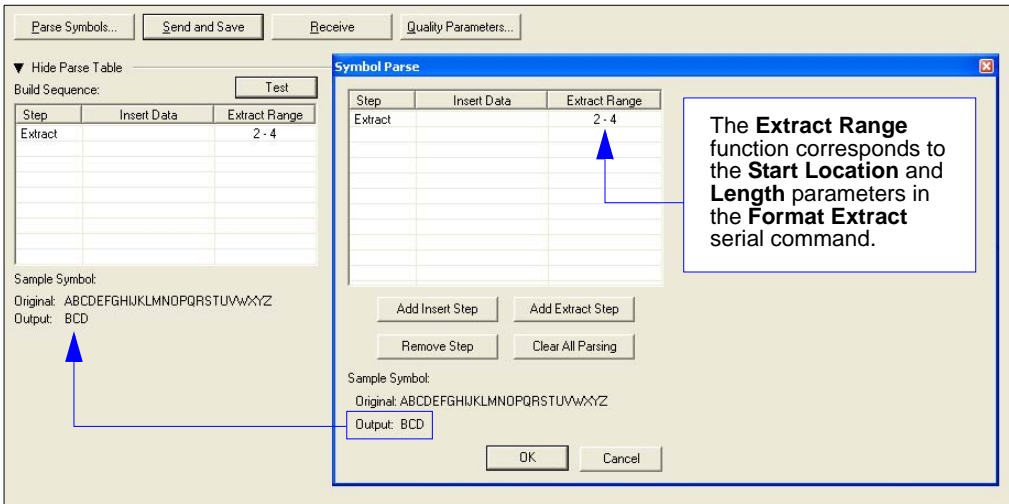

You can extract and insert several character sequences using **ESP's Symbol Parse** feature. In this example, the selected extraction range is characters 2-4. The "Sample Symbol" example on the **Symbol Parse** dialog shows the selected character positions extracted and output as desired. Simultaneously, the data string from the actual selected symbol is displayed at the bottom left of the **Parse Table**, followed by the user-defined extracted output.

Format Insert

Output Index

Definition: **Output Index** refers to the database entry you wish to modify with this command. A formatted output is built by extracting data from a symbol's original data output and/or *inserting user-defined characters*.

It may be helpful to think of individual indexes as positions in the final formatted output you wish to build. Starting with index # 1, enter either an extract or insert command to begin building your desired output string. Then, with the next index number, enter either an extract or insert command to continue building the output string. Continue this process until you are finished building the string.

Serial Cmd: <**K741**,*output index*,length,hex string>

Options: 1 to 100

Length

Definition: Specifies the length of the user-defined character string that will be inserted. This function is limited to 4 characters per output index, so multiple indexes must be entered in order to insert longer character sequences.

For example, if you wish to insert a 10 character sequence in user-defined output, you would need three commands with consecutive index numbers, where the first two character sequence lengths were 4 and the third was 2.

Serial Cmd: <**K741**,*output index*,length,hex string>

Default: **0** (disabled; end of format cell array)

Options: 1 to 4

Hex String

Definition: Specifies a character string that represents ASCII characters to be inserted in the database entry. Two hex characters are required for every ASCII character to be inserted in the user-defined output string. These two characters comprise the hex (base 16) value of the ASCII character.

For example, if you wanted to enter the three-character sequence "Hi!" you would enter **3** for the length of the string, and a hex sequence of **486921** for the ASCII sequence to be inserted. (48 = H; 69 = i; 21 = !)

Important: Each pair of hex characters represents one ASCII character. Hex character pairs range from 00 to FF. Since you are limited to 4 ASCII characters per insertion per database entry, you are likewise limited to 8 hex characters per insertion per database entry.

Serial Cmd: <**K741**,*output index*,length,hex string>

Default: **NULL (00)**

Options: 00 to FF (As many as 4 bytes, or hex pairs.)

Format Insert by ESP

Symbol Parse

Step	Insert Data	Extract Range
Insert		

Add Step Remove Step Clear All Parsing

Sample Symbol Parse:
Original: ABCDEFGHIJKLMNOPQRSTUVWXYZ0123456789
Output:

OK Cancel

Insert

SP	SP			
SOH	STX	ETX	EOT	ENQ
ACK	BEL	BS	HT	LF
VT	FF	CR	SO	SI
SI	DC1	DC2	DC3	DC4
NAK	SYN	ETB	CAN	EM
SUB	ESC	FS	GS	RS
US	SP			

Click 'Delete' to remove characters.

OK Cancel

The **Format Insert** process is very similar to the **Format Extract** process, except that **Insert** allows you to enter characters using the Insertion Calculator (shown above).

Parse Symbols Send and Save

Hide Parse Table

Build Sequence: Test

Step	Insert Data	Extract Range
Insert	SP SP	
Extract		3 - 5

Add Step Remove Step Clear All Parsing

Sample Symbol Parse:
Original: micro
Output: cro

Notice that **Extract** and **Insert** share the same **Parse Table**.

Symbol Parse

Step	Insert Data	Extract Range
Insert	SP SP	
Extract		3 - 5

Add Step Remove Step Clear All Parsing

Sample Symbol Parse:
Original: ABCDEFGHIJKLMNOPQRSTUVWXYZ0123456789
Output: CDE

OK Cancel

Output Filter Configuration

Definition: Output filtering is a method of providing a set of good read qualifiers and also providing ordered output. There is a filter for up to the first 10 positions in a multisymbol output. The first filter corresponds to the first symbol output at the end of the read cycle. Each filter has settings for the following four parameters: **Symbology Type**, **Symbol Length**, **Data**, and **Configuration Database Number**.

Serial Cmd: <**K744**, filter number, symbology type, length, wildcard, placeholder, data, unused, database index>

Rules for Output Filter Configuration

Output Configuration Rule # 1

Each symbol that is decoded must match one of the filters before it can be saved to a read cycle record. There is an exception to this rule, however, when the number of symbols required for a read cycle exceeds the number of active filters. In such a case, unfiltered symbols can be placed into unfiltered output positions.

For example, if the number of symbols required is 6 but there are only 4 active filters, the last 2 positions can be filled by any (unfiltered) qualified symbol.

Output Configuration Rule # 2

The same filter setup can be used multiple times.

For example, filters 1, 2, and 3 can be set up to filter Data Matrix symbols, and the output will occur in the order the symbols are decoded.

Output Configuration Rule # 3

All qualified symbols will be sorted and output in the matching filter position. If a symbol matches filter 3, it will be output as the third symbol. If a filter does not have a matching qualified symbol, a No Read message will be output in place of the symbol (assuming the No Read message is enabled).

For example, if there is not a symbol that meets filter 3's requirements, then a No Read message will be output in the third output position.

Filter Number

Definition: This is the filter index number that represents the position of the symbol in the data output at the end of the read cycle. This index number should be entered along with the following filter settings for the predetermined symbol position.

Serial Cmd: <**K744**, **filter number**, *symbology type*, *length*, *wildcard*, *placeholder*, *data*, *unused*, *database index*>

Options: 1 to 10

Symbology Type

Definition: Specifies the symbology type allowed to occupy this location in multi-symbol output.

Note: To filter or order a symbol, the symbol must meet all the requirements of the selected filter index.

Serial Cmd: <**K744**, *filter number*, **symbology type**, *length*, *wildcard*, *placeholder*, *data*, *unused*, *database index*>

Default: **Any type**

Options: **0 = Any type**

1 = Interleaved 2 of 5

2 = Code 39

3 = Code 128

4 = Codabar

5 = UPC

6 = PDF417

7 = EAN 128

8 = Code 93

9 = PharmaCode

10 = RSS

11 = MicroPDF417

12 = Composite

13 = BC412

14 = Data Matrix

15 = QR Code

Length

Definition: Specifies the length of the decoded symbol allowed to occupy this location in multi-symbol output.

Note: To filter or order a symbol, the symbol must meet all requirements of the selected filter index.

Serial Cmd: <**K744**, filter number, symbology type, **length**, wildcard, placeholder, data, unused, database index>

Default: **0**

Options: 0 to 64

Wildcard

Definition: This is the character to be used in the data output field when performing a data filter comparison. The wildcard character represents the end of matching, and allows for variable lengths of symbol output.

Serial Cmd: <**K744**, filter number, symbology type, length, **wildcard**, placeholder, data, unused, database index>

Default: “ * ” = **2A** (hex)

Options: Any ASCII input in the form of a pair of hex characters.

Example:

2A = *

00 = disabled

Placeholder

Definition: The placeholder character requires a character to be present, but does not compare the data value.

Serial Cmd: <**K744**, filter number, symbology type, length, wildcard, **placeholder**, data, unused, database index>

Default: “ ? ” = **3F** (hex)

Options: Any ASCII input in the form of a pair of hex characters.

Example:

3F = ?

00 = disabled

Data

Definition: This is the data string to be used when comparing symbol data for output filtering and ordering. This data string may also contain wildcard and placeholder characters to facilitate matching. Remember that in order to filter or order symbol data, it must meet all the requirements of the selected filter index.

Examples:

- Filter data = "123*". This will match data strings of "123", "123456", and "123ABC", but not "12".
- Filter data = "123*AB?C". This will be interpreted as "123**".
- Filter data = "123?". This will match "1234" and "123A", but not "123", "12345", or "1234C".
- Filter data = "123?A". This will match "1234A" and "123BA", but not "123", "1234C", or "1234ABCD".
- Filter data = "123?A?". This will match "1234AB" and "123BAT", but not "1234A" or "123BATS".
- Filter data = "12??*". This will match "1234", "123456", and "123ABC", but not "12" or "123".
- Filter data = "123?A*". This will match "1234A", "123BA", and "123BATS", but not "1234" or "1234C".

Serial Cmd: <**K744**, filter number, symbology type, length, wildcard, placeholder, **data**, unused, database index>

Default: (00)

Options: Any ASCII input in the form of a pair of hex characters.

Examples:

41422A = AB*

Data (00) = **NULL** represents string matching disabled.

Database Index

Definition: The index of the database entry that decodes a given symbol must equal this setting for filtering to occur. A setting of 0 allows any database index for this filter entry.

Serial Cmd: <**K744**, filter number, symbology type, length, wildcard, placeholder, **data**, unused, **database index**>

Default: 0 (any index)

Options: 0 to 10

Ordered Output Filter

Definition: **Number of Filters** refers to the number of active output filters. **0** disables all output filters. Any non-zero numeral will enable filtering to be performed using the filter indexes covered by this value.

For example, if the number of filters is **1**, then only filter index # 1 will be applied. If the number of filters is **2**, then only filter index # 1 and filter index # 2 will be applied, etc.

Serial Cmd: **<K745,number of filters>**

Default: **0**

Options: 0 to 10



16 Ethernet

Contents

Step 1 Setup..... 16-2
Step 2 Preliminary Steps..... 16-3
Step 3 Communicating in Ethernet..... 16-7
Step 4 Ethernet Application..... 16-8

While it is possible to connect the Quadrus Verifier directly to your host computer by Ethernet TCP/IP, typical usage is in a networked environment with either a switch or router.

Step 1 — Setup

For Ethernet setup, you will need:

1. A Quadrus Verifier.
2. An Ethernet/USB interface.
3. An IB-150 Kit (interface and cable).
4. An Ethernet switch or router.
RJ45 Ethernet cables (use a crossover cable if connecting directly to the host computer).
5. A laptop or desktop host computer with Ethernet connectivity to a network, Windows Vista, XP, or 2000, and Microscan's **ESP**.

Step 2 — Preliminary Steps

1. Plug the Ethernet/USB interface into the Quadrus Verifier.
2. Plug the IB-150 Interface Kit cable into the Ethernet/USB interface and make the connection to the host computer and power supply.
3. Connect the Ethernet cables from the Ethernet/USB interface to the switch or router and from the switch or router to the host computer.
The green **NETWORK STATUS** LED should illuminate when the Ethernet cable is connected.
4. Start **ESP** and establish communication with the host computer through the RS-232 host port.

There are three ways the Quadrus Verifier can connect to a host by Ethernet:

1. Assigning a network address.
2. Using the Verifier's default **IP Address**.
3. Using **DHCP** (Dynamic Host Configuration Protocol) assignment.

Assigning a Network Address

This procedure will configure the Verifier to work with the host computer's TCP/IP configuration.

Note: This is only a temporary solution. The preferred method is to receive **IP Address**, **Subnet**, and **Gateway** (if necessary) from your IT department.

If an IP Address has been assigned to the Verifier by your IT department (the preferred method), skip steps 1-3 below.

1. Determine the host computer's IP Address on the host's network.
Go to the Windows Start menu, select **Run**, type "command", and press **Enter**.
 - a) On computers running a Windows2000 operating system, type "ipconfig" at the command prompt.
2. Add **1** to the last decimal value of the host computer's IP Address. This will be the address that you assign to the Verifier.
For example, if the host computer's address is 123.234.1.**25**, the Verifier's address will be 123.234.1.**26**.
3. To be sure that the new IP Address is available, go back to the command prompt and type: "ping [Verifier IP Address]".
For example: **ping 123.234.1.26**.

If the ping program responds with a **Request timed out** message, then the **IP Address** can probably be used temporarily. If you receive a **Reply** message, then that address has already been assigned to another device and you need to contact your IT department for an available IP Address.
4. Send a **Receive Reader Settings** command.
5. From **ESP's Communications** menu, enter your Verifier's new IP Address.
For example, **123.234.1.26**. Save this to the Verifier.

The Verifier now has an IP Address that will allow communication with the host computer. In **ESP's Communications** menu, you will see the view shown at right.

6. Go to Step 3, **Communicating in Ethernet**.

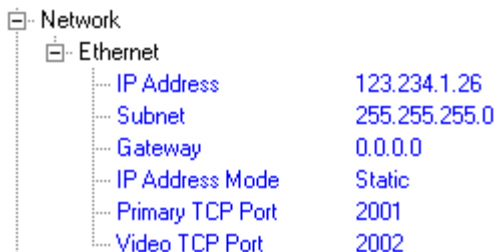

Network	
Ethernet	
IP Address	123.234.1.26
Subnet	255.255.255.0
Gateway	0.0.0.0
IP Address Mode	Static
Primary TCP Port	2001
Video TCP Port	2002

Using the Verifier's Default IP Address

Note: This procedure is only used when the Verifier is directly connected to the computer. Also, this is only a temporary solution since the preferred method is to receive **IP Address**, **Subnet**, and **Gateway** (if necessary) from your IT department.

1. Determine the host computer's IP Address on the host's network.
Go to the start menu, select **Run**, type "command", and press **Enter**.
 - a) On computers running a Windows 2000 operating system, type "ipconfig" at the command prompt.
2. Note the IP Address of the host computer.
3. At the Windows command prompt, type "route add 192.168.0.100 [host computer IP Address]" and press **Enter**. This adds the Verifier's IP address to the computer's routing table.
4. At the Windows command prompt, type "route print" and press **Enter**.
5. Look for **192.168.0.100** in the **Network Destination** column. If it does not appear in the Network Destination column, contact your IT department.
6. Go to Step 3, [Communicating in Ethernet](#).

Using DHCP to Configure the Verifier

This option assumes that the Quadrus Verifier is connected to a network with a **DHCP** server. RS-232 configuration is required to enable the Verifier's DHCP client (default **IP Address Mode** setting is **Static**, which disables DHCP).

1. Send a **Receive Reader Settings** command.
2. Under **Network** in **ESP's Communications** menu, double-click on **IP Address Mode** and change **Static** to **DHCP**.

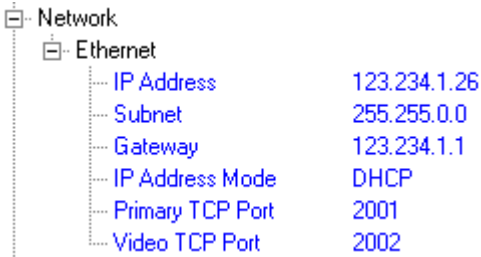

The screenshot shows a tree view of the configuration menu. The 'Network' folder is expanded to show the 'Ethernet' folder. The 'Ethernet' folder is also expanded to show the following settings:

IP Address	123.234.1.26
Subnet	255.255.0.0
Gateway	123.234.1.1
IP Address Mode	DHCP
Primary TCP Port	2001
Video TCP Port	2002

3. Right-click on the **Communications** menu and send **Save to Reader > Send no Save**.
4. Send a **Receive Reader Settings** command.
5. Notice that the network will have assigned new numbers to the **IP Address**, **Subnet**, and **Gateway**. (If the numbers have not changed, contact your IT department.)
6. Go to Step 3, [Communicating in Ethernet](#).

Step 3 – Communicating in Ethernet

By now either the Verifier should be configured with an IP Address, or the host computer should be configured to use the Verifier's default IP Address. Now **ESP** needs to be configured.

1. Select **Settings...** from **ESP's Connect** dropdown menu.
2. Click the **TCP/IP** tab.

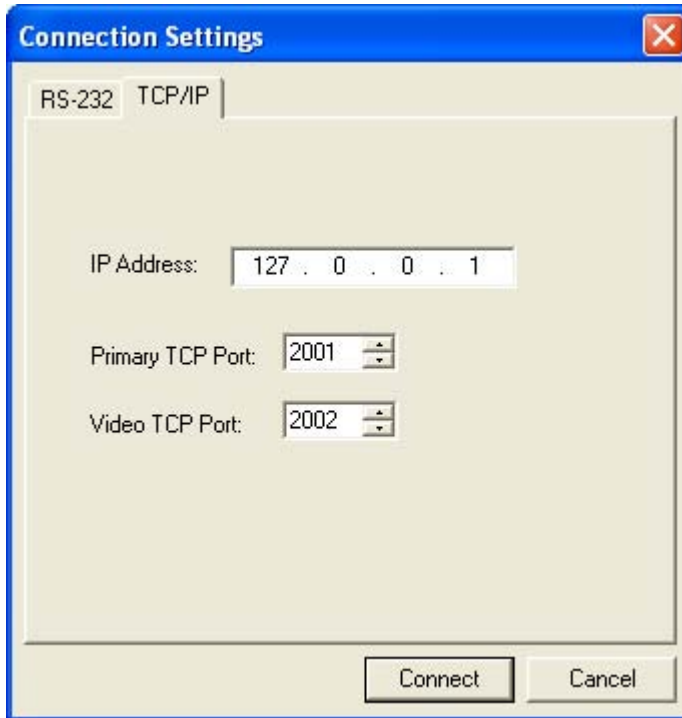

3. Type the Verifier's IP Address as it is shown on the **Communications** menu.
4. Click **Connect**.
5. After a few seconds, **ESP** should display **CONNECTED** at the bottom of the window.

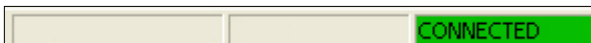

Step 4 — Ethernet Application

The Quadrus Verifier supports the Microscan communication protocol for Verifiers over two TCP/IP ports. This is the same protocol that is supported through the Verifier's RS-232 Host serial port. Note that on Ethernet, the Quadrus Verifier is a server device, which requires the host to establish the connection. Once the connection is established, however, the Verifier will send symbol data and diagnostic message data whenever it is generated.

Network Protocols Supported

The Quadrus Verifier supports the following RFC-compliant protocols:

IP	RFC0791, RFC950
ICMP, PING	RFC0792
TCP	RFC0793
Sockets	BSD v4.3
ARP	RFC0826
DHCP client	RFC0951, RFC1541, RFC2131, RFC2563 partial support
TFTP server	Revision 2, RFC1350

Communication with the Quadrus Verifier can be established via a Telnet client (raw data only, no IAC command processing), or through a custom “sockets” application. The Quadrus Verifier becomes a “server” device. It listens for connection requests from the Host before communication can begin. All Quadrus Verifiers have a unique 48-bit hardware (MACID) address. This address is printed on the Verifier's product label.

Microscan Protocol/Host RS-232 Supported

- Configuration Commands (K commands)
- **ESP** interface commands (<op> commands)
- Utility commands <A> - <Z>
- Host preamble <K141> and postamble <K142> strings are added to command responses and symbol data.
- All data formatting is supported (<K740>, <K741>).

Differences from Other Protocols

- Y-Modem is not supported. This includes the **Firmware Download** command <dy> and the **Image Send** command <uy>.
- An immediate response to the Verifier's **Status** command <?> is not sent. The response is queued for output between read cycles. Also, the response is formatted with host port preamble and postamble characters.
- Aux port (RS-232) interaction is not supported for transferring data between Ethernet and the aux port (**Transparent**, **Half Duplex**, and **Full Duplex**). These modes only function with the Host RS-232 port, and are not affected by Ethernet.
- Responses to “binary frame” commands from the **Video TCP Port** are sent, when connected. If not connected, the response will be sent to the **Primary TCP Port**.

Primary (Command) TCP Port

This port is used for all command processing and data outputs (except “binary frame” command responses). The application protocol used is the same as the Host RS-232 port.

Video TCP Port

The **Video TCP Port** is transmit-only (output from the Verifier, read-only by the host), and is used for “binary frame” data outputs as follows:

1. Response to **Image Send** command **<op,4>**.
2. Response to **Capture and Decode** and **Save** command **<op,5>**.
3. Response to **Symbol Information** command **<op,8>**.
4. Response to **Histogram** command **<op,14>**.

The primary purpose of this port is for access to a dedicated video stream, for **ESP** functions in particular. Because the format of the “binary frame” data is quite different from the Verifier's other command responses and outputs, sending this data on a dedicated, independent TCP port facilitates easier **ESP** implementation. Also, end users who wish to implement their own applications may find this useful since it has a consistent data type and provides access to a port whose only traffic is that which the host application has initiated.

The Video TCP Port is read-only from the host's perspective. The Verifier does not receive any data or commands on this port. The Verifier only processes commands from the primary (Command) TCP port. Also, the Verifier only responds to the video port if the video port has a connection to the host and a command is received that requires a “binary frame” response. If the video port is unconnected, the Verifier will respond to the primary port. This allows hosts the option to operate via a single port.

Image File Transfers

The Verifier's image files can be accessed with either “binary frame” commands **<op,4>** and **<op,5>**, or **TFTP** (Trivial File Transfer Protocol).

Binary Frames

These are primarily intended for **ESP**'s “near-real-time video” purposes. Although it is possible to get a full-size image from the Verifier using an **<op,4>** or **<op,5>** command, for quicker response, it is recommended that TFTP be used.

TFTP Server

A TFTP client can access the Verifier's image files (the Verifier is a TFTP server). Since TFTP does not support a directory structure, the host application must know the Verifier's file naming convention, or request an image list from the Verifier through the primary TCP/IP port (or RS-232 port) with the **<op,9>** command.

Limitations

The largest data size per packet (TCP MSS/MTU) the Verifier can receive and transmit is approximately 550 bytes. Since TCP/IP is used, this will not prevent larger data transmissions, but it will limit throughput.

An MTU of 550 may be somewhat limiting for some networks, but this should not prevent successful operation.

Appendices

- Appendix A General Specifications.....A-2
- Appendix B Electrical Specifications.....A-4
- Appendix C Connectivity AccessoriesA-8
- Appendix D Serial Configuration CommandsA-11
- Appendix E ASCII TableA-17
- Appendix F Data Matrix Symbology.....A-19
- Appendix G Object DetectorA-20
- Appendix H Operational TipsA-21
- Appendix I Embedded Menus.....A-22
- Appendix J Interface Standards.....A-23
- Appendix K Glossary of TermsA-24

Appendix A — General Specifications

Mechanical

Height: 9.88" (251 mm)

Width: 5.05" (128 mm)

Depth: 4.75" (121 mm)

Weight: ~60 oz. (~1,700 g)

Environmental

Operating Temperature: 0° to 43°C (32° to 109°F)

If mounted on non-metal surface, maximum operating temperature is 40°C (104°F)

Storage Temperature: -50° to 75°C (-58° to 167°F)

Humidity: Up to 90% (non-condensing)

Emissions/Immunity

ITE Disturbances: IEC 55022:1998 (radiated and conducted)
Class A

General Immunity: IEC 55024:1998 (residential)

Heavy Industrial Immunity: IEC 61000-6-2:1999

LED Radiation: IEC 60825-1

Light Source

Type: High output LEDs

External (45°, 30°): 660 nM

Light Collection

CCD array: 656 x 496 pixels

Video Output

Signal System: EIA (RS-170)

Number of Scanning Lines: 525 lines/2:1 interlaced

Output: Analog 1Vp-p/75 ohm

Communications Protocols

Interface: RS-232, Ethernet

Symbology

Data Matrix (ECC 0-200)

Symbol Verification Parameters

Maximum Characters: 78 characters plus overhead characters at a 45° angle.

Verification Standards

For Data Matrix: AIM DPM, ISO/IEC 15415, AS9132

Verifier Certification: ISO/IEC 15426-2

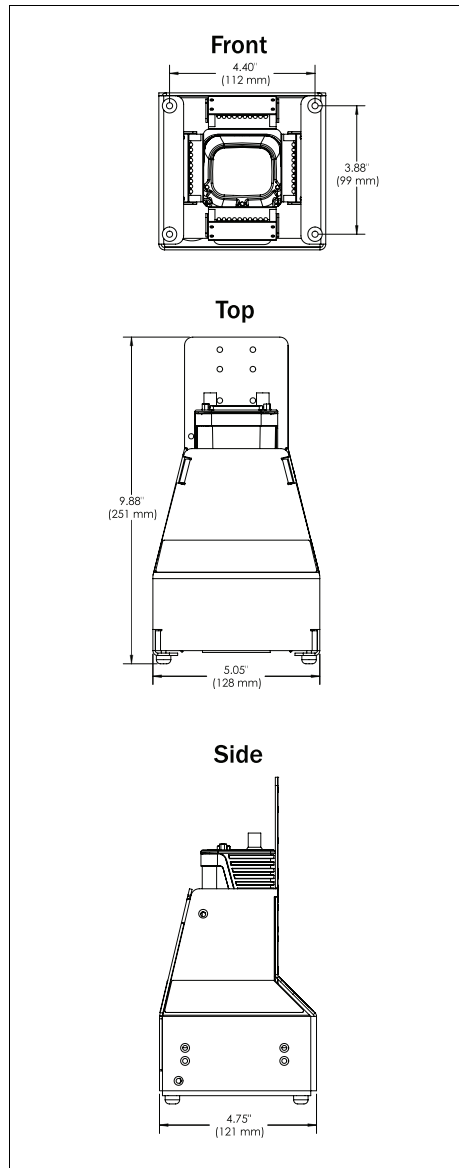

Verifier Dimensions

Indicators

LEDs: Read Performance, Power, Read Status, Network Status

Beeper: Read Performance, Power, Read Status, Network Status

Safety Certifications

Designed for: FCC, CE



ISO Certification

ISO 9001:2000

Issued by TUV USA Inc., Member of TUV NORD Group, Cert. No. 06-1080

Product specifications are given for typical performance at 25°C (77°F) using grade A symbols. Some performance characteristics may vary at high temperatures or other environmental extremes.

©2007 Microscan Systems, Inc.

Specifications subject to change.

Appendix B — Electrical Specifications

Power Requirements: Input, 10 to 28 VDC, 200 mV p-p max ripple, 333 mA at 24 VDC

Trigger, New Master, Input 1: (Optoisolated) 5 to 28 VDC rated (12 mA at 24 VDC)

Outputs 1/2: (Optoisolated) 1 to 28 VDC rated ($I_{CE} < 100$ mA at 24 VDC, current limited by user)

Output 3: Light control (Optoisolated) 1 to 28 VDC rated ($I_{CE} < 100$ mA at 24 VDC, current limited by user)

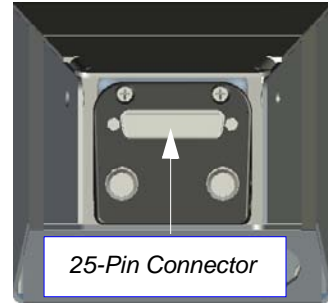

Quadrus Verifier Host 25-Pin Connector

Pin	Host RS-232	Host and Aux RS-232	Ethernet	I/O
1	Chassis Ground ^a			
2		TxD		Out
3		RxD		In
4	RTS		TxD	Out
5	CTS		RxD	In
6	Output 1 (+)			Out
7	Signal Ground ^b			
8	Output 2 (+)			Out
9	Trigger (-)			In
10	Trigger (+)			In
11	Default Configuration ^c			In
12	Input 1 (+)			In
13			RxD (+)	In
14			RxD (-)	In
15	Light Control (+)			Out
16			TxD (-)	Out
17	Power Ground ^d			
18	Power + 10 to 28 VDC			In
19			TxD (+)	Out
20	Output 1 (-)			Out
21	Output 2 (-)			Out
22	Light Control (-)			Out
23	Input 1 (-)			In
24	New Master (-)			In
25	New Master (+)			In

a. Chassis Ground: Used to connect chassis body to earth ground only. Not to be used as power or signal return.

b. Signal Ground: Used for communication and signal line grounds only. Not to be used as power or chassis return.

c. The default is activated by connecting pin 11 to ground pin 7.

d. Power Ground: Used for power return only.

CAUTION: If using your own power supply, verify correct connection of power and ground lines. Incorrect connections or use of Chassis Ground, Power Ground, and Signal Ground lines could equipment failure or software failure.

Optoisolator Outputs

Optoisolator circuits can transfer pulses between the Verifier and peripherals with no direct connection with the Verifier's internal circuitry. However, not every optoisolator configuration provides complete isolation. The following diagrams show both fully optoisolated and non-optoisolated circuits. They are only examples and do not represent all the possible wiring configurations.

	Iload=5mA	Iload=50mA	Iload=100mA
VOut-On	0.5V	0.5V	1.0V
tOn-Typ	5mS	0.7mS	0.8mS
tOff-Typ	5μS	5μS	5μS

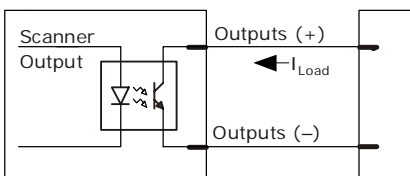

Output Circuit Examples

Fully Optoisolated

This circuit is fully optoisolated and the recommended configuration. It allows the user to apply 1 to 28 VDC to the circuit.

Caution: The maximum current that can pass through the optoisolator is 100mA.

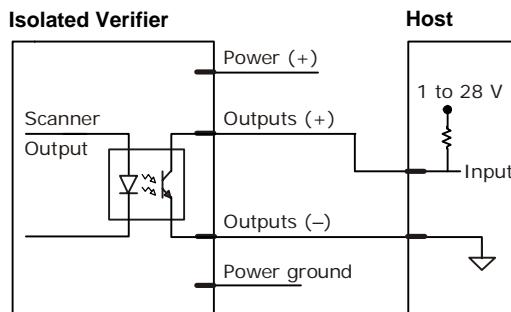

Not Optoisolated, Verifier Grounded

In this diagram, power is applied externally, but the Verifier's power ground is used to complete the circuit. This setup involves some risk to the optoisolator if excessive voltages are applied.

Caution: The maximum current that can pass through the optoisolator is 100mA.

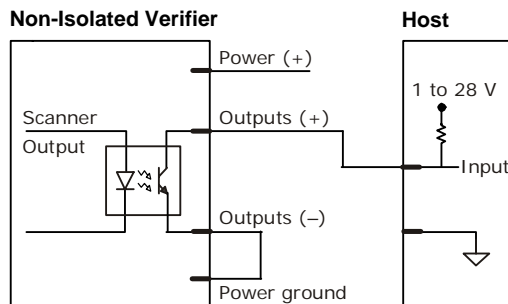

Additional Isolated Output Circuit Examples

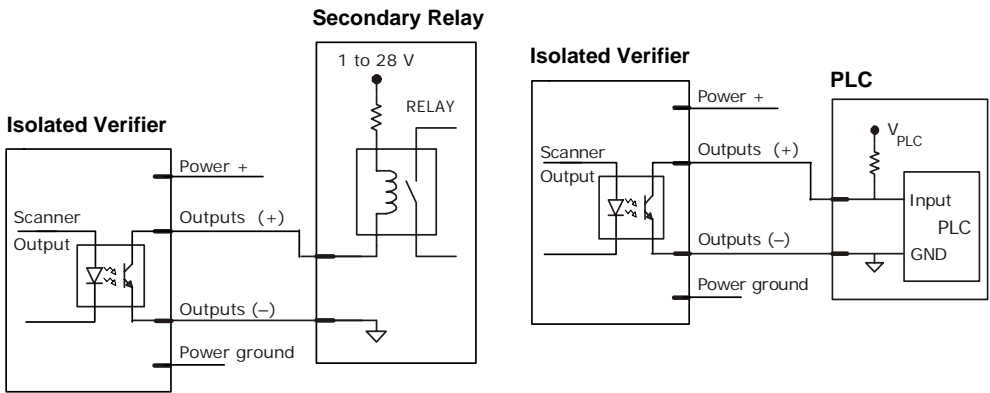

Optoisolator Inputs

All discrete inputs can be fully isolated pulses as PNP or NPN circuits. Inputs include Trigger, New Master, and Input 1.

Generic Waveform Characteristics

	Minimum	Maximum
VIN-HIGH/IIN-HIGH	4.5V/4mA	28V/12mA
VIN-LOW/IIN-LOW	0V/0mA	2V/2mA
Pulse Width min.	48 μ S	

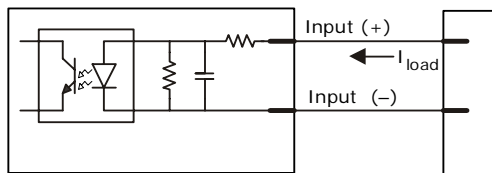

Input Examples

Fully Optoisolated

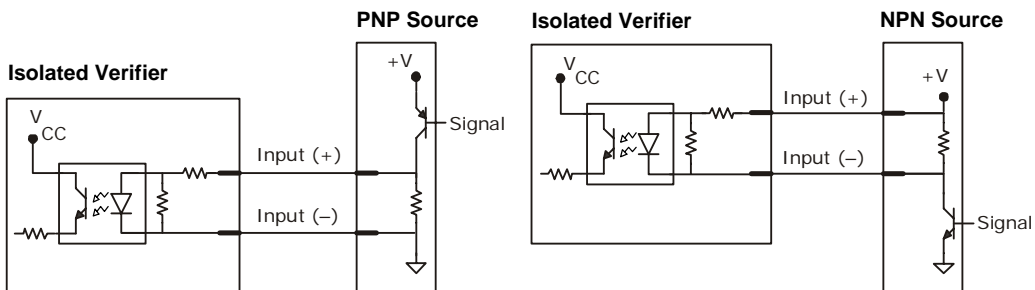

Not Optoisolated

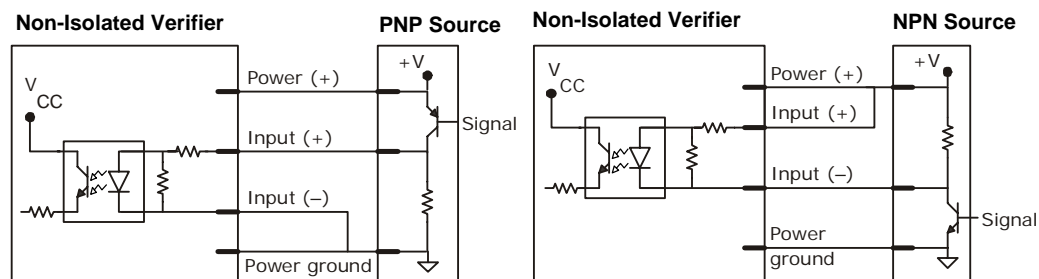

Appendix C — Connectivity Accessories

Three interface options are available for Verifier connectivity.

IB-150 Kit

The IB-150 Interface Kit links the Verifier to the host, power supply, trigger, and aux port connections. In addition to multidrop and daisy chain hookups, the aux port can plug into the terminal strip interface.

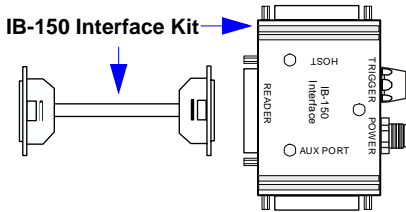

Port Connectors

Pin	Verifier	Host	Aux Port
1	Chassis ground	Chassis ground	Chassis ground
2	TxD	TxD	RxD
3	RxD	RxD	TxD
4	RTS/Aux TxD	RTS/Aux TxD	NC
5	CTS/Aux RxD	CTS/Aux RxD	NC
6	Output 1 (+)	Output 1 (+)	Output 1 (+)
7	Signal GND	Signal GND	Signal GND
8	Output 2 (+)	Output 2 (+)	Output 2 (+)
9	Trigger (-)	Trigger (-)	Trigger (-)
10	Trigger (+)	Trigger (+)	Trigger (+)
11	Default	Default	Default
12	Input 1 (+)	Input 1 (+)	Input 1 (+)
13	RxD (+)	RxD (+)	RxD (+)
14	TxD (-)	TxD (-)	TxD (-)
15	Light Control	Light Control	Light Control
16	RxD (-)	RxD (-)	RxD (-)
17	Power ground	NC	Power ground
18	+10 to 28 VDC	NC	+10 to 28VDC
19	TxD (+)	TxD (+)	TxD (+)
20	Output 1 (-)	Output 1 (-)	Output 1 (-)
21	Output 2 (-)	Output 2 (-)	Output 2 (-)
22	Light Control	Light Control	Light Control
23	Input 1 (-)	Input 1 (-)	Input 1 (-)
24	New master (-)	New master (-)	New master (-)
25	New master (+)	New master (+)	New master (+)

Trigger 4-pin Connector

Pin	Function
1	Power + 10 to 28VDC (out) ^a
2	Trigger (-) (in) ^b
3	Power Ground
4	Trigger (+) (in) ^a

- a. For NPN type, connect pins 1 and 4.
- b. For PNP type, connect pins 2 and 3.

Power 3-pin Connector

Pin	Function
1	Power Ground
2	Chassis Ground
3	Power + 10 to 28VDC (in)

Ethernet/USB Interface

USB and standard Ethernet (RJ45) connections can be made through the Ethernet/USB Interface, which plugs directly into the host port of the Quadrus Verifier. The Ethernet/USB Interface has a second 25-pin port to pass through all but the RS-422/485 connections.

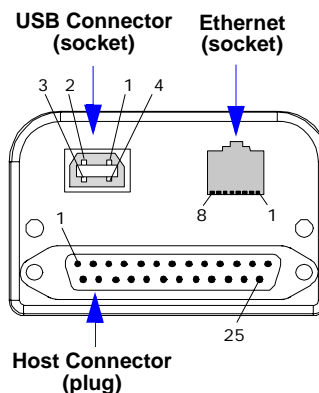
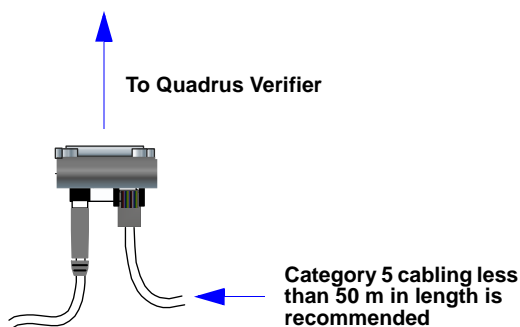

Ethernet

Pin	Ethernet Port
1	Ethernet TX (+)
2	Ethernet TX (-)
3	Ethernet RX (+)
4	NC
5	NC
6	Ethernet RX (-)
7	NC
8	NC

USB

Pin	USB Port
1	+5VDC
2	Data (-)
3	Data (+)
4	GND

Host

Pin	Host Port ^a
13	NC
14	NC
16	NC
19	NC

a. All other pins are as shown on the Verifier port.

Ethernet/USB Notes

- Protection components are installed within the interface to address Ethernet susceptibility to line transients and electrostatic discharge (ESD) that can cause communication dropouts and connection termination.
- The matching cable does not provide the proper matched impedance that the standard CAT 5 cable provides, thus allowing higher emission levels which exceed Class A CE limits and possible further signal degradation.

Terminal Strip Interface Kit

Custom terminal strip wiring can be done through this interface, which can either connect directly to the Verifier or indirectly by way of the aux port.

Note: This kit includes a gender changer. The gender changer is only used for direct connection between the interface and the Verifier.

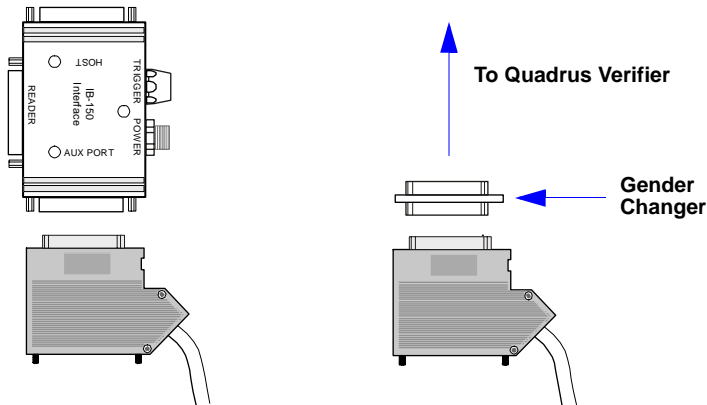

Note: Inside terminal assembly can be flipped over as required by application.

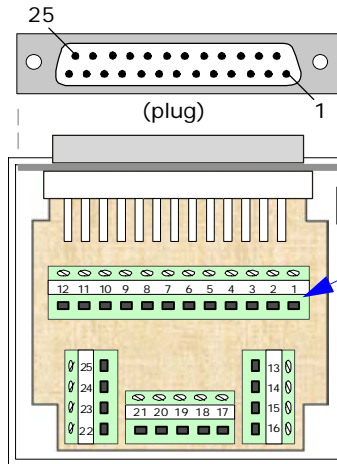

Steps for wiring:

1. Remove two screws from top case at these locations.
2. Pry at this point to separate cases.
3. Connect external wires to terminal connections as marked.

Appendix D — Serial Configuration Commands

Communications	
Host Port Connections	<K100, baud rate, parity, stop bits, data bits>
Host Port Protocol	<K140, protocol>
Host 232/422 Status	<K102, host 422>
Auxiliary Port	<K101, aux port mode, baud rate, parity, stop bits, data bits, daisy chain ID status, daisy chain ID>
Daisy Chain Autoconfigure	<K150 DAISY>
Daisy Chain ID	<K151, daisy chain reader #, daisy chain reader ID>
Ethernet Configuration	<K125, IP address, subnet address, gateway address, IP address mode, primary TCP port, video TCP port>
Preamble	<K141, status, preamble characters>
Postamble	<K142, status, postamble characters>
Response Timeout	<K143, response timeout>
LRC	<K145, status>
Aux Port System Data Status	<K146, aux port system data>
Read Cycle	
Multisymbol	<K222, number of symbols, multisymbol separator>
Trigger Mode/Duration	<K200, trigger mode, trigger filter duration>
External Trigger State	<K202, external trigger state>
Serial Trigger Character	<K201, serial trigger character>
Start Trigger Character	<K229, start character>
Stop Trigger Character	<K230, stop character>
End of Read Cycle	<K220, end of read cycle, read cycle timeout>
Active Camera	<K240, active camera>
Captures	<K241, capture mode, number of captures, rapid capture mode>
Capture Timing	<K242, time before 1st capture, time between capture 1 and 2 ,,,,,, time between capture 7 and 8>
Dual Camera Operations	<K243, switching mode, number of internal camera captures, number of external camera captures, internal camera timeout, external camera timeout>
Store No Read Image	<K244, image storage type, image storage mode>
Symbologies	
Data Matrix	<K479, ECC 200 status, ECC 000 status, ECC 050 status, ECC 080 status, ECC 100 status, ECC 140 status, ECC 120 status, ECC 130 status>
QR Code	<K480, status>
Code 39	<K470, status, check digit status, check digit output status, large intercharacter gap, fixed symbol length status, fixed symbol length, full ASCII set>
Code 128	<K474, status, fixed symbol length status, fixed symbol length>
BC412	<K481, status, check digit output, fixed symbol length status, fixed symbol length>
Interleaved 2 of 5	<K472, status, check digit status, check digit output, symbol length #1, symbol length #2, guard bar>
UPC/EAN	<K473, UPC status, EAN status, supplementals status, separator status, separator character, supplemental type>

Serial Configuration Commands

Pharmacode	<K477, status, fixed symbol length status, fixed symbol length, min. no. of bars, bar width status, direction, fixed threshold value>
RSS Expanded	<K484, status, fixed symbol length status, fixed symbol length>
RSS Limited	<K483, status>
RSS-14	<K482, status>
PDF417	<K476, status, [unused], fixed symbol length status, fixed symbol length, [unused], codeword collection>
Micro PDF417	<K485, status, [unused], fixed symbol length status, fixed symbol length>
Composite	<K453, mode, separator status, separator>
Narrow Margins/Symbology ID	<K450, narrow margins, symbology identifier status>
Background Color	<K451, background color>
Unique Item Identifiers (UII)	<K455, status, errstatus>

I/O Parameters

Symbol Data Output	<K705, symbol data output status, when to output>
No Read Message	<K714, no read message status, no read message>
Bad Symbol Message	<K715, [unused], message>
No Symbol Message	<K716, [unused], message>
1D/Stacked Symbology Qualification	<K717, minimum number of bars, minimum number of qualified scans, start/stop status>
2D Symbology Qualification	<K718, finder pattern status, symbol size mode, symbol size 1, symbol size 2, symbol size tolerance, dimension mode, dimension 1, dimension 2, dimension tolerance, orientation mode, orientation value>
Read Duration Output	<K706, status, separator>
LED Indicators	<K750, green flash mode, target pattern status, green flash duration>
Beeper	<K702, beeper status>
LED Configuration	<K737, LED mode, ISO/IEC 15415 grade, DPM grade>
Serial Verification	<K701, serial command echo status, serial command beep status, control/hex output>
Video Output	<K760, video output status, triggered mode, capture number>
Image Output	<K739, image output mode, comm port, file format, JPEG quality>
Image Captioning	<K762, mode>
Synchronous Trigger	<K761, synchronous trigger mode>
EZ Button	<K770, global status, default on power-on, load IP database, save for power-on>
EZ Button Modes	<K771, position 1 mode, position 2 mode, position 3 mode, position 4 mode>
Input 1	<K730, input mode, active state>
Output 1 Parameters	<K810, output on, active state, pulse width, output mode>
Trend Analysis Output 1	<K780, trend analysis mode, number of triggers, number to output on>
Diagnostic Warnings to Output 1	<K790, over temp, service unit, external camera disconnect>
ISO/IEC 15415 Verification Output 1	<K830, grade, decode, symbol contrast, fixed pattern damage, axial non-uniformity, grid non-uniformity, modulation, unused error correction, print growth value>
AS9132 Verification Output 1	<K840, dot center offset, cell fill, dot ovality, angle of distortion, symbol contrast, quiet zone>
Output 2 Parameters	<K811, output on, active state, pulse width, output mode>
Trend Analysis Output 2	<K781, trend analysis mode, trigger evaluation period, number to output on>

Diagnostic Warnings to Output 2	<K791, over temp, service unit, external camera disconnect>
ISO/IEC 15415 Verification Output 2	<K831, grade, decode, symbol contrast, fixed pattern damage, axial non-uniformity, grid non-uniformity, modulation, unused error correction, print growth value>
AS9132 Verification Output 2	<K841, dot center offset, cell fill, dot ovality, angle of distortion, symbol contrast, quiet zone>
Output 3 Parameters	<K812, output on, active state, pulse width, output mode>
Trend Analysis Output 3	<K782, trend analysis mode, trigger evaluation period, number to output on>
Diagnostic Warnings to Output 3	<K792, over temp, service unit, external camera disconnect>
ISO/IEC 15415 Verification Output 3	<K832, grade, decode, symbol contrast, fixed pattern damage, axial non-uniformity, grid non-uniformity, modulation, unused error correction, print growth value>
AS9132 Verification Output 3	<K842, dot center offset, cell fill, dot ovality, angle of distortion, symbol contrast, quiet zone>

Verification

ISO/IEC 15415 Verification Setup	<K531, aperture, wavelength, angle, reflectance maximum, reflectance minimum>
AIM DPM Verification Setup	<K532, minimum element size, maximum element size, wavelength, lighting>
General Verification Serial Output	<K708, separator character, unused (0), ISO grade type, symbol type, symbol dimensions>
AS9132 Element Shape and Marking Method	<K711, element shape, marking method, JES 131>
AS9132 Serial Output	<K712, dot center offset, percentage failed offset, cell fill, percentage failed cell fill, dot ovality, percentage failed ovality, angle of distortion, symbol contrast, quiet zone grade, pixels per element value>
ISO/IEC 15415 Serial Output	<K756, grade, aperture, wavelength, light angle value, decode grade, symbol contrast, fixed pattern damage grade, axial non-uniformity, grid non-uniformity, modulation grade, unused error correction, print growth value, pixels per element value>

Matchcode

Matchcode Type	<K223, type, sequential matching, match start position, match length, wildcard character, sequence on no read, sequence on mismatch>
Sequence Step	<K228, sequence step>
New Master Pin	<K225, status>
Number of Master Symbols	<K224, number of master symbols>
Enter Master Symbol Data	<K231, master symbol number, data>
Read Next Symbol as Master Symbol	<G master symbol number>
Request Master Symbol Data	<K231?,>[for all] or <K231?, master symbol number>
Delete Master Symbol Data	<K231, master symbol number,>

Diagnostics

Power-on / Reset Counts	<K406, power-on, resets, power-on saves, customer default saves>
External Camera Message	<K410, disconnect msg status, disconnect message, connect message status, control message>
Over Temperature Message	<K402, over temperature status, warning message>
Service Message	<K409, status, service message, threshold, resolution>

Serial Configuration Commands

Camera	
Region of Interest	<K516,top,left,height,width>
Camera	<K540,shutter speed,gain>
Illumination Source	<K535,illumination source>
Thresholding	<K512,threshold mode,threshold value>
Image Processing Mode	<K513,processing mode>
Multiple Symbols in Fast Linear Mode	<K518,number of symbols>
Image Processing Timeout	<K245,image processing timeout>
Hollow Mode	<K517,hollow status>
Output Format	
Symbol Output Format Status	<K743,symbol output format status>
Multisymbol Format Assignment	<K742,symbol number,multisymbol status>
Extraction Mode	<K740,output #,start position,length>
Insertion Mode	<K741,output #,length,hex string>
Ordered Output	<K744,filter number,symbology,length,wildcard character,placeholder character,data,>
Number of Filters	<K745,number of filters>
Output Object Information	<K734,output frame #,output coordinates>
Operational Commands	
ISO/IEC 15415 Reflectance Calibration	<@VER>
ISO/IEC 15415 Single Capture Verification	<V1>
ISO/IEC 15415 Multi-Capture Verification	<V2>
AS9132 Verification	<V3>
AIM DPM Reflectance Calibration	<@AIMDPM,Rmax,Rmin>
AIM DPM Verification	<V4>

Serial Command Format

Serial commands are of two types: utility and configuration.

Rules that apply to both utility and configuration commands

- A less than < and greater than > characters enclose the commands.
- Commands and data are “case sensitive.” That is, characters must be entered as upper or lower case, as specified.

Serial Utility Commands

These are sent during operations and are not followed by a <A> or <Z>.

Serial Configuration K Commands

These begin with a single ‘K’ character followed by a 3-digit numeric character, data fields, and an initializing command, as follows:

<K*numeric parameter,data,data,...etc.*><initializing command>

An initializing command <A> or <Z> may follow the command. A <Z> initializes the Verifier’s memory and saves for power-on; an <A> initializes the Verifier’s memory but does not save for power-on.

For example, to enable **UPC** and save the change for power-on, send <K473,1><Z>.

To change **Baud Rate** and reset without saving changes for power-on, send <K100,3><A>.

Serial Configuration Command Conventions

- All data fields (except the last) must be followed by a comma (without a space).
- The following characters cannot be used: **NULL**, <, or >.
- All fields preceding a modified field must be included.
- If there is no change in preceding fields, then commas alone can be entered in these fields. For example, if only the last field in the following command is changing, <K100,4,1,0,0> can be entered as <K100,,,,0>.
- All fields *following* a modified field can be omitted. For example, to change **Baud Rate** only, send <K100,3>.

Concatenating Configuration Commands

Commands can be concatenated (added together) in a single string or data block. For example, <K145,1><K220,1><K450,1><A> enables LRC, sets **End of Read Cycle** mode to **New Trigger**, enables **Narrow Margins**, and resets the data buffers (without saving the changes for power-on).

Serial Command Status Request

To ensure that any command was received and accepted, you can send the **Show Verifier Status** command: **<?>**.

The status of a specific serial command can be requested by entering the command followed by a question mark. For example, send **<K142?>** to request the status of **Postamble**.

Entering Special Characters in Serial Commands

To enter control characters within a serial command, hold down the control key while typing the desired character.

Example: To enter a carriage return and line feed (^M^J), enter **<K141,1,CNTL-m CNTL-j>**.

Entering Special Characters in Embedded Menus

Control Characters

Control characters entered on the command line are displayed in the menu as mnemonic characters, such as: **<CR><LF><NULL><NULL>**.

Press **SP** (the space bar) once, then enter the control character by holding down the control key and simultaneously pressing the desired character. For example to define a line feed, press **SP**, then **Control** and **J** simultaneously. It is displayed as **^J** on the command line and as **<LF>** in the menu when the screen is refreshed.

To Define a Carriage Return as a Character

Press **SP**, then **CR**. It is displayed as **^M** on the command line and as **<CR>** in the menu when the screen is refreshed.

To Define a Space as a Character

Press **SP** twice. It is displayed as a blank space in the menu when the screen is refreshed. While it appears that nothing has been assigned, the hex value **20** will be sent during data transmission.

To Select NUL as the Character

Press **SP**, then a **0** (zero). It is displayed as **NUL** in the menu when the screen is refreshed.

Appendix E — ASCII Table

ASCII Table with Control Characters

Dec	Hex	Mne	Ctrl	Dec	Hex	Ch	Dec	Hex	Ch	Dec	Hex	Ch
00	00	NUL	^@	32	20	SP	64	40	@	96	60	`
01	01	SOH	^A	33	21	!	65	41	A	97	61	a
02	02	STX	^B	34	22	"	66	42	B	98	62	b
03	03	ETX	^C	35	23	#	67	43	C	99	63	c
04	04	EOT	^D	36	24	\$	68	44	D	100	64	d
05	05	ENQ	^E	37	25	%	69	45	E	101	65	e
06	06	ACK	^F	38	26	&	70	46	F	102	66	f
07	07	BEL	^G	39	27	'	71	47	G	103	67	g
08	08	BS	^H	40	28	(72	48	H	104	68	h
09	09	HT	^I	41	29)	73	49	I	105	69	i
10	0A	LF	^J	42	2A	*	74	4A	J	106	6A	j
11	0B	VT	^K	43	2B	+	75	4B	K	107	6B	k
12	0C	FF	^L	44	2C	,	76	4C	L	108	6C	l
13	0D	CR	^M	45	2D	-	77	4D	M	109	6D	m
14	0E	SO	^N	46	2E	.	78	4E	N	110	6E	n
15	0F	SI	^O	47	2F	/	79	4F	O	111	6F	o
16	10	DLE	^P	48	30	0	80	50	P	112	70	p
17	11	DC1	^Q	49	31	1	81	51	Q	113	71	q
18	12	DC2	^R	50	32	2	82	52	R	114	72	r
19	13	DC3	^S	51	33	3	83	53	S	115	73	s
20	14	DC4	^T	52	34	4	84	54	T	116	74	t
21	15	NAK	^U	53	35	5	85	55	U	117	75	u
22	16	SYN	^V	54	36	6	86	56	V	118	76	v
23	17	ETB	^W	55	37	7	87	57	W	119	77	w
24	18	CAN	^X	56	38	8	88	58	X	120	78	x
25	19	EM	^Y	57	39	9	89	59	Y	121	79	y
26	1A	SUB	^Z	58	3A	:	90	5A	Z	122	7A	z
27	1B	ESC	^[59	3B	;	91	5B	[123	7B	{
28	1C	FS	^\	60	3C	<	92	5C	\	124	7C	
29	1D	GS	^]	61	3D	=	93	5D]	125	7D	}
30	1E	RS	^^	62	3E	>	94	5E	^	126	7E	~
31	1F	US	^_	63	3F	?	95	5F	_	127	7F	D

ASCII Table

Communication Protocol Commands

Protocol Command (Mnemonic displayed on Microscan menu)	Control Characters (Entered in menu or serial command)	Hex Value	Effect of Command
RES	^D	04	Reset
REQ	^E	05	Request
EOT	^D	04	Reset
STX	^B	02	Start of Text
ETX	^C	03	End of Text
ACK	^F	06	Acknowledge
NAK	^U	15	Negative Acknowledge
XON	^Q	11	Begin Transmission
XOFF	^S	13	Stop Transmission

Appendix F — Data Matrix Symbology

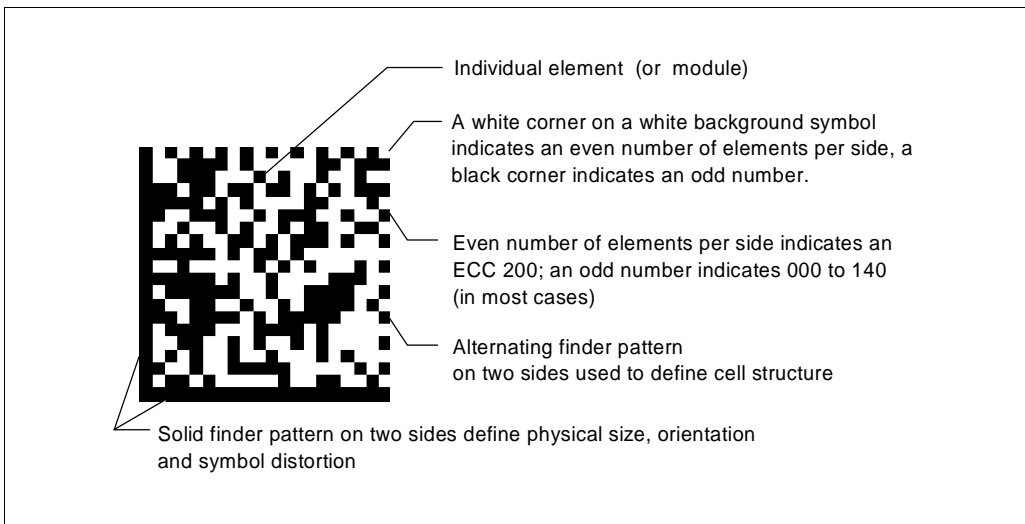

Data Matrix Symbol Comparison

Symbol Features	ECC 000 - 140	ECC 200
Number of rows and columns (including finder pattern)	Odd (except for some closed applications)	Even
Element in upper right hand corner	Dark (for light background symbols)	Light (for light background symbols)
Error correction routine	Convolution	Reed-Solomon
Symbol sizes (not including quiet zones)	17 to 21 sizes (squares only)	24 squares 6 rectangular
Append in structured format	No	Yes, up to 16 symbols
Subdivide code word stream into blocks for error detection	No	Yes, for symbols with more than 255 code words
Extended channel interpretation for other character sets	No	Yes, optional
Data encoded in:	Base 11, 27, 41, 37, ASCII, 8-bit Byte	ASCII, C40, text, X12, EDIFACT, and Base 256

Appendix G — Object Detector

The Quadrus Verifier can be used as a fully functional reader in a wide variety of applications. In a typical operation, a reader will wait for symbol data only during a triggered read cycle. A read cycle is initiated by a “trigger” and can be in the form of a serial command from the host (internal trigger) or a signal from an object detector (external trigger).

When an object detector (also called a sensor, package detector, etc.) is used, it is set up so that its beam will be interrupted by the approaching object and the resulting pulse will be sent to the reader to begin the read cycle. Typically, a detector is positioned so that it will detect the presence of an object before its symbol can be read.

An object detector is mounted in almost any position relative to the object as long as (1) the object passes within range of the detector and (2) direct or reflected light from the detector does not interfere with the reader’s reception.

As the item continues to move down the line, its symbol moves into the reader’s field of view and is decoded.

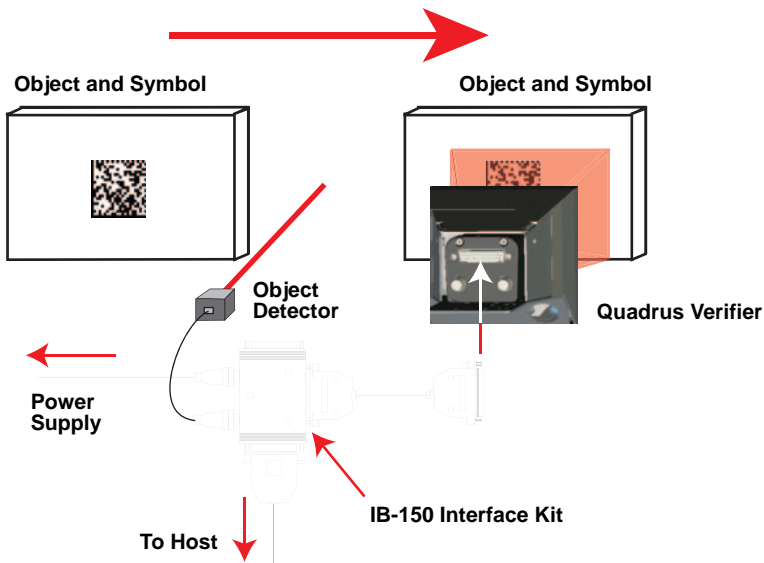

Example of Object Detector Operation

Appendix H — Operational Tips

Cleaning

The Quadrus Verifier has a hard-coated window that should only be cleaned with 100% isopropyl alcohol.

Mounting

If you use the Quadrus Verifier as a fixed-mount reader, do not insulate the stand mount. The bottom of the Verifier is the hottest part of the unit, and metal-to-metal contact is needed for heat dissipation.

Appendix I — Embedded Menus

In addition to **ESP**, you can also use a communications menu such as HyperTerminal to establish communication with Microscan's embedded menus.¹

1. With your host connected to the Quadrus Verifier, set your host communications settings as follows: **115.2K** baud, **8** Data Bits, **1** Stop Bits, and **None** Parity.
2. Set **Flow Control** to **None**.
3. Make the communications port selection. (Usually **COM 1** for Windows Operating Systems.)

Upon connection, send a **<D>** command to bring up the main menu.

```

                                MAIN MENU
-----
TOPICS                          DESCRIPTION
1) COMMUNICATIONS                HOST PROTOCOL & HOST/AUX PORT CONFIG.
2) READ CYCLE                    TRIGGERING, TIMEOUTS, ETC.
3) 2D SYMBOLOGY                 2-D CODE AND GLOBAL CODE PARAMETERS
4) LINEAR SYMBOLOGY 1           LINEAR CODE 1 PARAMETERS
5) LINEAR SYMBOLOGY 2           LINEAR CODE 2 PARAMETERS
6) I/O CONDITION                DISCRETE I/O
7) DATA OUTPUT 1               BEEPER, DATA MESSAGES, ETC.
8) DATA OUTPUT 2               VIDEO OUTPUT & EZ-SETUP BUTTON
9) DATA FORMAT                 ORDERED OUTPUT/FILTERING.
10) VERIFICATION                ISO & DPM VERIFICATION.
11) DIAGNOSTICS                 WARNING MESSAGES, SERVICE TIME, ETC.
12) CAMERA OPTIONS              CAMERA SETTINGS.
13) IPDATABASE                  IPDATABASE FOR GAIN,SHUTTER, ETC.
-----
ESC = MAIN MENU OR EXIT      N = NEXT ITEM
M  = PREVIOUS MENU          SP = NEXT ITEM
B  = PREVIOUS ITEM          CR = THIS ITEM
-----
MAIN--> COMMUNICATIONS
```

Menu navigation commands are case sensitive. Use the space bar or **N** to advance to the next item, **CR** (return key) to select a highlighted item, **B** to return to the previous item, **M** to return to the previous menu, and **ESC** to return to the Main menu or to exit the program. When exiting the program, you will be prompted to save your active settings for power up (**Y** or **N**). Typing **Y** will be equivalent to saving with a **<Z>** command.

1. If you are using HyperTerminal, you may find that the initial screen is not visible when you call up the program with the **<D>** command. If this occurs, exit the embedded menu with the sequence **ESC**, **E**, and **N**, and repeat the **<D>** command.

Appendix J — Interface Standards

Interface Standards, established by the Electronic Industries Association (EIA), specify such things as the signaling voltage levels, maximum cable lengths, and number of drivers. With Microscan devices, selection of interface is made by pin assignment.

RS-232

RS-232 defines an interface between two devices such as, for example, the Verifier and host. It differs from other interfaces by dedicating individual pins to specific functions and by requiring both devices to share a common ground line. Since both device chassis are connected to a common ground, a ground loop potential and the possibility of noise interference exists. Therefore cable lengths are limited to a maximum of 50 feet (19.7m). Despite being the most limited, this interface is used frequently because of the large installed base of RS-232 equipment.

Ethernet

Ethernet is supported for 10Mbps per second with packets between 64 and roughly 1,500 bytes in length. A 6-byte address is used, which is divided into a 3-byte vendor ID and a 3-byte vendor-defined field. Ethernet manufacturers are assigned a unique vendor ID, and are then responsible for insuring that all of their devices have unique addresses in the last 3 bytes.

Appendix K — Glossary of Terms

Aberration—The failure of an optical lens to produce an exact point-to-point correspondence between the object and its resulting image. Various types are chromatic, spherical, coma, astigmatism and distortion.

Absorption—The loss of light of certain wavelengths as it passes through a material and is converted to heat or other forms of energy.

Active Illumination—The process of lighting an area coordinated with the simultaneous acquisition of an image. Strobed flash tubes and pulsed lasers are examples.

Ambient Light—Light that is present in the environment of a vision system and that is generated from outside sources. This light, unless used for actual field of view illumination, will be treated as background noise by the vision system.

Analog—A smooth, continuous voltage or current signal. From the word “analogous,” meaning “similar to.”

Analog Gain Adjustment (AGC)—Adjustment of signal strength that seeks to maintain a constant level regardless of the range of the candidate symbol.

Analog-to-Digital Converter (ADC)—A device that converts an analog voltage or current signal to a discrete series of digitally encoded numbers (signal) for processing.

Angle of Distortion—The deviation from a 90 degree relation between a 2D symbol's rows and columns.

Architecture—For a vision system, the hardware organization designed for high speed image analysis.

AS9132—The Aerospace Standard for direct part marking (DPM) using Data Matrix symbols.

ASIC—Application Specific Integrated Circuit. All vision system elements including firmware can be integrated onto one ASIC.

Aspect Ratio—The ratio between the height and width of a sensor or display. It is found by dividing the vertical number of pixels (height) by the horizontal number of pixels (width).

Auxiliary Port—An alternate port that can be configured to communicate in RS-232 in several modes including **Daisy Chain**.

Axial Non-Uniformity—Uneven scaling of a 2D symbol's grid.

Baud Rate—Bits per second, or the number of discrete signal events per second.

Binarized Image—A black and white image created by applying the **Global Threshold** to the pixel values in the reference grey scale image.

Blooming—A condition in which too many photons are being produced to be received by a pixel. The pixel overflows and causes the photons to move to adjacent pixels. Blooming is similar to overexposure in film photography, except that in digital imaging, the result is a number of vertical and/or horizontal streaks appearing from the light source in the picture.

Capture—The act of acquiring and storing video images in a reader or host computer. Also, the image captured.

CCD—Charge-Coupled Device. CCDs capture light with an array of light-sensitive diodes, each diode representing one pixel.

Cell Fill—The percentage of the ideal cell size filled by a directly marked “dot” element.

Check Digit—A Modulus 43 or Modulus 10 digit that is added to the symbol message for additional data integrity.

CMOS—Complementary Metal Oxide Semiconductor. Like CCDs, CMOS readers include an array of photo-sensitive diodes, one diode within each pixel. Unlike CCDs, however, each pixel in a CMOS reader has its own individual amplifier integrated inside.

Connector—A plug or socket on a device or cable to provide in/out connectivity for various circuits and pins.

Concentrator—Intermediary device that relays data from multiple readers to a host and that relays commands from the host to the readers or other devices.

Counter—Memory space provided to keep track of reader events.

Daisy Chain—Linkage of master and secondary readers to allow data to be relayed up to the host via auxiliary port connections.

Data Matrix—A 2D matrix symbology consisting of dark and light square modules, or elements, within an L-shaped finder pattern.

Decode—A good read. The successful scanning and decoding of the information encoded in a symbol.

Default—Restores ROM or flash settings, initializes serial commands, and resets all counters.

Delimited—Bracketed by pre-defined characters.

Decode Rate—The number of good reads per second achieved by the reader.

Dark Field Illumination—Lighting of objects, surfaces, or particles at very shallow or low angles, so that light does not directly enter the reader’s optics.

Depth of Field—The range of an imaging system as measured by the nearest distance to the farthest distance that an object in the field of view remains in focus.

Diffused Lighting—Scattered soft lighting from a wide variety of angles used to eliminate shadows and specular interference from highly reflective surfaces.

Digital-to-Analog Converter (DAC)—A VLSI circuit used to convert digitally-processed images to analog for display on a monitor.

Digital Imaging—Conversion of a video image to pixels by means of an analog-to-digital converter, where the level of each pixel can be stored in a host computer.

Digital Signal Processor (DSP)—A VLSI chip designed for ultra-high-speed arithmetic processing. Often embedded in a vision engine.

Direct Part Mark (DPM)—A machine-readable symbol applied to an individual part using such techniques as dot peen, laser etch, and chemical etch.

Discrete I/O—Inputs and outputs characterized by discrete signal transitions from one voltage level to another so that digital switching can occur.

DMA—Direct Memory Access. A capability provided by some computer bus architectures that allows data to be sent directly to memory from an attached device.

Dot Center Offset—The deviation of the center of a directly marked “dot” element from the ideal dot center.

- Dot Ovality**—The extent of oval distortion of directly marked 2D symbol elements.
- DSP**—Digital Signal Processing. See also **Digital Signal Processor**.
- Dynamic Range**—The difference between the minimum and maximum thresholds of discernible images; the amount of usable signal.
- Edge Enhancement**—Image processing method to strengthen high spatial frequencies in an image.
- Element**—The fundamental unit of data encodation in a linear or 2D symbol. A single bar, space, square, dot, etc.
- Embedded Memory**—Onboard memory device such as EPROM or flash.
- End of Read Cycle**—The time or condition at which the reader stops expecting to receive symbol information.
- EPROM**—Erasable, programmable read-only memory.
- External Edge**—Allows a read cycle to be initiated by a trigger signal from an object detector when it detects the appearance of an object (rising edge). The read cycle ends with a good read, a timeout, or a new trigger.
- External Level**—Allows a read cycle to be initiated by a trigger signal from an object detector. The read cycle ends when the object moves out of the detector's range.
- Fill Factor**—Percentage of pixel area used for light collection.
- Firmware**—Software that is hard-coded in non-volatile memory (ROM).
- Fixed Pattern Damage**—A measurement of the damage to a symbol's finder pattern, clock pattern, quiet zone, and any other fixed pattern in or adjacent to a symbol.
- Fixed Symbol Length**—Increases data integrity by ensuring that only one symbol length will be accepted.
- Focal Distance**—In camera-based vision, the distance from the front of the camera to the object being viewed. (In optics, the distance from the lens to the focal plane.)
- Focal Plane**—Usually found at the image sensor, it is a plane perpendicular to the lens axis at the point of focus.
- Focus**—The point at which rays of light converge for any given point on the object in the image. Also called the focal point.
- Frame**—The total area captured by an image sensor.
- Frame Grabber**—A device that interfaces with a camera and, on command, samples the video, converts the sample to a digital value, and stores it in a computer's memory.
- Front End System**—The object, illumination, optics, and reader blocks of a vision system. Includes all components useful to acquire a good image for subsequent processing.
- FPGA**—Field-Programmable Gate Array. A semiconductor device containing programmable logic components and programmable interconnects.
- Gain**—The amount of energy applied to pixel gray scale values prior to output, expressed in dB. Also, optimal signal strength.
- Global Threshold**—The reflectance level at which dark and light elements in a symbol can be discriminated in a scan reflectance profile.
- Good Read**—The successful decoding of the information encoded in a symbol.

Gradient—The rate of change of pixel intensity (first derivative).

Gray Scale—Variations of values from white, through shades of gray, to black in a digitized image with black assigned the value of zero and white the value of one.

Grid Non-Uniformity—A measurement of the largest vector deviation of a 2D symbol's grid intersections.

Half Duplex—A configuration in which auxiliary port data is sent directly to the host and displayed on the auxiliary port screen.

Histogram—A graphical representation of the frequency of occurrence of each intensity or range of intensities (gray levels) of pixels in an image. The height represents the number of observations occurring in each interval.

Host—A computer, PLC, or other device that is used to execute commands and process data.

IEC (International Electrotechnical Commission)—A global organization that publishes international standards for electrical, electronic, and other technologies.

Image—Projection of an object or captured area onto a plane (i.e. screen or image sensor).

Image Processing—Transformation of captured image data into an output image with desired properties.

Image Resolution—The number of rows and columns of pixels in an image. An image sensor's total number of pixels.

Image Sensor—Array of pixels on a CCD or CMOS sensor.

Initialize—To implement serial configuration commands into the Verifier's active memory.

Input—A channel or communications line. Data or a discrete signal received by a device. See also **Output**.

Integration—Exposure of pixels on a CCD or CMOS sensor.

ISO (International Organization for Standardization)—A network of the national standards institutes of more than 155 countries, with a central headquarters in Geneva, Switzerland.

IUID (Item Unique Identification)—A United States Department of Defense initiative to implement a globally accepted identification system based on globally unique and unambiguous identifiers.

Ladder Orientation—A linear symbol in which the bars are parallel to the symbol's direction of travel (assuming horizontal movement).

LED—Light emitting diode. Often used as a strobe for objects traveling at medium speed.

Lens—A transparent piece of material with curved surfaces which cause light rays to converge or to diverge.

Machine Vision—The automatic acquisition and analysis of images to obtain desired data for the control of a specific application.

Modulation—A measurement of the uniformity of light and dark elements within a symbol.

Multidrop—A communications protocol for networking two or more readers or other devices with a concentrator (or controller), and characterized by the use of individual device addresses and the RS-485 standard.

Noise—The same as static in a telephone line or “snow” in a television picture, noise is any unwanted electrical signal that interferes with the image being read and transferred by the reader.

Normally Closed—A discrete output state that is only active when open.

Normally Open—A discrete output state that is only active when closed.

Output—A channel or communications line. Data or discrete signals that are transmitted or displayed by a device.

Parity—An error detection routine in which one data bit in each character is set to 1 or 0 so that the total number of bits in the data field is even or odd.

Picket Fence Symbol Orientation—A linear symbol orientation in which the bars are perpendicular to the symbol’s direction of travel.

Pixel—The basic unit of image composition in a digitized image array.

Pixels Per Element—The number of pixels making up each symbol element.

Port—Logical circuit for data entry and exit. (One or more ports may be included within a single connector.)

Print Growth—The extent to which dark or light symbol elements fill their module boundaries.

Processing Time—The time used by a vision system to receive, analyze and interpret image information. Often expressed as parts per minute.

Progressive Scan—A non-interlaced scan that doubles the number of visible picture lines per field by displaying all picture lines at once.

Protocol—The rules for communication between devices, providing a means to control the orderly flow of information between linked devices.

Quiet Zone—A clear space surrounding a symbol, required for symbol readability.

RAM—Random Access Memory for storage and retrieval of data.

Read Cycle—A pre-defined period of time during which the Verifier will accept symbol input.

Reference Decode Algorithm—A decoding algorithm that can be found in a specific symbology specification.

Reference Gray Scale Image—A plot of the reflectance values in x and y coordinates across a two-dimensional image.

Reflectance Calibration—The process of determining the optimal conditions for symbol verification in terms of reflected light from the substrate.

Region—An area of an image. Also called a Region of Interest for image processing operations.

RS-170—The Electronic Industries Association (EIA) standard governing monochrome television studio electrical signals. The broadcast standard of 30 complete images per second.

Saturation—The degree to which a color is free of white. One of the three properties of color perception along with hue and intensity.

Scattering—Redirection of light reflecting off a surface or through an object.

Symbol Contrast—A measurement of the difference in the light and dark values of a symbol's elements.

Symbology—A symbol type, such as Code 39 or Code 128, with special rules to define the widths and positions of bars (or elements) and spaces to represent specific numeric or alphanumeric information.

Symbol Transitions—The transition of bars and spaces on a symbol, used to detect the presence of a symbol on an object.

Trigger—A signal, transition, or character string that initiates a read cycle.

UII (Unique Item Identifier)—A globally unique data signature applied to items using direct part marking. UIIs provide business intelligence for the life of a part. See also **IUID**.

Unused Error Correction Capacity—A measurement of the extent to which regional damage or spot damage in a 2D symbol has eroded the reading safety margin provided by error correction capacity.

Verification—The process of testing a symbol to determine whether or not it meets specific requirements.

Verifier—A precisely calibrated device that tests symbols for conformance to specific requirements.

Watchdog Timer—A security device that detects system crashes and attempts to reset the reader.

Hyperlink Index

A

Absorption
Active Camera
Active Illumination
Active State (Input)
Add / Remove Exception
Additional Isolated Output Circuit Examples
Advanced Options
Advanced Tab
AI (Format 05)
AIM DPM
AIM DPM Evaluation Parameters
AIM DPM Quality Guideline
AIM DPM Reflectance Calibration
AIM DPM Reflectance Calibration by ESP
AIM DPM Verification by ESP
AIM DPM Verification by Serial Command
AIM DPM Verification Process
AIM DPM Verification Report
AIM DPM Verification Results
AIM DPM Verification Setup
AIM DPM Verification Setup by ESP
All Descriptor Status Request
All Range Status Request
All Status Request
Alpha (ISO Grade Type)
Always Ask Before Auto Sync Occurs
Ambient Light
Analog
Analog Gain Adjustment
Analog-to-Digital Converter
Angle
Angle of Distortion
Angle of Distortion (AS9132 Symbol Quality)
Aperture
Aperture Value
Appendices
Application Mode
Architecture
ARP
AS9132

B

AS9132 Calibration
AS9132 Evaluation Parameters
AS9132 Output by ESP
AS9132 Serial Output
AS9132 Symbol Quality (Output 1)
AS9132 Symbol Quality (Output 2)
AS9132 Symbol Quality (Output 3)
AS9132 Verification
AS9132 Verification by Serial Command
AS9132 Verification Process
AS9132 Verification Report
AS9132 Verification Results
AS9132/JES 131 Marking Method
AS9132/JES 131 Marking Method by ESP
ASCII Table
ASCII Table with Control Characters
ASIC
Aspect Ratio
Assigning a Network Address
Auto Sync
Aux Port System Data Status
Auxiliary Port
Auxiliary Port Connections
Auxiliary Port Mode
Average Value (Cell Fill)
Average Value (Dot Center Offset)
Average Value (Dot Ovality)
Axial Non-Uniformity
Axial Non-Uniformity (AIM DPM)
Axial Non-Uniformity (ISO/IEC 15415 Symbol Quality)
Axial Non-Uniformity (ISO/IEC 15415)

B

Background Color
Bad Symbol Message
Bad Symbol/No Symbol Qualification
Bar Code Configuration
Bar Code Dialog
Bar Code Options Tab
Bar Width Status (Pharmacode)
Baud Rate
Baud Rate (Aux Port)
Baud Rate (Host Port)
BC412

Beeper
Begin Transmission
Binarized Image
Binary Frames
Blooming

C

Calculating Number of Captures in a Rapid Capture Application
Calibrate
Calibrate by Serial Command
Calibrate Reflectance
Camera
Camera Setup
Camera Setup by ESP
Camera Setup Serial Commands
Capture
Capture and Decode
Capture Mode
Capture Timing
CCD
Cell Contrast (AIM DPM)
Cell Fill
Cell Fill (AS9132 Symbol Quality)
Cell Fill (AS9132)
Cell Modulation (AIM DPM)
Change Background Color
Change Echo Font
Change Font
Change Keyboard Macros
Check Digit
Check Digit Output (BC412)
Check Digit Output Status (Code 39)
Check Digit Output Status (Interleaved 2 of 5)
Check Digit Status (Code 39)
Check Digit Status (Interleaved 2 of 5)
Check Required Hardware
Cleaning the Quadrus Verifier
Clear
CMOS
Code 128
Code 39
Codeword Collection (PDF417)
Comm Port (EZ Trax Output by ESP)
Comm Port (EZ Trax Output by Serial Command)

D

- Command Processing Mode (Aux Port Mode)
- Communicating in Ethernet
- Communication Protocol Commands
- Communications
- Communications by ESP
- Communications Port (Image Output)
- Communications Protocols
- Communications Serial Commands
- Compliance Indicator
- Composite
- Concatenating Configuration Commands
- Concentrator
- Configuring EZ Trax Output
- Configuring EZ Trax Output by ESP
- Connect Message
- Connect Status
- Connect the System
- Connecting to a Host by TCP/IP
- Connectivity Accessories
- Connector
- Construct 1
- Construct 2
- Continuous Capture
- Continuous Capture Mode
- Continuous Capture Mode Examples
- Continuous Read
- Continuous Read 1 Output
- Control Characters
- Control/Hex Output
- Copy
- Counter
- Counters
- Counters by ESP
- Counters by Serial Command
- Counts (Read Only)
- Custom Default Saves
- Customer Default Parameters

D

- Daisy Chain
- Daisy Chain (Aux Port Mode)
- Daisy Chain Autoconfigure
- Daisy Chain ID
- Daisy Chain ID Status

Daisy Chain Reader ID
Daisy Chain Reader Number
Daisy Chain Remote Secondary Reader ID
Dark Field Illumination
Data
Data Bits (Aux Port)
Data Bits (Host Port)
Data Element Separator
Data Initiated from the Aux Port
Data Initiated from the Host
Data Initiated from the Verifier
Data Matrix
Data Matrix Symbol Comparison
Data Matrix Symbology
Data Qualifier
Database Index
Decode
Decode (ISO/IEC 15415 Symbol Quality)
Decode Direction (Pharmacode)
Decode Grade
Decode Rate
Default
Default all Settings
Default Current Menu Settings
Default Macros
Default on Power-On
Default on Power-On (EZ Button)
Default Settings
Defaulting
Defaulting/Saving/Resetting
Defining a Carriage Return as a Character
Defining a Space as a Character
Delete Master Symbol Data
Delimited
Depth of Field
Detailed No Read Message
Device Control
Device Control by ESP
Device Control By Serial Command
DHCP Client
DI (Format 06)
Diagnostics
Diagnostics (Output 1)
Diagnostics (Output 2)
Diagnostics (Output 3)

E

Diagnostics by ESP
Diagnostics Serial Commands
Differences from Default
Differences from Other Protocols
Diffused Lighting
Digital Imaging
Digital Signal Processor
Digital-to-Analog Converter
Dimension 1 (2D Symbology Qualification)
Dimension 2 (2D Symbology Qualification)
Dimension Mode (2D Symbology Qualification)
Dimension Tolerance (2D Symbology Qualification)
Direct Part Mark
Disable Reader
Disclaimer
Disconnect Message
Disconnect Status
Discrete I/O
DMA
Do Not Send or Receive Settings
Document Memo
Dot Center Offset
Dot Center Offset (AS9132 Symbol Quality)
Dot Center Offset (AS9132)
Dot Ovality
Dot Ovality (AS9132 Symbol Quality)
Dot Ovality (AS9132)
Dot Peen
Downloading ESP from the Web
DSP
Dual Camera Switching
Dynamic Range
Dynamic Setup
Dynamic Setup Calculator

E

EAN Status
ECC 000
ECC 000 - 140
ECC 050
ECC 080
ECC 100
ECC 120
ECC 130

ECC 140
ECC 200
Edge Enhancement
Editing a Macro
Effect
Effect of Command
EID Too Long
Electrical Specifications
Element
Element Shape
Embedded Memory
Embedded Menus
Emissions/Immunity
Enable Output Format
Enable PDF Information
Enable Reader
Enable Send and Save as Customer Defaults
Encoding a UII
End of Read Cycle
End of Read Cycle Mode
End Read Rate Test
Enhanced Format
Enter Decodes/Second Test
Enter Master Symbol Data
Enter Percent Test
Entering Special Characters in Embedded Menus
Entering Special Characters in Serial Commands
Enterprise Identifier (EID)
Environmental
EPROM
Error Message Examples
Error Messaging
ESP Preferences
ESP System Requirements
Ethernet
Ethernet Application
Ethernet Interface Standard
Ethernet Setup
Ethernet/USB Interface
Ethernet/USB Notes
Evaluation
Example of Object Detector Operation
Example of Timeout in Continuous Capture Mode
Example of Timeout in Rapid Capture Mode
Explanation of Modifiers for Code 39, Codabar, and Interleaved 2 of 5

F

Explanation of Modifiers for Other Symbologies

Export

External Camera Disconnect

External Camera Message

External Camera Timeout

External Edge

External Level

External Trigger State

Extract Range

EZ Button

EZ Button Modes

EZ Button Operation

EZ Button Trigger Mode

EZ Trax Output by ESP

EZ Trax Output by Serial Command

F

Features of UII Mode

File > New

File Format (Image Output)

Fill Factor

Filter Number

Find

Finder Pattern Status

Firmware

Firmware by ESP

Firmware Update

Firmware Verification

Fixed Pattern Damage

Fixed Pattern Damage (AIM DPM)

Fixed Pattern Damage (ISO/IEC 15415 Symbol Quality)

Fixed Pattern Damage (ISO/IEC 15415)

Fixed Pattern Damage Grade

Fixed Symbol Length

Fixed Symbol Length (BC412)

Fixed Symbol Length (Code 128)

Fixed Symbol Length (Code 39)

Fixed Symbol Length (MicroPDF417)

Fixed Symbol Length (PDF417)

Fixed Symbol Length (Pharmacode)

Fixed Symbol Length (RSS Expanded)

Fixed Symbol Length Status (BC412)

Fixed Symbol Length Status (Code 128)

Fixed Symbol Length Status (Code 39)

G

Fixed Symbol Length Status (MicroPDF417)
Fixed Symbol Length Status (PDF417)
Fixed Symbol Length Status (Pharmacode)
Fixed Symbol Length Status (RSS Expanded)
Fixed Threshold Value (Pharmacode)
Focal Distance
Focal Plane
Focus
Force Connect
Format Assign
Format Assign by ESP
Format Assign Status
Format Extract
Format Extract by ESP
Format Extract Length
Format Header
Format Insert
Format Insert by ESP
Format Insert Length
Four Beeps (Position #4)
FPGA
Frame
Frame Grabber
From Host
Front End System
Full ASCII Set (Code 39)
Full Duplex (Aux Port Mode)
Fully Optoisolated (Input)
Fully Optoisolated (Output)

G

Gain
Gateway Address
General Specifications
General Tab
General Verification Output by ESP
General Verification Serial Output
Generate
Generate and Save Verification Report
Generic Waveform Characteristics
Global Threshold
Glossary of Terms
Good Read
Good Read (Green Flash)

H

Good Read/Match Counter (or Good Read Counter)
Good Read/Match Counter Reset
Grade
Grade (Angle of Distortion)
Grade (Axial Non-Uniformity)
Grade (Cell Fill)
Grade (Dot Center Offset)
Grade (Dot Ovality)
Grade (Grid Non-Uniformity)
Grade (ISO/IEC 15415 Symbol Quality)
Grade (Symbol Contrast)
Grade and Average Value (Cell Fill)
Grade and Average Value (Dot Center Offset)
Grade and Average Value (Dot Ovality)
Grade and Value (Angle of Distortion)
Grade and Value (Axial Non-Uniformity)
Grade and Value (Grid Non-Uniformity)
Grade and Value (Symbol Contrast)
Grade and Worst Case Value (Cell Fill)
Grade and Worst Case Value (Dot Center Offset)
Grade and Worst Case Value (Dot Ovality)
Grade Output
Grade Report Options
Grade, Worst Case, and Average Values (Cell Fill)
Grade, Worst Case, and Average Values (Dot Center Offset)
Grade, Worst Case, and Average Values (Dot Ovality)
Gradient
Gray Scale
Green Flash Duration
Green Flash Mode
Grid Non-Uniformity
Grid Non-Uniformity (AIM DPM)
Grid Non-Uniformity (ISO/IEC 15415 Symbol Quality)
Grid Non-Uniformity (ISO/IEC 15415)
Guard Bar (Interleaved 2 of 5)

H

Half Duplex
Half Duplex (Aux Port Mode)
Hardware Configuration
Hardware Default
Hardware Required
Height (Row Depth)
Hex String

I

Hex Value
Highlighting
Histogram
Histogram Evaluation
Hollow Mode
Host
Host 422 Status
Host Communications
Host Port Connection
Host Port Protocol

I

I/O Parameters
I/O Parameters by ESP
I/O Parameters Serial Commands
IB-150 Kit Accessories
ICMP
IEC
Illumination
Illumination Source
Image
Image Captioning
Image File Transfers
Image Format (EZ Trax Output by ESP)
Image Format (EZ Trax Output by Serial Command)
Image Frame (Video Output)
Image Library Request
Image Mode
Image Mode (EZ Trax Output by Serial Command)
Image Output
Image Processing
Image Processing Database
Image Processing Database by ESP
Image Processing Settings
Image Processing Timeout
Image Resolution
Image Sensor
Image Storage Mode
Image Storage Type
Import
Import/Export
Indicators
Initialize
Input

I

- Input 1
- Input Examples
- Install ESP
- Installing ESP from a CD
- Integration
- Interface Standards
- Interleaved 2 of 5
- Internal Camera Timeout
- International Electrotechnical Commission
- International Organization for Standardization
- Invalid AI
- Invalid Characters
- Invalid Compliance Indicator
- Invalid DI
- Invalid Format Header
- Invalid TEI
- IP
- IP Address
- IP Address Mode
- IP Database
- IP Database by ESP
- IP Database Operation
- IP Database Serial Commands
- IP Database Window in ESP
- ISO
- ISO 15415 Single or Multi-Capture
- ISO Certification
- ISO Grade Type
- ISO/IEC 15415
- ISO/IEC 15415 Evaluation Parameters
- ISO/IEC 15415 Multi-Capture Verification
- ISO/IEC 15415 Multi-Capture Verification Report
- ISO/IEC 15415 Multi-Capture Verification Results
- ISO/IEC 15415 Output by ESP
- ISO/IEC 15415 Reflectance Calibration
- ISO/IEC 15415 Serial Output
- ISO/IEC 15415 Single Capture Reflectance Calibration by ESP
- ISO/IEC 15415 Single Capture Verification
- ISO/IEC 15415 Single Capture Verification Report
- ISO/IEC 15415 Single Capture Verification Results
- ISO/IEC 15415 Symbol Quality (Output 1)
- ISO/IEC 15415 Symbol Quality (Output 2)
- ISO/IEC 15415 Symbol Quality (Output 3)
- ISO/IEC 15415 Verification by Serial Command
- ISO/IEC 15415 Verification Setup

J

ISO/IEC 15426-2 Verifier Certification
ISO/IEC Multi-Capture Reflectance Calibration by ESP
ISO/IEC Verification Setup by ESP
Item Unique Identification
IUID

J

JES 131
JPEG Quality
JPEG Quality (EZ Trax Output by Serial Command)
JPEG Quality (Image Output)

L

Ladder Orientation
Large Intercharacter Gap (Code 39)
Laser or Chemical Etch
Last Frame
Last Frame or New Trigger
Latch Mode 1 (Unlatch Input # 1 Pin)
Latch Mode 2 (Unlatch Opposite Condition)
Latch Mode 3 (Unlatch Re-Enter Read Cycle)
LED
Left (Column Pointer)
Lens
Light Angle
Light Angle Value
Light Collection
Light Source
Lighting
Limitation of Liability Statement
Limitations
Line Scan
Linear Symbolologies
Linear/Stacked Symbolology Qualification
Live (Real Time) Video Output
Load Current Settings from Database
Load Current Settings from Database by ESP
Load IP Database (EZ Button)
Locate
Locate Symbol
Longitudinal Redundancy Check
Lower Case Characters
LRC Status

M

M

Machine Vision
Macro Name
Macro Value
Macros
Marking Method
Master Database
Master Database Overview
Master Symbol Database Size
Match
Match (Green Flash)
Match Length
Match Replace
Match Start Position
Matchcode
Matchcode by ESP
Matchcode Serial Commands
Matchcode Type
Maximum Characters for Master Symbol
Maximum Element Size
Mechanical
Menu Toolbar
Message Trailer Character
MicroPDF417
Microscan Default Parameters
Microscan Protocol/Host RS-232 Supported
MIL-STD-130M, Change 1
Minimum Element Size
Minimum Number of Bars
Minimum Number of Bars (Pharmacode)
Minimum Number of Qualified Scan Lines
Mirrored Image
Mismatch
Mismatch (Green Flash)
Mismatch Counter
Mismatch Counter Reset
Mismatch Replace
Model
Model Memo
Modulation
Modulation (ISO/IEC 15415 Symbol Quality)
Modulation (ISO/IEC 15415)
Modulation Grade
Mounting the Quadrus Verifier in an Application Environment

- Multi-Capture
- Multi-Capture Sequence
- Multi-Capture Verification Process
- Multi-Capture Verification Report
- Multidrop
- Multiple Symbols in Fast Linear Mode
- Multisymbol
- Multisymbol Separator

N

- Narrow Margin Status
- Narrow Margins
- Navigating in ESP
- Network
- Network Destination
- Network Protocols Supported
- New Master Pin
- New Model
- New Trigger
- No Read Counter
- No Read Counter Reset
- No Read Message
- No Read Message Mode
- No Symbol Message
- Noise
- Non-UII Characters
- Non-UII Characters in a Data String
- Normally Closed
- Normally Open
- Not Optoisolated (Input)
- Not Optoisolated, Verifier Grounded (Output)
- Notes on Triggered Capture Mode
- Number of Active Database Settings
- Number of Active Database Settings by ESP
- Number of Captures
- Number of External Camera Captures
- Number of Internal Camera Captures
- Number of Symbols
- Number of Triggers (Trend Analysis)
- Number to Output On (Trend Analysis)
- Numeric (ISO Grade Type)

O

- Object Detector

O

- Object Info Output
- Object Info Output (EZ Trax Output by Serial Command)
- Open/Save
- Operational Tips
- Options
- Optoisolator Inputs
- Optoisolator Outputs
- Ordered Output Filter
- Orientation Mode (2D Symbology Qualification)
- Orientation Value
- Other Operational Serial Commands
- Output
- Output 1 Parameters
- Output 1 Pulse
- Output 2 Parameters
- Output 2 Pulse
- Output 3 Parameters
- Output 3 Pulse
- Output Circuit Examples
- Output Filter Configuration
- Output Filter Configuration Rule # 1
- Output Filter Configuration Rule # 2
- Output Filter Configuration Rule # 3
- Output Filter Length
- Output Format
- Output Format Serial Commands
- Output Format Status
- Output Format Status by ESP
- Output Format Status Disabled
- Output Format Status Enabled
- Output Index
- Output Indicators
- Output Mode (Output 1)
- Output Mode (Output 2)
- Output Mode (Output 3)
- Output On (Output 1)
- Output On (Output 2)
- Output On (Output 3)
- Output On Diagnostic Warning
- Output On Good Read/Match
- Output On Mismatch
- Output On Mismatch or No Read
- Output On No Read
- Output On Read Cycle
- Output On Symbol Quality

Output On Trend Analysis
Output State (Output 1)
Output State (Output 2)
Output State (Output 3)
Output Symbol Data as Soon as Possible
Output Symbol Data at End of Read Cycle
Over Temperature
Over Temperature Message
Over Temperature Status
Overview of IP Database
Overview of IUID and UII
Overview of Matchcode
Overview of Verification

P

Parity
Parity (Aux Port)
Parity (Host Port)
Parse
Parse Table (Format Extract)
Parse Table (Format Insert)
Part Number Too Long
Paste
Pause
PDF417
Percentage Failed Cell Fill
Percentage Failed Offset
Percentage Failed Ovality
Pharmacode
Picket Fence Symbol Orientation
PING
Pixel
Pixels Per Element
Pixels Per Element (AIM DPM)
Pixels Per Element (AS9132)
Pixels Per Element (ISO/IEC 15415)
Pixels Per Element Value
Placeholder
Point-to-Point (Standard)
Point-to-Point with RTS/CTS
Point-to-Point with RTS/CTS and XON/XOFF
Point-to-Point with XON/XOFF
Polling Mode D
Port

Q

Port Connectors
Position Verifier and Symbol
Postamble
Postamble Character(s)
Postamble Status
Power 3-pin Connector
Power-On
Power-On Saves
Preamble
Preamble Character(s)
Preamble Status
Preferences
Preferences Dialog
Preferences Tab
Preliminary Steps
Primary (Command) TCP Port
Primary TCP Port
Print Growth
Print Growth (AIM DPM)
Print Growth (ISO/IEC 15415 Symbol Quality)
Print Growth (ISO/IEC 15415)
Print Growth Value
Processing Mode
Processing Time
Progressive Scan
Protocol
Protocol Command
Pulse
Pulse Width (Output 1)
Pulse Width (Output 2)
Pulse Width (Output 3)

Q

QR Code
Quadrus Verifier Host 25-Pin Connector
Quick Start
Quiet Zone
Quiet Zone (AS9132 Symbol Quality)
Quiet Zone (AS9132)
Quiet Zone Grade

R

RAM

Rapid Capture Mode
Rapid Capture Mode Examples
Rapid Capture Mode, Single Camera
Read Cycle
Read Cycle by ESP
Read Cycle Results (Image Captioning)
Read Cycle Serial Commands
Read Cycle Setup
Read Cycle Timeout
Read Duration Output
Read Duration Output Mode
Read Duration Output Separator
Read Next Symbol as Master Symbol
Read Rate
Read Rate by ESP
Read Rate by Serial Command
Reader Setup
Receive After Connect
Receive Settings from the Reader
Receiving
Reference Decode Algorithm
Reference Gray Scale Image
Reflectance Calibration
Reflectance Max
Reflectance Maximum
Reflectance Min
Reflectance Minimum
Region
Region of Interest (ROI)
Region of Interest by ESP
Region of Interest by Serial Command
Regular Image
Reload Last File
Replacement String
Request All Database Settings
Request All Master Symbol Data
Request Checksum
Request Checksum by ESP
Request Checksum by Serial Command
Request Master Symbol Data
Request New Master Status
Request Part Number
Request Part Number by ESP
Request Part Number by Serial Command
Request Selected Database Settings

S

- Reset Counts
- Resets
- Resolution
- Response Timeout
- RS-170
- RS-232 Interface Standard
- RS-232 Protocol
- RSS Expanded
- RSS Limited
- RSS-14
- Rules for Output Filter Configuration

S

- Safety Certifications
- Saturation
- Save
- Save AIM DPM Verification Report
- Save AIM DPM Verification Report as a CSV File
- Save AIM DPM Verification Report as a PDF
- Save AIM DPM Verification Report as an HTML File
- Save AIM DPM Verification Report as an RTF
- Save AS9132 Verification Report
- Save AS9132 Verification Report as a CSV File
- Save AS9132 Verification Report as a PDF
- Save AS9132 Verification Report as an HTML File
- Save AS9132 Verification Report as an RTF
- Save Current Settings to Database
- Save Current Settings to Database by ESP
- Save Current Text
- Save for Power-On (EZ Button)
- Save Multi-Capture Verification Report
- Save Multi-Capture Verification Report as a CSV File
- Save Multi-Capture Verification Report as a PDF
- Save Multi-Capture Verification Report as an HTML File
- Save Multi-Capture Verification Report as an RTF
- Save Single Capture Verification Report
- Save Single Capture Verification Report as a CSV File
- Save Single Capture Verification Report as a PDF
- Save Single Capture Verification Report as an HTML File
- Save Single Capture Verification Report as an RTF
- Saved for Power-On
- Saving
- Scattering
- Select All

- Select Communications Protocol
- Select Model
- Selecting NUL as the Character
- Send
- Send and Save
- Send and Save as Customer Defaults
- Send Current Command
- Send Current View
- Send ESP Settings to the Reader
- Send XON with Autoconnect
- Send, No Save
- Send/Receive Options
- Separator Character
- Separator Character (Composite)
- Separator Character (UPC/EAN)
- Separator Status (Composite)
- Separator Status (UPC/EAN)
- Sequence On Mismatch
- Sequence On No Read
- Sequence Step
- Sequential Matching
- Serial Command Beep Status
- Serial Command Echo Status
- Serial Command Format
- Serial Command Status Request
- Serial Configuration Command Conventions
- Serial Configuration Commands
- Serial Configuration K Commands
- Serial Data
- Serial Data or External Edge
- Serial Number Too Long
- Serial Trigger
- Serial Trigger Character (Delimited)
- Serial Utility Commands
- Serial Verification
- Service Message
- Service Message Status
- Service Unit
- Set Number of Symbols
- Set Verification Parameters
- Setting Up the Verifier for EZ Trax
- Show Connect Prompt
- Show Model Prompt
- Show Non-Printable Characters
- Shutter Speed

S

- Side View of IB-150
- Single Beep (Position #1)
- Single Capture
- Single Capture Verification Process
- Single Capture Verification Report
- Single Descriptor Status Request
- Single Range Status Request
- Single Status Request
- Sizing Information
- Sockets
- Software Defaults
- Space in Data Qualifier
- Start and Stop Trigger Characters (Non-Delimited)
- Start Character (Non-Delimited)
- Start Location
- Start/Stop Status
- Statement of Agency Compliance
- Static Presentation (Green Flash)
- Statistic Mode 1 (Image Captioning)
- Statistic Mode 2 (Image Captioning)
- Status Byte
- Status Requests
- Steps for Entering and Using Master Symbols
- Stop
- Stop Bits (Aux Port)
- Stop Bits (Host Port)
- Stop Character (Non-Delimited)
- Store No Read Image
- Store Report without file path prompt
- Subnet
- Summary of Utility Serial Commands
- Supplemental Type (UPC/EAN)
- Supplementals Status (UPC/EAN)
- Switch Model
- Switching by Number of Captures
- Switching by Timeout
- Switching Mode
- Symbol Contrast
- Symbol Contrast (AS9132 Symbol Quality)
- Symbol Contrast (AS9132)
- Symbol Contrast (ISO/IEC 15415 Symbol Quality)
- Symbol Contrast (ISO/IEC 15415)
- Symbol Data Output
- Symbol Dimension
- Symbol Features

- Symbol Length #1 (Interleaved 2 of 5)
- Symbol Length #2 (Interleaved 2 of 5)
- Symbol Number
- Symbol Parse
- Symbol Size 1 (2D Symbology Qualification)
- Symbol Size 2 (2D Symbology Qualification)
- Symbol Size Mode (2D Symbology Qualification)
- Symbol Size Tolerance (2D Symbology Qualification)
- Symbol Transitions
- Symbol Type
- Symbol Verification Parameters
- Symbologies
- Symbologies by ESP
- Symbologies Serial Commands
- Symbology
- Symbology ID
- Symbology Type
- Synchronous Trigger
- Synchronous Trigger Enabled
- Synchronous Trigger Restrictions

T

- Table of Contents
- Target Pattern
- Target Pattern Always OFF
- Target Pattern Always ON
- Target Pattern On When in Read Cycle
- Target Pattern On When NOT In Read Cycle
- TCP
- TCP/IP
- TEI (Format DD)
- Terminal
- Terminal Dropdown Menu
- Terminal Strip Interface Kit
- Terminal Tab
- Terminal Window
- Terminal Window Menus
- Test (Video Capture)
- TFTP Server
- Three Beeps (Position #3)
- Threshold
- Threshold (Histogram)
- Threshold Mode
- Threshold Value

U

- Thresholding
- Time Before First Capture
- Time Between Captures
- Time Delay Between Captures
- Timed Capture
- Timeout
- Timeout or New Trigger
- Top (Row Pointer)
- Trailer Character
- Transparent (Aux Port Mode)
- Trend Analysis (Output 1)
- Trend Analysis (Output 2)
- Trend Analysis (Output 3)
- Trend Analysis Mode (Trend Analysis)
- Trend Analysis to Output 3
- Trigger
- Trigger 4-pin Connector
- Trigger Counter
- Trigger Counter Reset
- Trigger Edge
- Trigger Filter Duration
- Trigger Image Mode (Video Output)
- Trigger Level
- Trigger Mode
- Triggered Capture
- Triggered Captures, Typical
- Triggered Video Output
- Two Beeps (Position #2)
- Two-Dimensional Symbologies
- Two-Dimensional Symbology Qualification

U

- UII
- UII Constructs
- UII Disabled (by Serial Command)
- UII Elements
- UII Enabled with Error Messaging and Pass Through
- UII Enabled with Pass Through
- UII Enabled with Pass Through (by Serial Command)
- UII Mode by ESP
- UII Mode by Serial Command
- UII Mode Error Messaging (by Serial Command)
- UII Mode Features
- UII Parsing

- Ull Too Long
- Ull-Only Enabled
- Ull-Only Enabled (by Serial Command)
- Ull-Only Enabled with Error Messaging
- Unique Item Identifier
- Unique Item Identifiers
- Unlatch Output
- Unused ECC
- Unused Error Correction
- Unused Error Correction (AIM DPM)
- Unused Error Correction (ISO/IEC 15415)
- Unused Error Correction Capacity
- Unused Error Correction Capacity (ISO/IEC 15415 Symbol Quality)
- Unused Error Correction Grade
- Unused Error Correction Grade and Value
- Unused Error Correction Value
- UPC/EAN
- User-Defined Address
- User-Defined Example
- User-Defined Multidrop
- User-Defined Point-to-Point
- Using DHCP to Configure the Verifier
- Using ESP
- Using Static Presentation
- Using the Verifier's Default IP Address
- Utilities
- Utility and Configuration Command Rules

V

- Valid Data Qualifier Formats
- Valid Data Qualifiers and Concatenated Ulls
- Value (Angle of Distortion)
- Value (Axial Non-Uniformity)
- Value (Grid Non-Uniformity)
- Value (Symbol Contrast)
- Verification
- Verification by ESP
- Verification Operational Commands
- Verification Report Tab
- Verification Serial Commands
- Verification Settings Tab
- Verification Standards
- Verifier
- Verifier Calibration Symbol

W

Verifier Dimensions
Verify Symbol
Video
Video Output
Video Output Status
Video TCP Port
View

W

Warning and Caution Summary
Warning Message
Warranty Statement
Watchdog Timer
Wavelength
Wavelength Value
When to Output Symbol Data
Width (Column Width)
Wild Card Character
Wildcard
Worst Case and Average Values (Cell Fill)
Worst Case and Average Values (Dot Center Offset)
Worst Case and Average Values (Dot Ovality)
Worst Case Value (Cell Fill)
Worst Case Value (Dot Center Offset)
Worst Case Value (Dot Ovality)

Y

Y-Modem Download Transfer Options
Y-Modem Upload Transfer Options