

User Guide Draft for Nokia 3595 Phone

What information is needed?	Numbers	Where is the number?
My number		Wireless service provider
Voice mail number		Wireless service provider
Wireless provider's number		Wireless service provider
Provider's customer care		Wireless service provider
Model number	3595	Label on back of phone (under battery). See "Remove the battery" on page 16.
Phone type	NPM-10	Label on back of phone (under battery).
Electronic serial number (ESN)		Label on back of phone (under battery).

The wireless phone described in this guide is approved for use in GSM networks.

LEGAL INFORMATION

Part No. 9355727, Issue No. 1

Copyright ©2003 Nokia. All rights reserved.

Nokia, Nokia Connecting People, Airglider, Bowling, Backgammon, Skydiver, Nokia 3595, Xpress-On, and the Nokia Original Accessories logos are trademarks or registered trademarks of Nokia Corporation. All other product and company names mentioned herein may be trademarks or tradenames of their respective owners.

Printed in Canada 03/2003

US Patent No 5818437 and other pending patents.

T9 text input software Copyright ©1999-2002. Tegic Communications, Inc. All rights reserved.

Includes RSA BSAFE cryptographic or security protocol software from RSA Security.



Java is a trademark of Sun Microsystems, Inc.

The information in this user guide was written for the Nokia 3595 phone. Nokia operates a policy of ongoing development. Nokia reserves the right to make changes and improvements to any of the products described in this document without prior notice.

UNDER NO CIRCUMSTANCES SHALL NOKIA BE RESPONSIBLE FOR ANY LOSS OF DATA OR INCOME OR ANY SPECIAL, INCIDENTAL, AND CONSEQUENTIAL OR INDIRECT DAMAGES HOWSOEVER CAUSED.

THE CONTENTS OF THIS DOCUMENT ARE PROVIDED "AS IS," EXCEPT AS REQUIRED BY APPLICABLE LAW. NO WARRANTIES OF ANY KIND, EITHER EXPRESS OR IMPLIED, INCLUDING, BUT NOT LIMITED TO, THE IMPLIED WARRANTIES OF MERCHANTABILITY AND FITNESS FOR A PARTICULAR PURPOSE, ARE MADE IN RELATION TO THE ACCURACY AND RELIABILITY OR CONTENTS OF THIS DOCUMENT. NOKIA RESERVES THE RIGHT TO REVISE THIS DOCUMENT OR WITHDRAW IT AT ANY TIME WITHOUT PRIOR NOTICE.

EXPORT CONTROLS

This product contains commodities, technology or software exported from the United States in accordance with the Export Administration regulations. Diversion contrary to U.S. law is prohibited.

FCC/INDUSTRY CANADA NOTICE

Your phone may cause TV or radio interference (for example, when using a telephone in close proximity to receiving equipment). The FCC or Industry Canada can require you to stop using your telephone if such interference cannot be eliminated. If you require assistance, contact your local service facility. This device complies with part 15 of the FCC rules. Operation is subject to the condition that this device does not cause harmful interference.

The term "IC:" before the certification/registration number only signifies that Industry Canada technical specifications were met.

For your safety	1	List of menu shortcuts	27
Welcome and quick guide	5	Phone book menu	33
Get the most out of this		Enter letters and numbers .34	
guide	5	ABC mode	34
Get started with the		Predictive text input	36
Quick Guide	7	Use the phone book	39
Menu shortcuts	8	Save names, numbers and e-mail	
Understand wireless network		addresses	39
services	9	Edit names	40
Learn about accessibility		Edit numbers	41
solutions	9	Add text entries	41
Shared memory	11	Find names in the phone	
Contact Nokia	11	book	41
Register your phone	12	Phone memory	42
E-newsletters	12	Delete names and numbers	43
Before you begin	13	Check call history	45
Install the SIM card	13	Check missed, received, or dialed	
Install the battery	14	calls	45
Charge the battery	15	Choose options in call lists	46
Battery notes	15	Clear call lists	46
Remove the battery	16	Use call timers	47
Set up your headset	16	Manage call costs	48
Remove the SIM card	17	Check data calls	48
About your phone	18	Advanced calling features .50	
Switch on your phone	18	Use in-call options	50
About the antenna	19	Make an international call	51
About the Start screen	19	Use automatic redial	51
About indicators and icons	20	Use 1-touch dialing	52
Make and answer calls	23	Use anykey answer	53
Make a call	23	Use network services	53
End a call	24	Use voice features	59
Answer a call	24	About voice mail	59
Reject a call	24	Use voice dialing	60
Silence an incoming call	25	Use voice commands	62
Redial the last-dialed number	25	Audible alerts	64
The menu	26	Personalize your phone	65
Scroll bar	26	Profiles	65
About menu shortcuts	26	Accessory settings	67

Draft

Polyphonic sound (MIDI)	71	Your WAP browser	108
Download ringing tones	71	Notes on mobile Internet	
Choose the display language . 72		access	108
Add a welcome note	72	Set up for browsing	109
Activate help text	73	Sign on to the mobile	
Set up the time and date	73	Internet	109
Display settings	75	Use browser options	110
Use caller groups	76	Navigate the mobile	
Restore factory settings	79	Internet	110
Change Xpress-on™ color		Use bookmarks	111
covers	80	Disconnect from the mobile	
Manage phone security	83	Internet	112
Lock the keypad (Keyguard) . . 83		Security issues	112
About security codes	84	Notes about GPRS	113
PIN codes	84	Your personal digital	
PUK codes	85	assistant	116
Security code	86	Use the calendar	116
Use fixed dialing	86	Use the alarm clock	119
Restrict calls	87	Share business cards	120
Set up a closed user group . . . 88		Use the calculator	121
Communicate with mobile		Make a to-do list	122
messages	89	Use the stopwatch	123
Message settings	89	Online purchases	125
Send and receive text		Use the wallet	126
messages	92	Synchronizing data	130
Communicate with e-mail . . . 95		Fun and games	133
Store messages	97	Game rules	133
Erase messages	99	Customize your phone with	
Send and receive picture		Java™ Applications	134
messages	100	Reference information	137
Receive multimedia messages		Batteries, chargers, and	
(MMS)	102	accessories	137
Use Instant messaging	105	Important safety	
Use the info message		information	138
service	107	Emergency calls	141
Use the service command		Certification information	
editor	107	(SAR)	142
		Care and maintenance	144

Accessories	145
Battery information	145
Chargers and other accessories	146
Technical information ...	153
Troubleshooting	154
Nokia One-Year Limited Warranty	155
Appendix A	
Message from the CTIA	161
Appendix B	
Message from the FDA	165

Draft

NOTES

1 For your safety

Read these simple guidelines. Breaking the rules may be dangerous or illegal. Further detailed information is given in this manual.



SWITCH OFF WHERE PROHIBITED

Do not switch on the phone when wireless phone use is prohibited or when it may cause interference or danger.



ROAD SAFETY COMES FIRST

Don't use a hand-held phone while driving



INTERFERENCE

All wireless phones may get interference, which could affect performance.



SWITCH OFF IN HOSPITALS

Follow any regulations or rules. Switch the phone off near medical equipment.



SWITCH OFF IN AIRCRAFT

Wireless devices can cause interference in aircraft.



SWITCH OFF WHEN REFUELING

Don't use the phone at a refueling point. Don't use near fuel or chemicals.



SWITCH OFF NEAR BLASTING

Don't use the phone where blasting is in progress. Observe restrictions, and follow any regulations or rules.



USE SENSIBLY

Use only in the normal position. Don't touch the antenna unnecessarily.



QUALIFIED SERVICE

Only qualified personnel may install or repair phone equipment.



ACCESSORIES AND BATTERIES

Use only approved accessories and batteries. Do not connect incompatible products.

For your safety

DRAFT



WATER-RESISTANCE

Your wireless phone is not water-resistant. Keep it dry.



CALLING

Ensure the phone is switched on and in service. Enter the phone number, including the area code, then press the **Talk** key. To end a call, press the **End** key. To answer a call, press the **Talk** key.



EMERGENCY CALLS

Ensure the phone is switched on and in service. Press the **End** key as many times as needed (for example, to exit a call, to exit a menu) to clear the display. Enter the emergency number, then press the **Talk** key. Give your location. Do not end the call until told to do so.

NOTES

For your safety

DRAFT

Nokia 3595 phone at a glance

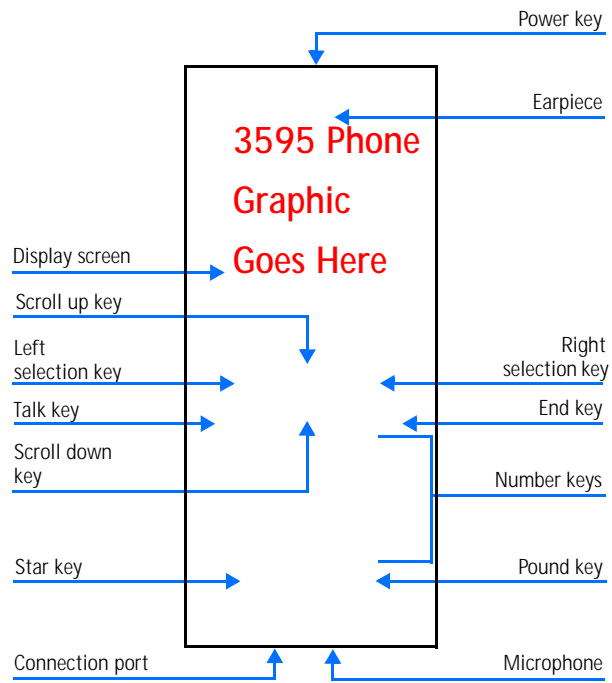

2 Welcome and quick guide

You will find that your Nokia 3595 mobile phone has many useful features for everyday use, such as a calendar, text messaging, and alarm clock.

• GET THE MOST OUT OF THIS GUIDE

The diagram to the left illustrates the various components of your phone. Familiarize yourself with the diagram to help you better understand the instructions that follow.

Understand the terms

This guide uses certain terms for the steps that you are asked to perform.

- **Press** means to briefly press, then release a key. For example, **press 7** means press the key on the keypad that is labeled with the number 7 and the letters, "p, q, r, s."
- **Press and hold** means to press and hold a key for two to three seconds (depending on the feature being used), then release the key.
- **Highlighted** options on the screen are enclosed within a dark bar. The selection keys are used to act on the highlighted option.
- Selection keys are used to select a menu option, press the selection key below the menu item on the phone's screen. In the example to the right, to select **Details**, you would press the left selection key. To exit the phonebook, press **Back** (the right selection key).
- **Scroll** keys are used to move up and down in the menus. For example, if instructed to scroll to another phonebook entry, this means to press **Scroll up** or **Scroll down** key.
- **Talk** and **End** keys: Press the **Talk** key to place a call or to answer an incoming call. Press the **End** key to end a call or press and hold to return to the idle screen.

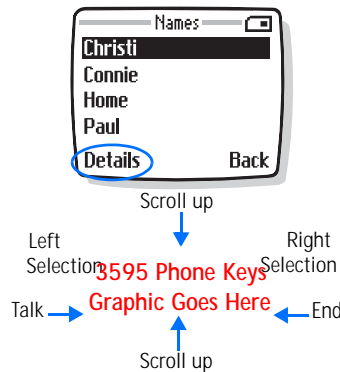

Notice text clues

This user guide provides text clues to make instructions clear and easy to follow.

Clue	What it means
bold	Indicates one of the following items: <ul style="list-style-type: none">• The word or phrase appears on the phone's screen.• Special text, such as Notes and Warnings.• The name of one of the phone keys.
bold and blue	Indicates the text is an address on the World Wide Web.
<i>italic</i>	Italics indicate emphasis. Pay close attention to any information in italics.

Follow graphic clues

This guide uses icons (graphic clues) to alert you to important information.



Tip: Information about a shortcut or an alternate method of doing something.



Note: Explanation about a feature or an important concept.



Important: Critical information about a feature.



Caution: Help to avoid information loss.



Warning: Help to avoid personal injury, damage to the phone, or property damage.

Look for updates

From time to time, Nokia updates this user guide to reflect changes or corrections. The latest version will be available at www.nokia.com/us.

Also, an interactive tutorial will be available at www.nokiahowto.com.

• GET STARTED WITH THE QUICK GUIDE

Make a call	Enter a phone number, press the Send key.
Answer a call	Press the Talk key.
Answer with call waiting	Press Options, then select Answer call.
End a call	Press the End key.
Reject a call	Press the End key.
Redial	Press the Talk key twice.
Adjust call volume	During a call, press the Scroll up or Scroll down key.
Use the in-call menu	During a call, press Options.
Save a name and number	Enter a number, press Options, select Save, enter a name, and press OK.
Recall a name/number	Press the Scroll up or Scroll down key to scroll to the name.
Recall a name/number during a call	Press Options, select Phone book, select Find, scroll to the name/number.
Add e-mail address	Recall the name, press Details, press Options, scroll to Add detail, press Select, select E-mail, enter e-mail address, and press OK.
Add multiple numbers	Recall the name, press Details, press Options, scroll to Add number, press Select. Select one of the number types: General, Mobile, Home, Work, or Fax. Add a number, press OK.
Send a text message	Press Menu 01-1-1, enter message, press Options, select Send, enter a phone number, and press OK.
Send a picture message	Press Menu 01-1-1, press Options, select Insert picture. Scroll to a picture you like, press View, press Insert, enter a text message, press Options, select Send, enter a phone number, and press OK.
Use browser	Press and hold 0 OR press Menu 10, scroll to Home, then press Select. Note: Internet content/services designed for mobile devices requires subscription to service.

• MENU SHORTCUTS

Press Menu followed by the menu numbers.

Note: Menu items may vary depending on network and accessories used.

1	MESSAGES		5	GALLERY	
	Text messages	01-1		View folders	5-1
	Multimedia messages	01-2		Add folder	5-2
	Instant messaging	01-3		Delete folder	5-3
	Voice messages	01-4		Rename folder	5-4
	Info messages	01-5		Gallery downl.	5-5
	Message settings	01-6	6	ORGANIZER	
	Service command editor	01-7		Alarm clock	6-1
	Chat	01-8		Calendar	6-2
2	CALL LOG			To-do list	6-3
	Missed calls	2-1		Wallet	6-4
	Received calls	2-2		Synchronize	6-5
	Dialed numbers	2-3	7	GAMES	
	Delete recent call lists	2-4		Select game	7-1
	Call timers	2-5		Game downlds.	7-2
	GPRS connection timer	2-6		Memory	7-3
	GPRS data counter	2-7		Settings	7-4
	GPRS connection timer	2-8	8	APPLICATIONS	
	Message Counter	2-9		Select app.	8-1
3	PROFILES			App. downloads	8-2
	Normal	3-1		Memory	8-3
	Silent	3-2	9	EXTRAS	
	Loud	3-3		Calculator	9-1
	Outdoor	3-4		Stopwatch	9-2
	My profile 1	3-5	10	CONNECTIVITY	
	My profile 2	3-6	11	SERVICES	
4	SETTINGS		12	SIM SERVICES	
	Time and date settings	4-1	13	NET MONITOR	
	Call settings	4-2			
	Phone settings	4-3			
	Display settings	4-4			
	Tone settings	4-5			
	Network services	4-6			
	Accessory settings	4-7			
	Security settings	4-8			
	Restore factory settings	4-9			

• UNDERSTAND WIRELESS NETWORK SERVICES

A number of features included in this guide are called Network Services. These are special services that you arrange through your wireless service provider. Before you can take advantage of any of these Network Services, you must subscribe to them through your service provider and obtain instructions for their use from your service provider.

Network services for the Nokia 3595 phone include:

- Voice mail
- Call waiting, call forwarding, and caller ID
- Text and picture messages
- Info Message Service
- Notifications on SIM update
- Cell info display
- Service command editor
- Selected Internet access services
- GPRS services



Note: Some networks may not support all language-dependent characters and/or services.

• LEARN ABOUT ACCESSIBILITY SOLUTIONS

Nokia is committed to making mobile phones easy to use for all individuals, including those with disabilities. Accessibility solutions are offered through alternate user guide formats and mobile phone accessories.

Accessible features

The Nokia 3595 phone has many accessible features, including:

- Ability to send and receive short text messages
- Convenience of one-touch dialing
- Ability to define ring tones for different caller groups
- Large easy-to-read display with adjustable font size
- Vibrating alert for incoming calls
- Voice dialing and commands for handsfree operation
- Audible alerts indicating battery and signal strengths

Access alternate formats

This user guide is available in alternate formats. Contact Nokia at www.nokiaaccessibility.com or call 1-888-665-4228 for more information.

LPS-3 Mobile Inductive Loopset

The LPS-3 Mobile Loopset gives people with T-coil equipped hearing aids the ability to make and receive calls without noise interference.

Also compatible with the Nokia 3300, 3500, 8200, 8300 and 8800 series digital phones, the loopset gives hearing-impaired users clear access to digital telephony.

The loopset is easy to use. You wear the loopset around your neck, connect it to your phone, and speak directly toward the microphone. For more information see "Set up the loopset profile" on page 69.

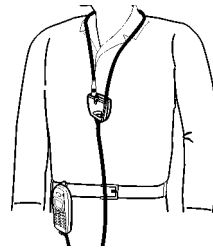

Note: The loopset can be purchased separately as an accessory. For operating instructions, refer to the booklet that comes with the LPS-3.

TTY/TDD Adapter (HDA-9)

The TTY/TDD Adapter is a Nokia accessory that allows you to connect your mobile phone to a Telecommunications Device for the Deaf (TTY/TDD) to make a call in digital mode.

WHAT YOU WILL NEED

In addition to the Nokia 3595 phone, you'll need the following for TTY/TDD communication.

- A TTY/TDD device that is "cellular ready" or "cellular compatible"
- A cable for connecting the TTY/TDD to your phone, usually supplied by the manufacturer of the TTY/TDD device
- The TTY/TDD Adapter (HDA-9), which can be purchased separately as an accessory at www.nokia.com/us

For information on choosing a profile so that the phone recognizes the TTY/TDD device, see "Set up the TTY/TDD profile" on page 69.

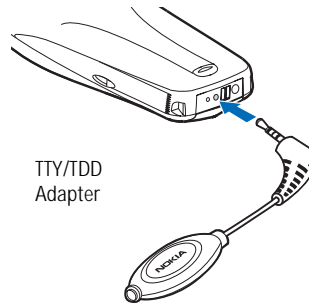

• SHARED MEMORY

The following features in this phone may share memory: ringing tones, pictures, screen savers, and Java games and applications. Using any of these features may reduce the memory available for any features sharing memory. This is especially true with heavy use of any of the features (although some of the features may have a certain amount of memory specially allotted to them, in addition to the amount of memory shared with other features). For example, saving many games may take all of the shared memory and your phone may display a message that the memory is full. In this case, delete some of the information or entries stored in the shared memory features before continuing.

• CONTACT NOKIA

If you ever need to call Nokia Customer Care or your service provider, you will need to provide specific information about your phone.

This information is provided on the phone label. The label is on the back of the phone (under the battery). It shows the following:

- Phone type
- Phone model
- IMEI



Important: Do not remove or deface the label.

Tip: See "Remove the battery" on page 16 for instructions on how to access the phone label.

Have the phone or accessory available

Whether you are calling about your phone or an accessory, have the equipment with you when you call. For example, if you are calling about a headset, please have it available. If a Nokia representative asks a specific question about the accessory, you will have it available for quick reference.

Nokia Customer Care Center, USA	Customer Care Centre, Canada
Nokia Mobile Phones 7725 Woodland Center Boulevard, Suite #150 Tampa, Florida 33614 Tel: 1-888-NOKIA-2U (1-888-665-4228) Fax: 1-813-249-9619 For TTY users: 1-800-24-NOKIA (1-800-246-6542)	Nokia Products Ltd. 601 Westney Rd. South Ajax, Ontario L1S 4N7 Tel: 1-905-427-1373 1-888-22-NOKIA (1-888-226-6542) Fax: 1-905-427-1070 Web site: www.nokia.ca

• REGISTER YOUR PHONE

Make sure to register your phone at www.warranty.nokiausa.com or 1-888-NOKIA-2U (1-888-665-4228) so that we can serve your needs better if you should need to call the center or have your phone repaired.

• E-NEWSLETTERS

When you register your phone, you can sign up for Nokia's e-newsletter *Nokia Connections* if you would like. You will receive tips and tricks on using your phone, accessory information, and special offers.

3 Before you begin

Before you begin, you need to prepare your phone by installing the SIM card, and charging the battery. This chapter covers these topics as well as instructions on how to attach the optional headset.



Note: Your service provider supplies the SIM card and headset.

• INSTALL THE SIM CARD



Important: Switch off the phone before installing the SIM card. Press and hold the power key for about two seconds to turn your phone off.

- 1 With the back of the phone body facing you, locate the SIM card slot.
- 2 Install the SIM card by sliding it gently into the slot: beveled corner on the right, gold contact area face down.

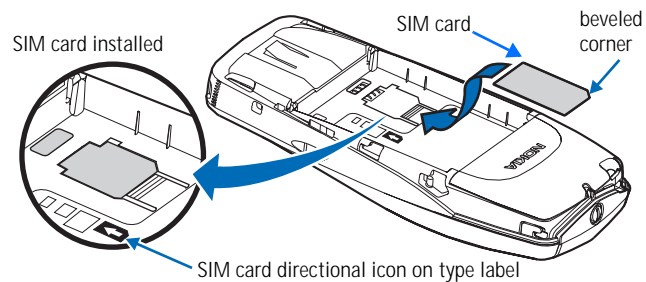

Notes about SIM cards

- Keep all miniature SIM cards out of the reach of small children.
- The SIM card and its contacts are easily damaged by scratches or bending, so be careful when handling, inserting, or removing the card.

Before you begin

DRAFT

• INSTALL THE BATTERY

- 1 Place the battery in the compartment with the label side facing up and the golden contact area of the battery aligned with the contact prongs inside the phone.
- 2 Slide the battery until it snaps into place.

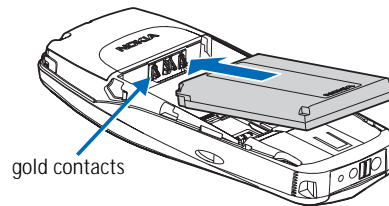

Replace the back cover

- 1 Direct the back cover towards the locking catches on the phone.
- 2 Slide the back cover until it locks into place.

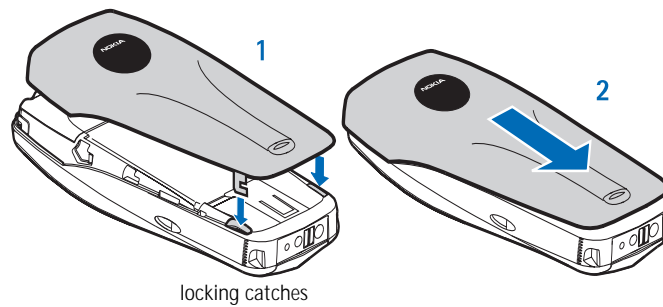

• CHARGE THE BATTERY

- 1 Connect the charger to a standard wall outlet.
- 2 Connect the lead from the charger to the bottom of the phone.
- 3 The battery power indicator (or battery bar) appears on the screen and starts scrolling. If the phone is on, **Charging** appears briefly on the screen.
- 4 When the battery bar stops scrolling, the battery charge is complete. **Battery full** appears also, if the phone is on.
- 5 Disconnect the charger from the phone.

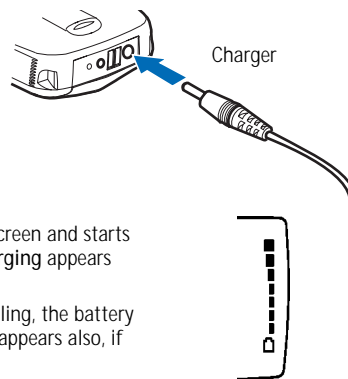

• BATTERY NOTES

Use the following guidelines to obtain the best performance from your battery:

- Recharge your battery only with a charger approved by Nokia.
- With your phone turned off, charge your new battery for three hours before its first use. Use the battery until it is fully discharged. Repeat this procedure twice for a total of three charging cycles.
- Battery operation time may be less than the estimated times during the first charges. This condition is normal.
- When the battery is fully discharged, the scrolling bars may not appear immediately.
- After the first charge, you can make and receive calls during the charging cycle, but the calls interrupt the charge. When the phone call ends, the charge will resume.
- The bars on the screen stop scrolling and remain constant when the phone is charged. If you leave the phone connected to the charger, the battery receives an additional charge.
- If the battery is completely empty, it may take a few minutes before you can make or receive calls.
- The charging time depends on the charger and battery that you use.



Note: The battery will accept a "trickle charge" for an additional two hours. For more details, see "Battery information" on page 145.

Before you begin

DRAFT

• REMOVE THE BATTERY

If you purchase a new battery or need to access information on the phone label, you may need to remove the battery.

 **Important:** Switch off the phone before removing the battery. Do not puncture or burn the battery. Please recycle or dispose of properly.

- 1 With the back of the phone facing you, press and hold the back cover release button.
- 2 Slide the cover up, then lift it off the phone.
- 3 Lift out the battery.

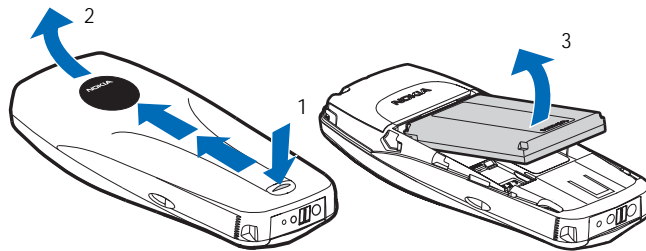

• SET UP YOUR HEADSET

Your phone may come with a headset you can use while talking on your phone. The headset provides convenient handsfree use of the phone.

Connect the headset

- 1 Insert the headset plug into the bottom of your phone.
- 2 Put the round ear plug into one ear.

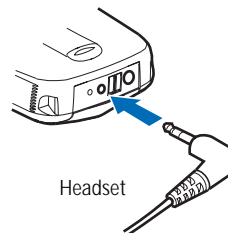

Use the headset



With the headset connected, you can make and answer calls as usual, using the keypad to press the Talk key and the End key or to enter numbers to call.

The microphone for the headset hangs at the side of your head. Although the microphone may seem far from your mouth, you can speak at a normal volume.

• REMOVE THE SIM CARD

If you ever need to take the SIM card out of the phone, follow these steps.



Warning: Keep all miniature SIM cards out of the reach of small children.

- 1 Remove the back cover and battery. See "Remove the battery" on page 16.
- 2 Press the plastic tab of the SIM card holder down.
- 3 Gently push the SIM card towards the top of the phone.

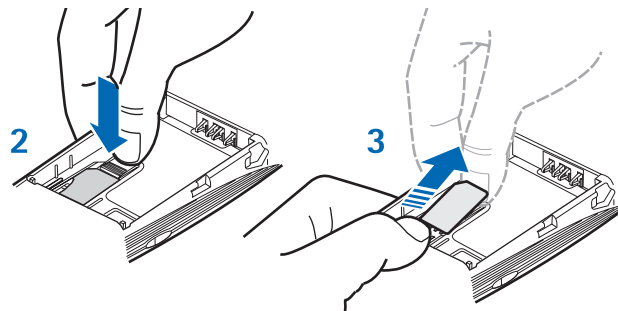

4 About your phone

• SWITCH ON YOUR PHONE

- Press and hold the power key for about 2 seconds. After your phone is on, when any key is pressed, the keypad and display lights stay on for up to 15 seconds.
The phone may ask for a Personal Identification Number (PIN) or a security code. Your service provider supplies the PIN code. See "About security codes" on page 84 for more information.



Warning: Do not switch the phone on when wireless phone use is prohibited or when it may cause interference or danger.

Back cover

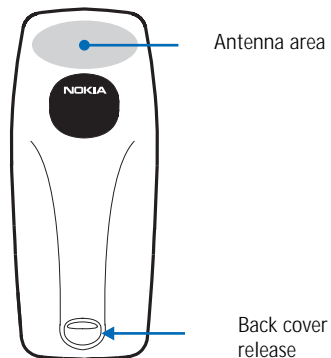

On the back of your phone, you will find the back cover release button and an internal antenna.

• ABOUT THE ANTENNA



Tip: Your phone has a built-in antenna. As with any other radio transmitting device, do *not* touch the antenna unnecessarily when the phone is switched on.

Contact with the antenna affects call quality and may cause the phone to operate at a higher power level than otherwise needed.

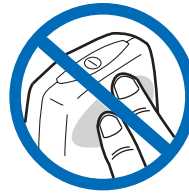

Not touching the antenna during a call optimizes the antenna performance and the talk-time of your phone. Hold the phone as you would any other telephone, with the antenna area pointed up and over your shoulder.

• ABOUT THE START SCREEN

When you turn on your phone, the first screen that appears is the Start screen. In the middle of the Start screen, you may see information indicating which wireless network your phone uses. This information can vary between phones. Other indicators and icons appear on this Start screen and are described in the next section.



• ABOUT INDICATORS AND ICONS

On your phone, you have two types of identifiers: indicators and icons.

Indicators

Indicators show the status of the phone. The phone uses three types of indicators:

Signal
Strength
Indicator

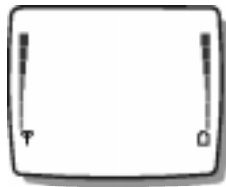



Battery
Strength
Indicator

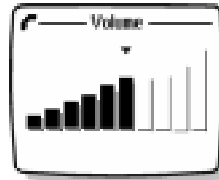















- The signal strength indicator: shows the strength of the signal to your phone.
- The battery strength indicator: shows how much power is left in your phone's battery.
- The volume indicator: shows the earpiece volume level. See "Adjust the earpiece volume during a call" on page 24 for details.
- The audible signal and battery indicator: indicates by a series of beeps that either the signal or battery strength is running low on your phone. You need to set up this feature on your phone through the voice command function before it will operate. See "Use Voice commands" on page 62 and "Audible alerts" on page 64 for more information.











Icons

Icons are graphical representations of a specific item or situation. The following table shows examples and tells you what each icon means.

Icon	What it means
	Line 1 is selected for outgoing calls.
	Line 2 is selected for outgoing calls.
	You have an active call.

Icon	What it means
	You have a call on hold.
	You have one or more new voice mail messages.
	You have a new voice mail message on line 1.
	You have new voice mail messages on line 1 and line 2.
	You have a new voice mail message on line 2.
	You have one or more new text messages. If the icon blinks, text message memory is full.
	Keyguard is on. Your phone will not accept any key presses.
	The alarm clock is set.
	The call alert and text message alert tones are turned off.
	The Timed profile is selected.
	Incoming voice calls are being forwarded to another number.
	You have forwarded all voice calls received on line 1.
	You have forwarded all voice calls received on line 2.
	You have forwarded all voice calls received on lines 1 and 2.
	The phone is ready for you to enter a response.
	There is a voice tag attached to a name in your phone book.

Icon	What it means
	Indicates an e-mail address in your phone book.
	You have assigned the name and number to a caller group.
	The headset is attached to your phone.
	The car kit is attached to your phone.
	The loopset is attached to your phone.
	A Telecommunications Device for the Deaf (TTY/TDD) is attached to your phone.
	The phone book entry is stored on the SIM card.
	You are using predictive text input. Your phone uses a built-in dictionary to predict or guess the word entered.

5 Make and answer calls

This chapter tells you how to make and receive calls and how to adjust certain options.

• MAKE A CALL

Check the signal strength

The signal indicator on the left side of your phone screen shows the strength of the network radio signal. The indicator scrolls as the signal strength increases and decreases. To get the strongest signal, try moving your phone slightly. If you are inside a building, move toward a window.

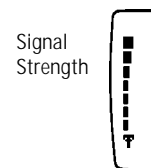

Use the keypad

- 1 Enter the area code (if required in your local calling area) and phone number.
- 2 Press the Talk key.



Warning: Do not switch the phone on when wireless phone use is prohibited or when it may cause interference or danger.

Use the phone book

- 1 From the Start screen, press the Scroll up key or the down scroll key and scroll to the number you want.



Tip: To skip ahead quickly in the list, press the number key that matches the first letter of the name.

- 2 Press the Talk key to make the call.

Adjust the earpiece volume during a call

- To increase the volume of a call, press the Scroll up key and watch the volume indicator go up.
- To decrease the volume, press the bottom scroll key and watch the volume indicator go down.

If an accessory with its own loudspeaker is connected to your phone, the volume keys adjust the volume for that accessory.

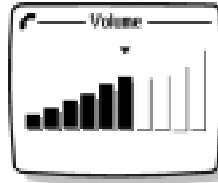

• END A CALL

Press the End key.

• ANSWER A CALL

When someone calls you, the phone alerts you and Calling flashes on the display.

To answer, press the Talk key.

OR

Press Options, scroll to Answer call, then press Select.

Caller ID



Note: This feature may not be available in all wireless systems. Contact your service provider for details and availability.

When Caller ID is active, your phone may display the caller's phone number. The caller's name may also appear, if his/her name and number are stored in the phone book. See "Use the phone book" on page 39.

• REJECT A CALL

Press the End key.

OR

Press Options, scroll to Decline call, then press Select.

- **SILENCE AN INCOMING CALL**

You can stop the ring for an incoming call by pressing Silence.
Then, answer or decline the call.

- **REDIAL THE LAST-DIALED NUMBER**

Press the Talk key twice.

Dial any of the twenty last-dialed numbers

- 1 Press the Talk key.
- 2 Scroll to the number you want to redial.
- 3 Press the Talk key again.

6 The menu

Your phone offers many functions that are grouped in menus and submenus. Access these menus with the selection keys and scroll keys or by entering the appropriate shortcut number. See “Nokia 3595 phone at a glance” on page 4 and “Understand the terms” on page 5 for more information about the selection keys and scroll keys and their functions.

• SCROLL BAR

While using phone menus, a scroll bar appears at the far right of the screen. This bar indicates where you are in the menu. Each numbered “tab” on the bar represents a different menu item.



For example, press Menu once. The scroll bar appears with the first (top) tab displayed. A different tab appears each time you press the Scroll up or Scroll down key.

• ABOUT MENU SHORTCUTS

You can use a series of numbers, or shortcuts, to access frequently used features. For example, if you use the phone alarm clock each morning, you may want to learn the menu shortcut for quick access.

To use a shortcut, press **Menu**, then the numbers that correspond to the feature.



Tip: Be sure to press the numbers quickly in sequence.

For example, to set your Alarm clock, press **Menu 6 -1** (**Organizer > Alarm clock**). For complete instructions on using this feature, see “Use the alarm clock” on page 119.

• LIST OF MENU SHORTCUTS

Here is an abbreviated list of menu items and their shortcuts. Later chapters tell you how to work with the menus, explaining their functions.





Note: Some items may not appear due to the SIM card configuration and network service availability.

For quick access to the Messages menu, press **Menu**, then **0**, then the menu numbers.

For example, to access your Messages Inbox, press **Menu 01-2**.

- 
- 1 Messages
 - 1 Text messages
 - 1 Create message
 - 2 Inbox
 - 3 Create e-mail
 - 4 Sent items
 - 5 Archive
 - 6 Templates
 - 7 My folders
 - 8 Distribution lists
 - 9 Delete messages
 - 2 Multimedia messages
 - 1 Create message
 - 2 Inbox
 - 3 Outbox
 - 4 Sent items
 - 5 Saved items
 - 6 Delete messages
 - 3 Instant messaging
 - 4 Voice messages
 - 1 Listen to voice messages
 - 2 Voice mailbox number
 - 5 Info messages
 - 6 Message settings
 - 1 Text messages
 - 2 Multimedia msg.
 - 3 Other settings
 - 7 Service command editor

- 2 Call log 
 - 1 Missed calls
 - 2 Received calls
 - 3 Dialed numbers
 - 4 Delete recent call lists
 - 1 All
 - 2 Missed
 - 3 Received
 - 4 Dialed
 - 5 Call timers
 - 1 Duration of last call
 - 2 Duration of received calls
 - 3 Duration of dialed calls
 - 4 Duration of all calls
 - 5 Life timer
 - 6 Clear timers
 - 6 Call costs (*Depends on network availability*)
 - 1 Last call units
 - 2 All calls units
 - 3 Call cost settings
 - 7 GPRS data counter
 - 1 Data sent in last session
 - 2 Data received in last session
 - 3 All sent data
 - 4 All received data
 - 5 Clear counters
 - 8 GPRS connection timer
 - 1 Duration of last session
 - 2 Duration of all sessions
 - 3 Clear timers
 - 9 Message Counter
 - 1 Sent messages
 - 2 Received messages
 - 3 Clear counters

- 3 Profiles 
 - 1 Normal
 - 1 Select
 - 2 Customize
 - 1 Ringing options
 - 2 Ringing tone
 - 3 Ringing volume
 - 4 Vibrating alert
 - 5 Message alert tone
 - 6 Keypad tones
 - 7 Warning tones
 - 8 Alert for
 - 9 Profile name (*Appears under Silent, Quiet, Loud, My profile 1 and My profile 2*)
 - 3 Timed
 - 2 Silent
 - 3 Quiet
 - 4 Loud
 - 5 Outdoor
 - 6 My profile 1
 - 7 My profile 2
- 4 Settings 
 - 1 Tone settings
 - 1 Ringing options
 - 2 Ringing tone
 - 3 Ringing volume
 - 4 Vibrating alert
 - 5 Message alert tone
 - 6 Keypad tones
 - 7 Warning tones
 - 8 Alert for
 - 2 Time and date settings
 - 1 Clock
 - 2 Date
 - 3 Auto-update of date & time
 - 3 Call settings
 - 1 Automatic redial
 - 2 1-touch dialing
 - 3 Summary after call
 - 4 Anykey answer

- 4 Phone settings
 - 1 Language
 - 2 Automatic keyguard
 - 3 Cell info display
 - 4 Welcome note
 - 5 Help text activation
 - 6 Start-up tone
 - 7 Memory status
- 5 Display settings
 - 1 Wallpaper
 - 2 Color schemes
 - 3 Operator logo
 - 4 Screen saver timeout
 - 5 Display brightness
- 6 Network services
 - 1 Call forwarding
 - 2 Call waiting
 - 3 Send own caller ID when calling
 - 4 System selection
 - 5 Confirm SIM service actions
- 7 Accessory settings
 - 1 Headset
 - 2 Handsfree (*Only shows up when phone is connected to Car Kit*)
 - 3 Loopset
 - 4 TTY/TDD
- 8 Security settings
 - 1 PIN code request
 - 2 Call restrictions
 - 3 Fixed dialing
 - 4 Closed user group
 - 5 Security level
 - 6 Change access codes
- 9 Restore factory settings
- 5 Gallery 
 - 1 View folders
 - 2 Add folder
 - 3 Delete folder
 - 4 Rename folder
 - 5 Gallery downl.

6 Organizer 

- 1 Alarm clock
- 2 Calendar
- 3 To-do list
- 4 Wallet
- 5 Synchronize

7 Games 

- 1 Select game
 - 1 Airglider
 - 2 Bowling
 - 3 Backgammon
 - 4 Skydiver
- 2 Game downlds. (depends on network availability)
- 3 Memory
- 4 Settings
 - 1 Game sounds
 - 2 Game lights
 - 3 Shakes
 - 4 Game controls
- 5 Club Nokia ID (depends on network availability)

8 Applications 

- 1 Select app.
- 2 App. downloads
- 3 Memory

9 Extras 

- 1 Calculator
- 2 Stopwatch
- 3 Voice commands

10 Connectivity

- 1 Synchronizes
- 2 GPRS connection

11 Services 

THE FOLLOWING MENU ITEMS MAY VARY; CONTACT YOUR SERVICE PROVIDER.

- 1 Home
- 2 Bookmarks

- 3 Service inbox
 - 4 Settings
 - 1 Active service settings
 - 2 Edit active service settings
 - Settings' name
 - Homepage
 - Session mode
 - Connection security
 - Data bearer
 - | | | |
|---------------------|-----------|---------------------|
| GSM data | or | GPRS |
| Dial up number | | GPRS connection |
| IP address | | GPRS access point |
| Authentication type | | IP address |
| Data call type | | Authentication type |
| Data call speed | | Login type |
| Login type | | User name |
| User name | | Password |
| Password | | |
 - 3 Appearance settings
 - 4 Cookie settings
 - 5 Certificates
 - 6 Security module settings
 - 7 Service inbox settings
 - 5 Go to address
 - 6 Clear the cache
- 12 SIM services
FOR AVAILABILITY, RATES AND INFORMATION ON USING SIM SERVICES, CONTACT YOUR SIM CARD VENDOR, E.G. NETWORK OPERATOR, SERVICE PROVIDER, OR OTHER VENDOR.
- 13 Net monitor

• PHONE BOOK MENU



- 1 For access to the phone book, press the End key to return to the Start screen.
- 2 Press Names.

These options may be available, depending on your SIM card:

- 1 Find
- 2 Add contact
- 3 Edit name
- 4 Delete
- 5 Copy
- 6 Add number
- 7 Settings
 - 1 Memory in use
 - 2 Phone book view
 - 3 Memory status
- 8 1-touch dialing
- 9 Voice tags
- 10 Caller groups
 - 1 Family
 - 2 VIP
 - 3 Friends
 - 4 Business
 - 5 Other
- 11 Info numbers (ONLY SHOWS UP IF YOU HAVE INFO MESSAGE SERVICE INCLUDED ON SIM CARD)
- 12 Service nos.
- 13 Own numbers

7 Enter letters and numbers

You can enter letters and numbers into your phone for a person's name and phone number, writing a text message, etc. There are two ways to do this:

-  ABC mode, for making entries in the phone book and renaming caller groups.
-  Predictive text input, for writing text messages, adding notes to a picture message, entering calendar notes, and entering a web address using WAP services.

• ABC MODE

You can use the ABC mode to enter information into the phone book.

Add letters

- 1 From the Start screen, press Names, then scroll to Add entry and press Select.
- 2 Find the key that has the letter you want to enter.
- 3 Press the key repeatedly until the letter appears on the screen.



Tip: The phone automatically switches to lower case after you enter the first letter.

Depending on the selected display language, the following characters may be available.

Key	Characters	Key	Characters
1	. ! ? ! * 1 - () @ / : _	7	PQRS7
2	ABC2	8	TUV8
3	DEF3	9	WXYZ9
4	GHI4	0	space, 0
5	JKL5	*	(See page 35 for details.)
6	MNO6	#	Changes letter case



Note: Some networks may not support all language-dependent characters.

Enter spaces and punctuation

- To enter a space, press 0 once.
- To enter punctuation, press 1 repeatedly until the character you want appears.

Erase mistakes

If you make a mistake:

- Press **Clear** to erase each character.
- Press and hold **Clear** to erase the entire field of characters.

Change letter case

To switch between uppercase and lowercase letters, press #.

The ABC icon switches to abc, showing you are using lowercase letters.

Enter numbers

To enter numbers:

- Press and hold # to switch to 123 mode. Press the appropriate number key to enter a number.
OR
- While in ABC mode, press and hold the corresponding number key until the number appears.

If you make a mistake:

- Press **Clear** to erase the number.
- To switch back to the ABC mode, press and hold # again.

Use special characters

IN ABC MODE

- 1 Press #. A screen appears with the following special characters:
., ' ? ! " - () @ / : _ ; + & % * = < > £ ¢ \$ ¥ ¢ [] { } \ ~ ^ ` ¡ ¢ §
- 2 Use scroll keys to select the character you want, then press **Insert**.

DRAFT

IN 123 MODE

You can access the following special characters only in 123 mode. There are two places you can use these characters:

- At the **Start** screen, when you dial a phone number
- At the number prompt, when you add a new entry to the phone book

Action	Character's Function
Press * to enter *.	* - Use this character to send command strings to the network. Contact your service provider for details.
Press * twice to enter +.	+ - Use this character as a prefix for dialing international numbers.
Press * three times to enter p.	p - Use this character to create a pause that occurs when dialing a number. Numbers entered to the right of this special character are automatically sent as touch tones after a 2.5-second pause.
Press * four times to enter w.	w - Use this character to create a wait; digits to the right of the w are not sent until you press the Talk key.

• PREDICTIVE TEXT INPUT

Predictive text input allows you to write messages much faster than the ABC mode. With predictive text input, you only need to press each number key once for each letter. Your phone uses a built-in dictionary to predict or guess what you are writing. You can also add new words to the dictionary.



Note: Predictive text input may not be available for all languages. It is not available for adding names to the phone book.

Select a language and turn on predictive text

- 1 Press Menu 01-1-1 (Messages > Text messages > Create message).
- 2 Press Options, scroll up to Predictive text, then press Select.
- 3 Scroll to the language you want, then press Select.
T9 prediction on appears.

Turn off predictive text

- To switch from predictive text input to ABC mode, repeat steps 1 through 3 above, then select Prediction off.
OR
- While writing the message, quickly press # twice to switch between predictive text input and ABC mode.



Tip: Your key presses must be quick! Press # twice in about 1.5 seconds.

Write words using predictive text

- Press the number key that corresponds to the letter you want to enter.
For example, to write "Nokia" with the English dictionary selected, press the following keys:

6 (for N) 6 (for o) 5 (for k) 4 (for i) 2 (for a)



The display shows the above words for each key pressed.

Since the displayed word changes after each key stroke, disregard the word until you have keyed in all the characters.

- If the displayed word is correct, press 0 to accept the word and add a space.
- If the displayed word is not correct, press * to see the other possible matches.
- If the word you are trying to write is not in the dictionary, a question mark appears.
- To check the number of available characters, refer to the counter in the upper right corner of the screen.





Add a new word to the dictionary

If the word you are trying to enter does not show up as a possible match, you can add the word to the dictionary.

- 1 Press * repeatedly until Spell appears in place of Options.
- 2 Press Spell, then enter the word, using ABC mode.
- 3 Press Save to add the word to the dictionary.

Use predictive text shortcuts

You can use predictive text shortcuts to write messages. Press Menu 01-1-1 (Messages > Text messages > Create message) and use the following shortcuts:

- Press * to view the next matching word if the underlined word is not the word you intended.
- Press **Spell** to add a new word to the dictionary.
- Press **0** to accept a word and add a space.
- Press and hold **#** to enter a number.
- Press **#** to change the character case. **ABC** indicates uppercase, while **abc** indicates lowercase, and **Abc** is the default for entering names in the phone book.
- Press twice to select predictive input or ABC mode.  **ABC** and  **abc** indicate ABC mode, while  **Abc** and  **abc** indicate predictive text input.
- Press **Clear** to delete the character to the left of the cursor.
- Press **1** to add a punctuation mark. To change the underlined symbol, press **1** repeatedly until the desired symbol appears.

Insert symbols

- 1 Press and hold * until the symbol screen appears.
- 2 Scroll to the desired symbol and press **Insert**.

Insert numbers

- 1 To add a number to the message, press and hold **#**.
- 2 Key in the desired numbers, then press and hold **#** to return to ABC mode.

Write compound words

- 1 Write the first part of the word and press the down scroll key to accept it.
- 2 Write the last part of the compound word and press **0** to enter the word in memory.

8 Use the phone book

You can keep track of names and numbers in your phone book.

- Names are saved in the phone book memory and/or SIM memory.
- For each name in the phone memory, you can add up to five phone numbers, including the following categories:



- For each name in the phone memory, you can also store an e-mail address, a web address and a street address.
- For more details about the phone's memory and SIM memory, see "Phone memory" on page 42.

• SAVE NAMES, NUMBERS AND E-MAIL ADDRESSES

Quick Save

Here is a quick and easy way to save a name and number into the phone book.

- 1 Make sure your phone is at the **Start** screen.
- 2 Enter the number you want to save, then press **Options**.
- 3 Scroll to **Save**, then press **Select**.
- 4 Enter the name and press **OK**.

Save a number only

- 1 Enter the phone number.
- 2 Press and hold **Options**.
- 3 Scroll to **Save**, press **Select**, and press **OK**.

Save a name and number while in a call

- 1 Press **Options**.
- 2 Scroll to **Phone book**, then press **Select**.
- 3 Scroll to **Add entry**, then press **Select**.
- 4 Enter the name, then press **OK**.
- 5 Enter the phone number, then press **OK**.

Save an e-mail address

You can save an e-mail address for a name in your phone book.



Tip: All phone book entries that contain e-mail addresses must be stored in the phone memory. See "Phone memory and SIM memory" on page 42.

- 1 At the **Start** screen, press the **Scroll up** or the **Scroll down** key to scroll through the list until you find the name you want.
- 2 Press **Details**, then press **Options**.
- 3 Scroll to **Add detail**, then press **Select**.
If the name has been saved to the SIM card, the phone prompts you to move it to the phone memory. Press **Yes**.
- 4 Scroll to **E-mail** and press **Select**.
- 5 Enter the e-mail address, then press **OK**.



Tip: To switch between letters and numbers, press and hold the **#** key. To enter **@** in the e-mail address, press the ***** key, scroll to **@**, then press **Insert**.

• EDIT NAMES

- 1 At the **Start** screen, press the **Scroll up** or **Scroll down** key to scroll through the list until you find the name you want to change.
- 2 Press **Details**, then press **Options**.
- 3 Scroll to **Edit name**, then press **Select**.
- 4 Edit the name, then press **OK**.

• EDIT NUMBERS

- 1 At the Start screen, press the Scroll up or Scroll down key to scroll through the list until you find the entry you want to change.
- 2 Press Details, then press Options.
- 3 Scroll to Edit number, then press Select.
- 4 Edit the number, then press OK.

• ADD TEXT ENTRIES

You can add a web address, street address, or note for each name.

- 1 At the Start screen, press the Scroll up or the Scroll down key to scroll through the list until you find the name.
- 2 Press Details, then press Options.
- 3 Scroll to Add detail, then press Select.
If the name has been saved to the SIM card, the phone prompts you to move it to the phone memory. Press Yes.
- 4 Scroll to Web address, Street addr. or Note, then press Select.
- 5 Enter your information, then press OK.

• FIND NAMES IN THE PHONE BOOK

- 1 At the Start screen, press Names.
- 2 With Find highlighted, press Select.
- 3 Scroll through the list until you find the name.
- 4 Press Details to show the phone number.
- 5 To call the number, press the Talk key.

Use scroll keys to find a name

At the Start screen, press the Scroll up or the Scroll down key to scroll through the list until you find the name.

• PHONE MEMORY

You can save names and numbers in the internal memory of the phone, SIM card memory, or in a combination of the two. The SIM icon  appears when the phone book entry is saved in SIM memory.



Note: Phone memory is dynamic. The shorter the names and numbers, the more entries you can store in the phone book. The phone's memory can hold from 125 to 500 names, depending on the number of characters used for each name, number, or text entry.

Phone memory and SIM memory

The following table summarizes the differences between the three types of memory you can choose.

Phone feature	Phone memory	SIM memory	Phone and SIM memory
Names capacity	Up to 500 (depending on length of entries)	Up to 250 names (Depends on your SIM card; check with your service provider)	Up to 750 names (both SIM and phone entries are displayed)
Phone numbers	Up to 5 numbers per name	1 number (Depends on your SIM card; check with your service provider)	Up to 5 numbers per name (stored in phone memory)
E-mail, Web address, Street Address and Note	Up to 3 text entries per name	Not available	Up to 3 text entries per name (stored in phone memory)
Caller groups?	Yes	Yes	Yes
Transfer names/numbers to another phone?	No	Yes, contact your service provider for details.	Only numbers stored to SIM can be transferred
Voice tags?	Yes	Yes	Yes

Switch between memory types

The default memory type is **Phone and SIM**.

- 1 At the **Start** screen, press **Names**.
- 2 Scroll to **Settings**, then press **Select**.
- 3 Scroll to **Memory in use**, then press **Select**.
- 4 Scroll to **Phone and SIM**, **Phone**, or **SIM card** then press **Select**.

If you choose to keep **Phone and SIM** as the memory type:

- Names and numbers can be recalled from both the phone and SIM card
- Phone book entries are displayed in a combined list
- New entries are saved to the phone memory.

Check phone book memory status

Check available storage space left in the phone memory or SIM card memory.

- 1 From the **Start** screen, press **Names**.
- 2 Scroll to **Settings**, then press **Select**.
- 3 Scroll to **Memory status**, then press **Select**.
- 4 Scroll to **Phone** or **SIM card**, then press **Select**.

Phone book is full

If your phone book is full, you can save the phone number to another memory or replace an existing entry.

• DELETE NAMES AND NUMBERS



Caution: You cannot undo delete functions, so delete carefully!

Delete a stored number

- 1 At the **Start** screen, press the **Scroll up** or the **Scroll down** key to scroll through the list until you find the entry you want to delete.
- 2 Press **Details**, then press **Options**.
- 3 Scroll to **Delete number**, then press **Select**, then **OK**.

Delete a stored name

- 1 At the Start screen, press the Scroll up key or the down scroll key to scroll through the list until you find the entry you want to delete.
- 2 Press Details, then press Options.
- 3 Scroll to Delete, then press Select, then OK.

Delete entire phone book content



Caution: This feature deletes the entire content of the phone book and cannot be undone!



Warning: If you submit your phone for service, your phone book entries may be erased.

- 1 Press Names.
- 2 Scroll to Delete and press Select.
- 3 Scroll to Delete all and press Select.
- 4 Scroll to the memory (Phone or SIM card) you want to delete, then press Delete.
- 5 Press OK to confirm. Enter your security code and press OK. See "Security code" on page 86 for the default code.

9 Check call history

Your phone registers information about each call you make and receive. The call log keeps track of the following:

- Missed calls
- Received calls
- Dialed calls
- GPRS data sent and received.
- Time spent online for GPRS data transfers



• CHECK MISSED, RECEIVED, OR DIALED CALLS

Your phone saves the last 20 numbers you have missed, received or dialed.



Note: The call log saves the phone numbers of missed or received calls only if the caller's number is available and has not been blocked.

- 1 Press Menu 2 (Call log), then scroll to Missed calls, Received calls or Dialed numbers.
- 2 Press Select, then scroll to the number you want to see.
- 3 To dial the number, press the Talk key.
- 4 Press Options to find more information or to add a number to your phone book.
- 5 Use the scroll keys to display each of the options listed in the following table. Once you find the option you want, press Select.

DRAFT

• CHOOSE OPTIONS IN CALL LISTS

When you view the missed calls, received calls, or dialed calls list and press Options, the following choices may appear.



Note: Not all options will appear each time. Also, the order of options may vary.

Choice	What it does
Call time	Shows the date and time of the last call. Use the scroll keys to view up to five recent call dates/time for the displayed phone number.
Send message	Allows you to write a short text message to the person who called you.
View number	Displays the phone number if the caller's name is stored in the phone book.
Edit number	Allows you to edit the displayed number and save it with a name to your phone book.
Save	Allows you to enter a name for the number and save both to your phone book.
Delete	Allows you to delete the number from the call list.
Call	Dials the number from the call log.

• CLEAR CALL LISTS

This feature clears all the missed, received, and dialed call lists.



Caution: You cannot undo this operation.

- 1 Press Menu 2-4 (Call log > Delete recent call lists).
- 2 Scroll to All, Missed, Received, or Dialed then press Select.



Caution: Missed, received, and dialed calls lists are also deleted when you change the phone security setting or if you use a SIM card that is not one of the five most recent cards used with the phone.

• USE CALL TIMERS

Two phone lines

If you subscribe to a second phone line (see “Work with two phone lines” on page 60), call timers are separate for each phone line. When you view call timers, the call timers that are shown are for the currently selected outgoing line. However, if you view call timers while you are in a call, the call timers that are shown are for the line you are using at that moment.

View the call duration

- 1 Press Menu 2-5 (Call log > Call timers).
- 2 Scroll to Duration of last call, Duration of received calls, Duration of dialed calls, or Duration of all calls.
- 3 Press Back after viewing the selected call timer.

View the Life timer

Your phone keeps track of the total call time (all calls made and received). The life timer is displayed in *hhh:mm* format.

- 1 Press Menu 2-5-5 (Call log > Call timers > Life timer).
- 2 Press Back after viewing the Life timer.

Reset call timers to zero



Note: The life timer cannot be reset.

- 1 Press Menu 2-5 (Call log > Call timers).
- 2 Scroll to Clear timers, then press Select.
- 3 Enter your security code, then press OK.

Show call timer during a call

- 1 While in a call, press Options.
- 2 Scroll to Menu, then press Select.
- 3 Scroll to Call log, then press Select.
- 4 Scroll to Call timers, then press Select.

The time for the active call is shown on the display.



Note: The actual time invoiced for calls by your service provider may vary, depending on network features, billing round-off, etc.

Show call timer after call

Your phone can display the time spent on a call after you end the call. This feature is called **Summary after call**.

TURN ON SUMMARY AFTER CALL

- 1 Press Menu 4-3-3 (Settings > Call settings > Summary after call).
- 2 Scroll to On, then press Select.

After you end a call, the total time for that call appears on the display.

TURN OFF SUMMARY AFTER CALL

- 1 Press Menu 4-3-3 (Settings > Call settings > Summary after call).
- 2 Scroll to Off, then press Select.

• MANAGE CALL COSTS

This network service allows you to check call costs. You can view the last call cost, or the total cost of all calls made or received since the counters were reset. Contact your service provider for availability and instructions.



Note: The actual invoice for calls and services from your service provider may vary, depending upon network features, billing round-off, taxes, etc.

• CHECK DATA CALLS

In addition to keeping track of voice calls, the phone's call log records information about data calls. You can check the amount of GPRS data transferred over the network. You can also keep track of how much time you spend online.



Note: Text messages sent over GPRS are not counted and therefore not included in the data counter or connection timer. For details on pricing and availability, contact your service provider. The actual invoice for calls and services from your service provider may vary, depending upon network features, billing round-off, taxes, etc.

Check the data counter

All data counters are displayed in bytes (B).

- 1 Press Menu 2-7 (Call log > GPRS data counter).
- 2 Scroll to the information you are interested in viewing. Your options include the following:
 - Data sent in last session
 - Data received in last session
 - All sent data
 - All received data

Clear the data counter

- 1 Press Menu 2-7 (Call log > GPRS data counter).
- 2 Scroll to Clear counters, then press Select.
- 3 Enter your security code, then press OK.

Check the connection timer

The time is displayed in *hh:mm:ss* format.



Note: The actual time invoiced for calls by your service provider may vary, depending upon network features, billing round-off, etc.

- 1 Press Menu 2-8 (Call log > GPRS connection timer).
- 2 Scroll to the information you are interested in viewing.
 - Duration of last session
 - Duration of all sessions

Clear the connection timer

- 1 Press Menu 2-8 (Call log > GPRS connection timer).
- 2 Scroll to Clear timers and press Select.
- 3 Enter your security code, then press OK.

10 Advanced calling features

This chapter covers advanced calling features, including:

- In-call options and swapping between calls
- Call settings that you control such as anykey answer
- Network services such as call forwarding

Not all features that are described are available in all wireless networks. Contact your service provider for availability of network services.

• USE IN-CALL OPTIONS

During a call, press **Options** to see the in-call menu.



Note: Not all options will appear each time. The order of options may vary.

Choice	What it does
Lock Keypad	Allows you to lock your phone keypad.
End call	Ends current call.
New call	Allows you to place a new call.
Touch tones	Sends touch tones. Touch tones are the sounds generated when you press a key; touch tones can be used for automated, over-the-phone services such as checking airline arrival/departure times.
Phone book	Switches you to the phone book so that you can look up a name, number, or address.
Menu	Allows you to access your phone menu.
Mute	Disables the microphone so that the other party cannot hear you speak. Mute also affects the microphone of any external accessories connected to your phone.
Hold	Holds or releases a call.



Make a new call

- 1 Enter the second phone number or recall it from the phone book.
- 2 Press the **Talk** key.
OR
- 1 Press **Options**.
- 2 Scroll to **New call**, then press **Select**.
- 3 Enter the second phone number or recall it from the phone book.
- 4 Press **Call**.

With either method, the first call is automatically put on hold.

SWITCH BETWEEN TWO CALLS IN PROGRESS

Press the **Talk** key or **Swap**.

The  icon represents the active call and the  icon represents the call on hold.

END THE ACTIVE CALL

Press the **End** key.

The call on hold becomes the active call.

• MAKE AN INTERNATIONAL CALL

- 1 Press * twice to enter the international dialing prefix (+).
- 2 Enter the country code, area code, and phone number, and press the **Talk** key.

• USE AUTOMATIC REDIAL

Activate automatic redial

- 1 Press Menu 4-3-1 (Settings > Call settings > Automatic redial).
- 2 Scroll to **On**, then press **Select**.

If the number you dial is busy, your phone immediately redials the number. If it is still busy, your phone will redial the number up to nine more times.



Note: Automatic redial will not work while you make or answer another call.

• USE 1-TOUCH DIALING

Assign a name and number to a 1-touch dialing location so that when you press this key, the phone automatically dials the associated number.

Key 1 is used to access your voice mail. See "Listen to your voice messages" on page 60 for details on voice mail.

Assign a number to a 1-touch dialing key

- 1 Press Names, scroll to 1-touch dialing, then press Select.
- 2 Scroll to a dialing location, then press Assign.
- 3 Enter a phone number, press OK. Enter a name, press OK.

OR

Press Find. Scroll to the phone book entry you want, then press Select twice.

Activate 1-touch dialing

- 1 Press Menu 4-3-2 (Settings > Call settings > 1-touch dialing).
- 2 Scroll to On, then press Select.

Call a 1-touch dial number

From the Start screen, press and hold the appropriate key, or press the key, then press the Talk key.

The phone dials the number.

Change 1-touch dialing numbers

- 1 Press Names.
- 2 Scroll to 1-touch dialing and press Select.
- 3 Scroll to the key that you want to change and press Options.
- 4 Scroll to Change and press Select.
- 5 Enter a phone number, then press OK.
- 6 Enter a name, then press OK.

Delete 1-touch dialing numbers

- 1 Press Names, scroll to 1-touch dialing and press Select.
- 2 Scroll to a key that you want to erase and press Options.
- 3 Scroll to Delete and press Select.
- 4 Press OK to confirm.

• USE ANYKEY ANSWER

This feature allows you to press any key to answer an incoming call.



Note: Anykey answer does *not* work with the power button, the End key, or the left and right selection keys.

Turn on Anykey answer

- 1 Press Menu 4-3-4 (Settings > Call settings > Anykey answer).
- 2 Scroll to On and press Select.

Turn off Anykey answer

- 1 Press Menu 4-3-4 (Settings > Call settings > Anykey answer).
- 2 Scroll to Off and press Select.

• USE NETWORK SERVICES

Network services include call forwarding, call waiting, caller ID, multiple lines for outgoing calls, and system selection. For availability, pricing, and subscription to network services, contact your service provider.

Choose an outgoing line



Tip: Your service provider must have this feature activated before you can select line 2.

- 1 Press Menu 4-6-6 (Settings > Network services > Confirm SIM service actions).
- 2 Scroll to Line 1 or Line 2, then press Select.

Send your own number in caller ID

You can determine, for each call you make, whether your telephone number appears on another's phone caller ID.

In most service areas, when you call others, your name is presented to their caller ID (if they subscribe to this service). With **Send own caller ID when calling**, you can block or send the display of your number when you make a call.



Note: This feature may not be available in all wireless systems. Contact your service provider for details and availability. Also note that this feature is effective only when you call a number that is equipped with caller ID.

- 1 Press Menu 4-6-3 (Settings > Network services > Send own caller ID when calling).
- 2 Scroll to one of the following options, then press Select:
 - Default: your phone number is sent according to the network.
 - Yes: your phone number is sent to the other person's caller ID.
 - No: your phone number is not sent to the other person's caller ID.

Forward your calls

This network service lets you forward your incoming calls to another phone number. Contact your service provider to sign up for call forwarding.



Note: Call forwarding options may vary, depending on the SIM card configuration. Contact your service provider for details. If you subscribe to a second phone line, call forwarding works separately for each line. Make sure you have selected the line you want before you set up any call forwarding.





ACTIVATE CALL FORWARDING

- 1 Press Menu 4-6-1 (Settings > Network services > Call forwarding).
- 2 Scroll to one of the call forwarding options, then press Select:
 -  **Tip:** If you want to forward your calls to another number when your phone is turned off, select Forward when not able to take calls.

- Forward all voice calls
- Forward if busy
- Forward if not answered
- Forward if out of reach
- Forward when not able to take calls
- Cancel all call forwarding

- 3 Scroll to Activate, then press Select.
- 4 Scroll to either To voice mailb. or To other no. If you choose To other no., enter the phone number, then press OK.

The following icons appear on your phone's screen:

-  Incoming voice calls are being forwarded to another number.
-  You have forwarded all voice calls that are received on line 1.
-  You have forwarded all voice calls that are received on line 2.
-  You have forwarded all voice calls that are received on lines 1 and 2.

CANCEL CALL FORWARDING

- 1 Press Menu 4-6-1 (Settings > Network services > Call forwarding).
- 2 Scroll to the call forwarding option you want , then press Select.
- 3 Scroll to Cancel, then press Select.



Note: Canceling all call forwarding may also cancel any automatic forwarding of calls to voice mail that your service provider has activated for you. Also, this option may cancel your call forwarding service. Contact your service provider for details.

CHECK CALL FORWARDING STATUS

- 1 Press Menu 4-6-1 (Settings > Network services > Call forwarding).
- 2 Scroll to the call forwarding option you want to check, press Select.
- 3 Scroll to Check status, then press Select.



Note: Status is not available for Forward when not able to take calls.

To see the phone number where the calls are being forwarded, press Number.

Select a system

You can select how your phone chooses a wireless network, as there may be more than one available. The selection you make stays active until you change it or change the SIM card.

- 1 Press Menu 4-6-5 (Settings > Network services > System selection).
- 2 Scroll to Automatic or Manual, then press Select.

Automatic: The phone automatically selects one of the available systems.

Manual: The phone searches for available systems and then lists them. Scroll to the one you want, then press Select. The phone looks for a network and displays the result. If you lose connection while in Manual mode, the phone asks you to select a network again.

Use call waiting

This network service lets you receive an incoming call when you are already in a call. The phone beeps to let you know of the incoming call. Contact your service provider to sign up for call waiting.

ACTIVATE/CANCEL CALL WAITING

- 1 Press Menu 4-6-2 (Settings > Network services > Call waiting).
- 2 Scroll to Activate or Cancel, then press Select.

CONFIRM CALL WAITING STATUS

- 1 Press Menu 4-6-2 (Settings > Network services > Call waiting).
- 2 Scroll to Check status and press Select.

ANSWER A WAITING CALL

- 1 Your phone signals when you have a call waiting.
- 2 Press the Talk key to put the current call on hold and answer the waiting call
OR
Press Answer.



REJECT A WAITING CALL

You can just let the phone ring or perform the following steps.

- 1 Press Options and scroll to Decline call.
- 2 Press Select.

SWITCH BETWEEN CALLS

Press the Talk key or Swap.

The  icon represents the active call and the  icon represents the call on hold.

END THE ACTIVE CALL

Press the End key.

The call on hold becomes active.

OR

Press Options, scroll to End call, then press Select.

THIRD CALL WAITING

If you have both an active and a call on hold and a third call is waiting, you can answer the third call and end the other calls.

- 1 Press Options.
- 2 Scroll to End all calls, then press Select.
- 3 Press the Talk key to answer the third call.

Make a conference call

This network service, if available from your service provider, allows you to make conference calls with your phone. Check with your service provider for availability and details for use.

- 1 Place a call to the first person.
- 2 Press **Options** and scroll to **New call**.
- 3 Press **Select**, enter the number of the next party you want to include, then press **Call**.
- 4 After the other party answers, press **Options**.
- 5 Scroll to **Conference**, then press **Select**.
- 6 To add other parties to the call, repeat steps 2 through 5.
- 7 To end the conference call, press the **End** key.

TALK PRIVATELY WITH A PARTICIPANT

- 1 While in a conference call, press **Options**.
- 2 Scroll to **Private call**, then press **Select**.
A list of the participants appears.
- 3 Scroll to the person you want to speak with, then press **OK**.
The other participants can continue talking with each other.
- 4 To rejoin the conference call, press **Options**.
- 5 Scroll to **Conference**, then press **Select**.

DROP A PARTICIPANT FROM THE CONFERENCE CALL

- 1 While in a conference call, press **Options**.
- 2 Scroll to **Private call**, then press **Select**.
A list of the participants appears.
- 3 Scroll to the person you want to drop, then press **OK**.
The other participants can continue talking with each other.
- 4 Press **Options**.
- 5 Scroll to **End call**, then press **Select**.

Transfer a call

When you have one active and one call on hold, you can connect the two calls and disconnect yourself from the call.



Note: Your network must support this feature. Contact your service provider for availability.

During a call, press **Options**, scroll to **Transfer calls**, then press **Select**.

Use Memory Status

You can find out the current memory consumption of your phone by using this feature. Memory information is gathered from the following functions:

- Phone book,
- SMS messages
- MMS messages
- Gallery

You can also check the phone book's memory status while you are in the phone book function. See "Check phone book memory status" on page 43

- 1 Press **Menu 4-4-7** (**Settings > Phone settings > Memory status**).
The phone displays the total size of both free and used memory.
- 2 Press **Back**.

11 Use voice features

The voice features in your phone make communication more convenient. You can check messages from friends or business associates, record a voice tag for contacts in the phone book, and use voice dialing for handsfree operation.

• ABOUT VOICE MAIL

Voice mail is a network feature that allows callers to leave a voice message for you when you are not able to take the call. To use voice mail, you must have:

- A voice mail subscription
- A voice mailbox number
- A temporary password

These items are assigned by your service provider. Your service provider should also tell you how to record a greeting for your voice mailbox and how to change the temporary password.



Note: If you have difficulty using the voice mail feature, contact your service provider.

Save the voice mailbox number

If your service provider has not already set up the voice mailbox number, follow these steps to set up the voice mailbox number.

- 1 Press **Menu**, then press **Select**.
- 2 Scroll to **Voice messages**, then press **Select**.
- 3 Scroll to **Voice mailbox number**, then press **Select**.
- 4 Enter your voice mailbox number, then press **OK**.

The voice mailbox number must be longer than 2 characters and emergency numbers, such as 911, are not allowed.

DRAFT

Work with two phone lines

If your particular SIM card supports it, your phone can have two phone lines. Your service provider can tell you if your SIM card allows the use of this feature and can give you access to two phone lines.

If you decide to use two phone lines, you can select one of the two lines for outgoing calls, but you can still answer calls on both lines.

If you use two phone lines, you will be given a voice mailbox number for each line. You need to save the voice mailbox number for each phone line separately.

To do this, first select the outgoing line and save its voice mailbox number. Then, select the other line and save its number.

Voice mail indicators

When you receive a voice message, your phone beeps and either displays an icon on the screen  or shows a text message. The method of notification depends upon your carrier.

If you subscribe to two different phone numbers, the message icon shows which line is receiving the voice mail message

 Voice mail message on line 1.

 Voice mail message on line 2.

 Voice mail message on line 1 and on line 2.

Listen to your voice messages

If there is a notification message on your screen, you can get your voice messages using one of the following methods:

- If you have saved your voice mailbox number in your phone, press and hold 1 to call your voice mailbox.
- Call your voice mailbox number as you would any other telephone number, then follow the directions provided.

To check your voice messages anytime, press Menu 01-4-1 (Messages > Voice messages > Listen to voice messages).

• USE VOICE DIALING

The phone voice dialing feature allows handsfree operation while you place a call. Before using this feature, you need to create entries in the phone book so you can associate a voice tag with a name and number. You can create up to 14 voice tags in your phone. To create entries in the phone book, see page 39.

Using voice tags

Before using voice dialing, note that:

- Voice tags are not language dependent. They are dependent on the speaker's voice.
- Voice tags are sensitive to background noise. Record them and make calls in a quiet environment.
- When recording a voice tag or making a call by speaking a voice tag, hold the phone in the normal position near to your ear.
- Very short names are not accepted. Use long names and avoid similar names for different numbers.
- You cannot use the voice tag or voice dialing feature if you are actively sending or receiving data using a GPRS connection.



Note: You must say the name exactly as you said it when you recorded it. This may be difficult in, for example, a noisy environment or during an emergency, so you should not rely solely upon voice dialing in all circumstances.

Add a voice tag to a phone book entry

- 1 At the **Start** screen, scroll to the name to which you want to assign a voice tag.
- 2 Press **Details**, then **Options**, and scroll to **Add voice tag**. Press **Select**.
- 3 Press **Start**. Speak the name clearly into the microphone.



Important: Do *not* press **Quit** unless you want to cancel the recording. The phone automatically stops recording, then replays and saves the voice tag.

Make a call using voice recognition

- 1 At the **Start** screen, press and hold **Names**. When you hear several beeps and **Please speak now** appears, release the button.
- 2 Pronounce the voice tag clearly into the microphone.
Your phone automatically dials the number.

Listen to a voice tag

- 1 Press **Names**, scroll to **Voice tags**, then press **Select**.
- 2 Scroll to the name with the voice tag you want to hear.
- 3 Press **Options**, scroll to **Playback**, and press **Select**.

Change a voice tag

- 1 Press **Names**, scroll to **Voice tags**, then press **Select**.
- 2 Scroll to the name with the voice tag you want to change.
- 3 Press **Options**, scroll to **Change**, and press **Select**.
- 4 Press **Start**, then speak the new name.

The phone repeats and saves your new voice tag.

Delete a voice tag

- 1 Press **Names**, scroll to **Voice tags**, then press **Select**.
- 2 Scroll to the name with the voice tag you want to erase.
- 3 Press **Options**, scroll to **Delete** and press **Select**.
- 4 Press **OK** to erase the voice tag.

• USE VOICE COMMANDS

The voice command feature allows access to handsfree operation for certain phone functions. Voice commands work similar to voice dialing. Before using voice commands, you must first associate a voice tag to the phone function you want to use.

Add a voice tag for a command

- 1 Press **Menu 9-3 (Extras > Voice commands)**.
Audible alerts appears.
- 2 Press **Select** and scroll to the following function you want to tag:
Audible signal bar
Audible battery bar
- 3 Press **Options**, then select **Add command**.
- 4 Press **Start**, then speak the voice tag clearly into the microphone.



Note: A message will appear if the voice command is either too short or long. You are given the option to try again.



Caution: Do not press **Quit** unless you want to cancel the recording.

The phone replays and then saves the recorded tag. The  icon appears next to commands which have voice tags assigned.

Work with an existing voice command tag

After you have associated a voice tag to a command, you can either play back, change or delete the tag.

PLAY BACK VOICE COMMAND TAGS

- 1 Press **Menu 9-3 (Extras > Voice commands)**.
Audible alerts appears.
- 2 Press **Select** and scroll to the voice command tag you want to play back.
- 3 Press **Options**, then select **Playback**.

CHANGE VOICE COMMAND TAGS

- 1 Press **Menu 9-3 (Extras > Voice commands)**.
Audible alerts appears.
- 2 Press **Select** and scroll to the voice command tag you want to delete.
- 3 Press **Options**, then select **Change**.
- 4 Press **Start**, then speak the voice tag clearly into the microphone.
Voice command changed appears.

DELETE VOICE COMMAND TAGS

- 1 Press **Menu 9-3 (Extras > Voice commands)**.
Audible alerts appears.
- 2 Press **Select** and scroll to the voice command tag you want to delete.
- 3 Press **Options**, then select **Delete**.
Delete voice command? appears.
- 4 Press **OK**.
Voice command deleted appears.

• AUDIBLE ALERTS

Audible alerts provide you with the current signal bar or battery bar strength of your phone. In order to obtain audible alerts, the alerts must first be set up as voice commands. To set up voice commands, see "Add a voice tag for a command" on page 62.

Set up audible alerts

- 1 Press and hold **Names**.
Please speak now appears.
- 2 Pronounce the voice tag clearly into the microphone.

When the phone finds the tag, confirmation appears and the phone plays the recognized voice tag from the phone memory through the earpiece. The phone then beeps.

Audible Alert	One Beep	Two Beeps	Three Beeps	Four Beeps
Battery Bar Strength	Low	Half full	Almost full	Full
Signal Bar Strength	Weak	Somewhat strong	Almost strong	Strong

12 Personalize your phone

• PROFILES

Profiles let you select the sound settings that match your environment, whether it is a meeting or a soccer game. Each profile contains settings for the ringing option, ringing tone, ringing volume, vibrating alert, message alert tone, keypad tones, and warning tones. Just pick the profile that suits your current environment: Normal, Silent, Outdoor, or Loud.

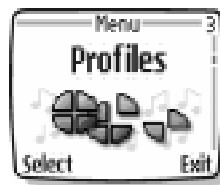

Your phone also has profile settings for Nokia accessories such as a headset, car kit, loopset, and TTY adapter.



Note: The accessory profiles do not appear until you attach these accessories for the first time.

Select a profile

- 1 Press Menu 3 (Profiles).
- 2 Scroll to the profile you want to use, then press Select.
- 3 Scroll to Select, then press Select.

Customize a profile

- 1 Press Menu 3 (Profiles).
- 2 Scroll to the profile you want to customize, then press Select.
- 3 Scroll to Customize, then press Select.
- 4 Use the scroll keys to display each of the options listed in the following table. Once you find the option you want to customize, press Select.

Option	What it does
Ringing options	Allows you to choose a ringing style. Your choices include Silent, Ring, Ascending, Ring once, and Beep once.
Ringing tone	Allows you to choose from 35 preprogrammed tones.

Option	What it does
Ring volume	Allows you to set the volume for incoming calls.
Vibrating alert	Allows you to turn the vibrating alert on or off. Note: your phone has an internal vibrating mechanism so you do not need a special battery to use this feature. In some profiles, the vibrating alert default is Off, so the lights may not flash unless you change the default.
Message alert tone	Allows you to choose an alert style. Your choices include No tone, Standard, Special, Beep once, Ascending, and Ringing Tone.
Keypad tones	Allows you to set the volume for keypad tones.
Warning tones	Allows you to turn warning and confirmation tones on or off.
Alert for	You can choose to have your phone sound an audible alert only when a member of a selected caller group is calling. For more information about Caller groups, see "Use caller groups" on page 76.
Tone Downloads	Allows you download ringing tones over the Internet. See "Download ringing tones" on page 71 for more information.
Profile name	Allows you to give a new name to the following profiles: Silent, Quiet, or Loud.

Set a timed profile

Timed profiles can prevent missed calls. For example, if you attend an event that requires you to set your phone to the **Silent** profile, you may forget to return the phone to the **Normal** profile after the event is over. You may not notice incoming calls. With the timed profile, you can have the phone automatically return to the **Normal** profile at a time you specify.

- 1 Press **Menu 3 (Profiles)**.
- 2 Scroll to the profile you wish to activate, then press **Select**.
- 3 Scroll to **Timed**, then press **Select**.
- 4 Enter the time for the profile to expire and press **OK**.
- 5 If you are using a 12-hour time format, scroll to **am** or **pm**, then press **Select**.

The profile you have set for expiration becomes active and appears in the **Start** screen along with a small clock icon.

• ACCESSORY SETTINGS

You can use your phone with these Nokia accessories:

- Headset (HDC-5, HDE-2, HDB-5, or HDC-10)
- Car kit (CARK125 or CARK 134)
- Loopset (LPS-3)
- TTY adapter (HDA-9)

The accessory settings do not appear in the phone menu until you connect the headset, car kit, loopset, or TTY/TDD adapter.

You can adjust settings related to the accessory, such as ring tone.

Set the default profile

When you use the headset, car kit, or loopset, you have the option of choosing a profile. You can use the currently selected profile (for example, **Normal**) or you can choose from the list.

- 1 Press **Menu 4-7 (Settings > Accessory settings)**.
- 2 Scroll to **Headset**, **Handsfree**, or **Loopset**, then press **Select**.
- 3 Scroll to **Default profile**, then press **Select**.
- 4 Scroll to the profile you want, then press **Select**.

Set up the car profile

You can connect your phone to an approved Nokia car kit for convenient handsfree operation. For descriptions and illustrations, see "Express Car Kit (CARK 125)" on page 151 and "Full Car Kit (CARK 134)" on page 152.

The car kit contains a microphone and a speaker, so you can conduct a conversation without holding the phone to your ear. The setting used with the car kit is called Handsfree.

SET UP AUTOMATIC ANSWER

This profile lets your phone answer incoming calls after just one ring.

- 1 Place the phone into the car kit holder. When the phone recognizes the accessory, the car kit icon  appears.
- 2 Press Menu 4-7-2 (Settings > Accessory settings > Handsfree).
- 3 Scroll to Automatic answer, then press Select.
- 4 Scroll to On, then press Select.

SET UP LIGHTS

If you are using your phone with an approved Nokia car kit, you can set lights to On (display and keypad lights stay on) or Automatic (after 15 seconds, lights turn off until the next key is pressed or the phone rings).

- 1 Place the phone into the car kit holder.
When the phone recognizes the accessory, the car kit icon  appears.
- 2 Press Menu 4-7-2 (Settings > Accessory settings > Handsfree).
- 3 Scroll to Lights, then press Select.
- 4 Scroll to On or Automatic, then press Select.



Note: Connecting your phone to a car kit automatically disables Keyguard.

Set up the loopset profile

The LPS-3 loopset gives people with T-coil equipped hearing aids the ability to make and receive calls without noise interference.

 **Important:** Refer to the booklet that comes with the LPS-3 for complete instructions and safety information.

- 1 Plug the loopset plug into the bottom of your phone, as shown in the illustration.
- 2 Press Menu 4-7-3 (Settings > Accessory settings > Loopset).
- 3 Scroll to Use loopset, then press Select.
- 4 Scroll to Yes, then press Select.

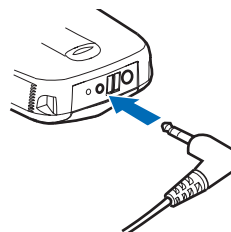

 **Note:** If you want to use the headset or TTY, you perform steps 2-3, then select **No** to deactivate the loopset profile.

Set up the TTY/TDD profile

You can connect your phone to a TTY/TDD using the Nokia TTY/TDD Adapter (HDA-9). In order for your phone to recognize the TTY/TDD, you'll need to set up the TTY/TDD profile, under Accessory settings.

 **Important:** Some manufacturers of TTY/TDD devices suggest that the phone be least 18 inches from the TTY/TDD device. Remember that when connecting to any other device, read its user guide or contact its manufacturer for detailed instructions and safety information.

- 1 First, connect the TTY/TDD by a cable to the HDA-9 adapter. Next, plug the HDA-9 adapter into the connector on the bottom of your phone, as shown in the illustration.

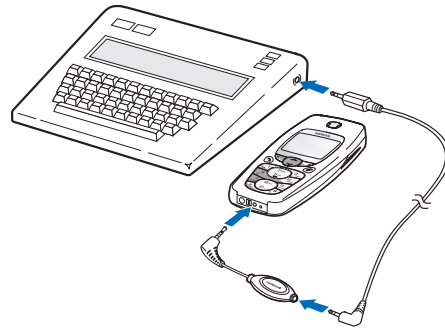

- 2 Press Menu 4-7-4 (Settings > Accessory settings > TTY/TDD > Use TTY), then press Select.
- 3 Scroll to Yes, then press Select.

NOTES ABOUT TTY/TDD CALLS

- The Nokia TTY/TDD Adapter (HDA-9) is for use with compatible TTY/TDD devices only. Check with the manufacturer of the TTY/TDD device to ensure that the connection is compatible.
- Check with the manufacturer of the TTY/TDD device for the connecting cable.
- TTY/TDD communications depend on network availability. Check with your service provider for availability and description of services.

MAKE A TTY/TDD CALL



Tip: Before making a TTY/TDD call with your Nokia phone, check the signal strength. See page 23 for more details.

- 1 From the Start screen, enter the number and press the Talk key.
- 2 When the receiving party answers, begin typing your conversation on the TTY/TDD.

RECEIVE A TTY/TDD CALL



Tip: You may find it helpful to use the vibrating alert under the Profiles menu. See "Customize a profile" on page 65 for details.

- 1 Make sure the TTY/TDD device is connected to your phone.
- 2 Press the Talk key to answer the call, then type your responses on the TTY/TDD.

END A TTY/TDD CALL

Press the End key.

• POLYPHONIC SOUND (MIDI)

Your phone is equipped with a polyphonic tone generator capable of playing up to four different voices simultaneously. The generator can reproduce over 40 different instrument tones, including drums, guitar, saxophone, flute, etc. The polyphonic sounds bring a new richness and quality to ringing tones, message alert tones, background music, and sound effects used in gaming.

Your Nokia 3595 phone supports Mobile MIDI (GMX) format messages and ringing tones. Your phone can receive polyphonic ringing tones in two ways:

- Through the multimedia message service (MMS). See "Receive multimedia messages (MMS)" on page 102 for more information.
- Through the WAP browser. See "Sign on to the mobile Internet" on page 109 for more information.

• DOWNLOAD RINGING TONES

You can download ringing tones over the Internet or have them sent to your phone via SMS (short message service) or MMS. MIDI ring tones can be downloaded via MMS or WAP. Traditional ringing tones can be downloaded via SMS, WAP, and MMS.

Your phone has memory space for several traditional ringing tones or MIDI ringing tones. The number of tones you can save depends on the size of each tone. MIDI tones take up more storage space in the memory than traditional ringing tones.



Note: Methods for downloading ringing tones vary. Some wireless providers allow you to send ringing tones to your phone via the Internet, but may charge for this service. For details about downloading ringing tones, contact your wireless service provider.

Notification of received ringing tone

When your phone receives a ringing tone, it displays Ringing tone received.

Listen to received ringing tones



Caution: If you press Exit at any time before saving the ringing tone, the ringing tone will be deleted.

- 1 When your phone displays Ringing tone received, press Options.
- 2 Scroll to Playback, then press Select.

Save received ringing tones

- 1 Press Options.
- 2 Scroll to Save tone, then press Select.
The tone is saved to your list of ringing tones.
If the memory is full, the phone prompts you to replace an existing tone. Replace tone? appears. Press Select.

Discard received ringing tones

If you don't want to save the ringing tone, press Exit, then press OK to confirm.
OR
Press Options, scroll to Discard, then press Select. Confirm with OK.

• CHOOSE THE DISPLAY LANGUAGE

You can choose the phone display language.

- 1 Press Menu 4-4-1 (Settings > Phone settings > Language).
- 2 Scroll to the language you want, then press Select.



• ADD A WELCOME NOTE

You can add a welcome note that is displayed briefly each time you turn on the phone.

- 1 Press Menu 4-4-4 (Settings > Phone settings > Welcome note).
- 2 Enter a note, then press Options.
- 3 Scroll to Save, then press Select.

Delete a welcome note

- 1 Press Menu 4-4-4 (Settings > Phone settings > Welcome note).
- 2 Press Options.
- 3 Scroll to Delete, then press Select.

• ACTIVATE HELP TEXT

Many menu items have brief explanations associated with them. To view the help text, scroll to the menu item and wait for about 30 seconds. Press More to see the next page of the text or Back to exit.

- 1 Press Menu 4-4-5 (Settings > Phone settings > Help text activation).
- 2 Scroll to On, then press Select.

To turn off help texts, scroll to Off, then press Select.

• SET UP THE TIME AND DATE

Your phone has an internal clock that can be displayed on the Start screen. It also features an alarm clock (see "Use the alarm clock" on page 119).



Note: The time and date has to be reset each time the phone's battery is taken out and replaced.

Select the time format

- 1 Press Menu 4-2-1-3 (Settings > Time and date settings > Clock > Time format).
- 2 Scroll to 24-hour or am/pm.
- 3 Press Select.

Set the time

- 1 Press Menu 4-2-1 (Settings > Time and date settings > Clock).
- 2 Scroll to Set the time, then press Select.
- 3 Enter the current time, using two digits for both hours and minutes.
- 4 Press OK, then select am or pm and press Select.



Note: If you entered the time in the 24-hour format, am and pm do not appear.

If this is the first time you have set the clock, the phone asks you to enter the date. Enter the date in *mm:dd:yyyy* format and press OK.

Set the date format

- 1 Press Menu 4-2-2 (Settings > Time and date settings > Date).
- 2 Scroll to Date format, then press Select
- 3 Choose one of the following formats, then press Select.
 - DD MM YYYY
 - MM DD YYYY
 - YYYY MM DD

Set the date

- 1 Press Menu 4-2-2 (Settings > Time and date settings > Date).
- 1 Scroll to Set the date, then press Select.
- 2 Enter the date in *mm:dd:yyyy* format, then press OK.

Display the clock

This feature lets you continuously display the time on the Start screen.

- 1 Press Menu 4-2-1 (Settings > Time and date settings > Clock).
- 2 Scroll to Hide clock or Show clock.
 - Only one choice appears, depending on the current setting.
- 3 Press Select.

Set automatic update of date and time

If this feature is supported by your wireless service provider, it automatically updates the clock in your phone in accordance with the current time zone. This may be helpful if you are traveling from New York to California, for example, and want to receive the local time from the wireless network.

- 1 Press Menu 4-2-3 (Settings > Time and date settings > Auto-update of date & time).
- 2 Scroll to one of the following options, then press Select:
 - On: Updates the date and time automatically.
 - Confirm first: Requires you to confirm that you want the update.
 - Off: Prevents the date and time from being automatically updated.

• DISPLAY SETTINGS

Wallpaper

You can set your phone to display a background picture (wallpaper) on the Start screen. Some pictures are pre-saved in the Gallery menu. You can download pictures via SMS, WAP, and MMS and then save them in the Gallery. Your phone supports JPEG, GIF, BMP, PNG, and WBMP formats.

SELECT WALLPAPER

- 1 Press Menu 4-5-1 (Settings > Display settings > Wallpaper).
- 2 Scroll to Change image, then press Select to browse the gallery.
- 3 Select Graphics, press Open and scroll to the image you want.
- 4 Press Select, then press Set as wallpaper.
Replace existing wallpaper? appears on the screen.
- 5 Press OK.

A confirmation note appears on the screen.



Note: If the wallpaper feature is off when an image is set as a wallpaper, it is switched to be On. You do not need to activate the wallpaper separately.

ACTIVATE/DEACTIVATE WALLPAPER

- 1 Press Menu 4-5-1 (Settings > Display settings > Wallpaper).
- 2 Scroll to On or Off and press Select.

Color schemes

You can change the color of some display components in your phone, such as indicators and signal bars.

- 1 At the Start screen, press Menu 4-5-2 (Settings > Display settings > Color schemes).
- 2 Scroll to the color scheme you want and press Select.
A confirmation note appears on the screen.

Screen saver

You can set your phone to display a screen saver after a preset time or after a custom time (up to 60 minutes). The screen saver is activated when no function of the phone is used after a preset period of time. Press any key to deactivate the screen saver. The screen saver is also deactivated when the phone is out of the network coverage area.

SCREEN SAVER TIMEOUT

- 1 At the Start screen, press Menu 4-5-4 (Settings > Display settings > Screen saver timeout).
- 2 Scroll to either 2 minutes or 5 minutes and press Select.
- 3 If you want to set a custom time (up to 60 minutes), scroll to Other and press Select.
- 4 Enter the custom time and press OK.
A confirmation note appears on the screen.

Display brightness

You can change the brightness of the phone display.

- 1 Press Menu 4-5-5 (Settings > Display settings > Display brightness).
A bar chart indicating the current brightness level appears on the screen.
- 2 Use the Scroll up or Scroll down key to adjust the contrast level to your preference.
- 3 Press OK to accept your settings.

• USE CALLER GROUPS

You can create groups of names in your phone book and give each group a different ringing tone. When someone from that group calls, you'll know because of the ringing tone.

Add names to a caller group

The name you add to a caller group must first be stored in the phone book.

- 1 From the Start screen, scroll to the name or number you want.
- 2 Press Details, then press Options.
- 3 Scroll to Caller groups and press Select.
- 4 Choose Family, VIP, Friends, Business or Other, then press Select.

Remove names from a caller group

- 1 Follow steps 1 through 3 above.
- 2 Scroll to **No group** and press **Select**.

Assign a ringing tone to a caller group

- 1 From the Start screen, press Names.
- 2 Scroll to Caller groups and press Select.
- 3 Scroll to the group you want and press Select.
- 4 Scroll to Group ringing tone and press Select.
- 5 Scroll to the tone you want to hear for this caller group and press Select.



Tip: You can set your phone to ring *only* when people from certain caller groups call you, and to be silent for all other call groups.

Rename a caller group

You can rename any call group with a name of your own.

- 1 Follow steps 1 through 3 above.
- 2 Scroll to Rename group and press Select.
- 3 Enter the group name, then press OK.

Assign group graphic

Each caller group has a picture associated with it. When you get a call from someone in a caller group, the graphic flashes on the screen.

To turn the graphic on for a caller group:

- 1 Press Names, scroll to Caller groups, and press Select.
- 2 Scroll to the name of the group and press Select.
- 3 Scroll to Group logo and press Select.



Note: To see the group graphic before you select it, scroll to View and press Select. Press Back to return to the menu.

- 4 Scroll to On and press Select.

To turn the graphic off, follow the steps above, but scroll to Off in the last step.

VIEW A RECEIVED GRAPHIC

- 1 When you receive a graphic from someone else, **Group logo received** appears.
- 2 To view the graphic, press **Show**.
- 3 After viewing the graphic, press **Options** and then choose:
Save to save it (you must choose which caller group gets the new graphic)
Discard to delete it
- 4 Press **Select**.

• RESTORE FACTORY SETTINGS

You can use **Menu 4 8 (Settings > Restore factory settings)** to reset some of the phone settings to their original values.



Caution: Restoring factory settings does not erase your phone book. However, it does erase all customized settings you may have entered.

- 1 Press **Menu 4-8 (Settings > Restore factory settings)**.
- 2 Enter the Security code, then press **OK**.
For the default code, see "Security code" on page 86.

• CHANGE XPRESS-ON™ COLOR COVERS

To personalize your Nokia 3595 phone, you can change the front and back covers. Nokia Xpress-on™ color covers, reactive covers (glow-in-the-dark), active covers, and gaming covers may be purchased from your authorized Nokia dealer.

 **Important:** Before changing the cover, always switch off the power and disconnect the phone from the charger or any other device. Always store the phone with the covers attached. When changing covers, remove the back cover first, then the front cover. When replacing covers, place the front cover on first, then the back cover.

Remove the back cover

- 1 With the back of the phone facing you, press and hold the back cover release button.
- 2 Slide the cover up.
- 3 Lift the cover off of the phone.

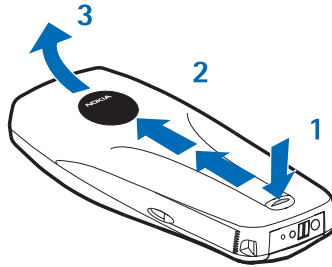

Remove the phone from the front cover

With the back of the phone facing you, gently separate the cover from the phone, starting at the bottom.

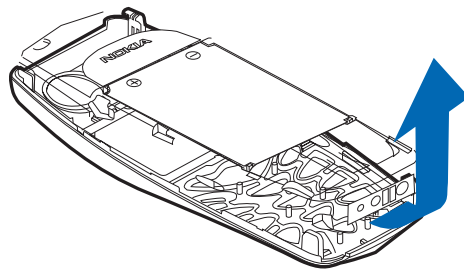

Change the keypad

- 1 Lift the keypad from inside the old front cover.
- 2 Place the keypad into the new front cover.

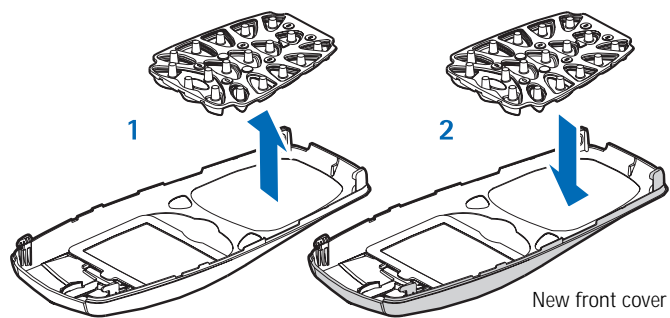

Replace the new front cover

- 1 To replace the front cover, align the top of the phone with the top of the front cover. Make sure both sets of plastic tabs line up with their slots, as shown at right.
- 2 Align the cover and snap it shut all the way around the edge of the phone.

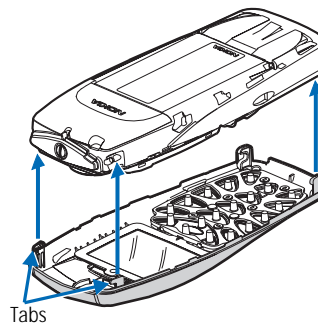

Replace the back cover

- 1 Direct the back cover towards the locking catches on the phone.
- 2 Slide the back cover until it locks into place.

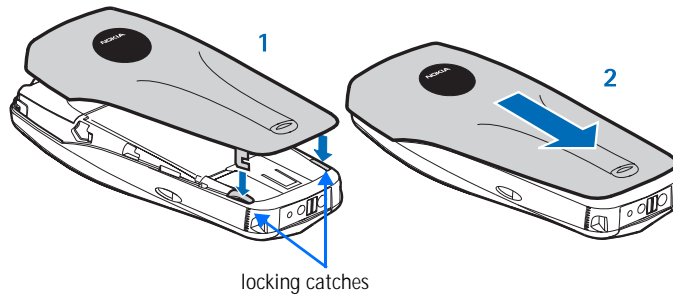

13 Manage phone security

Your phone is equipped with different security features that allow you to do the following:

- Avoid making accidental calls,
- Prevent unauthorized use of your phone, and
- Restrict outgoing or incoming calls.

• LOCK THE KEYPAD (KEYGUARD)

Keyguard disables your keypad to prevent accidental key presses (for example, when your phone is in your pocket or purse).

- To lock the keys, press **Menu**, then *****.
- To unlock the keys, press **Unlock**, then *****.

Automatic Keyguard

You can have your phone automatically lock the keys after a time you specify.

- 1 Press **Menu** 4-4-2 (Settings > Phone settings > Automatic keyguard).
- 2 Scroll to **On**, then press **Select**.
- 3 Set the delay time, then press **OK**.



Note: When Keyguard is on, calls may be possible to emergency numbers (for example, 911 or other official emergency number). Key in the emergency number and press the **Talk** key. The number is displayed only after you have keyed in its last digit. Keyguard does not prevent unauthorized use of your phone.

3595 Phone
Graphic
Goes
Here



• ABOUT SECURITY CODES

The following table summarizes how different types of security codes are used in your phone.

Code	Purpose
Security code	<p>Use the security code for the following procedures:</p> <ul style="list-style-type: none"> • Reset call timers (page 47) • Clear the data counter (page 49) • Clear the connection timer (page 49) • Restore factory settings (page 79) • Erase your entire phone book (page 44) <p>If phone security is on, the phone requests the security code the first time you use it after installing a new SIM card.</p>
PIN code	<p>You can use the PIN code to protect against unauthorized calls if the following conditions are met:</p> <ul style="list-style-type: none"> • The PIN code request is turned on • The phone is powered off <p>The next time the phone is turned on, you must enter the correct PIN code to make calls or use the menus.</p>
PIN2 code	<p>Enter the PIN2 code for the following procedure:</p> <p>Use fixed dialing (page 86)</p>
Restriction password	Required by the restrict calls feature.

• PIN CODES

The PIN (Personal Identity Number) and PIN2 codes are 4- to 8-digit numbers that usually come from your service provider along with the SIM card. Use the PIN code to protect your phone and SIM card against unauthorized use. The PIN2 code activates some of your phone's functions, such as Call cost limit. See "Manage call costs" on page 48.

When the phone requires the PIN or PIN2 code, it displays Enter PIN code: or Enter PIN2 code:.

Enter the code, then press OK.

Set PIN code request

You can activate the PIN code request to prevent unauthorized use of your phone. If you set the PIN code request to **On**, your phone will ask for the code each time you turn the phone on.



Note: When the phone is locked, calls may be possible to the emergency number programmed into your phone (for example, 911 or other official emergency number).

- 1 Press Menu 4-7-1 (Settings > Security settings> PIN code request).
- 2 Enter the PIN code supplied by your service provider, and press OK.
- 3 Scroll to **On** and press OK.

To turn off this feature, repeat steps 1 through 3 above, but select **Off** in step 3.

Change your PIN or PIN2 code

You can change your PIN or PIN2 code to any 4- to 8-digit number.



Tip: Activate the PIN code request *first*.

- 1 Press Menu 4-7-6 (Settings > Security settings > Change access codes).
- 2 Scroll to **Change PIN code**, then press **Select**.
- 3 Enter the current PIN code and press OK.
- 4 Enter the new PIN code and press OK.
- 5 Enter the new PIN code again to verify, and press OK.



Note: If you make a mistake while entering the code, **Code Error** appears. Start again at step 2 and be careful to enter the correct code. If you enter the wrong code three times in a row, the PIN code is blocked. To unblock the PIN code, you need a Personal Unblocking Key (PUK) from your service provider.

• PUK CODES

The PUK and PUK2 codes are 4-digit to 8-digit codes that usually come from your service provider along with the SIM card. The PUK code unblocks a blocked PIN code, and the PUK2 code unblocks a blocked PIN2 code.

If you block your phone, contact your service provider. When you enter the PUK code given by your service provider, the phone prompts you to enter and then confirm a new PIN code.

• SECURITY CODE

The default security code is 12345. Nokia recommends that you change the default code immediately.

You need the security code to access certain phone features. When the phone requires the security code, it displays Security code:

Enter the code, then press OK.

If you enter an incorrect security code five times in a row, the phone will not accept the correct code for 5 minutes.

Change the security code

- 1 Press Menu 4-7-6 (Settings > Security settings > Change access codes).
- 2 Scroll to Change security code and press Select.
- 3 Enter the current security code, then press OK.
- 4 Enter the new security code, then press OK.
- 5 Enter the security code again to verify, then press OK.



Important: Keep the code secret and in a safe place, separate from the phone.

• USE FIXED DIALING

If supported by your SIM card, this feature lets you restrict your outgoing calls to phone numbers included in the fixed dialing list or beginning with the same digit(s) as an entry in the list.



Note: When fixed dialing is set on, calls may be possible to certain emergency numbers in some networks (for example, 911 or other official emergency numbers).

Turn fixed dialing on or off

- 1 Press Menu 4-7-3 (Settings > Security settings > Fixed dialing).
- 2 Scroll to On or Off, then press Select.
- 3 Enter your PIN2 code, then press OK.

Add numbers to the fixed dialing list

- 1 Press Menu 4-7-3 (Settings > Security settings > Fixed dialing).
- 2 Scroll to **Number list**, then press **Select**.
- 3 Scroll to **Add**, then press **Select**.
- 4 Enter your PIN2 code and press **OK**.
- 5 Enter a name to go with the restricted phone number, then press **OK**.
- 6 Enter the phone number you want to restrict, then press **OK**.

Repeat steps 3 through 6 for each number you want to add to the list.

• RESTRICT CALLS

This network service, if available from your service provider, lets you restrict the calls your phone can make and receive. Check with your service provider for details.



Note: When calls are restricted, calls may be possible to certain emergency numbers in some networks (such as 911 or other official emergency number).

About the restriction password

Contact your service provider for the restriction password.

Turn on call restrictions

- 1 Press Menu 4-7-2 (Settings > Security settings > Call restrictions).
- 2 Scroll through the types of calls you can restrict, and press **Select** when you see the one you want.

Outgoing calls: Calls cannot be made.

International calls: Calls cannot be made to foreign countries.

International except to home country: When abroad, calls can be made only within the current country and to your home country (that is, the country where your home network operator is located).

Incoming calls: Calls cannot be received.

Incoming calls if roaming: Calls cannot be received outside your home area.

Cancel all call restrictions: Turns off all call restrictions. Calls can be made and received in the usual way.



Note: If you selected **Cancel all call restrictions**, the following steps are not available. Also, you can cancel call restrictions on each option, allowing restrictions on other options to stay in force.

- 3 Scroll to one of the following options, then press Select:
Activate: Enter the restriction password and press OK.
Cancel: Enter the restriction password and press OK.
Check Status: The phone lists the call types with call restriction active.

Change your restriction password

- 1 Press Menu 4-7-6 (Settings > Security settings > Change access codes).
- 2 Scroll to **Change restriction password**, then press Select.
- 3 Enter your current password, then press OK.
- 4 Enter your new password, then press OK.
- 5 Verify the new password, then press OK.

• SET UP A CLOSED USER GROUP

This network service, if available from your service provider, specifies the group of people to whom you can call and who can call you. Default resets the phone to use a user group that the SIM card owner has agreed upon with the service provider.



Note: When calls are limited to Closed User Groups, calls may be possible to certain emergency numbers in some networks (for example, 911 or other official emergency number).

Turn closed user group on/off

- 1 Press Menu 4-7-4 (Settings > Security settings > Closed user group).
- 2 Scroll to **On** or **Off**, then press Select.
- 3 Enter the group number, then press OK.

14 Communicate with mobile messages

You can use mobile messages to keep in touch with friends, family, and business associates. Your Nokia 3595 phone allows you to do the following:

- Send and receive text messages
- Communicate with e-mail
- Communicate online with other phone users
- Receive and view multimedia messages (MMS)
- Send and receive picture messages



Not all messaging features are available in all wireless networks. Contact your service provider for availability and subscription information.



Warning: Do not switch on the phone when wireless phone use is prohibited or when it may cause interference or danger.

• MESSAGE SETTINGS

Before you can send and receive messages you must:

- Have a text messaging subscription through your service provider.
- Contact your service provider for the message center number.
- Save your message center number in your phone.
- Set up other message settings, such as GPRS.

Save your message center number



Note: Your service provider supplies the message center number.

- 1 Press Menu, then press Select.
- 2 Scroll up to Message settings, then press Select.
- 3 Scroll to Text messages, then press Select.
- 4 Scroll to Sending profile, then press Select.
If your SIM supports more than one message profile, choose a profile, then press Select.
- 5 Scroll to Message center number, then press Select.
- 6 Enter your message center number, then press OK.

Set the message mode

You can choose the type of message sent by your phone. The message modes include Text, E-mail, Fax and Page.



Note: This feature appears only if your SIM card supports multiple message types.

- 1 Press **Menu**, then press **Select**.
- 2 Scroll up to **Message settings**, then press **Select**.
- 3 Scroll to **Text messages**, then press **Select**.
- 4 Scroll to **Sending profile**, then press **Select**.
If your SIM supports more than one message profile, choose a profile, then press **Select**.
- 5 Scroll to **Messages sent as**, then press **Select**.
- 6 Scroll to **Text, E-mail, Page, or Fax**, then press **Select**.



Note: In order to receive a converted message, the recipient needs to have the appropriate terminal device, such as a pager or fax machine. E-mail messages can be sent to a mobile phone or personal computer.

Adjust font size

You can modify the font size for message displays. The font size you choose appears in messages when you are reading or editing and in message lists.

- 1 Press **Menu**, then press **Select**.
- 2 Scroll up to **Message settings**, then press **Select**.
- 3 Scroll to **Text messages**, then press **Select**.
- 4 Scroll to **Font size**, then press **Select**.
- 5 Scroll to **Small font** or **Large font**, then press **Select**.

Choose other message settings

You can modify the following message settings, under Messages > Message settings > Text messages > Sending profile. For menu locations, see "List of menu shortcuts" on page 27



Note: The following list is dynamic. The order and number of items may vary, depending on the SIM card. Check with your service provider for more information.

Choice	What it does
Message validity	Allows you to select the length of time that the message center will try to deliver a message. You can choose a time from one hour to one week. If the message center cannot deliver the message within this time, the message is deleted.
Default recipient number	Allows you to specify a single recipient for all your messages. This option is not available when you choose "Messages sent as e-mail."
E-mail server	Allows you to store e-mail server information in your phone so that you do not have to enter the number each time you compose a new e-mail message. This option only shows up if you have set the message mode to E-mail . Contact your service provider for the server number.
Delivery reports	Allows you to ask the network for a report about message delivery.
Use GPRS	Allows you to send your messages via the General Packet Radio System (GPRS).
Reply via same center	Choose this when you want your recipient to reply through the same message center. Note: Do not choose Yes unless you know the recipient has the same service provider.
Rename sending profile	Allows you to name the profile. This option depends on SIM card. Note: This option is not available for the default profile.

• SEND AND RECEIVE TEXT MESSAGES

You can use the text message feature to compose and send a short text message to another phone.



Tip: Review ABC mode and predictive text input from "Enter letters and numbers" on page 34 before reading this section.

Send text messages

- 1 Press Menu 01-1 (Messages > Create message).
- 2 Enter a message.

You can compose one long message made up of several linked parts. Each part can be up to 160 characters. The counter in the upper right corner shows the number of available characters. For example, 100/2 refers to 100 characters available in the second part of the message.

Contact your service provider for information on pricing.

- 3 Once you have finished writing, press Options, scroll to Send, then press Select.
- 4 Enter or recall the recipient's phone number, then press OK.



Note: When sending messages via the SMS network service, your phone may display the words Message Sent. This is an indication that the message has been sent by your phone to the message center number programmed into your phone. This is not an indication that the message has been received at the intended destination. For more details about SMS services, check with your service provider.



Caution: If you need to exit while writing the message, press the End key anytime. Later, press Menu 01-1 to return and finish writing the message. If you turn off the phone without saving the message, the message will be lost.

Send messages to multiple recipients

You can send the same message to more than one recipient.



Tip: Before using this feature, the names of your recipients must be entered into the phone book. See "Save names, numbers and e-mail addresses" on page 39 for instructions.

- 1 From the message screen press **Options**.
- 2 Scroll to **Sending options**, then press **Select**.
- 3 Scroll to **Send to many**, then press **Select**.
- 4 Scroll to the person's name, then press **Send**.



Note: After you press **Send**, your phone may display the words **Message Sent** and then you return to the previous screen. To add other names to the message, repeat step 4 above.

Save messages in the outbox

When you write a text message, it's a good idea to save it in the outbox. Then if there is a message delivery problem, you can easily resend the message.

- 1 While writing the message, press **Options**.
- 2 Scroll to **Save message**, then press **Select**.
- 3 Scroll to **Sent items**, then press **Select**.

Resend a message from the outbox

- 1 Press **Menu**, then press **Select**.
- 2 Scroll to **Sent items**, then press **Select**.
- 3 Scroll to the message you want to resend, then press **Select**.
The message appears on the screen.
- 4 Press **Options** and scroll to **Send**, then press **Select**.
- 5 Scroll to **As text msg.** or **As e-mail**, then press **Select**.
- 6 Enter the number or e-mail address and press **OK** to send the message.

Read a new text message

When you receive a text message, the phone beeps and displays **Message received** and the  indicator in the upper left corner of the screen.

To read the message now, press **Show**.

Read a new text message later

- 1 When you receive a text message, press Exit.
- 2 Later when you want to read the message, press Menu, then press Select.
- 3 Scroll to **Inbox**, then press Select.
A list of message headers is displayed.



Indicates that a text message has been read.



Indicates that a text message has *not* been read.

- 4 Scroll to the message you want, then press Select.
- 5 If the message is long, use the scroll keys to scroll through the message.

Read linked messages

Your phone can receive one long message (up to 459 characters) in sequences. You can start reading the first part before the phone has received the entire message.

While viewing the message, you may see "some text missing" on the display. This is normal, and the message content will be updated as soon as the missing sequence arrives.

If the memory is full, you may have to delete a message from your inbox or outbox before your phone can update the missing text.

Choose text message options

While reading or viewing a message, you can choose one of the following options.



Note: The following list is dynamic. The order and number of options may vary.

Choice	What it does
Erase	Allows you to delete the message.
Send	Allows you to send the message.
Reply	Allows you to start your reply with an empty screen, a template or with standard replies like "Yes," "No," "Thank you," or "I love you too."

Choice	What it does
Use detail	Allows you to extract phone numbers, e-mail addresses, or web addresses from the current message. The phone goes through and gathers all phone numbers, e-mail addresses or web addresses in the message, including the originating number or address.
Forward	Allows you to send the message to another recipient.
Edit	Allows you to modify the message.
Move	Allows you to move the message to the Outbox or Archive, for example.
Rename	Allows you to enter a new title for the message.
Copy to calend.	Copies the message to your phone's calendar as a reminder note. This option is not available for picture messages.
Details	Shows, for example, the sender's name and phone number, message center used, reception date and time.
Instant messaging	Allows you to start an online conversation.
Save picture	Allows you to save a picture to the template folder. This option only appears in the list if you receive a picture message.

• COMMUNICATE WITH E-MAIL

You can send e-mail messages to friends and family directly from your phone if you sign up for this service with your service provider.

There are two ways of sending an e-mail message.

- You can send an e-mail message from the Messages menu.
- You can send an e-mail message from the phone book.



Tip: Before you send e-mail messages, you can set up a profile to define the e-mail server. Contact your service provider for the e-mail server number.

Define an e-mail sending profile

If you use the e-mail feature on a regular basis, you may find it helpful to define an e-mail sending profile.



Note: This feature depends on your SIM card. Contact your service provide for more information about e-mail profiles.

- 1 Press **Menu**, then press **Select**.
- 2 Scroll up to **Message settings**, then press **Select**.
- 3 Scroll to **Text messages**, then press **Select**.
- 4 Scroll to **Sending profile**, then press **Select**.
If your SIM supports more than one message profile, choose a profile, then press **Select**. If your SIM card already has a profile called **E-mail**, go to step 6.
- 5 Scroll to **Messages sent as**, then press **Select**.
- 6 Scroll to **E-mail**, then press **Select**.
- 7 Scroll to **E-mail server**, then press **Select**.
- 8 Enter the e-mail server number, then press **Options**. Scroll to **Accept**, then press **Select**.

Send an e-mail message

FROM THE MESSAGES MENU

- 1 Press **Menu 01-2 (Messages > Create e-mail)**.
- 2 Enter the e-mail address, then press **OK**.
OR
If you have already saved an e-mail address in the phone book, press **Find**, scroll to the person's name, press **Select**, then **OK**.
- 3 Enter a subject, then press **OK**.
- 4 Enter a message.
- 5 Once you have finished writing, press **Options**, scroll to **Send e-mail**, then press **Select**.
If you have defined an e-mail sending profile, a confirmation note appears.
- 6 If you have not defined an e-mail sending profile, enter the e-mail server number, then press **OK**.

FROM THE PHONE BOOK

First you must have an e-mail address entered into the phone book. See "Save names, numbers and e-mail addresses" on page 39 for instructions.

- 1 Press the **Scroll up** key, then scroll to the person to whom you want to send an e-mail message.
- 2 Press **Details**, scroll through the list until the e-mail address is highlighted, then press **Options**.
- 3 With **Send e-mail** highlighted, press **Select**.
- 4 Enter a subject, then press **OK**.
- 5 Enter a message.
The number of available characters appears in the upper right corner of the screen.
- 6 Once you have finished writing, press **Options**. With **Send e-mail** highlighted, press **Select**.

Receive an e-mail message

When you receive an e-mail message, the phone beeps and displays **Message received** and the  indicator in the upper left corner of the screen.

To read the message now, press **Show**.

When reading a received e-mail message, you can choose other options, such as **Reply**, **Forward** or **Chat**. See "Choose text message options" on page 94 for a list of options.

• STORE MESSAGES

Save a message to a folder

You can save a message to an existing folder or a folder you've created.

- 1 Press **Menu 01-1 (Messages > Create message)**.
After a brief pause, the message entry screen appears in the display.
- 2 Write your message and press **Options**.
- 3 Scroll to **Save message** and press **Select**.
- 4 Scroll to the folder where you want to save the message and press **Select**.
The message is saved.

INBOX FOLDER

Messages are automatically stored in the **Inbox** folder after they've been read or if you press the **End** key when **Message received** appears on the **Start** screen.

OUTBOX FOLDER

You can use the **Outbox** folder to store saved messages.

ARCHIVE FOLDER

To make sure that certain messages won't be overwritten when memory becomes full, move some of your messages to the **Archive** folder.

TEMPLATES FOLDER

Pictures and prewritten templates are stored in the **Templates** folder. You can use a template to speed up your chat session.

- 1 From the message screen press **Options**.
- 2 Scroll to **Use template**, then press **Select**.
- 3 Scroll to the template you want, then press **Select**.

My folders

Keep your messages organized by creating custom folders and saving your messages there.

ADD A FOLDER OF YOUR OWN

- 1 At the **Start** screen, press **Menu**, then press **Select**.
- 2 Scroll to **My folders**, then press **Select**.
- 3 Press **Options**. **Add folder** is highlighted. Press **Select**.
- 4 Enter a name for the new folder and press **OK**. The folder is added.

REMOVE A FOLDER

Only folders created in **My folders** can be deleted. The **Inbox**, **Sent** items, **Archive**, and **Templates** folders are protected. When you delete a folder, all messages in the folder are deleted as well.

- 1 At the **Start** screen, press **Menu**, then press **Select**.
- 2 Scroll to **My folders**, then press **Select**.
Any folders that you've created appear in the display.
- 3 Scroll to the folder you wish to remove and press **Options**.
- 4 Scroll to **Delete folder** and press **Select**.
- 5 Press **OK** if you wish to delete and **Back** if you wish to exit.

Move a message to a folder

- 1 While viewing the message, press **Options**.
- 2 Scroll to **Move** and press **Select**.
- 3 Scroll to the destination folder and press **Select**.
The message is moved.

• ERASE MESSAGES

If your message memory becomes full, the message icon blinks in the display. You can do the following to create more space:

- Read some of the unread messages and then erase them.
- Erase some of these messages from your folders.

Erase a single message

To erase a single message, you need to open it first.

- 1 Press **Menu 01 (Messages)**.
After a brief pause, **Create message** appears in the display.
- 2 Scroll to the folder containing the message you wish to erase and press **Select**.
A list of messages appears in the display.
- 3 Scroll to the message you wish to erase and press **Select**.
The message opens.
- 4 Press **Options**, scroll to **Erase**, and press **Select**.
- 5 You're asked to confirm the erasure. Press **OK** to erase the message.

Erase all messages in a folder

- 1 At the **Start** screen, press **Menu**, then press **Select**.
- 2 Scroll to **Delete messages**, then press **Select**.
- 3 Scroll to the desired folder or message type that you wish to erase and press **Select**.
- 4 You're asked to confirm your erasure. Press **OK** to empty the folder.

• SEND AND RECEIVE PICTURE MESSAGES

Picture messages are like picture postcards. You can add text to the postcard before sending the message to a friend.

There are two places you can find pictures:

- Under Messages > Templates
- Under Messages > Pictures

You can also save new pictures in the Templates folder.

Notes about picture messages

- This function can be used only if it is supported by your network operator or service provider. Only phones that offer picture message features can receive and display a picture message.
- Each picture message is made up of several text messages. Therefore, sending one picture message may cost more than sending one text message. Contact your service provider for pricing information.
- Since pictures are saved in the phone's memory, you cannot view them if you use your SIM card with another phone.



Tip: Before sending a picture message, be sure to set the message mode to Text. See "Set the message mode" on page 90 for instructions.

Send picture messages

- 1 Press Menu, then Select.
- 2 Scroll to Templates, then press Select.
- 3 Scroll up to the picture you want to send, and press Select.
The picture appears. To choose a different picture, press Back, scroll to another picture, then press Select.
- 4 Press Options, scroll to Send, then press Select.
- 5 Scroll to As text msg., then press Select.
- 6 Recall or enter the phone number.



Note: The phone number you choose must be able to receive picture messages.

- 7 Press OK.

Attach a picture to a text message

- 1 Press Menu 01 1 (Messages > Create message).
- 2 Enter your message, then press Options.
- 3 Scroll to **Attach picture**, then press Select.
- 4 Scroll to the picture you want to send, then press View.
- 5 After viewing the picture, select **Attach**.
- 6 Select **Options**, scroll to **Send**, then press Select.
- 7 Enter the phone number or recall a number from your phone book, then press OK.



Note: The phone number you choose must be able to receive picture messages.

Receive picture messages

When you receive a picture message, the phone beeps and displays **Message received** and the  indicator in the upper left corner of the screen.

To read the message now, press **Show**.

To read the message later, press **Exit**.

Read a new picture message later

- 1 When you want to read the message, press **Menu**, then press **Select**
- 2 Scroll to **Inbox**, then press **Select**.
A list of message headers is displayed.
- 3 Scroll to the message you want, then press **Select**.
- 4 If the message is long, use the scroll keys to view the message.

Save picture messages

- 1 While viewing the message, press **Options**.
- 2 Scroll to **Save picture**, then press **Select**.
- 3 Enter a title for the picture, then press **OK**.
A confirmation note appears. The picture is saved to the **Templates** folder.

Save picture messages with edited text

- 1 While viewing the message, press **Options**.
- 2 Scroll to **Edit text**, then press **Select**.
- 3 Scroll to **As text msg.**, then press **Select**.
- 4 Make changes to the text, then press **Options**.
- 5 Scroll to **Save message**, then press **Select**.
- 6 Choose **Sent items**, **Archive**, or **Templates**, then press **Select**. If the phone prompts you to replace the original, press **OK**.

Choose a picture for a screen saver

- 1 Press **Menu**, then press **Select**.
- 2 Scroll to **Pictures**, then press **Select**.
- 3 Scroll to the image you want, then press **Options**.
- 4 Scroll to **Use as s. saver**, then press **Select**.

• RECEIVE MULTIMEDIA MESSAGES (MMS)

A multimedia message (MMS) can contain text, images, and sounds.

Your phone has a multimedia message viewer for playing messages and a multimedia inbox for storing saved messages.

Once you save the multimedia message, you can use the image as a screen saver or the sound as a ringing tone.



Note: This function can be used only if it is supported by your network operator or service provider. Only devices that offer compatible multimedia message or e-mail features can receive and display multimedia messages.

Message receiving limitations

Your phone can receive a multimedia message if

- the message size is under 30 KB, and
- the message type and settings allow reception.

Define MMS settings

Before you can use the multimedia message feature, you need to first define the way you want to receive the messages.



Note: The default setting of the multimedia message service is on, and your operator or service provider may charge you for every message you receive.

ALLOW MULTIMEDIA RECEPTION

You can choose to receive all messages or to receive messages only when you are in the service provider's home network.

- 1 Press Menu, then press Select.
- 2 Scroll up to Message settings, then press Select.
- 3 Scroll to Multimedia msg., then press Select.
- 4 Scroll to Allow multimedia reception, then press Select.
- 5 Scroll to one of the following, then press Select:
 - Yes to allow all incoming messages
 - In home system to allow incoming messages only if you are in the service provider's home system.
- 6 Scroll to Incoming multimedia messages, then press Select.
- 7 Scroll to Retrieve, then press Select.

BLOCK ALL MESSAGES

If you do not want to receive any multimedia messages, follow these instructions.

- 1 Press Menu, then press Select.
- 2 Scroll up to Message settings, then press Select.
- 3 Scroll to Multimedia msg., then press Select.
- 4 Scroll to Allow multimedia reception, then press Select.
- 5 Scroll to No, then press Select.

ALLOW ADVERTISEMENTS

- 1 Press Menu, then press Select.
- 2 Scroll up to Message settings, then press Select.
- 3 Scroll to Multimedia msg., then press Select.
- 4 Scroll to Allow advertisements, then press Select.
- 5 Scroll to Yes, then press Select.

BLOCK ADVERTISEMENTS

- 1 Press **Menu**, then press **Select**.
- 2 Scroll up to **Message settings**, then press **Select**.
- 3 Scroll to **Multimedia msg.**, then press **Select**.
- 4 Scroll to **Allow advertisements**, then press **Select**.
- 5 Scroll to **No**, then press **Select**.

ABOUT CONNECTION SETTINGS

Contact your service provider for information about downloading appropriate connection sets for the multimedia message service.

View a multimedia message

When you receive a multimedia message, the phone beeps and displays **Multimedia message received**.

To view the message now, press **Show**. You can use the scroll keys to view the different elements of the message, for example, text, images, or MIDI tones.

Discard a multimedia message

To discard the message, press **Exit**, then press **OK** to confirm.

Choose multimedia message options

- 1 While viewing a message, press **Options**.
- 2 Scroll to one of these choices listed in the table, then press **Select**.



Note: The following list is dynamic. The order and number of options may vary.

Choice	What it does
Play	Allows you to play the ringing tone when the sound clip part of the multimedia message is active
Save tone	Allows you to save the ringing tone when the sound clip part of the multimedia message is active. The tone is saved under the ringing tone list. See "Customize a profile" on page 65 for information about choosing a ringing tone.
Save image	Allows you to save the image when the graphic part of the multimedia message is active. The image is saved under Messages > Pictures.
Save message	Allows you to save the multimedia message in the Multimedia inbox
Erase message	Allows you to delete a saved multimedia message
Discard	Allows you to delete a newly received multimedia message
Details	Shows information such as the sender's name, subject, type of file, file size, time, and date

• USE INSTANT MESSAGING

Under development

You can now take text messaging to the next level by experiencing Instant Messaging in a wireless environment. You can engage in instant messaging with friends and family, regardless of the mobile system or platform (like the Internet) they are using.

Log into service

CHOOSE AUTOMATIC LOGIN

Instant messages

RECEIVE INSTANT MESSAGES

WRITE AND SEND INSTANT MESSAGES

Chat Sessions

INITIATE CHAT SESSION

QUIT CHAT SESSION

Invitations to group chat

ACCEPT INVITATIONS TO GROUP CHAT

REJECT INVITATIONS TO GROUP CHAT

DELETE INVITATIONS TO GROUP CHAT

Contacts

SAVE TEMPORARY CONTACT TO CONTACT LIST

SAVE NEW CONTACT TO CONTACT LIST

REMOVE CONTACT FROM CONTACT LIST

BLOCK MESSAGES FROM A CONTACT

UNBLOCK MESSAGES FROM A CONTACT

Private Groups

CREATE PRIVATE GROUP

ADD MEMBERS TO PRIVATE GROUP CHAT

REMOVE PRIVATE GROUP MEMBERS

SEND INVITATIONS TO PRIVATE GROUP CHAT

Log Off Service

- **USE THE INFO MESSAGE SERVICE**

With the info message network service, you can receive short text messages on various topics, such as weather and traffic conditions, from your service provider. Info message selections can be found under **Messages > Info messages**.

 **Note:** For available topics and relevant topic numbers, contact your service provider.

- **USE THE SERVICE COMMAND EDITOR**

Use the **Service command editor** to key in and send service requests (also known as USSD commands) to your service provider.

 **Note:** For more information, contact your service provider.

15 Your WAP browser

Your phone has a built-in browser you can use to connect to selected services on the mobile Internet. You can view weather reports, check news or flight times, view financial information, make online purchases and much more.



• NOTES ON MOBILE INTERNET ACCESS

This section gives a brief overview of mobile Internet technology.

Technology background

WAP

A technology called Wireless Application Protocol (WAP) is to mobile devices what the World Wide Web (WWW) is to personal computers. The mobile community began developing WAP several years ago to provide access to Internet sites designed for mobile users.

Today, most WAP sites are made up of text and hyperlinks. Some pages even contain low-resolution graphics, or require data input. Your service provider and others are free to design WAP sites as they choose, so the sites are as variable as Web pages on the Internet.

Internet content on your personal computer is called a "web page." Internet content on your mobile phone is called a "page," "WAP card," or a "Deck of cards."

GPRS

General Packet Radio Service (GPRS) is a technology used to send and receive data via short bursts or packets over the wireless network. GPRS allows you to stay connected to the Internet. This feature allows for faster downloads of information and no time spent completing a dial-up connection. Applications using GPRS include the WAP browser and text messaging.

- For information about how to track time spent online, see "Check data calls" on page 48.
- For information about sending messages via GPRS, see the entry for Use GPRS under "Choose other message settings" on page 91.
- For availability, pricing, and subscription to GPRS services, contact your service provider.

The service provider's role

Because mobile Internet content is designed to be viewed from your phone, your wireless service provider now becomes your "mobile Internet service provider" as well.

It's likely that your service provider has created a home page and set up your browser to go to this page when you log on to the Internet. Once at your service provider's home page, you'll find links to a number of other sites.

• SET UP FOR BROWSING

You should not need to do anything to set up your phone for browsing. Your service provider usually modifies the appropriate settings when you subscribe to the feature. Contact your service provider if you have problems using the browser.

• SIGN ON TO THE MOBILE INTERNET

You use the Services menu to connect to the mobile Internet.



Note: Your phone must be switched on to use this function. Do not switch the phone on when wireless phone use is prohibited or when it may cause interference or danger.

- 1 Press Menu 10 (Services).
- 2 Scroll to Home, then press Select.

Your phone connects to the mobile Internet and to your service provider's home page.

If you see an error message, the phone may not be set up for browsing. Contact your service provider to make sure that your phone is configured properly.

• USE BROWSER OPTIONS

The Services menu gives you the options shown in the following list.

Some service providers may have customized the options on the Services menu. Contact your service provider for more information if any of the options shown here are not available.

Choice	What it does
Home	Starts the browser and takes you to your service provider's home page.
Bookmarks	Shows a list of all saved bookmarks. Bookmarks help you find a WAP site quickly.
Service inbox	Allows you to receive notifications from your service provider. Notifications may be about new e-mail messages, changes in stock prices or news headlines.
Settings	Provides options for changing connection settings, appearance settings, and authority certificate.
Go to address	Accepts an address you enter.
Clear the cache	Empties the browser's temporary memory and frees up space. It's advisable to empty your cache at the end of each session.

• NAVIGATE THE MOBILE INTERNET

Since your phone's screen is much smaller than a computer screen, Internet content is displayed in a different format than you may be used to seeing. This section shows simple guidelines for using the phone's keys to navigate a WAP site. Examples of how to read a WAP site follow the guidelines.

General guidelines for using the phone keys

- Use the scroll keys to browse the WAP site.
- To select a highlighted item, press the Talk key.
- To enter letters and numbers, press the 0 to 9 keys.
- To enter special characters, press the * key.

Examples of mobile Internet sites

The following illustrations show most of the elements you may find on a mobile Internet site. These are examples only.

- 1) **Header line:** shows the current Internet site.
- 2) **Inactive link:** appears as an underlined word.
- 3) **Active link:** appears as a highlighted word.



Use the **Scroll up** and **Scroll down** keys to scroll through the list of links.

- 1) **Selection list:** Brackets [] appear when you have the option to enter information.
- 2) **Options:** Press Options to go to the site's menu and/or browser page.
- 3) **Back:** Press Back to return to the previous page.

Data entry field: Brackets [] around three dots appear when you need to enter information. In this example, you can enter your zip code to receive the local weather forecast.

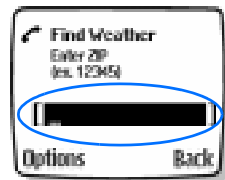
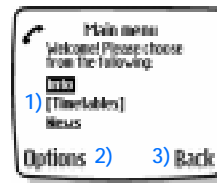

• USE BOOKMARKS

You can save addresses for your favorite sites as bookmarks. A bookmark helps you find a site again, just as a slip of paper helps you find a page in a book.

Set a bookmark

You can add up to 50 bookmarks.

- 1 Press Menu 10-2 (Services > Bookmarks), then press Options.
- 2 Scroll to New bookmark, then press Select.
- 3 Enter address, then press OK.
- 4 Enter a title, then press OK.

Set a bookmark while browsing

- 1 Press Menu 10-1 (Services > Home), then press Options.
- 2 Scroll to Add bookmark, then press Select.

• DISCONNECT FROM THE MOBILE INTERNET

- 1 Press Options.
- 2 Scroll to Quit, then press Select.
The words, **Quit Browsing?** appears in the display.
- 3 Press Yes.



Note: You can also close your connection by pressing and holding the End key.

• SECURITY ISSUES

Clear the cache memory



Note: The information or services you have accessed may be stored in the cache of your phone. A cache is a buffer memory, which is used to store data temporarily. If you have tried to access or have accessed confidential information requiring passwords (for example, your bank account), empty the cache of your phone after each use.

- 1 Press Menu 10 (Services).
- 2 Scroll to Clear the cache, then press Select.

CLEAR THE CACHE WHILE BROWSING

- 1 Press Options.
- 2 Scroll to Clear the cache, then press Select.

About authority certificates

To use some WAP services, such as banking services, you need an authority certificate. Using the certificate can help you to improve the security of connections between your phone and a WAP server.

You can download the certificate from a WAP page if the WAP service supports the use of authority certificates. After the download, you can view the certificate, then save or delete it. If you save the certificate, it is added to the list of certificates in the phone.

Your phone alerts you if the identity of the WAP server or WAP gateway cannot be verified or is not authentic.

VIEW THE LIST OF AUTHORITY CERTIFICATES

- 1 Press Menu 10 (Services).
- 2 Scroll to Settings, then press Select.
- 3 Scroll to Authority certificates, then press Select.

• NOTES ABOUT GPRS

When you use GPRS to connect to the mobile Internet, you are making a data call. The following icons appear on the screen to show you the status of your connection.



Note: In order to use GPRS, you must first subscribe to the network service. Contact your service provider for details on availability and pricing



Warning: Your phone must be switched on to use this function. Do not switch on the phone when wireless phone use is prohibited or when it may cause interference or danger.

	<ul style="list-style-type: none">• Shows up in the left upper corner of the screen• Indicates an active GPRS connection, for example, when you are using the WAP browser
	<ul style="list-style-type: none">• May show up in the left lower corner of the screen, under the signal strength bars, indicating a continuous GPRS connection, if you choose the "always online" setting
	<ul style="list-style-type: none">• Indicates that circuit switched (CS) or voice calls are not possible when using GPRS for a data call
	<ul style="list-style-type: none">• Indicates that the GPRS connection has been interrupted by a voice call

Set up the GPRS connection

Some service providers may have customized the options on the Services menu. Contact your service provider for more information if the options shown here are not available.



Important: GPRS may not be available in all wireless networks. The establishment and continuation of a GPRS and Internet connection depends on network availability, service provider support, and signal strength.

You can choose one of the following options from Services > Settings > Edit active service settings > GPRS connection:

- **Always online:** the GPRS connection is established when you turn your phone on. The connection continues in the background even after you exit the WAP browser, depending on network coverage.
- **When needed:** the GPRS connection is established when you use the WAP browser and is closed when you exit the WAP browser.

The following options shows how to end your browsing session, depending on which option you have chosen for your GPRS connection.

- Press the **End** key to return to the **Start** screen if you have selected **Always online**. The GPRS connection remains in the background.
- Press the **End** key to end the GPRS connection if you have selected **When needed**.
- Press the **End** key twice to return to the **Start** screen if you have selected **When needed**.
- Press and hold the **End** key to end browsing and disconnect from GPRS if you have selected **When needed**.

Receive a call while online

If you are using the WAP browser over GPRS, you can still receive a voice call. Your data call is put on hold and you can choose to answer the call.

- To answer the incoming call, press the **Talk** key.
- To reject the incoming call, press the **End** key.



Note: After you end your voice call, the GPRS connection automatically resumes.

Make a call while online

When you are browsing a WAP card and want to make a call to a number on the WAP page, you can select **Use number**. Your phone then searches the information on the WAP card for a string of numbers. You can then choose from the number or numbers displayed to place the call.

An alternate way is to press the **End** key to disconnect from the Internet, then place your call by searching the phone book for a name and number or by keying in the phone number.

Make an emergency call while online

If you are using GPRS to connect to the mobile Internet, you can end your data connection and then make an emergency call.

- 1 To close your mobile Internet connection, simply press the **End** key twice.
- 2 Enter the emergency number for your present location (for example, 911 or any other official emergency number—emergency numbers vary by location).
- 3 Press the **Talk** key.

16 Your personal digital assistant

Your Nokia 3595 phone has many useful features for organizing your everyday life, including a calendar, alarm clock, calculator, to-do list, wallet, and stopwatch. In this chapter, you'll learn how to use your phone as a personal digital assistant.

• USE THE CALENDAR

The calendar shows a month view and day view. You can use the calendar to keep track of reminders, calls you need to make, and birthdays. You can also set an alarm for calendar notes.



Warning: Your phone must be switched on to use this function. Do not switch on the phone when wireless phone use is prohibited or when it may cause interference or danger.

View the calendar

To view today's date in the calendar, press Menu 6-2 (Organizer > Calendar).

The first time you access the calendar, your phone prompts you to enter the time and today's date.

Select a day

When you open the calendar, the month view shows today's date highlighted. To move the cursor to a new date:

- Press 2 to scroll up one week.
- Press 4 to scroll left.
- Press 6 to scroll right.
- Press 8 to scroll down one week.

Make a note

When you make a note in your calendar, you can choose from the following four types.



Reminder



Call



Birthday



Meeting

ENTER A REMINDER

- 1 Press Menu 6-2 (Organizer > Calendar), press Select, then press Options.
- 2 Scroll to Make a note, then press Select.
- 3 Scroll to Reminder, then press Select.
- 4 Enter your note, press Options, scroll to Save, then press Select.
- 5 Scroll to Alarm on or Alarm off, then press Select.
If you have selected Alarm on, enter a time, then press OK. Scroll to am or pm, then press Select.

ENTER A CALL NOTE

- 1 Press Menu 6-2 (Organizer > Calendar), press Select, then press Options.
- 2 Scroll to Make a note, then press Select.
- 3 Scroll to Call, then press Select.
- 4 Enter the phone number, press Options, scroll to Save, then press Select.
- 5 Enter the person's name, press Options, scroll to Save, then press Select.
- 6 Enter a time, then press OK. Scroll to am or pm, then press Select.
- 7 Choose one of the following, then press Select.
No alarm
Silent
With tone
If you select Silent or With tone, you can then choose a time.

ENTER A BIRTHDAY NOTE

- 1 Press Menu 6-2 (Organizer > Calendar), press Select, then press Options.
- 2 Scroll to Make a note, then press Select.
- 3 Scroll to Birthday, then press Select.
- 4 Enter the person's name, press Options, scroll to Save, then press Select.
- 5 Enter the year of birth, then press OK.
- 6 Choose one of the following, then press Select.
No alarm
Silent
With tone
If you select Silent or With tone, you can then choose a day and time.

ENTER A MEETING NOTE

- 1 Press Menu 6-2 (Organizer > Calendar), press Select, then press Options.
- 2 Scroll to Make a note, then press Select.
- 3 Scroll to Meeting, then press Select.
- 4 Enter the subject of the meeting, press Options, scroll to Save, then press Select.
- 5 Enter the meeting's location, press Options, scroll to Save, then press Select.
- 6 Enter the meeting's start time, then press OK. Scroll to am or pm, then press Select.
- 7 Enter the meeting's end time, then press OK. then press OK. Scroll to am or pm, then press Select.
- 8 Choose one of the following, then press Select.
 - No alarm
 - Silent
 - With toneIf you select Silent or With tone, you can then choose a time.

View calendar notes

After you make a few calendar notes, you can view the day's events.

- 1 From the Start screen, press Menu 6-2 (Organizer > Calendar), then press Select.
- 2 At the month view, scroll to the date you want.
 - Press 2 to scroll up one week.
 - Press 4 to scroll left.
 - Press 6 to scroll right.
 - Press 8 to scroll down one week.
- 3 With the date highlighted, press Options.
- 4 Scroll to View day, then press Select.

• USE THE ALARM CLOCK

The alarm clock feature is based on your phone's internal clock and sounds an alert at a time you specify. The alarm clock works even if you turn your phone off.

Set the alarm clock

- 1 Press Menu 6-1 (Organizer > Alarm clock).
- 2 Enter the alarm time in hhmm format, then press OK.
Step 3 is necessary only if you have selected am/pm format.
- 3 Select either am or pm, then press Select.

Manage the alarm

PHONE ON

- Press Stop to shut off the alarm.
OR
- Press Snooze.

The alarm stops and sounds again in 10 minutes.



Note: If you let the alarm sound for one minute without pressing a key, it stops for ten minutes, and then sounds again.

PHONE OFF

If the alarm time is reached while the phone is switched off, the phone switches itself on and starts sounding the alarm tone. If you press Stop, the phone asks whether you want to activate the phone for calls. Press No to switch off the phone or Yes to make and receive calls.



Note: Do not press Yes when wireless phone use is prohibited or when it may cause interference or danger.

Turn off the alarm clock

- 1 Press Menu 6-1 (Organizer > Alarm clock).
- 2 Scroll to Off and press Select.

• SHARE BUSINESS CARDS

Your phone can send or receive an electronic business card as a short text message. The business card can have either:

- a name and number, or
- a name, multiple numbers (home, work, fax, mobile), an e-mail address, web address and street address if you have entered this information in the phone book.

If you are exchanging business cards with multiple numbers and addresses, both the receiving and sending phone must have a phone book that supports these kinds of entries.

Send a business card as a short text message

- 1 Recall the name from your phone book.
- 2 Press **Details**, if shown, or go to Step 3.
- 3 Press **Options**.
- 4 Scroll to **Send bus. card** and press **Select**.
- 5 Scroll to **Via text msg.** and press **Select**.
- 6 If the name in the phone book has multiple numbers, you have the following choices:
 - Choose **Primary number** if you want to send a name and number only, OR
 - Choose **All details** if you want to send a name, multiple numbers, e-mail, web and street address.
- 7 Enter the number for the receiving phone, then press **OK**.

Receive a business card

Your phone can accept and receive an electronic business card from a compatible phone, if it is one of the following types:

- Nokia Smart Messaging compact business card
- V-card format



Note: If you press the End key at any time before saving the business card, the business card will be deleted.

- 1 When your phone displays **Business card received**, press **Show**.
- 2 After viewing the business card, press **Options**.
- 3 Scroll to **Save** to keep the information in the phone book, then press **Select**
OR
Scroll to **Discard** to delete the business card, then press **Select**.

• USE THE CALCULATOR

Your phone's calculator adds, subtracts, multiplies, divides, and computes square and square root functions.

You can also use the calculator to convert currency.



Note: Your phone must be switched on to use this function. Do not switch on the phone when wireless phone use is prohibited or when it may cause interference or danger.

This calculator has a limited accuracy and rounding errors may occur, especially in long division.

Add, subtract, multiply and divide

- 1 Press Menu 9-1 (Extras > Calculator).
- 2 Enter the first number in the calculation.
 - Press # to enter a decimal point and press Clear to erase any mistakes.
 - To add, press + once (+ appears).
 - To subtract, press - twice (- appears).
 - To multiply, press * three times (* appears).
 - To divide, press / four times (/ appears).
- 3 Enter the second number, repeating steps as needed.
- 4 Press Options.
Equals is selected.
- 5 Press Select.

Use the square and square root functions

You can use the calculator for finding the square of a number or the square root of a number.

- 1 Press Menu 9-1 (Extras > Calculator).
- 2 Enter the number.
- 3 Press Options, scroll to Square or Square root, then press Select.

Convert currency

SET THE EXCHANGE RATE

- 1 Press Menu 9-1 (Extras > Calculator), then press Options.
- 2 Scroll to Exchange rate, then press Select.
- 3 Scroll to Home units converted to foreign units or Foreign units converted to home units.
- 4 Press Select.
- 5 Enter the exchange rate (press # to enter a decimal point).
- 6 Press OK.



Note: The exchange rate remains in the phone's memory until you replace it.

CONVERT A CURRENCY AMOUNT

- 1 Enter the amount to be converted.
- 2 Press Options.
- 3 Scroll to To home to convert to domestic units or To foreign to convert to foreign units.
- 4 Press Select.

• MAKE A TO-DO LIST

You can keep track of your tasks with the to-do list feature. You may be able to save up to 30 notes, depending on how long the notes are.

Add a to-do note

When you add a new note, the default priority is medium (2). You can change the priority to high (1) or low (3).

- 1 Press Menu 6-3 (Organizer > To-do list), press Select, then press Options.
- 2 Scroll to Add, then press Select.
Subject: appears on the display.
- 3 Enter your note, press Options, scroll to Save, then press Select.
- 4 Scroll to the priority you want, then press Select.

Use predictive text for quick note entry

When entering your to-do note, you can use the phone's built-in dictionary to speed things up. See "Predictive text input" on page 36 for details.

- 1 When entering your note, press **Options**.
- 2 Scroll to **Predictive text**, then press **Select**.
- 3 Scroll to the language you want, then press **Select**.
- 4 Continue entering your note.

• USE THE STOPWATCH

Your phone has a stopwatch that can be used to track time at sporting events or other occasions. The stopwatch displays time in hours, minutes, seconds and fractions of a second. 00:00:00:0



Note: Your phone must be switched on to use this function. Do not switch the phone on when wireless phone use is prohibited or when it may cause interference or danger.

Measure time

- 1 Press **Menu 9-2** (Extras > Stopwatch), then press **Select**.
- 2 Scroll to **Split timing** and press **OK**.
- 3 Press **Start** to begin split timing. The running time appears on the screen.

Measure split time

You can use the split time function for such things as a long distance race when you need to pace yourself.

- 1 Press **Menu 9-2** (Extras > Stopwatch), then press **Select**.
- 2 Scroll to **Split timing**, press **OK**, then press **Start**.
- 3 Take an intermediate time by pressing **Split**. The timer continues to run. The split time appears below the running time.

If you split the time more than once, the new measured time appears at the beginning of the list. You can scroll to see previous measured times.

STOP THE SPLIT TIMER

Press **Stop** to end the split timer.

Measure lap time

You can use the lap time function when you want to track how long it takes to complete each cycle or lap.

- 1 Press **Menu 9-2** (Extras > Stopwatch), then press **Select**.
- 2 Scroll to **Lap timing** and press **Select**.
- 3 Press **Start** to begin lap timing. The running time appears on the screen.
- 4 Take a lap time by pressing **Lap**.

The clock stops, then starts immediately from zero. The lap time appears below the running time.

If you take more than 1 lap time, the new measured time appears at the beginning of the list. You can scroll to see previous measured times. When you press **Stop**, the total time appears at the top.

SAVE THE LAP TIME

- 1 While the clock is running, press **Stop**, then press **Options**.
- 2 Scroll to **Save** and press **Select**.
- 3 Enter a name for the measurement and press **OK**. If you don't enter a name, the total time is used as the default title for the lap time.

STOP THE LAP TIMER

Press **Stop** to end the lap timer.

Choose other stopwatch options

You can choose the following options when using the Stopwatch.

Choice	Function
Continue	Shows up when the Stopwatch is working in the background.
Show last time	Allows you to view the last measured time.
View times	Allows you to browse the saved times.
Delete times	Allows you to delete any saved times. You can delete the saved times one by one or all at once.

Note about stopwatch operation

Using the stopwatch consumes the battery and the phone's operating time will be reduced. Be careful not to let it run in the background when performing other operations with your phone.

If you press the **End** key and return to the Start screen, the clock continues to run in the background.

To return to the Stopwatch function, take the following steps:

- 1 Press **Menu 9-2 (Extras > Stopwatch)**. After a brief pause, a list of options appear in the display.
- 2 Scroll to **Continue** and press **Select**.
- 3 To stop the clock, press **Stop**.

• ONLINE PURCHASES



Important: Online purchases and digital signature capabilities are dependent upon your wireless provider. The Wallet feature exists in your phone to support and simplify wireless payment services expected to launch in selected markets in the near future.

Before you can make an online purchase using the WAP browser, you need to enter your credit or debit card information into the Wallet. See "Create a wallet card" on page 128 for more information.

- 1 Press **Menu 10-1 (Services > Home)**.
Your phone connects to the Internet and is directed to your wireless provider's home page.
- 2 Direct your browser to a WAP site which supports wireless transactions in ECML (Electronic Commerce Modeling Language) format.
- 3 When you are ready to make a purchase, press **Options**. Scroll to **Use Wallet Info**, then press **Select**.
- 4 Enter your Wallet code, then press **OK**.
- 5 Scroll to **Cards**, then press **Select**.
- 6 Scroll to the card you would like to use for this purchase (if you have more than one), then press **Select**.
- 7 If the WAP site supports the ECML format, you can chose **Fill in all fields**. Otherwise, you can view the following categories: **Card info**, **User info**, **Shipping info**, **Billing info** and **Receipt info**.
- 8 Scroll to your choice, then press **Select**. Wallet automatically fills in the details

as required by the online service.

Respond to any further queries as necessary to complete the transaction. To digitally sign the payment, select the proper signing certificate from the certificate list. This confirms your purchase.



Note: The Wallet has an automatic time-out feature for security purposes. If the Wallet is open for longer than 5 minutes without any input (keypresses), the phone automatically closes the Wallet. You can continue to use your WAP browser.

• USE THE WALLET

The wallet feature allows you to store debit and credit card information in Electronic Commerce Modeling Language (ECML) format to an encrypted area of your phone's memory. This information can then be used to make fast, secure purchases online. Wallet also uses digital signature for signing and verifying transactions. Online purchases and digital signature capabilities are dependent upon your wireless provider.



Note: In order to make online purchases, you must first be able to access the wireless Internet with your WAP browser. Contact your service provider for information on network availability. This section focuses on setting up the Wallet. After you've entered the necessary information, see "Online purchases" on page 125 for instructions on how to use the Wallet for transactions with your WAP browser.

Notes about wallet security

- To protect yourself against unauthorized purchases, you can require a code to be entered each time you use the wallet. See "Activate wallet code request" on page 127 for instructions.
- Your phone has other security features, including a PIN code that can protect you against unauthorized use in case your phone is stolen. If you activate the PIN code request, your phone will ask for the code each time the phone is turned on. Without the proper code, the phone cannot be used (except to make an emergency call). See "About security codes" on page 84 for more information.
- The wallet also has a time-out feature to increase security. See "Wallet time-out" on page 128 for details.

Create a wallet code

The first time you use the wallet, you'll be asked to create a wallet code. The wallet code must be from four to ten characters in length.

- 1 Press **Menu 6-4** (**Organizer > Wallet**).
- 2 Enter your code and press **OK**. You'll be asked to verify the code.
- 3 Enter the code again for verification and press **OK**.

A confirmation note appears on the screen.



Note: Create a code that is unique, yet easy to remember. This will be your key to using wallet features. Also, keep your wallet code in a secret place, separate from your phone.

Change your wallet code

- 1 Press **Menu 6-4** (**Organizer > Wallet**).
- 2 Enter your wallet code, then press **OK**.
- 3 Scroll to **Settings**, then press **Select**.
- 4 Scroll to **Change code**, then press **Select**.
- 5 Enter the original wallet code, then press **OK**.
- 6 Enter the new wallet code, then press **OK**.
- 7 Enter the new wallet code for verification, then press **OK**.

A confirmation note appears on the screen.

Activate wallet code request

To protect yourself against unauthorized purchases, you can require the wallet code to be entered each time you use Wallet.

- 1 At the **Start** screen, press **Menu 6-4** (**Organizer > Wallet**).
- 2 Enter your wallet code and press **OK**.
- 3 Scroll to **Settings** and press **Select**.
- 4 **Code request** appears on the screen, then press **Select**.
- 5 Enter the wallet code and press **OK**.
- 6 Scroll to **On** to activate or **Off** to deactivate the code request, then press **Select**.

Wallet time-out

If Wallet is open for longer than 5 minutes without any input (keypresses), the phone prompts you for a response. The words, **Close wallet?** appear on the display.

- To close the wallet, press **OK**.
- To keep the wallet open, press **Back**.

If you don't respond within five seconds, Wallet closes and the phone returns to the **Start** screen.

Create a wallet card

Wallet cards contain data entry fields for shipping, billing, receipt, and credit card information. Once you create a wallet card, you can make online purchases.

Your wallet can hold up to 5 card sets.

- 1 Press **Menu 6-4 (Organizer > Wallet)**. If the code request is activated, the phone prompts you for the wallet code.
- 2 Enter the wallet code and press **OK**. Scroll to **Cards**, then press **Select**.
- 3 Scroll to a card set, then select one of the options listed below:

Choice	What it does
Card info	Allows you to enter card holder, type, number, verification value, expiration date (day, month and year).
User info	Allows you to enter your user name and password.
Shipping info	Allows you to enter your first, middle and last name, company name, street address 1, street address 2, city, state, zip code, country, phone number, and e-mail address.
Billing info	Allows you to enter your first, middle and last name, company name, street address 1, street address 2, city, state, zip code, country, phone number and e-mail address.
Receipt info	Allows you to enter a receipt to phone number and a receipt to e-mail address
Copy card	Copies the contents of the selected card to one of the other four cards [not in Amadeus proto but in Wallet spec...?]
Clear card	Allows you to delete the contents of the selected card

Choice	What it does
Rename card	Allows you to assign a new name to the selected card. The name cannot be more than 20 characters.

Use predictive text for quick card entry

When entering your information in a wallet card, you can use the phone's built-in dictionary to speed things up. See "Predictive text input" on page 36 for details.

- 1 Chose a card set, then press **Select**.
- 2 Scroll to **View**, then select the type of information, for example **Card info**, then **Card holder**.
- 3 Press **Options**.
- 4 Scroll to **Predictive text**, then press **Select**.
- 5 Scroll to the language you want, then press **Select**.
- 6 Continue entering your card information.

Compose a personal note

You can store up to 30 personal notes in the wallet. Your notes are protected by wallet's security feature.

- 1 At the **Start** screen, press **Menu 6-4 (Organizer > Wallet)**.
- 2 Enter your wallet code (if the code request is activated), then press **OK**.
- 3 Scroll to **Personal notes**, then press **Select**.
- 4 Select **Add new**, compose a note up to 139 characters, then press **Options**.
- 5 Scroll to **Save**, then press **Select**.
- 6 Enter a title for the note, then press **Options**.
- 7 Scroll to **Save**, then press **Select**.

Reset the wallet code

If you forget the wallet code and want to erase all the information stored in the wallet, follow these steps.



Caution: Once you reset the wallet code and contents, you *cannot* restore this information.

- 1 From the **Start** screen, enter ***#3925538#**.
Delete code and content of wallet? appears on the screen.
- 2 If you want to *permanently* delete the wallet code and contents, then press **OK**.
- 3 Enter the security code, then press **OK**.

• SYNCHRONIZING DATA

Your phone has the ability to synchronize its phone book and calendar data with remote devices. Using the synchronization feature, data such as names, numbers, and e-mail addresses stored in your phone book, or day notes and reminders from the calendar can be exchanged with other devices through a synchronization service provider. After synchronization, the data in the phone will be the same as the data contained in the host database.

Before you begin

Before you can begin to use your phone's synchronization feature, you must first verify the following:

- You must establish service with a synchronization service provider - either directly or through your wireless service provider.
- You must be in a digital service area. If you are roaming in an analog network, the synchronization feature will not be available.

For more information about signing up for synchronization services, contact your wireless service provider.

Configure your phone for synchronization

Your phone can be configured automatically by your wireless service provider or manually through the **Server Options** menu.

Automatic configuration

Your service provider may be able to automatically configure your phone with the correct synchronization settings using SMS. This can only take place while your phone is in idle mode. After your service provider sends the settings via SMS, your alert tone will sound and a message will appear, saying "Allow automatic overwriting of synch. settings?" Select "Yes" to begin overwriting your settings.

Manual configuration

You can manually configure your phone with the correct synchronization settings.

- 1 Press **Menu 6-5-2 (Organizer > Synchronize > Settings)**.
- 2 Scroll to one of the following options, then press Select:
 - Active Internet sync. settings
 - Custom. active Internet sync.

ACTIVE INTERNET SYNC. SETTINGS

This menu option allows you to select which synchronization set to activate. You have the option of renaming the set. There are four sets available.

CUSTOM. ACTIVE INTERNET SYNC.

This menu option allows you to customize the active synchronization set from a set of options, which are shown in the following table.

Choice	What it does
Data to be synchronized	Allows you to select the databases to be synchronized. When you select this menu item, you are given two options, Phone book or Calendar, which will be implemented during future synchronization sessions.
Database address	Allows you to enter the database address for the database you are synchronizing.
User name	Allows you to create or change your user name for authorization with the synchronization server. If you have previously entered a user name, it appears.

Choice	What it does
Password	Allows you to establish or change your password, which is used to authenticate your user name while connecting with the synchronization server. If you change your password or user name in the phone without also changing them with the synchronization service provider, you will not be able to synchronize your data.
Synchronization Server	Allows you to enter the name of the synchronization server to which you are connecting to synchronize your data.
Copy card	Copies the contents of the selected card to one of the other four cards [not in Amadeus proto but in Wallet spec...?]
Clear card	Allows you to delete the contents of the selected card
Rename card	Allows you to assign a new name to the selected card. The name cannot be more than 20 characters.

Start the synchronization process

During the synchronization process, it is not possible to access the database where your data is stored. However, you can cancel the synchronization process by pressing Quit or the End key.



Note: It is not possible to place or receive calls, including emergency calls, during synchronization. To place a call, you must cancel the synchronization process.

- 1 Press **Menu 6-5-2 (Organizer > Synchronize)**.
Synchronize selected data? appears.
- 2 Press Yes and the synchronization begins.
Once all selected databases have been synchronized, a confirmation notes appears, indicating which databases have been synchronized.
- 3 Press OK to return to the Start screen.

17 Fun and games

• GAME RULES

Challenge yourself or a friend to one of the four fun games in your phone.

- In **Airglider** you must avoid enemy flying disks or be instantly destroyed.
- In **Bowling**, you try to score as many points as possible. Hit Strikes and Spares as you go for glory and monitor your progress on the high score chart.
- In **Backgammon**, you can play a one of the world's most popular and enduring games. Use a doubling cube which allows you to successively double the points at stake over a game while you play.
- In **Skydiver**, you can skydive from the air to a target area on the ground as quickly as possible. Watch out for birds and planes as you freefall.



Warning: Your phone must be switched on to use this function. Do not switch on the phone when wireless phone use is prohibited or when it may cause interference or danger.

Start a new game

- 1 Press Menu 7-4 (Games > Select game).
- 2 Scroll to the desired game, then press Select.

Adjust game settings

- 1 To adjust sound, lights or vibra, press Menu 7-4 (Games > Settings).
- 2 Scroll to the desired setting and press Select. The following settings are available for all games:

Option	Description
Game sounds	Used to turn game sound effects On or Off.
Game lights	Used to turn screen lights On or Off during game play only.
Shakes	Used to turn game vibrating effects On or Off.

Use the Xpress-on™ Gaming Cover

The Xpress-on™ gaming cover features a modified keypad design with enhanced game controls. The gaming cover also works for normal phone functions. The vibrating alert must be on for some covers to light. In some profiles, the vibrating alert default is Off, so the lights may not flash unless you change the default. For instructions on how to change the covers, see page 80.



Important: The gaming cover works with preloaded games only.

- 1 Press Menu 7-4 (Games > Settings).
- 2 Scroll to Game controls, then press Select.
- 3 Scroll to Games cover, then press Select.

Game control

Your phone supports four-way scrolling while playing the games. Use the following keys to navigate through the games:

- Press 2 to scroll up.
- Press 8 to scroll down.
- Press 4 to scroll left.
- Press 6 to scroll right.

LEARN ABOUT GAME OPTIONS

Use the option Instructions to learn how to play the game. With the option Level you can choose the difficulty level of the game.

• CUSTOMIZE YOUR PHONE WITH JAVA™ APPLICATIONS

Your Nokia 3595 phone has an Applications menu for downloading and storing Java™ applications or midlets. The phone software may include midlets specially designed for this phone.



Examples of downloadable Java applications include interactive games, animations, sports training calendars, and map applications.

Launch an application

- 1 Press Menu 8-1 (Applications > Select app.)
- 2 If you have more than one application, scroll to the one you want to launch, then press Options.

- 3 Scroll to **Open**, then press **Select**.



Tip: If an application uses the whole display area, no selection key names are displayed. Press one of the selection keys to show the options list. Then, select one of the options or press **Back** to continue with the application.

Check available memory

Before you download new applications to your Nokia 3595 phone, be sure to check the available memory.

- 1 Press **Menu 8-3 (Applications > Memory)**.
The phone displays the available memory.
- 2 Press **More** to display how the memory is being used between your phone's applications and games.

Download an application

You can download new Java applications from the mobile Internet. Use the WAP browser to find an appropriate application.



Caution: Only install software from sources that offer adequate protection against viruses and other harmful software.

- 1 Press **Menu 8-2 (Applications > App. downloads)**.
- 2 Scroll to the application you want to download, then press **Select**.

See "Sign on to the mobile Internet" on page 109 for more information about the WAP browser.

Choose other application options

When viewing the list of applications, press **Options** to access the choices listed in the following table:

Choice	What it does
Open	Allows you to launch an application.
Erase	Allows you to delete the application or application set from the phone.
Web access	An application may require web access to make updates. You can restrict the application from accessing the mobile Internet. Your choices include Ask first , Allowed , and Not allowed .

DRAFT

Choice	What it does
Check version	Allows you to check if a new version of the application is available for download from mobile Internet services.
Web page	Allows you to check on additional information for the application from Internet Mobile Services. Web page is shown only if an Internet address has been provided with the application.
Details	Allows you to view information about the application, for example, the name, version number, vendor, a brief description, or memory size.

18 Reference information

• BATTERIES, CHARGERS, AND ACCESSORIES

This section provides information about the phone's batteries, accessories, and chargers. Be aware that the information in this section is subject to change as the batteries, chargers, and accessories change.

Check the model number of any charger before use with this device.



Warning: Use only batteries, chargers and accessories approved by the phone manufacturer for use with this particular phone model. The use of any other types may invalidate any approval or warranty applying to the phone, and may be dangerous. For availability of approved accessories, please check with your dealer.



Note: For information on how to charge and recharge your battery, refer to "Charge the battery" on page 15.

Charging and Discharging

Your phone is powered by a rechargeable battery.

Note that a new battery's full performance is achieved only after two or three complete charge and discharge cycles!

The battery can be charged and discharged hundreds of times but it will eventually wear out. When the operating time (talk and standby time) is noticeably shorter than normal, it is time to buy a new battery.

Use only batteries approved by the phone manufacturer and recharge your battery only with the chargers approved by the manufacturer.

Unplug the charger when not in use. Do not leave the battery connected to a charger for longer than a week, since overcharging may shorten its lifetime. If left unused, a fully charged battery will discharge itself over time.

Temperature extremes can affect the ability of your battery to charge. Allow it to cool down or warm up first.

When the battery is running out of power and your phone only has a few minutes of talk time remaining, a warning tone sounds and the **Battery low** message appears briefly. When no more talk time is left, a warning tone is sounded and the phone switches itself off.

DRAFT

Do not short-circuit the battery. Accidental short-circuiting can occur when a metallic object (coin, clip, and pen) causes a direct connection of the + and - terminals of the battery (metal strips on the battery), for example, when you carry a spare battery in your pocket or purse. Short-circuiting the terminals may damage the battery or the connecting object.

Leaving the battery in hot or cold places, such as in a closed car in either summer or winter conditions, will reduce the capacity and lifetime of the battery. Always try to keep the battery between 59°F and 77°F (15°C and 25°C).

A phone with a hot or cold battery may not work temporarily, even when the battery is fully charged. The performance of Li-Ion batteries is particularly limited in temperatures below 32°F (0°C).

The following list provides guidelines that you can follow:

- When the operating time (talk and standby time) is noticeably shorter than normal, buy a new battery.
- Use the battery only for its intended purpose.
- Never use any charger or battery that is damaged and/or worn out.
- Dispose of batteries according to local regulations (for example, recycling). Do not dispose of as household waste.
- When you disconnect the power cord of any accessory, grasp and pull the plug, not the cord.

• IMPORTANT SAFETY INFORMATION

This section provides additional safety information. A brief overview of safety can be found in "For your safety" on page 1.

Traffic Safety

Do not use a handheld telephone while driving a vehicle. Always secure the phone in its holder; do not place the phone on the passenger seat or where it can break loose in a collision or sudden stop.

Remember road safety always comes first!

Operating environment

Remember to follow any special regulations in force in any area and always switch off your phone whenever it is forbidden to use it, or when it may cause interference or danger.

Use the phone only in its normal operating positions.

Parts of the phone are magnetic. Metallic materials may be attracted to the phone, and persons with a hearing aid should not hold the phone to the ear with the hearing aid. Always secure the phone in its holder, because metallic materials may be attracted by the earpiece. Do not place credit cards or other magnetic storage media near the phone, because information stored on them may be erased.

Electronic devices

Most modern electronic equipment is shielded from radio frequency (RF) signals. However, certain electronic equipment may not be shielded against the RF signals from your wireless phone.

PACEMAKERS

Pacemaker manufacturers recommend that a minimum separation of 20 cm (6 inches) be maintained between a handheld wireless phone and a pacemaker to avoid potential interference with the pacemaker. These recommendations are consistent with the independent research by and recommendations of Wireless Technology Research. Persons with pacemakers:

- Should always keep the phone more than 20 cm (6 inches) from their pacemaker when the phone is switched on.
- Should not carry the phone in a breast pocket.
- Should use the ear opposite the pacemaker to minimize the potential for interference.
- If you have any reason to suspect that interference is taking place, switch off your phone immediately.

HEARING AIDS

Some digital wireless phones may interfere with some hearing aids. In the event of such interference, you may want to consult your service provider.

Other medical devices

Operation of any radio transmitting equipment, including cellular phones, may interfere with the functionality of inadequately protected medical devices. Consult a physician or the manufacturer of the medical device to determine if they are adequately shielded from external RF energy or if you have any questions. Switch off your phone in health care facilities when any regulations posted in these areas instruct you to do so. Hospitals or health care facilities may be using equipment that could be sensitive to external RF energy.

Vehicles

RF signals may affect improperly installed or inadequately shielded electronic systems in motor vehicles (for example, electronic fuel injection systems, electronic antiskid/antilock braking systems, electronic speed control systems, air bag systems). Check with the manufacturer or its representative regarding your vehicle. You should also consult the manufacturer of any equipment that has been added to your vehicle.

POSTED FACILITIES

Switch your phone off in any facility where posted notices so require.

Potentially explosive atmospheres

Switch off your phone when in any area with a potentially explosive atmosphere and obey all signs and instructions. Sparks in such areas could cause an explosion or fire resulting in bodily injury or even death.

Users are advised to switch off the phone when at a refuelling point (service station). Users are reminded of the need to observe restrictions on the use of radio equipment in fuel depots (fuel storage and distribution areas), chemical plants, or where blasting operations are in progress.

Areas with a potentially explosive atmosphere are often but not always clearly marked. They include below deck on boats; chemical transfer or storage facilities; vehicles using liquefied petroleum gas (such as propane or butane); areas where the air contains chemicals or particles, such as grain, dust, or metal powders; and any other area where you would normally be advised to turn off your vehicle engine.

Vehicles

Only qualified personnel should service the phone or install the phone in a vehicle. Faulty installation or service may be dangerous and may invalidate any warranty which may apply to the unit.

Check regularly that all wireless phone equipment in your vehicle is mounted and operating properly.

Do not store or carry flammable liquids, gases or explosive materials in the same compartment as the phone, its parts or accessories.

For vehicles equipped with an air bag, remember that an air bag inflates with great force. Do not place objects, including both installed or portable wireless equipment in the area over the air bag or in the air bag deployment area. If in-vehicle wireless equipment is improperly installed and the air bag inflates, serious injury could result.

FCC regulations prohibit using your phone while in the air. Switch off your phone before boarding an aircraft. The use of wireless telephones in an aircraft may be dangerous to the operation of the aircraft, disrupt the wireless telephone network, and may be illegal.

Failure to observe these instructions may lead to suspension or denial of telephone services to the offender, legal action or both.

• EMERGENCY CALLS



Important: This phone, like any wireless phone, operates using radio signals, wireless, and landline networks as well as user-programmed functions. Because of this, connections in all conditions cannot be guaranteed. Therefore you should never rely solely upon any wireless phone for essential communications (for example, medical emergencies).

To make an emergency call:

- 1 If the phone is not on, switch it on. Check for adequate signal strength. Some networks may require that a valid SIM card is properly inserted in the phone.
- 2 Press the **End** key as many times as needed (for example, to exit a call, to exit a menu, etc.) to clear the display and ready the phone for calls.
- 3 Key in the emergency number for your present location (for example, 911 or other official emergency number). Emergency numbers vary by location.
- 4 Press the **Talk** key

If certain features are in use, you may first need to turn those features off before you can make an emergency call. Consult this user guide and your local cellular service provider.

When making an emergency call, remember to give all the necessary information as accurately as possible. Remember that your wireless phone may be the only means of communication at the scene of an accident—do not end the call until given permission to do so.

• CERTIFICATION INFORMATION (SAR)

THIS MODEL PHONE MEETS THE GOVERNMENT'S REQUIREMENTS FOR EXPOSURE TO RADIO WAVES.

Your wireless phone is a radio transmitter and receiver. It is designed and manufactured not to exceed the emission limits for exposure to radio frequency (RF) energy set by the Federal Communications Commission of the U.S. Government. These limits are part of comprehensive guidelines and establish permitted levels of RF energy for the general population. The guidelines are based on standards that were developed by independent scientific organizations through periodic and thorough evaluation of scientific studies. The standards include a substantial safety margin designed to assure the safety of all persons, regardless of age and health.

The exposure standard for wireless mobile phones employs a unit of measurement known as the Specific Absorption Rate, or SAR. The SAR limit set by the FCC is 1.6W/kg.* Tests for SAR are conducted using standard operating positions accepted by the FCC with the phone transmitting at its highest certified power level in all tested frequency bands. Although the SAR is determined at the highest certified power level, the actual SAR level of the phone while operating can be well below the maximum value. This is because the phone is designed to operate at multiple power levels so as to use only the power required to reach the network. In general, the closer you are to a wireless base station antenna, the lower the power output.

Before a phone model is available for sale to the public, it must be tested and certified to the FCC that it does not exceed the limit established by the government-adopted requirement for safe exposure. The tests are performed in positions and locations (for example, at the ear and worn on the body) as required by the FCC for each model. The highest SAR value for this model phone as reported to the FCC when tested for use at the ear is 1.08 W/kg, and when worn on the body, as described in this user guide, is 0.73 W/kg. (Body-worn measurements differ among phone models, depending upon available accessories and FCC requirements).

While there may be differences between the SAR levels of various phones and at various positions, they all meet the government requirement.

The FCC has granted an Equipment Authorization for this model phone with all reported SAR levels evaluated as in compliance with the FCC RF exposure guidelines. SAR information on this model phone is on file with the FCC and can be found under the Display Grant section of <http://www.fcc.gov/oet/fccid> after searching on FCC ID GMLNPM-10.

For body worn operation, this phone has been tested and meets the FCC RF exposure guidelines for use with an accessory that contains no metal and that positions the handset a minimum of 5/8 inch (1.5 cm) from the body. Use of other accessories may not ensure compliance with FCC RF exposure guidelines. If you do not use a body-worn accessory and are not holding the phone at the ear, position the handset a minimum of 5/8 inch (1.5 cm) from your body when the phone is switched on.

*In the United States and Canada, the SAR limit for mobile phones used by the public is 1.6 watts/kilogram (W/kg) averaged over one gram of tissue. The standard incorporates a substantial margin of safety to give additional protection for the public and to account for any variations in measurements. SAR values may vary depending on national reporting requirements and the network band. For SAR information in other regions please look under product information at www.nokia.com/us.

• CARE AND MAINTENANCE

Your phone is a product of superior design and craftsmanship and should be treated with care. The suggestions below will help you to fulfill any warranty obligations and to enjoy this product for many years:

- Keep the phone and all its parts and accessories out of the reach of small children.
- Keep the phone dry. Precipitation, humidity, and all types of liquids or moisture can contain minerals that will corrode electronic circuits.
- Do not use or store the phone in dusty, dirty areas. Its moving parts can be damaged.
- Do not store the phone in hot areas. High temperatures can shorten the life of electronic devices, damage batteries, and warp or melt certain plastics.
- Do not store the phone in cold areas. When it warms up (to its normal temperature), moisture can form inside and may damage electronic circuit boards.
- Do not attempt to open the phone, except as explained in this guide. Non-expert handling may damage it.
- Do not drop, knock, or shake the phone. Rough handling can break internal circuit boards.
- Do not use harsh chemicals, cleaning solvents, or strong detergents to clean the phone.
- Do not paint the phone. Paint can clog the moving parts and prevent proper operation.
- Use only the supplied or an approved replacement antenna. Unauthorized antennas, modifications, or attachments could damage the phone and may violate regulations governing radio devices.

All of the above suggestions apply equally to your phone, battery, charger or any accessory. If any of them are not working properly, take them to your nearest qualified service facility. The personnel there will assist you, and if necessary, arrange for service.

• ACCESSORIES

If you want to enhance your phone's functionality, a range of accessories is available for you. You can select any of these items to help accommodate your specific communication needs. For availability of these and other accessories, contact your dealer.



A FEW PRACTICAL RULES FOR ACCESSORY OPERATION

- Keep all accessories out of reach of small children.
- When you disconnect the power cord of any accessory, grasp and pull the plug, not the cord.
- Check regularly that any vehicle-installed accessories are mounted and are operating properly.
- Installation of any complex car accessories *must* be made by qualified personnel only.

Use only batteries, chargers, and accessories that have been approved by the phone manufacturer. The use of any other types could invalidate any approval or warranty applying to the phone, and could be dangerous. Refer to "Batteries, chargers, and accessories" on page 137 for important battery usage information.

• BATTERY INFORMATION

This section provides information about the phone's battery. Be aware that the information in this section is subject to change.



Note: The phone uses a lithium ion (Li-Ion) battery. Dispose of used batteries in accordance with any local regulations. Do not dispose of as household waste.

The tables shown in this section provide information about the batteries that are available for your phone, charging times with the Rapid Travel Charger (ACP-8), the Standard Travel Charger (ACP-7), talk times, and standby times. Consult your service provider for more information.

Charging Times

The charging times listed below are approximate.

Battery option	ACP-7 Charger	ACP-8 Charger	ACP-12 Charger
BLC-2 Li-ion Battery 950 mAh	4 hours	2.5 hours	2 hours

Standby and Talk Times

The times shown in the following table are estimates only and represent a range for either standby or talk times (not a combination of both). The operation time of the battery depends on conditions such as:

- Transmitting power level
- Signal (distance between the phone and the base station)
- Network parameters defined by the operator
- Phone use (WAP, games, SMS, Xpress-on active covers)
- Charging procedure used

Battery option	Talk time	Standby time
BLC-2 Li-ion Battery 1000 mAh	up to 4.5 hours	up to 13 days

• CHARGERS AND OTHER ACCESSORIES

This section provides information about the phone's chargers and accessories. Be aware that the information in this section is subject to change as the chargers and accessories change.

The chargers and accessories that are described in this section are available for your phone. Contact your dealer for details.



Note: When a charger is not in use, disconnect it from the power source. Do not leave the battery connected to a charger for longer than a week, since prolonged maintenance charging of the battery could shorten its life span. If left unused, a fully charged battery will discharge itself over time.

For information about Accessibility solutions, including accessories, see page 9.



Note: Stylish carrying cases that protect your 3595 phone are available for purchase and can be located at www.nokia.com/us.

Standard Travel Charger (ACP-7)

The Standard Travel Charger is a lightweight (187 g) and durable AC charger.

To use the Standard Travel Charger, plug it into a standard 120 V AC wall outlet and connect the lead from the charger to the base of your phone.

This charger can also be used with the optional Compact Desktop Charging Stand (DCV-10).



Note: If the battery is completely empty, you cannot use the phone until it has enough charge to operate.

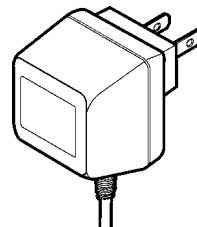

Rapid Travel Charger (ACP-8)

The Rapid Travel Charger is a lightweight (100 g) and durable AC charger. Calls can be made during charging, even with a fully discharged battery.

To use the Rapid Travel Charger (ACP-8), plug it into a standard 120 V or 220 V AC wall outlet, and connect the lead from the charger to the base of your phone.

The charger can also be used together with the optional Compact Desktop Charging Stand (DCV-10). Approximate charging times for discharged batteries are shown in "Charging Times" on page 146.

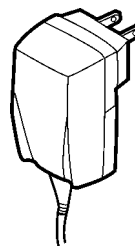

Travel Charger (ACP-12)

The Travel Charger is a small, lightweight, high power AC-switcher charger, with cable management.

To use the Travel Charger, plug it into a standard 120 V wall outlet and connect the lead from the charger to the base of your phone. (Voltages for other countries are also available.)

This charger can also be used with the optional Compact Desktop Charging Stand (DCV-10).

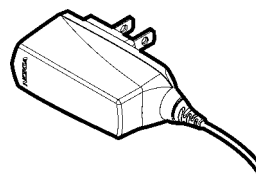

Mobile Charger (LCH-9)

You can charge your phone's battery from your vehicle battery by using the Mobile Charger (LCH-9).

Calls are possible during charging. A green light indicates that the charger is ready for charging.

The battery charging times are the same as those for the Rapid Travel Charger (ACP-8).

The input voltage range is from 11 V to 24 V DC, negative grounding. Avoid prolonged charging with the Mobile Charger (LCH-9) when the car engine is not running; this could cause your car battery to drain. Note also, that in some cars, the cigarette lighter plug is not provided with electricity if the ignition is not switched on.

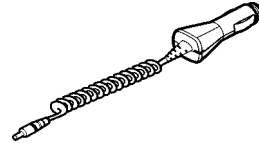

Mobile Charger (LCH-12)

You can charge your phone's battery from your vehicle battery by using the Mobile Charger (LCH-12).

Calls are possible during charging. A green light indicates that the charger is ready for charging.

The battery charging times are the same as those for the Rapid Travel Charger (ACP-8).

The input voltage range is from 10.8 V to 32 V DC, negative grounding. Avoid prolonged charging with the Mobile Charger (LCH-12) when the car engine is not running; this could cause your car battery to drain. Note also, that in some cars, the cigarette lighter plug is not provided with electricity if the ignition is not switched on.

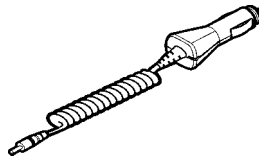

Headrest Handsfree Accessory (BHF-2)

The Headrest Handsfree Accessory (BHF-2) offers a headrest handsfree option with an ergonomic design and easy installation. Also, charging of the phone is simultaneous as power is provided to the Headrest Handsfree Accessory via Mobile Charger (LCH-12).

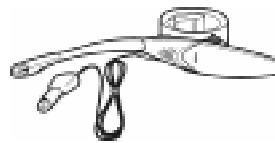

Compact Desktop Charging Stand (DCV-10)

Used together with the Standard Travel Charger (ACP-7), the Rapid Travel Charger (ACP-8), or the Travel Charger (ACP-12), the Compact Desktop Charging Stand is a stylish choice when you need your phone close at hand, always ready for calls.

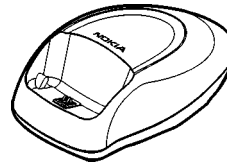

This charging stand allows you to charge your phone's battery in an upright, obtainable position on your desk.

Battery Charging Stand (DDC-1)

This Battery Charging Stand provides the possibility to charge a spare battery and thus have a full power source available whenever needed.

- Compatible with BLC-1 and BLC-2.
- Can be used with the Standard Charger (ACP-7), the Rapid Travel Charger (ACP-8) and the Travel Charger (ACP-12).

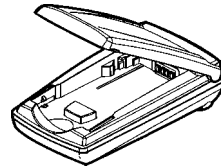

Headset Kit (HDC-5)

Small and lightweight, the headset kit allows easy and convenient handsfree operation. The headset has a foam earpiece cover for a comfortable fit and has a clip to hold it firmly in place. This headset's 4-wire 2.5 mm plug fits directly into the bottom of the phone, see "Set up your headset" on page 16 for more details. A remote control button located in the microphone makes the headset convenient to use while answering or receiving calls. You can use the headset with your phone's voice tag feature, see "Make a call using voice recognition" on page 61 for more information.

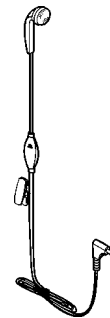

Headset Kit (HDE-2)

Small and lightweight, the headset kit allows easy and convenient handsfree operation. This headset comes with a clip for a comfortable fit. This headset's 4-wire 2.5 mm plug fits directly into the bottom of your phone. See "Set up your headset" on page 16 for more details.

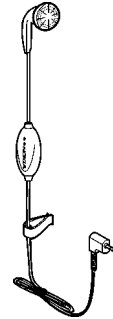

Boom Headset (HDB-5)

Small and lightweight, the Boom Headset fits over the ear. This headset has excellent audio quality with the microphone and speaker integrated into the unit. The Boom Headset provides basic handsfree functionality with an answer/end button. See "Set up your headset" on page 16 for more details.



Retractable Headset Kit (HDC-10)

Compact and functional, this headset provides you with convenient, portable, handsfree operation. The retractable mechanism and remote control provide easy operation.

See "Set up your headset" on page 16 for more details.

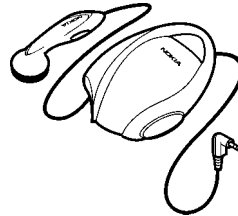

Express Car Kit (CARK 125)

This car kit provides charging and handsfree functionality. With excellent audio quality, the car kit is easy to use and is compatible with 12 V systems.

The Express Car Kit Includes a holder, plug-in handsfree, external microphone.

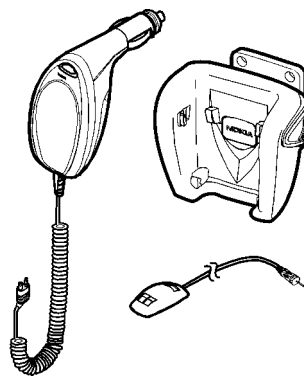

Full Car Kit (CARK 134)

The Full Car Kit (CARK 134) offers a convenient handsfree option, automatic charging facility, transmission capacity with external antenna connection and car radio mute.

The Full Car Kit contains the following:

- HHS-9 Swivel Mount
- HFU-5 Junction Box
- MKU-1 Mounting Plate
- HFM-8 Handsfree Microphone
- HFS-12 External Handsfree Speaker
- PCH-4J Power Cable

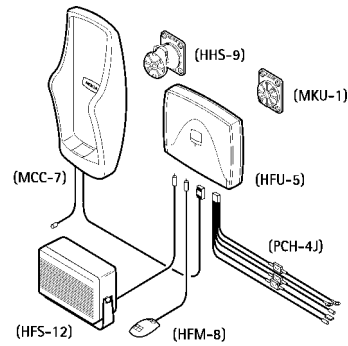

Important: Installation should be done by qualified personnel only to secure safe and efficient equipment and wiring. Please note that the terms of the warranty require that the car kit be installed by an experienced installation facility. An end user should never attempt to install the car kit without professional assistance as the installation requires special tools and knowledge. Electronic fuel injection systems, electronic cruise control systems, and other electronic systems can malfunction due to the lack of protection from radio signals. Please check with your local retail store or your service provider for professional installation facilities in your area.

There is no optional privacy handset for the Full Car Kit.

Antenna considerations: Please contact your local dealer for the type of external antenna that will best support the system and terrain in your area.

19 Technical information

Weight	80 g 107 g with BLC-2 battery
Size	Length 119 mm (4.68 in.) Width 50 mm (1.97 in.) Depth 23 mm (0.90 in.)
Transmitting power	GSM 850 2 W GSM 1900 1 W
Operating voltage	3.6 V DC nominal 3.6 V DC for car kit
Networks	GSM 850 MHz/1900 MHz
Frequency band	GSM 850 824.2 to 848.8 MHz (TX) 869.2 to 893.8 MHz (RX) GSM 1900 1850.2 to 1909.8 MHz (TX) 1930.2 to 1989.8 MHz (RX)
Memory locations	Up to 500 memory locations in phone. Each location holds up to 5 numbers and 3 text fields (dynamic memory); Check with your SIM card provider or carrier for information about SIM card memory capacity.

20 Troubleshooting

This section provides a table that lists some of the most commonly encountered problems and provides possible causes and solutions.

Problem	Possible cause	Possible solution
My phone isn't charging.	The charger and the phone are not properly connected.	Securely connect the charger to the phone.
	The charger is not properly plugged in.	Make sure that the charger is plugged in correctly.
My phone isn't making/answering calls.	The battery is not charged.	Charge the battery.
	The signal strength is poor.	If you are indoors, move toward a window.
I can't listen to my voice messages.	You don't have voice mail service.	Call your wireless service provider.
	You have not set up your voice mailbox with your service provider.	Call your wireless service provider.
	You have not saved your voice mail number in your phone.	Refer to "Use voice features" on page 59.
	The voice mail number you have saved is incorrect.	Call your wireless service provider.
	You have forgotten your password or are entering it incorrectly.	Call your wireless service provider.

21 Nokia One-Year Limited Warranty

Nokia Inc. ("Nokia") warrants that this cellular phone ("Product") is free from defects in material and workmanship that result in Product failure during normal usage, according to the following terms and conditions:

- 1 The limited warranty for the Product extends for ONE (1) year beginning on the date of the purchase of the Product. This one year period is extended by each whole day that the Product is out of your possession for repair under this warranty.
- 2 The limited warranty extends only to the original purchaser ("Consumer") of the Product and is not assignable or transferable to any subsequent purchaser/end- user.
- 3 The limited warranty extends only to Consumers who purchase the Product in the United States of America.
- 4 During the limited warranty period, Nokia will repair, or replace, at Nokia's sole option, any defective parts, or any parts that will not properly operate for their intended use with new or refurbished replacement items if such repair or replacement is needed because of product malfunction or failure during normal usage. No charge will be made to the Consumer for any such parts. Nokia will also pay for the labor charges incurred by Nokia in repairing or replacing the defective parts. The limited warranty does not cover defects in appearance, cosmetic, decorative or structural items, including framing, and any non-operative parts. Nokia's limit of liability under the limited warranty shall be the actual cash value of the Product at the time the Consumer returns the Product for repair, determined by the price paid by the Consumer for the Product less a reasonable amount for usage. Nokia shall not be liable for any other losses or damages. These remedies are the Consumer's exclusive remedies for breach of warranty.
- 5 Upon request from Nokia, the Consumer must prove the date of the original purchase of the Product by a dated bill of sale or dated itemized receipt.
- 6 The Consumer shall bear the cost of shipping the Product to Nokia in Melbourne, Florida. Nokia shall bear the cost of shipping the Product back to the Consumer after the completion of service under this limited warranty.

- 7 The Consumer shall have no coverage or benefits under this limited warranty if any of the following conditions are applicable:
 - a) The Product has been subjected to abnormal use, abnormal conditions, improper storage, exposure to moisture or dampness, unauthorized modifications, unauthorized connections, unauthorized repair, misuse, neglect, abuse, accident, alteration, improper installation, or other acts which are not the fault of Nokia, including damage caused by shipping.
 - b) The Product has been damaged from external causes such as collision with an object, or from fire, flooding, sand, dirt, windstorm, lightning, earthquake or damage from exposure to weather conditions, an Act of God, or battery leakage, theft, blown fuse, or improper use of any electrical source, damage caused by computer or internet viruses, bugs, worms, Trojan Horses, cancelbots or damage caused by the connection to other products not recommended for interconnection by Nokia.
 - c) Nokia was not advised in writing by the Consumer of the alleged defect or malfunction of the Product within fourteen (14) days after the expiration of the applicable limited warranty period.
 - d) The Product serial number plate or the accessory data code has been removed, defaced or altered.
 - e) The defect or damage was caused by the defective function of the cellular system or by inadequate signal reception by the external antenna, or viruses or other software problems introduced into the Product.
- 8 Nokia does not warrant uninterrupted or error-free operation of the Product. If a problem develops during the limited warranty period, the Consumer shall take the following step-by-step procedure:
 - a) The Consumer shall return the Product to the place of purchase for repair or replacement processing.
 - b) If "a" is not convenient because of distance (more than 50 miles) or for other good cause, the Consumer shall ship the Product prepaid and insured to:

Nokia Inc., Attn: Repair Department
795 West Nasa Blvd.
Melbourne, FL 32901
 - c) The Consumer shall include a return address, daytime phone number and/or fax number, complete description of the problem, proof of purchase and service agreement (if applicable). Expenses related to removing the Product from an installation are not covered under this limited warranty.

- d) The Consumer will be billed for any parts or labor charges not covered by this limited warranty. The Consumer will be responsible for any expenses related to reinstallation of the Product.
 - e) Nokia will repair the Product under the limited warranty within 30 days after receipt of the Product. If Nokia cannot perform repairs covered under this limited warranty within 30 days, or after a reasonable number of attempts to repair the same defect, Nokia at its option, will provide a replacement Product or refund the purchase price of the Product less a reasonable amount for usage. In some states the Consumer may have the right to a loaner if the repair of the Product takes more than ten (10) days. Please contact the Customer Service Center at Nokia at the telephone number listed at the end of this warranty if you need a loaner and the repair of the Product has taken or is estimated to take more than ten (10) days.
 - f) If the Product is returned during the limited warranty period, but the problem with the Product is not covered under the terms and conditions of this limited warranty, the Consumer will be notified and given an estimate of the charges the Consumer must pay to have the Product repaired, with all shipping charges billed to the Consumer. If the estimate is refused, the Product will be returned freight collect. If the Product is returned after the expiration of the limited warranty period, Nokia's normal service policies shall apply and the Consumer will be responsible for all shipping charges.
- 9 You (the consumer) understand that the product may consist of refurbished equipment that contains used components, some of which have been reprocessed. The used components comply with Product performance and reliability specifications.

- 10 ANY IMPLIED WARRANTY OF MERCHANTABILITY, OR FITNESS FOR A PARTICULAR PURPOSE OR USE, SHALL BE LIMITED TO THE DURATION OF THE FOREGOING LIMITED WRITTEN WARRANTY. OTHERWISE, THE FOREGOING LIMITED WARRANTY IS THE CONSUMER'S SOLE AND EXCLUSIVE REMEDY AND IS IN LIEU OF ALL OTHER WARRANTIES, EXPRESS OR IMPLIED. NOKIA SHALL NOT BE LIABLE FOR SPECIAL, INCIDENTAL, PUNITIVE OR CONSEQUENTIAL DAMAGES, INCLUDING BUT NOT LIMITED TO LOSS OF ANTICIPATED BENEFITS OR PROFITS, LOSS OF SAVINGS OR REVENUE, LOSS OF DATA, PUNITIVE DAMAGES, LOSS OF USE OF THE PRODUCT OR ANY ASSOCIATED EQUIPMENT, COST OF CAPITAL, COST OF ANY SUBSTITUTE EQUIPMENT OR FACILITIES, DOWNTIME, THE CLAIMS OF ANY THIRD PARTIES, INCLUDING CUSTOMERS, AND INJURY TO PROPERTY, RESULTING FROM THE PURCHASE OR USE OF THE PRODUCT OR ARISING FROM BREACH OF THE WARRANTY, BREACH OF CONTRACT, NEGLIGENCE, STRICT TORT, OR ANY OTHER LEGAL OR EQUITABLE THEORY, EVEN IF NOKIA KNEW OF THE LIKELIHOOD OF SUCH DAMAGES. NOKIA SHALL NOT BE LIABLE FOR DELAY IN RENDERING SERVICE UNDER THE LIMITED WARRANTY, OR LOSS OF USE DURING THE PERIOD THAT THE PRODUCT IS BEING REPAIRED.
- 11 Some states do not allow limitation of how long an implied warranty lasts, so the one year warranty limitation may not apply to you (the Consumer). Some states do not allow the exclusion or limitation of incidental and consequential damages, so certain of the above limitations or exclusions may not apply to you (the Consumer). This limited warranty gives the Consumer specific legal rights and the Consumer may also have other rights which vary from state to state.
- 12 Nokia neither assumes nor authorizes any authorized service center or any other person or entity to assume for it any other obligation or liability beyond that which is expressly provided for in this limited warranty including the provider or seller of any extended warranty or service agreement.
- 13 This is the entire warranty between the Nokia and the Consumer, and supersedes all prior and contemporaneous agreements or understandings, oral or written, relating to the Product, and no representation, promise or condition not contained herein shall modify these terms.
- 14 This limited warranty allocates the risk of failure of the Product between the Consumer and Nokia. The allocation is recognized by the Consumer and is reflected in the purchase price.
- 15 Any action or lawsuit for breach of warranty must be commenced within eighteen (18) months following purchase of the Product.

- 16 Questions concerning this limited warranty may be directed to:
Nokia Inc.
Attn: Customer Service
7725 Woodland Center Blvd., Ste. 150
Tampa, FL 33614
Telephone: 1-888-NOKIA-2U (1-888-665-4228)
Facsimile: (813) 287-6612
TTY/TDD Users Only: 1-800-24-NOKIA (1-800-246-6542)
- 17 The limited warranty period for Nokia supplied attachments and accessories is specifically defined within their own warranty cards and packaging.
Nokia is a registered trademark of Nokia Corporation.

Nokia One-Year Limited Warranty

DRAFT

NOTES

DRAFT

Appendix A Message from the CTIA

Appendix A

Message from the CTIA (Cellular Telecommunications & Internet Association) to all users of mobile phones.

© 2001 Cellular Telecommunications & Internet Association. All Rights Reserved. 1250 Connecticut Avenue, NW Suite 800, Washington, DC 20036.
Phone: (202) 785-0081

Safety is the most important call you will ever make.

A Guide to Safe and Responsible Wireless Phone Use

Tens of millions of people in the U.S. today take advantage of the unique combination of convenience, safety and value delivered by the wireless telephone. Quite simply, the wireless phone gives people the powerful ability to communicate by voice--almost anywhere, anytime--with the boss, with a client, with the kids, with emergency personnel or even with the police. Each year, Americans make billions of calls from their wireless phones, and the numbers are rapidly growing.

But an important responsibility accompanies those benefits, one that every wireless phone user must uphold. When driving a car, driving is your first responsibility. A wireless phone can be an invaluable tool, but good judgment must be exercised at all times while driving a motor vehicle--whether on the phone or not.

The basic lessons are ones we all learned as teenagers. Driving requires alertness, caution and courtesy. It requires a heavy dose of basic common sense--keep your head up, keep your eyes on the road, check your mirrors frequently and watch out for other drivers. It requires obeying all traffic signs and signals and staying within the speed limit. It means using seatbelts and requiring other passengers to do the same.

But with wireless phone use, driving safely means a little more. This brochure is a call to wireless phone users everywhere to make safety their first priority when behind the wheel of a car. Wireless telecommunications is keeping us in touch, simplifying our lives, protecting us in emergencies and providing opportunities to help others in need. When it comes to the use of wireless phones, *safety is your most important call.*

Wireless Phone "Safety Tips"

Below are safety tips to follow while driving and using a wireless phone which should be easy to remember.

- 1 Get to know your wireless phone and its features such as speed dial and redial. Carefully read your instruction manual and learn to take advantage of valuable features most phones offer, including automatic redial and memory. Also, work to memorize the phone keypad so you can use the speed dial function without taking your attention off the road.
- 2 When available, use a hands free device. A number of hands free wireless phone accessories are readily available today. Whether you choose an installed mounted device for your wireless phone or a speaker phone accessory, take advantage of these devices if available to you.
- 3 Position your wireless phone within easy reach. Make sure you place your wireless phone within easy reach and where you can grab it without removing your eyes from the road. If you get an incoming call at an inconvenient time, if possible, let your voice mail answer it for you.
- 4 Suspend conversations during hazardous driving conditions or situations. Let the person you are speaking with know you are driving; if necessary, suspend the call in heavy traffic or hazardous weather conditions. Rain, sleet, snow and ice can be hazardous, but so is heavy traffic. As a driver, your first responsibility is to pay attention to the road.

DRAFT

Appendix A Message from the CTIA

- 5 Do not take notes or look up phone numbers while driving. If you are reading an address book or business card, or writing a "to do" list while driving a car, you are not watching where you are going. It's common sense. Don't get caught in a dangerous situation because you are reading or writing and not paying attention to the road or nearby vehicles.
- 6 Dial sensibly and assess the traffic; if possible, place calls when you are not moving or before pulling into traffic. Try to plan your calls before you begin your trip or attempt to coincide your calls with times you may be stopped at a stop sign, red light or otherwise stationary. But if you need to dial while driving, follow this simple tip--dial only a few numbers, check the road and your mirrors, then continue.
- 7 Do not engage in stressful or emotional conversations that may be distracting. Stressful or emotional conversations and driving do not mix--they are distracting and even dangerous when you are behind the wheel of a car. Make people you are talking with aware you are driving and if necessary, suspend conversations which have the potential to divert your attention from the road.
- 8 Use your wireless phone to call for help. Your wireless phone is one of the greatest tools you can own to protect yourself and your family in dangerous situations--with your phone at your side, help is only three numbers away. Dial 9-1-1 or other local emergency number in the case of fire, traffic accident, road hazard or medical emergency. Remember, it is a free call on your wireless phone!
- 9 Use your wireless phone to help others in emergencies. Your wireless phone provides you a perfect opportunity to be a "Good Samaritan" in your community. If you see an auto accident, crime in progress or other serious emergency where lives are in danger, call 9-1-1 or other local emergency number, as you would want others to do for you.
- 10 Call roadside assistance or a special wireless non-emergency assistance number when necessary. Certain situations you encounter while driving may require attention, but are not urgent enough to merit a call for emergency services. But you still can use your wireless phone to lend a hand. If you see a broken-down vehicle posing no serious hazard, a broken traffic signal, a minor traffic accident where no one appears injured or a vehicle you know to be stolen, call roadside assistance or other special non-emergency wireless number.

Careless, distracted individuals and people driving irresponsibly represent a hazard to everyone on the road. Since 1984, the Cellular Telecommunications Industry Association and the wireless industry have conducted educational outreach to inform wireless phone users of their responsibilities as safe drivers and good citizens. As we approach a new century, more and more of us will take advantage of the benefits of wireless telephones. And, as we take to the roads, we all have a responsibility to drive safely.

The wireless industry reminds you to use your phone safely when driving.
For more information, please call 1-888-901-SAFE.
For updates: [http://www.wow-com.com/consumer/issues/driving/
articles.cfm?ID=85](http://www.wow-com.com/consumer/issues/driving/articles.cfm?ID=85)

© 2001 Cellular Telecommunications & Internet Association. All Rights Reserved. 1250 Connecticut Avenue, NW Suite 800, Washington, DC 20036.
Phone: (202) 785-0081

DRAFT

Appendix B Message from the FDA

Appendix B
Message from the FDA
(U.S. Food and Drug
Administration)
to all users of mobile phones.

July 18, 2001 For updates: <http://www.fda.gov/cdrh/phones>

Consumer Update on Wireless Phones
U.S. Food and Drug Administration

1. Do wireless phones pose a health hazard?

The available scientific evidence does not show that any health problems are associated with using wireless phones. There is no proof, however, that wireless phones are absolutely safe. Wireless phones emit low levels of radiofrequency energy (RF) in the microwave range while being used. They also emit very low levels of RF when in the stand-by mode. Whereas high levels of RF can produce health effects (by heating tissue), exposure to low level RF that does not produce heating effects causes no known adverse health effects. Many studies of low level RF exposures have not found any biological effects. Some studies have suggested that some biological effects may occur, but such findings have not been confirmed by additional research. In some cases, other researchers have had difficulty in reproducing those studies, or in determining the reasons for inconsistent results.

2. What is FDA's role concerning the safety of wireless phones?

Under the law, FDA does not review the safety of radiation-emitting consumer products such as wireless phones before they can be sold, as it does with new drugs or medical devices. However, the agency has authority to take action if wireless phones are shown to emit radiofrequency energy (RF) at a level that is hazardous to the user. In such a case, FDA could require the manufacturers of wireless phones to notify users of the health hazard and to repair, replace or recall the phones so that the hazard no longer exists.

Although the existing scientific data do not justify FDA regulatory actions, FDA has urged the wireless phone industry to take a number of steps, including the following:

- Support needed research into possible biological effects of RF of the type emitted by wireless phones;
- Design wireless phones in a way that minimizes any RF exposure to the user that is not necessary for device function; and
- Cooperate in providing users of wireless phones with the best possible information on possible effects of wireless phone use on human health.

FDA belongs to an interagency working group of the federal agencies that have responsibility for different aspects of RF safety to ensure coordinated efforts at the federal level. The following agencies belong to this working group:

- National Institute for Occupational Safety and Health
- Environmental Protection Agency
- Federal Communications Commission
- Occupational Safety and Health Administration
- National Telecommunications and Information Administration

The National Institutes of Health participates in some interagency working group activities, as well.

FDA shares regulatory responsibilities for wireless phones with the Federal Communications Commission (FCC). All phones that are sold in the United States must comply with FCC safety guidelines that limit RF exposure. FCC relies on FDA and other health agencies for safety questions about wireless phones. FCC also regulates the base stations that the wireless phone networks rely upon. While these base stations operate at higher power than do the wireless phones themselves, the RF exposures that people get from these base stations are typically thousands of times lower than those they can get from wireless phones. Base stations are thus not the subject of the safety questions discussed in this document.

DRAFT

3. What kinds of phones are the subject of this update?

The term wireless phone refers here to hand-held wireless phones with built-in antennas, often called cell mobile or PCS phones. These types of wireless phones can expose the user to measurable radiofrequency energy (RF) because of the short distance between the phone and the user's head. These RF exposures are limited by Federal Communications Commission safety guidelines that were developed with the advice of FDA and other federal health and safety agencies. When the phone is located at greater distances from the user, the exposure to RF is drastically lower because a person's RF exposure decreases rapidly with increasing distance from the source. The so-called cordless phones, which have a base unit connected to the telephone wiring in a house, typically operate at far lower power levels, and thus produce RF exposures far below the FCC safety limits.

4. What are the results of the research done already?

The research done thus far has produced conflicting results, and many studies have suffered from flaws in their research methods. Animal experiments investigating the effects of radiofrequency energy (RF) exposures characteristic of wireless phones have yielded conflicting results that often cannot be repeated in other laboratories. A few animal studies, however, have suggested that low levels of RF could accelerate the development of cancer in laboratory animals. However, many of the studies that showed increased tumor development used animals that had been genetically engineered or treated with cancer-causing chemicals so as to be predisposed to develop cancer in the absence of RF exposure. Other studies exposed the animals to RF for up to 22 hours per day. These conditions are not similar to the conditions under which people use wireless phones, so we don't know with certainty what the results of such studies mean for human health.

Three large epidemiology studies have been published since December 2000. Between them, the studies investigated any possible association between the use of wireless phones and primary brain cancer, glioma, meningioma, or acoustic neuroma, tumors of the brain or salivary gland, leukemia, or other cancers. None of the studies demonstrated the existence of any harmful health effects from wireless phone RF exposures. However, none of the studies can answer questions about long-term exposures, since the average period of phone use in these studies was around three years.

5. What research is needed to decide whether RF exposure from wireless phones poses a health risk?

A combination of laboratory studies and epidemiological studies of people actually using wireless phones would provide some of the data that are needed. Lifetime animal exposure studies could be completed in a few years. However, very large numbers of animals would be needed to provide reliable proof of a cancer promoting effect if one exists. Epidemiological studies can provide data that is directly applicable to human populations, but 10 or more years follow-up may be needed to provide answers about some health effects, such as cancer. This is because the interval between the time of exposure to a cancer-causing agent and the time tumors develop - if they do - may be many, many years. The interpretation of epidemiological studies is hampered by difficulties in measuring actual RF exposure during day-to-day use of wireless phones. Many factors affect this measurement, such as the angle at which the phone is held, or which model of phone is used.

6. What is FDA doing to find out more about the possible health effects of wireless phone RF?

FDA is working with the U.S. National Toxicology Program and with groups of investigators around the world to ensure that high priority animal studies are conducted to address important questions about the effects of exposure to radiofrequency energy (RF).

FDA has been a leading participant in the World Health Organization International Electromagnetic Fields (EMF) Project since its inception in 1996. An influential result of this work has been the development of a detailed agenda of research needs that has driven the establishment of new research programs around the world. The Project has also helped develop a series of public information documents on EMF issues.

FDA and the Cellular Telecommunications & Internet Association (CTIA) have a formal Cooperative Research and Development Agreement (CRADA) to do research on wireless phone safety. FDA provides the scientific oversight, obtaining input from experts in government, industry, and academic organizations. CTIA-funded research is conducted through contracts to independent investigators. The initial research will include both laboratory studies and studies of wireless phone users. The CRADA will also include a broad assessment of additional research needs in the context of the latest research developments around the world.

7. How can I find out how much radiofrequency energy exposure I can get by using my wireless phone?

All phones sold in the United States must comply with Federal Communications Commission (FCC) guidelines that limit radiofrequency energy (RF) exposures. FCC established these guidelines in consultation with FDA and the other federal health and safety agencies. The FCC limit for RF exposure from wireless telephones is set at a Specific Absorption Rate (SAR) of 1.6 watts per kilogram (1.6 W/kg). The FCC limit is consistent with the safety standards developed by the Institute of Electrical and Electronic Engineering (IEEE) and the National Council on Radiation Protection and Measurement. The exposure limit takes into consideration the body's ability to remove heat from the tissues that absorb energy from the wireless phone and is set well below levels known to have effects.

Manufacturers of wireless phones must report the RF exposure level for each model of phone to the FCC. The FCC website (<http://www.fcc.gov/oet/rfsafety>) gives directions for locating the FCC identification number on your phone so you can find your phone's RF exposure level in the online listing.

8. What has FDA done to measure the radiofrequency energy coming from wireless phones?

The Institute of Electrical and Electronic Engineers (IEEE) is developing a technical standard for measuring the radiofrequency energy (RF) exposure from wireless phones and other wireless handsets with the participation and leadership of FDA scientists and engineers. The standard, Recommended Practice for Determining the Spatial-Peak Specific Absorption Rate (SAR) in the Human Body Due to Wireless Communications Devices: Experimental Techniques, sets forth the first consistent test methodology for measuring the rate at which RF is deposited in the heads of wireless phone users. The test method uses a tissue-simulating model of the human head. Standardized SAR test methodology is expected to greatly improve the consistency of measurements made at different laboratories on the same phone. SAR is the measurement of the amount of energy absorbed in tissue, either by the whole body or a small part of the body. It is measured in watts/kg (or milliwatts/g) of matter. This measurement is used to determine whether a wireless phone complies with safety guidelines.

9. What steps can I take to reduce my exposure to radiofrequency energy from my wireless phone?

If there is a risk from these products--and at this point we do not know that there is--it is probably very small. But if you are concerned about avoiding even potential risks, you can take a few simple steps to minimize your exposure to radiofrequency energy (RF). Since time is a key factor in how much exposure a person receives, reducing the amount of time spent using a wireless phone will reduce RF exposure.

If you must conduct extended conversations by wireless phone every day, you could place more distance between your body and the source of the RF, since the exposure level drops off dramatically with distance. For example, you could use a headset and carry the wireless phone away from your body or use a wireless phone connected to a remote antenna.

Again, the scientific data do not demonstrate that wireless phones are harmful. But if you are concerned about the RF exposure from these products, you can use measures like those described above to reduce your RF exposure from wireless phone use.

10. What about children using wireless phones?

The scientific evidence does not show a danger to users of wireless phones, including children and teenagers. If you want to take steps to lower exposure to radiofrequency energy (RF), the measures described above would apply to children and teenagers using wireless phones.

Reducing the time of wireless phone use and increasing the distance between the user and the RF source will reduce RF exposure. Some groups sponsored by other national governments have advised that children be discouraged from using wireless phones at all. For example, the government in the United Kingdom distributed leaflets containing such a recommendation in December 2000. They noted that no evidence exists that using a wireless phone causes brain tumors or other ill effects. Their recommendation to limit wireless phone use by children was strictly precautionary; it was not based on scientific evidence that any health hazard exists.

11. What about wireless phone interference with medical equipment?

Radiofrequency energy (RF) from wireless phones can interact with some electronic devices. For this reason, FDA helped develop a detailed test method to measure electromagnetic interference (EMI) of implanted cardiac pacemakers and defibrillators from wireless telephones. This test method is now part of a standard sponsored by the Association for the Advancement of Medical Instrumentation (AAMI). The final draft, a joint effort by FDA, medical device manufacturers, and many other groups, was completed in late 2000. This standard will allow manufacturers to ensure that cardiac pacemakers and defibrillators are safe from wireless phone EMI. FDA has tested hearing aids for interference from handheld wireless phones and helped develop a voluntary standard sponsored by the Institute of Electrical and Electronic Engineers (IEEE). This standard specifies test methods and performance requirements for hearing aids and wireless phones so that no interference occurs when a person uses a compatible phone and a accompanied hearing aid at the same time. This standard was approved by the IEEE in 2000. FDA continues to monitor the use of wireless phones for possible interactions with other medical devices. Should harmful interference be found to occur, FDA will conduct testing to assess the interference and work to resolve the problem.

12. Where can I find additional information?

For additional information, please refer to the following resources:

- FDA web page on wireless phones
<http://www.fda.gov/cdrh/phones/index.html>
- Federal Communications Commission (FCC) RF Safety Program
<http://www.fcc.gov/oet/rfsafety>
- International Commission on Non-Ionizing Radiation Protection
<http://www.icnirp.de>
- World Health Organization (WHO) International EMF Project
<http://www.who.int/emf>
- National Radiological Protection Board (UK)
<http://www.nrpb.org.uk/>

July 18, 2001 For updates: <http://www.fda.gov/cdrh/phones>

Index – Draft

Numerics

1-touch dialing

- assigning a number 52
- change a 1-touch number 52
- delete a 1-touch number 52

A

ABC mode 34

accessibility solutions 9

accessibility website 9

accessible features 9

accessory

- battery charging stand 149
- car kit 151
- charging stand 149
- headset kit 149
- loopset 10
- mobile charger 148
- rapid travel charger 147
- standard travel charger 147
- TTY adapter 10

active call options

- activate/cancel call waiting 55
- answer a waiting call 56
- end the active call 56
- reject a waiting call 56
- switch between calls 56
- third call waiting 56

adapter

- for TTY connection 10

advertisements

- block reception 104

- receive multimedia message 103

alarm clock 119

- delay alarm 119
- snooze 119
- symbol 21

allow multimedia reception 103

answer a call 24

answer call with any key 53

answer waiting call 56

antenna

- contact 19
- how to hold the phone 19
- location 19
- performance 19

anykey answer 53

applications

- launch, open 134

audible alerts 64

authority certificates 112

automatic keyguard

- delay time 83

B

battery

- charge 15
- check strength 20
- empty 15
- indication on screen 20
- install 17
- power 20
- recycle 138
- remove 16
- temperature range 138

- battery low indication 137
- block incoming messages 103
- block international calls 87
- block multimedia messages 103
- bookmark
 - set while browsing 111
- bookmarks 111
- browser
 - use bookmarks 111
- browser options 110
- business cards 120
 - send as text message 120
 - sending 120

C

- cache memory 112
- calculator 121
- calendar 116
 - make a note 116, 118
- call forwarding 54
- call on hold
 - symbol 21
- call restrictions
 - cancel 87
- call timers 47
- call waiting 30, 55
- caller group
 - icon 22
- caller groups
 - add names 76
 - assign ringing tone 78
 - graphics 78
 - remove names 77

- rename 78
- caller ID 24, 30
- car kit
 - icon 22
- car profile 68
- check volume 20
- clock
 - 12 hour 73
 - 24 hour 73
 - alarm 119
 - display the clock 74
 - set the clock 73
- closed user groups 88
- code
 - default security code 86
 - personal unblocking key 85
 - PIN 84
 - restriction password 84
 - security code 84
- conference calls 57
- convert currency 122
- covers, changing 80

D

- data call history 48
- default security code 86
- delete
 - phone book entries 44
- Desktop Charging Stand 149
- dictionary
 - add word 37
- disconnect from mobile Internet 112

display language 72
downloading ringing tones 71

E

e-mail
send 96, 97
set up sending profile 96
e-mail address
save 40
emergency call
make while using GPRS 115
end a call 24
END key 24
enter characters 34
enter letters
ABC mode 34
entering letters and numbers
special characters 35
standard text input 34
erase message 105

F

factory settings
default settings 79
file size 105
file type 105
fixed dialing 86

G

games 133
Airglider 133
Backgammon 133
Bowling 133

Skydiver 133
use cover 134

gaming cover 134

GPRS 108

call history 45
check data call history 45
make a call while online 115
phone symbols 113
receive a call while online 114

graphics

associate with caller group 78

H

handsfree operation 62

headset

connect 16
icon 22
make and answer calls 17
set up 16
use 17

Headset Kit 149

help text 73

I

icons 20

idle screen 19

in-call options

access the phone book 51
conference calls 57
make a new call 51
put a call on hold 51

information message service
107

install SIM card 13

[instant messaging 105](#)

[international call 51](#)

[international calls](#)

prefix 36

restrict access 87

[Internet](#)

connect with your phone 109

J

[Java midlets 134](#)

K

[keyguard 83](#)

automatic 83

delay time 83

symbol 21

[keypad](#)

avoid accidental keypresses 83

lock 83

[keys and features](#)

bottom 18

L

[label 11](#)

[language 72](#)

English 72

French 72

phone support 72

Spanish 72

[lights](#)

keypad and display 18

[line for outgoing calls 30](#)

[lock codes](#)

PIN codes 84

PUK codes 85

[loopset 10](#)

profile 69

set as default 69

[LPS-3 10](#)

M

[make a call 23](#)

use the phone book 23

[make an emergency call while](#)

[online 115](#)

[make an international call 51](#)

[memory](#)

available for multimedia

messages 102

available for names in phone

book 42

choose memory type for phone

book entry 43

default memory for phone book

43

phone 42

shared 11

[menus](#)

list of items 27

[message settings](#)

message center number 89

message mode 90

[messages](#)

check text messages 93

check voice mail 60

[MIDI 71](#)

[MIDI tones 71](#)

midlets 134

- launch application 134

MMS 102

- allow advertisements 103
- block advertisements 104
- connection settings 104
- delete message 105
- discard a message 104
- maximum size 102
- multimedia inbox 102
- play sound clip 105
- ringing tone 102
- save message 105
- save MIDI tone 105
- save received graphic 105
- save ringing tone 105
- screen saver 102
- sender information 105
- settings 103
- turn off 103
- view a message 104

Mobile Charger 148

mobile Internet

- clear the cache 112
- security issues 112
- sign off 112
- sign on 109

mobile Internet site

- examples 111
- how to read 111

multimedia inbox 102

multimedia messages 102

N

network services 30

- call forwarding 30, 54
- call waiting 55
- caller ID 53
- choose outgoing line 53
- conference call 57
- system selection 55
- transfer a call 58

Nokia Customer Care

- phone information 11

O

online help 73

onscreen help 73

P

phone

- check signal 20
- frequency bands 153
- illustrated 4
- operating voltage 153
- transmitting power 153
- turn on 18

phone book

- add entry 34
- delete names and numbers 43
- features 33
- find names 41
- make a call 23
- menu 33
- options 33

phone label 11

phone size 153

- phone symbols 20
- phone weight 153
- picture messages
 - sending with text 101
 - viewing 101
- PIN code 85
- play MIDI tone 105
- polyphonic sound 71
- power button
 - location 18
- predictive text input 36
 - add word 37
 - language support 36
 - shortcuts 38
 - turn off 37
 - turn on 36
 - use keys 38
- profiles
 - car kit 68
 - customizing 65
 - for accessories 67
 - handsfree 68
 - loopset 69
 - timed 67
 - TTY 69
- PUK code 85
- punctuation
 - how to enter 35
- R**
- Rapid Travel Charger 147
- receive multimedia messages 102

- reception 20
- redial a call 25
- reject a call 24
- remove battery 16
- remove SIM card 17
- restore factory settings 79
- restrict calls 87
- ringing tones
 - download 71
 - receive from network 71
- ringing tones
 - polyphonic sound 71

S

- scroll bar 26
- security code 84
 - default 86
- security features
 - automatic keyguard 83
 - keyguard 83
 - personal unblocking key 85
 - PIN code 85
 - prevent unauthorized use 85
 - PUK code 85
 - require password 85
 - restrict calls 87
- service command editor 107
- settings
 - MMS connection sets 104
 - MMS, multimedia 103
- signal strength indicator 20
- SIM 42
- SIM card 13

- avoid damage 13
- handling 13
- install 13
- remove 17
- [SIM card feature](#)
 - fixed dialing 86
- [SIM memory](#)
 - icon 22
- [speed-dial 52](#)
- [Standard Travel Charger 147](#)
- [start screen 19](#)
- [stopwatch 123](#)
 - measure lap time 124
 - measure split time 123
 - stop the clock 124
- [swap between two calls 56](#)
- [system selection 30](#)

T

- [T9 36](#)
- [talk key 23](#)
- [technical information 153](#)
- [text clues 6](#)
- [text message](#)
 - copy to calendar 95
- [text messages](#)
 - reading 93
 - resending 93
 - send to single recipient 91
 - sending 92
 - set up 89
 - use GPRS 91

[time](#)

- [receive network update 74](#)
- [time format 73](#)
- [to-do note 122](#)
- [touch tones](#)
 - send pause 36
- [track](#)
 - online usage 48
 - wireless Internet usage 48
- [troubleshooting 154](#)
- [TTY](#)
 - connection between phone and TTY Device 69
 - end a call 71
 - make a call 70
 - receive a call 71
- [TTY adapter 10](#)
- [TTY communication 10](#)
- [TTY connection](#)
 - icon 22
- [TTY settings 69](#)

U

- [update date and time 74](#)
- [use two phone lines 56](#)
- [user guide](#)
 - alternate formats 9
 - updates 6
- [user guide conventions 6](#)

V

- [voice commands 62](#)
- [voice dialing](#)
 - add a voice tag 60

- change a voice tag 62
- delete a voice tag 62
- make a call with voice recognition 61
- play back a voice tag 61
- [voice mail](#)
 - listen to your messages 59
 - save the mailbox number 59
- [volume 20](#)
 - adjust 20
 - check level on screen 20
 - decrease 24
 - earpiece 20
 - increase 24
 - keypad tones 65

W

- [WAP 108](#)
- [WAP browser 110](#)
 - use phone keys 110
- [WAP page](#)
 - active link 111
 - enter information 111
 - examples 111
 - header line 111
- [welcome note 72](#)
- [wireless network services 9](#)
- [write messages](#)
 - with built-in dictionary 36
- [www.nokiaaccessibility.com 9](#)

X

- [Xpress-on color cover 80](#)