

THE APPLICANT HAS BEEN CAUTIONED AS TO THE FOLLOWING:

15.21 INFORMATION TO USER.

The users manual or instruction manual for an intentional radiator shall caution the user that changes or modifications not expressly approved by the party responsible for compliance could void the user's authority to operate the equipment.

15.27(a) SPECIAL ACCESSORIES.

Equipment marketed to a consumer must be capable of complying with the necessary regulations in the configuration in which the equipment is marketed. Where special accessories, such as shielded cables and/or special connectors are required to enable an unintentional or intentional radiator to comply with the emission limits in this part, the equipment must be marketed with, i.e. shipped and sold with, those special accessories. However, in lieu of shipping or packaging the special accessories with the unintentional or intentional radiator, the responsible party may employ other methods of ensuring that the special accessories are provided to the consumer, without additional charge.

Information detailing any alternative method used to supply the special accessories for a grant of equipment authorization or retained in the verification records, as appropriate. The party responsible for the equipment, as detailed in § 2.909 of this chapter, shall ensure that these special accessories are provided with the equipment. The instruction manual for such devices shall include appropriate instructions on the first page of text concerned with the installation of the device that these special accessories must be used with the device. It is the responsibility of the user to use the needed special accessories supplied with the equipment.

Nokia 6161

User Guide

Final Version

Note: This User Guide describes functionality planned for the HD963 final product, and may vary from the HD963 prototype provided with this User Guide.

Inclusion of items in this User Guide does not imply or guarantee inclusion in the HD963 final product. Nokia Mobile Phones reserves the right to make changes and improvements to HD963 and this User Guide without prior notice.

Quick guide to the menu

Back one level - Press **Back**

Entering the menu - From start screen, press **Menu**

Exiting the menu - Press **Exit** or **Back** repeatedly, or press **END**

Scrolling the menu - Press **Menu**, then **▼** or **▲**

















Selecting a submenu or option - Press **Select** or **OK**

Using shortcuts - Press **Menu**, then menu number, then submenu number

Menu summary:

- 1 Messages**
 - 1 Text messages
 - 2 Voice messages
 - 3 Welcome note
- 2 Call log**
 - 1 Missed calls
 - 2 Dialed calls
 - 3 Received calls
 - 4 Clear call lists
 - 5 Call timers
- 3 Profiles**
 - 1 Normal
 - 2 Silent
 - 3 Meeting
 - 4 Outdoor
 - 5 Pager
 - 6 Car (once phone is connected to a car kit)
 - 7 Headset (once phone is connected to a headset)
- 4 Settings**
 - 1 Call settings
 - 2 Phone settings
 - 3 Security settings
 - 4 Network services
- 5 System**
 - 1 Automatic
 - 2 Manual
 - 3 New search
- 6 Games**
- 7 Calculator**
- 8 Calendar**
- 9 Keyguard**

Indicators and icons

- | | |
|---|--|
|  | You have an active call. |
|  | The phone is waiting for you to enter a response. |
|  | Ring tones for the current profile has been set to Silent . |
|  | Keyguard has been activated to help prevent any accidental keypresses. |
|  | You have one or more voice messages waiting. |
|  | You have one or more unread text messages waiting. |
|  | Digital service is available. |
|  | Any characters you enter will be upper-case letters or numbers. Press the # key to switch letter case. |
|  | Any characters you enter will be lower-case letters or numbers. Press the # key to switch letter case. |
|  | This appears when you press and hold the # key when storing names. Letters can not be entered when this appears, allowing quicker access to numbers. |
|  | You are in "special character" mode; select a special character and press Insert . (When entering letters, you can switch to this mode by pressing the * key) |
|  | The alarm clock is set. |
|  | You have a reminder in your calendar to do something (appears only on Calendar display) |
|  | You have a reminder in your calendar that it's someone's birthday (appears only on Calendar display). |
|  | You have a reminder in your calendar to call someone (appears only on Calendar display). |
|  | You have a reminder in your calendar of a meeting (appears only on Calendar display). |

2. Getting Connected

So you've just bought your new phone, taken it out of the box, and you're wondering what to do next. Well, this chapter will help get you started.

Installing your battery

Simply place the battery in the grooves on the back of your phone. Then slide the battery upward until it clicks.

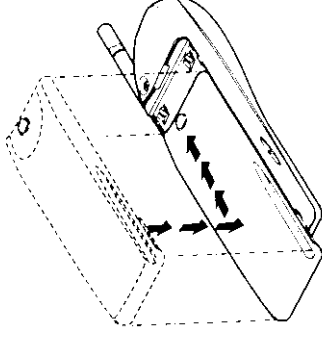

Note: Use only those batteries approved by the phone manufacturer and recharge your battery only with the chargers approved by the manufacturer.

See "Important Battery Information" on page 10

Charging your new battery

Your phone is powered by a rechargeable Li-Ion or NiMH battery, which should be charged for 24 hours before you use it for the first time. Note that a new battery's full performance is achieved only after two or three complete charge and discharge cycles.

With your phone on or off, simply connect the lead from the charger to the bottom of your phone or place it on a charging stand. Then connect the charger to a standard 120V AC outlet.

When the battery begins charging, your phone will beep once and the battery strength indicator on the right side of the display will scroll.

FCC/Industry Canada Notice

Your phone may cause TV or radio interference (e.g. when using a telephone in close proximity to receiving equipment). The FCC/Industry Canada can require you to stop using your telephone if such interference can not be eliminated. If you require assistance, contact your local service facility.

This device complies with part 15 of the FCC rules. Operation is subject to the condition that this device does not cause harmful interference.

Using this Guide

The wireless phone described in this guide is approved for use in TDMA/AMPS networks.

A number of features included in this guide are called Network Services. They are special services provided by wireless service providers. Before you can take advantage of any of these Network Services, you must subscribe to the service(s) from your home service provider and obtain instructions for their use.

Disclaimer

It's possible that you may not be able to activate your phone on all wireless systems. Please see your service provider for details.

3. The Basics

Your phone is designed with many powerful features that you can learn to use as needed. This chapter covers the basic information you need to use your phone. A more comprehensive description of your phone is covered in "Your Phone A to Z" starting on page 21.

Switching on the phone

Press and hold the  key for two seconds to switch on the phone.

NORMAL POSITION: Hold the phone as you would any other telephone with the antenna pointed up and over your shoulder.

TIPS ON EFFICIENT OPERATION: As with any other radio transmitting device, do not touch the antenna unnecessarily when the phone is switched on. Contact with the antenna affects call quality and may cause the phone to operate at a higher power level than otherwise needed.

WARNING! Do not switch on the phone when wireless phone use is prohibited or when it may cause interference or danger.

See "Safety At A Glance" on page 6 for more information.

Checking signal strength

Your phone operates on radio waves, and the quality of radio reception depends entirely on the strength of the radio signal in your area.

This radio coverage is maintained by a wireless network and the quality of calls on a wireless phone depends on the strength of the wireless radio signal.

Get a strong signal

When you are at the start screen (see page 17) or in a call, the strength of the radio signal is indicated by the signal indicators on the left side of your phone's display. These indicators scroll as the strength of the signal increases and decreases.

Increasing your phone's signal may be easy. Try moving

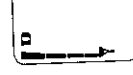

- after two or three complete charge and discharge cycles!
- The battery can be charged and discharged hundreds of times but it will eventually wear out. When the operating time (talk time and standby time) is noticeably shorter than normal, it is time to buy a new battery.
- Use only batteries approved by the phone manufacturer and recharge your battery only with the chargers approved by the manufacturer. When a charger is not in use, disconnect it from the power source. Do not leave the battery connected to a charger for longer than a week, since overcharging may shorten its life. If left unused a fully charged battery will discharge itself over time.
- (NiMH batteries only) For good operation times, discharge the battery from time to time by leaving your phone switched on until it turns itself off (or by using the battery discharge facility of any approved accessory available for your phone). Do not attempt to discharge the battery by any other means.
- Temperature extremes will affect the ability of your battery to charge: allow it to cool down or warm up first.
- Use the battery only for its intended purpose.
- Never use any charger or battery which is damaged or worn out.
- Do not short circuit the battery. Accidental short circuiting can occur when a metallic object (coin, clip, or pen) causes direct connection of the + and - terminals of the battery (metal strips on the back of the battery), for example when you carry a spare battery in your pocket or purse. Short circuiting the terminals may damage the battery or the connecting object.
- Leaving the battery in hot or cold places, such as in a closed car in summer or winter conditions, will reduce the capacity and lifetime of the battery. Always try to keep the battery between 59 F and 77 F (15 C and 25 C). A phone with a hot or cold battery may temporarily not work, even when the battery is fully charged. NiMH batteries' performance is particularly limited in temperatures below 14 F (-10 C). Li-ion batteries' performance is particularly limited in temperatures below 32 F (-0 C).
- Do not dispose of batteries in a fire!
- Batteries must be recycled or disposed of properly. Must not be disposed of in municipal waste.

4. Working The Menu

Your phone contains several menus and submenus, giving you access to certain options and allowing you to customize your phone to suit your individual needs.

This section describes several different tools your phone uses to access many of its features. Once you have mastered these tools, using your phone should be easier than ever.

Navigating tools

Softkeys

Your phone has two softkeys that appear below the display. Their current function is indicated by the words appearing above them. Simply press the corresponding key under the choice you wish to select.

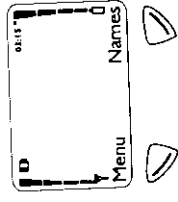

This illustration shows the phone at the start screen (see "What is the 'start screen'?" on page 17). The start screen always displays **Menu** on the left and **Names** on the right. **Menu** allows you to access your phone's menus and submenus. **Names** allows you to access your phone book (see "Phone book" on page 53).

Scroll button

Your phone has a scroll button located just below the display screen. The scroll button has two arrows on it that look like ▲ and ▼. Press these arrows to navigate through your phone's menus and submenus, as well as through your phone book (See "Phone book" on page 53).

- 1) Press **Menu 9 (Keyguard)**
- 2) **Keys locked** will appear on the display

Deactivating Keyguard

Press **Unlock**, then *

Keyguard can not be activated when your phone is in a car kit or in any handsfree kit.

*Note: When Keyguard is ON, calls to the emergency number programmed into your phone (e.g. by pressing 911 then **TALK**) may be possible. However, Emergency key 9 doesn't work.*

Answering a call with Keyguard active

During an incoming call the keypad automatically unlocks. However, you can answer a call only by opening the keypad cover if it's active; otherwise, press only **TALK**. After you end the call, Keyguard automatically becomes active again.

Some notes about Keyguard

- Calls may be possible to the emergency number programmed into your phone (e.g. 911 or other official emergency number). The number is displayed only after you have keyed in its last digit.
- Pressing the **END** key quickly turns lights on for 15 seconds.
- Keyguard is automatically turned off when the phone is connected to a car kit.

Summary of Menu Items

1 Messages

- 1 1 Text Messages
 - 1 1 1 Inbox
 - 1 1 2 Saved
- 1 2 Voice messages
 - 1 2 1 Listen to voice messages
 - 1 2 2 Voice mailbox number

1 3 Welcome Note

2 Call log

- 2 1 Missed calls
- 2 2 Dialed calls
- 2 3 Received calls
- 2 4 Clear call lists
- 2 5 Call timers

3 Profiles

- 3 1 Normal
- 3 2 Silent
- 3 3 Meeting
- 3 4 Outdoor
- 3 5 Pager
- 3 6 Car *(once used with car kit)*
- 3 7 Headset *(once used with headset)*

4 Settings

- 4 1 Call settings
 - 4 1 1 Emergency key 9
 - 4 1 2 Automatic redial
 - 4 1 3 Calling card
- 4 2 Phone settings
 - 4 2 1 Clock
 - 4 2 2 Alarm clock
 - 4 2 3 Touch tones
 - 4 2 4 Restore factory settings
 - 4 2 5 Language

- 4 2 6 Keypad cover setting
- 4 3 Security settings
 - 4 3 1 Restrict calls
 - 4 3 2 Access codes
- 4 4 Network services
 - 4 4 1 Voice privacy
 - 4 4 2 Call forwarding
 - 4 4 3 Call waiting
 - 4 4 4 Send own number
 - 4 4 5 Network feature setting
 - 4 4 6 NAM selection

5 System

- 5 1 Automatic
- 5 2 Manual
- 5 3 New search

6 Games

- 6 1 Memory
- 6 2 Snake
- 6 3 Logic
- 6 4 Dice

7 Calculator

8 Calendar

9 Keyguard

- 4) Enter the second number. Repeat these steps as many times as needed. Press **Clear** to erase any mistakes.

- 5) Press **Options**. With **Equals** highlighted, press **OK**

Note: You can also choose Add, Subtract, Multiply, and Divide from the list of options.

Storing exchange rates

- 1) Press **Menu 7**, then press **Options**
- 2) Press **OK** at **Exchange rate**
- 3) Press **▼** or **▲** at either **How many home units to a visited unit** or **How many visited units to a home unit**, depending on how you wish to convert the currency. Press **OK** once you decide.
- 4) Enter the appropriate exchange rate and press **OK** (use the **#** key for decimals)
- 5) Phone will display **Rate saved**

Calculating exchange rates

- 1) Press **Menu 7**
- 2) Enter number of units, then press **Options**
- 3) Press **▼** or **▲** to either **To home** or **To visited**, and press **OK**
- 4) Converted currency will display

Calendar

The calendar keeps track of reminders, calls you need to make, meetings, and birthdays. It can even sound an alarm when it's time for you to make a call or go to a meeting.

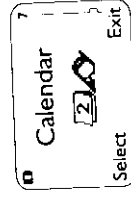

Remember! Your phone must be switched on to use this feature. Do not switch on the phone when wireless phone use is prohibited or when it may cause interference or danger.

- 4) Press **▼** to **On** and press **OK**.

Note: This feature will not function with data calls.

Automatic redial

Your phone will redial the number you're trying to call up to 3 times after you hear a quick, busy signal. Press **END** to stop the call attempts.

This feature attempts to redial numbers that are busy due to the wireless network. It will not redial numbers to a busy party.

Activating automatic redial

- 1) Press **Menu 4 1 2 (Settings - Call settings - Automatic redial)**
(For details on how to work the Menu, see page 16)
- 2) Press **▼** or **▲** to **On** and press **OK**

Calculator

Your phone's calculator adds, subtracts, multiplies, divides, and converts currency.

Remember! Your phone must be switched on to use this feature. Do not switch on the phone when wireless phone use is prohibited or when it may cause interference or danger.

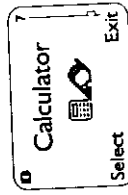

Using the calculator

- 1) Press **Menu 7 (Calculator)**
(For details on how to work the Menu, see page 16)
- 2) With the screen that contains a "0", enter the first number in the calculation (press **#** for decimals)
- 3) To add, press ***** (+ appears)
To subtract, press ****** twice (**-** appears)
To multiply, press ******* (***** appears)
To divide, press ******** (**/** appears)
To add a decimal, press the **#** key **♦**

calls. Contact your service provider for details.

When Caller ID is active, your phone may display the caller's phone number. The caller's name may also display if their name and number has been stored in the phone book (see "Phone book" on page 53) or if the wireless network supports it.

Call or Call-caller ID unavailable will display when the wireless network doesn't recognize the calling number. Also, **Call-caller ID blocked** may display if the calling party has blocked caller ID.

Calling card

If you wish to use a calling card for long distance calls, you must first store your calling card information into your phone. Your phone can store up to four calling cards.

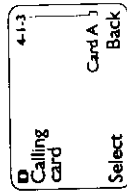

Programming a calling card

- 1) Press **Menu 4 1 3 (Settings - Call settings - Calling card)**
(For details on how to work the Menu, see page 16)
- 2) Press **▼** or **▲** to desired calling card, press **Options**
- 3) Press **▼** or **▲** to **Edit**, press **OK**
- 4) Enter security code and press **OK**
- 5) Press **Select** at **Dialing sequence**. Select the dialing sequence your card uses (use chart below), press **▼** or **▲** to choose sequence, then press **Select**

Note: The order of the following steps may vary, depending on which dialing sequence your card uses.

- 6) Enter access number when prompted for the calling card's access number (usually the 1-800 number listed on the back of the calling card), press **OK**

*Note: You can also retrieve the access number from your phone book if it has already been stored. Simply press **Search**, then **▼** or **▲** to find the number.*

- 7) Enter card number and/or PIN when prompted to enter calling card number and personal identification number, then press **OK**. Press **OK** again at **Save changes?**

- 8) Press **▼** or **▲** to **Card name** and press **Select**. Enter card name using your phone's keypad, press **OK**

See "Entering letters and numbers" on page 39 if you need help on entering the card name

For details about your phone's security code, see "Security code" on page 64.

Dialing Sequence	Use for cards that require you to:	Cards using this sequence*
Access no. + phone no. + card no.	Dial 1-800 access number, then phone number, then card number (- PIN if required)	MCI, AT&T True Choice, Sprint Canada, Untel
Access no. + card no. + phone no.	Dial 1-800 access number, then card number (- PIN if required), then phone number	networkMCI, WorldPhone/MCI
Prefix + phone no. + card no.	Dial the prefix (any numbers that must precede the phone number) and phone number you want to dial, then card number, (then PIN, if required)	GTE, PacBell, AT&T, Stentor

Choosing a calling card to use

- 1) Press **Menu 4 1 3 (Settings - Call settings - Calling card)**
- 2) Press **▼** or **▲** to desired card, press **Options**
- 3) Press **▼** or **▲** to highlight **Select** and press **OK**
- 4) Enter security code at **Security code**; press **OK**
- 5) Your phone will display **Card ready for use**

Making calling card calls

Enter the phone number, including any prefix (such as 0 or 1) that your calling card may require when you

2) Press ▼ repeatedly to show duration of the following options

Last call displays call duration of last call.

All calls displays call duration of all calls made since timers have last been reset (see page 34 for details on how to clear call timers).

Life timer shows duration of all calls; this can not be reset (see page 45)

Clear timers clears all call timers except the Life timer (see page 34).

These call durations are for the currently-selected NAM (phone number). Your phone has separate timers for each NAM your phone uses.

See "NAM selection" on page 49 for details on NAM

Note: The actual time invoiced for calls by your service provider may vary, depending upon items such as network features, rounding off for billing, and taxes.

Call waiting

If you have subscribed to Call Waiting, your phone will beep during a call let you know you have an incoming call. Your phone may also display the incoming caller's identification (see "Caller ID" on page 26).

Answering an incoming call with call waiting

Press **(TALK)**

Swapping between two calls

Press **(TALK)**

Ending the calls

Press **(END)** to end both calls

Activating call waiting

You can also activate this feature with your phone; simply ask your service provider for the feature code, store

The 'Options' soft key

When you access **Dialed calls**, **Received calls**, or **Missed calls** and press **Options**, a list of options will appear on your phone's display.

Call time shows the date and time when the call was first connected (if clock has been set)

Edit number allows you to edit the dialed number.

Save allows you to save the number into your phone book.

Erase will erase the number from the call list.

View number will appear only if the number has been stored in the phone book and the name is displayed instead of the number.

Call settings

This feature allows you to access and activate some of your phone's features.

Using call settings

1) Press **Menu 4 1 (Settings - Call settings)**

(For details on how to work the Menu, see page 16)

2) Press ▼ to reach one of the following options, then press **Select**

4-1-1 **Emergency key 9** - See page 38.

4-1-2 **Automatic redial** - See page 23.

4-1-3 **Calling card** - See page 27.

Call timers

Your phone automatically keeps track of the amount of time you've spent in calls.

1) Press **Menu 2 5 (Call log - Call timers)**

(For details on how to work the Menu, see page 16)

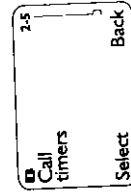

been selected; see below)

Selecting time format

- 1) Press **Menu 4 2 1 (Settings - Phone settings - Clock)**

(For details on how to work the Menu, see page 16)

- 2) Press **▼** to **Time format** and press **Select**
- 3) Press **▼** to either **24-hour** or **am/pm**
- 4) Press **OK**

Displaying or hiding the clock

- 1) Press **Menu 4 2 1 (Settings - Phone settings - Clock)**

(For details on how to work the Menu, see page 16)

- 2) Press **▼** to either **Hide clock** or **Display clock** (only one will display depending on the current setting)
- 3) Press **Select**

Conference call

This feature allows you to add a third party to a call. You can use this feature with local and long distance calls.

Note: This feature may not be available in all systems. See your service provider for details and availability.

Making a conference call

- 1) While in a call, enter (or recall from the phone book) the second phone number and press **(TALK)**
- 2) Once the third party answers, press **(TALK)** to connect all three parties
- 3) Press **(TALK)** again if you wish to disconnect the third party. Press **(END)** to drop both parties.

Recalling a number from the phone book

- 1) During the call, press **Options**
- 2) Press **▼** or **▲** to **Names** and press **OK**

- 3) Press **Select** at **Search**
- 4) Enter name and press **OK**, or just press **▼** or **▲** to scroll through the phone book
- 5) Press **(TALK)**

Current call timer

This feature displays the running elapsed time on your screen while a call is active. Once the call has ended, simply press any key to clear the display.

Also, see "Call timers" on page 31.

Activating the current call timer

- 1) Press **Menu 2 5 (Call log - Call timers)**
(For details on how to work the Menu, see page 16)
- 2) With **Last call** displayed, press **Details**
- 3) With **Current call timer** displayed, press **Select**
- 4) Press **▼** or **▲** to **On**, press **OK**

Customer care contact number

With the press of a single button, you can quickly attempt calls to your service provider. This feature can be helpful if you're having difficulties dialing a number, especially when traveling outside your home area.

Simply press and hold the 2 key and your phone will attempt to call a customer care operator in the area.

Note: This may not be available on all systems. Contact your service provider for availability.

Customize profiles

This feature allows you to customize individual Profiles.

See "Profiles" on page 58 for details

IMPORTANT!

Official emergency numbers vary by location (e.g. 911). Only one emergency number is programmed into your phone to be dialed automatically by Emergency key 9, which may not be the proper number in all circumstances.

Entering letters and numbers

You can enter letters, as well as numbers, when storing information into your phone by using your phone's keypad. When you see the letter you wish to enter, simply press the key associated with that letter until it appears on the display (numbers also appear).

ABC mode

When you need to enter letters into your phone, it will automatically switch over to **ABC** mode.

Your phone displays the **ABC** icon to indicate that your phone is in ABC mode. It also displays when you are viewing names rather than numbers.

When **ABC** is displayed, you can enter these characters:

Key	Characters	Key	Characters
1	.,!:-1	7	PQRS7
2	ABC2	8	TUV8
3	DEF3	9	WXYZ9
4	GHI4	0	Enters an empty space, 0
5	JKL5	*	(See below for details)
6	MNO6	#	Changes letter case; long press accesses 123 mode

While you're editing a name, the **▲** key will move the cursor to the left, and **▼** will move it to the right. Press **Clear** to correct any mistakes.

If you wish to enter an empty space between characters, press 0 for each space.

Changing letter case

Press the **#** key to switch between upper and lower case letters. The **ABC** icon will switch to **abc** to indicate you are using lower case.

123 mode

When storing names to the phone book, you can enter a number within a name at any time. Simply press that particular number key a few times until it appears.

However, you can do this more quickly by accessing the **123** mode, without having to scroll through each letter to access the number you wish to enter.

Simply press the **#** key for about 2 seconds while in **ABC** mode and the **123** icon will appear. While in this mode, only numbers can be entered. Letters can not be entered unless your phone is in **ABC** mode.

Press the **#** key again for a couple of seconds if you wish to deactivate the **123** mode.

Special characters (for storing names)

When in ABC mode (see page 27), you can press the ***** key and the following special characters will appear.

You can use these characters to help when storing names in your phone book. Simply press **▼** or **▲** to highlight the one you wish to use and press **Insert**.

.,? ! ; : - + # * () ' " _ @ & £ % / < > ¿ ¡ \$ % ~ | | ¥

TIP: If you wish to access a special character that appears toward the end of this list, press **▲** for quicker access.

Special Characters (for storing numbers)

The following special characters are helpful when you store names to your phone book (see page 53). Simply press the ***** key once or repeatedly, and the following characters can be stored within the number sequence.

(p) creates a pause when a number is dialed; the

Top score will display the top score (*does not appear in Logic*).

Instructions will describe how the game is played.

Note: Last view or Continue may appear in the options list if a game is interrupted, not finished, or if you have lost the game.

Inbox

When you receive a text message, it's stored in the Inbox. Your phone will display **Message received**, along with the text message icon, and makes a sound (*depending on the message alert tone; see page 48*).

Please see "Text messages and pages" on page 68 for more details on this feature.

Keypad

This feature helps protect the keypad against accidental keypresses.

See "Keypad" on page 14 for more details.

Keypad cover setting

This feature activates the keypad cover if you wish to answer and end calls with the keypad cover.

See "Using the keypad cover" on page 13 for details.

Keypad tones

This is one of the settings in your phone's Profiles (see page 58). It sets the volume of the tone you hear when you press your phone's keys.

Note that if you choose the **Silent** profile, keypad tones will be turned off.

Setting the keypad tones

- 1) Press **Menu 3 (Profiles)**
(For details on how to work the Menu, see page 16)
- 2) Your phone lists each profile. Use **▼** to highlight the one you want to set the keypad tones for and

press **Options**.

- 3) Highlight **Customize** and press **OK**. Press **▼** to **Keypad tones** and press **Select**

- 4) Press **▼** to scroll through the options; your phone plays a sample of each. Press **OK** for the one you want.

Language

Because many wireless phone customers speak English as a second language, your phone allows you to choose your phone's displayed language.

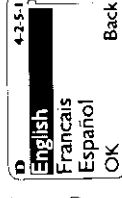

Choosing a language for your phone

- 1) Press **Menu 4 2 5 (Settings - Phone settings - Language)**

(For details on how to work the Menu, see page 16)

- 2) Use **▼** or **▲** to select the language you wish to use and press **OK**

You can choose from English, French, Spanish, or Portuguese.

Last call timer

This feature displays the duration of your last call.

See "Call timers" on page 31.

Last number redial

When you want to call your last dialed number,

Press **(TALK)** and wait 3 seconds

Note: You must be at the start screen before you press (TALK)

Letter case

You can change from upper to lower case when entering letters into your phone.

See "Changing letter case" on page 40 for more details.

See "Touch tones" on page 70 for details.

Setting manual touch tones

- 1) Press **Menu** 4 2 3 1 (**Settings** - **Phone settings** - **Touch tones** - **Manual touch tones**)

(For details on how to work the **Menu**, see page 16)

- 2) Use **▼** or **▲** to highlight one of the following options, then press **OK**

Continuous means the tone sounds for as long as you press and hold the key.

Fixed sets the tone length to .1 seconds, regardless of how long you press the key.

Off turns the tones off, and no tones will be sent when you press the keys.

Memory status

This feature allows you to see how many free and in-use memory locations are in your directory.

Also, see "Phone book" on page 53.

At the start screen,

- 1) Press **Names**
- 2) Press **▼** or **▲** to **Options** and press **Select**
- 3) Press **▼** or **▲** to **Memory status**
- 4) Press **Select**

Messages

This feature allows you to access your voice and text messages, as well as composing your own welcome note.

Using messages

- 1) Press **Menu** 1 (**Messages**)

(For details on how to work the **Menu**, see page 16)

- 2) Press **▼** to reach one of the following options, then press **Select**

1-1 **Text messages** - See page 68.

1-2 **Voice messages** - See page 73.

1-3 **Welcome note** - See page 75.

Message alert tone

This is one of the settings in your phone's Profiles (see page 58). It sets the tone that your phone makes when you get a text message.

Also, see "Text messages and pages" on page 68.

- 1) Press **Menu** 3 (**Profiles**)
(For details on how to work the **Menu**, see page 16)
- 2) Your phone lists each of the 5 profiles. Use **▼** to highlight the one you want to set the message alert tone for and press **Options**.
- 3) Highlight **Customize** and press **OK**. Press **▼** to highlight **Message alert tone**, then press **Select**.
- 4) Use **▼** to scroll through your choices (your phone plays samples) and press **OK**.

Microphone

You can mute and unmute your phone's microphone while a call is in progress. During a call, your phone's softkeys change from **Names** and **Menu** to **Options** and **Mute**.

Muting and unmuting your phone

You can mute the phone's microphone during a call: simply press **Mute**. To unmute the microphone, press **Unmute**.

If these texts are not available, press **Options**, scroll to **Mute** or **End mute** and press **Select**.

Muting and unmuting also affects the microphones of

tion code received from your dealer (e.g. *74, *740, etc.), press **OK**

- 3) ▼ to the service that the code applies to and press **Select**
- 4) ▼ to suboption, then **Select** (Repeat step as required, based on number of suboptions)
(Use step four only for call forwarding options)
- 5) ▼ to **Activate** or **Cancel**, then press **OK**

Removing items from the menu

Follow the steps in 'Storing codes', but press **OK** after the **Feature code:** prompt (without entering a code). Then highlight both **Activate** and **Cancel** for each feature you wish to remove, and press **OK**.

Note: This feature does not deactivate those services, it only removes them from the menu.

Network services

Most of the features in this menu are network services that require a subscription. See your service provider for details and availability.

- 4-4-1 **Voice privacy** - See page 74.
- 4-4-2 **Call forwarding *** - See page 29
- 4-4-3 **Call waiting *** - See page 32.
- 4-4-4 **Send own number *** - See page 65.
- 4-4-5 **Network feature setting** - See page 50.
- 4-4-6 **NAM selection** - See page 49.

* These features will not appear in the menu unless they are activated using **Network feature setting**. See "Network feature setting" on page 50 for details.

One-touch dialing

This feature allows you to make phone calls quickly and easily with the touch of a button. •

But first...

You must store names and numbers in your phone book (see page 67) before you can use this feature. Then you can assign a name from the phone book to a one-touch dial location using your phone's keys 2 through 8.

Note: Keys 1 and 9 are used exclusively for dialing your voice mailbox (see page 73) and for attempting emergency calls (see page 84) to the emergency number programmed into your phone (e.g. 911 or other official emergency number). The 2 key is for dialing a customer care operator (see page 36), which can be overwritten if you prefer.

Assigning one-touch dial locations

At the start screen,

- 1) Press **Names**
- 2) Press ▼ or ▲ to highlight **i-touch dialing**
- 3) Press **Select**
- 4) Press ▼ or ▲ to next available empty location, **(empty)** will appear
- 5) Press **Assign**
- 6) Press ▼ or ▲ to select desired name and press **OK**
- 7) Repeat as necessary

Calling a number using one-touch dialing

Press and hold the key (2 through 8) for a few seconds to call the number in the corresponding one-touch dial location. Your phone recalls the phone number from the memory, displays it briefly, then dials it.

*Note: If you press and hold 1, your phone calls your voice mailbox. If you press and hold 9, and emergency key 9 (Menu 4 1) is **ON**, your phone attempts a call to the emergency number programmed into your phone (e.g. 911 or other official emergency number). The 2 key is for dialing a customer care operator.*

- upper and lower case) and press **OK**
- 4) Enter phone number and press **OK**

Also, see "Entering letters and numbers" on page 39 and "Quick save" on page 67.

Changing a number stored with a name

- 1) Recall stored name, then press **Details** to view number
- 2) Press **Options**, scroll to **Edit** and press **Select**
- 3) Press **OK** while name is displayed, unless you wish to change it. If so, press and hold **Clear**, re-enter name and press **OK**
- 4) Press and hold **Clear** to erase number or use the ▼ and ▲ keys to edit
- 5) Enter new number
- 6) Press **OK** to save new number

Recalling names & numbers

Retrieving names and numbers from the phone book is easy to do.

At the start screen,

- 1) Press ▼ or ▲ to view names in directory
- 2) Scroll to the person you wish to call
- 3) Press **(CALL)** to dial the number (phone will display number dialed to confirm)

Recalling numbers by name

You can easily find a specific name stored in the phone book.

At the start screen,

- 1) Press **Names**
- 2) Press the number on the keypad with the corresponding first letter of the name you wish to call

Note: If you only entered the first letter of the name and there are several names beginning with the same letter, press ▼ or ▲ until the desired name appears.

Erasing stored names and numbers

- 1) Recall stored name
- 2) Press **Details**
- 3) Press **Options**
- 4) Highlight **Erase**, then press **Select**, then **OK**

Note: You can not undo Erase functions, so be careful!

Erasing your entire phone book

- 1) Press **Names**
- 2) Press ▼ to highlight **Erase all**
- 3) Press **Select**
- 4) Press **OK** at **Are you sure?**
- 5) Enter security code at **Security code:**
- 6) Press **OK**

Warning: This feature will erase your entire phone book, which can not be undone!

Phone lock

When you turn this on, your phone will lock after you switch your phone off and back on. Then, each time you turn your phone on, it will prompt you for a lock code when you press either **Names** or **Menu**. You can not access most of your phone's memory and menu features, or make phone calls without entering the lock code.

Turning on phone lock

- 1) Press **Menu** 4 3 2 1 (**Settings** - **Security settings** - **Access codes** - **Phone lock**)

(For details on how to work the Menu, see page 16)

(For details on how to work the Menu, see page 16)

- 2) ▼ or ▲ until desired Profile is highlighted
- 3) Press **Options**

Once **Options** is selected, **Select**, **Customize** and **Rename** will appear as your choices. Once you have selected and highlighted one of these items, press **OK**. If you wish to go back to the main menu, press **Back**.

Select activates the currently highlighted Profile.

Customize allows you to customize a Profile by changing the current settings.

Rename allows you to rename the Profile.

When you select **Customize**, press **OK** and you'll have access to several lists and sub-menus that will enable you to adjust the settings on the current Profile.

Note: Car and Headset will not appear in the Profiles list unless your phone is connected to a car kit or a headset. However, they will remain in the menu once connected for the first time.

Note: When you change a setting in the current Profile, it only affects that Profile and will not change your phone's normal settings.

Renaming profiles

- 1) Press **Menu 3 (Profiles)**

(For details on how to work the Menu, see page 16)

- 2) ▼ or ▲ until desired Profile is highlighted
- 3) Press **Options**
- 4) ▼ or ▲ to **Rename** and press **OK**
- 5) Enter new name and press **OK**

Note: Some profiles can not be renamed.

Received calls

This call list shows you the phone numbers of the 10 most recent calls you've answered.

At the start screen, press **Menu 2 3 (Call log - Received calls)**, then ▼ to scroll the numbers.

Also, see "Call log" on page 30 for details on other call lists.

The 'Options' soft key

See "The 'Options' soft key" on page 31.

Restore factory settings

You can reset the settings of many of your phone's features to factory defaults (as in a new telephone).

Restoring factory settings

- 1) Press **Menu 4 2 4 (Settings - Phone settings - Restore factory settings)**

(For details on how to work the Menu, see page 16)

- 2) Enter security code and press **OK**

Note: The memory, timers, language selection, security code and lock codes are not reset. However, any Profiles you have modified will reset when you restore your settings.

Renaming profiles

See "Profiles" on page 58.

Restrict calls

This feature allows you to restrict incoming and outgoing calls for your phone. You can select the level of restrictions through a series of menu choices.

- 1) Press **Menu 4 3 1 (Settings - Security settings - Restrict calls)**
(For details on how to work the Menu, see page 16)
- 2) Scroll to either **Restrict outgoing calls** or **Restrict incoming calls** and press **Select** (the following steps are used for both options)
- 3) Enter the security code and press **OK**
- 4) Press ▼ or ▲ and press **Mark** to select each level of

- 4) Press ▼ to scroll through the options. When you hear the volume level you wish to use, press **OK**.

Note: The ringing volume setting is stored individually for the handsfree desktop charger and handsfree car kit.

Roaming

This is a term used to indicate that your phone is not in its home area. Calls made or received while roaming are usually more expensive than calls made in your home area.

When roaming in some systems outside your home area, your phone may not be recognized by the host system (the one you're travelling in) and you may not be able to place a call.

Contact your service provider for more specific information on how roaming works with your phone, as well as any information on coverage limitations.

Roaming Indicators

When your phone begins roaming, it will beep once and display **ROAM** or **EXTENDED AREA**, depending on how roaming works with your phone. Contact your service provider for more details. If your phone is not roaming (i.e. in its home area) it will either display **HOME** or the name of the service provider.

Saved

This is where saved text messages are stored.

See "Text messages and pages" on page 68 for details.

Scrolling view

You have three different options on how you can view the phone book. Your choices are:

Name list shows all stored names in a scrolling list. Three names will appear at any given time. To view other names in the directory, scroll back and forth through the list using ▼ or ▲. **Name list** is the default setting.

Name + number displays individual names and numbers stored in your directory. Only one name will display on your screen at a time, with the corresponding phone number. Use ▼ or ▲ to view other names.

Name only shows individual names only. To view other names, use ▼ or ▲. You can view the corresponding phone number by pressing **Details**, then ▼ or ▲.

Selecting your scrolling view

At the start screen,

- 1) Press **Names**
- 2) Press ▼ to **Options**, then press **Select**
- 3) Press **Select** at **Scrolling view**
- 4) Press ▼ or ▲ to select either **Name list**, **Name + number**, or **Name only**
- 5) Press **OK**

Security settings

This menu includes the following security features:

- 4-3-1 **Restrict calls** - See page 60.
- 4-3-2 **Access codes** - See page 21.

The **Access codes** submenu includes **Phone lock** (page 56), **Unlocked phone number** (page 72), **Change lock code** (page 46), and **Change security code** (page 65).

Security code

Your phone will prompt you for a security code for certain features. These features can be used only after the correct security code has been successfully entered.

*Note: When entering your security code, ***** will appear on the display to keep others from viewing your code.*

If you make a mistake entering the code, erase the last entered digit by pressing **Clear** or press and hold **Clear**. Then enter the correct code or press **Back** to exit the current feature.

See "Phone book" on page 53 for more details on storing names and numbers.

Storing a name & number

You can save names and numbers in the Phone book. Either use the method described in "Storing a name and number" on page 54 or the "quick save" method described below.

Quick save

At the start screen,

- 1) Enter the phone number and press **Save**
- 2) The phone prompts you to enter a **Name**: Enter a name if you wish (optional), then press **OK**

Also, see "Entering letters and numbers" on page 39.

System

Your phone is capable of working in Residential, Private, and Public Systems (such as your Home System). You can choose how your phone selects a network to use.

This feature is **Menu 5** in your phone. The default is **Automatic**, which means your phone automatically searches for networks available to you and chooses the appropriate one. Every time you switch on your phone, it resets this to **Automatic**.

If you choose **Manual**, your phone searches for networks, then begins displaying them. Your phone displays **AVAILABLE** or **NOT AVAILABLE**: for the systems it finds (You can not use **NOT AVAILABLE**: systems). Use the **▼** key to scroll through the choices, and press **OK** when you see the one you want.

If you choose **New Search**, your phone begins a new search for new Private and Residential systems. When it finds the best new system, it displays it. You can then **Select it**, or start another search by pressing **Next**.

*Note: If you have two phone numbers (two **N**Ms), the **Manual***

and **New search** features are only used with your primary phone number (**NAM 1**). See "NAM selection" on page 49 for more information concerning **NAMs**

To switch from private to public

If you are in a private system and want access to a public system, press and hold **Menu** when you are not in a call. Your phone will display **Search public systems?**, press **OK** and your phone will use the public system for the next (only once) outgoing call. After that it goes back to **Automatic** system selection.

Text messages and pages

Before you can receive and store text messages and pages, you must subscribe to the text messaging network service. See your service provider for details.

About text messages

The maximum length of a text message is up to 225 characters. Your phone has space for up to 30 text messages, depending on the length of each message.

Note: Text messages that you receive with your phone may appear different at times, due to messages that originate in networks other than your own. This does not affect the use of your phone in any way.

Also, the maximum length of a text message may depend on the network's capabilities. See your service provider for additional text messaging information.

Text message options

When you access **Text messages**, you will view a screen with two different options.

Inbox is where incoming messages are received and stored. All new, unread messages are kept here.

Saved allows you to save your incoming messages. All saved, read messages are kept here.

known as DTMF tones.

Touch tones can be used for many automated, over-the-phone services such as checking bank balances, airline arrival and departure times, and using voice mailbox options. Touch tones can be sent only when a call is active.

Storing touch tone strings

Touch tone strings can be used for sending and receiving information with your phone. For example, you can store your office voice mailbox number, along with your password for easy access to your messages.

Store touch tone strings the same way you store phone numbers (see page 67).

You can store a whole digit sequence in your phone book and send it as touch tones for frequently-used strings of numbers.

Sending a touch tone string

Make sure Menu 4 2 3 1 (**Settings - Phone settings - Touch tones - Manual touch tones**) is not set to **Off**. During a call,

- 1) Press **Options**
- 2) Scroll to **Touch tones** and press **OK**
- 3) Enter touch tone string or recall string from the phone book and press **OK**

Note: Use caution when sending confidential information over the air when using DTMF tones in analog mode.

Storing touch tone strings with phone numbers

- 1) Enter the phone number (e.g. your office voice mailbox)
- 2) Press ***** (p)** or ****** (w)**
- 3) Enter the touch tone string (e.g. voice mailbox password)
- 4) Store the number as you normally would

Note: See "Special Characters (for storing numbers)" on page 40 for details on "p" and "w" characters.

When you dial this number, your phone first dials the phone number, then waits (because of the "w" character) for you to press **Send**. Your phone then sends your password.

If you include a "p" character instead of a "w", your phone pauses for 2.5 seconds, then automatically sends your password as touch tones.

Touch tone length

This feature determines the length of each touch tone when they are sent automatically.

Short sets the tone length to .1 seconds. **Long** sets the tone length to .5 seconds.

You can set the touch tone length by pressing **Menu 4 2 3 2 (Settings - Phone settings - Touch tones - Touch tone length)**.

Unlocked phone number

When the phone lock is on (see page 56), no calls can be made. However, you can store one number into your phone that can be called when it's locked.

Storing the unlocked phone number

At the start screen,

- 1) Press **Menu 4 3 2 2 (Settings - Security settings - Access codes - Unlocked phone number)**

(For details on how to work the Menu, see page 16)

- 2) Enter lock code and press **OK**
- 3) Enter phone number at **Number:** (or press **Search** and scroll through the phone book)
- 4) Press **OK**

Warning tones

This is one of the settings in your phone's Profiles (see page 58). Warning tones include tones your phone makes for conditions such as errors, confirmations, power on, battery low, and recharge battery. You can set warning tones on or off.

Turning warning tones on and off

- 1) Press **Menu 3 (Profiles)**
(For details on how to work the Menu, see page 16)
- 2) Your phone lists each Profile. Use **▼** to highlight the one you want to set the warning tones for and press **Options**.
- 3) Highlight **Customize** and press **OK**. Press **▼** to **Warning tones**, then press **Select**.
- 4) Use **▼** to highlight **On** or **Off** and press **OK**

Welcome note

You can program a welcome note into your phone to display a message when you first turn it on (i.e. hello, your name, a reminder, etc.). The maximum length is 36 characters.

- 1) Press **Menu 1 3 (Messages - Welcome note)**
(For details on how to work the Menu, see page 16)
- 2) Enter new message or edit an existing one
- 3) Press **Options**
- 4) Press **▼** to **Save** or **Erase** and press **OK**

The welcome note displays each time your phone is switched on. Characters you enter are added to the left of the cursor. Press **Clear** to delete characters to the left of the cursor. Press **▼** or **▲** to move the cursor right or left.

See "Entering letters and numbers" on page 39 for details.

6. Accessories

If you want to enhance your phone's functionality, an extensive range of accessories is available for you. You can select any of these items to help accommodate your specific communication needs. For availability of these and other accessories, contact your service provider.



A few practical rules for accessory operation:

- Keep all accessories out of reach of small children.
- When you disconnect the power cord of any accessory, grasp and pull the plug, not the cord.
- Check regularly that any vehicle-installed accessories are mounted and are operating properly.
- Installation of any complex car accessories must be made by qualified personnel only.

Use only batteries, chargers and accessories approved by the phone manufacturer. The use of any other types will invalidate any approval or warranty applying to the phone, and may be dangerous.

See page 10 for important battery usage information.

Batteries

The following table shows battery options that are available for your phone, charging times with the Rapid Travel Charger (ACP-9) and the Rapid Cigarette Lighter Charger (LCH-9), talk times, and standby times. Consult your service provider for more information. *These charging times are approximate.*

Rapid Cigarette Lighter Charger (LCH-9)

You can charge your phone's battery from your vehicle battery by using the Rapid Cigarette Lighter Charger (LCH-9).

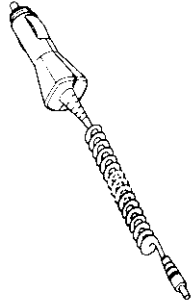

You can also use this lightweight charger with the Compact Desktop Charging Stand (DCH-9).

Calls are possible during charging. A green light indicates the charger is ready for charging (when not charging) or finished charging (if it has been charging). The battery charging times are the same as those for the Rapid Travel Charger (ACP-9U)

The input voltage range is from 11 to 32V DC, negative grounding. Avoid prolonged charging with the Rapid Cigarette Lighter Charger (LCH-9) when the car engine is not running; this may cause the battery of your car to drain. Note also that in some cars the cigarette lighter plug is not provided with electricity if the ignition is not switched on.

Compact Desktop Charging Stand (DCH-9)

The Compact Desktop Charging Stand (DCH-9) supports your phone for an easy and convenient way to charge your phone's battery, as well as a spare battery.

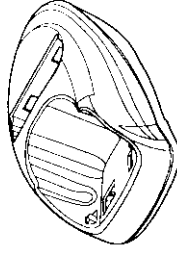

Used together with the Standard Travel Charger (ACP-7U) or the Rapid Travel Charger (ACP-9U), this drop-in stand is an economical choice when you need your phone close at hand, always ready for calls.

Charging is indicated by the scrolling battery bars on the right side of your phone's display. When the scrolling stops, the battery is approximately 80% charged. A battery will be fully charged a few hours after the scrolling stops.

Also, you may notice a light indicator on the stand, which is used for charging a spare battery. A green light indicates a battery is at least 80% full; the red light indicates a battery is charging.

- Should not carry the phone in a breast pocket.
- Should use the ear opposite the pacemaker to minimize the potential for interference.
- If you have any reason to suspect that interference is taking place, switch off your phone immediately.

Hearing Aids

Some digital wireless phones may interfere with some hearing aids. In the event of such interference, you may want to consult your service provider.

Other Medical Devices

Operation of any radio transmitting equipment, including cellular phones, may interfere with the functionality of inadequately protected medical devices. Consult a physician or the manufacturer of the medical device to determine if they are adequately shielded from external RF energy or if you have any questions. Switch off your phone in health care facilities when any regulations posted in these areas instruct you to do so. Hospitals or health care facilities may be using equipment that could be sensitive to external RF energy.

Vehicles

RF signals may affect improperly installed or inadequately shielded electronic systems in motor vehicles (e.g. electronic fuel injection systems, electronic anti-skid (anti-lock) braking systems, electronic speed control systems, air bag systems). Check with the manufacturer or its representative regarding your vehicle. You should also consult the manufacturer of any equipment that has been added to your vehicle.

Posted Facilities

Switch your phone off in any facility where posted notices so require.

Potentially Explosive Atmospheres

Switch off your phone when in any area with a potentially explosive atmosphere and obey all signs and instructions. Sparks in such areas could cause an explosion or fire resulting in bodily injury or even death.

Users are advised to switch off the phone while at a refueling point (service station). Users are reminded of the need to observe restrictions on the use of radio equipment in fuel depots (fuel storage and distribution areas), chemical plants or where

blasting operations are in progress.

Areas with a potentially explosive atmosphere are often but not always clearly marked. They include below deck on boats; chemical transfer or storage facilities; vehicles using liquefied petroleum gas (such as propane or butane); areas where the air contains chemicals or particles, such as grain, dust or metal powders; and any other area where you would normally be advised to turn off your vehicle engine.

Vehicles

Only qualified personnel should service the phone, or install the phone in a vehicle. Faulty installation or service may be dangerous and may invalidate any warranty which may apply to the unit.

Check regularly that all wireless phone equipment in your vehicle is mounted and operating properly.

Do not store or carry flammable liquids, gases or explosive materials in the same compartment as the phone, its parts or accessories.

For vehicles equipped with an air bag, remember that an air bag inflates with great force. Do not place objects, including both installed or portable wireless equipment, in the area over the air bag or in the air bag deployment area. If in-vehicle wireless equipment is improperly installed and the air bag inflates, serious injury could result.

Switch off your phone before boarding an aircraft. The use of wireless telephones in an aircraft may be dangerous to the operation of the aircraft, disrupt the wireless telephone network and may be illegal.

Failure to observe these instructions may lead to the suspension or denial of telephone services to the offender, or legal action, or both.

Emergency Calls

IMPORTANT!

This phone, like any wireless phone, operates using radio signals, wireless and landline networks as well as user-programmed functions which can not guarantee connection in all conditions. Therefore, you should never rely solely upon any wireless phone for essential communications (e.g. medical emergencies).

Remember, to make or receive any calls the phone must be switched on and in a service area with adequate signal strength. Emergency calls may not be possible on all wireless phone net-

NOKIA One-Year Limited Warranty

Nokia Mobile Phones, Inc. ("NMPI") warrants that this cellular phone ("Product") is free from defects in material and workmanship, according to the following terms and conditions:

1. The limited warranty for the Product extends for ONE (1) year beginning on the date of purchase of the Product.
2. The limited warranty extends only to the original consumer purchaser ("Consumer") of the Product and is not assignable or transferable to any subsequent purchaser/second user.
3. The limited warranty extends only to Consumers who purchase the Product in the United States.
4. During the limited warranty period, NMPI will repair, or replace, at NMPI's option, any defective parts, or any parts that will not properly operate for their intended use with new or factory rebuilt replacement items. No charge will be made to the Consumer for any such parts. NMPI will also pay for the labor charges incurred by NMPI in repairing or replacing the defective parts. The external housing and cosmetic parts shall be free of defects at the time of shipment and, therefore, shall not be covered under these limited warranty terms.
5. Upon request from NMPI, the Consumer must provide information to reasonably prove the date of purchase.
6. The Consumer shall bear the cost of shipping the Product to the Customer Service Department of NMPI. NMPI shall bear the cost of shipping the Product back to the Consumer after the completion of service under this limited warranty.
7. The Consumer shall have no coverage or benefits under this limited warranty if any of the following conditions are applicable:
 - a) The Product has been subject to abnormal use, abnormal conditions, improper storage, exposure to moisture or dampness, unauthorized modifications, unauthorized connections, unauthorized repair, misuse, neglect, abuse, accident, alteration, improper installation, or other acts which are not the fault of NMPI, including damage caused by shipping and blown fuses.
 - b) The Customer Service Department at NMPI was not notified by Consumer of the alleged defect or malfunction of the Product during the applicable limited warranty period.
 - c) The Product serial number plate or the accessory date code has been removed, defaced, or altered. ▼

d) The defect or damage was caused by the defective function of the cellular system, or by inadequate signal reception by the external antenna.

8. If a problem develops during the limited warranty period, the Consumer should take the following step-by-step procedure:

- a) The Consumer shall return the Product to the place of purchase for repair or replacement processing.
- b) If "a" is not convenient, the Consumer may contact the Customer Service Department at NMPI, at the phone number listed on the bottom of the next page for further instructions.
- c) The Consumer shall ship the Product prepaid and insured. Expenses related to removing the Product from an installation are not covered under this limited warranty.
- d) The Consumer will be billed for any parts or labor charges not covered by this limited warranty. The Consumer shall be responsible for expenses related to reinstallation of the Product.
- e) If the Product is returned to the Customer Service Department at NMPI during the limited warranty period, but the problem with the Product can not be fixed under the terms and conditions of this limited warranty, the Consumer will be notified and given an estimate of the charges the Consumer must pay to have the Product repaired, with all shipping charges billed to the Consumer. If the estimate is refused, the Product will be returned freight collect. If the Product is returned to the Customer Service Department at NMPI after the expiration of the warranty period, NMPI's normal service policies shall apply and the Consumer will be invoiced for all shipping charges.
9. The Product consists of newly assembled equipment that may contain used components which have been reprocessed to allow machine compliance with Product performance and reliability specifications.
10. ANY IMPLIED WARRANTY OF MERCHANTABILITY, OR FITNESS FOR A PARTICULAR PURPOSE OF USE, SHALL BE LIMITED TO THE DURATION OF THE FOREGOING WRITTEN WARRANTY. OTHERWISE, THE FOREGOING WARRANTY IS THE PURCHASER'S SOLE AND EXCLUSIVE REMEDY AND IN LIEU OF ALL OTHER WARRANTIES, EXPRESS OR IMPLIED. NMPI SHALL NOT BE LIABLE FOR INCIDENTAL OR CONSEQUENTIAL DAMAGES OR A LOSS OF ANTICIPATED BENEFITS OR PROFITS, RESULTING FROM THE PURCHASE OR USE OF THE PRODUCT OR ARISING FROM THE BREACH

FCC/Industry Canada Notice

Your phone may cause TV or radio interference (e.g. when using a telephone in close proximity to receiving equipment). The FCC/Industry Canada can require you to stop using your telephone if such interference can not be eliminated. If you require assistance, contact your local service facility.

This device complies with part 15 of the FCC rules. Operation is subject to the condition that this device does not cause harmful interference.

Using this Guide

The wireless phone described in this guide is approved for use in TDMA/AMPS networks.

A number of features included in this guide are called Network Services. They are special services provided by wireless service providers. Before you can take advantage of any of these Network Services, you must subscribe to the service(s) from your home service provider and obtain instructions for their use.

Disclaimer

It's possible that you may not be able to activate your phone on all wireless systems. Please see your service provider for details.

2. Getting Connected

So you've just bought your new phone. Taken it out of the box, and you're wondering what to do next. Well, this chapter will help get you started.

Installing your battery

Simply place the battery in the grooves on the back of your phone. Then slide the battery upward until it clicks.

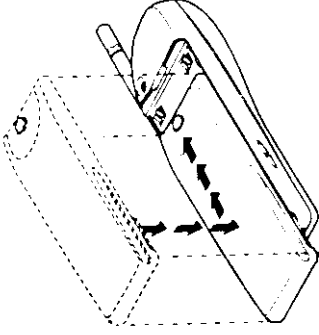

Note: Use only those batteries approved by the phone manufacturer and recharge your battery only with the chargers approved by the manufacturer.

See "Important Battery Information" on page 10.

Charging your new battery

Your phone is powered by a rechargeable Li-Ion or NiMH battery, which should be charged for 24 hours before you use it for the first time. Note that a new battery's full performance is achieved only after two or three complete charge and discharge cycles.

With your phone on or off, simply connect the lead from the charger to the bottom of your phone or place it on a charging stand. Then connect the charger to a standard 120V AC outlet.

When the battery begins charging, your phone will beep once and the battery strength indicator on the right side of the display will scroll.

OF THE WARRANTY EVEN IF NMPI KNEW OF THE LIKELIHOOD OF SUCH DAMAGES.

11. Some states do not allow limitation of how long an implied warranty lasts, so the above limitation may not apply to you (the Consumer). Some states do not allow the exclusion of incidental or consequential damages, so the above limitation or exclusions may not apply to you (the Consumer). This limited warranty gives you specific legal rights and you may also have other rights which vary from state to state.
12. NMPI neither assumes nor authorizes any authorized service center or any person or entity to assume for it any other obligation or liability beyond that which is expressly provided for in this limited warranty.
13. Questions concerning this limited warranty may be directed to the Customer Service Department at Nokia, 6200 Courtney Campbell Causeway, Suite 900, Tampa, FL 33630. Telephone (813) 288-3800 or 1-800-456-5553. Facsimile: (813) 287-6612.
14. The limited warranty period for Nokia Product Corp. supplied attachments and accessories are specifically defined within their own warranty cards and packaging.

9. Technical Data

Wireless System	Dual-Band TDMA and AMPS
Weight	165g (6 oz) with BMS-2 900 mAh NiMH Battery
Size	140 cc
Frequency Range	
Lowband	824.04 - 848.97 MHz (TX) 869.04 - 893.97 MHz (RX)
Highband	1850.04 - 1909.92 MHz (TX) 1930.08 - 1989.96 MHz (RX)
Transmitter Output Power	Up to 600mW nominal
Battery Voltage	3.6 V nominal
Charging current	850 mAh max.
Operating Temperature	-20 °C to + 40 °C (-4 °F to + 104 °F)
Number of Channels	832 lowband 1997 highband
Number of NAMS	3
Memory Locations	199
Memory Capacity	Alpha: 16 digits per location Numeric: 32 digits per location

The information contained in this phone was written for dual-mode TDMA and AMPS phones. The right to make changes and improvements to any of the products described in this guide without prior notice is reserved.

Issue No. 1

© 1998 Nokia Mobile Phones. All rights reserved.

works or when certain network services and/or phone features are in use. Check with local service providers.

Making an Emergency Call

- 1) If the phone is not on, switch it on.
- 2) Key in the emergency number for your present location (e.g. 911 or other official emergency number). Emergency numbers vary by location.
- 3) Press **(TALK)**

If certain features are in use (keyguard, restrict calls, etc.), you may first need to turn those features off before you can make an emergency call. Consult this document and your local cellular service provider.

When making an emergency call, remember to give all the necessary information as accurately as possible. Remember that your wireless phone may be the only means of communication at the scene of an accident - do not cut off the call until given permission to do so.

Radio Frequency (RF) Signals

Your wireless handheld portable telephone is a low power radio transmitter and receiver. When it is ON, it receives and also sends out radio frequency (RF) signals.

In August, 1996, the Federal Communications Commission (FCC) adopted RF exposure guidelines with safety levels for handheld wireless phones. Those guidelines are consistent with safety standards previously set by both U.S. and international standards bodies:

ANSI C95.1 (1992)*; NCRP Report 86 (1986)*; ICNIRP (1996)*

Those standards were based on comprehensive and periodic evaluations of the relevant scientific literature. For example, over 120 scientists, engineers, and physicians from universities, government health agencies and industry reviewed the available body of research to develop the ANSI Standard (C95.1)

The design of your phone complies with the FCC guidelines (and those standards).

*American National Standards Institute, National Council on Radiation Protection and Measurements; International Commission on Non-ionizing Radiation Protection

Care and Maintenance

Your phone is a product of superior design and craftsmanship and should be treated with care. The suggestions below will help you to fulfill any warranty obligations and allow you to enjoy this product for many years. When using your phone, battery charger, OR any accessory:

- Keep it and all its parts and accessories out of small children's reach.
- Keep it dry. Precipitation, humidity and liquids contain minerals that will corrode electronic circuits.
- Do not use or store it in dusty, dirty areas as its moving parts can be damaged.
- Do not store it in hot areas. High temperatures can shorten the life of electronic devices, damage batteries, and warp or melt certain plastics.
- Do not store it in cold areas. When the phone warms up (to its normal operating temperature), moisture can form inside the phone, which may damage the phone's electronic circuit boards.
- Do not attempt to open it. Non-expert handling of the device may damage it.
- Do not drop, knock or shake it. Rough handling can break internal circuit boards.
- Do not use harsh chemicals, cleaning solvents, or strong detergents to clean it. Wipe it with a soft cloth slightly dampened in a mild soap-and-water solution.
- Do not paint it. Paint can clog the device's moving parts and prevent proper operation.
- Use only the supplied or an approved replacement antenna. Unauthorized antennas, modifications or attachments could damage the phone and may violate regulations governing radio devices.
- If the phone, battery, charger, or any accessory is not working properly, take it to your nearest qualified service facility. The personnel there will assist you, and if necessary, arrange for service.

7. Troubleshooting

What if charging fails?

If your phone displays **Not charging**, charging is suspended. Make sure the battery is connected to an approved charging device and that the battery is at room temperature. Extreme temperatures, hot or cold, can affect your battery's performance and prevent charging.

If charging still fails, disconnect the charger from your phone. Then reconnect the charger to your phone and retry. If you still experience charging problems, contact your dealer and, if necessary, bring your phone in to have it serviced. Also remember to bring in your battery and charger.

No service

If you're outside the wireless service area, **No service** will display on your phone. No calls can be made or received, including emergency calls.

What if the call doesn't go through?

Your phone can make and receive calls only when it's switched on and in the wireless network's service area. **No service** means that you're probably outside the wireless service area. No calls can be made or received. See "Get a strong signal" on page 12.

Check call restrictions means calls to the phone number you tried to call are restricted (see "Restrict calls" on page 60), or your phone is locked (see "Phone lock" on page 56).

Note: Check with your service provider for information about when you need to dial a "1" and/or an area code in addition to the number.

If you make a mistake dialing

Press **Clear** to delete the last character entered, or press and hold **Clear** to delete all characters entered.

8. Reference Information

Important Safety Information

Traffic Safety

Do not use a hand-held telephone while driving a vehicle. If using a hand-held phone park the vehicle before conversing. Always secure the phone in its holder, do not place the phone on the passenger seat or where it can break loose in a collision or sudden stop.

The use of an alert device to operate a vehicle's lights or horn on public roads is not permitted.

Remember, road safety always comes first!

Operating Environment

Remember to follow any special regulations in force in any area and always switch off your phone whenever it is forbidden to use it, or when it may cause interference or danger.

When connecting the phone or any accessory to another device, read its user's guide for detailed safety instructions. Do not connect incompatible products.

As with other mobile radio transmitting equipment, users are advised that for the satisfactory operation of the equipment and for the safety of personnel, it is recommended that the equipment should only be used in the normal operating position (held to your ear with the antenna pointing over your shoulder).

Electronic Devices

Most modern electronic equipment is shielded from radio frequency (RF) signals. However, certain electronic equipment may not be shielded against the RF signals from your wireless phone.

Pacemakers

- Pacemaker manufacturers recommend that a minimum separation of 6 inches (20 cm.) be maintained between a hand-held wireless phone and a pacemaker to avoid potential interference with the pacemaker. Those recommendations are consistent with the independent research by and recommendations of Wireless Technology Research Partners with pacemakers:
- Should always keep the phone more than 6 inches (20 cm.) from their pacemaker when the phone is switched on.



CONTAINS: Nickel metal hydride or lithium ion battery. Must be recycled or disposed of properly. Must not be disposed of in municipal waste.

Charging Times

Battery Option	ACP-7U Charger	ACP-9 Charger
BLS-2 Extended Li-Ion Battery 900 mAh	4 hrs	2 hrs
BMS-2 Extended NIMH Battery 900 mAh	4 hrs	1 hr 30 min
BMS-2V Vibrating NIMH Battery 900 mAh	4 hrs	1 hr 30 min
BLS-4 Extended Li-Ion Battery 1500 mAh	5 hrs	3 hrs 30 min

Standby and Talk Times

Battery Option	Digital Talk Time	Analog Talk Time	Standby Time
BLS-2 Extended Li-Ion Battery 900 mAh	2 hrs to 3 hrs 15 min	1 hr to 1 hr 50 min	100 to 200 hrs (dig) 30 to 50 hrs (ana)
BMS-2 Extended NIMH Battery 900 mAh	2 hrs to 3 hrs 15 min	1 hr to 1 hr 50 min	100 to 200 hrs (dig) 30 to 50 hrs (ana)
BMS-2V Vibrating NIMH Battery 900 mAh	2 hrs to 3 hrs 15 min	1 hr to 1 hr 50 min	100 to 200 hrs (dig) 30 to 50 hrs (ana)
BLS-4 Extended Li-Ion Battery 1500 mAh	3 hrs 10 min to 5 hrs 10 min	1 hr 35 min to 2 hrs 50 min	170 to 335 hrs (dig) 50 to 83 hrs (ana)

Note: The times shown are approximate. Battery operation times vary according to signal conditions, network parameters set by the service provider, and how you use your phone.

Chargers & Other Accessories

The following chargers and other accessories are available for your phone; please see your dealer for details. Also, refer to the accessories brochure that was included in your sales package for the entire line of Genuine Nokia Accessories.

Note: When a charger is not in use, disconnect it from the power source. Do not leave the battery connected to a charger for longer than a week; since overcharging may shorten its life. If left unused, a fully charged battery will discharge itself over time.

Standard Travel Charger (ACP-7U)

This lightweight (187g) and durable AC charger can be used with all battery options.

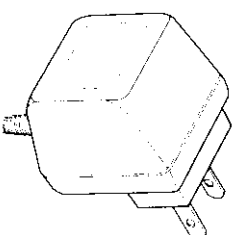

To use the Standard Travel Charger, plug it into a wall outlet and connect the lead from the charger to the base of your phone. The charger can also be used together with the Compact Desktop Charging Stand (DCH-9).

Rapid Travel Charger (ACP-9U)

This lightweight (100g) AC charger can be used with all battery options. Calls can be made during charging, even with a fully discharged battery.

To use the Rapid Travel Charger (ACP-9U), plug it into a standard 120V AC wall outlet, and connect the lead from the charger to the base of your phone.

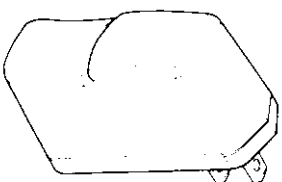

The charger can also be used together with the optional Compact Desktop Charging Stand (DCH-9). Approximate charging times for discharged batteries are shown at the beginning of this section.

Calling the unlocked phone number

Note: Your phone must be locked to use this feature.

At the start screen, press ▼ or ▲ once, then **TALK** or you can manually enter the phone number as it is stored and press **TALK**.

Vibrating alert

This is one of the settings in your phone's Profiles (see page 58). When your phone has the vibrating battery attached, you can set your phone to vibrate when you receive a voice call.

Note: This setting will not appear in your phone unless a vibrating battery has been attached.

Activating vibrating alert

1) Press Menu 3 (Profiles)

(For details on how to work the Menu, see page 16)

2) Your phone lists each Profile. Use ▼ to highlight the one you want to set the vibrating alert for and press **Options**.

3) Highlight **Customize** and press **OK**. Press ▼ to reach **Vibrating alert**, then press **Select** again.

4) Use ▼ to highlight **On** or **Off** and press **OK**. If you choose **On**, your phone will vibrate even if you have set **Ringing options** (see page 61) to **Silent**.

Note: The vibrating alert does not work when your phone is connected to any charger or car kit.

Voice mailbox number

This number dials your voice mailbox.

See "Voice messages" in next section.

Voice messages

When you receive a voice message, your phone will notify you by beeping, lighting up the voice message

indicator, and displaying **New voice message**. The display shows the number of messages if there are more than one.

Storing your voice mailbox number

1) Press **Menu 1 2 2 (Messages - Voice messages - Voice mailbox number)**

(For details on how to work the Menu, see page 16)

2) Enter voice mailbox number

3) Press **OK**

Once you enter your voice mailbox number, it's used until you change it again. It may be up to 32 digits long.

Note: The voice mailbox may be provided by the network (the service provider gives you the number to call).

Calling your voice mailbox any time

Press **Menu 1 2 1 (Messages - Voice messages - Listen to voice messages)**

(For details on how to work the Menu, see page 16)

OR

Press and hold 1

Note: Before you can call your voice mailbox, you must first store your voice mailbox number.

Voice privacy

Note: This feature may not be available in all areas. Please see your service provider for details and availability.

Used only in digital networks, Voice Privacy encrypts the voice channel so that people can not eavesdrop on your conversation. If you turn this feature on and voice privacy becomes inactive for any reason your phone displays **Voice privacy not active** and beeps.

You may set this to **On** or **Off** by pressing **Menu 4 4 1 (Settings - Network services - Voice privacy)**.

When you receive a text message

Text messages are shown in the order that they were received, in their order of priority.

Message received indicates an unread message or page. If more than one message exists, the number of received messages will be listed first.

New emergency message indicates that the message or page received was sent by someone via the service provider. Emergency messages are sent only in situations where life and/or property are in immediate danger. Emergency messages are listed first and will override all other messages.

Urgent messages are also high priority messages.

Reading text messages

With **Message received** displayed,

- 1) Press **Read** and scroll to new message
- 2) Press **Read** again

The 'Options' soft key

Press **Options** while a text message is displayed to access the following reading options.

- 1) Press **Options**
- 2) Press **▼** to the option you want (see below)
- 3) Press **OK**

Reading options

When you open a message and read it, you'll have access to a list of options.

Read next allows you to read the next message.

Erase will erase the message.

Call back will automatically call whoever sent the message if any phone numbers are included in the message.

Save will save the message to **Saved**.

If someone has paged you

Your phone will display **Message received**. The message will display **Call**, followed by the name or number of the person who paged you. Names will appear only if that person has been stored in the phone book.

Calling someone back in a message

The message along with the phone number must be displayed on your phone's screen. While the text message is displayed,

- 1) Press **Options**
- 2) Select **Call back**, then press **OK**

To quickly call back a number in a message

Press **TALK** while the message is displayed.

*Note: If more than one number is on the display, the numbers are displayed in a list. Simply select the phone number you want to call and press **TALK**. If no numbers are found, your phone will display **No number found on this screen**.*

When your phone's memory is full

When you have an incoming text message and your phone's memory is full, one or more messages, of lowest priority, will automatically be deleted in order to receive the new text message.

If the message memory is still full, your phone will display **No space: message waiting**. You can clear this notification by pressing **OK**.

Note: Messages are usually deleted from your inbox. An incoming emergency message may delete messages from your Saved folder.

Touch tones

Your phone can generate various sounds, called touch tones, when the keys are pressed. These are also

If you enter an incorrect security code (**Code error** will appear) five times in a row, your phone won't accept any entries for the next five minutes.

Your phone's default security code is 12345. It's highly recommended that you change this code at once, write it down, and store it in a safe place away from your phone.

Changing your security code

- 1) Press **Menu 4 3 2 4 (Settings - Security settings - Access codes - Change security code)**

(For details on how to work the Menu, see page 16)

- 2) Enter security code and press **OK**
- 3) Enter new security code at **Enter new security code:**, press **OK**
- 4) Enter new security code again at **Verify new security code:**, press **OK**
- 5) Phone will display **Security code changed**

Note: If you have changed your security code and don't remember the new code, contact your service provider. Once you have changed your security code, the default setting is no longer valid.

Send own number

In most service areas, when you call someone your name will be presented to his/her caller ID (if they subscribe). This feature allows you to block their caller ID (i.e. your number will not be presented) when you call them. This feature works on a per-call basis. Contact your service provider for more details.

Note: Before you can activate this feature, you must first store the feature code given to you by your service provider. Otherwise, this feature may not appear in the menu. See "Network feature setting" on page 50 for more details.

Note: This feature is only effective when calling to a number that is equipped with Caller ID.

- 1) Press **Menu 4 4 4 (Settings - Network services - Send**

own number)

(For details on how to work the Menu, see page 16)

- 2) **▼** to **Yes** (to show your number) or **No** (to not show it) and press **OK**
- 3) Enter the number you wish to call (or press **Search** to retrieve the number from the phone book and press **OK**), then press **OK**
- 4) Your phone will attempt to call this number with the feature code you stored in Menu 4 4 5 (see "Network feature setting" on page 50)

Settings

This main menu allows you access to other features. See these individual entries for more information.

- 4-1 **Call settings** - See page 31.
- 4-2 **Phone settings** - See page 57.
- 4-3 **Security settings** - See page 64.
- 4-4 **Network services** - See page 51.

Special ringing tone

You can set your phone to ring differently when a particular person calls you.

Simply store that person's name and number in your phone book and include the 1 character somewhere within that person's name (e.g. Joe1Smith).

To include a 1 character within a name, just press the 1 key four times.

You can also do this by pressing the * key. When a list of special characters appears, press **▼** or **▲** to the 1 character and press **Insert**.

When that person calls you from that number, you'll know it by the special ringing tone.

Note: The special ringing tone will function only when Caller ID is active and the calling number is available.

restriction.

If you have already marked a selection, then highlight the marked selection and press **Unmark** if you wish to remove the restriction.

Restrict outgoing calls

Local calls restricts all outgoing local calls.

Long distance restricts all outgoing long distance calls and chargeable service numbers.

International restricts all outgoing international calls.

If you attempt to make a call when the appropriate restrict call feature is on, your phone will display **Check call restrictions**.

Restrict incoming calls

All calls restricts all incoming calls.

Note: When calls are restricted, calls may be possible to the emergency number programmed into your phone (e.g. 911 or other official emergency numbers). However, Emergency key 9 may not operate depending on the type of restriction you choose.

Ringtone options

This is one of the settings in your phone's Profiles (see page 58). You can choose how your phone notifies you of an incoming call. This setting does not affect incoming text message alert tones (see page 68).

Selecting ringing options

- 1) Press **Menu 3 (Profiles)**
(For details on how to work the Menu, see page 16)
- 2) Your phone lists each profile. Use **▼** to highlight the one you want to set the ringing options for and press **Options**.
- 3) Highlight **Customize** and press **OK**. Press **▼** to **Ring options**, then press **Select**.

- 4) Highlight either **Ring, Ascending, Ring once, Beep once** or **Silent** and press **OK**

Ringtone tones

This is one of the settings in your phone's Profiles (see page 58). It sets the ringing tone for incoming voice calls.

If you set **Ringtone Options** (see page 61) to **Silent** or **Beep once**, ringing tones are automatically off.

Selecting ringing tones

- 1) Press **Menu 3 (Profiles)**
(For details on how to work the Menu, see page 16)
- 2) Your phone lists each profile. Use **▼** to highlight the one you want to set the ringing tones for and press **Options**.
- 3) Highlight **Customize** and press **OK**. Press **▼** to **Ring tones**, then press **Select**.
- 4) Press **▼** to scroll through the options. After you hear the tone you wish to use, press **OK**

Ringtone volume

This is one of the settings in your phone's Profiles (see page 58). It sets the default ringing volume for incoming voice calls and message alert tones.

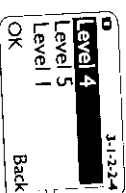

Setting the ringing volume

- 1) Press **Menu 3 (Profiles)**
(For details on how to work the Menu, see page 16)
- 2) Your phone lists each profile. Use **▼** to highlight the one you want to set the ringing volume for and press **Options**.
- 3) Highlight **Customize** and press **OK**. Press **▼** to **Ring volume**, then press **Select**.

- 2) Enter lock code then press **OK**
- 3) Press **▼** or **▲** to **On**, then press **OK**

When your phone is locked, calls may be possible to the emergency number programmed into your phone (e.g. 911 or other official emergency number) including calls with Emergency key 9 (page 38).

You can also store a number in the **Unlocked phone number location**, which allows you to call this number even though your phone is locked (See page 72 for details).

Answering a call with phone lock on

Press any key except **END** and **PMW**

Turning off phone lock

- 1) Press **Menu** 4 3 2 1 (**Settings** - **Security settings** - **Access codes** - **Phone lock**)

(For details on how to work the Menu, see page 16)

- 2) Enter lock code and press **OK**

- 3) Scroll to **Off**, press **OK**

With phone lock off, you can now use your phone without entering the lock code each time you turn your phone on.

Phone settings

Phone settings allows you access to other phone features such as an alarm clock and your phone's language.

Using phone settings

- 1) Press **Menu** 4 2 (**Settings** - **Phone settings**)

(For details on how to work the Menu, see page 16)

- 2) Press **▼** to reach one of the following options, then press **Select**

4-2-1 **Clock** - See page 34.

4-2-2 **Alarm clock** - See page 21.

4-2-3 **Touch tones** - See page 70.

4-2-4 **Restore factory settings** - See page 60.

4-2-5 **Language** - See page 44.

Profiles

Now you can adjust and customize your phone to whatever environments you find yourself in (i.e. meetings, a movie, etc.).

With Profiles, you can control your phone's ringing volume, ringing tone, message alert, keypad tones, warning tones, etc., in a matter of seconds.

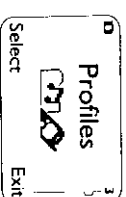

Note: Restore factory settings (see page 60) will reset any changes made in Profiles back to the factory defaults. The default setting is Normal

Accessing Profiles

At the start screen, press **Menu** 3

Selecting different Profiles

If you want to change your phone's Profile, quickly press the **PMW** key. Quickly press **PMW** again to scroll through each choice, then press and hold the **PMW** key for a second to select that Profile.

You can also scroll through the list of Profiles with a quick press of the **PMW** key. Then press **▼** or **▲** to choose another Profile and press **OK**.

Either way, this only allows you to select other Profiles; you can not customize them here. Keep reading to learn how to customize a Profile.

Customizing Profiles

- 1) Press **Menu** 3 (**Profiles**)

which can be overwritten if you prefer.

Changing numbers in one-touch dial list

With this feature, you can assign a different number to any one-touch dial location.

At the start screen,

- 1) Repeat steps 1 through 3 in "Assigning one-touch dial locations"
- 2) Press ▼ or ▲ to select location you wish to change
- 3) Press **Options**
- 4) Press ▼ or ▲ to **Change**, then press **Select**
- 5) Press ▼ or ▲ to select different name for location and press **OK**

Erasing one-touch dial locations

- 1) Repeat steps 1 through 3 in "Assigning one-touch dial locations"
- 2) Press ▼ or ▲ to select location you wish to erase
- 3) Press **Options**
- 4) Press ▼ or ▲ to **Erase**, then press **Select**
- 5) Press **OK** at **Erase?**

Paging

You can receive pages with your phone.

See "Text messages and pages" on page 68.

Phone book

You can store up to 199 numbers and associated names in your phone's memory. These numbers are right at your fingertips for easy dialing.

Things to know about the phone book

Stored numbers may be up to 32 digits long.

Stored names may be up to 16 characters long.

You can not store identical names into your phone (i.e., John, John); make sure that like names are somewhat different in the phone book (i.e., John, Johnny). **Replace?** followed by the currently stored name displays when storing a name already in memory.

Accessing the phone book

At the start screen,

- 1) Press **Names**
- 2) Press ▼ or ▲ to highlight desired submenu
- 3) Press **Select**

About the submenus

The phone book has several submenus from which you can choose.

Search allows you to search for a specific name.

Add new allows you to enter new names and numbers.

Options lets you choose your scrolling view, as well as to show memory status.

1-touch dialing allows you to assign up to seven one-touch dial locations. (see page 57 for details).

Erase all lets you erase every name and number in your phone book. You can erase one name and number at a time by pressing **Details**, then **Options** when viewing a name already in the directory.

Storing a name and number

- 1) Press **Names**
- 2) Scroll to **Add new** and press **Select**
- 3) Enter name using the keypad (use # to switch between

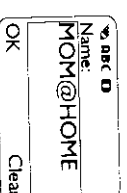

any accessories connected to the phone.

Missed calls

Your phone will keep track of the last 10 calls you have missed, either if you weren't around to answer the call, were out of the service area, or if your phone was off.

If the display says 'Missed calls'

Press **List**. To call back the displayed number, press **TALK**. Press **Exit** to go back to the start screen.

The 'Options' soft key

See "The 'Options' soft key" on page 31.

Checking the missed calls list anytime

At the start screen,

Press **Menu 2 1 (Call log - Missed calls)**, then ▼

(For details on how to work the Menu, see page 16)

This shows you the phone numbers of the 10 most recent calls you've not answered.

When the **Forward if not answered** option in the Call Forwarding feature (see page 29) is selected, your phone treats the forwarded calls as missed calls.

Also, see "Call log" on page 30 for details on other call lists.

NAM selection

The service provider programs your phone with the phone number and system information into your phone's memory when your phone is first activated. This is called a Number Assignment Module (NAM).

For example, your phone can be activated in up to 3 different service areas (e.g. one in Dallas, another in Chicago, and maybe one more in New York), each giving your phone a different phone number or account. Only one number can be active at a time. When you se-

lect a phone number, you're also selecting which system you're using as your home system (see "System" on page 67). The first phone number displayed with this menu is the currently selected number.

Note: It is not necessary to have three NAMs for your phone if your service provider has service or roaming agreements for each area in which you wish to use your phone. Contact your service provider for details.

Selecting the NAM for your phone

1) Press **Menu 4 4 6 (Settings - Network services - NAM selection)**

(For details on how to work the Menu, see page 16)

2) Use ▼ or ▲ to highlight the phone number you want to use and press **OK**

Note: You need at least one active number to make calls. You can not change from one NAM to another during a call.

Network feature setting

Call forwarding (page 29), Call waiting (page 32) and Send own number (page 65) are network services available through your service provider or dealer.

When you subscribe to any of these services, your service provider or dealer gives you a separate feature code to activate each service. Deactivation codes are used to deactivate each service.

Once you store the appropriate code in your phone, the service appears as a menu item. You can then use the menu to activate and deactivate these services.

Note: Storing feature codes apply only to NAM 1.

Storing codes

1) Press **Menu 4 4 5 (Settings - Network services - Network feature setting)**

(For details on how to work the Menu, see page 16)

2) At **Feature Code:**, enter the feature code or deactivate

Life timer

The life timer displays the total time of all calls dialed and received with your phone (in hours and minutes only). The life timer can not be reset and is used in conjunction with your phone's warranty.

Also, see "Call timers" on page 31.

Lights

This is one of the settings in your phone's **Car Profile** (see page 56). This feature determines whether the lights are on only when you use your phone, or if they are on at all times. This setting works only when your phone is connected to a car kit.

1) Press **Menu 3 (Profiles)**

(For details on how to work the Menu, see page 16)

2) Your phone lists each of the 5 profiles. Use ▼ to highlight **Car** and press **Options**.

Note: Car will not appear in the list until the phone has been connected to a car kit at least one time.

3) Highlight **Customize** and press **Select**. Press ▼ to highlight **Lights** and press **Select** again.

4) Use ▼ to scroll through your choices and press **OK**. If you select **Automatic**, your phone's lights are turned off within fifteen seconds if no keys are pressed. If **On** is selected, then the lights will remain on the entire time your phone is connected to the car kit.

Listen to voice messages

Also, see "Voice messages" on page 73.

With **New voice message** on display,

Press **Listen**

OR

Press **TALK**

Listening to voice messages anytime

If you don't wish to listen to voice messages as you get them, you can access them later.

Simply press **Menu 1 2 1** or press and hold the 1 key to call your voice mailbox.

Note: To receive messages from your voice mailbox, your voice mailbox number must first be stored in your phone. See "Voice mailbox number" on page 73 for details.

Lock code

You'll need the lock code to activate and deactivate Phone Lock (see page 55), or to change your lock code. The default lock code is 1234. If you enter an incorrect lock code five times in a row, your phone will prompt you for the security code (see page 64).

Changing your lock code

In a lock code, only numeric characters are accepted.

1) Enter **Menu 4 3 2 3 (Settings - Security settings - Access codes - Change lock code)**

(For details on how to work the Menu, see page 16)

2) Enter lock code at **Enter lock code:** and press **OK**

3) Enter new lock code, press **OK**

4) Verify new lock code, press **OK**

Note: When you change your lock code, make sure you store it in a safe place, away from your phone. Avoid entering access codes similar to emergency numbers to prevent accidental emergency calls.

Manual touch tones

This setting determines how long touch tones are produced as you press the keys on the keypad. Note that touch tones are sometimes called DTMF tones.

digits located to the right of the "P" are automatically sent as touch tones after a 2.5 second pause (see page 70).

(W) creates a "wait" when a number is dialed. The "W" makes your phone wait for you to press **Send** or **TALK**, then it sends the digits located to the right of the "W" as touch tones (see page 70).

You can add as many special characters as you need in a single number sequence. These characters can not be entered while in **ABC** mode.

Erasing stored names and numbers

See "Erasing stored names and numbers" on page 56.

Erasing your entire phone book

See "Erasing your entire phone book" on page 56.

Games

Challenge yourself or a friend to four exciting games in your phone. In the main menu scroll down to **Games** and press **Select**, or just press **Menu 6**, and choose one of the following games:

REMEMBER! Your phone must be switched on to use this function. Do not switch on the phone when wireless phone use is prohibited or when it may cause interference or danger.

Memory

Reveal pictures to find pairs in as few tries as possible. Move the cursor with the 2 (up), 4 (left), 6 (right), and 8 (down) keys. Press the 5 key to reveal pictures. Press the # key to jump right over revealed pictures or move from top left to bottom right. Press the * key to jump left over revealed pictures or move from bottom right to top left. Once found, pairs stay visible.

Snake

Feed the snake with as many goodies as possible and

watch it grow. Use keys 2, 4, 6, and 8 to turn the snake toward food. The longer the snake's tail grows, the higher the score. If the snake hits its own tail or the surrounding wall, the game is over.

Logic

Find a secret combination of figures. Available figures are shown at the top of the display before you accept the first guess row. Use the 2, 4 and 8 keys to move the cursor and the 5 key to select the figure. To copy a figure from a previously accepted guess row, start scrolling with the 4 key, move the cursor to the desired figure in the normal way and accept the selection with the 5 key.

Once you think you have the right combination, press the * key. The result is presented as a set of marks over the row. A correct figure in the right place gives a full mark; a correct figure in the wrong place gives a half mark. The game ends when all the figures are correct and in the right place.

Dice

Use this to play other games that require a set of dice if one isn't available. Use the **Level** option to set the number of dice, up to six. You can roll, lock, and unlock each die as many times as you wish.

When you start a new game, the dice roll for a couple of seconds and then stop. Use the 4 (left) and 6 (right) keys to select a die. Press the 5 key to lock or unlock the selected die.

Press **(*)** to roll the unlocked dice again.

Game options

When you select a game, you can choose from the following submenus:

Level allows you to choose the level of difficulty

New game starts a new game.

Dialed calls

Your phone automatically stores the last 10 numbers you've dialed.

- 1) Press **Menu 2 2 (Call log - Dialed calls)**

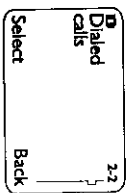

(For details on how to work the Menu, see page 16)

- 2) Press **▼** or **▲**
- 3) Press **(TALK)** to dial the number you wish to call

You can also access the last 10 dialed numbers if you press **(TALK)**, then quickly press **▼** or **▲** to scroll through the list.

Also, see "Call log" on page 30 for details on other call lists.

The 'Options' soft key

See "The 'Options' soft key" on page 31.

Earpiece volume

The scroll keys on your phone will adjust the earpiece volume during a phone call. The top scroll key increases while the bottom one decreases the volume.

If an accessory like a headset or a car kit, or one with its own loudspeaker, is connected to your phone, the scroll keys will adjust the volume for that accessory.

Note: Using the scroll keys to adjust earpiece volume functions only during phone calls.

Emergency calls

Before attempting any emergency calls, see "Emergency Calls" on page 84 for important safety information.

- 1) If the phone is not on, switch it on
- 2) Key in the emergency number for your present location (e.g. 911 or other official emergency number). Emergency numbers vary by location.
- 3) Press **(TALK)**

IMPORTANT!

This phone, like any cellular phone, operates using radio signals, cellular and landline networks, as well as user-programmed functions which can not guarantee connection in all conditions. Therefore, you should never rely solely upon any cellular phone for essential communications (e.g., medical emergencies).

Remember to make or receive any calls, the phone must be switched on and in a service area with adequate cellular signal strength.

Emergency calls may not be possible on all cellular phone networks or when certain network services and/or phone features are in use. Check with local cellular service providers.

If certain features are in use (keyguard, restrict calls, etc.), you may first need to turn those features off before you can make an emergency call. Consult this document and your local cellular service provider.

When making an emergency call, remember to give all the necessary information as accurately as possible. Remember that your cellular phone may be the only means of communication at the scene of an accident - do not cut off the call until given permission to do so.

Emergency key 9

With this feature on, the phone attempts to make an emergency call when you press 9, then **(TALK)**. The phone dials the emergency number pre-programmed into your phone.

Note: You can also dial an emergency call by pressing and holding 9 until the phone indicates it is attempting to make an emergency call. However, this method does not work when Keyguard is active or when the phone is connected to a modem.

Activating Emergency key 9

- 1) Press **Menu 4 1 1 (Settings - Call settings - Emergency key 9)**

(For details on how to work the Menu, see page 16)

- 2) Press **▼** to **On** or **Off**, then press **OK**

it into your phone, then activate it.

Note: This feature may not appear in your phone's menu until the feature code has been stored.

See "Network feature setting" on page 50 for more details.

- 1) Press **Menu 4 4 5 (Settings - Network services - Call waiting)**

(For details on how to work the Menu, see page 16)

- 2) Press **▼** to **Activate** (or select **Cancel** to cancel)
- 3) Press **OK**
- 4) Your phone will attempt to call the network to confirm the feature code you entered in Menu 4 4 5 (see "Network feature setting" on page 50)
- 5) Once the feature code had been confirmed, the feature is activated.

Change lock code

This feature allows you to change your lock code.

See "Changing your lock code" on page 46.

Change security code

This feature allows you to change your security code.

See "Changing your security code" on page 65.

Clear call lists

This feature will clear all dialed numbers, as well as numbers of answered calls and missed calls. You can not undo this operation, so be careful.

Also, see "Call log" on page 30.

- 1) Press **Menu 2 4 (Call log - Clear call lists)**
(For details on how to work the Menu, see page 16)
- 2) Highlight either **All Missed**, **Dialed**, or **Received** and press **OK (All)** will clear all call lists, while the others clear their respective call lists)

Clear timers

This feature clears all call timers for the currently-selected NAM.

See "Call timers" on page 31 for more details.

- 1) Press **Menu 2 5 4 (Call log - Call timers - Clear timers)**

(For details on how to work the Menu, see page 16)

- 2) Enter security code at **Security code:** and press **OK**

Careful: Clearing call timers can not be undone. If you are using the call timers to log or track the amount of time you are using your phone, you may wish to record the call timers before you erase them.

Note: The Life timer contains important warranty information and can not be reset. See "Life timer" on page 45 for details.

Clock

Your phone has an internal clock that can be displayed or hidden. It also features an alarm clock (see page 21).

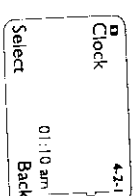

Note: The clock is powered by your phone's battery. If your clock has been activated and you remove the battery while your phone is still on, you will need to reset the time after you turn your phone back on.

However, if you first turn your phone off before removing the battery, your phone will retain the time and date it had before the battery was removed.

Setting the clock

- 1) Press **Menu 4 2 1 (Settings - Phone settings - Clock)**
(For details on how to work the Menu, see page 16)
- 2) Press **▼** to **Adjust time:** press **Select**
- 3) Enter present time at **Time:** (use two-digit fields for hours and minutes)
- 4) Press **OK**
- 5) Select **am** or **pm** and press **OK** (if am/pm format has

make a calling card call. See your calling card for instructions.

Press and hold **TALK** for a few seconds until your phone displays **Card call**.

Press **OK** when you see **Wait for tone, then press OK**. When you see **Wait for tone, press OK again, press OK** again.

Note: This procedure may not apply to all calling card options programmed into your phone. Please look at the back of your calling card or contact your long distance company for more information.

Call forwarding

This network service is used to forward incoming calls to another number so you won't miss an important call. Check with your service provider for details.

Note: Before you can activate this feature, you should first store the feature code given to you by your service provider. Otherwise, this feature may not appear in the menu.

*However, you can use the feature code manually, if you choose, by including the feature code in front of the phone number (e.g., *72 555 1212)*

See "Network feature setting" on page 50 for more details.

1) Press Menu 4 4 2 (Settings - Network services - Call forwarding)

(For details on how to work the Menu, see page 16)

2) Press **▼** or **▲** to desired call forwarding feature (see options below)

3) Press **Select**

4) Highlight **Activate** and press **OK**

5) Enter phone number at **Number:** (or press **Search** to locate number in phone book) and press **OK**

6) Your phone will attempt to call the network to confirm the feature code you entered in Menu 4 4 5 (see "Network feature setting" on page 50)

7) Once the feature code had been confirmed, the feature is activated.

Call forwarding options

Forward all calls forwards all incoming calls.

Forward if busy forwards calls only when you're on the phone.

Forward if not answered forwards calls if you don't answer.

Forward if out of reach forwards calls if you are out of the serving wireless network.

Cancel all call forwarding cancels all call forwarding options you have active.

Call log

This feature automatically keeps track of numbers you've dialed, numbers that have called you, and the amount of time you've spent on calls.

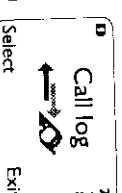

Using call log

1) Press Menu 2 (Call log)

(For details on how to work the Menu, see page 16)

2) Press **▼** to reach one of the following options, then press **Select** or **OK**

2-1 **Missed calls** - See page 49.

2-2 **Dialed calls** - See page 37.

2-3 **Received calls** - See page 59.

2-4 **Clear call lists** - See page 33.

2-5 **Call timers** - See page 31.

Tip: You can dial any of the phone numbers by pressing **TALK** while the number is on the display.

Note: Your phone must remain on to use the calendar's alarm feature. If your phone is off, the alarm will not sound at its scheduled time and the note will be erased from memory.

Using the calendar

1) Press Menu 8 (Calendar)

(For details on how to work the Menu, see page 16).

- 2) If you haven't set the time and date, your phone prompts you to set your phone's clock

When your phone prompts you for the time with **hh:mm**, enter the time in hours and minutes (using two-digit fields), then press **OK**

Time format (24-hour or am/pm) is set using the Clock. See "Selecting time format" on page 35.

When your phone prompts you for the date with **mm/dd/yyyy**, enter the month and day (using two-digit fields) and year (using a four-digit field), then press **OK**.

Tip: Use ▼ to move the cursor right and ▲ to move it left. When you enter a digit, it writes over the number to the right of the cursor.

- 3) Your phone displays the current day. You can also scroll to different days by pressing ▼ or ▲.
- 4) Once you're at the date you want, press **Options**. Then use ▼ to highlight the option you want, and press **OK**. The options are:

Option 1: View day

With this option, you can view the notes of the day currently on display.

Use ▼ to scroll through the notes. Each note allows you to choose the following **Options**:

Erase clears the note from your calendar.

Edit gives you the same prompts you got when you made the note.

Move gives you the date prompt so you can move the note to another date.

Option 2: Make note

With this option, you'll need to choose **Reminder**, **Call**, **Meeting**, or **Birthday**. Your phone will prompt you for more information depending on which one you choose. You can also set an alarm for any calendar note.

See "Entering letters and numbers" on page 39 for help with entering information at the **Subject** prompt.

Note: When the alarm goes off, you can press **Postpone** or **OK**. Press **OK** to shut off the alarm.

Option 3: Erase notes

With this option, you'll need to choose which notes to erase. If you choose all the notes for the day currently on display (**Of Chosen Day**), or **One By One** (for all notes in the calendar), your phone presents each note to you with the option **Erase** or **Back**.

If you choose **All at Once**, your phone will delete all calendar notes. When prompted to confirm the erase, press **Yes** or **No**.

Option 4: View all

This allows you to view the notes of the entire calendar. Use ▼ or ▲ to scroll through the notes. **Calendar memory empty** will appear if there are no notes in the calendar.

Option 5: Go to date

Enter the date you wish to go to.

Option 6: Set the date

Enter the day and month (using two-digit fields) and year (using a four-digit field), then press **OK**

Caller ID

This is a network service that helps identify incoming

5. Your Phone A to Z

ABC mode

This allows you to enter names into your phone book. See "Entering letters and numbers" on page 39.

Access codes

This is a security feature that allows you access to certain phone features, such as the phone lock (page 56) and unlocked phone number (page 72).

Also, see "Lock code" on page 46 and "Security code" on page 64.

Alarm clock

The alarm clock operates off your phone's clock and can be set in advance to sound an alert at a designated time. See "Clock" on page 34 for information on your phone's clock.

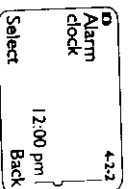

Setting the alarm clock

- 1) Press **Menu 4 2 2 (Settings - Phone settings - Alarm clock)**

(For details on how to work the Menu, see page 16)

- 2) Enter time you wish to set alarm (use two-digit fields for hours and minutes). Existing digits will be replaced with the new alarm time.
- 3) Press **OK**
- 4) Select either **am** or **pm** and press **OK**

Note: Step 4 appears only if you have selected am/pm format. See "Selecting time format" on page 35 for more information.

When the alarm goes off

Press **Stop** to shut off the alarm.

Snoozing

Press **Snooze**

The alarm will go off again in 10 minutes. If you let the phone alarm for 1 minute without pressing a key, it stops alarming for 10 minutes then starts again.

Turning the alarm clock off

- 1) Press **Menu 4 2 2 (Settings - Phone settings - Alarm clock)**

(For details on how to work the Menu, see page 16)

- 2) Press **▼** or **▲** to **Off**
- 3) Press **OK**

All calls timer

This feature keeps track of how much time you have spent on all calls with your phone.

See "Call timers" on page 31.

Automatic answer

This is one of the settings in your phone's Profiles (see page 58). With this on, your phone answers incoming voice calls after one ring.

Note: This can only be used when your phone is connected to a headset or to an approved handsfree car kit equipped with the ignition sense option, with the ignition on.

Activating automatic answer

- 1) Press **Menu 3 (Profiles)**
- 2) Your phone lists each profile. Use **▼** to highlight either the **Car** or **Headset** profile and press **Options**.

Note: **Car** and **Headset** will not appear in the list unless the phone has already been connected to a car kit or headset.

- 3) Highlight **Customize** and press **OK**. Press **▼** to **Automatic answer**, then press **Select** again.

Scroll bar

When you access your phone's menu and sub-menus, you will notice a scroll bar at the far right of the screen. This bar indicates where you are in the menu structure: each "tab" on the bar represents a different menu item.



For example, press **Menu** once. The scroll bar appears with the first (top) tab displayed. A different tab appears each time you press the ▼ or ▲ key to move up and down through the menu structure. The scroll bar works the same way with submenus.

Menu & submenu numbering

When you scroll to a menu or submenu, the menu number and/or submenu number appears on the display above the scroll bar. If you become familiar with these numbers, you can use them as shortcuts for accessing different menus.

For example, when you scroll to menu 2 (**Call log**) the number **2** appears in the top right-hand corner of the display. If you scroll to menu 4 (**Settings**), submenu 3 (**Security settings**), your phone will display **4-3** in the top right-hand corner.

Also, see "Using shortcuts" on page 18.

What is the 'start screen'?

The start screen appears when you first turn your phone on, in its idle state.

When you want to get to the start screen

Press **(END)** at any time except during a call (unless you want to hang up)

If you press **(END)** when the phone is requesting input (for example, a setting, phone number, name, etc.), the phone displays the start screen and the input is not saved.

Scrolling through the main menu

- 1) At the start screen, press **Menu**
- 2) Press ▼ or ▲ to reach the desired menu item
- 3) Press **Select Options** or **OK** (whichever appears) to enter submenus and to choose options
- 4) Press **Exit** to exit the present menu or **Back** to go back one level

Using shortcuts

This is a quick and easy way to access a menu without having to scroll through other menus.

Press **Menu**, then menu number, then submenu number. Press the menu and submenu numbers within a couple of seconds of each other when using this method.

For a summary of your phone's menu structure, see "Summary of Menu Items" on page 19.

Help text

If you're not sure how a feature works, wait about ten to fifteen seconds and help text will appear for most of your phone's features. Press **More** to see the next page of the text or **Back** to exit.

your phone slightly, or move towards a window if you're calling from inside a building.

Using the keypad cover

When **Keypad cover setting** is on, you can answer calls simply by opening the keypad cover. When you want to hang up, just close the cover and the call will end.

When the keypad cover setting is off, you must open the keypad cover to answer any calls. Once opened, you can press any key (except the **PMR** and **END** keys) to answer a call.

To end a call, press **END** before closing the keypad cover.

Activating the keypad cover

- 1) Press **Menu** 4 2 6
- 2) Press **▼** or **▲** to **On** and press **OK**

*Note: If you're using a headset and wish to close the keypad cover and still keep the call active, press **Options** once before closing the keypad cover.*

Making a call

When you want to make a call, open the keypad cover, enter the area code and phone number and press **TALK**.

Editing a number on display

Press **▲** to move the cursor to the left and **▼** to move it to the right. Press **Clear** to delete the character to the left of the cursor.

Dialing a phone number stored in the phone book

View stored names and numbers by pressing **▼** or **▲** from the start screen (see page 17), then press **TALK**.

Emergency calls

See "Emergency calls" on page 37.

Ending a call

If **Keypad cover setting** is active, simply close the keypad cover. Otherwise, press **END**.

See "Using the keypad cover" on page 13.

Answering a call

The phone rings according to the settings in the currently selected profile (see page 58).

If **Keypad cover setting** is active, simply open the keypad cover to answer the call. Otherwise, press any key except **END** or **PMR**.

*Note: If Keypad cover is on (see page 14), only **TALK** answers calls. See "Using the keypad cover" on page 13.*

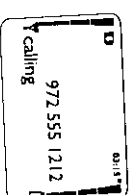

Switching off the phone

Press and hold the **PMR** key for two seconds **OR** quickly press the **PMR** key (**Switch off** will appear, highlighted) then press **OK**.

Keypadguard

This feature helps to prevent accidental key presses (e.g. when your phone is in your pocket, in your purse) by locking your keypad. If any keys are pressed while Keypadguard is activated, **Press Unlock and then *** will display.

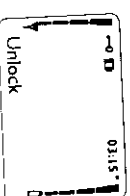

Activating Keypadguard

Press and hold **END**

OR

Press **Menu ***

Activating Keypadguard via the menu

At the start screen:

Note: If you're charging the battery for the first time, the battery strength indicator bars will not scroll the entire time. If your phone is off, the scroll bars will disappear long before the 24 hours have elapsed. This is normal. If your phone is on, the scroll bars will stop scrolling after a while. Either way charge the battery for the entire 24-hour duration.

If your phone displays **Not charging**, charging is suspended. Check that the battery is not connected to a non-approved charging device. If the battery is very hot or cold, wait for a while; charging will automatically resume after the battery is restored to its normal operating state. If charging still fails, contact your dealer.

When is a good time to charge?

Actually, you can charge anytime. If you have a NiMH battery, you should allow it to completely discharge once in a while.

When your phone beeps once and displays **Battery low**, you only have a couple of minutes of talk time remaining. The repetition rate of these battery-low warnings depend on the remaining battery capacity and the battery condition. These warnings are more frequent when you're in a call.

Note: The phone will not give you the warning tone under certain conditions. See "Warning tones" on page 75.

Once all the power has drained from your battery, you'll hear three beeps with the message **Recharge battery** on your display. At this point, your phone will switch itself off and you'll need to recharge your battery.

When is charging complete?

When the charge indicators stop scrolling, your phone is considered fully charged. However, a slight increase in charge may occur if your phone is left connected to the charger for a while. This is called "trickle charge."

Charging times depend on the type of battery and charger used.

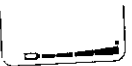

For approximate charging and operating times, see "Batteries" on page 76.

Can you make calls while charging?

Yes, you can. But your battery may not charge while a call is in progress. Charging should resume once you end the call.

Discharging NiMH batteries

A NiMH battery lasts longer and performs better if you fully discharge it from time to time. To discharge the battery, leave your phone switched on until the battery is drained. The phone will display several messages that the battery is low and that you need to recharge it; just ignore them.

Note: Do not attempt to discharge the battery by any other means.

When do I need to buy a new battery?

The battery can be charged and discharged hundreds of times, but it will eventually wear out. When the operating time (talk-time and standby time) is noticeably shorter than normal, it's time to buy a new battery.

Removing the battery

Note: Switch off the phone before removing the battery!

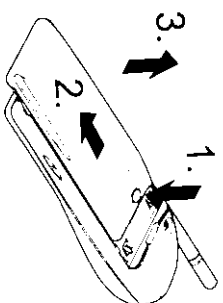

- 1) Press and hold the button at the top of the battery.
- 2) Slide the battery toward the bottom of the phone.
- 3) Lift the battery off the phone.

Important Battery Information

- Note that a new battery's full performance is achieved only

Table of Contents

Safety At A Glance	6
Getting Connected	8
Installing your battery	8
Charging your new battery	8
Removing the battery	10
The Basics	12
Switching on the phone	12
Checking signal strength	12
Using the keypad cover	13
Making a call	13
Ending a call	14
Answering a call	14
Switching off the phone	14
Keypad	14
Working The Menu	16
Navigating tools	16
What is the 'start screen'?	17
Scrolling through the main menu	18
Help text	18
Summary of Menu Items	19
Your Phone A to Z	21
Accessories	76
Batteries	76
Chargers & Other Accessories	78
Troubleshooting	81
Reference Information	82
Technical Data	90

1. Safety At A Glance



Read these simple guidelines before using your phone. Failure to comply with those guidelines may be dangerous or illegal.

For more detailed safety information, "Important Safety Information" on page 82.



Road Safety Comes First
Don't use a hand-held phone while driving; park the vehicle first.



Switch Off In Hospitals
Switch off your phone when near medical equipment. Follow any regulations or rules in force.



Switch Off On Aircraft
Mobile phones can cause interference. Using them on aircraft is illegal.



Switch Off When Refueling
Do not use the phone at a refueling point. Do not use near fuels or chemicals.



Switch Off Near Blasting
Do not use the phone where blasting is in progress. Observe restrictions, and follow any regulations or rules in force.



Interference
All mobile phones may get interference which could affect performance.



Use Sensibly
Use only in the normal position (to ear). Avoid unnecessary contact with the antenna when phone is on.



Qualified Service
Only qualified service personnel may install or repair cellular phone equipment. Use only approved accessories and batteries.



Accessories and Batteries
Use only approved accessories and batteries. Do not connect incompatible products.

Keys

Power key

Press and hold to turn your phone on or off.

Scroll keys

Scroll through menus, sub-menus, and the phone book. Press and hold for continuous scrolling.

TALK
Dials the number on the display.

Softkeys

Their current function is displayed above the key (for example, here their functions are "Menu" and "Names").

END
Push this key to end a phone call.

Keypad cover

Flip it open to answer a call and to access the keypad. Flip it closed to end a call.

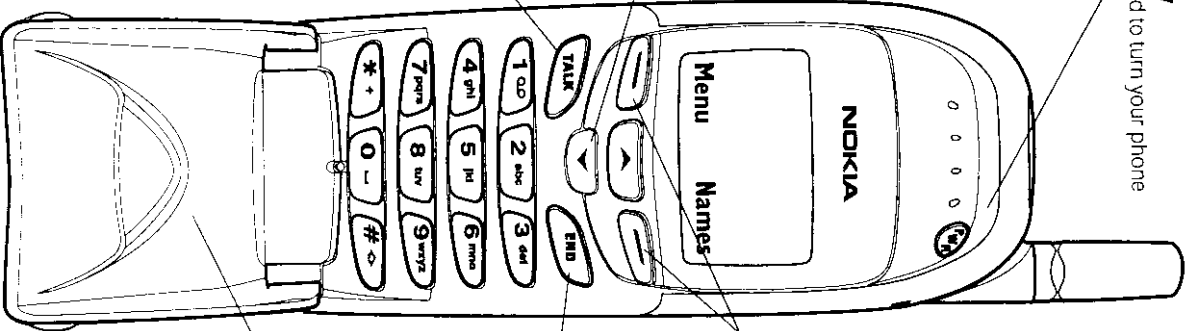

Quick guide to functions

*Note: If you have trouble accessing a feature, try starting from the start screen. To get to the start screen, press **END** at any time except during a call (unless you want to hang up).*

Accessing your phone book - Press **▼** or **▲**

Answering a call - Open keypad cover or press any key except **END** or **END** if you have not activated the keypad cover setting

Answering a Call Waiting with another call active - Press **TALK** (press **TALK** to swap calls; press **END** to end both calls)

Clearing a digit from the display - Press **Clear**

Emergency 9 call - Press and hold 9 for three seconds. (*Emergency key 9 feature must be set to on!*)

Ending a call - Press **END** or close the keypad cover if you have activated the keypad cover setting

Keypad activation - Press and hold **END** until **Keys** locked appears, or press **Menu ***

Keypad deactivation - Press **Unlock**, then *****

Last number redial - Press **TALK**, wait three seconds

Listening to voice messages - With **New voice message** on display, press **Listen** or press **TALK** (requires voice mail subscription)

Making a call - Enter phone number, then press **TALK**

One-touch dialing - After you assign the one-touch dialing locations, press and hold a number key (2 through 8 only) for two seconds

Profiles - Quickly press **END** once, scroll through profile list with the **END** key; press and hold **END** to choose profile

Storing a name and number (Quick Save) - Enter the phone number and press **Save**. Enter a name if you wish (optional), then press **OK**

Switching on/off - Press and hold **END** for 2 seconds

Volume adjust - During a call, press **▲** to increase your phone's volume or **▼** to decrease