

# Nokia N78 User Guide

---

Issue 1

DECLARATION OF CONFORMITY

**CE 0434**

Hereby, NOKIA CORPORATION declares that this RM-236 product is in compliance with the essential requirements and other relevant provisions of Directive 1999/5/EC. A copy of the Declaration of Conformity can be found at [http://www.nokia.com/phones/declaration\\_of\\_conformity/](http://www.nokia.com/phones/declaration_of_conformity/).

© 2008 Nokia. All rights reserved.

Nokia, Nokia Connecting People, Nokia Original Enhancements logos, Nseries, N78, Navi, N-Gage, Visual Radio, and Nokia Care are trademarks or registered trademarks of Nokia Corporation. Nokia tune is a sound mark of Nokia Corporation. Other product and company names mentioned herein may be trademarks or tradenames of their respective owners.

Reproduction, transfer, distribution, or storage of part or all of the contents in this document in any form without the prior written permission of Nokia is prohibited.

**symbian**

This product includes software licensed from Symbian Software Ltd © 1998-2007. Symbian and Symbian OS are trademarks of Symbian Ltd.

US Patent No 5818437 and other pending patents. T9 text input software Copyright © 1997-2007. Tegic Communications, Inc. All rights reserved.



**Java**  
POWERED

Java and all Java-based marks are trademarks or registered trademarks of Sun Microsystems, Inc.

Portions of the Nokia Maps software are copyright © 1996-2002 The FreeType Project. All rights reserved.

This product is licensed under the MPEG-4 Visual Patent Portfolio License (i) for personal and noncommercial use in connection with information which has been encoded in compliance with the MPEG-4 Visual Standard by a consumer engaged in a personal and noncommercial activity and (ii) for use in connection with MPEG-4 video provided by a licensed video provider. No license is granted or shall be implied for any other use. Additional information, including that related to promotional, internal, and commercial uses, may be obtained from MPEG LA, LLC. See <http://www.mpegla.com>.

Nokia operates a policy of ongoing development. Nokia reserves the right to make changes and improvements to any of the products described in this document without prior notice.

TO THE MAXIMUM EXTENT PERMITTED BY APPLICABLE LAW, UNDER NO CIRCUMSTANCES SHALL NOKIA OR ANY OF ITS LICENSORS BE RESPONSIBLE FOR ANY LOSS OF DATA OR INCOME OR ANY SPECIAL, INCIDENTAL, CONSEQUENTIAL OR INDIRECT DAMAGES HOWSOEVER CAUSED.

THE CONTENTS OF THIS DOCUMENT ARE PROVIDED "AS IS". EXCEPT AS REQUIRED BY APPLICABLE LAW, NO WARRANTIES OF ANY KIND, EITHER EXPRESS OR IMPLIED, INCLUDING, BUT NOT LIMITED TO, THE IMPLIED WARRANTIES OF MERCHANTABILITY AND FITNESS FOR A PARTICULAR PURPOSE, ARE MADE IN RELATION TO THE ACCURACY, RELIABILITY OR CONTENTS OF THIS DOCUMENT. NOKIA RESERVES THE RIGHT TO REVISE THIS DOCUMENT OR WITHDRAW IT AT ANY TIME WITHOUT PRIOR NOTICE.

For the most current product information, please refer to [www.nokia.com.cn](http://www.nokia.com.cn).

The third-party applications provided with your device may have been created and may be owned by persons or entities not affiliated with or related to Nokia. Nokia does not own the copyrights or intellectual property rights to the third-party applications. As such, Nokia does not take any responsibility for end-user support, functionality of the applications, or the information in the applications or these materials. Nokia does not provide any warranty for the third-party applications.

BY USING THE APPLICATIONS YOU ACKNOWLEDGE THAT THE APPLICATIONS ARE PROVIDED AS IS WITHOUT WARRANTY OF ANY KIND, EXPRESS OR IMPLIED, TO THE MAXIMUM EXTENT PERMITTED BY APPLICABLE LAW. YOU FURTHER ACKNOWLEDGE THAT NEITHER NOKIA NOR ITS AFFILIATES MAKE ANY REPRESENTATIONS OR WARRANTIES, EXPRESS OR IMPLIED, INCLUDING BUT NOT LIMITED TO WARRANTIES OF TITLE, MERCHANTABILITY OR FITNESS FOR A PARTICULAR PURPOSE, OR THAT THE APPLICATIONS WILL NOT INFRINGE ANY THIRD-PARTY PATENTS, COPYRIGHTS, TRADEMARKS, OR OTHER RIGHTS.

The availability of particular products and applications and services for these products may vary by region. Please check with your Nokia dealer for details, and availability of language options.

#### Export controls

This device may contain commodities, technology or software subject to export laws and regulations from the US and other countries. Diversion contrary to law is prohibited.

#### FCC/INDUSTRY CANADA NOTICE

Your device may cause TV or radio interference (for example, when using a telephone in close proximity to receiving equipment).The FCC or Industry Canada can require you to stop using your telephone if such interference cannot be eliminated. If you require assistance, contact your local service facility. This device complies with part 15 of the FCC rules. Operation is subject to the following two conditions: (1) This device may not cause harmful interference, and (2) this device must accept any interference received, including interference that may cause undesired operation. Any changes or modifications not expressly approved by Nokia could void the user's authority to operate this equipment.

/Issue 1

# Contents

## For your safety .....10

About your device.....	11
Network services.....	12
Enhancements, batteries, and chargers.....	12

## Get started.....13

Keys and parts (front).....	13
Keys and parts (back).....	14
Insert (U)SIM card and battery.....	14
Switch the device on.....	15
Charge the battery.....	15
Wrist strap.....	16

## Get connected.....17

## Find help.....18

In-device help.....	18
Get started.....	18
Nokia support and contact information.....	18
Additional applications.....	18
Settings.....	19
Access codes.....	19
Prolong battery life.....	19
Free memory.....	20

## Your device.....22

Antenna locations.....	22
Welcome.....	22
Nokia Switch.....	22
Transfer content.....	22

Synchronise, retrieve, or send content.....	23
Display indicators.....	24
Shortcuts.....	25
Lock the keypad.....	25
Find items.....	26
Navi™ wheel.....	26
Multimedia menu.....	27
Mobile search.....	27
Games.....	28
Headset.....	28
Volume and loudspeaker control.....	29
Offline profile.....	30

## Personalise your device.....31

Themes.....	31
Change the look of your device.....	31
Audio themes.....	32
Set tones.....	32
3-D tones.....	33
Modify the standby mode.....	33
Modify the main menu.....	34

## Positioning (GPS).....35

About GPS.....	35
Assisted GPS (A-GPS).....	35
Hold your device correctly.....	36
Tips on creating a GPS connection.....	36
Position requests.....	37
Landmarks.....	38
GPS data.....	38

Route guidance.....	39	Listen to internet radio stations.....	56
Retrieve position information.....	39	Favourite stations.....	56
Trip meter.....	39	Search for stations.....	57
<b>Maps.....</b>	<b>41</b>	Station directory.....	57
About Maps.....	41	Internet radio settings.....	57
Browse maps.....	41	<b>Camera.....</b>	<b>59</b>
Download maps.....	43	About the camera.....	59
Find a place.....	44	Activate the camera.....	59
Plan a route.....	44	Image capture.....	59
<b>Music folder.....</b>	<b>46</b>	Still image camera indicators.....	59
Music player.....	46	Active toolbar.....	60
Play a song or a podcast episode.....	46	Capture images.....	61
Music menu.....	47	Location information.....	62
Playlists.....	47	After taking a picture.....	62
Podcasts.....	48	Flash.....	62
Transfer music to your device.....	48	Camera flash.....	63
Transfer music from PC.....	49	Scenes.....	63
Transfer with Windows Media Player.....	49	Take pictures in a sequence.....	63
Nokia Music Store.....	50	You in the picture—self-timer.....	64
Nokia Podcasting.....	51	Tips on taking good photographs.....	64
Podcasting settings.....	51	Video recording.....	65
Search podcasts.....	52	Video capture indicators.....	65
Directories.....	52	Record videos.....	66
Downloads.....	53	After recording a video.....	66
Play and manage podcasts.....	53	Camera settings.....	67
Radio applications.....	54	Still image camera settings.....	67
Visual Radio.....	54	Setup settings—adjust colour and lighting.....	68
Listen to the radio.....	54	Video settings.....	69
View visual content.....	55	<b>Photos.....</b>	<b>70</b>
Saved stations.....	55	About Photos.....	70
Visual Radio settings.....	55	View images and videos.....	70
Nokia Internet Radio.....	56	View and edit file details.....	71

Organise images and videos.....	71
Active toolbar.....	72
Albums.....	72
Tags.....	72
Slide show.....	73
Edit images.....	73
Image editor.....	73
Crop image.....	74
Reduce red-eye.....	74
Useful shortcuts.....	74
Edit videos.....	74
Edit videos.....	74
Edit video, sound, image, text, and transitions.....	75
Edit video clips to send.....	75
Print images.....	76
Image print.....	76
Printer selection.....	76
Print preview.....	76
Print settings.....	77
Share images online.....	77
<b>Gallery.....</b>	<b>78</b>
Main view.....	78
Sounds.....	79
Streaming links.....	79
Presentations.....	79
<b>Nokia Video Centre.....</b>	<b>80</b>
View and download videos.....	80
Internet videos.....	81
Play downloaded videos.....	81
Transfer videos from your PC.....	81
Video Centre settings.....	82

<b>Web browser.....</b>	<b>83</b>
Browse the web.....	83
Browser toolbar.....	84
Navigate pages.....	85
Web feeds and blogs.....	85
Widgets.....	86
Content search.....	86
Download and purchase items.....	86
Bookmarks.....	87
Empty the cache.....	87
End the connection.....	87
Connection security.....	88
Web settings.....	88
<b>Connections.....</b>	<b>90</b>
Active data connections.....	90
Bluetooth connectivity.....	91
About Bluetooth connectivity.....	91
Settings.....	91
Security tips.....	92
Send data using Bluetooth connectivity.....	92
Pair devices.....	93
Receive data using Bluetooth connectivity.....	93
Block devices.....	94
Remote SIM mode.....	94
USB.....	94
PC connections.....	95
<b>Media folder.....</b>	<b>96</b>
RealPlayer.....	96
Play video clips.....	96
Stream content over the air.....	96
RealPlayer settings.....	97
Adobe Flash Player.....	97

Licences.....	97	View messages on a SIM card.....	110
Recorder.....	98	Messaging settings.....	110
<b>Write text.....</b>	<b>99</b>	Text message settings.....	110
Input method indicators.....	99	Multimedia message settings.....	111
Default input method.....	99	E-mail settings.....	112
Switch input methods.....	99	Manage mailboxes.....	112
Pinyin input method.....	99	Connection settings.....	112
Use Pinyin input method.....	99	User settings.....	113
Pinyin input example: To input characters for "Pinyin".....	101	Retrieval settings.....	113
Automatic retrieval settings.....	113		
Stroke input method.....	101	Web service message settings.....	114
Use Stroke input method.....	102	Cell broadcast settings.....	114
Stroke input example: To input characters for "birthday".....	103	Other settings.....	114
Insert special characters and punctuation marks in Chinese input mode.....	103	<b>Make calls.....</b>	<b>116</b>
Traditional text input.....	103	Calls.....	116
Predictive text input.....	104	Options during a call.....	116
Tips on text input.....	104	Voice mailbox.....	117
<b>Messaging.....</b>	<b>105</b>	Answer or decline a call.....	117
Messaging main view.....	105	Make a conference call.....	117
Write and send messages.....	106	Speed dial a phone number.....	118
Messaging inbox.....	107	Call waiting.....	118
Receive messages.....	107	Voice dialling.....	118
Multimedia messages.....	107	Log.....	119
Data, settings, and web service messages.....	108	Recent calls.....	119
Mailbox.....	108	Call duration.....	119
Define the e-mail settings.....	108	Packet data.....	120
Open the mailbox.....	108	Monitor all communication events.....	120
Retrieve e-mail messages.....	109	<b>Contacts (phonebook).....</b>	<b>121</b>
Delete e-mail messages.....	109	Save and edit names and numbers.....	121
Disconnect from the mailbox.....	110	Manage names and numbers.....	121
		Default numbers and addresses.....	122
		Add ringing tones for contacts.....	122

Copy contacts.....	122
SIM directory and other SIM services.....	123
Manage contact groups.....	123

## **Time management.....125**

Clock .....	125
Alarm clock.....	125
World clock.....	125
Calendar.....	125
Create a calendar entry.....	125
Calendar views.....	126
Manage calendar entries.....	127
Lunar calendar.....	127

## **Office folder.....128**

Quickoffice.....	128
Quickword.....	128
Quicksheet.....	128
Quickpoint.....	129
Quickmanager.....	129
Notes.....	129
Adobe PDF reader.....	129
Converter.....	129

## **Applications folder.....131**

Calculator.....	131
Application manager.....	131
Install applications and software .....	131
Remove applications and software.....	133
Settings.....	133

## **Tools folder.....135**

File manager.....	135
Voice commands.....	135

Sync.....	136
Device manager.....	137

## **Settings.....138**

General settings.....	138
Personalisation settings.....	138
Enhancement settings.....	139
Security settings.....	140
Phone and SIM.....	140
Certificate management.....	140
Security module.....	142
Restore original settings.....	142
Navi wheel settings.....	142
Positioning settings.....	142
Phone settings.....	143
Call settings.....	143
Call divert.....	144
Call barring.....	144
Network settings.....	144
Connection settings.....	145
Data connections and access points.....	145
Access points.....	145
Create a new access point.....	145
Packet data access points.....	146
Packet data settings.....	146
Configurations.....	147
Application settings.....	147

## **Troubleshooting.....148**

## **Nokia original enhancements.....150**

Enhancements.....	150
Title?.....	150
Battery.....	151



<b>Battery information.....</b>	<b>152</b>
Charging and discharging.....	152
Nokia battery authentication guidelines.....	153
Authenticate hologram.....	153
What if your battery is not authentic?.....	153
<b>Care and maintenance.....</b>	<b>155</b>
.....	156
<b>Additional safety information.....</b>	<b>157</b>
Small children.....	157
Operating environment.....	157
Medical devices.....	157
Implanted medical devices.....	157
Hearing aids.....	158
Vehicles.....	158
Potentially explosive environments.....	159
Certification information (SAR).....	159
Emergency calls.....	160
<b>MANUFACTURER'S LIMITED WARRANTY.....</b>	<b>161</b>
Warranty period.....	161
How to get warranty service.....	162
What is not covered?.....	162
Other important notices.....	163
Limitation of Nokia's liability.....	164
Statutory obligations.....	164
<b>How to obtain an English Nokia N78 User Guide.....</b>	<b>166</b>
<b>Index.....</b>	<b>167</b>

# For your safety

Read these simple guidelines. Not following them may be dangerous or illegal. Read the complete user guide for further information.



## SWITCH ON SAFELY

Do not switch the device on when wireless phone use is prohibited or when it may cause interference or danger.



## ROAD SAFETY COMES FIRST

Obey all local laws. Always keep your hands free to operate the vehicle while driving. Your first consideration while driving should be road safety.



## INTERFERENCE

All wireless devices may be susceptible to interference, which could affect performance.



## SWITCH OFF IN HOSPITALS

Follow any restrictions. Switch the device off near medical equipment.



## SWITCH OFF IN AIRCRAFT

Follow any restrictions. Wireless devices can cause interference in aircraft.



## SWITCH OFF WHEN REFUELING

Do not use the device at a refueling point. Do not use near fuel or chemicals.



## SWITCH OFF NEAR BLASTING

Follow any restrictions. Do not use the device where blasting is in progress.



## USE SENSIBLY

Use only in the positions as explained in the product documentation. Do not touch the antenna areas unnecessarily.



## QUALIFIED SERVICE

Only qualified personnel may install or repair this product.



## ENHANCEMENTS AND BATTERIES

Use only approved enhancements and batteries. Do not connect incompatible products.



## WATER-RESISTANCE

Your device is not water-resistant. Keep it dry.



### BACK-UP COPIES

Remember to make back-up copies or keep a written record of all important information stored in your device.



### CONNECTING TO OTHER DEVICES

When connecting to any other device, read its user guide for detailed safety instructions. Do not connect incompatible products.



### EMERGENCY CALLS

Ensure the phone function of the device is switched on and in service. Press the end key as many times as needed to clear the display and return to the standby mode. Enter the emergency number, then press the call key. Give your location. Do not end the call until given permission to do so.

## About your device

The wireless device described in this guide is approved for use on the GSM 850, 900, 1800, and 1900 networks. Contact your service provider for more information about networks.

When using the features in this device, obey all laws and respect local customs, privacy and legitimate rights of others, including copyrights.

Copyright protections may prevent some images, music (including ringing tones), and other content from being copied, modified, transferred, or forwarded.

Your device supports internet connections and other methods of connectivity. Like computers, your device may be exposed to viruses, malicious messages and applications, and other harmful content. Exercise caution and open messages, accept connectivity requests, download content, and accept installations only from trustworthy sources. To increase the security of your devices, consider installing, using, and regularly updating antivirus software, firewall, and other related software on your device and any connected computer.



**Warning:** To use any features in this device, other than the alarm clock, the device must be switched on. Do not switch the device on when wireless device use may cause interference or danger.

The office applications support common features of Microsoft Word, PowerPoint, and Excel (Microsoft Office 2000, XP, and 2003). Not all file formats can be viewed or modified.

Your device may have preinstalled bookmarks and links for third-party internet sites. You may also access other third-party sites through your device. Third-party sites are not affiliated with Nokia, and Nokia does not endorse or assume liability for them. If you choose to

access such sites, you should take precautions for security or content.

The images in this guide may differ from your device display.

## Network services

To use the phone you must have service from a wireless service provider. Many of the features require special network features. These features are not available on all networks; other networks may require that you make specific arrangements with your service provider before you can use the network services. Your service provider can give you instructions and explain what charges will apply. Some networks may have limitations that affect how you can use network services. For instance, some networks may not support all language-dependent characters and services.

Your service provider may have requested that certain features be disabled or not activated in your device. If so, these features will not appear on your device menu. Your device may also have a special configuration such as changes in menu names, menu order, and icons. Contact your service provider for more information.

This device supports WAP 2.0 protocols (HTTP and SSL) that run on TCP/IP protocols. Some features of this device, such as MMS, browsing, and e-mail require network support for these technologies.

## Enhancements, batteries, and chargers

Always switch the device off and disconnect the charger before removing the battery.

Check the model number of any charger before use with this device. This device is intended for use when supplied with power from the AC-6, AC-4, AC-5, or DC-4 charger.

The exact charger model number may vary depending on the type of plug. For example, the model numbers for the AC-4 charger can be, among others, AC-4C, AC-4U, or AC-4X. The charger model offered to mainland China is AC-6C.

The battery intended for use with this device is BL-6F.



**Warning:** Use only batteries, chargers, and enhancements approved by Nokia for use with this particular model. The use of any other types may invalidate any approval or warranty, and may be dangerous.

For availability of approved enhancements, please check with your dealer. When you disconnect the power cord of any enhancement, grasp and pull the plug, not the cord.

# Get started

## Keys and parts (front)

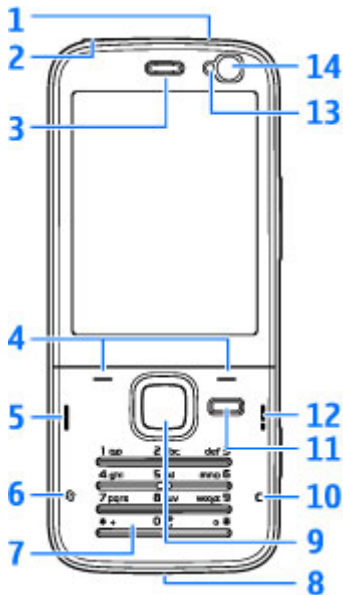

1 — Power key

2 — Nokia AV Connector (3.5 mm) for compatible headsets, and headphones

3 — Earpiece

4 — Selection keys

5 — Call key

6 — Menu key 

7 — Numeric keypad

8 — Microphone

9 — Navi™ wheel. Hereinafter referred to as the scroll key.

10 — Clear key 

11 — Multimedia key

12 — End key

13 — Light sensor

14 — Secondary camera with lower resolution

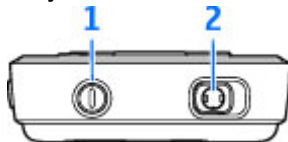

## Keys and parts (back)

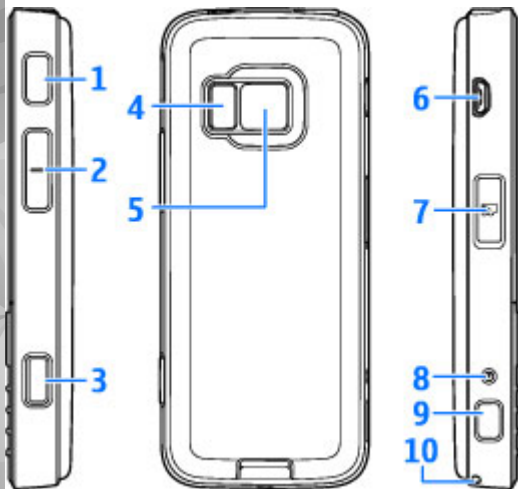

- 1 — Stereo speakers with 3-D sound effect on each side of the device
- 2 — Zoom/volume key
- 3 — 2-stage capture key for auto-focus, still image capture, and video recording
- 4 — LED flash
- 5 — Main camera for high resolution (up to 3.2 megapixels) image capture and video recording

- 6 — Micro USB connector to connect to a compatible PC
- 7 — Memory card slot for a compatible microSD card
- 8 — Charger connector
- 9 — Hole for a wrist strap

## Insert (U)SIM card and battery

A USIM card is an enhanced version of the SIM card and is supported by UMTS mobile phones.

Always switch the device off and disconnect the charger before removing the battery.

1. With the back of the device facing you, press and hold the release button and lift up the cover.
2. Insert the SIM card into the card holder. Ensure that the bevelled corner on the card is facing toward the slot, and that the contact area on the card is facing down.

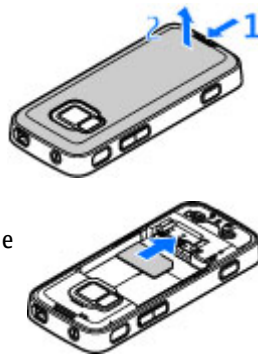

3. Insert the battery.
4. To replace the cover, direct the top locking catch toward its slot first and then press down until the cover locks into place.

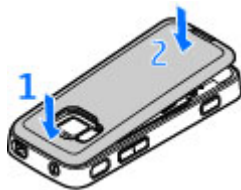

## Switch the device on

1. Press and hold the power key.
2. If the device asks for a PIN code or lock code, enter it, and press the left selection key. The factory setting for the lock code is **12345**.

Your device has internal antennas.



**Note:** Your device may have internal and external antennas. As with any radio transmitting device, avoid touching the antenna unnecessarily when the antenna is in use. Contact



with such an antenna affects the communication quality, may cause the device to operate at a higher power level than otherwise needed and may reduce the battery life.



- 1 — Bluetooth antenna and GPS receiver
- 3 — Cellular antenna

## Charge the battery

1. Connect a compatible charger to a wall outlet.
2. Connect the power cord to the device. If the battery is completely discharged, it may take a while before the charging indicator starts scrolling.
3. When the battery is fully charged, the charging indicator stops scrolling. Disconnect the charger from the device, then from the wall outlet.





**Tip:** Disconnect the charger from the wall outlet when the charger is not in use. A charger that is connected to the outlet consumes power even when it is not connected to the device.

## Wrist strap

1. Remove the back cover.
2. Thread a strap as shown and tighten it.
3. Replace the cover.





# Get connected

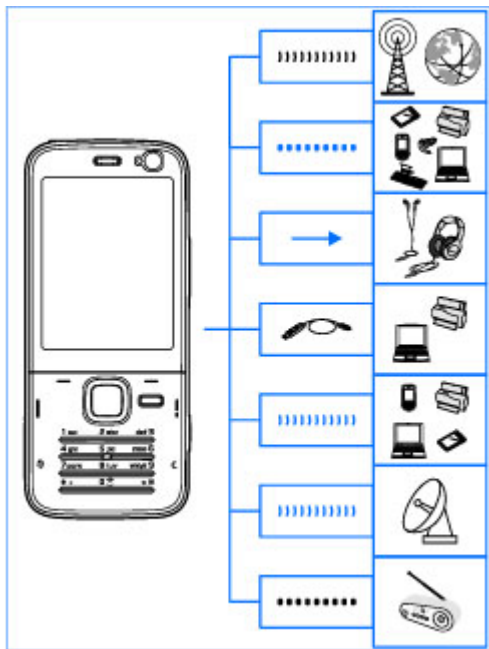

Your device supports the following connectivity methods:





- 2G network
- Bluetooth connectivity — to transfer files and connect to compatible enhancements. [See "Bluetooth connectivity", p. 91.](#)
- Nokia AV connector (3.5 mm) — to connect to compatible headsets, headphones, or home stereo sets
- USB data cable — to connect to compatible devices, such as printers and PCs. [See "USB", p. 94.](#)
- GPS — to receive transmissions from GPS satellites to measure your location. [See "Positioning \(GPS\)", p. 35.](#)

# Find help

## In-device help

Your device has context-sensitive help.

When an application is open, select **Options** > **Help** to access help for the current view. To open help from the main menu, select **Tools** > **Utilities** > **Help**. Select the desired application to view its help topics.

If you browse through Help, at the end of a help text you can find links to related topics. You can also change the size of the text to make it easier to read.  a link to a related help topic.  a link to an application being discussed. Dotted underlining indicates a short term explanation that opens as a pop-up box. When you are reading the instructions, to switch between help and the application that is open in the background, press and hold  or select the application link (.

## Get started

See the get started guide for keys and parts information, instructions for setting up the device and for other essential information.

## Nokia support and contact information

Check [www.nokia.com.cn/support](http://www.nokia.com.cn/support) or your local Nokia website for the latest guides, additional information, downloads, and services related to your Nokia product. You may also download free configuration settings such as MMS, GPRS, e-mail, and other services for your device model at [www.nokia.com.cn/settings](http://www.nokia.com.cn/settings).

If you need to contact customer service, check the list of local Nokia Care contact centres at [www.nokia.com.cn/contactus](http://www.nokia.com.cn/contactus).

For maintenance services, check your nearest Nokia Care point at [www.nokia.com.cn/repair](http://www.nokia.com.cn/repair).

## Additional applications

There are various applications provided by Nokia and different third-party software developers that help you do more with your device. These applications are explained in the guides that are available on the product support pages of the Nokia website.

## Settings

Your device normally has MMS, GPRS, streaming, and mobile internet settings automatically configured in the device, based upon your network service provider information. You may have settings from your service providers already installed in your device, or you may receive or request the settings from the network service providers as a special message.

You can change the general settings in your device, such as language, standby mode, display, and keypad lock settings. [See "General settings", p. 138.](#)

## Access codes

If you forget any of the access codes, contact your service provider.

- Personal identification number (PIN) code — This code protects your SIM card against unauthorised use. The PIN code (4 to 8 digits) is usually supplied with the SIM card. After three consecutive incorrect PIN code entries, the code is blocked, and you need the PUK code to unblock it.
- PIN2 code — This code (4 to 8 digits) is supplied with some SIM cards, and is required to access some functions in your device.

- Lock code (also known as security code) — This code (5 digits) can be used to lock the device to avoid unauthorised use. The factory setting for the lock code is **12345**. To avoid unauthorised use of your device, change the lock code. Keep the new code secret and in a safe place separate from your device. Try entering the code only once, if you forget the code. If the code you entered is not correct, contact a Nokia Care point or your service provider for further instructions.
- Personal unblocking key (PUK) code and PUK2 code — These codes (8 digits) are required to change a blocked PIN code or PIN2 code, respectively. If the codes are not supplied with the SIM card, contact the operator whose SIM card is in your device.

## Prolong battery life

Many features in your device increase the demand on battery power and reduce the battery life time. To save battery power, note the following:

- Features that use Bluetooth technology, or allowing such features to run in the background while using other features, increase the demand on battery power. Turn Bluetooth technology off when you do not need it.
- If you have set **Packet data connection to When available** in connection settings, and

there is no packet data coverage (GPRS), the device periodically tries to establish a packet data connection. To prolong the operating time of your device, select **Packet data connection > When needed**.

- The Maps application downloads new map information when you scroll to new areas on the map, which increases the demand on battery power. You can prevent the automatic download of new maps. [See "Maps", p. 41.](#)
- If the signal strength of the cellular network varies much in your area, your device must scan for the available network repeatedly. This increases the demand on battery power.
- The backlight of the display increases the demand on battery power. In the display settings, you can change the time-out after which the backlight is switched off, and adjust the light sensor that observes lighting conditions and adjusts the display brightness. Press **⚙**, and select **Tools > Settings > General > Personalisation > Display and Light time-out or Light sensor**.
- Leaving applications running in the background increases the demand on battery power. To close the applications you do not use, press and hold **⚙**, scroll to an application in the list, and press **C**.

Pressing **C** does not close Music player. To close Music player, select it from the list and **Options > Exit**.

## Free memory

Many features of the device use memory to store data. The device notifies you if the device memory or the memory card memory (if available) is low.

To view how much memory different data types consume, press **⚙**, and select **Tools > File mgr.**, the desired memory, and **Options > Details > Memory**.

To free device memory, transfer data to a compatible memory card (if available) or to a compatible PC.

To remove data you no longer need, use File manager or go to the respective application. You can remove the following:

- Messages in the folders in Messaging and retrieved e-mail messages from the mailbox
- Saved web pages
- Contact information
- Calendar notes
- Applications shown in Application manager that you do not need

- Installation files (.sis or .sisx) of applications you have installed. Transfer the installation files to a compatible PC.
- Images and video clips in Photos. Back up the files to a compatible PC using Nokia Nseries PC Suite.

If you are deleting multiple items and a note **Not enough memory to perform operation. Delete some data first.** or **Memory low. Delete some data from phone memory.** is shown, delete items one by one, beginning with the smallest items.

# Your device

## Antenna locations

Your device has internal antennas.



**Note:** Your device may have internal and external antennas. As with any radio transmitting device, avoid touching the antenna unnecessarily when the antenna is in use. Contact with such an antenna affects the communication quality, may cause the device to operate at a higher power level than otherwise needed and may reduce the battery life.



1 — Bluetooth antenna and GPS receiver

3 — Cellular antenna

## Welcome

When you switch on your device, the Welcome application is displayed.

Select from the following:

- **Sett. wizard** — to configure various settings, such as e-mail. For more information on the Settings wizard application, see the guides available at the Nokia product support pages or your local Nokia website.
- **Switch** — to transfer content, such as contacts and calendar entries, from a compatible Nokia device. [See "Transfer content", p. 22.](#)

There may also be a demonstration about your device available in the Welcome application.

To access the Welcome application later, press , and select **Tools** > **Utilities** > **Welcome**. You can also access the individual applications from their menu locations.

## Nokia Switch

### Transfer content

You can use the **Switch** application to copy content such as phone numbers, addresses, calendar items, and images from your previous Nokia device to your new device using Bluetooth connectivity.

The type of content that can be transferred depends on the model of the device from which you want to transfer content. If that device supports synchronisation, you can also synchronise data between the devices. Your device notifies you if the other device is not compatible.

If the other device cannot be switched on without a SIM card, you can insert your SIM card in it. When your device is switched on without a SIM card, the offline profile is automatically activated.

### Transfer content for the first time

1. To retrieve data from the other device for the first time, on your device, select **Switch** in the Welcome application, or press , and select **Tools > Utilities > Switch**.
2. Select the connection type you want to use to transfer the data. Both devices must support the selected connection type.
3. If you select Bluetooth, connect the two devices. To have your device search for devices with Bluetooth connectivity, select **Continue**. Select the device from which you want to transfer content. You are asked to enter a code on your device. Enter a code (1-16-digits), and select **OK**. Enter the same code on the other device, and select **OK**. The devices are now paired. [See "Pair devices", p. 93.](#)

Some earlier Nokia devices do not already have the Switch application. In this case the Switch application is sent to the other device as a message. To install the Switch application on the other device, open the message, and follow the instructions on the display.

4. From your device, select the content you want to transfer from the other device.

When the transfer has started, you can cancel it and continue later.

Content is transferred from the memory of the other device to the corresponding location in your device. The transfer time depends on the amount of data to be transferred.

### Synchronise, retrieve, or send content

After the first transfer, select from the following to start a new transfer, depending on the model of the other device:

 to synchronise content between your device and the other device, if the other device supports synchronisation. The synchronisation is two-way. If an item is deleted in one device, it is deleted in both. You cannot restore deleted items with synchronisation.

 to retrieve content from the other device to your device. With retrieval, content is transferred from the other device to your device. You may be asked to keep or delete the original content in the other device, depending on the device model.

 to send content from your device to your other device

If **Switch** cannot send an item, depending on the type of the other device, you can add the item to the **Nokia folder** to **C:\Nokia** or **E:\Nokia** and send it from there. When you select the folder to transfer, the items are synchronised in the corresponding folder in the other device, and vice versa.

### Use shortcuts to repeat a transfer

After a data transfer, you can save a shortcut with the transfer settings to the main view to repeat the same transfer later.

To edit the shortcut, scroll to it, and select **Options** > **Shortcut settings**. You can, for example, create or change the name of the shortcut.

A transfer log is shown after every transfer. To view the log of a previous transfer, scroll to a shortcut in the main view, and select **Options** > **View log**.

### Handle transfer conflicts

If an item to be transferred has been edited in both devices, the device attempts to merge the changes automatically. If this is not possible, there is a

transfer conflict. Select **Check one by one**, **Priority to this phone**, or **Priority to other phone** to solve the conflict. For further instructions, select **Options** > **Help**.

## Display indicators

 The device is being used in a GSM network (network service).

 You have one or more unread messages in the **Inbox** folder in Messaging.

 You have received new e-mail in the remote mailbox.

 There are messages waiting to be sent in the **Outbox** folder.

 You have missed calls.

 The ringing type is set to silent.

 A timed profile is active.

 The device keypad is locked.



 A clock alarm is active.



 All calls to the device are diverted to another number (network service).

 A compatible microSD card is in the device.

 A compatible headset is connected to the device.



 A GPRS packet data connection is active (network service).  indicates the connection is on hold and  that a connection is available.

 A packet data connection is active in a part of the network that supports EGPRS (network service).  indicates the connection is on hold and  that a connection is available. The icons indicate that EGPRS is available in the network, but your device is not necessarily using EGPRS in the data transfer.

 Bluetooth connectivity is on. [See "Bluetooth connectivity", p. 91.](#)

 Data is being transmitted using Bluetooth connectivity. When the indicator is blinking, your device is trying to connect with another device.

 A USB connection is active.

 Synchronisation is in progress.

## Shortcuts

When in the menus, instead of using the scroll key, you can use the number keys, #, and \* to quickly access the applications. For example, in the main menu, press **2** to open Messaging, or **#** to open the application or folder in the corresponding location in the menu.

To switch between open applications, press and hold . Leaving applications running in the

background increases the demand on battery power and reduces the battery life.

To open the multimedia menu to view the multimedia content you have used most frequently in your device, press the multimedia key.

To start a web connection (network service), in the standby mode, press and hold **0**.

In many applications, to view the most common option items () , press the scroll key.

To change the profile, press the power key, and select a profile.

To switch between the **General** and **Silent** profiles, in the standby mode, press and hold **#**.

To call your voice mailbox (network service), in the standby mode, press and hold **1**.

To open the last dialled numbers list, in the standby mode, press the call key.

To use voice commands, in the standby mode, press and hold the right selection key.

## Lock the keypad

To lock the keys, press the left selection key, then **\***.

To unlock the keys, press the left selection key, then **\***.

You can select to lock the keypad automatically after a time-out. [See "Security settings", p. 140.](#)

In low light conditions, it is possible to illuminate the keypad by briefly pressing the power key.

## Find items

When a search field is available in the application, you can use the search field to search for a name, file, or application.

1. To search for an item, enter text in the search field. The device will immediately start to search and filter the entries matching to the text you input. The more texts you input, the more accurate the search result will be. When entering text, use the input methods included in your device. The current input method indicator will be shown in the search field near the magnifier icon.
2. After finding your needed item, press the scroll key to open it.

## Navi™ wheel

Hereafter referred to as the scroll key.

Use the scroll key to move around the menus and lists (up, down, left, or right). Press the scroll key to

select the action shown on top of the key or to show the most used options .

When the Navi wheel setting is switched on in the settings, you can scroll quickly through Photos, Music Player, Nokia Video Centre, Contacts, and Messaging lists, or the multimedia menu. [See "Navi wheel settings", p. 142.](#)

1. Move the tip of your finger gently around the rim of the scroll key clockwise or counterclockwise. Keep moving your finger until scrolling starts on the display.
2. To continue scrolling, slide your finger around the rim of the scroll key clockwise or counterclockwise.



**Tip:** When you start using quick scrolling, move your finger slowly around the rim of the scroll key to get used to the feature, and increase the speed little by little.

## Sleep mode indicator

When the device is on standby, the rim inside the Navi wheel lights up slowly. The light varies periodically as if the device was breathing. The breathing is quicker if there are missed calls or received messages.

To switch off breathing, press **⌘**, and select **Tools > Settings > General > Sensor settings** and select `{No display_text mapping for 'qtn_set_sensor_breathing.gssensorplugin', locale='en'}`.

## Multimedia menu

With the multimedia menu, you can access your most frequently used multimedia content. The selected content is shown in the appropriate application.

1. To open or close the multimedia menu, press the multimedia key.
2. To browse the tiles, scroll left or right, or, if the Navi wheel setting is set on, slide your finger on the rim of the scroll key. [See "Navi wheel", p. 26.](#)

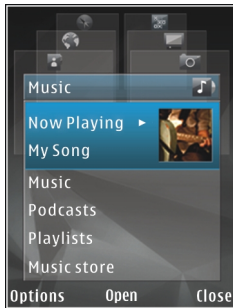

The tiles are the following:

- **Music** — Enter Music player and the Now playing view, browse your songs and playlists, or download and manage podcasts.

- **Videos** — View your last taken videos.
  - **Images** — View your most recently taken picture, start a slide show of your images, or view media files in albums.
  - **Games** — Try out N-Gage games (network service).
  - **Maps** — View your favourite locations in the Maps application.
  - **Internet** — View your favourite web links in the browser.
  - **Contacts** — Add your own contacts, send messages, or make voice calls. To add a new contact to an empty position on the list, press the scroll key, and select a contact. To send a message, in the multimedia menu, select a contact, and **Options > Send text message** or **Send multimedia msg.**
3. To scroll up or down in a tile, press the scroll key up or down. To select items, press the scroll key.

To change the order of the tiles, select **Options > Arrange tiles**.

To return to the multimedia menu from an open application, press the multimedia key.

## Mobile search

Press **⌘**, and select **Search**.

Use Mobile Search to access internet search engines and to find and connect to local services, websites, images, and mobile content. You can also search content in your device, such as calendar entries, e-mail, and other messages.

### Web search (network service)

1. In the Search main view, select **Search the Internet**.
2. Select a search engine.
3. Enter your text to search.
4. Press the scroll key to start the search.

### My content search

To search content in your device, in the main view, enter your text to the search field. The search results are displayed on the screen as you write.

## Games

You can play high-quality multiplayer N-Gage™ games with your device.

Your device includes either one of the following applications in the main menu:

- Discover N-Gage application — With this preview application you can get information about the upcoming N-Gage gaming experience, try out game demos, and download and install the full N-Gage application when it becomes available.

- N-Gage application — The full featured application gives you access to the complete N-Gage experience replacing the Discover N-Gage application in the menu. You can find new games, try and buy games, find other players, and access scores, events, chat, and more. Some features may not be available at the time of software installation on your device, check [www.n-gage.com](http://www.n-gage.com) for software updates.

For the full N-Gage experience, you need internet access on your device through the cellular network. Contact your service provider for more information on data services.

For more information, visit [www.n-gage.com](http://www.n-gage.com).

## Headset

You can connect a compatible headset or compatible headphones to your device. You may need to select the cable mode.



**Warning:** When you use the headset, your ability to hear outside sounds may be affected. Do not use the headset where it can endanger your safety.

Some headsets come in two parts, a remote control unit and headphones. A remote control unit has a microphone and keys to answer or end a phone call, adjust the volume, and play music or video files. To use the headphones with a remote control unit, connect the unit to the Nokia AV Connector (3.5 mm) in the device, then connect the headphones to the unit.

If a headset does not include a microphone, for handsfree phone calls, use such a headset with a compatible remote control unit or the microphone of the device.

When using certain headset enhancements, to adjust the volume during a call, use the volume key in the device. Some headset enhancements have multimedia volume controls that are used to adjust the volume only for music or video playback.

Do not connect products that create an output signal as this may cause damage to the device. Do not connect any voltage source to the Nokia AV Connector.



When connecting any external device or any headset, other than those approved by Nokia for use with this device, to the Nokia AV Connector, pay special attention to volume levels.

## Volume and loudspeaker control

To increase or decrease the volume level when you have an active call or are listening to a sound, use the volume key.

The built-in loudspeaker allows you to speak and listen from a short distance without having to hold the device to your ear.





**Warning:** Do not hold the device near your ear when the loudspeaker is in use, because the volume may be extremely loud.

To use the loudspeaker during a call, press **Loudsp..**

To turn off the loudspeaker, press **Handset.**

## Offline profile

To activate the offline profile, press the power key briefly, and select **Offline**. Or, press , and select **Tools > Profiles > Offline**.

The offline profile lets you use the device without connecting to the wireless network. When you activate the offline profile, the connection to the wireless network is turned off, as indicated by  in the signal strength indicator area. All wireless RF signals to and from the device are prevented. If you try to send messages, they are placed in the outbox to be sent later.

When the offline profile is active, you can use your device without a SIM card.

 **Important:** In the offline profile you cannot make or receive any calls, or use other features that require cellular network coverage. Calls may still be possible to the official emergency number programmed into your device. To make calls, you must first activate the phone function by changing profiles. If the device has been locked, enter the lock code.

To leave the offline profile, press the power key briefly, and select another profile. The device re-enables wireless transmissions (providing there is sufficient signal strength).

# Personalise your device

You can personalise your device by changing the standby mode, main menu, tones, themes, or font size. Most of the personalisation options, such as changing the font size, can be accessed through the device settings. [See "Personalisation settings", p. 138.](#)

## Themes

Press , and select **Tools > Settings > General > Personalisation > Themes.**

## Change the look of your device

Use Themes to change the look of the display, such as the wallpaper and icons.

To change the theme that is used for all the applications in your device, select **General**.

To preview a theme before activating it, select **Options > Preview**. To activate the theme, select **Options > Set**. The active theme is indicated by .

The themes on a compatible memory card (if inserted) are indicated by . The themes on the memory card are not available if the memory card

is not inserted in the device. If you want to use the themes saved in the memory card without the memory card, save the themes in the device memory first.

To change the layout of the main menu, select **Menu view**.

To open a browser connection and download more themes, in **General**, select **Download themes (network service)**.

 **Important:** Use only services that you trust and that offer adequate security and protection against harmful software.

To have a wallpaper image or a slide show of changing images as the background in the standby mode, select **Wallpaper > Image or Slide show**.

To have an animation or a slide show as the power saver, select **Power saver > Animation or Slide show**.

To change the background of the call bubble shown when a call comes in, select **Call image**.

## Audio themes

In Audio themes, you can select a sound scheme such as 'Orchestral' to cover all device events, such as calling, battery low, and mechanical events. The sounds can be tones, synthesised voice tags, or a combination of both.

Select the sound scheme you want to use in **Active audio theme**. Note that activating an audio theme changes all your previous sound settings. If you want to return to using the default tones, select audio theme 'Nokia'.

You can change the sounds for different events individually by selecting one of the sound groups, for example, **Menu events**.

To add 3-D effects to the audio theme, select **Options > 3-D ringing tones**. [See "3-D tones", p. 33.](#)

To change the language that is used for the synthesised voice tag, select **Options > Set Speech language**.

If you have changed the tones of individual events, you can save the theme by selecting **Options > Save theme**.

### Set sounds for events

To set the sound of an individual event to silent, open an event group, select the event, and change it to **Silent**.

To set a synthesised voice tag as the sound for an event, open an event group, select the event, and **Speech**. Enter the desired text, and press **OK**. **Speech** is not available if you have set **Say caller's name** on in **Profiles**. [See "Voice dialling", p. 118.](#)

## Set tones

Press , and select **Tools > Profiles**.

You can set and customise the ringing tones, message alert tones, and other tones for different events, environments, or caller groups.

To change the profile, select a profile, and **Options > Activate**. To also change the profile, press the power key in the standby mode. Scroll to the profile you want to activate, and select **OK**.



**Tip:** To switch between the general and silent profiles in the standby mode, press and hold **#**.

To modify a profile, scroll to the profile, and select **Options > Personalise**. Scroll to the setting you want to change, and press the scroll key to open the choices. Tones stored on a compatible memory card (if inserted) are indicated with .

If you want to set a profile to be active a certain time, select **Options > Personalise > Timed**. When the set time expires the profile changes back to the profiles that was previously active. When a



profile has been timed, you can see ⌚ in the standby mode. The Offline profile cannot be timed.

In the tones list, select **Download sounds** (network service) to open a list of bookmarks. You can select a bookmark and start connection to a web page to download more tones.

If you want the caller's name to be spoken when your device rings, select **Options > Personalise**, and set **Say caller's name** to **On**. The caller's name must be saved in Contacts.

To create a new profile, select **Options > Create new**.

## 3-D tones

Press , select **Tools > Utilities > 3-D tones**.

With 3-D tones, you can enable three-dimensional sound effects for ringing tones. Not all ringing tones support 3-D effects.

To enable the 3-D effects, select **3-D ringing tone effects > On**. To change the ringing tone, select **Ring tone** and the desired ringing tone.

To change the 3-D effect that is applied to the ringing tone, select **Sound trajectory** and the desired effect.

To modify the effect, select from the following settings:

- **Trajectory speed** — Scroll left or right to adjust the speed at which sound moves from one direction to another. This setting is not available for all ringing tones.
- **Reverberation** — Select the type of echo.

To listen to the ringing tone with the 3-D effect, select **Options > Play tone**. If you enable the 3-D tones but do not select any 3-D effect, stereo widening is applied to the ringing tone.

To adjust the ringing tone volume, select **Tools > Profiles > Options > Personalise > Ringing volume**.

## Modify the standby mode

To switch the active standby on or off, press , and select **Tools > Settings > General > Personalisation > Standby mode > Active**

**standby.** The active standby display shows application shortcuts, and events from applications such as calendar and player.

To change the selection key shortcuts or the default shortcut icons in the active standby mode, select **Tools > Settings > General >**

**Personalisation > Standby mode.** Some shortcuts may be fixed, and you cannot change them.

To change the clock shown in the standby mode, press **⌘**, and select **Applications > Clock > Options > Settings > Clock type.**

You can also change the standby mode background image or what is shown in the power saver in the device settings. [See "Change the look of your device", p. 31.](#)

**💡 Tip:** To check whether there are applications running in the background, press and hold **⌘**. To close the applications you do not use, scroll to an application in the list, and press **C**. Leaving applications running in the background increases the demand on battery power.

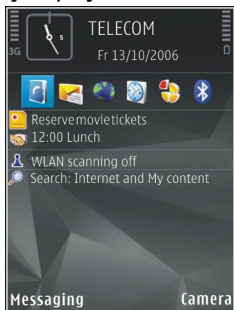

## Modify the main menu

To change the main menu view, in the main menu, press **⌘** and select **Tools > Settings > General > Personalisation > Themes > Menu view.** You can change the main menu to be shown as **Grid, List, Horseshoe, or V-shaped.**

To rearrange the main menu, in the main menu, select **Options > Move, Move to folder, or New folder.** You can move applications used less frequently into folders and place applications that you use more often into the main menu.

# Positioning (GPS)

You can use applications such as Maps and GPS data to find out your location, or measure distances and coordinates. These applications require a GPS connection.

## About GPS

The Global Positioning System (GPS) is a worldwide radio navigation system that includes 24 satellites and their ground stations that monitor the operation of the satellites. Your device has an internal GPS receiver.

A GPS terminal receives low-power radio signals from the satellites and measures the travel time of the signals. From the travel time, the GPS receiver can calculate its location to the accuracy of metres.

The coordinates in the GPS are expressed in degrees and decimal degrees format using the international WGS-84 coordinate system.

The Global Positioning System (GPS) is operated by the government of the United States, which is solely responsible for its accuracy and maintenance. The accuracy of location data can be affected by adjustments to GPS satellites made by the United States government and is subject to change with

the United States Department of Defense civil GPS policy and the Federal Radionavigation Plan. Accuracy can also be affected by poor satellite geometry. Availability and quality of GPS signals may be affected by your location, buildings, natural obstacles, and weather conditions. The GPS receiver should only be used outdoors to allow reception of GPS signals.

Any GPS should not be used for precise location measurement, and you should never rely solely on location data from the GPS receiver and cellular radio networks for positioning or navigation.

To enable or disable different positioning methods, such as Bluetooth GPS, press , and select **Tools > Settings > General > Positioning > Positioning methods**.

## Assisted GPS (A-GPS)

Your device also supports Assisted GPS (A-GPS). A-GPS is a network service.

Assisted GPS (A-GPS) is used to retrieve assistance data over a packet data connection, which assists in calculating the coordinates of your current location

when your device is receiving signals from satellites.

When you activate A-GPS, your device receives useful satellite information from an assistance data server over the cellular network. With the help of assisted data, your device can obtain the GPS position faster.

Your device is preconfigured to use the Nokia A-GPS service, if no service provider-specific A-GPS settings are available. The assistance data is retrieved from the Nokia A-GPS service server only when needed.

You must have an internet access point defined in the device to retrieve assistance data from the Nokia A-GPS service over a packet data connection. To define an access point for A-GPS, press **ⓘ**, and select **Tools > Settings > General > Positioning > Positioning server > Access point**. Only a packet data internet access point can be used. Your device asks for the internet access point when GPS is used for the first time.

## Hold your device correctly

The GPS receiver is located in the top of the device. When using the receiver, from an upright position, move the device to an angle of about 45 degrees, with an unobstructed view of the sky.

Establishing a GPS connection may take from a couple of seconds to tens of minutes.

Establishing a GPS connection in the car, in bad weather conditions, or in a challenging geographical environment may take longer.

The GPS receiver draws its power from the device battery. Using the GPS receiver may drain the battery faster.



## Tips on creating a GPS connection

If your device cannot find the satellite signal, consider the following:

- If you are indoors, go outdoors to receive a better signal.
- If you are outdoors, move to a more open space.

- Ensure that your hand does not cover the GPS antenna of your device. See ["Hold your device correctly"](#) , p. 36.



- If the weather conditions are bad, the signal strength may be affected.
- Some vehicles have tinted (athermic) windows, which may block the satellite signals.

### Check satellite signal status

To check how many satellites your device has found, and whether your device is receiving satellite signals, press , and select **Tools** > **Connectivity** > **GPS data** > **Position** > **Options** > **Satellite status**. Or, in the Maps application, select **Options** > **Map options** > **Satellite info**.

If your device has found satellites, a bar for each satellite is shown in the satellite info view. The longer the bar, the stronger the satellite signal. When your device has received enough data from the satellite signal to calculate the coordinates of your location, the bar turns black.

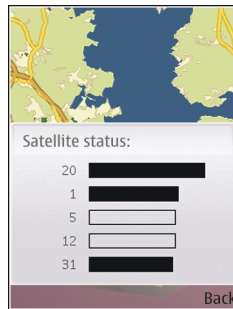

Initially your device must receive signals from at least four satellites to be able to calculate the coordinates of your location. When the initial calculation has been made, it may be possible to continue calculating the coordinates of your location with three satellites. However, the accuracy is generally better when more satellites are found.

### Position requests

You may receive a request from a network service to receive your position information. Service providers may offer information about local topics, such as weather or traffic conditions, based on the location of your device.

When you receive a position request, a message is displayed showing the service that is making the request. Select **Accept** to allow your position information to be sent or **Reject** to deny the request.

## Landmarks

Press , and select **Tools > Connectivity > Landmarks**.

With Landmarks, you can save the position information of specific locations in your device. You can sort the saved locations into different categories, such as business, and add other information to them, such as addresses. You can use your saved landmarks in compatible applications, such as **GPS data** and **Maps**.

GPS coordinates are expressed in degrees and decimal degrees format using the international WGS-84 coordinate system.

To create a new landmark, select **Options > New landmark**. To make a positioning request for your current location, select **Current position**. To enter the position information manually, select **Enter manually**.

To edit or add information to a saved landmark (for example, a street address), scroll to a landmark, and

select **Options > Edit**. Scroll to the desired field, and enter the information.

You can sort your landmarks into preset categories, and create new categories. To edit and create new landmark categories, scroll right in Landmarks, and select **Options > Edit categories**.

To add a landmark to a category, scroll to the landmark in Landmarks, and select **Options > Add to category**. Scroll to each category to which you want to add the landmark, and select it.

To send one or several landmarks to a compatible device, select **Options > Send**. Your received landmarks are placed in the **Inbox** folder in Messaging.

## GPS data

GPS data is designed to provide route guidance information to a selected destination, position information about your current location, and traveling information, such as the approximate distance to the destination and approximate duration of travel.

Press , and select **Tools > Connectivity > GPS data**.

The coordinates in the GPS are expressed in degrees and decimal degrees format using the international WGS-84 coordinate system.

To use GPS data, the GPS receiver of your device must initially receive position information from at least four satellites to calculate the coordinates of your location. When the initial calculation has been made, it may be possible to continue calculating the coordinates of your location with three satellites. However, the accuracy is generally better when more satellites are found.

## Route guidance

Press **⌘**, and select **Tools > Connectivity > GPS data > Navigation**.

Start the route guidance outdoors. If started indoors, the GPS receiver may not receive the necessary information from the satellites.

Route guidance uses a rotating compass on the device display. A red ball shows the direction to the destination, and the approximate distance to it is shown inside the compass ring.

Route guidance is designed to show the straightest route and the shortest distance to the destination, measured in a straight line. Any obstacles on the route, such as buildings and natural obstacles, are ignored. Differences in altitude are not taken into account when calculating the distance. Route guidance is active only when you move.

To set your trip destination, select **Options > Set destination** and a landmark as the destination, or

enter the latitude and longitude coordinates. Select **Stop navigation** to clear the destination set for your trip.

## Retrieve position information

Press **⌘**, and select **Tools > Connectivity > GPS data > Position**.

In the position view, you can view the position information of your current location. An estimate of the accuracy of the location is displayed.

To save your current location as a landmark, select **Options > Save position**. Landmarks are saved locations with more information, and they can be used in other compatible applications and transferred between compatible devices.

## Trip meter

Press **⌘**, and select **Tools > Connectivity > GPS data > Trip distance**.

Select **Options > Start** to activate trip distance calculation, and **Stop** to deactivate it. The calculated values remain on the display. Use this feature outdoors to receive a better GPS signal.

Select **Reset** to set the trip distance and time and average and maximum speeds to zero, and to start a new calculation. Select **Restart** to set the odometer and total time to zero.

The trip meter has limited accuracy, and rounding errors may occur. Accuracy can also be affected by availability and quality of GPS signals.



# Maps

Map availability varies by country /region. To the maximum extent permitted by the applicable law, Nokia disclaims any and all warranty with respect to the availability, accuracy, correctness or update of maps.

## About Maps

Press , and select **Maps**.

With Maps, you can see your current location on the map, browse maps for different cities and countries, search for addresses and different points of interest, plan routes from one location to another, and save locations as landmarks and send them to compatible devices.

Some maps may be pre-loaded on the memory card in your device. You can download more maps through the internet using Nokia Map Loader PC software. [See "Download maps", p. 43.](#)

Downloading maps may involve the transmission of large amounts of data through your service provider's network. Contact your service provider for information about data transmission charges.

Maps uses GPS. [See "Positioning \(GPS\)", p. 35.](#) You can define the positioning methods used with your device in the device settings. [See "Positioning settings", p. 142.](#) For the most accurate location information, use either the internal GPS or a compatible external GPS receiver.

When you use Maps for the first time, you may need to define an internet access point for downloading map information for your current location. To change the default access point later, select **Options > Settings > Network > Default access point**.

To receive a note when your device registers to a network outside your home cellular network, select **Options > Settings > Network > Roaming warning > On**. Contact your network service provider for details and roaming costs.

Almost all digital cartography is inaccurate and incomplete to some extent. Never rely solely on the cartography provided for use in this device.

## Browse maps

The map coverage varies by country.

When you open the Maps application, Maps zooms in to the location that was saved from your last session. If no position was saved from the last session, the Maps application zooms in to the capital city of the country you are in based on the information the device receives from the cellular network. At the same time, the map of the location is downloaded, if it has not been downloaded during previous sessions.

To establish a GPS connection and zoom in to your current location, select **Options > Find place > GPS position [0]**, or press **0**

If the power saver turns on while the device is attempting to establish a GPS connection, the attempt is interrupted.

A GPS indicator  is shown on the display when you browse maps. When the device tries to establish a GPS connection, the circles are yellow. When the device receives enough data from the satellites to calculate the coordinates of your current location, the circles turn green.

To view information about satellites when you are using Maps, select **Options > Map options > Satellite info**.

## Move on the map

Your current location is indicated on the map with . To move on the map, scroll up, down, left, or right. When you browse the map on the display, a new map is automatically downloaded if you scroll to an area which is not covered by maps already downloaded. These maps are free of charge, but downloading may involve the transmission of large amounts of data through your service provider's network. For more information on data transmission charges, contact your service provider. The maps are automatically saved in the device memory or on a compatible memory card (if inserted).

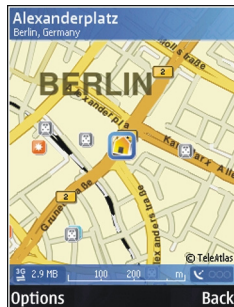

## Edit the map view

To zoom in or out, press **\*** or **#**.

To switch between the 2D and 3D views, select **Options > Map options > 2D/3D**.

To define what kinds of points of interest are shown on the map, select **Options > Map options > Categories** and the desired categories.

To adjust the network, routing, and general settings, select **Options** > **Settings**.

### Find and save locations

To find a location, select **Options** > **Find place**. You can choose to go to your GPS position, find an address, find a point of interest by entering a keyword, or find locations nearby.

To use a location on the map, for example, as a starting point for a nearby search, to plan a route, or view its details, press the scroll key, and select the desired option.

To save a location as a landmark, in the desired location, press the scroll key, select **Save** > **As landmark**, enter a name for the landmark, and select the categories you want to include it in. To take a screen shot of your location, select **Save** > **As image**. The screen shot is saved in Photos. To send the screen shot, select **Options** > **Use this place** > **Send**, and the method. You can also send the screen shot in Photos.

To view saved landmarks, select **Options** > **Find place** > **Landmark**.

To send a landmark to a compatible device, in the landmarks view, press the scroll key, and select **Send**. If you send the landmark in a text message, the information is converted to plain text.

## Download maps

When you browse a map on the display in Maps, a new map is automatically downloaded if you scroll to an area which is not covered by maps already downloaded. You can view the amount of transferred data from the data counter (kB) shown on the display. The counter shows the amount of network traffic when you browse maps, create routes, or search for locations online.

To prevent the device from automatically downloading maps through the internet, for example, when you are outside your home cellular network, select **Options** > **Settings** > **Network** > **Use network** > **Never**.

To define how much memory card space you want to use for saving maps or voice guidance files, select **Options** > **Settings** > **Network** > **Max. memory card use (%)**. This option is available only when a compatible memory card is inserted. When the memory is full, the oldest map data is deleted. The saved maps data can be deleted using Nokia Map Loader PC software.

### Nokia Map Loader

Nokia Map Loader is PC software that you can use to download and install maps from the internet to a compatible memory card.

To use Nokia Map Loader, you must first install it to a compatible PC. You can download the PC software from the internet at [www.nokia.com/maps](http://www.nokia.com/maps). Follow the instructions on the screen.

You must use the Maps application and browse maps at least once before using Nokia Map Loader. Nokia Map Loader uses the Maps history information to check the version of map data to be downloaded.

After you have installed the PC software to your PC, to download maps, do the following:

1. Connect your device to the PC by using a compatible USB data cable. Select **Mass storage** as the USB connection mode.
2. Open Nokia Map Loader in your PC. Nokia Map Loader checks the version of map data to be downloaded.
3. Select the maps or voice guidance files you want, and download and install them to your device.

## Find a place

To view points of interest near your current location or other locations on the map, select **Options** > **Find place** > **Nearby** and a category.

To search for a point of interest by name, select **Options** > **Find place** > **Keyword search** or start

entering the first letters of the name, and select **Find**.

To search for a location by address, select **Options** > **Find place** > **By address**. You must enter the city and country. To use an address you have saved to a contact card in Contacts, select **Options** > **Find place** > **By address** > **Options** > **Select from contacts**.

To view a search result on the map, press the scroll key, and select **Show on map**. To return to the results list, select **Back**.

To view a list of your previous locations, select **Options** > **Find place** > **Recent**.

## Plan a route

To plan a route from one location to another (for example, from your home to your office), do the following:

1. Scroll to a point on the map, press the scroll key, and select **Route from**.
2. Scroll to **From**, and select **Options** > **Select** and the desired option.

To adjust the routing settings, such as the mode of transportation, select **Options** > **Settings** > **Routing**.

3. To select the destination, scroll to **To**, and select **Options** > **Select** and the desired option.
4. To view the route itinerary, select **Options** > **Show route**. The route is calculated using the selected routing settings.

To view the itinerary route on the map, select **Options** > **Show on map**.

To run a simulation of the route, select **Options** > **Start simulation**.



**Tip:** You can also use a compatible GPS receiver with Bluetooth connectivity with Maps. For example, in a car, an external GPS receiver can be positioned so that it has a clear view of the sky. Enable the use of an external GPS receiver in positioning settings. [See "Positioning settings", p. 142.](#)

# Music folder

## Music player



**Warning:** Listen to music at a moderate level. Continuous exposure to high volume may damage your hearing. Do not hold the device near your ear when the loudspeaker is in use, because the volume may be extremely loud.

Music player supports file formats such as AAC, AAC+, eAAC+, MP3, and WMA. Music player does not necessarily support all features of a file format or all the variations of file formats.

You can also use Music player to listen to podcast episodes. Podcasting is the method for delivering audio or video content over the internet using either RSS or Atom technologies for playback on mobile devices and PCs.

You can transfer music from other compatible devices to your device. [See "Transfer music to your device", p. 48.](#)

## Play a song or a podcast episode

You may have to refresh the music and podcast libraries after you have updated the song or podcast selection in your device. To add all available items

to the library, in the Music player main view, select **Options** > **Refresh**.

To play a song or a podcast episode, do the following:

1. Press , and select **Music** > **Music player**.
2. Select **Music** or **Podcasts**.
3. Select categories to navigate to the song or podcast episode you want to hear. If the Navi wheel setting is set on in the settings, to browse the lists, slide your finger on the rim of the scroll key .
4. To play the selected files, press the scroll key.

To pause playback, press the scroll key; to resume, press the scroll key again. To stop playback, scroll down.

To fast forward or rewind, press and hold the scroll key to the right or left.

To go to the next item, scroll right. To return to the beginning of the item, scroll left. To skip to the previous item, scroll left again within 2 seconds after a song or podcast has started.

To switch random play (⌘) on or off, select **Options > Shuffle**.

To repeat the current item (⏮), all items (⏮), or to switch repeat off, select **Options > Repeat**.

If you play podcasts, shuffle and repeat are automatically switched off.

To adjust the volume, press the volume key.

To modify the tone of the music playback, select **Options > Equaliser**.

To modify the balance and stereo image or to enhance bass, select **Options > Audio settings**.

To view a visualisation during playback, select **Options > Show visualisation**.

To return to the standby mode and leave the player playing in the background, press the end key, or to

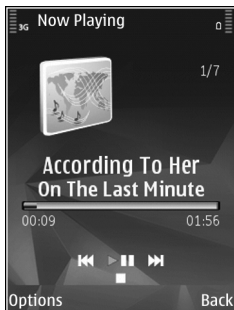

switch to another open application, press and hold ⌘.

To close the player, select **Options > Exit**.

## Music menu

Press ⌘, and select **Music > Music player > Music**.

The music menu shows the available music. Select the desired option in the music menu to view all songs, sorted songs, or playlists.

When the Music player is playing in the background, to open the Now playing view, press and hold the multimedia key.

## Playlists

Press ⌘, and select **Music > Music player > Music**.

To view and manage playlists, in the music menu, select **Playlists**.

To view details of the playlist, select **Options > Playlist details**.

### Create a playlist

1. Select **Options > Create playlist**.
2. Enter a name for the playlist, and select **OK**.
3. To add songs now, select **Yes**; or to add the songs later, select **No**.

- If you select **Yes**, select artists to find the songs you want to include in the playlist. Press the scroll key to add items.

To show the song list under an artist title, scroll right. To hide the song list, scroll left.

- When you have made your selections, select **Done**.

If a compatible memory card is inserted, the playlist is saved to the memory card.

To add more songs later, when viewing the playlist, select **Options** > **Add songs**.

To add songs, albums, artists, genres, and composers to a playlist from the different views of the music menu, select an item and **Options** > **Add to playlist** > **Saved playlist** or **New playlist**.

To remove a song from a playlist, select **Options** > **Remove**. This does not delete the song from the device; it only removes it from the playlist.

To reorder songs in a playlist, scroll to the song you want to move, and select **Options** > **Reorder list**. To grab songs and drop them to a new position, use the scroll key.

## Podcasts

Press **⌘**, and select **Music** > **Music player** > **Podcasts**.

The podcast menu displays the podcasts available in the device.

Podcast episodes have three states: never played, partially played, and completely played. If an episode is partially played, it plays from the last playback position the next time it is played. If an episode is never played or completely played, it plays from the beginning.

## Transfer music to your device

You can transfer music from a compatible PC or other compatible devices using a compatible USB data cable or Bluetooth connectivity.

PC requirements for music transfer:

- Microsoft Windows XP operating system (or later)
- A compatible version of the Windows Media Player application. You can get more detailed information about Windows Media Player compatibility from your device's product pages on the Nokia website.
- Nokia Nseries PC Suite 1.6 or later

Windows Media Player 10 may cause playback delays to WMDRM technology protected files after they have been transferred to your device. Check Microsoft support website for a hotfix to Windows Media Player 10 or get a newer compatible version of Windows Media Player.



## Transfer music from PC

You can use three different methods to transfer music:

- To view your device on a PC as a mass memory device where you can transfer any data files, make the connection with a compatible USB data cable or Bluetooth connectivity. If you are using the USB cable, select **Mass storage** as the connection mode. A compatible memory card needs to be inserted in the device.
- To synchronise music with Windows Media Player, connect the compatible USB data cable and select **Media transfer** as the connection mode. A compatible memory card needs to be inserted in the device.
- To use Nokia Music Manager in Nokia Nseries PC Suite, connect the compatible USB data cable and select **PC Suite** as the connection mode.

Use **Mass storage** and **Media transfer** modes to transfer files to a compatible memory card.

To change the default USB connection mode, press **Ⓜ**, and select **Tools > Connectivity > USB > USB connection mode**.

Both Windows Media Player and Nokia Music Manager in Nokia Nseries PC Suite have been optimised to transfer music files. For information about transferring music with Nokia Music

Manager, see the help function on Nokia Nseries PC Suite or visit the Nokia support pages.

## Transfer with Windows Media Player

Music synchronisation functions may vary between different versions of the Windows Media Player application. For more information, see the corresponding Windows Media Player guides and help. The following instructions are for Windows Media Player 11.

### Manual synchronisation

With manual synchronisation, you can select the songs and playlists that you want to move, copy, or remove.

1. After your device is connected with Windows Media Player, select your device in the navigation pane on the right, if more than one device is connected.
2. In the left navigation pane, browse the music files on your PC which you want to synchronise.
3. Drag and drop songs to the **Sync List** on the right.  
You can see the amount of available memory in your device above the **Sync List**.
4. To remove songs or albums, select an item in the **Sync List**, right-click, and select **Remove from list**.
5. To start the synchronisation, click **Start Sync**.

## Automatic synchronisation

1. To activate the automatic synchronisation function in Windows Media Player, click the **Sync** tab, select **Nokia Handset > Set Up Sync...**, and check the **Sync this device automatically** check box.
2. Select the playlists you want to synchronise automatically in the **Available playlists** pane, and click **Add**.  
The selected items are transferred to the **Playlists to sync** pane.
3. To finalise the setup for automatic synchronisation, click **Finish**.

When the **Sync this device automatically** check box is checked and you connect your device to the PC, the music library in your device is automatically updated based on the playlists you select for synchronisation in Windows Media Player. If no playlists have been selected, the whole PC music library is selected for synchronisation. If there is not enough free memory in your device, Windows Media Player selects manual synchronisation automatically.

To stop automatic synchronisation, click the **Sync** tab, and select **Stop Sync to 'Nokia Handset'**.

## Nokia Music Store

In the Nokia Music Store (network service) you can search, browse, and purchase music to download to your device. To purchase music, you first need to register for the service.

To check the Nokia Music Store availability in your country, visit [music.nokia.com](http://music.nokia.com).

To access the Nokia Music Store, you must have a valid internet access point in the device.

To open Nokia Music Store, press , and select **Music > Music store**.

To find more music in different categories of the music menu, select **Options > Find in Music store**.

### Nokia Music Store settings

The availability and appearance of the music store settings may vary. The settings may also be predefined and not editable. If the settings are not predefined, you may be asked to select the access point to use when connecting to the music store. To select the access point, select **Default acc. pt.**

In the music store, you may be able to edit the settings by selecting **Options > Settings**.

# Nokia Podcasting

With the Nokia Podcasting application (network service), you can search, discover, subscribe to, and download podcasts over the air, and play, manage, and share audio and video podcasts with your device.

 **Warning:** Listen to music at a moderate level. Continuous exposure to high volume may damage your hearing. Do not hold the device near your ear when the loudspeaker is in use, because the volume may be extremely loud.

## Podcasting settings

Before using Nokia Podcasting, set your connection and download settings.

Check with your service provider for terms and data service fees before using other connections. For example, a flat rate data plan can allow large data transfers for one monthly fee.

### Connection settings

To edit the connection settings, press , and select **Music > Podcasting > Options > Settings > Connection**.

Define the following:

- **Default access point** — Select the access point to define your connection to the internet.

- **Search service URL** — Define the podcast search service to be used in searches.

### Download settings

To edit the download settings, press , and select **Music > Podcasting > Options > Settings > Download**.

Define the following:

- **Save to** — Define the location where you want to save your podcasts.
- **Update interval** — Define how often podcasts are updated.
- **Next update date** — Define the date of the next automatic update.
- **Next update time** — Define the time of next automatic update.

Automatic updates only occur if a specific default access point is selected and Nokia Podcasting is running. If Nokia Podcasting is not running, the automatic updates are not activated.

- **Download limit (%)** — Define the size of the memory that is used for podcast downloads.
- **If limit exceeds** — Define what to do if the downloads exceed the download limit.

Setting the application to retrieve podcasts automatically may involve the transmission of large amounts of data through your service provider's network. Contact your service provider for information about data transmission charges.

To restore the default settings, select **Options** > **Restore default** in the settings view.

## Search podcasts

Search helps you to find podcasts by keyword or title.

The search engine uses the podcast search service you set up in **Podcasting** > **Options** > **Settings** > **Connection** > **Search service URL**.

To search for podcasts, press , select **Music** > **Podcasting** > **Search**, and enter the desired keywords.



**Tip:** Search looks for podcast titles and keywords in descriptions, not specific episodes. General topics, such as football or hip-hop, usually give better results than a specific team or artist.

To subscribe to marked channels and add them to your podcasts, select **Subscribe**. You can also add a podcast by selecting one.

To start a new search, select **Options** > **New search**.

To go the website of the podcast, select **Options** > **Open web page** (network service).

To see the details of a podcast, select **Options** > **Description**.

To send selected podcasts to another compatible device, select **Options** > **Send**.

## Directories

Directories help you to find new podcast episodes to which to subscribe.

To open directories, press , and select **Music** > **Podcasting** > **Directories**.

Contents of the directories change. Select the desired directory folder to update it (network service). The colour of the folder changes, when the update is complete.

Directories can include top podcasts listed by popularity or themed folders.

To open the desired folder topic, select it and **Open**. A list of podcasts is displayed.

To subscribe to a podcast, select the title, and **Update**. After you have subscribed to episodes of a podcast, you can download, manage, and play them in the podcasts menu.

To add a new directory or folder, select **Options** > **New** > **Web directory** or **Folder**. Select a title, URL of the .opml (outline processor markup language) file, and **Done**.

To edit the selected folder, web link, or web directory, select **Options** > **Edit**.

To import an .opml file stored on your device, select **Options > Import OPML file**. Select the location of the file, and import it.

To send a directory folder as a multimedia message or using Bluetooth connectivity, select the folder and **Options > Send**.

When you receive a message with an .opml file using Bluetooth connectivity, open the file to save the file into the **Received** folder in directories. Open the folder to subscribe to any of the links to add to your podcasts.

## Downloads

After you have subscribed to a podcast, from directories, search, or by entering a URL, you can manage, download, and play episodes in **Podcasts**.

To see the podcasts you have subscribed to, select **Podcasting > Podcasts**.

To see individual episode titles (an episode is a particular media file of a podcast), select the podcast title.

To start a download, select the episode title. To download or to continue to download selected or marked episodes, select **Download**. You can download multiple episodes at the same time.

To play a portion of a podcast during download or after partial downloading, select the podcast and **Options > Play preview**.

Fully downloaded podcasts can be found in the **Podcasts** folder, but are not shown until the library is refreshed.

## Play and manage podcasts

To display the available episodes from the selected podcast, in **Podcasts**, select **Open**. Under each episode, you see the file format, the size of the file, and time of the upload.

When the podcast is fully downloaded, to play the full episode, select it and **Play**.

To update the selected podcast or marked podcasts, for a new episode, select **Options > Update**.

To stop the updating, select **Options > Stop update**.

To add a new podcast by entering the URL of the podcast, select **Options > New podcast**. If you do not have an access point defined or if during packet data connection you are asked to enter a user name and password, contact your service provider.

To edit the URL of the selected podcast, select **Options > Edit**.

To delete a downloaded podcast or marked podcasts from your device, select **Options** > **Delete**.

To send the selected podcast or marked podcasts to another compatible device as .opml files as a multimedia message or by Bluetooth connectivity, select **Options** > **Send**.

To update, delete, and send a group of selected podcasts at once, select **Options** > **Mark/Unmark**, mark the desired podcasts, and select **Options** to choose the desired action.

To open the website of the podcast (network service), select **Options** > **Open web page**.

Some podcasts provide the opportunity to interact with the creators by commenting and voting. To connect to the internet to do this, select **Options** > **View comments**.

## Radio applications

Press , select **Music** > **Radio**, and **Visual Radio** or **Internet radio**.

## Visual Radio

You can use the radio as a traditional FM radio and automatically tune into and save stations. If you tune into stations that offer the Visual Radio service

(network service), you will see information related to the radio programme on the display.

The radio supports Radio Data System (RDS) functionality. Radio stations supporting RDS may display information, such as the name of the station. If activated in the settings, RDS also attempts to scan for an alternative frequency for the currently playing station, if the reception is weak.

When you open the radio for the first time, a wizard helps you to save local radio stations (network service).

If you cannot access the Visual Radio service, the operators and radio stations in your area may not support Visual Radio.

## Listen to the radio

The FM radio depends on an antenna other than the wireless device antenna. A compatible headset or enhancement needs to be attached to the device for the FM radio to function properly.



Press , and select **Music** > **Radio** > **Visual Radio**.

Note that the quality of the radio broadcast depends on the coverage of the radio station in that particular area.

You can make a call or answer an incoming call while listening to the radio. The radio is muted when there is an active call.

To start a station search, select  or .

To change the frequency manually, select **Options** > **Manual tuning**.

If you have saved radio stations in your device, to go to the next or previous saved station, select  or .

To adjust the volume, use the volume key. Listen to music at a moderate level. Continuous exposure to high volume may damage your hearing. Do not hold the device near your ear when the loudspeaker is in use, because the volume may be extremely loud.

To listen to the radio using the loudspeaker, select **Options** > **Activate loudspeaker**.

To view available stations based on location, select **Options** > **Station directory** (network service).

To save the station to which you are currently tuned to your station list, select **Options** > **Save station**.

To open the list of your saved stations, select **Options** > **Stations**.

To return to the standby mode while listening to the FM radio in the background, select **Options** > **Play in background**.

## View visual content

To check availability and costs and to subscribe to the service, contact your service provider.

To view available visual content for a tuned station, select **Options** > **Start visual service**. If the visual service ID has not been saved for the station, enter it, or select **Retrieve** to search for it in the station directory (network service).

When the connection to the visual service is established, the current visual content is displayed.

## Saved stations

To open the list of your saved stations, select **Options** > **Stations**.

To listen to a saved station, select **Options** > **Station** > **Listen**. To view available visual content for a station with Visual Radio service, select **Options** > **Station** > **Start visual service**.

To change station details, select **Options** > **Station** > **Edit**.

## Visual Radio settings

Press , and select **Music** > **Radio** > **Visual Radio** > **Options** > **Settings**.

- **Alternative frequencies** — To automatically search for alternative frequencies if the reception is weak, select **Auto scan on**.
- **Auto-start service** — To start Visual Radio automatically when you select a saved station that offers Visual Radio service, select **Yes**.

- **Access point** — Select the access point used for the data connection. You do not need an access point to use the application as an FM radio.
- **Current region** — Select the region where you currently are. This setting is displayed only if there is no network coverage when you start the application.

## Nokia Internet Radio

With the Nokia Internet Radio application (network service), you can listen to available radio stations on the internet. To listen to radio stations, you must have a packet data access point defined in your device. Listening to the stations may involve the transmission of large amounts of data through your service provider's network. Check with your service provider for terms and data service fees before using other connections. For example, a flat rate data plan can allow large data transfers for a set monthly fee.

### Listen to internet radio stations

Press , and select **Music > Radio > Internet radio**.

To listen to a radio station on the internet, do the following:

1. Select a station from your favourites or the station directory, or search stations by their name from the Nokia Internet Radio service.

To add a station manually, select **Options > Add station manually**. You can also browse for station links with the Web application. Compatible links are automatically opened in the Internet Radio application.

### 2. Select **Listen**.

The Now playing view opens displaying information about the currently playing station and song.

To stop the playback, press the scroll key; to resume, press the scroll key again.

To adjust the volume, use the volume key. Listen to music at a moderate level. Continuous exposure to high volume may damage your hearing. Do not hold the device near your ear when the loudspeaker is in use, because the volume may be extremely loud.

To view station information, select **Options > Station information** (not available if you have saved the station manually).

If you are listening to a station saved in your favourites, scroll left or right to listen to the previous or next saved station.

### Favourite stations

To view and listen to your favourite stations, press , and select **Music > Radio > Internet radio > Favourites**.



To add a station manually to favourites, select **Options > Add station manually**. Enter the web address of the station and a name that you want to appear in the favourites list.

To add the currently playing station to favourites, select **Options > Add to Favourites**.

To view station information, to move a station up or down in the list, or to delete a station from the favourites, select **Options > Station** and the desired option.

To view only stations beginning with particular letters or numbers, start entering the characters. Matching stations are displayed.

## Search for stations

To search for radio stations in the Nokia Internet Radio service by their name, do the following:

1. In the application main view, select **Search**.
2. Enter a station name or the first letters of it in the search field, and select **Search**.

Matching stations are displayed.

To listen to a station, select it, and **Listen**.

To save a station to your favourites, select it, and **Options > Add to Favourites**.

To make another search, select **Options > Search again**.

## Station directory

Press **⌘**, and select **Radio > Internet radio > Station directory**.

The station directory is maintained by Nokia. If you want to listen to internet radio stations outside the directory, add station information manually or browse for station links on the internet with the Web application.

Select how you want the available stations to be sorted:

- **Browse by genre** — View the available radio station genres.
- **Browse by language** — View the languages in which there are stations broadcasting.
- **Browse by country** — View the countries in which there are stations broadcasting.
- **Top stations** — View the most popular stations in the directory.

## Internet radio settings

Press **⌘**, and select **Music > Radio > Internet radio > Options > Settings**.

To select the default access point to connect to the network, select **Default access point** and from the available options. Select **Always ask** if you want the device to ask for the access point every time you open the application.

To change the connection speeds for different connection types, select from the following:

- **GPRS connection bitrate** — for GPRS packet data connections

The quality of the radio broadcast depends on the selected connection speed. The higher the speed, the better the quality. To avoid buffering, use the highest quality only with high speed connections.

# Camera

## About the camera

Your Nokia N78 has two cameras. The main, high resolution camera (up to 3.2 megapixels), is on the back of the device. The secondary, lower resolution, camera is on the front. You can use both cameras to take still pictures and record videos.

Your device supports an image capture resolution of 2048x1536 pixels. The image resolution in this guide may appear different.

The images and video clips are automatically saved in the Photos application. [See "Photos", p. 70.](#) The cameras produce .jpeg images. Video clips are recorded in the MPEG-4 file format with the .mp4 file extension, or in the 3GPP file format with the .3gp file extension (sharing quality). [See "Video settings", p. 69.](#)

To free memory for new images and video clips, transfer files to a compatible PC using a compatible USB data cable, for example, and remove the files from your device. The device informs you when the memory is full, and asks whether you want to change the memory in use.

You can send images and video clips in a multimedia message, as an e-mail attachment, or by using other

connection methods, such as Bluetooth connectivity. You can also upload them to a compatible online album. [See "Share images online", p. 77.](#)

## Activate the camera

To activate the main camera, press and hold the capture key. To activate the main camera when it is already open in the background, press and hold the capture key.

To close the main camera, select **Exit**.

Keep a safe distance when using the flash. Do not use the flash on people or animals at close range. Do not cover the flash while taking a picture.

## Image capture

### Still image camera indicators

The still image camera viewfinder displays the following:



- 1 — Capture mode indicator
- 2 — Active toolbar. The toolbar is not displayed during image capture. [See "Active toolbar", p. 60.](#)
- 3 — Battery charge level indicator
- 4 — Image resolution indicator
- 5 — Image counter, which displays the estimated number of images you can capture using the current image quality setting and memory in use.
- 6 — The device memory (📁) and memory card (📁) indicators, which show where images are saved
- 7 — GPS signal indicator. [See "Location information", p. 62.](#)

## Active toolbar









The active toolbar provides you with shortcuts to different items and settings before and after capturing an image or recording a video. Scroll to items, and select them by pressing the scroll key.

You can also define when the active toolbar is visible on the display.

The settings in the active toolbar return to the default settings after you close the camera.

To view the active toolbar before and after capturing an image or recording a video, select **Options** > **Show icons**. To view the active toolbar only when you need it, select **Options** > **Hide icons**. To activate the active toolbar when it is hidden, press the scroll key. The toolbar is visible for 5 seconds.

Before capturing an image or recording a video, in the active toolbar, select from the following:

-  to switch between the video mode and the image mode
-  to select the scene
-  to select the flash mode (images only)
-  to activate the self-timer (images only). [See "You in the picture—self-timer", p. 64.](#)
-  to activate the sequence mode (images only). [See "Take pictures in a sequence", p. 63.](#)
-  to select a colour effect
-  to show or hide the viewfinder grid (images only)
-  to adjust white balance

 to adjust the exposure compensation (images only)

 to adjust sharpness (images only)

 to adjust brightness (images only)

 to adjust contrast (images only)

 to adjust light sensitivity (images only)

The icons change to reflect the current setting.

Saving the captured image may take longer if you change the zoom, lighting, or colour settings.

The available options vary depending on the capture mode and view you are in. [See "After taking a picture", p. 62.](#) [See "After recording a video", p. 66.](#) The active toolbar in Photos has different options. [See "Active toolbar", p. 72.](#)

## Capture images

When capturing an image, note the following:

- Use both hands to keep the camera still.
- The quality of a digitally zoomed image is lower than that of a nonzoomed image.
- The camera goes into the battery saving mode if there are no keypresses for a moment. To continue capturing images, press the capture key.

To capture an image, do the following:

1. If the camera is in the video mode, select the image mode from the active toolbar.
2. To lock the focus on an object, press the capture key halfway down (main camera only, not available in landscape or sport scene. [See "Active toolbar", p. 60.](#)) A green locked focus indicator appears on the display. If the focus was not locked, a red focus indicator appears. Release the capture key, and press it halfway down again. You can also capture an image without locking the focus.
3. To capture an image, press the capture key. Do not move the device before the image is saved.



To zoom in or out when capturing an image, use the zoom key in your device.

To activate the front camera, select **Options** > **Use secondary camera**. To capture an image, press the scroll key. To zoom in or out, scroll up or down.



To leave the camera open in the background and use other applications, press . To return to the camera, press and hold the capture key.

## Location information

With geotagging, you can automatically add location information to the file details of the image. For example, in the Photos application you can then view the location where an image was captured.

To activate geotagging in Camera, select **Options** > **Settings** > **Record location** > **Yes**.

Geotagging indicators at the bottom of the display:

-  — Location information unavailable. GPS stays on in the background for several minutes. If a satellite connection is found and the indicator changes to  within that time, all the images captured during that time are tagged based on the received GPS positioning information.
-  — Location information is available. Location information is added to the image information.





See ["Still image camera settings", p. 67.](#)

Geotagged images are indicated by  in the Photos application.

## After taking a picture

After you take a picture, select from the following options in the active toolbar (available only if you select **Show captured image** > **On** in the still image camera settings):

- If you do not want to keep the image, select **Delete** .

- To send the image using a multimedia message, e-mail, or other connection methods, such as Bluetooth connectivity, press the call key, or select **Send** . See ["Write and send messages", p. 106.](#) This option is not available during a call.
- To add the image to an album, select **Add to album** .
- To view information about the image, select **Details** .
- To send the image to a compatible online album, select  (available only if you have set up an account for a compatible online album). See ["Share images online", p. 77.](#)

To zoom in an image after taking it, press  to open the image, and use the zoom key on the side of your device.

To use the image as wallpaper in the active standby mode, select **Options** > **Set as wallpaper**.

To set the image as a call image for a contact, select **Options** > **Set as contact call img.** > **Assign to contact**.

To return to the viewfinder to capture a new image, press the capture key.

## Flash

The flash is available only in the main camera.

Keep a safe distance when using the flash. Do not use the flash on people or animals at close range. Do not cover the flash while taking a picture.

The camera of your device has an LED flash for low light conditions. The following flash modes are available for the still image camera: **Automatic** (🔦), **Red-eye** (👁), **On** (🔦), and **Off** (🚫).

To change the flash mode, in the active toolbar, select the desired flash mode.

## Camera flash

- Text
- Text
- Text
- Text
- Text



**Note:** Text

Title: Text

## Scenes

Scenes are only available in the main camera.

A scene helps you to find the right colour and lighting settings for the current environment. The settings of each scene have been set according to a certain style or environment.

The default scene in the image mode is **Auto**, and in the video mode **Automatic** (both indicated with **A**).

To change the scene, in the active toolbar, select **Scene modes** and a scene.

To make your own scene suitable for a certain environment, scroll to **User defined**, and select **Options** > **Change**. In the user defined scene you can adjust different lighting and colour settings. To copy the settings of another scene, select **Based on scene mode** and the desired scene. To save the changes and return to the scenes list, press **Back**. To activate your own scene, scroll to **User defined**, press the scroll key, and select **Select**.

## Take pictures in a sequence

The sequence mode is available only in the main camera.

To set the camera to take six pictures or the desired number of pictures in sequence (if enough memory is available), in the active toolbar, select **Sequence mode**.

To take six pictures, select **Burst**. To capture the pictures, press the capture key.

To take two or more pictures in a sequence, select the desired time interval. To capture pictures using the selected time interval, press the capture key. To

stop taking pictures, select **Cancel**. The number of pictures taken depends on the available memory.

After you take the pictures in the burst mode, they are shown in a grid on the display. To view a picture, press the scroll key to open it. If you used a time interval, only the last taken picture is shown on the display. You can view the other pictures in the Photos application.

You can also use the sequence mode with the self-timer.

To return to the sequence mode viewfinder, press the capture key.

To switch off the sequence mode, in the active toolbar, select **Sequence mode** > **Single shot**.

## You in the picture—self-timer

The self-timer is available only in the main camera. Use the self-timer to delay the capture so that you can include yourself in the picture.

To set the self-timer delay, in the active toolbar, select **Self timer** > **2 seconds**, **10 seconds**, or **20 seconds**.

To activate the self-timer, select **Activate**. The device beeps when the timer is running and the quadrangle blinks just before the image capture. The camera takes the picture after the selected delay elapses.

To switch off the self-timer, in the active toolbar, select **Self timer** > **Off**.



**Tip:** In the active toolbar, select **Self timer** > **2 seconds** to keep your hand steady when taking a picture.

## Tips on taking good photographs

### Picture quality

Use the appropriate picture quality. The camera has several picture quality modes. Use the highest setting to make sure that the camera produces the best picture quality available. Note however, that better picture quality requires more storage space. For multimedia message (MMS) and e-mail attachments it may be necessary to use the smallest picture quality mode optimised for MMS sending. You can define the quality in the camera settings. [See "Still image camera settings", p. 67.](#)

### Background

Use a simple background. For portraits and other pictures with people, avoid having your subject in front of a cluttered, complex background that may distract attention from the subject. Move the camera, or the subject, when these conditions cannot be met. Move the camera closer to the object to take clearer portraits.



## Depth

When shooting landscapes and sceneries, add depth to your pictures by placing objects in the foreground. If the foreground object is too close to the camera, it may be blurred.

## Lighting conditions

Changing the source, amount, and direction of light can change photographs dramatically. Here are some typical lighting conditions:

- Light source behind the subject. Avoid placing your subject in front of a strong light source. If the light source is behind the subject or visible in the display, the resulting picture may have weak contrast, may be too dark, and may contain unwanted light effects.
- Sidelit subject. Strong side light gives a dramatic effect but may be too harsh, resulting in too much contrast.
- Light source in front of the subject. Harsh sunlight may cause the subjects to squint their eyes. The contrast may also be too high.
- Optimal lighting is found in situations where there is plenty of diffused, soft light available, for example, on a bright, partially cloudy day or on a sunny day in the shadow of trees.



## Video recording

### Video capture indicators

The video viewfinder displays the following:



- 1 — Capture mode indicator
- 2 — Video stabilisation on indicator [See "Video settings", p. 69.](#)
- 3 — Audio mute on indicator
- 4 — Active toolbar. The toolbar is not displayed during recording. [See "Active toolbar", p. 60.](#)
- 5 — Battery charge level indicator
- 6 — Video quality indicator. The options are **High**, **Normal** and **Sharing**.
- 7 — The video clip file type
- 8 — Total available video recording time. When you are recording, the current video length indicator also shows the elapsed time and time remaining.

9 — The device memory () and memory card () indicators that show where videos are saved

To display all viewfinder indicators, select **Options** > **Show icons**. Select **Hide icons** to display only the video status indicators, and during the recording, the time remaining, zoom bar when zooming, and the selection keys.

## Record videos

To record a video, do the following:

1. If the camera is in the image mode, select the video mode from the active toolbar.
2. To start recording, press the capture key. The red record icon () is shown and a tone sounds, indicating that recording has started.
3. To pause recording at any time, press **Pause**. Select **Continue** to resume recording. Video recording automatically stops if recording is set to pause and there are no keypresses within a minute.





To zoom in or out of the subject, use the zoom key in your device.

4. To stop recording, select **Stop**. The video clip is automatically saved in the Photos application. The maximum length of the video clip depends on the available memory.

To activate the front camera, select **Options** > **Use secondary camera**. To start recording a video, press the scroll key. To zoom in or out, scroll up or down.

## After recording a video

After you record a video clip, select from the following options in the active toolbar (available only if **Show captured video** is set to **On** in the video settings):

- To immediately play the video clip you just recorded, select **Play** (.
- If you do not want to keep the video, select **Delete** (.
- To send the video clip using a multimedia message, e-mail, or other connection methods, such as Bluetooth connectivity, press the call key, or select **Send** (). [See "Write and send messages", p. 106.](#) [See "Send data using Bluetooth connectivity", p. 92.](#) This option is not available during a call. You may not be able to send video clips saved in the MPEG-4 file format in a multimedia message.
- To add the video clip to an album, select **Add to album** (.
- To view information about the video clip, select **Details** (.

- To upload the video clip to a compatible online album, select  (only available if you have set up an account for a compatible online album). [See "Share images online", p. 77.](#)
- To return to the viewfinder to record a new video clip, press the capture key.

## Camera settings

There are two kinds of settings for the camera: setup settings and main settings. The setup settings return to the default settings after you close the camera, but the main settings remain the same until you change them again. To adjust the setup settings, use the options in the active toolbar. [See "Setup settings—adjust colour and lighting", p. 68.](#) To change the main settings, in the image or video mode, select **Options > Settings**.

### Still image camera settings

To change the main settings, in the image mode, select **Options > Settings** and from the following:

- **Image quality** — Set the resolution **Print 3M - Large** (2048x1536), **Print 2M - Medium** (1600x1200), **Print 1.3M - Small** (1280x960), **E-mail 0.8M - Med.** (1024x768), or **MMS 0.3M -**

**Small** (640x480). The better the image quality, the more memory the image consumes.

These resolutions are only available in the main camera. The number of images left for the memory in use with the chosen resolution is shown on the display.

- **Add to album** — Save the image to a certain album in Photos. If you select **Yes**, a list of available albums opens.
- **Use tag** — Add a tag to the current image. [See "Tags", p. 72.](#)
- **Record location** — To add GPS location coordinates to each image file, select **Yes**. Receiving GPS signal may take time or the signal may not be available. [See "Location information", p. 62.](#)
- **Show captured image** — To see the captured image after it is taken, select **On**. To continue taking pictures immediately, select **Off**.
- **Default image name** — Define the default name for the captured images
- **Extended digital zoom** (main camera only) — **On (continuous)** allows the zoom increments to be smooth and continuous between digital and extended digital zoom, **On (paused)** allows the zoom increments to pause at the digital and extended digital step point, and **Off** allows a limited amount of zoom while retaining the image resolution.

- **Flicker cancellation** — To avoid screen flickering, select 60 Hz.
- **Capture tone** — Set the tone that sounds when you take a picture.
- **Memory in use** — Choose where to store your images.
- **Restore camera settings** — To return the default values to the camera settings, select Yes.

## Setup settings—adjust colour and lighting

To enable the camera to reproduce colours and lighting more accurately or to add effects to your pictures or videos, scroll through the active toolbar, and select from the following options:

- **Flash mode** (🔦) (images mode only) — Select the desired flash mode.
- **Colour tone** (🎨) — Select a colour effect from the list.
- **White balance** (☀️) — Select the current lighting condition from the list. This allows the camera to reproduce colours more accurately.
- **Exposure compensation** (⦿) (images mode only) — If you are shooting a dark subject against a very light background, such as snow, adjust the exposure to +1 or +2 to compensate the

background brightness. For light subjects against a dark background, use -1 or -2.

- **Sharpness** (📏) (images only) — Adjust the sharpness of the image.
- **Brightness** (☀️) (images only) — Adjust the brightness of the image
- **Contrast** (📏) (images only) — Adjust the difference between the lightest and darkest parts of the image.
- **Light sensitivity** (ISO) (images mode only) — Increase the light sensitivity in low light conditions to decrease the risk of images that are too dark.

The screen display changes to match any settings you make so that you see how the change affects the pictures or videos.

The available settings vary depending on the selected camera.

The setup settings are camera-specific; if you change the settings in the secondary camera, the settings in the main camera do not change. The setup settings are also shooting-mode specific; if you change the settings in the image mode, the settings in the video mode do not change.

Switching between the modes does not reset the defined setup settings.

The setup settings return to the default settings when you close the camera.

If you select a new scene, the colour and lighting settings are replaced by the selected scene. You can change the setup settings after selecting a scene if needed.

## Video settings

To change the main settings, in the video mode, select **Options** > **Settings** and from the following:

- **Video quality** — Set the quality of the video clip. Select **Sharing**, if you want to send the video clip using a multimedia message. The clip is recorded with OCIF resolution, in 3GPP format, and the size is limited to 300 kB (approximately 20 seconds). You may not be able to send video clips saved in the MPEG-4 file format in a multimedia message.
- **Video stabilisation** — Select **On** to reduce the effects of the camera shaking when recording a video.
- **Audio recording** — Select **Mute** if you do not want to record sound.
- **Add to album** — to add the recorded video clip to a certain album in Photos.
- **Show captured video** — to view the first frame of the recorded video clip after the recording stops. To view the entire video clip, select **Play** from the active toolbar (main camera) or **Options** > **Play** (secondary camera).
- **Default video name** — Define the default name for captured video clips.

- **Memory in use** — Select where you want to store your video clips.
- **Restore camera settings** — to restore the camera settings to default values.

# Photos

## About Photos

Press , select **Photos** and from the following:

- **Captured** — to show all the photos and videos you have taken
- **Months** — to show photos and videos categorised by the month they were taken
- **Albums** — to show the default albums and those you have created
- **Tags** — to show tags you have created for each item
- **Downloads** — to show items and videos downloaded from the web or received via MMS or email
- **All** — to view all items

Files stored on your compatible memory card (if inserted) are indicated with .

To open a file, press the scroll key. Video clips open and play in RealPlayer. [See "RealPlayer", p. 96.](#)

To copy or move files to another memory location, select a file, **Options** > **Move and copy**, and from the available options.

## View images and videos

Press , select Photos, and one of the following:

- **All**. — View all photos and videos.
- **Captured** — View pictures taken and video clips recorded with the camera of your device.
- **Downloads** — View downloaded video clips and video clips saved in Video Centre. [See "Nokia Video Centre", p. 80.](#)

Images and video clips can also be sent to you in a multimedia message, as an e-mail attachment, or through Bluetooth connectivity. To be able to view a received image or video clip in Photos, you must first save it.

The images and video clip files are in a loop and ordered by date and time. The number of files is displayed. To browse the files one by one, scroll left or right. To browse files in groups, scroll up or



down. Or, if the Navi wheel setting is activated, to browse the files, slide your finger on the rim of the scroll key. [See "Personalisation settings", p. 138.](#)

To open a file, press the scroll key. When an image opens, to zoom in the image, press the zoom key on the side of your device. The zooming ratio is not stored permanently.

To edit a video clip or a photo, select **Options** > **Edit**. [See "Edit images", p. 73.](#)

To see where an image marked with  was captured, select **Options** > **Show on map**.

To print your images on a compatible printer, or to store them on a compatible memory card (if inserted) for printing, select **Options** > **Print**. [See "Image print", p. 76.](#) To move images to an album for later printing, select **Options** > **Add to album** **Print** later.

## View and edit file details

To view and edit image or video properties, select **Options** > **Details** and from the following:

- **Tags** — Contains currently used tags. Select **Add** to add more tags to the current file. [See "Tags", p. 72.](#)
- **Description** — To add a free-form description of the file, select the field.

- **Location** — This field displays the GPS location information, if available. To edit the location information, select the field.
- **Title** — This field contains a thumbnail image of the file and the current file name. To edit the name, select the field.
- **Albums** — Displays in which albums the current file is located.
- **Resolution** — Displays the size of the image in pixels.
- **Duration** — Displays the length of the video.
- **Usage rights** — Select **View** to view the DRM rights of this file. [See "Licences", p. 97.](#)

## Organise images and videos

You can organise files in Photos as follows:

- To view items in the Tags view, add tags to them. [See "Tags", p. 72.](#)
- To view items by months, select **Months**.
- To create an album to store items, select **Albums** > **Options** > **New album**.

To add an image or a video clip to an album in Photos, select the item and **Add to album** from the active toolbar. [See "Albums", p. 72.](#)

To delete an image or video clip, select the image and **Delete** from the active toolbar.







## Active toolbar

The active toolbar is available only when you have selected an image or a video clip in a view.

In the active toolbar, scroll up or down to different items, and select them by pressing the scroll key. The available options vary depending on the view you are in and whether you have selected an image or a video clip.

To hide the toolbar, select **Options** > **Hide icons**. To activate the active toolbar when it is hidden, press the scroll key.

Select from the following:

-  to play the selected video clip
-  to send the selected image or video clip
-  to upload the selected image or video clip to a compatible online album (only available if you have set up an account for a compatible online album). See "[Share images online](#)", p. 77.
-  to add the selected item to an album
-  to manage tags and other properties of the selected item
-  to delete the selected image or video clip

## Albums

With albums, you can conveniently manage your images and video clips. To view the albums list in Photos, select **Albums** in the main view.

To create a new album in the albums view, select **Options** > **New album**.

To add a picture or a video clip to an album in Photos, scroll to a picture or video clip, and select **Options** > **Add to album**. A list of albums opens. Select the album to which you want to add the picture or video clip. The item you added to the album is still visible in **Photos**.

To remove a file from an album, open the album, scroll to the file, and select **Options** > **Remove from album**.

## Tags

Use tags to categorize media items in Photos. You can create and delete tags in Tag manager. Tag manager shows the tags currently in use and the number of items associated with each tag.

To open Tag manager, select an image or video clip and select **Options** > **Details** > **Tag manager**.

To create a tag, select **Options** > **New tag**.



To view the list in most frequently used order, select **Options > Most used**.

To view the list in alphabetical order, select **Options > Alphabetical**.

To see the tags you have created, select **Tags** in the Photos main view. The size of the tag name corresponds to the number of items the tag is assigned to. Select a tag to view all the images associated with the tag.

To assign a tag to an image, select an image and select **Options > Add tags**.

To remove an image from a tag, open a tag and select **Options > Remove from tag**.

## Slide show

To view your images as a slide show, select an image and **Options > Slide show**. The slide show starts from the selected file.

To view only the selected images as a slide show, select **Options > Mark/Unmark > Mark** to mark images, and **Options > Slide show > Start** to start the slide show.

Select from the following:

- **Pause** — to pause the slide show
- **Continue** — to resume the slide show, if paused
- **End** — to close the slide show

To browse the images, scroll left or right.

Before starting the slide show, adjust the slide show settings. Select **Options > Slide show > Settings**, and from the following:

- **Music** — to add sound to the slide show. Select **On or Off**.
- **Song** — to select a music file from the list
- **Delay between slides** — to adjust the tempo of the slide show
- **Transition** — to make the slide show move smoothly from one slide to another, and zoom in and out in the images randomly

To decrease or increase the volume during the slide show, use the volume key in your device.

## Edit images

### Image editor

To edit the pictures after taking them or the ones already saved in Photos, select **Options > Edit**. The image editor opens.

To open a grid where you can select different edit options indicated by small icons, select **Options > Apply effect**. You can crop and rotate the image; adjust the brightness, colour, contrast, and resolution; and add effects, text, clip art, or a frame to the picture.

## Crop image

To crop an image, select **Options** > **Apply effect** > **Crop**, and a predefined aspect ratio from the list. To crop the image size manually, select **Manual**.

If you select **Manual**, a cross appears in the upper left corner of the image. Use the scroll key to select the area to crop, and select **Set**. Another cross appears in the lower right corner. Again select the area to be cropped. To adjust the first selected area, select **Back**. The selected areas form a rectangle that forms the cropped image.

If you select a predefined aspect ratio, select the upper left corner of the area to be cropped. To resize the highlighted area, use the scroll key. To freeze the selected area, press the scroll key. To move the area within the picture, use the scroll key. To select the area to be cropped, press the scroll key.

## Reduce red-eye

To reduce red-eye in an image, select **Options** > **Apply effect** > **Red eye reduction**.

Move the cross onto the eye, and press the scroll key. A loop appears on the display. To resize the loop to fit the size of the eye, use the scroll key. To reduce the redness, press the scroll key. When you have finished editing the image, press **Done**.

To save the changes and return to the previous view, press **Back**.

## Useful shortcuts

You can use the following shortcuts when editing images:

- To view a full-screen image, press **\***. To return to the normal view, press **\*** again.
- To rotate an image clockwise or counterclockwise, press **3** or **1**.
- To zoom in or out, press **5** or **0**.
- To move on a zoomed image, scroll up, down, left, or right.

## Edit videos

### Edit videos

To edit video clips in Photos, scroll to a video clip, and select **Options** > **Edit** and an editing option.

The video editor supports .3gp and .mp4 video file formats, and .aac, .amr, .mp3, and .wav audio file formats. It does not necessarily support all features of a file format or all the variations of file formats.

## Edit video, sound, image, text, and transitions

To create custom video clips, mark and select one or more video clips, and select **Options** > **Edit** > **Video editor**.

To modify the video, select from the following options:

- **Edit video clip** — to cut the video clip; insert colour effects on the clip; use slow motion; mute or unmute sound; or move, remove, or duplicate the video clip
- **Edit text** (shown only if you added text) — to move, remove, or duplicate text; change the colour and style of the text; define how long it stays on the screen; and add effects to the text
- **Edit image** (shown only if you added an image) — to move, remove, or duplicate an image; define how long it stays on the screen; and set a background or a colour effect to the image
- **Edit sound clip** (shown only if you added a sound clip) — to cut or move the sound clip, to adjust its length, or to remove or duplicate the clip
- **Edit transition** (shown only if you added a transition on the time line) — There are three types of transitions: at the start of a video, at the end of a video, and between video clips.
- **Insert** — Select **Video clip**, **Image**, **Text**, **Sound clip**, or **New sound clip**.

- **Movie** — Preview the movie in full-screen or as a thumbnail, save the movie, or cut the movie to a proper size to send it in a multimedia message.

To take a snapshot of a video clip, in the cut video view, select **Options** > **Take snapshot**. In the thumbnail preview view, press the scroll key, and select **Take snapshot**.

To save your video, select **Options** > **Movie** > **Save**. To define the memory in use, select **Options** > **Settings**. The default is the device memory.

In the video editor settings, you can also define the default video name, default snapshot name, and resolution of the video clip.

## Edit video clips to send

To send a video clip, select **Options** > **Send**, and the desired method. Contact your network service provider for details of the maximum multimedia message size that you can send.

To send a video clip that is over the maximum multimedia message size allowed by your service provider, you can send the clip using Bluetooth connectivity. See ["Send data using Bluetooth connectivity", p. 92](#). You can also transfer your videos to a compatible PC using Bluetooth connectivity, a USB data cable, or a compatible memory card reader enhancement.

You can also cut the video clip to send it in a multimedia message. In the video editor main view, select **Options > Movie > Edit for MMS**. The duration and size of the video clip is displayed. To edit the size of the clip, scroll left or right. When the clip is the proper size to send, select **Options > Send via MMS**.

If your video clip is in .mp4 format, you may not be able to send it in a multimedia message. To change the file format of the clip, scroll to it in Photos, and select **Options > Edit > Video editor > Options > Settings > Resolution > MMS compatible**. Return to the video editor main view, select **Options > Movie > Save**, and enter a name for the clip. The video clip is saved in .3gpp format and can be sent in a multimedia message. The file format of the original video clip does not change.

## Print images

### Image print

To print images with Image print, select the image you want to print, and the print option in Photos, camera, image editor, or image viewer.

Use Image print to print your images using a compatible USB data cable, or Bluetooth connectivity. If a compatible memory card is

inserted, you can store the images to the memory card, and print them using a compatible printer.

You can only print images that are in .jpeg format. The pictures taken with the camera are automatically saved in .jpeg format.

### Printer selection

To print images with Image print, select the image and the print option in Photos, camera, image editor, or image viewer.

When you use Image print for the first time, a list of available compatible printers is displayed. Select a printer. The printer is set as the default printer.

To use a printer compatible with PictBridge, connect the compatible data cable before you select the print option, and check that the data cable mode is set to **Image print** or **Ask on connection**. [See "USB", p. 94](#). The printer is automatically displayed when you select the print option.

If the default printer is not available, a list of available printers is displayed.

To change the default printer, select **Options > Settings > Default printer**.

### Print preview

After you select the printer, the selected images are displayed using predefined layouts.

To change the layout, scroll left or right to browse through the available layouts for the selected printer. If the images do not fit on a single page, scroll up or down to display the additional pages.

## Print settings

The available options vary depending on the capabilities of the printing device you selected.

To set a default printer, select **Options** > **Default printer**.

To select the paper size, select **Paper size**, the size of paper from the list, and **OK**. Select **Cancel** to return to the previous view.

## Share images online

You can share images in compatible online albums, weblogs, or in other compatible online sharing services on the web. You can upload content, save unfinished posts as drafts and continue later, and view the content of the albums. The supported content types may vary depending on the service provider.

To share images online, you must have an account with an online image sharing service. You can usually subscribe to such a service on the web page of your service provider. Contact your service provider for more information.

To upload a file from Photos to the online service, press **⌘**, and select **Photos**. Select an album, scroll to the desired file, and select **Options** > **Send** > **Post to web**, or select the file and  from the active toolbar.







For more information on the application and compatible service providers, see the Nokia product support pages or your local Nokia website.

# Gallery

To access your images, video clips, and songs, or store and organise sound clips and streaming links, press **⌘**, and select **Applications > Media > Gallery**.

## Main view

Press **⌘**, and select **Applications > Media > Gallery**, and from the following:

- **Photos**  — to view images and videos in Photos. [See "About Photos", p. 70.](#)
- **Video clips**  — to view videos in Video Centre
- **Songs**  — to open Music player. [{unresolved reference to ID 'GUID-77973B23-959A-4A87-9912-E6D87548A9D5'}](#)
- **Sound clips**  — to listen to sound clips
- **Streaming links**  — to view and open streaming links
- **Presentations**  — to view presentations

You can browse and open folders and copy and move items to folders. You can also create albums and copy and add items to albums. [See "Albums", p. 72.](#)

Files stored on your compatible memory card (if inserted) are indicated with .

To open a file, press the scroll key. Video clips, RAM files, and streaming links open and play in RealPlayer, and music and sound clips in Music player. [See "RealPlayer", p. 96.](#) [See "Music player", p. 46.](#)

To copy or move files to the memory card (if inserted) or to device memory, select a file and **Options > Move and copy > Copy to memory card** and from the available options.

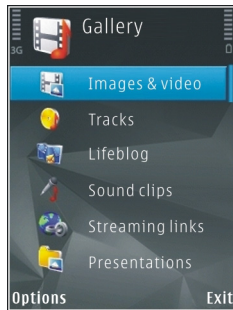

## Sounds

This folder contains all the sounds you have created with the Recorder application or downloaded from the web.

To listen to sound files, press **⌘**, and select **Applications > Media > Gallery > Sound clips**. Scroll to a sound file, and press the scroll key. To pause playing, press the scroll key again.

To fast forward or rewind, scroll right or left.

To download sounds, select the download link.

## Streaming links

To open streaming links, press **⌘**, and select **Applications > Media > Gallery > Streaming links**. Select a link, and press the scroll key.

To add a new streaming link, select **Options > New link**.

## Presentations

With presentations, you can view SVG (scalable vector graphics) files, such as cartoons and maps. SVG images maintain their appearance when printed or viewed with different screen sizes and resolutions.

To view SVG files, press **⌘**, and select **Applications > Media > Gallery > Presentations**. Scroll to an image, and select **Options > Play**. To pause playing, select **Options > Pause**.

To zoom in, press **5**. To zoom out, press **0**.

To rotate the image 90 degrees clockwise or counterclockwise, press **1** or **3**, respectively. To rotate the image 45 degrees, press **7** or **9**.

To switch between full and normal screen, press **\***.

# Nokia Video Centre

With Nokia Video Centre (network service), you can download and stream video clips over the air from compatible internet video services using packet data. You can also transfer video clips from a compatible PC to your device and view them in Video Centre.

Using packet data access points to download videos may involve the transmission of large amounts of data through your service provider's network. Contact your service provider for information about data transmission charges.

All videos are played in the landscape mode by default.

Your device may have predefined services.

Service providers may provide free content or charge a fee. Check the pricing in the service or from the service provider.

## View and download videos

1. Press , and select **Video centre**.

2. To connect to a service, scroll left or right, and select the desired video service.

The device updates and displays the content available in the service.

3. To view videos by categories (if available), scroll down.

To search for videos in the service, select **Video search**. Search may not be available in all services.

4. To view information about a video, select **Options** > **Video details**.

5. Some video clips can be streamed over the air, but others must be first downloaded to your device. To download a video clip, select **Options** > **Download**.

To stream a video clip or view a downloaded clip, select **Options** > **Play**.

To schedule an automatic download for videos in a service, select **Options** > **Schedule**





**downloads.** Automatic downloads are performed daily during the time you define. Videos already in **My videos** are not downloaded.

When the clip is playing, use the scroll key and the selection keys to control the player. To adjust the volume, press the volume key.

Downloads continue in the background if you exit the application. The downloaded videos are saved in **Video centre > My videos**.

To connect to the internet to browse available services that you can add to Video Centre, select **Add new services**.

## Internet videos

Internet videos are video clips distributed in the internet using RSS-based feeds. You can add new feeds to **Internet videos** in the settings.

You can view your feeds in the **Internet videos** folder in Video Centre.

To add or delete feeds, select **Options > Feed subscriptions**.

To view the videos available in a feed, scroll to it, and press the scroll key.

To view information about a video, select **Options > Video details**.

To download a video, scroll to it, and select **Options > Download**.

To play the downloaded video, press the scroll key.

## Play downloaded videos

The downloaded videos are saved in **Video centre > My videos**.

To play a downloaded video, press the scroll key.

When the clip is playing, use the scroll key and the selection keys to control the player.

If there is not enough free space in the device memory and compatible memory card, the application automatically deletes some of the oldest videos when new videos are downloaded.  indicates videos that may soon be deleted.

To prevent a video from being automatically deleted () , select **Options > Protect**.

## Transfer videos from your PC

Transfer your own videos to Video Centre from compatible devices using a compatible USB data cable.

To transfer videos from a compatible PC to the memory card in your device, do the following:

1. To view your device on a PC as a mass memory device (E:\) where you can transfer any data files, make the connection with a compatible USB data cable.
2. Select **Mass storage** as the connection mode. A compatible memory card needs to be inserted in the device.
3. Select the videos you want to copy from your PC.
4. Transfer the videos to **E:\My Videos** in the memory card.

The transferred videos appear in the **My videos** folder in Video Centre. Video files in other folders of your device are not displayed.

## Video Centre settings

In the Video Centre main view, select **Options > Settings** and from the following:

- **Video service selection** — Select the video services you want to appear in Video Centre. You can also view the details of a video service.

Some services require a user name and a password that you receive from the service provider.

- **Default access points** — Select **Always ask** or **User-defined** to choose the access points used for the data connection. Using packet data access points to download files may involve the

transmission of large amounts of data through your service provider's network. Contact your service provider for information about data transmission charges.

- **Parental control** — Activate the parental lock for video services, if the service provider has set age limits for videos.
- **Preferred memory** — Select where the downloaded videos are saved. If the selected memory becomes full, your device saves the content to another memory, if available, or deletes some of the oldest files automatically.
- **Thumbnails** — Select whether to view thumbnail images in video lists.

# Web browser

With the Web browser, you can view hypertext markup language (HTML) web pages on the internet as originally designed. You can also browse web pages that are designed specifically for mobile devices, and use extensible hypertext markup language (XHTML), or the wireless markup language (WML).

The XHTML browser in this device supports the Unicode encoding format.

If the web page is unreadable or not supported and garbage code is found while browsing, you can try to press , and select **Web > Options > Settings > Page > Default encoding**, and select a corresponding encoding.

To browse the web, you need to have an internet access point configured in your device.

## Browse the web

Press , and select **Web**.



**Shortcut:** To start the browser, press and hold **0** in the standby mode.



**Important:** Use only services that you trust and that offer adequate security and protection against harmful software.



**Important:** Only install and use applications and other software from trusted sources, such as applications that are Symbian Signed or have passed the Java Verified™ testing.

To browse a web page, in the bookmarks view, select a bookmark, or enter the address in the field () , and press the scroll key.

Some web pages may contain material, such as graphics and sounds, that requires a large amount of memory to view. If your device runs out of memory while loading such a page, the graphics on the page are not shown.

To browse web pages without graphics, to save memory, select **Options > Settings > Page > Load content > Text only**.

To enter a new web page address you want to visit, select **Options > Go to web address**.



**Tip:** To visit a web page saved as a bookmark in the bookmarks view, while browsing, press **1**, and select a bookmark.

To retrieve the latest content of the page from the server, select **Options > Navigation options > Reload**.

To save the web address of the current page as a bookmark, select **Options > Save as bookmark**.

To use visual history to view snapshots of the pages you have visited during the current browsing session, select **Back** (available if **History list** is set on in the browser settings and the current page is not the first page you visit). To go to a previously visited page, select the page.

To save a page while browsing, select **Options > Tools > Save page**.

You can save pages and browse them later when offline. You can also group these saved pages into folders. To access the pages you have saved, select **Options > Bookmarks > Saved pages**.

To open a sublist of commands or actions for the page that is open, select **Options > Service options** (if supported by the web page).

To allow or prevent the automatic opening of multiple windows, select **Options > Window > Block pop-ups** or **Allow pop-ups**.

### Shortcuts while browsing

- Press **1** to open your bookmarks.
- Press **2** to search for keywords in the current page.
- Press **3** to return to the previous page.
- Press **5** to list all open windows.
- Press **8** to show the page overview of the current page. Press **8** again to zoom in and view the desired section of the page.
- Press **9** to enter a new web address.
- Press **0** to go to the home page (if defined in settings).
- Press **\*** and **#** to zoom in or out on the page.



**Tip:** To return to the standby mode with the browser open in the background, press **⌘** twice or the end key. To return to the browser, press and hold **⌘**, and select the browser from the list.

## Browser toolbar

The browser toolbar helps you select frequently used functions of the browser.

To open the toolbar, press and hold the scroll key on an empty spot on a web page. To move within the toolbar, scroll left or right. To select a feature, press the scroll key.

In the toolbar, select from the following:

- **Frequently used links** — View a list of the web addresses you visit frequently.
- **Page overview** — See an overview of the current web page.
- **Find** — Search for keywords within the current page.
- **Reload** — Refresh the page.
- **Subscribe to web feeds** (if available) — View a list of available web feeds on the current web page, and subscribe to a web feed.

## Navigate pages

Mini Map and page overview help you navigate web pages that contain a large amount of information.

When Mini Map is set on in the browser settings and you scroll through a large web page, Mini Map opens and shows an overview of the web page you browse.

To set Mini Map on, select **Options > Settings > General > Mini map > On**.

To move in Mini Map, scroll left, right, up, or down. When you find the desired location, stop scrolling. Mini Map disappears and leaves you at the selected location.

When you are browsing a web page that contains a large amount of information, you can also use **Page**

**overview** to view what kind of information the page contains.

To show the page overview of the current page, press **8**. To find the desired spot on the page, scroll up, down, left, or right. Press **8** again to zoom in and view the desired section of the page.

## Web feeds and blogs

Web feeds are xml files on web pages that are used by the weblog community and news organisations to share the latest headlines or text, for example, news feeds. Blogs or weblogs are web diaries. Most of the web feeds use RSS and Atom technologies. It is common to find web feeds on web, blog, and wiki pages.

The Web application automatically detects if a web page contains web feeds.

To subscribe to a web feed, select **Options > Subscribe to web feeds**.

To view the web feeds to which you have subscribed, in the bookmarks view, select **Web feeds**.

To update a web feed, select it and **Options > Refresh**.

To define how the web feeds are updated, select **Options > Settings > Web feeds**.

## Widgets

The web browser supports widgets (network service). Widgets are small, downloadable web applications that deliver multimedia, news feeds, and other information, such as weather reports, to your device. Installed widgets appear as separate applications in the **Applications** folder.

You can download widgets using the Download! application or from the web.

The default access point for widgets is the same as in the web browser. When active in the background, some widgets may update information automatically to your device.

## Content search

To search for keywords, phone numbers, or e-mail addresses within the current web page, select **Options** > **Find** and the desired option. To go to the previous match, scroll up. To go to the next match, scroll down.



**Tip:** To search for keywords within the page, press 2.

## Download and purchase items

You can download items such as ringing tones, images, operator logos, themes, and video clips. These items can be provided free of charge, or you can purchase them. Downloaded items are handled by the respective applications in your device, for example, a downloaded photo can be saved in Photos.



**Important:** Only install and use applications and other software from trusted sources, such as applications that are Symbian Signed or have passed the Java Verified™ testing.

To download an item, do the following:

1. Select the link.
2. Select the appropriate option to purchase the item (for example, **Buy**).
3. Carefully read all the information provided.
4. To continue or cancel the download, select the appropriate option (for example, **Accept** or **Cancel**).

When you start a download, a list of ongoing and completed downloads from the current browsing session is displayed.

To modify the list, select **Options > Downloads**. In the list, scroll to an item, and select **Options** to cancel ongoing downloads, or open, save, or delete completed downloads.

## Bookmarks

The bookmarks view opens when you open the Web application. You can select web addresses from a list or from a collection of bookmarks in the **Recently visited pages** folder. You can also enter the URL address of the web page you want to visit directly into the field (🌐).

🌐 indicates the starting page defined for the default access point.

You can save URL addresses as bookmarks while browsing on the internet. You can also save addresses received in messages to your bookmarks and send saved bookmarks.

To open the bookmarks view while browsing, press **1**, or select **Options > Bookmarks**.

To edit the details of a bookmark, such as the title, select **Options > Bookmark manager > Edit**.

In the bookmarks view, you can also open other browser folders. The Web application allows you to save web pages during browsing. In the **Saved pages** folder, you can view the content of the pages you have saved offline.

Web also keeps track of the web pages you visit during browsing. In the **Recently visited pages** folder, you can view the list of visited web pages.

In **Web feeds**, you can view saved links to web feeds and blogs to which you have subscribed. Web feeds are commonly found on major news organisation web pages, personal weblogs, online communities that offer the latest headlines, and article summaries. Web feeds use RSS and Atom technologies.

## Empty the cache

The information or services you have accessed are stored in the cache memory of the device.

A cache is a memory location that is used to store data temporarily. If you have tried to access or have accessed confidential information requiring passwords, empty the cache after each use. The information or services you have accessed are stored in the cache.

To empty the cache, select **Options > Clear privacy data > Cache**.

## End the connection

To end the connection and view the browser page offline, select **Options > Tools > Disconnect**; or

to end the connection and close the browser, select **Options** > **Exit**.

To take the browser to the background, press the end key once. To end the connection, press and hold the end key.

To delete the information the network server collects about your visits to various web pages, select **Options** > **Clear privacy data** > **Cookies**.

## Connection security

If the security indicator (🔒) is displayed during a connection, the data transmission between the device and the internet gateway or server is encrypted.

The security icon does not indicate that the data transmission between the gateway and the content server (or place where the requested resource is stored) is secure. The service provider secures the data transmission between the gateway and the content server.

Security certificates may be required for some services, such as banking services. You are notified if the identity of the server is not authentic or if you do not have the correct security certificate in your device. For more information, contact your service provider.

## Web settings

Press , and select **Web**.

Select **Options** > **Settings** and from the following:

### General settings

- **Access point** — Change the default access point. Some or all access points may be preset for your device by your service provider; you may not be able to change, create, edit, or remove them.
- **Homepage** — Define the home page.
- **Mini map** — Set Mini Map on or off. [See "Navigate pages", p. 85.](#)
- **History list** — While browsing, to select **Back** to see a list of the pages you have visited during the current browsing session, set **History list** on.
- **Security warnings** — Hide or show security notifications.
- **Java/ECMA script** — Enable or disable the use of scripts.

### Page settings

- **Load content** — Select whether you want to load images and other objects while browsing. If you select **Text only**, to load images or objects later during browsing, select **Options** > **Tools** > **Load images**.
- **Screen size** — Select between full screen and the normal view with the options list.



- **Default encoding** — If text characters are not shown correctly, you can select another encoding according to language for the current page.
- **Block pop-ups** — Allow or block automatic opening of different pop-ups while browsing.
- **Automatic reload** — If you want the web pages to be refreshed automatically while browsing, select **On**.
- **Font size** — Define the font size that is used for web pages.

### Privacy settings

- **Recently visited pages** — Enable or disable automatic bookmark collecting. If you want to continue saving the addresses of the visited web pages into the **Recently visited pages** folder, but hide the folder from the bookmarks view, select **Hide folder**.
- **Form data saving** — If you do not want the data you enter to different forms on a web page to be saved and used the next time you open the page, select **Off**.
- **Cookies** — Enable or disable the receiving and sending of cookies.

### Web feed settings

- **Automatic updates** — Define whether you want the web feeds to be updated automatically and how often you want to update them. Setting the application to retrieve web feeds automatically may involve the transmission of large amounts

of data through your service provider's network. Contact your service provider for information about data transmission charges.

- **Acc. point for auto-update** — Select the desired access point for updating. This option is only available when **Automatic updates** is on.

# Connections

At Nokia, we understand how important it is that your mobile phone or device operates reliably and that your personal content is saved safely.

Any information from an unknown or unreliable source, via Bluetooth connectivity, multimedia message, or cable, may harm your PC, mobile phone, or device. You may protect your mobile phone or device from damage and keep it secured by following simple measures:

- Always keep Bluetooth connectivity closed unless you want your phone or device to be visible to others.
- Always be alert when receiving information from an unknown or untrustworthy source.
- Do not download or install any applications that may include software harmful to your phone or device.
- Always download and install applications or content from trusted or well-known sources, such as Nokia Software Market, where good protection is provided against viruses and other harmful software.

Your device offers several options to connect to the internet or to another compatible device or PC.

## Active data connections

Press , and select **Tools > Connectivity > Conn. mgr..**

In the active data connections view, you can see the open data connections:

 data calls

 packet data connections



**Note:** The actual time invoiced for calls by your service provider may vary, depending on network features, rounding off for billing, and so forth.

To end a connection, select **Options > Disconnect**. To close all open connections, select **Options > Disconnect all**.

To view the details of a connection, select **Options > Details**. The details shown depend on the connection type.

# Bluetooth connectivity

## About Bluetooth connectivity

You can make a wireless connection to other compatible devices with Bluetooth connectivity. Compatible devices may include mobile phones, computers, and enhancements such as headsets and car kits. You can use Bluetooth connectivity to send images, video clips, music and sound clips, and notes; make a wireless connection to your compatible PC (for example, to transfer files); and connect to a compatible printer to print images with Image print.

Since devices with Bluetooth wireless technology communicate using radio waves, they do not need to be in direct line-of-sight. However, they must be within 10 metres (33 feet) of each other, although the connection may be subject to interference from obstructions such as walls or from other electronic devices.

This device is compliant with Bluetooth Specification 2.0 supporting the following profiles: Generic Audio/Video Distribution Profile, Advanced Audio Distribution Profile, Audio/Video Remote Control Profile, Basic Imaging Profile, Basic Printing Profile, Dial-up Networking Profile, File Transfer Profile, Hands-Free Profile, Headset Profile, Human Interface Device Profile, Object Push Profile, SIM Access Profile, Synchronization Profile, Serial Port

Profile, and Phonebook Access Profile. To ensure interoperability between other devices supporting Bluetooth technology, use Nokia approved enhancements for this model. Check with the manufacturers of other devices to determine their compatibility with this device.

There may be restrictions on using Bluetooth technology in some locations. Check with your local authorities or service provider.

Features using Bluetooth technology, or allowing such features to run in the background while using other features, increase the demand on battery power and reduce the battery life.

When the device is locked, you cannot use Bluetooth connectivity.

## Settings

Press , and select **Tools > Bluetooth**.

When you open the application for the first time, you are asked to define a name for your device. You can change the name later on.

Select from the following:

- **Bluetooth** — To make a wireless connection to another compatible device, first set Bluetooth connectivity **On**, then establish a connection. To switch off Bluetooth connectivity, select **Off**.
- **My phone's visibility** — To allow your device to be found by other devices with Bluetooth

wireless technology, select **Shown to all**. To set a time after which the visibility is set from shown to hidden, select **Define period**. To hide your device from other devices, select **Hidden**.

- **My phone's name** — Edit the name shown to other devices with Bluetooth wireless technology.
- **Remote SIM mode** — To enable another device, such as a compatible car kit enhancement, to use the SIM card in your device to connect to the network, select **On**. [See "Remote SIM mode", p. 94.](#)

## Security tips

Press , and select **Tools > Bluetooth**.

When you are not using Bluetooth connectivity, to control who can find your device and connect to it, select **Bluetooth > Off** or **My phone's visibility > Hidden**.

Do not pair with or accept connection requests from an unknown device. This protects your device from harmful content.

## Send data using Bluetooth connectivity

Several Bluetooth connections can be active at a time. For example, if you are connected to a

compatible headset, you can also transfer files to another compatible device at the same time.

1. Open the application where the item you want to send is stored. For example, to send an image to another compatible device, open Photos.
2. Select the item and **Options > Send > Via Bluetooth**.

Devices with Bluetooth wireless technology that are within range are displayed. Device icons are as follows:

 computer

 phone

 audio or video device

 other device

To interrupt the search, select **Stop**.

3. Select the device with which you want to connect.
4. If the other device requires pairing before data can be transmitted, a tone sounds, and you are asked to enter a passcode. [See "Pair devices", p. 93.](#)

When the connection is established, **Sending data** is displayed.



**Tip:** When searching for devices, some devices may show only the unique address (device address). To find the unique address

of your device, enter **\*#2820#** in the standby mode.

## Pair devices

To pair with compatible devices and view your paired devices, in the main view of Bluetooth connectivity, scroll right.

Before pairing, create your own passcode (1 to 16 digits), and agree with the owner of the other device to use the same code. Devices that do not have a user interface have a factory-set passcode. The passcode is used only once.

1. To pair with a device, select **Options > New paired device**. Devices that are within range are displayed.
2. Select the device, and enter the passcode. The same passcode must be entered on the other device as well.
3. Some audio enhancements connect automatically to your device after pairing. Otherwise, scroll to the enhancement, and select **Options > Connect to audio device**.

Paired devices are indicated by  in the device search.



To set a device as authorised or unauthorised, scroll to the device, and select from the following options:

- **Set as authorised** — Connections between your device and the authorised device can be made without your knowledge. No separate acceptance or authorisation is needed. Use this status for your own devices, such as your compatible headset or PC or devices that belong to someone you trust.  indicates authorised devices in the paired devices view.
- **Set as unauthorised** — Connection requests from this device must be accepted separately every time.

To cancel a pairing, scroll to the device, and select **Options > Delete**.

If you want to cancel all pairings, select **Options > Delete all**.

## Receive data using Bluetooth connectivity

When you receive data through Bluetooth connectivity, a tone sounds, and you are asked if you want to accept the message. If you accept,  is displayed, and the item is placed in the **Inbox** folder in Messaging. Messages received through Bluetooth connectivity are indicated by .

## Block devices

Press , and select **Tools** > **Bluetooth**.

To block a device from establishing a Bluetooth connection to your device, scroll right to open **Paired devices**. Select a device you want to block and **Options** > **Block**.

To unblock a device, scroll right to **Blocked devices**, select a device, and **Options** > **Delete**. To unblock all blocked devices, select **Options** > **Delete all**.

If you reject a pairing request from another device, you are asked if you want to block all future connection requests from this device. If you accept the query, the remote device is added to the list of blocked devices.

## Remote SIM mode

Before the remote SIM mode can be activated, the two devices must be paired and the pairing initiated from the other device. When pairing, use a 16-digit passcode, and set the other device as authorised.

To use the remote SIM mode with a compatible car kit enhancement, activate Bluetooth connectivity, and enable the use of the remote SIM mode with your device. Activate the remote SIM mode from the other device.

When the remote SIM mode is on in your device, **Remote SIM mode** is displayed in the standby mode. The connection to the wireless network is turned off, as indicated by  in the signal strength indicator area, and you cannot use SIM card services or features requiring cellular network coverage.

When the wireless device is in the remote SIM mode, you can only use a compatible connected enhancement, such as a car kit, to make or receive calls. Your wireless device will not make any calls while in this mode, except to the emergency numbers programmed into your device. To make calls from your device, you must leave the remote SIM mode. If the device is locked, enter the lock code to unlock it.

To leave the remote SIM mode, press the power key, and select **Exit remote SIM mode**.

## USB

Press , and select **Tools** > **Connectivity** > **USB**.

To have the device ask the purpose of the connection each time a compatible data cable is connected, select **Ask on connection** > **Yes**.

If **Ask on connection** is set to off or you want to change the mode during an active connection,

select **USB connection mode** and from the following:

- **PC Suite** — Use Nokia PC applications such as Nokia Nseries PC Suite.
- **Mass storage** — Transfer data between your device and a compatible PC. Use this mode also for downloading maps with the Nokia Map Loader PC application.
- **Image transfer** — Print images on a compatible printer.
- **Media transfer** — Synchronise music with Windows Media Player.

## PC connections

You can use your device with a variety of compatible PC connectivity and data communications applications. With Nokia Nseries PC Suite you can, for example, transfer images between your device and a compatible PC.

For information on Apple Macintosh support and connecting your device to an Apple Macintosh device, visit [www.nseries.com/mac](http://www.nseries.com/mac).

# Media folder

## RealPlayer

With RealPlayer, you can play video clips or stream media files over the air without saving them to the device first.

RealPlayer supports files with extensions such as .3gp, .mp4, or .rm. However, RealPlayer does not necessarily support all file formats or all the variations of file formats.

### Play video clips

Press , and select **Applications > Media > RealPlayer**.

To play a saved media file, select **Video clips**, a clip, and **Play**.

To list previously played files, in the application main view, select **Recently played**.

To adjust the volume, use the volume key.

After you select a media file, select **Options** and from the following:

- **Send** — Send a file using a multimedia message, e-mail, or other connection methods, such as Bluetooth connectivity.

- **Use video** — Assign a video to a contact or set it as a ringing tone.
- **Mark/Unmark** — Mark items in the list to send or delete multiple items at the same time.
- **View details** — View details of the selected item, such as format, resolution, and duration.
- **Settings** — Edit the settings for video playback and streaming.

### Stream content over the air

Many service providers require you to use an internet access point (IAP) for your default access point. Other service providers allow you to use a WAP access point.

In RealPlayer, you can only open an `rtsp://` URL address. However, RealPlayer plays a .ram file if you open an HTTP link to it in a browser.

To stream content over the air (network service), in RealPlayer or Photos, select a streaming link saved in the **Streaming links** folder. You can also receive a streaming link in a text message or multimedia message, or open a link on a web page. Before live content begins streaming, your device connects to



the site and starts loading the content. The content is not saved in your device.

## RealPlayer settings

Press , and select **Applications > Media > RealPlayer**.

You may receive RealPlayer settings in a special message from the service provider. For more information, contact your service provider.

Select **Options > Settings** and from the following:

- **Video** — Select whether video clips are played in full screen or in the normal view, and whether the clips are automatically repeated after they finish playing.
- **Streaming** — Select whether to use a proxy server, change the default access point, and set the port range used when connecting. Contact your service provider for the correct settings.

## Advanced settings

To edit the advanced settings, in the settings view, select **Streaming > Network > Options > Advanced settings**.

To select the bandwidth used for a network, select the network setting and the desired value.

To edit the bandwidth yourself, select **User defined**.

## Adobe Flash Player

Press , and select **Applications > Media > Flash Player**.

Use Adobe Flash Player to view, play, and interact with compatible flash files made for mobile devices.

To open a flash file, select it, and **Open**.

## Licences

To view digital rights licences, press , and select **Applications > Media > Licences**.

### Digital rights management

Content owners may use different types of digital rights management (DRM) technologies to protect their intellectual property, including copyrights. This device uses various types of DRM software to access DRM-protected content. With this device you can access content protected with WMDRM 10, OMA DRM 1.0, and OMA DRM 2.0. If certain DRM software fails to protect the content, content owners may ask that such DRM software's ability to access new DRM-protected content be revoked. Revocation may also prevent renewal of such DRM-protected content already in your device. Revocation of such DRM software does not affect the use of content protected with other types of DRM or the use of non-DRM-protected content.

Digital rights management (DRM) protected content comes with an associated activation key that defines your rights to use the content.

If your device has OMA DRM protected content, to back up both the activation keys and the content, use the backup feature of Nokia Nseries PC Suite. Other transfer methods may not transfer the activation keys which need to be restored with the content for you to be able to continue the use of OMA DRM-protected content after the device memory is formatted. You may also need to restore the activation keys in case the files on your device get corrupted.

If your device has WMDRM protected content, both the activation keys and the content will be lost if the device memory is formatted. You may also lose the activation keys and the content in case the files on your device get corrupted. Losing the activation keys or the content may limit your ability to use the same content on your device again. For more information, contact your service provider.

Some licences may be connected to a specific SIM card, and the protected content can be accessed only if the SIM card is inserted in the device.

In the main view, select from the following:

- **Valid licences** — View licences that are connected to media files or whose validity period has not begun.

- **Invalid licences** — View licences that are not valid; the time period for using the media file is exceeded or there is a protected media file in the device but no connected activation key.
- **Not in use** — View licences that have no media files connected to them in the device.

To buy more usage time for a media file, select an invalid licence and **Options** > **Get new licence** (web service messages must be enabled). See "[Web service message settings](#)", p. 114.

To view detailed information, such as the validity status and ability to send the file, scroll to an activation key, and press the scroll key.

## Recorder

Press , and select **Applications** > **Media** > **Recorder**.

With Recorder, you can record voice memos and telephone conversations.

To record a telephone conversation, open Recorder during a voice call. Both parties hear a tone every 5 seconds during recording.