



# Nokia 6710 Navigator User Guide

---



1111111  
Issue 1





DECLARATION OF CONFORMITY

**CE0434** ⓘ

Hereby, NOKIA CORPORATION declares that this RM-491 product is in compliance with the essential requirements and other relevant provisions of Directive 1999/5/EC. A copy of the Declaration of Conformity can be found at [www.nokia.com/phones/declaration\\_of\\_conformity/](http://www.nokia.com/phones/declaration_of_conformity/).

© 2009 Nokia. All rights reserved.

Nokia, Nokia Connecting People, Navi, Mail for Exchange, N-Gage, OVI, and Nokia Original Enhancements logo are trademarks or registered trademarks of Nokia Corporation. Nokia tune is a sound mark of Nokia Corporation. Other product and company names mentioned herein may be trademarks or tradenames of their respective owners

Reproduction, transfer, distribution, or storage of part or all of the contents in this document in any form without the prior written permission of Nokia is prohibited. Nokia operates a policy of continuous development. Nokia reserves the right to make changes and improvements to any of the products described in this document without prior notice.

**symbian**

This product includes software licensed from Symbian Software Ltd ©1998-2009. Symbian and Symbian OS are trademarks of Symbian Ltd.



**Java**

POWERED Java and all Java-based marks are trademarks or registered trademarks of Sun Microsystems, Inc.

Portions of the Nokia Maps software are ©1996-2009 The FreeType Project. All rights reserved.

This product is licensed under the MPEG-4 Visual Patent Portfolio License (i) for personal and noncommercial use in connection with information which has been encoded in compliance with the MPEG-4 Visual Standard by a consumer engaged in a personal and noncommercial activity and (ii) for use in connection with MPEG-4 video provided by a licensed video provider. No license is granted or shall be implied for any other use. Additional information, including that related to promotional, internal, and commercial uses, may be obtained from MPEG LA, LLC. See <http://www.mpegla.com>.

TO THE MAXIMUM EXTENT PERMITTED BY APPLICABLE LAW, UNDER NO CIRCUMSTANCES SHALL NOKIA OR ANY OF ITS LICENSORS BE RESPONSIBLE FOR ANY LOSS OF DATA OR INCOME OR ANY SPECIAL, INCIDENTAL, CONSEQUENTIAL OR INDIRECT DAMAGES HOWSOEVER CAUSED.

THE CONTENTS OF THIS DOCUMENT ARE PROVIDED "AS IS". EXCEPT AS REQUIRED BY APPLICABLE LAW, NO WARRANTIES OF ANY KIND, EITHER EXPRESS OR IMPLIED, INCLUDING, BUT NOT LIMITED TO, THE IMPLIED WARRANTIES OF MERCHANTABILITY AND FITNESS FOR A PARTICULAR PURPOSE, ARE MADE IN RELATION TO THE ACCURACY, RELIABILITY OR CONTENTS OF THIS DOCUMENT. NOKIA RESERVES THE RIGHT TO REVISE THIS DOCUMENT OR WITHDRAW IT AT ANY TIME WITHOUT PRIOR NOTICE.

Reverse engineering of software in the device is prohibited to the extent permitted by applicable law. Insofar as this user guide contains any limitations on Nokia's representations, warranties, damages and liabilities, such limitations shall likewise limit any representations, warranties, damages and liabilities of Nokia's licensors.





The third-party applications provided with your device may have been created and may be owned by persons or entities not affiliated with or related to Nokia. Nokia does not own the copyrights or intellectual property rights to the third-party applications. As such, Nokia does not take any responsibility for end-user support, functionality of the applications, or the information in the applications or these materials. Nokia does not provide any warranty for the third-party applications.

BY USING THE APPLICATIONS YOU ACKNOWLEDGE THAT THE APPLICATIONS ARE PROVIDED AS IS WITHOUT WARRANTY OF ANY KIND, EXPRESS OR IMPLIED, TO THE MAXIMUM EXTENT PERMITTED BY APPLICABLE LAW. YOU FURTHER ACKNOWLEDGE THAT NEITHER NOKIA NOR ITS AFFILIATES MAKE ANY REPRESENTATIONS OR WARRANTIES, EXPRESS OR IMPLIED, INCLUDING BUT NOT LIMITED TO WARRANTIES OF TITLE, MERCHANTABILITY OR FITNESS FOR A PARTICULAR PURPOSE, OR THAT THE APPLICATIONS WILL NOT INFRINGE ANY THIRD-PARTY PATENTS, COPYRIGHTS, TRADEMARKS, OR OTHER RIGHTS.

The availability of particular products and applications and services for these products may vary by region. Please check with your Nokia dealer for details and availability of language options. This device may contain commodities, technology or software subject to export laws and regulations from the US and other countries. Diversion contrary to law is prohibited.

**FCC/INDUSTRY CANADA NOTICE**

Your device may cause TV or radio interference (for example, when using a telephone in close proximity to receiving equipment). The FCC or Industry Canada can require you to stop using your telephone if such interference cannot be eliminated. If you require assistance, contact your local service facility. This device complies with part 15 of the FCC rules. Operation is subject to the following two conditions: (1) This device may not cause harmful interference, and (2) this device must accept any interference received, including interference that may cause undesired operation. Any changes or modifications not expressly approved by Nokia could void the user's authority to operate this equipment.

111111/Issue 1 EN



# Contents

<b>Safety.....</b>	<b>7</b>	In-device help.....	18
About your device.....	7	Software updates.....	18
Network services.....	8		
<b>1. Get started.....</b>	<b>9</b>	<b>4. Call functions.....</b>	<b>18</b>
Insert SIM card and battery.....	9	Voice calls.....	19
Insert a memory card.....	9	Video calls.....	20
Remove a memory card.....	10	Call settings.....	21
Charge the battery.....	10	Video sharing.....	23
Switch the device on and off.....	11		
Antenna locations.....	11	<b>5. Media.....</b>	<b>24</b>
Configuration settings.....	11	Music player.....	24
<b>2. Your device.....</b>	<b>12</b>	<b>6. Positioning.....</b>	<b>25</b>
Keys and parts.....	11	About GPS.....	25
Zoom area.....	13	Assisted GPS (A-GPS).....	25
Home screen.....	13	Maps.....	26
Frequently used menu paths.....	13	Landmarks.....	31
Display indicators.....	14	GPS data.....	32
Power saver.....	15		
Menu.....	16	<b>7. Write text.....</b>	<b>33</b>
Volume control.....	16	Traditional text input.....	32
Keypad lock.....	16	Predictive text input.....	33
Access codes.....	16	Change the writing language.....	33
Remote lock.....	17	Copy and delete text.....	34
Connect a compatible headset.....	17		
Wrist strap.....	17	<b>8. Messaging.....</b>	<b>34</b>
		Write and send messages.....	34
		Message reader.....	35
<b>3. Useful information.....</b>	<b>17</b>	E-mail.....	36



View messages on a SIM card.....38  
 Messaging settings.....38

**9. Contacts.....40**  
 Work with contacts.....40  
 Location information.....40  
 Create contact groups.....40  
 Add ringing tones for contacts.....41  
 Change Contacts settings.....41

**10. About Photos.....41**

**11. Camera.....42**  
 Capture an image.....42  
 Capture a panorama image.....43  
 Record videos.....43  
 Location information.....43

**12. Internet.....44**  
 Web browser .....43  
 Share online.....48  
 Nokia Video Centre.....49  
 Search.....50  
 Nokia Music Store.....50

**13. Personalisation.....50**  
 Change the display theme.....51  
 Profiles .....51  
 Sensor settings.....51

**14. Time management.....52**

**Contents**

Alarm clock.....52  
 Clock settings.....52

**15. Office applications.....52**  
 Dictionary.....52  
 Converter.....53  
 Active notes .....53

**16. Settings.....54**  
 Settings wizard.....54  
 Common accessory settings.....54  
 Restore original settings.....55

**17. Data management.....55**  
 Install applications.....55  
 Device manager.....56  
 Licenses.....57

**18. Connectivity.....58**  
 Transfer content from another device.....58  
 PC connections.....59  
 Bluetooth.....59  
 Data cable.....62  
 Sync.....62  
 WLAN wizard .....63

**Accessories.....64**

**Battery.....66**  
 Battery and charger information.....66  
 Nokia battery authentication guidelines.....67



**Contents**

**Taking care of your device.....68**

Recycle.....68

**Additional safety information.....69**

Small children.....69

Operating environment.....69

Medical devices.....69

Vehicles.....70

Potentially explosive environments.....70

Emergency calls.....70

Certification information (SAR).....71

**Index.....73**



## Safety

Read these simple guidelines. Not following them may be dangerous or illegal. Read the complete user guide for further information.



### SWITCH ON SAFELY

Do not switch the device on when wireless phone use is prohibited or when it may cause interference or danger.



### ROAD SAFETY COMES FIRST

Obey all local laws. Always keep your hands free to operate the vehicle while driving. Your first consideration while driving should be road safety.



### INTERFERENCE

All wireless devices may be susceptible to interference, which could affect performance.



### SWITCH OFF IN RESTRICTED AREAS

Follow any restrictions. Switch the device off in aircraft, near medical equipment, fuel, chemicals, or blasting areas.



### QUALIFIED SERVICE

Only qualified personnel may install or repair this product.



### ACCESSORIES AND BATTERIES

Use only approved accessories and batteries. Do not connect incompatible products.



### WATER-RESISTANCE

Your device is not water-resistant. Keep it dry.

## About your device

The wireless device described in this guide is approved for use on the (E)GSM 850, 900, 1800, and 1900 networks, and UMTS 900/1900/2100 HSPA networks. Contact your service provider for more information about networks.

Your device supports several connectivity methods and like computers may be exposed to viruses and other harmful content. Exercise caution with messages, connectivity requests, browsing, and downloads. Only install and use services and software from trustworthy sources that offer adequate security and protection, such as applications that are Symbian Signed or have passed the Java Verified™ testing. Consider installing antivirus and other security software on your device and any connected computer.

Your device may have preinstalled bookmarks and links for third-party internet sites and may allow you to access third-party sites. These are not affiliated with Nokia, and Nokia does not endorse or assume liability for them. If you access such sites, take precautions for security or content.



**Warning:** To use any features in this device, other than the alarm clock, the device must be switched on. Do not



### Safety

switch the device on when wireless device use may cause interference or danger.

When using this device, obey all laws and respect local customs, privacy and legitimate rights of others, including copyrights. Copyright protection may prevent some images, music, and other content from being copied, modified, or transferred.

Make back-up copies or keep a written record of all important information stored in your device.

When connecting to any other device, read its user guide for detailed safety instructions. Do not connect incompatible products.

The images in this guide may differ from your device display. Refer to the user guide for other important information about your device.

### Network services

To use the device you must have service from a wireless service provider. Some features are not available on all

networks; other features may require that you make specific arrangements with your service provider to use them.

Network services involve transmission of data. Check with your service provider for details about fees in your home network and when roaming on other networks. Your service provider can explain what charges will apply. Some networks may have limitations that affect how you can use some features of this device requiring network support such as support for specific technologies like WAP 2.0 protocols (HTTP and SSL) that run on TCP/IP protocols and language-dependent characters.

Your service provider may have requested that certain features be disabled or not activated in your device. If so, these features will not appear on your device menu. Your device may also have customized items such as menu names, menu order, and icons.





## 1. Get started

### Insert SIM card and battery

Safe removal. Always switch the device off and disconnect the charger before removing the battery.

1. Remove the back cover by lifting it from the bottom end of the device.
2. Lift the cover off.
3. To remove the battery, lift it from the end.
4. Slide the SIM card into the SIM card holder.

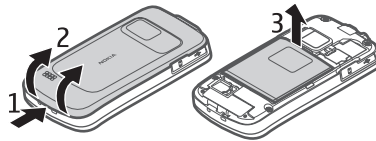

Make sure that the gold-coloured contact area on the card is facing down on the device, and the bevelled corner is facing toward the card holder slot.

5. Replace the battery.
6. Replace the back cover.

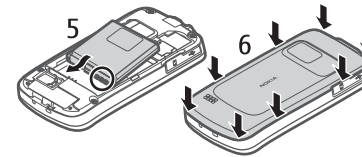
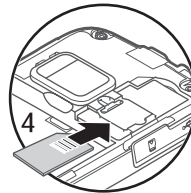

### Insert a memory card

Use a memory card to save the memory on your device. You can also back up data from your device to the memory card.

Use only compatible microSD cards approved by Nokia for use with this device. Nokia uses approved industry standards for memory cards, but some brands may not be fully compatible with this device. Incompatible cards may damage the card and the device and corrupt data stored on the card.

Keep all memory cards out of the reach of small children.

Check the compatibility of a memory card with its manufacturer or provider.

A compatible memory card may be supplied with the device, and may already be inserted in the device. If not, do the following:

1. Open the memory card slot cover (1).



### Get started

2. Place the card in the slot with the contact area facing down (2).
3. Push the card gently to lock it into place. Close the slot cover (3).

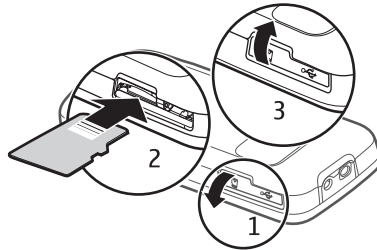

### Remove a memory card

 **Important:** Do not remove the memory card during an operation when the card is being accessed. Doing so may damage the memory card and the device, and corrupt data stored on the card.

1. Press the power key briefly, and select **Remove memory card** > **Yes**.
2. Open the memory card slot cover.
3. Press the memory card gently to release it.
4. Pull the card out, and press **OK**.
5. Close the slot cover.

### Charge the battery

Your battery has been partially charged at the factory. If the device indicates a low charge, do the following:

1. Connect the charger to a wall outlet.
2. Connect the charger to the device.
3. When the device indicates a full charge, disconnect the charger from the device, then from the wall outlet.

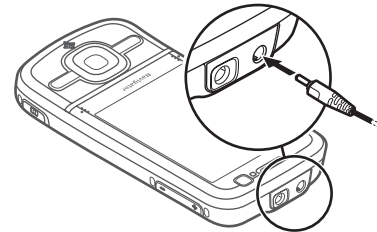

You can also charge the battery with a USB data cable connected to a compatible computer.

1. Connect the USB data cable to a USB port of a computer and to your device.
2. When the battery is fully charged, disconnect the USB data cable.

USB charging efficiency varies significantly. In some cases, it may take a very long time for charging to start and the device to start functioning. You do not need to charge the battery for a specific length of time, and you can use the device while it is charging. If the battery is completely discharged, it may take several minutes before the charging indicator appears on the display or before any calls can be made.

## Switch the device on and off

Press and hold the power key to switch the device on and off. Briefly pressing this key ends an active call or closes an application.

If the device asks for a PIN code, enter the PIN code, and select **OK**.

If the device asks for the lock code, enter the lock code, and select **OK**. The factory setting for the lock code is 12345.

To set the correct time zone, time, and date, select the country you are presently in, then enter the local time and date.

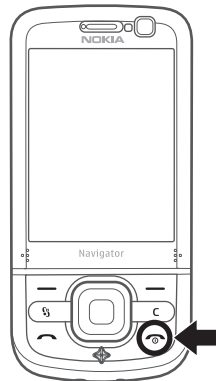

## Antenna locations

Your device may have internal and external antennas. Avoid touching the antenna area unnecessarily while the antenna is transmitting or receiving. Contact with antennas affects the communication quality and may cause a higher power level during operation and may reduce the battery life.

During extended operation such as an active video call and high speed data connection, the device may feel warm. In most cases, this condition is normal. If you suspect the device is not working properly, take it to the nearest authorised service facility.

## Get started



## Configuration settings

Before you can use multimedia messaging, e-mail, synchronisation, streaming, and the browser, you must have the proper configuration settings in your device. Your device may automatically configure browser, multimedia messaging, access point, and streaming settings based on the SIM card used. If not, you can use the Settings wizard application to configure the settings. You may receive the settings as a configuration message that you can save to your device. For more information on availability, contact your service provider or nearest authorised Nokia dealer.

When you receive a configuration message, and the settings are not automatically saved and activated, **1 new message** is displayed. To save the settings, select **Show > Options > Save**. You may need to enter a PIN code provided by the service provider.

Your device

## 2. Your device

### Keys and parts

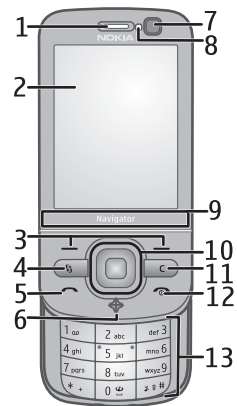

- 1 — Earpiece
- 2 — Display
- 3 — Selection keys
- 4 — Menu key 
- 5 — Call key
- 6 — Navigator key with GPS light
- 7 — Secondary camera

12

- 8 — Light sensor
- 9 — Zoom area
- 10 — Navi™ key; hereafter referred to as scroll key
- 11 — Clear key C
- 12 — End/Power key
- 13 — Number keys

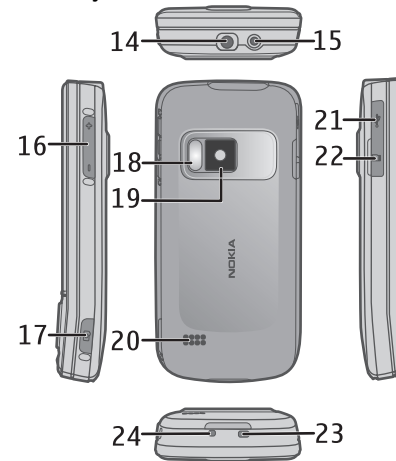

- 14 — Nokia AV connector
- 15 — Charger connector
- 16 — Volume/Zoom keys
- 17 — Capture key
- 18 — Camera flash
- 19 — Main camera
- 20 — Stereo loudspeakers
- 21 — Micro USB connector
- 22 — Memory card slot
- 23 — Wrist wrap eyelet
- 24 — Microphone

Keep your device away from magnets or magnetic fields.

## Zoom area

Your device has a zoom area below the display. In the zoom area, swipe left or right to zoom in or out.

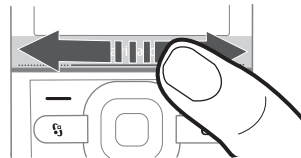

The zoom works in the Maps, Browser, Photos, and Camera applications.

## Your device

## Home screen

When you have switched on the device, and it is registered to a network, the device is in the home screen and ready for use.

To open a list of most recently dialed numbers, press the call key.

To call your voice mailbox, press and hold 1.

To use voice commands or voice dialling, press and hold the right selection key.

To change the profile, press the power key briefly, and select a profile.

To open a connection to the web, press and hold 0.

To modify the home screen, select  > **Settings** > **Settings and General** > **Personalisation** > **Standby mode** and from the following:

- **Standby theme** — Select a home screen theme.
- **Shortcuts** — Add shortcuts to applications or events, or assign shortcuts to the scroll key, depending on the selected home screen theme.

## Frequently used menu paths

To use the converter, select  > **Organiser** > **Converter**.

To use the calculator, select  > **Organiser** > **Calculator**.

To manage the time and date, or to set an alarm, select  > **Applications** > **Clock**.

To manage settings for messaging, select  > **Messaging and Options** > **Settings**.

### Your device

To open the music player, select  > **Applications** > **Music player**.

To open the FM radio, select  > **Applications** > **Radio**.

To manage call related settings, select  > **Settings** > **Settings** and **Phone**.

To open the in-device help, select  > **Applications** > **Help** > **Help**.

To change the display theme, select  > **Settings** > **Themes**.

To personalise profiles, select  > **Settings** > **Profiles**.

To change the menu view, select  > **Options** > **Change Menu view**.

### Display indicators

 **3G** The device is being used in a UMTS network or a GSM network (network service). The bar next to the icon indicates the signal strength of the network at your current location. The higher the bar, the stronger the signal.

 **3.5G** High-speed packet access (HSPA) (network service) in the UMTS network is activated.

 **X** The device is using the Offline profile and is not connected to a cellular network.



The battery charge level. The higher the bar, the stronger the charge in the battery.



You have unread messages in the Inbox folder in Messaging.



You have received new e-mail in the remote mailbox.



There are messages waiting to be sent in the Outbox folder in Messaging.



You have missed calls.



The keys of the device are locked.



An alarm is active.



You have activated the Silent profile, and the device does not ring for an incoming call or message.





Bluetooth connectivity is activated.





A Bluetooth connection is established. When the indicator is blinking, your device is trying to connect with another device.





A GPRS packet data connection is available (network service).  indicates that the connection is active.  indicates that the connection is on hold.





An EGPRS packet data connection is available (network service).  indicates that the connection is active.  indicates that the connection is on hold.



A UMTS packet data connection is available (network service).  indicates that the connection is active.  indicates that the connection is on hold.



HSPA is supported and available (network service). The icon may vary between regions.  indicates that the connection is active.  indicates that the connection is on hold.



You have set the device to scan for wireless LANs (WLAN), and a WLAN is available.



A WLAN connection is active in a network that does not have encryption.



A WLAN connection is active in a network that has encryption.



#### Your device



Your device is connected to a computer with a USB data cable.



All calls are forwarded to another number.



A headset is connected to the device.



A hands-free car kit is connected to the device.



A loopset is connected to the device.



Your device is synchronising.



The GPS indicator shows the availability of the satellite signals. One bar is one satellite. When the device receives enough data from the satellites to calculate your location, the bar turns green.

Other indicators may also be displayed.

### Power saver

Select  > **Settings** > **Settings**.

To set the screen saver settings, select **General** > **Personalisation** > **Display** and from the following:

- **Power saver time-out** — Set the length of time that the device is inactive before the power saver is activated.



### Your device

- **Light time-out** — Set the length of time that the device is inactive before the screen is dimmed.

## Menu

Select .

In the menu, you can access the functions in your device.

To open an application or a folder, select the item.

If you change the order of the functions in the menu, the order may differ from the default order described in this user guide.

To mark or unmark an item in applications, press #.

To mark or unmark several consecutive items, press and hold #, and scroll up or down.

To change the menu view, select **Options** > **Change Menu view**.

To close an application or a folder, select **Options** > **Exit**.

To display and switch between open applications, press and hold , and select an application.

Leaving applications running in the background increases the demand on battery power and reduces the battery life.

## Volume control

 **Warning:** Continuous exposure to high volume may damage your hearing. Listen to music at a moderate level, and do not hold the device near your ear when the loudspeaker is in use.

16

To adjust the earpiece or loudspeaker volume during a call or when listening to an audio file, press the volume keys.

To activate or deactivate the loudspeaker during a call, select **Loudsp.** or **Handset**.

## Keypad lock

Select  > **Settings** > **Settings and General**.

To set the device to automatically lock the keypad after a certain length of time in the standby mode, select **Security** > **Phone and SIM card**, scroll to **Keypad autolock period**, select **Change** > **User defined** and the desired time.

To select whether the keypad is locked when you close the slide, select **Slide handling** > **Keyguard activation** > **On if closing slide**.

To unlock the keypad, open the slide, or press the left selection key, and select **OK** within 1.5 seconds.

When the device or keypad is locked, calls may be possible to the official emergency number programmed into your device.

## Access codes

Select  > **Settings** > **Settings**.

To define how your device uses the access codes and security settings, select **General** > **Security** > **Phone and SIM card** and from the following:

- The PIN (UPIN) code, supplied with the SIM (USIM) card, helps to protect the card against unauthorised use.



- The PIN2 (UPIN2) code, supplied with some SIM (USIM) cards, is required to access certain services.
- PUK (UPUK) and PUK2 (UPUK2) codes may be supplied with the SIM (USIM) card. If you enter the PIN code incorrectly three times in succession, you are asked for the PUK code. If the codes are not supplied, contact your service provider.
- The security code helps to protect your phone against unauthorised use. You can create and change the code, and set the phone to request the code. Keep the code secret and in a safe place separate from your phone. If you forget the code and your phone is locked, your phone will require service and additional charges may apply. For more information, contact your service provider.
- The barring password is required when using the call barring service to restrict calls to and from your phone (network service).

### Remote lock

You can lock your device from another device using a text message (5-20 characters long). To enable your device to be locked remotely, and to define the lock message to be used, select **Settings > Settings > General > Security and Phone and SIM card > Remote phone locking**. Enter the content of the message, verify it, and enter the lock code.

To lock your device, send the lock message as a text message to your mobile phone number. To unlock your device, select **Unlock**, and enter the lock code.

## 3. Useful information

Check [www.nokia.com/support](http://www.nokia.com/support) or your local Nokia website

### Useful information

#### Connect a compatible headset

Do not connect products that create an output signal as this may cause damage to the device. Do not connect any voltage source to the Nokia AV Connector.

When connecting any external device or any headset, other than those approved by Nokia for use with this device, to the Nokia AV Connector, pay special attention to volume levels.

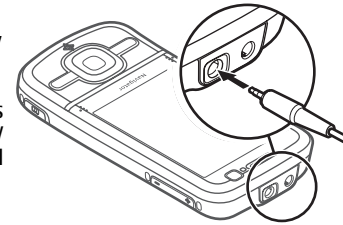

#### Wrist strap

Thread the wrist strap, and tighten it.

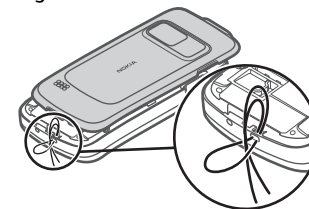

### Call functions

for the latest guides, additional information, downloads, and services related to your Nokia product.



### In-device help

Your device contains instructions to help to use the applications in your device.

To open help texts from the main menu, select  > **Applications** > **Help** > **Help** and the application for which you want to read instructions.

When an application is open, to access the help text for the current view, select **Options** > **Help**.

When you are reading the instructions, to change the size of the help text, select **Options** > **Decrease font size** or **Increase font size**.

You can find links to related topics at the end of the help text. If you select an underlined word, a short explanation is displayed. Help texts use the following indicators:  shows a link to a related help topic.  shows a link to the application being discussed.

When you are reading the instructions, to switch between help texts and the application that is open in the background, press and hold the menu key, and select from the list of open applications.

### Software updates

Nokia may produce software updates that offer new features, enhanced functions, and improved performance. You may be

able to request these updates through the Nokia Software Updater PC application. Software updates may not be available for all products or their variants. Not all operators may endorse the latest software versions available.

To update the device software, you need the Nokia Software Updater application and a compatible PC with Microsoft Windows XP, or Vista operating system, broadband internet access, and a compatible data cable to connect your device to the PC.

 **Warning:** If you install a software update, you cannot use the device, even to make emergency calls, until the installation is completed and the device is restarted. Be sure to back up data before accepting installation of an update.

To get more information and to download the Nokia Software Updater application, visit [www.nokia.com/softwareupdate](http://www.nokia.com/softwareupdate) or your local Nokia website.

If software updates over the air are supported by your network, you may also be able to request updates through the device.

 **Tip:** To check the software version in your device, enter **\*#0000#** in the home screen.

## 4. Call functions

### Voice calls

When security features that restrict calls are in use (such as call barring, closed user group, and fixed dialling), calls may be possible to the official emergency number programmed into your device. Call barring and call diverting cannot be active at the same time.

When the device or keypad is locked, calls may be possible to the official emergency number programmed into your device.

### Make a call

To make a call, enter the phone number, including the area code, and press the call key.



**Tip:** For international calls, add the + character that replaces the international access code, and enter the country code, area code (omit the leading 0, if necessary), and phone number.

To end the call or cancel the call attempt, press the end key.

To make a call using the saved contacts, open the contacts. Enter the first letters of the name, scroll to the name, and press the call key.

To make a call using the log, press the call key to view up to 20 numbers that you last called or attempted to call. Scroll to the desired number or name, and press the call key.

To adjust the volume of an active call, use the volume keys.

To switch from a voice call to a video call, select **Options** > **Switch to video call**. The device ends the voice call and makes a video call to the recipient.

### Speed dialling

Select  > **Settings** > **Settings** and **Phone** > **Call** > **Speed dialling**.

Speed dialling allows you to make a call by pressing and holding a number key in the home screen.

To activate speed dialling, select **On**.

To assign a number key to a phone number, select  > **Settings** > **Speed dial**. Scroll to the number key (2 - 9) on the display, and select **Options** > **Assign**. Select the desired number from the contacts list.

To delete the phone number assigned to a number key, scroll to the speed dialling key, and select **Options** > **Remove**.

To modify a phone number assigned to a number key, scroll to the speed dialling key, and select **Options** > **Change**.

### Voice mail

Select  > **Settings** > **Call mailbox**.

When you open the Voice mail application for the first time, you are asked to enter the number of your voice mailbox.

### Call functions

To call your voice mailbox, scroll to Voice mailbox, and select **Options > Call voice mailbox**.

To call your video mailbox, scroll to Video mailbox, and select **Options > Call video mailbox**.

To call your mailbox in the home screen, press and hold **1**; or press **1** and then the call key. Select the mailbox you want to call.

To change the mailbox number, select the mailbox and **Options > Change number**.

### Make a conference call

1. To make a conference call, enter a participant's phone number, and press the call key.
2. When the participant answers, select **Options > New call**.
3. When you have made a phone call to all the participants, select **Options > Conference** to merge the calls into a conference call.

To mute the microphone of your device during the call, select **Options > Mute**.

To drop a participant from the conference call, scroll to the participant, and select **Options > Conference > Drop participant**.

To discuss privately with a conference call participant, scroll to the participant, and select **Options > Conference > Private**.

### Answer a call

To answer a call, press the call key.

To reject a call, press the end key.

To mute the ringing tone instead of answering a call, select **Silence**.

When you have an active call and the call waiting function (network service) is activated, press the call key to answer a new incoming call. The first call is put on hold. To end the active call, press the end key.

### Call and data registers

Select **Log**.

To view recently missed, received, and dialed calls, select **Recent calls**.

 **Tip:** To view the dialed numbers when in the home screen, press the call key.

To view the approximate duration of calls to and from your device, select **Call duration**.

To view the amount of data transferred during packet data connections, select **Packet data**.

### Video calls

#### Make a video call

To make a video call, enter the phone number or select the recipient from the contacts list and **Options > Call > Video call**. When the video call starts, the camera of the device is

activated. If the camera is already in use, video sending is disabled. If the recipient of the call does not want to send video back to you, a still image is shown instead. To define the still image sent from your device instead of video, select **⚙️ > Settings > Settings and Phone > Call > Image in video call**.

To disable the sending of audio, video, or video and audio, select **Options > Disable > Sending audio, Sending video, or Sending aud. & video**.

To adjust the volume of an active video call, use the volume keys.

To use the loudspeaker, select **Options > Activate loudspeaker**. To mute the loudspeaker and use the earpiece, select **Options > Activate handset**.

To swap the places of images, select **Options > Swap images**.

To zoom the image on the display, select **Options > Zoom** and scroll up or down.

To end the video call and make a new voice call to the same recipient, select **Options > Switch to voice call**.

### Answer or decline a video call

When a video call arrives,  is displayed.

To answer the video call, press the call key. **Allow video image to be sent to caller?** is displayed. To start sending live video image, select **Yes**.

### Call functions

If you do not activate the video call, you only hear the sound of the caller. A grey screen replaces the video image. To replace the grey screen with a still image captured by the camera in your device, select **Tools > Settings > Phone > Call > Image in video call**.

To end the video call, press the end key.

## Call settings

### Call settings

Select **⚙️ > Settings > Settings and Phone > Call**.

Select from the following:

- **Send my caller ID** — Display your phone number to the person you are calling.
- **Call waiting** — Set the device to notify you of incoming calls while you are in a call (network service).
- **Reject call with message** — Reject a call, and send a text message to the caller.
- **Message text** — Write the standard text message that is sent when you reject a call.
- **Own video in recvd. call** — Allow or deny video sending during a video call from your device.
- **Image in video call** — Display a still image if video is not sent during a video call.
- **Automatic redial** — Set your device to make a maximum of 10 attempts to connect the call after an unsuccessful call attempt. To stop automatic redialling, press the end key.
- **Show call duration** — Display the length of a call during the call.

### Call functions

- **Summary after call** — Display the length of a call after the call.
- **Speed dialling** — Activate speed dialling.
- **Anykey answer** — Activate anykey answer.

### Call divert

Select  > **Settings** > **Settings and Phone** > **Call divert**.

Divert incoming calls to your voice mailbox or to another phone number. For details, contact your service provider.

Select the type of calls to divert and from the following:

- **All voice calls, All data and video calls, or All fax calls** — Divert all incoming voice, data, video, or fax calls. You cannot answer the calls, only divert the calls to another number.
- **If busy** — Divert incoming calls if you have an active call.
- **If not answered** — Divert incoming calls after your device rings for a specified length of time. Select the length of time for the device to ring before diverting the call.
- **If out of reach** — Divert calls when the device is switched off or out of network coverage.
- **If not available** — Divert calls if you have an active call, do not answer, or the device is switched off or out of network coverage.

To divert calls to your voice mailbox, select a call type, a diverting option, and **Options** > **Activate** > **To voice mailbox**.

To divert calls to another phone number, select a call type, a diverting option, and **Options** > **Activate** > **To other**

**number**. Enter the number, or select **Find** to retrieve a number saved in Contacts.

To check the current diverting status, scroll to the diverting option, and select **Options** > **Check status**.

To stop diverting calls, scroll to the diverting option, and select **Options** > **Deactivate**.

### Call barring

Select  > **Settings** > **Settings and Phone** > **Call barring**.

You can bar the calls that can be made or received with the device (network service). To change the settings, you need the barring password from your service provider. Call barring affects all call types.

To bar calls, select from the following:

- **Outgoing calls** — Prevent making voice calls with your device.
- **Incoming calls** — Prevent incoming calls.
- **International calls** — Prevent calling to foreign countries or regions.
- **Incoming calls when roaming** — Prevent incoming calls when outside your home country.
- **International calls except to home country** — Prevent calls to foreign countries or regions, but allow calls to your home country.

To check the status of voice call barrings, select the barring option and **Options** > **Check status**.

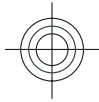

## Call functions

To deactivate all voice call barrings, select a barring option and **Options > Deactivate all barrings**.

To change the password used for barring voice, fax, and data calls, select **Options > Edit barring password**. Enter the current code, then the new code twice. The barring password must be four digits long. For details, contact your service provider.

### Network settings

Select  > **Settings > Settings and Phone > Network**.

To select the network mode, select **Network mode** and **Dual mode, UMTS**, or **GSM**. In dual mode, the device switches automatically between networks.



**Tip:** Selecting **UMTS** enables faster data transfer, but may increase the demand on battery power and reduce the battery life. In regions close to both GSM and UMTS networks, selecting **Dual mode** may cause constant jumping between the two networks, which also increases the demand on battery power.

To select the operator, select **Operator selection** and **Manual** to select from available networks, or **Automatic** to set the device to select the network automatically.

To set the device to indicate when it is used in a microcellular network (MCN), select **Cell info display > On**.



## Video sharing

### Video sharing requirements

Video sharing requires a UMTS connection. For more information on the service, UMTS network availability, and fees associated with using this service, contact your service provider.

To use video sharing you must do the following:

- Ensure that your device is set up for person-to-person connections.
- Ensure you have an active UMTS connection and are within UMTS network coverage. If you move outside the UMTS network during a video sharing session, the sharing stops while your voice call continues.
- Ensure that both the sender and recipient are registered to the UMTS network. If you invite someone to a sharing session and the recipient's device is not within UMTS network coverage, does not have video sharing installed, or person-to-person connections set up, the recipient does not receive invitations. You receive an error message that indicates that the recipient cannot accept the invitation.

### Share live video or video clips

During an active voice call, select **Options > Share video**.

1. To share live video during the call, select **Live video**.

To share a video clip, select **Video clip** and the clip you want to share.

You may need to convert the video clip into a suitable format to be able to share it. If your device notifies you





## Media



that the video clip must be converted, select **OK**. Your device must have a video editor for the conversion to work.



2. If the recipient has several SIP addresses or phone numbers including the country code saved in the contacts list, select the desired address or number. If the SIP address or phone number of the recipient is not available, enter the address or number of the recipient including the country code, and select **OK** to send the invitation. Your device sends the invitation to the SIP address.



Sharing begins automatically when the recipient accepts the invitation.

### Options during video sharing

-  Zoom the video (available for sender only).
-  Adjust the brightness (available for sender only).

 or  Mute or unmute the microphone.

 or  Turn the loudspeaker on and off.

 or  Pause and resume video sharing.

 Switch to full screen mode (available for receiver only).

3. To end the sharing session, select **Stop**. To end the voice call, press the end key. When you end the call, video sharing also ends.

To save the live video you shared, select **Yes** when prompted. The device notifies you of the location of the saved video.

If you access other applications while you are sharing a video clip, the sharing is paused. To return to the video sharing view, and to continue sharing, in the home screen, select **Options > Continue**.

## 5. Media

 **Warning:** When you use the headset, your ability to hear outside sounds may be affected. Do not use the headset where it can endanger your safety.

### Music player

Select  > **Applications > Music player**.

With Music player, you can play music files, and create and listen to playlists. Music player supports file formats such as MP3 and AAC.

### Play a song or a podcast episode

To add all available songs and podcasts to the music library, select **Options > Refresh library**.

To play a song or a podcast episode, select the desired category, and the song or podcast episode.

To modify the tone of the music playback, select **Options > Equaliser**.





## Positioning

To modify the balance and stereo image, or to enhance the bass, select **Options** > **Audio settings**.

To return to the home screen and leave the player playing in the background, press the end key.

## 6. Positioning

### About GPS

The coordinates in the GPS are expressed in the degrees and decimal degrees format using the international WGS-84 coordinate system.

The Global Positioning System (GPS) is operated by the government of the United States, which is solely responsible for its accuracy and maintenance. The accuracy of location data can be affected by adjustments to GPS satellites made by the United States government and is subject to change with the United States Department of Defense civil GPS policy and the Federal Radionavigation Plan. Accuracy can also be affected by poor satellite geometry. Availability and quality of GPS signals may be affected by your location, buildings, natural obstacles, and weather conditions. GPS signals may not be available inside buildings or underground and may be impaired by materials such as concrete and metal.

GPS should not be used for precise location measurement, and you should never rely solely on location data from the GPS receiver and cellular radio networks for positioning or navigation.

Different positioning methods can be enabled or disabled in positioning settings.

### Assisted GPS (A-GPS)

Your device also supports assisted GPS (A-GPS).

A-GPS is a network service.

Assisted GPS (A-GPS) is used to retrieve assistance data over a packet data connection, which assists in calculating the coordinates of your current location when your device is receiving signals from satellites.

When you activate A-GPS, your device receives useful satellite information from an assistance data server over the cellular network. With the help of assisted data, your device can obtain the GPS position faster.

Your device is preconfigured to use the Nokia A-GPS service, if no service provider-specific A-GPS settings are available. The assistance data is retrieved from the Nokia A-GPS service server only when needed.

To disable the A-GPS service, select **⌘** > **Applications** > **GPS data** and **Options** > **Positioning settings** > **Positioning methods** > **Assisted GPS** > **Disable**.

You must have an internet access point defined in the device to retrieve assistance data from the Nokia A-GPS service over a packet data connection. The access point for A-GPS can be defined in positioning settings. A wireless LAN (WLAN) access point cannot be used for this service. Only a packet data

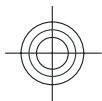

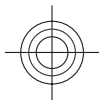

### Positioning

internet access point can be used. Your device asks you to select the internet access point when GPS is used for the first time.

### Maps

Content such as satellite images, guides, weather and traffic information and related services are generated by third parties independent of Nokia. The content may be inaccurate and incomplete to some extent and is subject to availability. Never rely solely on the aforementioned content and related services.

Select **⌘** > **Maps**, or press the Navigator key.

### About Maps

With Maps, you can see your current location on the map, browse maps of different cities and countries, search for places, plan routes from one location to another, save locations, and send them to compatible devices. You can also purchase licences for traffic information and navigation services, if available for your country or region.

When you use Maps for the first time, you may need to select an internet access point for downloading maps.

If you browse to an area which is not covered by maps already downloaded in your device, a map for the area is automatically downloaded through the internet. Some maps may be available in your device or on a memory card. You can also use the Nokia Map Loader PC software to download maps. To install Nokia Map Loader to a compatible PC, see [www.nokia.com/maps](http://www.nokia.com/maps).



**Tip:** To avoid data transfer costs, you can also use Maps without an internet connection, and browse the maps that are saved in your device or memory card.



**Note:** Downloading content such as maps, satellite images, voice files, guides or traffic information may involve transmission of large amounts of data (network service).

Almost all digital cartography is inaccurate and incomplete to some extent. Never rely solely on the cartography that you download for use in this device.

For instructions on how to use the various features of Maps, select **⌘** > **Applications** > **Help** > **Help and Maps**, or when using Maps, select **Options** > **Support** > **Help**.

### Maps and licences

Your device has pre-loaded maps. The maps may vary depending on the region where you purchase your device.

Your device has a global licence for pedestrian navigation.

Your device has a licence for car navigation valid for preselected regions in the pre-loaded maps only.

Your device has licences for location-related content and services, such as traffic information, weather reports, and events. The licences have a validity period of two years from purchase, and may be valid only for the preselected regions in the pre-loaded maps. These services may require a connection to the internet.

All licences are activated when you purchase the device. Licences are tied to the device and cannot be transferred to any other device.





For more information, check [www.nokia.com/support](http://www.nokia.com/support) or your local Nokia website.

### About licences

To purchase a service for your current location, select **Options > Shop & Licenses > Shop**.

When you purchase a service, you have two options:

- purchase a licence with a fixed end date
- subscribe to a licence that is automatically renewed every 30 days until you cancel it. To cancel the licence, select **Options > Shop & Licenses > My licenses**, scroll to the licence, and select **Options > Cancel subscription**.

You can pay for the service in your phone bill or with your credit card. During the purchase, you can select to save your credit card number and expiry date to your device. To remove the credit card information from your device, select **Options > Clear personal data**.

To view your valid licences, select **Options > Shop & Licenses > My licenses**.

To view the services available in other regions, select **Options > Shop & Licenses > Options > Shops for other regions**.

### Calibrate the compass

Your device has an internal compass. When the compass is calibrated, the circle around the compass is green, and the map view rotates automatically according to the direction to which the top of the device is pointing.

### Positioning

The compass has limited accuracy. Electromagnetic fields, metal objects, or other external circumstances may also affect the accuracy of the compass. The compass should always be properly calibrated.

To calibrate the compass, do the following:

1. Select **☰ > Maps**.
2. The compass is active by default. To deactivate the compass, select **Options > Tools > Turn compass off**. When the compass is deactivated, the circle around the compass is white, and the map view does not rotate automatically. Deactivating the compass is only valid for the current session. When you open Maps the next time, the compass is activated automatically.
3. Rotate the device around all axes in a continuous movement until the calibration indicator changes its colour to green . If the indicator is yellow, the accuracy of the compass is low. If the indicator is red, the compass is not calibrated.

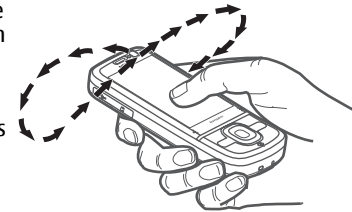

### Display indicators

The GPS indicator  shows the availability of the satellite signals. One bar is one satellite. When the device tries







### Positioning

to find satellite signals, the bar is yellow. When the device receives enough data from the satellites for GPS to calculate your location, the bar turns green. The more green bars, the more reliable the location calculation.

Initially, your device must receive signals from at least four satellites to calculate the coordinates of your location. After the initial calculation, signals from three satellites may be enough.

The data transfer indicator  **21.5 kb** shows the internet connection used, and the amount of data transferred since the application started.

### Move on a map

When the GPS connection is active,  shows your current location on the map.

To zoom in to your current or last known location, select **Options > My position**.

To move on the map, scroll up, down, left, or right with the scroll key. The map is oriented towards north by default.

When you have an active GPS connection and browse the map on the display, a new map is automatically downloaded if you scroll to an area not covered by the maps that have already been downloaded. The maps are automatically saved in the device memory or on a compatible memory card, if inserted.

To zoom in and out on the map, press \* and #.

To change the map type, select **Options > Map mode**.

### Find locations

To search for locations, press the scroll key and select **Explore**. Start entering the location name in the search field. The device suggests matching nearby locations. Select the location from the list, or enter the location name in the search field, and select **Search**.

1. To find a specific address, select **Options > Address search**.
2. Start entering the required information. The fields marked with an asterisk (\*) are mandatory.
3. Select the address from the list of suggested matches.
4. Select **Options > Search**.

To find an address saved in the contacts list, select **Options > Address search > Options > Select from Contacts**.

To search for locations by their coordinates, select **Options > Address search > Options > Search by coordinates**. To select the coordinate format, scroll up or down.

To search for locations in specific categories, such as restaurants or shopping, press the scroll key, and select **Explore**. Select a category, and enter the search terms in the search field.

### Save and send locations

To save a location to your device, press the scroll key, and select **Save**.

To view your saved locations, in the main view, select **Options > Favourites**.





To send a location to a compatible device, press the scroll key, and select **Send**.

### Your search history

To check which locations you have recently searched for, select **Options > History**.

To view the selected location on the map, press the scroll key, and select **Show on map**.

To send the location to a compatible device, press the scroll key, and select **Send**.

To add the location to a route, press the scroll key, and select **Add to route**.

### Plan a route

To plan a route, scroll to your start point on the map, press the scroll key, and select **Add to route**. To add the destination and more locations to the route, select **Add new route point**. If you want to use your current position as the starting point, add the destination to the route.

To change the order of the locations in the route, scroll to a location, press the scroll key, and select **Move**. Scroll to the place where you want to move the location, and select **Select**.

To edit the route, press the scroll key, and select **Edit route**.

To show the route on the map, select **Show route**.



### Positioning

To navigate to the destination by car or on foot, if you have purchased a licence for these services, select **Show route > Options > Start driving** or **Start walking**.

To save the route, select **Show route > Options > Save route**.

### Drive to your destination

 **Warning:** The location of speed/safety cameras can be shown on your route during navigation, if this feature is enabled. Some jurisdictions prohibit or regulate the use of speed/safety camera location data. Nokia is not responsible for the accuracy, or the consequences of use of speed/safety camera location data.

To start navigating by car, scroll to a location, press the scroll key, and select **Drive to**. When you use car navigation for the first time, you are asked to select the language of the voice guidance and download the related voice guidance files.

Downloading voice guidance files may involve the transmission of large amounts of data through your service provider's network. Contact your service provider for information about data transmission charges.

To switch between different views during the navigation, press the scroll key, and select **2D view**, **3D view**, **Arrow view**, or **Route overview**.

To find an alternative route, select **Options > Diff. route**.

To repeat the voice guidance, select **Options > Repeat**.



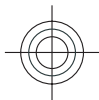

### Positioning

To adjust the volume of the voice guidance, select **Options** > **Volume**.

To view details about the trip distance and duration, select **Options** > **Dashboard**.

To stop navigating, select **Stop**.

### Walk to your destination

The walking route includes pedestrian zones and parks, prioritises walkways and smaller roads, and omits motorways.

The distance between the start and end points of a walking route is limited to a maximum of 50 kilometres (31 miles) and the travelling speed to a maximum of 30 kph (18 mph). If the speed limit is exceeded, navigation stops and is resumed once the speed is back within limits.

There is no voice guidance available for pedestrian navigation, but the device guides you with a tone or vibration approximately 20 metres (22 yards) before you need to turn or make another manoeuvre. The guiding method depends on the settings of the profile currently active in your device.

To start navigating, scroll to a location, press the scroll key, and select **Walk to**.

If the destination is on off-road terrain, the route is displayed as a straight line to indicate the walking direction.

To see an overview of the route, select **Options** > **Route overview**.

To stop navigating, select **Stop**.

### Traffic and safety

The real-time traffic information service provides information about traffic events that may affect your travel. You may need to download the traffic information service to your device, if available in your country or region.

 **Note:** Downloading content such as maps, satellite images, voice files, guides or traffic information may involve transmission of large amounts of data (network service).

Content such as satellite images, guides, weather and traffic information and related services are generated by third parties independent of Nokia. The content may be inaccurate and incomplete to some extent and is subject to availability. Never rely solely on the aforementioned content and related services.

 **Warning:** The location of speed/safety cameras can be shown on your route during navigation, if this feature is enabled. Some jurisdictions prohibit or regulate the use of speed/safety camera location data. Nokia is not responsible for the accuracy, or the consequences of use of speed/safety camera location data.

To view information about traffic events, select **Options** > **Traffic info**. The events are shown on the map as triangles and lines.

To view the details of an event, including possible rerouting options, select **Options** > **Open**.

To update the traffic information, select **Update traffic info**.



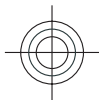

## Positioning

To set your device to plan a new route automatically to avoid traffic events, in the main view, select **Options > Tools > Settings > Navigation > Reroute due to traffic**.

### Synchronise your favourite locations with Ovi Maps

The Ovi website contains the internet services that Nokia provides. The Ovi Maps section contains services related to Maps.

To create an account for Ovi, see [www.ovi.com](http://www.ovi.com).

To synchronise the locations, collections, and routes you have saved to your device with your Ovi account, select **Options > Favourites > Synchronise with OVI**.

To set the device to synchronise your saved locations, collections, and routes with your Ovi account automatically when you open and close the Maps application, select **Options > Tools > Settings > Synchronisation > Synchronise with OVI > At start-up and shut-d..**

Synchronising may involve the transmission of large amounts of data through your service provider's network. Contact your service provider for information about data transmission charges.

### Maps settings

To edit the Maps settings, select **Options > Tools > Settings** and from the following:

- **Internet** — Define the internet settings.
- **Navigation** — Define the navigation settings.

- **Route** — Define the routing settings.
- **Map** — Define the map settings.
- **Synchronisation** — Define the settings for synchronising saved items with the Ovi web service.

### Nokia Map Loader

With the Nokia Map Loader application, you can download maps and voice guidance files from the internet to the device memory or a compatible memory card. You must use the Maps application and browse maps at least once before using Nokia Map Loader, as Nokia Map Loader uses the Maps information to check which version of the maps to download.

To install Nokia Map Loader to a compatible computer, go to <http://nokia.com/maps>, and follow the instructions on the display.

### Landmarks

Select **☰ > Applications > Landmarks**.

With Landmarks, you can save the position information of specific locations in your device. You can sort the saved locations into different categories, such as business, and add other information to them, such as addresses. You can use your saved landmarks in compatible applications, such as GPS data.

GPS coordinates are expressed in the degrees and decimal degrees format using the international WGS-84 coordinate system.

Select **Options** and from the following:



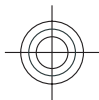

### Positioning

- **New landmark** — Create a new landmark. To make a positioning request for your current location, select **Current position**. To select the location from map, select **Select from map**. To enter the position information manually, select **Enter manually**.
- **Edit** — Edit or add information to a saved landmark (for example, a street address).
- **Add to category** — Add a landmark to a category in Landmarks. Select each category to which you want to add the landmark.
- **Send** — Send one or several landmarks to a compatible device. Your received landmarks are placed in the Inbox folder in Messaging.

You can sort your landmarks into preset categories, and create new categories. To edit and create new landmark categories, open the categories tab, and select **Options > Edit categories**.

### GPS data

#### Route guidance

Select **⌘ > Applications > GPS data and Navigation**.

Start the route guidance outdoors. If started indoors, the GPS receiver may not receive the necessary information from the satellites.

Route guidance uses a rotating compass on the device display. A red ball shows the direction to the destination, and

the approximate distance to it is shown inside the compass ring.

Route guidance is designed to show the straightest route and the shortest distance to the destination, measured in a straight line. Any obstacles on the route, such as buildings and natural obstacles, are ignored. Differences in altitude are not taken into account when calculating the distance. Route guidance is active only when you move.

To set your trip destination, select **Options > Set destination** and a landmark as the destination, or enter the latitude and longitude coordinates.

To clear the destination set for your trip, select **Stop navigation**.

#### Retrieve position information

Select **⌘ > Applications > GPS data and Position**.

In the position view, you can view the position information of your current location. An estimate of the accuracy of the location is displayed.

To save your current location as a landmark, select **Options > Save position**. Landmarks are saved locations with more information, and they can be used in other compatible applications and transferred between compatible devices.





## 7. Write text

### Traditional text input

**Abc** indicates traditional text input.

**ABC** and **abc** indicate the uppercase and lowercase.

**Abc** indicates the sentence case, that is, the first letter of the sentence is written in uppercase and all the other letters are automatically written in lowercase. **123** indicates number mode.

To write text with the keypad, press a number key, 2-9, repeatedly until the desired character is displayed. There are more characters available for a number key than are printed on the key. If the next letter is located on the same key as the present one, wait until the cursor is displayed, and enter the letter.

To insert a number, press and hold the number key.

To switch between the different character cases and modes, press #.

To enter the most common punctuation marks, press **1** repeatedly until the desired punctuation mark is displayed.

To add special characters, press and hold \*.

To insert a space, press **0**. To insert a line break, press **0** three times.

### Predictive text input

1. To activate or deactivate predictive text input, press # twice quickly. This activates or deactivates predictive text input for all editors in the device.  indicates that predictive text input is activated.
2. To write the desired word, press the keys 2-9. Press each key once for each letter.
3. When you have finished writing the word, and it is correct, scroll right to confirm it, or press **0** to add a space.

If the word is not correct, press \* repeatedly to view the matching words in the dictionary.

If the ? character is displayed after the word, the word you intended to write is not in the dictionary. To add a word to the dictionary, select **Spell**, enter the word (up to 32 letters) using traditional text input, and select **OK**. The word is added to the dictionary. When the dictionary is full, the new word replaces the oldest added word.

Write the first part of a compound word; to confirm it, scroll right. Write the second part of the compound word. To complete the compound word, press **0** to add a space.

### Change the writing language

When you are writing text, you can change the writing language. For example, if you press the 6 key repeatedly to

### Messaging

reach a specific character, changing the writing language gives you access to characters in a different order.

If you are writing text using a non-Latin alphabet and want to write Latin characters, for example e-mail or web addresses, you may need to change the writing language. To change the writing language, select **Options** > **Input options** > **Writing language**, and a writing language that uses Latin characters.

### Copy and delete text

1. To select letters and words, press and hold #, and at the same time scroll left or right. To select lines of text, press and hold #, and at the same time scroll up or down.

## 8. Messaging

Only devices that have compatible features can receive and display multimedia messages. The appearance of a message may vary depending on the receiving device.

### Write and send messages

Select **✉** > **Messaging**.

Before you can create a multimedia message or write an e-mail, you must have the correct connection settings in place.

The wireless network may limit the size of MMS messages. If the inserted picture exceeds this limit, the device may make it smaller so that it can be sent by MMS.

2. To copy the text, press and hold #, and at the same time select **Copy**.

To delete the selected text, press the clear key **C**.

3. To paste the text, scroll to the desired location, press and hold #, and at the same time select **Paste**.

Check the size limit of e-mail messages with your service provider. If you attempt to send an e-mail message that exceeds the size limit of the e-mail server, the message is left in the Outbox folder, and the device attempts to resend it periodically. Sending an e-mail requires a data connection, and continuous attempts to resend the e-mail may increase your phone bill. In the Outbox folder, you can delete such a message, or move it to the Drafts folder.

1. Select **New message** > **Message** to send a text or multimedia message (MMS), **Audio message** to send a message that includes one sound clip, or **E-mail** to send an e-mail message.



## Messaging

2. In the To field, press the scroll key to select recipients or groups from the contacts list, or enter the recipient's phone number or e-mail address. To add a semicolon (;) that separates the recipients, press and hold \*.
3. In the Subject field, enter the subject of the e-mail. To change the fields that are visible, select **Options > Message header fields**.
4. In the message field, write the message. To insert a template or note, select **Options > Insert content > Insert text > Template** or **Note**.
5. To add a media object to a multimedia message, select **Options > Insert content**, the object type or source, and the desired object. To add a business card, slide, note, or some other file to the message, select **Options > Insert content > Insert other**.
6. To capture an image or record a video or sound clip for a multimedia message, select **Options > Insert content > Insert image > New**, **Insert video clip > New**, or **Insert sound clip > New**.
7. To add an attachment to an e-mail, select **Options > Add attachment**. E-mail attachments are indicated by .
8. To send the message, select **Options > Send**, or press the call key.



**Note:** The message sent icon or text on your device screen does not indicate that the message is received at the intended destination.

Your device supports text messages beyond the limit for a single message. Longer messages are sent as two or more

messages. Your service provider may charge accordingly. Characters with accents, other marks, or some language options take more space, and limit the number of characters that can be sent in a single message.

You may not be able to send video clips that are saved in the MP4 file format or that exceed the size limit of the wireless network in a multimedia message.



**Tip:** You can combine images, video, sound, and text as a presentation and send it in a multimedia message. Start to create a multimedia message, and select **Options > Insert content > Insert presentation**. The option is shown only if **MMS creation mode** is set to **Guided** or **Free**.

## Message reader

With Message reader you can listen to text, multimedia, and audio messages and e-mail.

To change the message reading settings in the Speech application, select **Options > Speech**.

To listen to new messages or e-mail, in the home screen, press and hold the left selection key until the Message reader application opens.

To listen to messages from your Inbox folder or e-mail from your Mailbox, select a message and **Options > Listen**. To stop the reading, press the end key.

To pause or resume, press the scroll key. To skip to the next message or e-mail, scroll right. To replay the current message



## Messaging

or e-mail, scroll left. To skip to the previous message, scroll left twice. To adjust the volume, scroll up or down.

To view the current message or e-mail in text format without the sound, select **Options > View**.

## E-mail

### Set up your e-mail

With the Nokia e-mail wizard, you can set up your corporate e-mail account, such as Microsoft Outlook, Mail for Exchange, or Intellisync, and your internet e-mail account.

When setting up your corporate e-mail, you may be prompted for the name of the server associated with your e-mail address. Ask your company IT department for details.

1. To start the wizard, go to the home screen, scroll to the e-mail wizard, and press the scroll key.
2. Enter your e-mail address and password. If the wizard is not able to configure your e-mail settings automatically, you need to select your e-mail account type and enter the related account settings.

If your device contains any additional e-mail clients, those are offered to you when you start the e-mail wizard.

### Send e-mail

Select  > **Messaging**.

1. Select your mailbox and **Options > Create email**.
2. In the To field, enter the recipient's e-mail address. If the recipient's e-mail address can be found in Contacts, start

entering the recipient's name, and select the recipient from the proposed matches. If you add several recipients, insert ; to separate the e-mail addresses. Use the Cc field to send a copy to other recipients, or the Bcc field to send a blind copy to recipients. If the Bcc field is not visible, select **Options > More > Show Bcc field**.

3. In the Subject field, enter the subject of the e-mail.
4. Enter your message in the text area.
5. Select **Options** and from the following:
  - **Add attachment** — Add an attachment to the message.
  - **Priority** — Set the priority of the message.
  - **Flag** — Flag the message for follow-up.
  - **Insert template** — Insert text from a template.
  - **Add recipient** — Add recipients to the message from Contacts.
  - **Editing options** — Cut, copy, or paste the selected text.
  - **Input options** — Activate or deactivate predictive text input, or select the writing language.
6. Select **Options > Send**.

### Read e-mail

Select  > **Messaging**.

 **Important:** Exercise caution when opening messages. Messages may contain malicious software or otherwise be harmful to your device or PC.

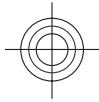

## Messaging

To read a received e-mail message, select the mailbox, and select the message from the list.

To reply to the message sender, select **Options** > **Reply**. To reply to the sender and all other recipients, select **Options** > **Reply to all**.

To forward the message, select **Options** > **Forward**.

### Download attachments

Select  > **Messaging** and a mailbox.

To view the attachments in a received e-mail message, scroll to the attachment field, and select **Options** > **Actions**. If there is one attachment in the message, select **Open** to open the attachment. If there are several attachments, select **View list** to see a list showing which attachments have been downloaded or not.

To download the selected attachment or all the attachments from the list to your device, select **Options** > **Download** or **Download all**. The attachments are not saved in your device, and are deleted when you delete the message.

To save the selected attachment or all the downloaded attachments in your device, select **Options** > **Save** or **Save all**.

To open the selected, downloaded attachment, select **Options** > **Actions** > **Open**.

### Disconnect from the mailbox

Select  > **Messaging** and a mailbox.

To cancel the synchronisation between the device and the e-mail server, and to work with e-mail without a wireless connection, select **Options** > **Disconnect**. If your mailbox does not have the **Disconnect** option, select **Options** > **Exit** to disconnect from the mailbox.

To start the synchronisation again, select **Options** > **Connect**.

### General e-mail settings

Select  > **Messaging**, mailbox, and **Options** > **Settings** > **Global settings** and from the following:

- **Message list layout** — Select whether the e-mail messages in Inbox display one or two lines of text.
- **Body text preview** — Select whether to preview messages when scrolling through the list of e-mail messages in Inbox.
- **Title dividers** — Select **On** to be able to expand and collapse the list of e-mail messages.
- **Download notifications** — Select whether to have the device to display a notification when an e-mail attachment has been downloaded.
- **Home screen** — Define how many lines of e-mail are shown in the home screen information area.

### ActiveSync

Use of the Mail for Exchange is limited to over-the-air synchronisation of PIM information between the Nokia device and the authorised Microsoft Exchange server.



## Messaging

### View messages on a SIM card

Select  > **Messaging** and **Options** > **SIM messages**.

Before you can view SIM messages, you must copy them to a folder in your device.

1. Select **Options** > **Mark/Unmark** > **Mark** or **Mark all** to mark messages.
2. Select **Options** > **Copy**. A list of folders opens.
3. To start copying, select a folder. To view the messages, open the folder.

### Messaging settings

The settings may be preconfigured in your device, or you may receive them in a message. To enter settings manually, fill in all fields marked with **Must be defined** or an asterisk.

Some or all message centres or access points may be preset for your device by your service provider, and you may not be able to change, create, edit, or remove them.

### Text message settings

Select  > **Messaging** and **Options** > **Settings** > **Text message**.

Select from the following:

- **Message centres** — View a list of all text message centres that have been defined.
- **Message centre in use** — Select which message centre to use to deliver text messages.

- **Character encoding** — To use character conversion to another encoding system when available, select **Reduced support**.
- **Receive report** — Select whether the network sends delivery reports on your messages (network service).
- **Message validity** — Select how long the message centre resends your message if the first attempt fails (network service). If the message cannot be sent within the validity period, the message is deleted from the message centre.
- **Message sent as** — To learn if your message centre is able to convert text messages into these other formats, contact your service provider.
- **Preferred connection** — Select the connection to use.
- **Reply via same centre** — Select whether you want the reply message to be sent using the same text message centre number (network service).

### Multimedia message settings

Select  > **Messaging** and **Options** > **Settings** > **Multimedia message**.

Select from the following:

- **Image size** — Define the size of the image in a multimedia message.
- **MMS creation mode** — If you select **Guided**, the device informs you if you try to send a message that may not be supported by the recipient. If you select **Restricted**, the device prevents you from sending messages that may not be supported. To include content in your messages without notifications, select **Free**.

- **Access point in use** — Select which access point is used as the preferred connection.
- **Multimedia retrieval** — Select how you want to receive messages. To receive messages automatically in your home network, select **Auto in home netw.** Outside your home network, you receive a notification that there is a message to retrieve in the multimedia message centre. If you select **Always automatic**, your device automatically makes an active packet data connection to retrieve the message both in and outside your home network.
- **Allow anonymous msgs.** — Select whether you want to reject messages from an anonymous sender.
- **Receive adverts** — Select whether you want to receive multimedia message advertisements.
- **Receive reports** — Select whether you want the status of the sent message to be shown in the log (network service).
- **Deny report sending** — Select whether you want to prevent your device from sending delivery reports of received messages.
- **Message validity** — Select for how long the message centre resends your message if the first attempt fails (network service). If the message cannot be sent within this time period, the message is deleted from the message centre.

### Web service message settings

Press **Ⓜ**, and select **Messaging > Options > Settings > Service message**.

Select whether you want to receive service messages. If you want to set the device to automatically activate the browser and start a network connection to retrieve content when you receive a service message, select **Download messages > Automatically**.

### Cell broadcast settings

Check the available topics and related topic numbers with your service provider.

Press **Ⓜ**, and select **Messaging > Options > Settings > Cell broadcast**.

Select from the following:

- **Reception** — Select whether you want to receive cell broadcast messages.
- **Language** — Select the languages in which you want to receive messages: **All**, **Selected**, or **Other**.
- **Topic detection** — Select whether the device automatically searches for new topic numbers, and saves the new numbers without a name to the topic list.

### Other settings

Press **Ⓜ**, and select **Messaging > Options > Settings > Other**.

Select from the following:

- **Save sent messages** — Select whether you want to save a copy of the text messages, multimedia messages, or e-mail that you send to the **Sent** folder.

### Messaging



## Contacts

- **Number of saved msgs.** — Define how many sent messages are saved to the sent folder at a time. When the limit is reached, the oldest message is deleted.
- **Memory in use** — Select the memory where you want to save your messages.

# 9. Contacts

## Work with contacts

Select **⌘** > **Contacts**.

To create a contact, select **Options** > **New contact**, and enter the details of the contact.

To copy the details of a contact from the memory card, if available, select **Options** > **Create backup** > **Memory card to phone**.

To search for contacts, start entering the contact's name in the search field.

To switch to predictive search mode, select **Options** > **Activate predict. search**.

To search for contacts in predictive search mode, start entering the contact's name in the search field. To move to the next proposed match, press **\***.

## Location information

Usage of Maps information or services may be limited by the license you have purchased.



**Note:** Downloading content such as maps, satellite images, voice files, guides or traffic information may involve transmission of large amounts of data (network service).

Almost all digital cartography is inaccurate and incomplete to some extent. Never rely solely on the cartography that you download for use in this device.

Select **⌘** > **Contacts**.

To add location information to a contact from the Maps application, scroll to the contact, and select **Options** > **Edit** > **Options** > **Add location**.

If you have added location information to a contact from Maps, you may view the location on the map. Scroll to the contact, and select **Options** > **Show on Maps**.

## Create contact groups

Select **⌘** > **Contacts**.

1. To create a contact group, scroll to each contact you want to add to the group, and select **Options** > **Mark/Unmark** > **Mark**.
2. Select **Options** > **Group** > **Add to group** > **Create new group**, and enter a name for the group.







If you want to make conference calls to the group using a conference service, define the following:

- **Conf. service number** — Enter the conference call service number.
- **Conf. service ID** — Enter the conference call ID.
- **Conf. service PIN** — Enter the conference call PIN code.

To make a conference call to the group using the conference service, select the group, scroll right, and select **Call conf. service**.

## Add ringing tones for contacts

Select  > **Contacts**.

To add a ringing tone for a contact, select the contact, **Options** > **Ringing tone**, and a ringing tone. The ringing tone sounds when the contact calls you.

To add a ringing tone for a contact group, select the contact group, **Options** > **Group** > **Ringing tone**, and a ringing tone.

## 10. About Photos

Select  > **Gallery** > **Images & videos** and from the following:

- **Captured** — View all the images and videos you have captured.
- **Months** — View images and videos categorised by the month they were captured.

### About Photos

To remove the ringing tone, select **Default tone** from the list of ringing tones.

## Change Contacts settings

Select  > **Contacts**.

To change the settings of the Contacts application, select **Options** > **Settings** > **Contacts** and from the following:

- **Contacts to display** — Select the memories from where contacts are displayed.
- **Default saving memory** — Select the default memory to save contacts.
- **Name display** — Change the way the contacts' names are displayed.
- **Default contact list** — Select which contacts directory opens when you open the Contacts application.
- **Remote search server** — Change the remote contacts database. This option is only available if remote contacts databases are supported by your service provider.

- **Albums** — View the default albums and the ones you have created.
- **Tags** — View the tags you have created for each item.
- **Downloads** — View items and videos downloaded from the web or received as a multimedia or e-mail message.
- **All** — View all items.
- **Share online** — Post your images or videos to the web.



## Camera

Files stored on your compatible memory card (if inserted) are indicated with .

To copy or move files to another memory location, select a file, **Options** > **Move and copy**, and from the available options.

# 11. Camera

Keep a safe distance when using the flash. Do not use the flash on people or animals at close range. Do not cover the flash while taking a picture.

Your device has two cameras to capture still images and record videos. A high resolution main camera is on the back of the device using landscape mode, and lower resolution secondary camera is on the front of the device using portrait mode. To activate the secondary camera when the main camera is activated, select **Options** > **Use secondary camera**.

## Capture an image











Select  > **Camera**. You can also press the capture key to activate the camera.

Your device supports an image capture resolution of up to 2592 x 1944 pixels (5Mpix). The image resolution in this guide may appear different.

To capture an image, use the display as a viewfinder, and press the capture key. The device saves the image in Gallery.

To zoom in or out before capturing an image, use the zoom keys.

The toolbar provides you with shortcuts to different items and settings before and after capturing an image or recording a video clip. Select from the following:

-  Switch to image mode.
-  Switch to video mode.
-  Select the scene.
-  Switch the video light off (video mode only)
-  Switch the video light on (video mode only)
-  Select the flash mode (images only).
-  Activate the self-timer (images only).
-  Activate sequence mode (images only).
-  Select a colour tone.
-  Adjust the white balance.

The available options vary depending on the mode and view you are in. The settings return to the default values when you close the camera.

To customise the camera toolbar, switch to image mode, and select **Options** > **Customise toolbar**.



To view the toolbar before and after capturing an image or recording a video clip, select **Options** > **Show toolbar**.

To view the toolbar only when you need it, select **Options** > **Hide toolbar**.

### Capture a panorama image

1. To use panorama mode, select **Options** > **Panorama mode**.
2. Press the capture key. The panorama preview is displayed.
3. Turn slowly to the right or left. You cannot change direction. If the arrow on the display is red, you are turning too quickly.
4. To stop capturing the panorama image, press the capture key.

### Record videos

Select **Camera**.

1. If the camera is in image mode, select video mode from the toolbar.
2. To start recording, press the capture key.
3. To pause recording, select **Pause**. Select **Continue** to resume recording.

### Camera



4. To stop recording, select **Stop**. The video clip is automatically saved in Gallery. The maximum length of the video clip depends on the available memory.

### Location information

You can automatically add capture location information to the captured images and recorded video clips. For example, in the Photos application, you can then view the location where an image was captured.

To add location information to all captured material, in Camera, select **Options** > **Settings** > **Record location** > **On**.

Location information indicators at the bottom of the display:

-  — Location information unavailable. The GPS is active in the background for several minutes. If a satellite connection is established, the indicator changes to  within that time, all the images captured and video clips recorded during that time are tagged based on the received GPS positioning information.
-  — Location information is available. Location information is added to the captured material.

Files with location information are indicated with  in the Photos application.



## Internet

# 12. Internet

## Web browser

With the Web browser application, you can view hypertext markup language (HTML) web pages on the internet as originally designed. You can also browse web pages that are designed specifically for mobile devices, and use extensible hypertext markup language (XHTML), or the wireless markup language (WML).

To browse the web, you need to have an internet access point configured in your device.

### Browse the web

Select  > **Internet** > **Web**.

 **Shortcut:** To start the browser, press and hold **0** in the home screen.

To browse the web, in the bookmarks view, select a bookmark, or start to enter a web address (the  field opens automatically), and select **Go to**.

Some web pages may contain material, such as graphics and sounds, that requires a large amount of memory to view. If your device runs out of memory while loading such a web page, the graphics on the page are not shown.

To browse web pages with graphics disabled, to save memory and increase the page loading speed, select **Options** > **Settings** > **Page** > **Load content** > **Text only**.

To enter a web address, select **Options** > **Go to** > **New web page**.

To refresh the content of the web page, select **Options** > **Web page options** > **Reload**.

To save the current web page as a bookmark, select **Options** > **Web page options** > **Save as bookmark**.

To view snapshots of the web pages you have visited during the current browsing session, select **Back** (available if **History list** is activated in the browser settings and the current web page is not the first web page you visit).

To prevent or allow the automatic opening of multiple windows, select **Options** > **Web page options** > **Block pop-ups** or **Allow pop-ups**.

To view the shortcut key map, select **Options** > **Keypad shortcuts**. To edit the shortcut keys, select **Edit**.

 **Tip:** To minimise the browser without exiting the application or connection, press the end key once.

### Browser toolbar

The browser toolbar helps you select frequently used functions of the browser.

To open the toolbar, press and hold the scroll key on an empty spot on a web page. To move within the toolbar, scroll left or right. To select a feature, press the scroll key.

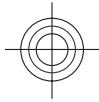

In the toolbar, select from the following:

- **Frequently used links** — View a list of the web addresses you visit frequently.
- **Page overview** — See an overview of the current web page.
- **Find** — Search for keywords within the current page.
- **Reload** — Refresh the page.
- **Subscribe to web feeds** (if available) — View a list of available web feeds on the current web page, and subscribe to a web feed.

### Navigate pages

Mini Map and Page overview help you navigate web pages that contain a large amount of information.

To activate Mini Map, select **Options > Settings > General > Mini map > On**. When you scroll through a large web page, Mini Map opens and shows an overview of the page.

To move in Mini Map, scroll left, right, up, or down. When you find the desired location, stop scrolling. Mini Map disappears and leaves you at the selected location.

When you are browsing a web page that contains a large amount of information, you can also use Page overview to view what kind of information the web page contains.

To see an overview of the current web page, press **8**. To find the desired spot on the web page, scroll up, down, left, or right. Press **8** again to zoom in and view the desired section of the web page.

### Content search

To search for text, phone numbers, or e-mail addresses within the current web page, select **Options > Text** and the desired option. To go to the previous match, scroll up. To go to the next match, scroll down.



**Tip:** To search for text within the current web page, press **2**.

### Download and purchase items

You can download items such as ringing tones, images, operator logos, themes, and video clips. These items can be provided free of charge, or you can purchase them. Downloaded items are handled by the respective applications in your device, for example, a downloaded photo can be saved in Gallery.



**Important:** Only install and use applications and other software from trusted sources, such as applications that are Symbian Signed or have passed the Java Verified™ testing.

To download an item:

1. Select the link.
2. Select the appropriate option to purchase the item (for example, **Buy**).
3. Carefully read all the information provided.
4. To continue or cancel the download, select the appropriate option (for example, **Accept** or **Cancel**).



## Internet

When you start a download, a list of ongoing and completed downloads from the current browsing session is displayed.

To modify the list, select **Options** > **Downloads**. In the list, select an item and **Options** to cancel ongoing downloads, or open, save, or delete completed downloads.

## Bookmarks

Select  > **Internet** > **Web**.

The bookmarks view opens when you open the browser. You can select web addresses from a list or from a collection of bookmarks in the recently visited pages/Recently visited pages folder.

If you start to enter a web address, the  field opens automatically.

 indicates the starting page defined for the default access point.

Select **Options** and from the following:

- **Go to** — Enter a new web address, go to the previous web page, or view saved links to web feeds and blogs.
- **Bookmark options** — Send and add bookmarks, or set bookmarks as the homepage.
- **Bookmark manager** — Edit, move, or delete bookmarks.

## Empty the cache

The information or services you have accessed are stored in the cache memory of the device.

A cache is a memory location that is used to store data temporarily. If you have tried to access or have accessed

confidential information requiring passwords, empty the cache after each use.

To empty the cache, select **Options** > **Clear privacy data** > **Cache**.

## End the connection

To end the connection and view the browser page offline, select **Options** > **Tools** > **Disconnect**.

To end the connection and close the browser, select **Options** > **Exit**.

To minimise the browser without ending the connection, press the end key once. To end the connection, press and hold the end key.

To delete the information the network server collects about your visits to various web pages, select **Options** > **Clear privacy data** > **Cookies**.

## Connection security

If the security indicator () is displayed during a connection, the data transmission between the device and the internet gateway or server is encrypted.

The security icon does not indicate that the data transmission between the gateway and the content server (where the data is stored) is secure. The service provider secures the data transmission between the gateway and the content server.

Security certificates may be required for some services, such as banking services. You are notified if the identity of the server is not authentic or if you do not have the correct

security certificate in your device. For more information, contact your service provider.

 **Important:** Even if the use of certificates makes the risks involved in remote connections and software installation considerably smaller, they must be used correctly in order to benefit from increased security. The existence of a certificate does not offer any protection by itself; the certificate manager must contain correct, authentic, or trusted certificates for increased security to be available. Certificates have a restricted lifetime. If "Expired certificate" or "Certificate not valid yet" is shown, even if the certificate should be valid, check that the current date and time in your device are correct.

Before changing any certificate settings, you must make sure that you really trust the owner of the certificate and that the certificate really belongs to the listed owner.

### Web settings

Select  > **Internet** > **Web and Options** > **Settings** and from the following:

#### General settings

- **Access point** — Change the default access point. Some or all access points may be preset for your device by your service provider. You may not be able to change, create, edit, or remove them.
- **Homepage** — Define the homepage.
- **Mini map** — Turn Mini Map on or off. Mini Map helps with web page navigation.

### Internet

- **History list** — If you select **On**, while browsing, to see a list of the pages you have visited during the current session, select **Back**.
- **Security warnings** — Hide or show security notifications.
- **Java/ECMA script** — Enable or disable the use of scripts.
- **Java/ECMA script errors** — Select whether you want to receive script notifications.
- **Open while downloading** — Select whether you want to be able to open a file while it is being downloaded.

#### Page settings

- **Load content** — Select whether you want to load images and other objects while browsing. If you select **Text only**, to load images or objects later during browsing, select **Options** > **Tools** > **Load images**.
- **Default encoding** — If text characters are not shown correctly, you can select another encoding according to the language for the current page.
- **Block pop-ups** — Allow or block automatic opening of different pop-ups while browsing.
- **Automatic reload** — Select whether you want the web pages to be refreshed automatically while browsing.
- **Font size** — Define the font size that is used for web pages.

#### Privacy settings

- **Recently visited pages** — Enable or disable automatic bookmark collecting. If you want to continue saving the addresses of the visited web pages into the **Recently visited pages** folder, but hide the folder from the bookmarks view, select **Hide folder**.

## Internet

- **Form data saving** — Select whether you want the password data or data you enter on different forms on a web page to be saved and used the next time you open the page.
- **Cookies** — Enable or disable the receiving and sending of cookies.

## Web feed settings

- **Acc. point for auto-update** — Select the desired access point for updating. This option is only available when **Automatic updates** is active.
- **Update when roaming** — Select whether you want the web feeds to be updated automatically when roaming.

## Share online

### About Share online

Select  > **Internet** > **Share online**.

With Share online, you can post images, video clips, and sound clips from your device to compatible online sharing services, such as albums and blogs. You can also view and send comments to the posts in these services, and download content to your compatible Nokia device.

The supported content types and the availability of the Share online service may vary.

### Subscribe to services

Select  > **Internet** > **Share online**.

To subscribe to an online sharing service, go to the service provider's website, and check that your Nokia device is

compatible with the service. Create an account as instructed on the website. You receive a user name and password needed to set up your device with the account.

1. To activate a service, open the Share online application in your device, select a service and **Options** > **Activate**.
2. Allow the device to create a network connection. If you are prompted for an internet access point, select one from the list.
3. Sign in to your account as instructed on the service provider's website.

Nokia's services in the online sharing service are free of charge. Any data transferred over the network may incur charges from your service provider. For the availability and cost of the third party services and data transfer costs, contact your service provider or the relevant third party.

### Create a post

Select  > **Internet** > **Share online**.

To post media files to a service, select a service and **Options** > **New upload**. If the online sharing service provides channels for posting files, select the desired channel.

To add an image, video clip, or sound clip to the post, select **Options** > **Insert**.

Enter a title or description for the post, if available.

To add tags to the post, select **Tags**.



To enable the posting of location information contained in the file, select **Location**:

To set the level of privacy for a file, select **Privacy**: To allow everyone to view your file, select **Public**. To restrict others from seeing your files, select **Private**. You can define the **Default** setting on the service provider's website.

To send the post to the service, select **Options** > **Upload**.

## Nokia Video Centre

With Nokia Video Centre (network service), you can download and stream video clips over the air from compatible internet video services using a packet data or wireless LAN (WLAN) connection. You can transfer video clips from a compatible PC to your device and view them in Video centre.

Using packet data access points to download videos may involve the transmission of large amounts of data through your service provider's network. Contact your service provider for information about data transmission charges.

Your device may have predefined services.

Service providers may provide free content or charge a fee. Check the pricing in the service or from the service provider.

### View and download video clips Connect to video services

1. Select  > **Internet** > **Video centre**.

2. To connect to a service to install video services, select **Video directory** and the desired video service from the service catalogue.

### View a video clip

To browse the content of installed video services, select **Video feeds**.

The content of some video services is divided into categories. To browse video clips, select a category.

To search for a video clip in the service, select **Video search**. Search may not be available in all services.

Some video clips can be streamed over the air, but others must be first downloaded to your device. To download a video clip, select **Options** > **Download**. Downloads continue in the background if you exit the application. The downloaded video clips are saved in My videos.

To stream a video clip or view a downloaded one, select **Options** > **Play**. To adjust the volume, use the volume key.

 **Warning:** Continuous exposure to high volume may damage your hearing. Listen to music at a moderate level, and do not hold the device near your ear when the loudspeaker is in use.

Select **Options** and from the following:

- **Resume download** — Resume a paused or failed download.
- **Cancel download** — Cancel a download.
- **Preview** — Preview a video clip.
- **Feed details** — View information about a video clip.

## Internet

### Personalisation

- **Refresh list** — Refresh the list of video clips.
- **Open link in browser** — Open a link in the web browser.

### Schedule downloads

Setting the application to download video clips automatically may involve the transmission of large amounts of data through your service provider's network. For information about data transmission charges, contact your service provider. To schedule an automatic download for video clips in a service, select **Options > Schedule downloads**. Video centre automatically downloads new video clips daily at the time you define.

To cancel scheduled downloads, select **Manual download** as the download method.

## Search

### Start a search

Select **⌘ > Internet > Search**.

To search the contents of your mobile device, enter search terms in the search field, or browse the content categories. While you enter the search terms, the results are organised into categories. The most recently accessed results appear at the top of the result list, if they match your search terms.

To search for web pages on the internet, select **Search the Internet**, a search provider, and enter your search terms in the search field. The search provider you selected is set as your default internet search provider.

If a default search provider is already set, select it to start a search, or select **More search services** to use another search provider.

To change the default service provider, select **Options > Select service**.

To change the country or region setting to find more search providers, select **Options > Settings > Country or region**.

## Nokia Music Store

Select **⌘ > Applications > Music store**.

In the Nokia Music Store (network service) you can search, browse, and purchase music to download to your device. To purchase music, you first need to register for the service.

To access the Nokia Music Store, you must have a valid internet access point in the device.

Nokia Music Store is not available for all countries or regions.

### Nokia Music Store settings

The availability and appearance of the Nokia Music Store settings may vary. The settings may also be predefined and not editable. You may be asked to select the access point to use when connecting to the Nokia Music Store. Select **Default access point**.

In the Nokia Music Store, you may be able to edit the settings by selecting **Options > Settings**.

## 13. Personalisation

### Change the display theme

Select  > **Settings** > **Themes**.

To change the theme used in all applications, select **General**.

To change the theme used in the main menu, select **Menu view**.

To change the theme for a particular application, select the application-specific folder.

To change the background image of the home screen, select **Wallpaper**.

To select an animation for the screen saver, select **Power saver**.

To turn theme effects on or off, select **General** > **Options** > **Theme effects**.

### Profiles

Select  > **Settings** > **Profiles**.

You can adjust and customise the ringing tones, alert tones, and other device tones for different events, environments, or caller groups. The active profile is shown at the top of the display in the home screen. However, if the active profile is General, only today's date is shown.

To create a new profile, select **Options** > **Create new**, and define the settings.

To customise a profile, select a profile and **Options** > **Personalise**.

To change a profile, select a profile and **Options** > **Activate**. The Offline profile prevents your device from accidentally switching on, sending or receiving messages, or using wireless LAN, Bluetooth connectivity, GPS, or FM radio; it also closes any internet connection that may be in operation when the profile is selected. The Offline profile does not prevent you from establishing a wireless LAN or Bluetooth connection at a later time, or from restarting the GPS or FM radio, so comply with any applicable safety requirements when establishing and using these features.

To set the profile to be active until a certain time within the next 24 hours, scroll to the profile, select **Options** > **Timed**, and set the time. When the time expires, the profile changes back to the previously active non-timed profile. When the profile is timed,  is displayed in the home screen. The Offline profile cannot be timed.

To delete a profile that you created, select **Options** > **Delete profile**. You cannot delete the predefined profiles.

### Sensor settings

Mute calls or snooze alarms by turning the phone.



### Time management

Select  > **Settings** > **Settings and General** > **Sensor settings**.

Select from the following:

- **Sensors** — Activate the sensors.
- **Turning control** — Mute calls or snooze alarms by turning your device.

## 14. Time management

### Alarm clock

Select  > **Applications** > **Clock**.

To view your active and inactive alarms, open the alarms tab. To set a new alarm, select **Options** > **New alarm**. Define the repetition, if needed. When an alarm is active,  is displayed.

To turn off the sounding alarm, select **Stop**. To stop the alarm for a certain time period, select **Snooze**. If your device is switched off when an alarm is due, your device switches itself on and starts sounding the alarm tone.

 **Tip:** To define the time period after which the alarm sounds again when you set it to snooze, select **Options** > **Settings** > **Alarm snooze time**.

To cancel an alarm, select **Options** > **Remove alarm**.

To change the time, date, and clock type settings, select **Options** > **Settings**.

### Clock settings

Select **Options** > **Settings**.

To change the time or date, select **Time** or **Date**.

To change the clock shown on the home screen, select **Clock type** > **Analogue** or **Digital**.

To allow the mobile phone network to update the time, date, and time zone information to your device (network service), select **Automatic time update** > **On**.

To change the alarm tone, select **Clock alarm tone**.



## 15. Office applications

### Dictionary

Select  > **Organiser** > **Dictionary**.

To translate words from one language to another, enter text in the search field. As you enter text, suggestions of words to

translate are displayed. To translate a word, select the word from the list.

Select **Options** and from the following:

- **Listen** — Listen to the selected word.



- **History** — Find previously translated words from the current session.
- **Languages** — Change the source or target language.
- **Languages** — Download languages from the internet or remove a language from the dictionary. You cannot remove the English language from the dictionary. You can have two additional languages installed, besides English.
- **Speech** — Edit the voice feature settings. You can adjust the speed and volume of the voice.

## Converter

With Converter, you can convert measures from one unit to another.

The converter has limited accuracy, and rounding errors may occur.

### Currency converter

Select **⌘** > **Organiser** > **Converter**.

Select **Type** > **Currency**. Before you can make currency conversions, you must select a base currency and add exchange rates. The default base currency is Home. The rate of the base currency is always 1.

1. Select **Options** > **Currency rates**.
2. The default name for the currency items is Foreign. To rename a currency, select **Options** > **Rename currency**.
3. Add the exchange rates for the currencies, and select **Done**.

### Office applications

4. In the other Unit field, select the currency to which you want to convert.
5. In the first Amount field, enter the value you want to convert. The other Amount field shows the converted value automatically.

To change the base currency, select **Options** > **Currency rates**, a currency and **Options** > **Set as base currency**.

When you change base currency, you must enter new exchange rates because all previously set exchange rates are cleared.

### Convert measures

Select **⌘** > **Organiser** > **Converter**.

1. In the Type field, select the measure you want to use.
2. In the first Unit field, select the unit from which you want to convert.
3. In the other Unit field, select the unit to which you want to convert.
4. In the first Amount field, enter the value you want to convert.

The other Amount field shows the converted value automatically.

### Active notes

Active notes allows you to create notes that contain images and sound or video clips. You can also link a note to a contact. The note is displayed during a call with the contact.

## Settings

### Create and edit notes

Select  > **Organiser** > **Active notes**.

To create a note, start writing.

To edit a note, select the note and **Options** > **Editing options**.

To add boldface, italics, or underlining to your text or change the font colour, press and hold #, and scroll to select the text. Then select **Options** > **Text**.

Select **Options** and from the following:

- **Insert object** — Insert images, sound or video clips, business cards, web bookmarks, and files.
- **Insert new** — Add new items to the note. You can record sound and video clips, and capture images.
- **Send** — Send the note.
- **Link note to call** — Select **Add contacts** to link a note to a contact. The note is displayed when making a call to or receiving a call from the contact.

## 16. Settings

### Settings wizard

Select  > **Settings** > **Sett. wizard**.

The Settings wizard application configures your device for operator and e-mail settings based on your service provider. Configuring other settings may also be possible.

To use these services, you may have to contact your service provider to activate a data connection or other services.

### Settings for Active notes

Select  > **Organiser** > **Active notes** and **Options** > **Settings**.

To select where to save notes, select **Memory in use** and the desired memory.

To change the layout of active notes, or to view the notes as a list, select **Change view** > **Grid** or **List**.

To see a note in the background when making or receiving phone calls, select **Show note during call** > **Yes**.

 **Tip:** If you temporarily do not want to see notes during phone calls, select **Show note during call** > **No**. This way you do not have to remove the links between notes and contact cards.

### Common accessory settings

Select  > **Settings** > **Settings** and **General** > **Enhancement**.

With most accessories, you can do the following:

To define which profile is activated when you attach an accessory to your device, select the accessory and **Default profile**.

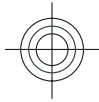

## Data management

To set the device to answer phone calls automatically after 5 seconds when an accessory is attached, select **Automatic answer** > **On**. If the ringing type is set to **Beep once** or **Silent** in the selected profile, automatic answering is disabled.

To illuminate the device while it is attached to an accessory, select **Lights** > **On**.

## 17. Data management

### Install applications

Select  > **Applications** > **App. mgr.**

You can transfer installation files to your device from a compatible computer, download them during browsing, or receive them in a multimedia message, as an e-mail attachment, or using other connectivity methods, such as Bluetooth connectivity. You can use Nokia Application Installer in Nokia Ovi Suite to install an application to your device.

Icons in Application manager indicate the following:

 SIS or SISX application

 Java™ application

 widgets

 **Important:** Only install and use applications and other software from trusted sources, such as applications

### Restore original settings

To restore the original device settings, select  > **Settings** > **Settings and General** > **Factory settings**. To do this, you need your device lock code. After resetting, the device may take a longer time to switch on. Documents, contact information, calendar entries, and files are unaffected.

that are Symbian Signed or have passed the Java Verified testing.

Before installation, note the following:

- To view the application type, version number, and the supplier or manufacturer of the application, select **Options** > **View details**.  
To display the security certificate details of the application, in **Details**;, scroll to **Certificates**;, and select **View details**.
- If you install a file that contains an update or repair to an existing application, you can only restore the original application if you have the original installation file or a full backup copy of the removed software package. To restore the original application, remove the application, and install the application again from the original installation file or the backup copy.

The JAR file is required for installing Java applications. If it is missing, the device may ask you to download it. If there is no access point defined for the application, you are asked to select one. When you are downloading the JAR



## Data management

file, you may need to enter a user name and password to access the server. You obtain these from the supplier or manufacturer of the application.

To install an application or software:

1. To locate an installation file, select **☰** > **Applications** > **App. mgr.**. Alternatively, search for installation files using File manager, or open a message in **Messaging** > **Inbox** that contains an installation file.
2. In Application manager, select **Options** > **Install**. In other applications, to start the installation, select the installation file.

During installation, the device shows information about the progress of the installation. If you install an application without a digital signature or certification, the device displays a warning. Continue installation only if you are sure of the origin and contents of the application.

To start an installed application, locate the application in the menu, and select the application.

To see which software packages are installed or removed and when, select **Options** > **View log**.

 **Important:** Your device can only support one antivirus application. Having more than one application with antivirus functionality could affect performance and operation or cause the device to stop functioning.

After you install applications to a compatible memory card, installation files (.sis, .sisx) remain in the device memory. The files may use large amounts of memory and prevent you from

storing other files. To maintain sufficient memory, use Nokia Ovi Suite to back up installation files to a compatible PC, then use the file manager to remove the installation files from the device memory. If the .sis file is a message attachment, delete the message from the Messaging inbox.

## Device manager

### Remote configuration

Select **☰** > **Settings** > **Device manager**.

With Device manager, you can manage settings, data, and software on your device remotely.

You can connect to a server, and receive configuration settings for your device. You may receive server profiles and different configuration settings from your service providers or company information management department. Configuration settings may include connection and other settings used by different applications in your device. The available options may vary.

The remote configuration connection is usually started by the server when the device settings need to be updated.

To create a new server profile, select **Options** > **Server profiles** > **Options** > **New server profile**.

You may receive these settings from your service provider in a configuration message. If not, define the following:

- **Server name** — Enter a name for the configuration server.
- **Server ID** — Enter the unique ID to identify the configuration server.



- **Server password** — Enter a password to identify your device to the server.
- **Access point** — Select the access point to use for the connection, or create a new access point. You can also choose to be asked for the access point every time you start a connection. This setting is available only if you have selected **Internet** as the bearer type.
- **Host address** — Enter the web address of the configuration server.
- **Port** — Enter the port number of the server.
- **User name and Password** — Enter your user ID and password for the configuration server.
- **Allow configuration** — Select **Yes** to allow the server to initiate a configuration session.
- **Auto-accept all requests** — Select **Yes** if you do not want the server to ask for your confirmation when it initiates a configuration session.
- **Network authentication** — Select whether to use http authentication.
- **Network user name and Network password** — Enter your user ID and password for the http authentication. This setting is available only if you have selected **Network authentication** to be used.

To connect to the server and receive configuration settings for your device, select **Options** > **Start configuration**.

To view the configuration log of the selected profile, select **Options** > **View log**.

To update the device software over the air, select **Options** > **Check for updates**. The update does not erase your settings. When you receive the update package on your device, follow

#### Data management

the instructions on the display. Your device is restarted once the installation is complete. Downloading software updates may involve the transmission of large amounts of data (network service). Make sure that the device battery has enough power, or connect the charger before starting the update.

 **Warning:** If you install a software update, you cannot use the device, even to make emergency calls, until the installation is completed and the device is restarted. Be sure to back up data before accepting installation of an update.

## Licenses

### About Licenses

Select  > **Applications** > **Licences**.

Some media files, such as images, music, or video clips, are protected by digital usage rights. The licenses for such files may allow or restrict their usage. For example, with some licenses you may listen to a song only a limited number of times. During one playback session you may rewind, fast-forward, or pause the song, but once you stop it, you have used one of the instances allowed.

### Use licenses

Digital rights management (DRM) protected content comes with an associated activation key that defines your rights to use the content.

### Connectivity

If your device has OMA DRM-protected content, to back up both the activation keys and the content, use the backup feature of Nokia Ovi Suite.

If your device has WMDRM-protected content, both the activation keys and the content will be lost if the device memory is formatted. You may also lose the activation keys and the content if the files on your device get corrupted. Losing the activation keys or the content may limit your ability to use the same content on your device again. For more information, contact your service provider.

Some activation keys may be connected to a specific SIM card, and the protected content can be accessed only if the SIM card is inserted in the device.

To view your licenses by type, select **Valid licences**, **Invalid licences**, or **Not in use**.

To view the key details, select **Options** > **Licence details**.

The following details are displayed for each media file:

- **Status** — The status is **Licence is valid**, **Licence expired**, or **Licence not yet valid**.

## 18. Connectivity

### Transfer content from another device

Select  > **Settings** > **Switch**.

With the Switch application, you can transfer content, such as contacts, between two compatible Nokia devices.

- **Content sending** — **Allowed** means that you can send the file to another device. **Not allowed** means that you cannot send the file to another device.
- **Content in phone** — **Yes** means that the file is in the device and the path of the file is displayed. **No** means that the related file is not currently in the device.

To activate a key, in the licenses main view, select **Invalid licences** > **Options** > **Get licence**. Establish a network connection at the prompt, and you are directed to a website where you can purchase rights to the media.

To remove file rights, open the valid keys tab or the keys not in use tab, scroll to the desired file, and select **Options** > **Delete**. If there are several rights related to the same media file, all the rights are deleted.

The group key view displays all of the files related to a group right. If you have downloaded multiple media files with the same rights, they are all displayed in this view. You can open the group view from either the valid keys or invalid keys tabs. To access these files, open the group rights folder.

The type of content that can be transferred depends on the model of the device from which you want to transfer content. If the other device supports synchronisation, you can also synchronise data between the other device and your device. Your device notifies you if the other device is not compatible. If the other device cannot be switched on without a SIM card, you can insert your SIM card in it. When your device is

switched on without a SIM card, the offline profile is automatically activated.

The other device must support Bluetooth connectivity.

### Transfer content

To retrieve data from your other device for the first time:

1. Activate Bluetooth connectivity in both devices.
2. Select the device from which you want to transfer content. You are asked to enter a code on your device. Enter a code (1-16 digits), and select **OK**. Enter the same code on the other device, and select **OK**. The devices are now paired.

For some device models, the Switch application is sent to the other device as a message. To install the Switch application on the other device, open the message, and follow the instructions.

3. From your device, select the content you want to transfer from the other device.

Content is transferred from the memory of the other device to the corresponding location in your device.

Transfer time depends on the amount of data to be transferred. You can cancel the transfer and continue later.

The synchronisation is two-way, and the data in both devices is the same. If an item is deleted from either device, it is deleted from the other device when synchronising; you cannot restore deleted items by synchronising.

To view the log of the last transfer, select a shortcut in the main view and **Options** > **View log**.

## PC connections

You can use your mobile device with a variety of compatible PC connectivity and data communications applications. With Nokia Ovi Suite, you can, for example, transfer files and images between your device and a compatible computer.

For more information about Ovi Suite and the download link, see [www.ovi.com](http://www.ovi.com).

## Bluetooth

### About Bluetooth

Bluetooth technology enables wireless connections between electronic devices within a range of 10 metres (33 feet). A Bluetooth connection can be used to send images, videos, text, business cards, calendar notes, or to connect wirelessly to devices that use Bluetooth technology.

Since devices using Bluetooth technology communicate using radio waves, your device and the other devices do not need to be in direct line-of-sight. The two devices only need to be within a maximum of 10 metres of each other, although the connection can be subject to interference from obstructions such as walls or other electronic devices.

Several Bluetooth connections can be active at a time. For example, if your device is connected to a headset, you can also transfer files to another compatible device at the same time.

This device is compliant with Bluetooth Specification 2.0 + EDR supporting the following profiles: Advanced Audio Distribution, Audio/Video Remote Control, Basic Imaging,

## Connectivity

Basic Printing, Device ID, Dial-up Networking, File Transfer, Generic Audio/Video Distribution, Generic Access, Generic Object Exchange, Handsfree, (Human Interface Device) Headset, Object Push, Phone Book Access, Serial Port, and SIM Access. To ensure interoperability between other devices supporting Bluetooth technology, use Nokia approved accessories for this model. Check with the manufacturers of other devices to determine their compatibility with this device.

Features using Bluetooth technology increase the demand on battery power and reduce the battery life.

## Security tips

Operating the device in hidden mode is a safer way to avoid malicious software. Do not accept Bluetooth connectivity from sources you do not trust. Alternatively, switch off the Bluetooth function. This does not affect other functions of the device.

Select  > **Settings** > **Connectivity** > **Bluetooth**.

When you are not using Bluetooth connectivity, select **Bluetooth** > **Off** or **My phone's visibility** > **Hidden**.

Do not pair with an unknown device.

## Pair devices

Select  > **Settings** > **Connectivity** > **Bluetooth**.

Open the paired devices tab.

Before pairing, decide on your own passcode (1-16 digits), and agree with the user of the other device to use the same code. Devices that do not have a user interface have a fixed

passcode. You need the passcode only when you connect the devices for the first time. After pairing, it is possible to authorise the connection. Pairing and authorising the connection makes connecting quicker and easier, as you do not have to accept the connection between paired devices every time you establish a connection.

The passcode for remote SIM access must have 16 digits.

1. Select **Options** > **New paired device**. The device starts to search for Bluetooth devices within range. If you have sent data using Bluetooth connectivity before, a list of the previous search results is displayed. To search for more Bluetooth devices, select **More devices**.
2. Select the device with which you want to pair, and enter the passcode. The same passcode must be entered to the other device as well.
3. Select **Yes** to make the connection between your device and the other device automatic, or **No** to confirm the connection manually every time a connection attempt is made. After pairing, the device is saved to the paired devices page.

To give a nickname to the paired device, select **Options** > **Assign short name**. The nickname is only displayed in your device.

To delete a pairing, select the device whose pairing you want to delete and **Options** > **Delete**. To delete all pairings, select **Options** > **Delete all**. If you are currently connected to a device and cancel the pairing with that device, pairing is removed immediately, and the connection is ended.

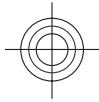

## Connectivity

To allow a paired device to connect automatically to your device, select **Set as authorised**. Connections between your device and the other device can be made without your knowledge. No separate acceptance or authorisation is needed. Use this status for your own devices, such as your compatible headset or computer, or devices that belong to someone you trust. If you want to accept connection requests from the other device separately every time, select **Set as unauthorised**.

To use a Bluetooth audio accessory such as a Bluetooth handsfree or headset, you need to pair your device with the accessory. For the passcode and further instructions, see the accessory user guide. To connect to the audio accessory, switch on the accessory. Some audio accessories connect automatically to your device. Otherwise, open the paired devices tab, select the accessory and **Options > Connect to audio device**.

### Send and receive data with Bluetooth

Select  > **Settings > Connectivity > Bluetooth**.

1. When you activate Bluetooth connectivity for the first time, you are asked to name your device. Give your device a unique name to make it easy to recognise if there are several Bluetooth devices nearby.
2. Select **Bluetooth > On**.
3. Select **My phone's visibility > Shown to all** or **Define period**. If you select **Define period**, you need to define the time during which your device is visible to others. Your device and the name you entered can now be seen by other users with devices using Bluetooth technology.

4. Open the application where the item you want to send is stored.
5. Select the item and **Options > Send > Via Bluetooth**. The device searches for other devices using Bluetooth technology within range and lists them.



**Tip:** If you have sent data using Bluetooth connectivity before, a list of the previous search results is displayed. To search for more Bluetooth devices, select **More devices**.

6. Select the device with which you want to connect. If the other device requires pairing before data can be transmitted, you are asked to enter a passcode.

When the connection has been established, **Sending data** is displayed.

The Sent folder in the Messaging application does not store messages sent using Bluetooth connectivity.

To receive data using Bluetooth connectivity, select **Bluetooth > On** and **My phone's visibility > Shown to all** to receive data from a non-paired device or **Hidden** to receive data from a paired device only. When you receive data through Bluetooth connectivity, depending on the settings of an active profile, a tone sounds, and you are asked if you want to accept the message in which the data is included. If you accept, the message is placed in the Inbox folder in the Messaging application.



**Tip:** You can access the files in the device or on the memory card using a compatible accessory that supports the File Transfer Profile Client service (for example, a laptop computer).



### Connectivity

A Bluetooth connection is disconnected automatically after sending or receiving data. Only Nokia Ovi Suite and some accessories such as headsets may maintain a connection even if not actively used.

### Data cable

To avoid damaging the memory card or corrupting data, do not disconnect the USB data cable during a data transfer.

#### Transfer data between your device and a PC

1. Insert a memory card in your device, and connect the device to a compatible PC with the USB data cable.
2. When the device asks which mode to use, select **Mass storage**. In this mode, you can see your device as a removable hard drive in your computer.
3. Transfer data between the computer and your device.
4. End the connection from the computer (for example, from an Unplug or Eject Hardware wizard in Windows) to avoid damaging the memory card.

To transfer images from the device to a compatible PC, or to print the images stored in the device on a compatible printer, connect the USB data cable to the PC or printer, and select **Image transfer**.

To modify the USB mode settings, select **Settings > Connectivity > USB**.

To change the USB mode you normally use with the USB data cable, select **USB connection mode**.

To set the device to ask which mode to use each time you connect the USB data cable to the device, select **Ask on connection > Yes**.

To use Nokia Ovi Suite with your device, install Nokia Ovi Suite on your PC, connect the USB data cable, and select **PC Suite**.

### Sync

Select **Settings > Connectivity > Sync**.

Sync enables you to synchronise your notes, calendar entries, text and multimedia messages, browser bookmarks, or contacts with various compatible applications on a compatible computer or on the internet.

You may receive synchronisation settings in a special message from your service provider.

A synchronisation profile contains the necessary settings for synchronisation.

When you open the Sync application, the default or previously used sync profile is displayed. To modify the profile, scroll to a sync item, and select **Mark** to include it in the profile or **Unmark** to leave it out.

To manage sync profiles, select **Options** and the desired option.

To synchronise data, select **Options > Synchronise**. To cancel synchronisation before it finishes, select **Cancel**.

## WLAN wizard

 **Note:** In France, you are only allowed to use WLAN indoors.

Features using wireless LAN increase the demand on battery power and reduce the battery life.

Select  > **Settings** > **Connectivity** > **WLAN wiz.**

The WLAN wizard helps you find and connect to a wireless LAN (WLAN). When you open the application, your device starts to scan for available WLANs and lists them.

Select **Options** and from the following:

- **Refresh** — Update the list of available WLANs.
- **Filter WLAN networks** — Filter out WLANs in the list of found networks. The selected networks are filtered out the next time the application searches for WLANs.
- **Start web browsing** — Start browsing the web using the access point of the WLAN.
- **Cont.web browsing** — Continue web browsing using the currently active WLAN connection.
- **Disconnect WLAN** — Disconnect the active connection to the WLAN.
- **Details** — View the details of the WLAN.

 **Important:** Always enable one of the available encryption methods to increase the security of your wireless LAN connection. Using encryption reduces the risk of unauthorised access to your data.

## Connectivity

To set the WLAN wizard to automatically create an access point for the selected WLAN when you select **Start web browsing** or **Use for**, select  > **Settings** > **Settings**, and **Connection** > **Wireless LAN** > **Internet connectivity test** > **Run automatically**. The access point can also be used with other applications requiring a WLAN connection.

If you select a secured WLAN, you are asked to enter the relevant passcodes. To connect to a hidden network, you must enter the correct service set identifier (SSID).

## Accessories

 **Warning:** Use only batteries, chargers, and accessories approved by Nokia for use with this particular model. The use of any other types may invalidate any approval or warranty, and may be dangerous. In particular, use of unapproved chargers or batteries may present a risk of fire, explosion, leakage, or other hazard.

For availability of approved accessories, please check with your dealer. When you disconnect the power cord of any accessory, grasp and pull the plug, not the cord.

### Nokia Holder Easy Mount HH-20 and CR-111

The Nokia Holder Easy Mount HH-20 is a mounting device that allows you to attach the Nokia CR-111 mobile holder to the windscreen of your vehicle.

Read these instructions carefully before installing and using the product.

This product may contain small parts. Keep them out of the reach of small children.

### General safety instructions

Only operate the mounting device or mobile holder if it is safe to do so under all driving conditions. When you install the mounting device or mobile holder, ensure that they do not interfere with or hinder the steering or braking systems or other systems used in the operation of the vehicle (for

example, airbags) or disturb your field of vision while driving. Check that the deployment of the airbag is not blocked or impaired in any way. Ensure that the mounting device or mobile holder is not installed where you might come in contact with it in the event of an accident or collision. Periodically check that the suction cup at the bottom of the mounting device is firmly attached to the windscreen, especially if the ambient temperature changes a lot. Never leave the mounting device inside the vehicle in direct sunlight or in excessive heat. The mounting device and suction cup may be damaged and adhesion may be impaired if the inside temperature exceeds +70°C (160°F).

### Attach the holder

To attach the mobile holder to the mounting device, insert the catch on the mounting device into the slot at the back of the holder. Rotate the holder clockwise about 90 degrees until it locks into place. When attaching a mobile holder, ensure that the display of the mobile device is clearly visible for the user. For your safety, install the holder in the upright position.

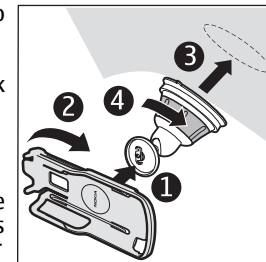



To detach the holder from the mounting device, rotate it anticlockwise.

### Attach the mounting device

Before you attach the mounting device to the windscreen, locate a safe mounting surface on the windscreen, and clean the surface thoroughly with a glass cleaner and a clean towel. If the ambient temperature is below +15°C (60°F), carefully warm the surface and the suction cup with a hair dryer to ensure a firm grip on the windscreen. Ensure that you do not heat the windscreen excessively to avoid damage to it.

Press the suction cup of the mounting device gently against the windscreen, and rotate the mounting device clockwise to create a vacuum between the suction cup and the windscreen. Check that the suction cup is firmly attached.

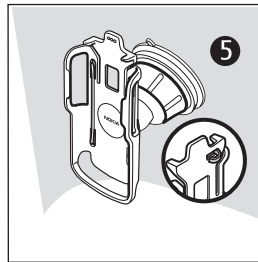

### Place or remove the device

Do not place or remove a mobile device while driving. To place your device into the holder, close the slide of the device, push the catch at the top of the holder, and slide the mobile device into the holder.

To charge the battery of your device, use a compatible charger. To attach the charger cable to the back of the holder, insert the cable through the slot into the cable support, and connect the charger plug to the charger connector at the top of the device.

To remove the device, close the slide of the device, push the catch, and slide the device out from the holder by pushing it from the bottom.

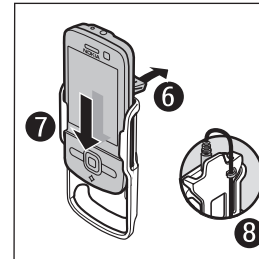

### Accessories

## Battery

To detach the suction cup from the windscreen, rotate the mounting device anticlockwise, pull the strap located on the edge of the suction cup, and pull the

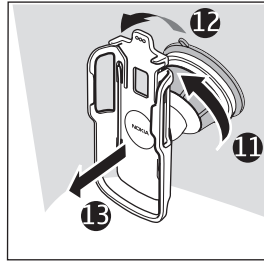

holder with the mounting device from the windscreen.

## Battery

### Battery and charger information

Your device is powered by a rechargeable battery. The battery intended for use with this device is BP-5M. Nokia may make additional battery models available for this device. This device is intended for use when supplied with power from the following chargers: AC-8. The exact charger model number may vary depending on the type of plug. The plug variant is identified by one of the following: E, EB, X, AR, U, A, C, K, or UB.

The battery can be charged and discharged hundreds of times, but it will eventually wear out. When the talk and standby times are noticeably shorter than normal, replace the battery. Use only Nokia approved batteries, and recharge your battery only with Nokia approved chargers designated for this device.

If a battery is being used for the first time or if the battery has not been used for a prolonged period, it may be necessary to connect the charger, then disconnect and reconnect it to begin charging the battery. If the battery is completely discharged, it may take several minutes before the charging indicator appears on the display or before any calls can be made.

**Safe removal.** Always switch the device off and disconnect the charger before removing the battery.

**Proper charging.** Unplug the charger from the electrical plug and the device when not in use. Do not leave a fully charged battery connected to a charger, since overcharging may shorten its lifetime. If left unused, a fully charged battery will lose its charge over time.

## Battery

Avoid extreme temperatures. Always try to keep the battery between 15°C and 25°C (59°F and 77°F). Extreme temperatures reduce the capacity and lifetime of the battery. A device with a hot or cold battery may not work temporarily. Battery performance is particularly limited in temperatures well below freezing.

Do not short-circuit. Accidental short-circuiting can occur when a metallic object such as a coin, clip, or pen causes direct connection of the positive (+) and negative (-) terminals of the battery. (These look like metal strips on the battery.) This might happen, for example, when you carry a spare battery in your pocket or purse. Short-circuiting the terminals may damage the battery or the connecting object.

Disposal. Do not dispose of batteries in a fire as they may explode. Dispose of batteries according to local regulations. Please recycle when possible. Do not dispose as household waste.

Leak. Do not dismantle, cut, open, crush, bend, puncture, or shred cells or batteries. In the event of a battery leak, prevent battery liquid contact with skin or eyes. If this happens, flush the affected areas immediately with water, or seek medical help.

Damage. Do not modify, remanufacture, attempt to insert foreign objects into the battery, or immerse or expose it to water or other liquids. Batteries may explode if damaged.

Correct use. Use the battery only for its intended purpose. Improper battery use may result in a fire, explosion, or other hazard. If the device or battery is dropped, especially on a hard surface, and you believe the battery has been damaged, take it to a service centre for inspection before continuing to

use it. Never use any charger or battery that is damaged. Keep your battery out of the reach of small children.

## Nokia battery authentication guidelines

Always use original Nokia batteries for your safety. To check that you are getting an original Nokia battery, purchase it from a Nokia authorised service centre or dealer, and inspect the hologram label using the following steps:

### Authenticate hologram

1. When you look at the hologram on the label, you should see the Nokia connecting hands symbol from one angle and the Nokia Original Enhancements logo when looking from another angle.
2. When you angle the hologram left, right, down and up, you should see 1, 2, 3 and 4 dots on each side respectively.

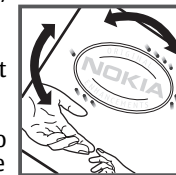
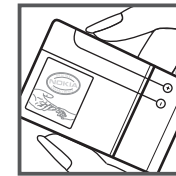

Successful completion of the steps is not a total assurance of the authenticity of the battery. If you cannot confirm authenticity or if you have any reason to believe that your Nokia battery with the hologram on the label is not an authentic Nokia battery, you should refrain from



### Taking care of your device

using it, and take it to the nearest Nokia authorised service centre or dealer for assistance.

To find out more about original Nokia batteries, see [www.nokia.com/battery](http://www.nokia.com/battery).

## Taking care of your device

Your device is a product of superior design and craftsmanship and should be treated with care. The following suggestions will help you protect your warranty coverage.

- Keep the device dry. Precipitation, humidity, and all types of liquids or moisture can contain minerals that will corrode electronic circuits. If your device does get wet, remove the battery, and allow the device to dry completely before replacing it.
- Do not use or store the device in dusty, dirty areas. Its moving parts and electronic components can be damaged.
- Do not store the device in high or cold temperature. High temperatures can shorten the life of electronic devices, damage batteries, and warp or melt certain plastics. When the device warms to its normal temperature from a cold temperature, moisture can form inside the device and damage electronic circuit boards.
- Do not attempt to open the device other than as instructed in this guide.
- Do not drop, knock, or shake the device. Rough handling can break internal circuit boards and fine mechanics.
- Do not use harsh chemicals, cleaning solvents, or strong detergents to clean the device. Only use a soft, clean, dry cloth to clean the surface of the device.

- Do not paint the device. Paint can clog the moving parts and prevent proper operation.
- Use only the supplied or an approved replacement antenna. Unauthorised antennas, modifications, or attachments could damage the device and may violate regulations governing radio devices.
- Use chargers indoors.
- Backup all data you want to keep, such as contacts and calendar notes.
- To reset the device from time to time for optimum performance, power off the device and remove the battery.

These suggestions apply equally to your device, battery, charger, or any accessory.

## Recycle

Always return your used electronic products, batteries, and packaging materials to dedicated collection points. This way you help prevent uncontrolled waste disposal and promote the recycling of materials. Check product environmental information and how to recycle your Nokia products at [www.nokia.com/werecycle](http://www.nokia.com/werecycle), or [nokia.mobi/werecycle](http://nokia.mobi/werecycle).





 The crossed-out wheeled-bin symbol on your product, battery, literature, or packaging reminds you that all electrical and electronic products, batteries, and accumulators must be taken to separate collection at the end of their working life. This requirement applies in the

## Additional safety information

The surface of this device is nickel-free.

### Small children

Your device and its accessories are not toys. They may contain small parts. Keep them out of the reach of small children.

### Operating environment

This device meets RF exposure guidelines in the normal use position at the ear or at least 2.2 centimetres (7/8 inch) away from the body. Any carry case, belt clip, or holder for body-worn operation should not contain metal and should position the device the above-stated distance from your body.

To send data files or messages requires a quality connection to the network. Data files or messages may be delayed until such a connection is available. Follow the separation distance instructions until the transmission is completed.

Parts of the device are magnetic. Metallic materials may be attracted to the device. Do not place credit cards or other magnetic storage media near the device, because information stored on them may be erased.

### Additional safety information

European Union. Do not dispose of these products as unsorted municipal waste. For more environmental information, see the product Eco-Declarations at [www.nokia.com/environment](http://www.nokia.com/environment).

### Medical devices

Operation of radio transmitting equipment, including wireless phones, may interfere with the function of inadequately protected medical devices. Consult a physician or the manufacturer of the medical device to determine whether they are adequately shielded from external RF energy. Switch off your device when regulations posted instruct you to do so. Hospitals or health care facilities may use equipment sensitive to external RF energy.

### Implanted medical devices

Manufacturers of medical devices recommend a minimum separation of 15.3 centimetres (6 inches) between a wireless device and an implanted medical device, such as a pacemaker or implanted cardioverter defibrillator, to avoid potential interference with the medical device. Persons who have such devices should:

- Always keep the wireless device more than 15.3 centimetres (6 inches) from the medical device.
- Not carry the wireless device in a breast pocket.





#### Additional safety information

- Hold the wireless device to the ear opposite the medical device.
- Turn the wireless device off if there is any reason to suspect that interference is taking place.
- Follow the manufacturer directions for the implanted medical device.

If you have any questions about using your wireless device with an implanted medical device, consult your health care provider.

#### Hearing aids

Some digital wireless devices may interfere with some hearing aids.

#### Vehicles

RF signals may affect improperly installed or inadequately shielded electronic systems in motor vehicles such as electronic fuel injection, electronic antilock braking, electronic speed control, and air bag systems. For more information, check with the manufacturer of your vehicle or its equipment.

Only qualified personnel should service the device or install the device in a vehicle. Faulty installation or service may be dangerous and may invalidate your warranty. Check regularly that all wireless device equipment in your vehicle is mounted and operating properly. Do not store or carry flammable liquids, gases, or explosive materials in the same compartment as the device, its parts, or accessories.

70

Remember that air bags inflate with great force. Do not place your device or accessories in the air bag deployment area.

Switch off your device before boarding an aircraft. The use of wireless teledevices in an aircraft may be dangerous to the operation of the aircraft and may be illegal.

#### Potentially explosive environments

Switch off your device in any area with a potentially explosive atmosphere. Obey all posted instructions. Sparks in such areas could cause an explosion or fire resulting in bodily injury or death. Switch off the device at refuelling points such as near gas pumps at service stations. Observe restrictions in fuel depots, storage, and distribution areas; chemical plants; or where blasting operations are in progress. Areas with a potentially explosive atmosphere are often, but not always, clearly marked. They include areas where you would be advised to turn off your vehicle engine, below deck on boats, chemical transfer or storage facilities and where the air contains chemicals or particles such as grain, dust, or metal powders. You should check with the manufacturers of vehicles using liquefied petroleum gas (such as propane or butane) to determine if this device can be safely used in their vicinity.

#### Emergency calls

 **Important:** This device operates using radio signals, wireless networks, landline networks, and user-programmed functions. If your device supports voice calls over the internet (internet calls), activate both the internet calls and the



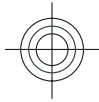

cellular phone. The device may attempt to make emergency calls over both the cellular networks and through your internet call provider if both are activated. Connections in all conditions cannot be guaranteed. You should never rely solely on any wireless device for essential communications like medical emergencies.

To make an emergency call:

1. If the device is not on, switch it on. Check for adequate signal strength. Depending on your device, you may also need to complete the following:
  - Insert a SIM card if your device uses one.
  - Remove certain call restrictions you have activated in your device.
  - Change your profile from Offline or Flight profile to an active profile.
2. Press the end key as many times as needed to clear the display and ready the device for calls.
3. Enter the official emergency number for your present location. Emergency numbers vary by location.
4. Press the call key.

When making an emergency call, give all the necessary information as accurately as possible. Your wireless device may be the only means of communication at the scene of an accident. Do not end the call until given permission to do so.

### **Certification information (SAR)**

**This mobile device meets guidelines for exposure to radio waves.**

### **Additional safety information**

Your mobile device is a radio transmitter and receiver. It is designed not to exceed the limits for exposure to radio waves recommended by international guidelines. These guidelines were developed by the independent scientific organisation ICNIRP and include safety margins designed to assure the protection of all persons, regardless of age and health.

The exposure guidelines for mobile devices employ a unit of measurement known as the Specific Absorption Rate or SAR. The SAR limit stated in the ICNIRP guidelines is 2.0 watts/kilogram (W/kg) averaged over 10 grams of tissue. Tests for SAR are conducted using standard operating positions with the device transmitting at its highest certified power level in all tested frequency bands. The actual SAR level of an operating device can be below the maximum value because the device is designed to use only the power required to reach the network. That amount changes depending on a number of factors such as how close you are to a network base station.

The highest SAR value under the ICNIRP guidelines for use of the device at the ear is 1.03 W/kg.

Use of device accessories may result in different SAR values. SAR values may vary depending on national reporting and testing requirements and the network band. Additional SAR information may be provided under product information at [www.nokia.com](http://www.nokia.com).

Your mobile device is also designed to meet the requirements for exposure to radio waves established by the Federal Communications Commission (USA) and Industry Canada. These requirements set a SAR limit of 1.6 W/kg averaged over one gram of tissue. The highest SAR value reported under this

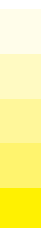



**Additional safety information**

standard during product certification for use at the ear is 1.28 W/kg and when properly worn on the body is 0.70 W/kg.





## Index

### A

- access codes 16
- accessories 64
  - settings 54
- activation keys 57
- active notes 53, 54
  - settings 54
- alarm clock 52
- animated screen saver 51
- antennas 11
- audio messages 34
- auto-update for time/date 52

### B

- background image 51
- barring password 16
- battery 10
  - charge level 14
  - inserting 9
- Bluetooth
  - authorising devices 60
  - pairing 60
  - passcode 60
  - receiving data 61
  - security 60
  - sending data 61
- bookmarks 46

### browser

- bookmarks 46
- browsing pages 44, 45
- cache memory 46
- downloads 45
- searching content 45
- security 46
- settings 47

### C

- cable 62
- cache memory 46
- call barring 22
- call divert 22
- caller ID 21
- calls
  - answering 20
  - call waiting 21
  - caller ID 21
  - conference call 20
  - making 19
  - muting the ringing tone 20
  - rejecting 20
  - rejecting with text message 21
  - selecting type 21
  - settings 21
  - speed dialling 19
  - voice mail 19

### camera

- capturing images 42
- location information 43
- toolbar 42
- video clips 43

### Clock

- settings 52

### compass 27

- computer connections 59
  - See also *data connections*

### conference calls 20

- configuration settings 11

### connection methods

- Bluetooth 61
- data cable 62

### contacts 40

- adding ringing tones 41
- contact groups 40
- location 40
- settings 41
- synchronising 62

### converter 53

- currency
  - converter 53

### D

### data connections

- PC connectivity 59
- synchronisation 62

## Index

**date and time** 52  
**device manager** 56  
**dictionary** 52  
**display**  
  changing the look 51  
  indicators 14  
**downloads** 45

**E**

**e-mail**  
  disconnecting 37  
  downloading attachments 37  
  general settings 37  
  reading 36  
  sending 36  
  set-up 36

**H**

**headphones** 17  
**headset** 17  
**help application** 18  
**home screen** 13

**I**

**indicators** 14  
**inserting**  
  battery 9  
  SIM card 9  
**installation of applications** 55  
**internet connection** 44  
  See also *browser*

## K

**keys and parts** 12

## L

**landmarks** 31  
**language**  
  changing 33  
**licenses** 57  
**log** 20

## M

**making a call** 19  
**maps** 26  
  browsing 28  
  compass 27  
  driving 29  
  finding locations 28  
  history 29  
  indicators 27  
  licences 27  
  Nokia Map Loader 31  
  Ovi synchronisation 31  
  routes 29  
  saving locations 28  
  sending locations 28  
  settings 31  
  traffic and safety 30  
  walking 30  
**memory**  
  web cache 46

**memory card** 9, 10

**menu** 16

**menu view** 16

**message reader** 35

**messages**

  call rejection messages 21  
  settings 38

**Mini Map** 45

**MMS (multimedia message service)** 34

**multimedia messages** 34

**music player**

  playing 24

## N

**network**

  settings 23

**Nokia Map Loader** 31

**Nokia Music Store** 50

## O

**operator**

  selecting 23

**original settings** 55

**Ovi Maps** 31

## P

**page overview** 45

**pairing**

  devices 60  
  passcode 60

**personalisation** 51  
**PIN** 16  
**playing**  
  messages 35  
**power saver** 15  
**predictive text input** 33  
**profiles**  
  creating 51  
  customising 51  
**PUK** 16

**R**  
**remote configuration** 56  
**restoring original settings** 55  
**ringing tones**  
  contacts 41

**S**  
**screen saver** 51  
**searching** 50  
**security**  
  Bluetooth 60  
  web browser 46  
**security code** 16  
**security module** 16  
**sending**  
  using Bluetooth 61  
**sensors** 51  
**settings**  
  accessories 54  
  active notes 54

  browser 47  
  calls 21  
  clock 52  
  configuration 11  
  network 23  
  restoring 55  
**settings wizard** 54  
**Share online**  
  activating services 48  
  creating posts 48  
  subscribing 48  
**share online** 48  
**signal strength** 14  
**SIM card**  
  inserting 9  
  messages 38  
**SMS (short message service)** 34  
**software update** 18  
**speed dialling** 19  
**switch the device off** 11  
**switch the device on** 11  
**synchronisation of data** 62

**T**  
**text**  
  letter mode 33  
  number mode 33  
  predictive input 33  
  traditional input 33  
**text messages**  
  sending 34

  settings 38  
  SIM messages 38  
**themes**  
  changing 51  
**time and date** 52  
**traditional text input** 33

**U**  
**UPIN** 16  
**USB data cable** 62

**V**  
**video calls** 21  
  making a call 20  
  switching to voice call 20  
**Video Centre** 49  
**video centre**  
  downloading 49  
  viewing 49  
**video sharing**  
  sharing live video 23  
  sharing video clips 23  
**voice mail**  
  calling 19  
  changing number 19  
**volume control** 16

**W**  
**web connection** 44  
**WLAN**  
  access points 63

## Index



**Index**

**WLAN wizard 63**  
**writing language 33**

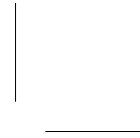

**76**

