

Nokia 6270 User Guide

9242257
Issue 1

DECLARATION OF CONFORMITY

We, NOKIA CORPORATION declare under our sole responsibility that the product RM-56 is in conformity with the provisions of the following Council Directive: 1999/5/EC.

A copy of the Declaration of Conformity can be found from
http://www.nokia.com/phones/declaration_of_conformity/.

CE 434



The crossed-out wheeled bin means that within the European Union the product must be taken to separate collection at the product end-of-life. This applies to your device but also to any enhancements marked with this symbol. Do not dispose of these products as unsorted municipal waste.

Copyright © 2005 Nokia. All rights reserved.

Reproduction, transfer, distribution or storage of part or all of the contents in this document in any form without the prior written permission of Nokia is prohibited.

Nokia, Visual Radio, Nokia Connecting People, and Pop-Port are trademarks or registered trademarks of Nokia Corporation. Other product and company names mentioned herein may be trademarks or tradenames of their respective owners.

Nokia tune is a sound mark of Nokia Corporation.

Bluetooth is a registered trademark of Bluetooth SIG, Inc.



Includes RSA BSAFE cryptographic or security protocol software from RSA Security.



Java is a trademark of Sun Microsystems, Inc.

This product is licensed under the MPEG-4 Visual Patent Portfolio License (i) for personal and noncommercial use in connection with information which has been encoded in compliance with the MPEG-4 Visual Standard by a consumer engaged in a personal and noncommercial activity and (ii) for use in connection with MPEG-4 video provided by a licensed video provider. No license is granted or shall be implied for any other use. Additional information including that relating to promotional, internal and commercial uses may be obtained from MPEG LA, LLC. See <<http://www.mpegla.com>>.

Nokia operates a policy of continuous development. Nokia reserves the right to make changes and improvements to any of the products described in this document without prior notice.

Under no circumstances shall Nokia be responsible for any loss of data or income or any special, incidental, consequential or indirect damages howsoever caused.

The contents of this document are provided "as is". Except as required by applicable law, no warranties of any kind, either express or implied, including, but not limited to, the implied warranties of merchantability and fitness for a particular purpose, are made in relation to the accuracy, reliability or contents of this document. Nokia reserves the right to revise this document or withdraw it at any time without prior notice.

The availability of particular products may vary by region. Please check with the Nokia dealer nearest to you.

This device may contain commodities, technology or software subject to export laws and regulations from the US and other countries. Diversion contrary to law is prohibited.

FCC/INDUSTRY CANADA NOTICE

Your device may cause TV or radio interference (for example, when using a telephone in close proximity to receiving equipment). The FCC or Industry Canada can require you to stop using your telephone if such interference cannot be eliminated. If you require assistance, contact your local service facility. This device complies with part 15 of the FCC rules. Operation is subject to the following two conditions: (1) This device may not cause harmful interference, and (2) this device must accept any interference received, including interference that may cause undesired operation. Any changes or modifications not expressly approved by the Nokia could void the user's authority to operate this equipment.

9242257 / Issue 1

Contents

For your safety	6	Memory full.....	35
General information	9	Flash messages.....	35
Overview of functions.....	9	Nokia Xpress audio messaging.....	36
Access codes.....	9	Instant messaging.....	37
Configuration settings service.....	10	E-mail application.....	42
Download content and applications.....	11	Voice messages.....	45
Nokia support and contact information.....	11	Info messages.....	45
1. Get started	13	Service commands.....	45
Install the SIM card and the battery.....	13	Delete messages.....	45
Install a memory card.....	14	Message settings.....	46
Charge the battery.....	15	7. Contacts	50
Switch the phone on and off.....	16	Search for a contact.....	50
Open the keypad.....	17	Save names and phone numbers....	50
Normal operating position.....	17	Save multiple numbers, text items, or an image.....	50
Wrist strap.....	17	Copy contacts.....	51
2. Your phone	18	Edit contact details.....	51
Keys and parts.....	18	Delete contacts.....	51
Standby mode.....	19	My presence.....	52
Keypad lock (keyguard).....	23	Subscribed names.....	53
3. Call functions	24	Business cards.....	54
Make a call.....	24	Settings.....	54
Answer or reject a call.....	25	Groups.....	55
Options during a call.....	26	Speed dials.....	55
4. Write text	27	Service and my numbers.....	55
Settings.....	27	8. Call log	56
Predictive text input.....	27	Positioning information.....	56
Traditional text input.....	28	9. Settings	58
5. Navigate the menus	29	Profiles.....	58
6. Messaging	30	Themes.....	58
Text messages (SMS).....	30	Tones.....	58
SIM messages.....	31	Display.....	59
Multimedia messages.....	32	Time and date.....	60
		My shortcuts.....	60
		Connectivity.....	62
		Call.....	68

Contents

<p>Phone 69</p> <p>Enhancements 70</p> <p>Configuration 70</p> <p>Security 71</p> <p>Restore factory settings 72</p> <p>10.Operator menu..... 73</p> <p>11.Gallery 74</p> <p>Format memory card 74</p> <p>12.Media 75</p> <p>Camera 75</p> <p>Media player 76</p> <p>Music player 77</p> <p>Radio 78</p> <p>Voice recorder 80</p> <p>Equalizer 81</p> <p>Stereo widening 81</p> <p>13.Push to talk..... 82</p> <p>Connect to and disconnect from the PTT service 82</p> <p>Make and receive a PTT call 83</p> <p>Callback requests 84</p> <p>Add a one-to-one contact 86</p> <p>PTT channels 86</p> <p>PTT settings 87</p> <p>14.Organizer..... 89</p> <p>Alarm clock 89</p> <p>Calendar 89</p> <p>To-do list 90</p> <p>Notes 91</p> <p>Countdown timer 91</p> <p>Stopwatch 92</p> <p>15.Applications..... 93</p>	<p>Games 93</p> <p>Collection 93</p> <p>16.Web..... 95</p> <p>Basic steps to access and use services 95</p> <p>Set up browsing 95</p> <p>Connect to a service 96</p> <p>Browse pages 96</p> <p>Bookmarks 97</p> <p>Appearance settings 98</p> <p>Security settings 99</p> <p>Download settings 99</p> <p>Service inbox 99</p> <p>Cache memory 100</p> <p>Browser security 101</p> <p>17.SIM services..... 103</p> <p>18.PC connectivity 103</p> <p>USB data storage 103</p> <p>Nokia PC Suite 104</p> <p>Data communication applications 104</p> <p>(E)GPRS, HSCSD, and CSD 104</p> <p>19.Battery information 105</p> <p>Charging and discharging 105</p> <p>Nokia battery authentication guidelines 106</p> <p>Care and maintenance 108</p> <p>Additional safety information..... 109</p> <p>INDEX 113</p>
---	--

For your safety

For your safety

Read these simple guidelines. Not following them may be dangerous or illegal. Read the complete user guide for further information.



SWITCH ON SAFELY

Do not switch the phone on when wireless phone use is prohibited or when it may cause interference or danger.



ROAD SAFETY COMES FIRST

Obey all local laws. Always keep your hands free to operate the vehicle while driving. Your first consideration while driving should be road safety.



INTERFERENCE

All wireless phones may be susceptible to interference, which could affect performance.



SWITCH OFF IN HOSPITALS

Follow any restrictions. Switch the phone off near medical equipment.



SWITCH OFF IN AIRCRAFT

Follow any restrictions. Wireless devices can cause interference in aircraft.



SWITCH OFF WHEN REFUELING

Do not use the phone at a refueling point. Do not use near fuel or chemicals.



SWITCH OFF NEAR BLASTING

Follow any restrictions. Do not use the phone where blasting is in progress.



USE SENSIBLY

Use only in the normal position as explained in the product documentation. Do not touch the antenna unnecessarily.



QUALIFIED SERVICE

Only qualified personnel may install or repair this product.



ENHANCEMENTS AND BATTERIES

Use only approved enhancements and batteries. Do not connect incompatible products.

For your safety



WATER-RESISTANCE

Your phone is not water-resistant. Keep it dry.



BACK-UP COPIES

Remember to make back-up copies or keep a written record of all important information stored in your phone.



CONNECTING TO OTHER DEVICES

When connecting to any other device, read its user guide for detailed safety instructions. Do not connect incompatible products.



EMERGENCY CALLS

Ensure the phone is switched on and in service. Press the end key as many times as needed to clear the display and return to the start screen. Enter the emergency number, then press the call key. Give your location. Do not end the call until given permission to do so.

■ About your device

The wireless device described in this guide is approved for use on the EGSM 900 and GSM 850/1800/1900 network. Contact your service provider for more information about networks.

When using the features in this device, obey all laws and respect privacy and legitimate rights of others.

When taking and using images or video clips, obey all laws and respect local customs as well as privacy and legitimate rights of others.



Warning: To use any features in this device, other than the alarm clock, the device must be switched on. Do not switch the device on when wireless device use may cause interference or danger.

■ Network services

To use the phone you must have service from a wireless service provider. Many of the features in this device depend on features in the wireless network to function. These network services may not be available on all networks or you may have to make specific arrangements with your service provider before you can utilize network services. Your service provider may need to give you additional instructions for their use and explain what charges will apply. Some networks may have limitations that affect how you can use network services. For instance, some networks may not support all language-dependent characters and services. Your service provider may have requested that certain features be disabled or not activated in your device. If so, they will not appear on your device menu. Your

For your safety

device may also have been specially configured. This configuration may include changes in menu names, menu order, and icons. Contact your service provider for more information.

This device supports WAP 2.0 protocols (HTTP and SSL) that run on TCP/IP protocols. Some features of this device, such as multimedia messaging (MMS), browsing, e-mail application, instant messaging, presence-enhanced contacts, remote synchronization, and content downloading using the browser or MMS, require network support for these technologies.

■ Shared memory

The following features in this device may share memory: gallery, contacts, text messages, multimedia messages, instant messages, e-mail, calendar, to-do notes, Java™ games and applications, and note application. Use of one or more of these features may reduce the memory available for the remaining features sharing memory. For example, saving many Java applications may use all of the available memory. Your device may display a message that the memory is full when you try to use a shared memory feature. In this case, delete some of the information or entries stored in the shared memory features before continuing. Some of the features, such as text messages, may have a certain amount of memory specially allotted to them in addition to the memory shared with other features.

■ Enhancements

A few practical rules about accessories and enhancements.

- Keep all accessories and enhancements out of the reach of small children.
- When you disconnect the power cord of any accessory or enhancement, grasp and pull the plug, not the cord.
- Check regularly that enhancements installed in a vehicle are mounted and are operating properly.
- Installation of any complex car enhancements must be made by qualified personnel only.

General information

■ Overview of functions

Your phone provides many functions that are practical for daily use, such as a text and multimedia messaging, push to talk, e-mail application, a clock, an alarm clock, a radio, and a music player. Your phone also supports the following functions:

- Active standby. See "Active standby," p. 20.
- Built-in 2 Megapixel camera. See "Camera," p. 75.
- Enhanced voice dialing. See "Enhanced voice dialing," p. 24 and "Voice commands," p. 61.
- Stereo speakers with 3D sound effects. See "Stereo widening," p. 81.
- Music player. See "Music player," p. 77.
- Bluetooth technology. See "Bluetooth wireless technology," p. 62.
- Plug and play online service to get the configuration settings. See "Plug and play service," p. 16 and "Configuration," p. 70.
- Memory card to extend the memory capacity of your phone to save images and video clips

■ Access codes

Security code

The security code (5 to 10 digits) helps to protect your phone against unauthorized use. The preset code is 12345. To change the code, and to set the phone to request the code, see "Security," p. 71.

If you enter an incorrect security code five times in succession, the phone ignores further entries of the code. Wait for 5 minutes, and enter the code again.

General information

PIN codes

- The personal identification number (PIN) code and the universal personal identification number (UPIN) code (4 to 8 digits) help to protect your SIM card against unauthorized use. See "Security," p. 71. The PIN code is usually supplied with the SIM card. To set the phone to request the PIN code, see "Security," p. 71.
- The PIN2 code (4 to 8 digits) may be supplied with the SIM card and is required for some functions.
- The module PIN is required to access the information in the security module. See "Security module," p. 101. The module PIN is supplied with the SIM card if the SIM card has a security module in it.
- The signing PIN is required for the digital signature. See "Digital signature," p. 102. The signing PIN is supplied with the SIM card if the SIM card has a security module in it.

PUK codes

The personal unblocking key (PUK) code and the universal personal unblocking key (UPUK) code (8 digits) is required to change a blocked PIN code and UPIN code, respectively. The PUK2 code is required to change a blocked PIN2 code.

If the codes are not supplied with the SIM card, contact your service provider for the codes.

Barring password

The barring password (4 digits) is required when using the [Call barring service](#). See "Security," p. 71. You can obtain the password from your service provider.

If you enter an incorrect barring password three times in succession, the password is blocked. Contact your service provider or network operator.

■ [Configuration settings service](#)

Before you use multimedia messaging, instant messaging and presence, push to talk, e-mail application, synchronization, streaming, and the

browser, you must have the proper configuration settings on your phone. You may receive the settings directly as a configuration message, which you save to your phone. For more information on availability, contact your network operator, service provider, or nearest authorized Nokia dealer.

When you have received the settings as a configuration message, and the settings are not automatically saved and activated, *Configuration settings received* is displayed.

To save the received settings, select **Show** > **Save**. If the phone requests *Enter settings' PIN*, enter the PIN code for the settings, and select **OK**. To receive the PIN code, contact the service provider that supplies the settings.

If no settings are saved yet, these settings are saved and set as default configuration settings. Otherwise, the phone asks *Activate saved configuration settings?*

To discard the received settings, select **Show** > **Discard**.

■ Download content and applications

You may be able to download content, such as themes, tones, and video clips, to the phone (network service). Select the download function (for example, in the *Gallery* menu). To access the download function, see the respective menu descriptions. For availability of different services, pricing, and tariffs, contact your service provider.



Important: Use only services that you trust and that offer adequate security and protection against harmful software.

■ Nokia support and contact information

Check www.nokia.com/support or your local Nokia Web site for the latest version of this guide, additional information, downloads, and services related to your Nokia product.

On the Web site, you can get information on the use of Nokia products and services. If you need to contact customer service, check the list of local Nokia contact centers at www.nokia.com/customerservice.

General information

For maintenance services, check your nearest Nokia service center location at www.nokia.com/repair.

1. Get started

■ Install the SIM card and the battery

Always switch the device off and disconnect the charger before removing the battery.

Keep all SIM cards out of the reach of small children.

For availability and information on using SIM card services, contact your SIM card vendor. This may be the service provider, network operator, or other vendor.

This device is intended for use with the BL-5C battery.

The SIM card and its contacts can easily be damaged by scratches or bending, so be careful when handling, inserting, or removing the card.

1. With the back of the phone facing you, slide the back cover to remove it from the phone (1).

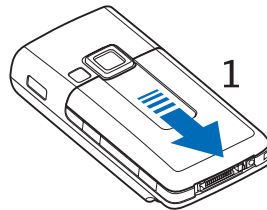

2. To remove the battery, lift it as shown (2).

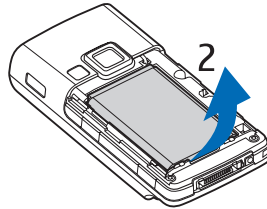

3. To release the SIM card holder, gently pull the locking clip of the card holder, and open it (3).

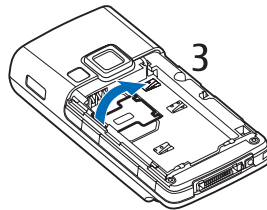

Get started

4. Insert the SIM card into the SIM card holder (4). Make sure that the SIM card is properly inserted and that the golden contact area on the card is facing downwards.

Close the SIM card holder, and press it until it snaps into position.

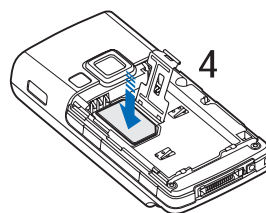

5. Replace the battery (5).

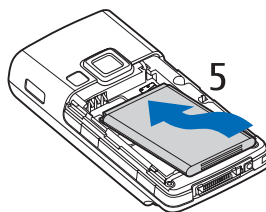

6. Slide the back cover into place (6).

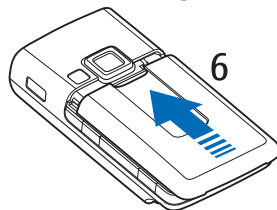

■ Install a memory card

Use only compatible miniSD cards with this device. Other memory cards, such as Reduced Size MultiMediaCards, do not fit in the memory card slot and are not compatible with this device. Using an incompatible memory card may damage the memory card as well as the device, and data stored on the incompatible card may be corrupted.



You can use a memory card to extend the memory of *Gallery*. See "Gallery," p. 74.

You can insert or change the memory card without switching the phone off.



Important: Do not remove the memory card in the middle of an operation when the card is being accessed. Removing the card in the middle of an operation may damage the memory card as well as the device, and data stored on the card may be corrupted.

To insert the memory card, open the memory card holder as shown (1). Place the memory card in the card holder (2). Make sure that the memory card is properly inserted and that the golden contact area on the card is facing downwards. Close the memory card holder.

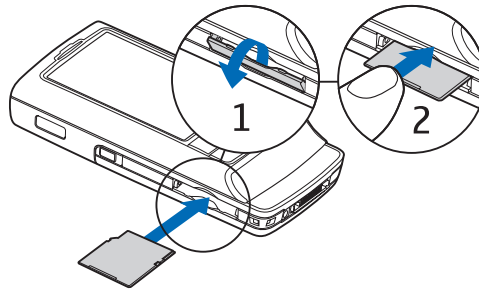

You can use the memory card to save your multimedia files, such as video clips, sound files, and images, in [Gallery](#).

To format the memory card, see "Format memory card," p. 74.

■ Charge the battery

Check the model number of any charger before use with this device. This device is intended for use when supplied with power from the AC-4, AC-1, AC-3, and DC-4 charger.



Warning: Use only batteries, chargers, and enhancements approved by Nokia for use with this particular model. The use of any other types may invalidate any approval or warranty, and may be dangerous.

For availability of approved enhancements, please check with your dealer. When you disconnect the power cord of any enhancement, grasp and pull the plug, not the cord.

Get started

1. Connect the charger to a wall socket.
2. Connect the lead from the charger to the CA-44 charging adapter (1), and the adapter to the socket on the bottom of your phone (2).

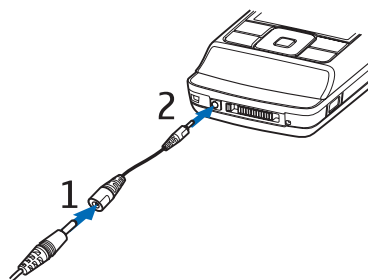

If the battery is completely discharged, it may take a few minutes before the charging indicator appears on the display or before any calls can be made.

The charging time depends on the charger used. For example, charging a BL-5C battery with the AC-4 charger takes about 1 hour and 30 minutes while the phone is in the standby mode.

Switch the phone on and off



Warning: Do not switch the phone on when wireless phone use is prohibited or when it may cause interference or danger.

Press and hold the power key as shown.

If the phone asks for a PIN or UPIN code, enter the code, and select **OK**.

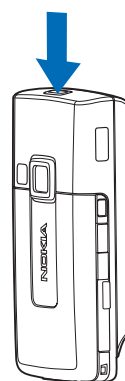

Plug and play service

When you switch on your phone for the first time, and the phone is in the standby mode, you may be asked to get the configuration settings from your service provider (network service). Confirm or decline the query. See [Connect to serv. support](#) in "Configuration," p. 70 and "Configuration settings service," p. 10.

■ Open the keypad

To open the keypad, slide the phone as shown.

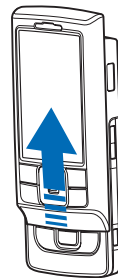

■ Normal operating position

Use the phone only in its normal operating position.

Your device has an internal antenna.



Note: As with any other radio transmitting device, do not touch the antenna unnecessarily when the device is switched on. Contact with the antenna affects call quality and may cause the device to operate at a higher power level than otherwise needed. Avoiding contact with the antenna area when operating the device optimizes the antenna performance and the battery life.

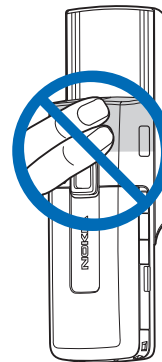

■ Wrist strap

Thread the strap as shown in the picture.

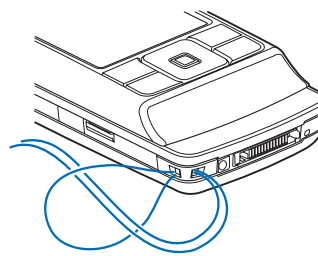

2. Your phone

■ Keys and parts

- Power key (1)
- Loudspeaker (2)
- Camera flash (3)
- Camera lens (4)
- Volume keys (5)
- Camera key (6)

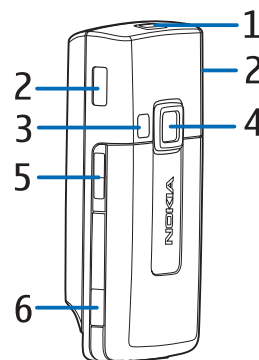

- Earpiece (7)
- Left, middle, and right selection keys (8)

The function of these keys depends on the guiding text shown on the display above the keys.

- 4-way navigation key (9)
Scroll up, down, left, and right.
- Call key (10)
- End key (11)
- Number keys (12) to enter numbers and characters. * and # (12) are used for various purposes in different functions.

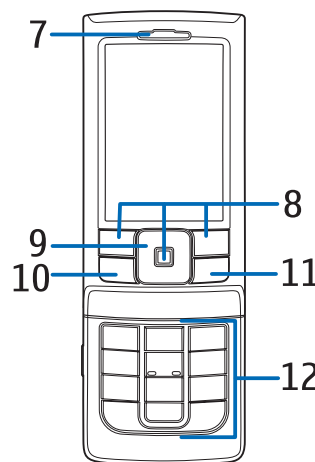

Your phone

- Push to talk key (13)
- Infrared (IR) port (14)
- Memory card slot (15)
- Charger connector (16)
- Enhancements connector (17)

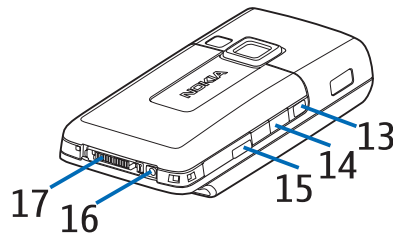

■ Standby mode

When the phone is ready for use, and you have not entered any characters, the phone is in the standby mode.

- Signal strength of the cellular network (1)
- Battery charge level (2)
- Indicators (3)
- The name of the network or the operator logo (4)
- Clock (5)
- Active standby (6). See "Active standby," p. 20.
- The left selection key (7) is **Go to** or a shortcut to another function. See "Left selection key," p. 60.
- The middle selection key (8) mode is **Menu**.
- The right selection key (9) may be **Names** to access the list of contacts in the **Contacts** menu, an operator-specific name to access an operator-specific Web site, or a shortcut to a function that you selected. See "Right selection key," p. 61.

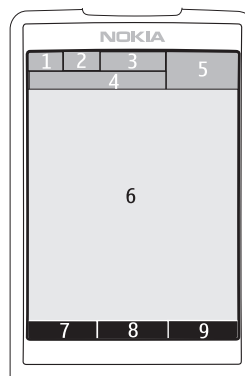

Active standby

In active standby the phone display can show separate content item windows, such as shortcuts (1), audio functions (2), the calendar (3), and a user note (4). To select whether the active standby is shown, see [Active standby](#) in "Standby mode settings," p. 59.

The active standby is in passive mode when the middle selection key (5) is **Menu**; you can only view content. To activate the navigation mode and scroll through the

content, scroll up or down. To change the key for accessing the navigation mode, see [Enabling active standby](#) in "Standby mode settings," p. 59. When the arrow indicators (6) are shown, you can scroll the item left and right.

To personalize and organize the active standby content, select [Options](#) > [Active standby](#). See "Standby mode settings," p. 59.

To exit the navigation mode, select [Exit](#). If no keys are pressed in a certain time, the phone automatically returns to the passive mode.

Content items in navigation mode

- [Shortcut bar](#) – To select a shortcut, scroll to the desired function and select it.

To change or organize the shortcuts when in the navigation mode, select [Options](#) > [Active standby](#) > [Options](#) > [Personalise](#), scroll to the shortcut window, and select [Options](#) > [Select links](#) or [Organise links](#).

- [Audio applications](#) – To switch on the radio or the music player, scroll to and select it. To change a track in the music player or a channel in the radio, scroll left or right. To start the radio channel search, scroll and hold left or right.

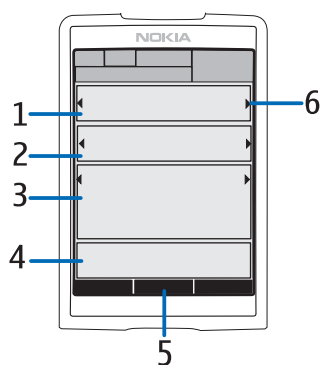

- **Calendar** – To view today's notes, select the desired one. To view the notes for the previous or next days, scroll left or right.
- **My note** – To enter a note, select the content window, write your note, and save it.
- **My presence** – To change your presence status information, select the content item.
- **Countdown timer** – To start the countdown timer, select the content item. The remaining time with a note is shown.
- **General indicators** – To show standby indicators, such as date, cell info display, info messages, PTT default group name, and closed user group index. The date is shown if the calendar is not selected as active standby content.

Standby mode shortcuts

- To access the list of dialed numbers, press the call key once. See "Make a call," p. 24.
- To call your voice mailbox (network service) when you have saved your voice mailbox number in the phone, press and hold 1.
- To connect to a browser service, press and hold 0.
- To set shortcut functions for the navigation key, see [Navigation key](#) in "My shortcuts," p. 60.
- To change the profile, open the list of profiles by briefly pressing the power key. Scroll to the desired profile, and select it.

Power saver

To set the power saving function *On*, see [Power saver](#) in "Display," p. 59.

Indicators























You have unread messages in the [Inbox](#) folder.



You have unsent, canceled, or failed messages in the [Outbox](#) folder.

Your phone

-  The phone registered a missed call.
-  Your phone is connected to the instant messaging service, and the availability status is online/offline.
-  You received one or several instant messages, and you are connected to the instant messaging service.
-  The keypad is locked.
-  The phone does not ring for an incoming call or text message.
-  The alarm clock is set to *On*.
-  The countdown timer is running.
-  The stopwatch is running in the background.
-  The phone is registered to the GPRS or EGPRS network.
-  A GPRS or EGPRS connection is established.
-  The GPRS or EGPRS connection is suspended (on hold), for example, if there is an incoming or outgoing call during an (E)GPRS dial-up connection.
-  When the infrared connection is activated, the indicator is shown continuously.
-  A Bluetooth connection is active.
-  If you have two phone lines, the second phone line is selected.
-  All incoming calls are diverted to another number.
-  The loudspeaker is activated, or the music stand is connected to the phone.
-  Calls are limited to a closed user group.
-  The timed profile is selected.
-  A headset, hands-free, loopset, or music stand enhancement is connected to the phone.

 /  A push to talk connection is active/suspended.

■ Keypad lock (keyguard)

To prevent the keys from being accidentally pressed, select **Menu**, and press * within 3.5 seconds to lock the keypad; or close the slide, and select **Lock**.

To unlock the keypad, open the slide, or select **Unlock** > **OK**. If the slide is open, select **Unlock**, and press * within 1.5 seconds. If the **Security keyguard** is set **On**, select **Unlock**, press *, and enter the security code.

To answer a call when the keyguard is on, press the call key. When you end or reject the call, the keypad automatically locks.

For **Automatic keyguard** and **Security keyguard**, see "Phone," p. 69.

When the keyguard is on, calls still may be possible to the official emergency number programmed into your device.

3. Call functions

■ Make a call

1. Enter the phone number, including the area code.
For international calls, press * twice for the international prefix (the + character replaces the international access code), enter the country code, the area code without the leading 0, if necessary, and the phone number.
2. To call the number, press the call key.
3. To end the call, or to cancel the call attempt, press the end key.
To end the call by closing the slide, see [Slide call handling](#) in "Call," p. 68.

To search for a name or phone number that you have saved in [Contacts](#), see "Search for a contact," p. 50. Press the call key to call the number.

To access the list of phone numbers you have most recently called or attempted to call, in the standby mode, press the call key once. To call the number, scroll to the number or name you want, and press the call key.

Speed dialing

Assign a phone number to one of the speed-dialing keys, 2 to 9. See "Speed dials," p. 55. Call the number in either of the following ways:

- Press the speed-dialing key, then the call key.
- If [Speed dialing](#) is set to [On](#), press and hold a speed-dialing key until the call begins. See "Call," p. 68.

Enhanced voice dialing

You can make a phone call by saying the name that is saved in the contact list of the phone. A voice command is added automatically to all entries in the contact list of the phone.

Make a voice dialing call

If an application is sending or receiving data using a packet data connection, end the application before you use voice dialing.

Voice commands are language-dependent. To set the language, see [Voice playback language](#) in "Phone," p. 69.



Note: Using voice tags may be difficult in a noisy environment or during an emergency, so you should not rely solely upon voice dialing in all circumstances.

1. In the standby mode, press and hold the right selection key. A short tone is played, and *Speak now* is displayed.
If you are using a compatible headset with the headset key, press and hold the headset key to start the voice dialing.
2. Say the voice command clearly. If the voice recognition was successful, a list with matches is shown. The phone plays the voice command of the match on the top of the list. After about 1.5 seconds, the phone dials the number; or if the result is not the correct one, scroll to another entry, and select to dial the entry.
Using voice commands to carry out a selected phone function is similar to voice dialing. See [Voice commands](#) in "My shortcuts," p. 60.

■ Answer or reject a call

To answer a call, press the call key. To answer the call by opening the slide, see also [Slide call handling](#) in "Call," p. 68.

To mute the ringing tone before you answer the call, select [Silence](#).

To end the call, or to reject a call, press the end key.



Tip: If the [Divert if busy](#) function is activated to divert the calls (for example, to your voice mailbox), rejecting an incoming call also diverts the call. See "Call," p. 68.

If a compatible headset supplied with the headset key is connected to the phone, to answer and end a call, press the headset key.

Call functions

Call waiting

During a call, to answer the waiting call, press the call key. The first call is put on hold. To end the active call, press the end key.

To activate the *Call waiting* function, see "Call," p. 68.

Options during a call

Many of the options that you can use during a call are network services. For availability, contact your network operator or service provider.

Call options are *Mute* or *Unmute*, *Contacts*, *Menu*, *Lock keypad*, *Record*, *Loudspeaker*, or *Handset*.

Network services options are *Answer*, *Reject*, *Hold* or *Unhold*, *New call*, *Add to conference*, *End call*, *End all calls*, and the following:

Send DTMF— to send tone strings

Swap— to switch between the active call and the call on hold

Transfer— to connect a call on hold to an active call and disconnect yourself

Conference— to make a conference call that allows up to five persons to take part in a conference call



Private call— to discuss privately in a conference call



Warning: Do not hold the device near your ear when the loudspeaker is in use, because the volume may be extremely loud.

4. Write text

You can enter text (for example, when writing messages) using traditional or predictive text input. When using traditional text input, press a number key, 1 to 9, repeatedly until the desired character appears. In predictive text input you can enter a letter with a single keypress.



When you write text,  or  appears at the top of the display, indicating predictive text input, and  appears, indicating traditional text input. **Abc**, **abc**, or **ABC** appears next to the text input indicator, indicating the character case. To change the character case, press **#**. **123** indicates number mode. To change from the letter to number mode, press and hold **#**, and select *Number mode*.

■ Settings

To set the writing language while writing text, select **Options** > *Writing language*.

When writing text, select **Options** > *Prediction settings*.

To set predictive text input on or revert to traditional text input, select *Prediction* > *On* or *Off*.

To select the prediction type, select *Prediction type* > *Normal* or *Word suggestions*. If you select *Normal*, indicated with , the phone predicts the word on the basis of the characters you entered. If you select *Word suggestions*, indicated with , the phone predicts and completes the word before you enter all the characters.



Tip: To quickly set predictive text input on or off when writing text, press **#** twice, or select and hold **Options**.

■ Predictive text input

Predictive text input allows you to write text quickly using the phone keypad and a built-in dictionary.

Write text

1. Start writing a word using the 2 to 9 keys. Press each key only once for one letter. The phone displays * or the letter if it separately has a meaning as a word. The entered letters are displayed underlined.
If you selected *Word suggestions* as prediction type, the phone starts to predict the word you are writing. After you enter a few letters, and if these entered letters are not a word, the phone tries to predict longer words. Only the entered letters are displayed underlined.
To insert a special character, press and hold *, or select **Options** > *Insert symbol*. Scroll to a character, and select **Use**.
2. When you finish writing the word and it is correct, to confirm it, press 0 to add space.
If the word is not correct, press * repeatedly, or select **Options** > *Matches*. When the word that you want appears, select **Use**.
If the ? character is displayed after the word, the word you intended to write is not in the dictionary. To add the word to the dictionary, select **Spell**. Complete the word (traditional text input is used), and select **Save**.

To write a compound word, enter the first part of the word, and scroll forward to confirm it. Write the next part of the word, and confirm the word.

■ Traditional text input

Press a number key, 1 to 9, repeatedly until the desired character appears. Not all characters available under a number key are printed on the key. The characters available depend on the selected writing language. See "Settings," p. 27.

If the next letter you want is located on the same key as the present one, wait until the cursor appears, or briefly press any of the navigation keys and enter the letter.

The most common punctuation marks and special characters are available under the 1 key. For more characters, press *.

5. Navigate the menu

The phone offers you an extensive range of functions, which are grouped into menus.

1. To access the menu, select **Menu**.

To change the menu view, select **Options** > *Main menu view* > *List*, *Grid*, *Grid with labels*, or *Tab*.

To rearrange the menu, scroll to the menu you want to move, and select **Options** > *Organise* > **Move**. Scroll to where you want to move the menu, and select **OK**. To save the change, select **Done** > **Yes**.

2. Scroll through the menu, and select an option (for example, *Settings*).
3. If the selected menu contains further submenus, select the one that you want (for example, *Call*).
4. If the selected menu contains further submenus, repeat step 3.
5. Select the setting of your choice.
6. To return to the previous menu level, select **Back**. To exit the menu, select **Exit**.

The menus, submenus, and setting options are numbered. You can access some of them by using their shortcut number.

To access the menu, select **Menu**. Enter quickly, within 2 seconds, the shortcut number of the menu function you want to access. To access the menu functions in menu level 1, enter 0 and 1.

6. Messaging



You can read, write, send, and save text, multimedia, e-mail, audio, and flash messages. All messages are organized into folders.

■ Text messages (SMS)

With the short message service (SMS) you can send and receive text messages, and receive messages that can contain pictures (network service).

Before you can send any text or SMS e-mail message, you must save your message center number. See "Message settings," p. 46.

To check SMS e-mail service availability and to subscribe to the service, contact your service provider. To save an e-mail address in [Contacts](#), see "Save multiple numbers, text items, or an image," p. 50.

Your device supports the sending of text messages beyond the character limit for a single message. Longer messages will be sent as a series of two or more messages. Your service provider may charge accordingly. Characters that use accents or other marks, and characters from some language options like Chinese, take up more space limiting the number of characters that can be sent in a single message.

The message length indicator at the top of the display shows the total number of characters left and the number of messages needed for sending. For example, 673/2 means that there are 673 characters left and that the message will be sent as a series of two messages.

Write and send SMS messages

1. Select [Menu](#) > [Messaging](#) > [Create message](#) > [Text message](#).
2. Enter the recipient's phone number in the *To:* field. To retrieve a phone number from [Contacts](#), select [Add](#) > [Contact](#). To send the message to multiple recipients, add the desired contacts one by one. To send the message to persons in a group, select [Contact group](#) and the desired group. To retrieve the contacts to which you recently sent messages, select [Add](#) > [Recently used](#).

3. Scroll down, and write your message in the *Message:* field. See "Write text," p. 27.
 To insert a template into the message, select **Options** > *Use template*.
 To see how the message will look to the recipient, select **Options** > *Preview*.
4. To send the message, select **Send**. See "Message sending," p. 33.

Read and reply to an SMS message

1 message received, or the number of new messages with *messages received* are shown when you have received a message.

1. To view a new message, select **Show**. To view it later, select **Exit**.
 To read the message later, select **Menu** > *Messaging* > *Inbox*. If more than one message is received, select the message you want to read.
 is shown if you have unread messages in *Inbox*.
2. To view the list of available options while reading a message, select **Options**. You can, for example, select to copy text from the beginning of a message to your phone calendar as a reminder note.
3. To reply to a message, select **Reply** > *Text message*, *Multimedia*, *Flash message*, or *Audio message*.
 To send a text message to an e-mail address, enter the e-mail address in the *To:* field.
 Scroll down, and write your message in the *Message:* field. See "Write text," p. 27.
 If you want to change the message type for your reply message, select **Options** > *Change message type*.
4. To send the message, select **Send**.

■ SIM messages

SIM messages are text messages that are saved to your SIM card. You can copy or move those messages to the phone memory, but not vice versa. Received messages are saved to the phone memory.

Messaging

To read SIM messages, select **Menu** > *Messaging* > **Options** > *SIM messages*.

■ Multimedia messages



Note: Only devices that have compatible features can receive and display multimedia messages. The appearance of a message may vary depending on the receiving device.

To check availability and to subscribe to the multimedia messaging network service, contact your network operator or service provider. See "Multimedia messages," p. 47.

A multimedia message can contain text, sound, pictures, video clips, a business card, and a calendar note. If the message is too large, the phone may not be able to receive it. Some networks allow text messages that include an Internet address where you can view the multimedia message.

Multimedia message sending supports the following picture, sound, and video file formats:

- Picture: JPEG, GIF, animated GIF, and WBMP
- Sound: AMR audio
- Video clips: 3GP format with H.263 or MPEG video (QCIF resolution) and AMR audio

The phone may not support all variations of the file formats.

You cannot receive multimedia messages during a call or an active browsing session over GSM data. Because delivery of multimedia messages can fail for various reasons, do not rely solely upon them for essential communications.

Write and send a multimedia message

The wireless network may limit the size of MMS messages. If the inserted picture exceeds this limit, the device may make it smaller so that it can be sent by MMS.

1. Select **Menu** > *Messaging* > *Create message* > *Multimedia*.
2. Enter your message.

Your phone supports multimedia messages that contain several pages (slides). A message can contain a calendar note and a business card as attachments. A slide can contain text, one image, and one sound clip; or text and a video clip. To insert a slide in the message, select **New**; or select **Options** > **Insert** > **Slide**.

To insert a file in the message, select **Insert**; or **Options** > **Insert**.

3. To view the message before sending it, select **Options** > **Preview**.
4. To send the message, select **Send**. See "Message sending," p. 33.
5. Enter the recipient's phone number in the **To:** field. To retrieve a phone number from **Contacts**, select **Add** > **Contact**. To send the message to multiple recipients, add the desired contacts one by one. To send the message to persons in a group, select **Contact group** and the desired group. To retrieve the contacts to which you recently sent messages, select **Add** > **Recently used**.

Message sending

Copyright protections may prevent some images, music (including ringing tones), and other content from being copied, modified, transferred or forwarded.

When you finish writing your message, to send the message, select **Send**, or press the call key. The phone saves the message in the **Outbox** folder, and the sending starts. If you select **Save sent messages** > **Yes**, the sent message is saved in the **Sent items** folder. See "General settings," p. 46.



Note: When the phone is sending the message, the animated  is shown. Actual receipt of a message depends on a number of factors. For more details about messaging services, check with your service provider.

It takes more time to send a multimedia message than to send a text message. While the message is being sent, you can use other functions on the phone. If an interruption occurs while the message is being sent, the phone tries to resend the message a few times. If these attempts fail, the message remains in the **Outbox** folder. You can try to resend it later.

M e s s a g i n g

Cancel message sending

To cancel the sending of the messages in the *Outbox* folder, scroll to the desired message, and select **Options** > *Cancel sending*.

Read and reply to a multimedia message



Important: Exercise caution when opening messages. Multimedia message objects may contain malicious software or otherwise be harmful to your device or PC.

Multimedia message received or the number of new messages with *messages received* is shown when you receive a new multimedia message.

1. To read the message, select **Show**. To view it later, select **Exit**.
To read the message later, select **Menu** > *Messaging* > *Inbox*. Scroll to the message that you want to view, and select it.  is shown if you have unread messages in *Inbox*.
2. To view the whole message if the received message contains a presentation, select **Play**.
To view the files in the presentation or the attachments, select **Options** > *Objects* or *Attachments*.
3. To reply to the message, select **Options** > *Reply* > *Text message*, *Multimedia*, *Flash message*, or *Audio message*. Write the reply message.
If you want to change the message type for your reply message, select **Options** > *Change message type*. The new message type may not support all the content that you have added.
4. To send the message, select **Send**. See "Message sending," p. 33.

■ Memory full

When you are receiving a message, and the memory for the messages is full, *Memory full. Unable to receive messages.* is shown. To first delete old messages, select **OK** > **Yes** and the folder. Scroll to the desired message, and select **Delete**. If one or more messages are marked, select **Mark**. Mark all the messages you want to delete, and select **Options** > *Delete marked*.

■ Folders

The phone saves received messages in the *Inbox* folder.

Messages that have not yet been sent are saved in the *Outbox* folder.

To set the phone to save the sent messages in the *Sent items* folder, see *Save sent messages* in "General settings," p. 46.

To save the message that you are writing and want to send later in the *Drafts* folder, select **Menu** > *Messaging* > *Drafts*.

You can move your messages to the *Saved items* folder. To organize your *Saved items* subfolders, select **Menu** > *Messaging* > *Saved items* > *Saved messages* or a folder you added. To add a new folder for your messages, select **Options** > *Add folder*. To delete or rename a folder, scroll to the desired folder, and select **Options** > *Delete folder* or *Rename folder*.

Your phone has templates. To create a new template, save or copy a message as a template. To access the template list, select **Menu** > *Messaging* > *Saved items* > *Templates*.

■ Flash messages

Flash messages are text messages that are instantly displayed upon reception. Flash messages are not automatically saved.

Write a flash message

Select **Menu** > *Messaging* > *Create message* > *Flash message*. Enter the recipient's phone number in the *To:* field. Write your message in the

M e s s a g i n g

Message: field. The maximum length of a flash message is 70 characters. To send the message, select **Send**.

Receive a flash message

A received flash message is indicated with the text *Message*: and a few words from the beginning of the message. To read the message, select **Read**. To extract phone numbers, e-mail addresses, and Web site addresses from the current message, select **Options** > *Use detail*.

■ Nokia Xpress audio messaging

You can use the multimedia message service to create and send a voice message in a convenient way. Multimedia messaging service must be activated before you can use audio messages.

Create an audio message

1. Select **Menu** > *Messaging* > *Create message* > *Audio message*. The recorder opens. To use the recorder, see "Voice recorder," p. 80.
2. To view the available options, select **Options**.
3. Enter the recipient's phone number in the *To*: field. To retrieve a phone number from *Contacts*, select **Add** > *Contact*. To send the message to multiple recipients, add the desired contacts one by one. To send the message to persons in a group, select *Contact group* and the desired group. To retrieve the contacts to which you recently sent messages, select **Add** > *Recently used*.
4. To send the message, select **Send**.

Receive an audio message

When your phone receives audio messages, *1 audio message received* or the number of messages and the text *messages received* is shown. To open the message, select **Play**; or if more than one message is received, select **Show** > **Play**. To listen to the message later, select **Exit**. Select **Options** to see the available options.

■ Instant messaging

Instant messaging (IM) (network service) is a way to send short, simple text messages to online users, delivered over TCP/IP protocols.

Before you can use instant messaging, you must subscribe to the service. To check the availability and costs, and to subscribe to the service, contact your network operator or service provider, from whom you also receive your unique ID, password, and settings.

To set the required settings for the instant messaging service, see [Connection settings](#) in "Access the instant messaging menu," p. 37. The icons and texts on the display may vary, depending on the instant messaging service.

While you are connected to the instant messaging service, you can use the other functions of the phone, and the instant messaging conversation remains active in the background. Depending on the network, the active instant messaging conversation may consume the phone battery faster, and you may need to connect the phone to a charger.

Access the instant messaging menu

To access the [Instant messages](#) menu while still offline, select [Menu](#) > [Messaging](#) > [Instant messages](#). If more than one set of connection settings for instant messaging service is available, select the desired one. If there is only one set defined, it is selected automatically.

The following options are shown:

[Login](#) – to connect to the instant messaging service. To set the phone to automatically connect to the instant messaging service when you switch on the phone, select [Menu](#) > [Messaging](#) > [Instant messages](#), connect to the instant messaging service, and select [My settings](#) > [Automatic login](#) > [On phone start-up](#).

[Saved conversations](#) – to view, erase, or rename the conversations that you saved during an instant messaging session

[Connection settings](#) – to edit the settings needed for messaging and presence connection

Connect to and disconnect from the instant messaging service

To connect to the instant messaging service, access the *Instant messages* menu, select the desired instant messaging service if needed, and select *Login*. When the phone has successfully connected, *Logged in* is displayed.

To disconnect from the instant messaging service, select *Logout*.

Start an instant messaging conversation

Open the *Instant messages* menu, and connect to the instant messaging service. You can start a conversation in different ways:

- Select *Conversations*. The list of new and read messaging sessions or invitations to instant messaging during the active conversation is displayed. Scroll to a message or an invitation, and select *Open*.



 indicates new and  read instant messages.

 indicates new and  read group messages.

 indicates invitations.

The icons and texts on the display may vary, depending on the instant messaging service.

- Select *IM contacts*. The contacts that you added to the list are displayed. Scroll to the contact with whom you would like to start instant messaging, and select *Chat*, or if  is shown next to a contact, select *Open*.

 indicates an online contact and  an offline contact in the contact memory of the phone.

 indicates a blocked contact. See "Block and unblock messages," p. 41.

 indicates that you have received a new message from a contact.

You can add contacts to the list. See "Contacts for instant messaging," p. 40.

- Select *Groups* > *Public groups* (dimmed if groups are not supported by the network). The list of bookmarks to public groups provided by

the network operator or service provider is displayed. To start a conversation, scroll to a group, and select **Join**. Enter the screen name that you want to use as a nickname in the conversation. When you have successfully joined the group conversation, you can start a group conversation. You can also create a private group. See "Groups," p. 41.

- Select **Search** > **Users** or **Groups** to search for other instant messaging users or public groups on the network by phone number, screen name, e-mail address, or name. If you select **Groups**, you can search for a group by a member in the group or by group name, topic, or ID.

To start the conversation when you have found the user or the group that you want, select **Options** > **Chat** or **Join group**.

- Start a conversation from Contacts. See "View the subscribed names," p. 53.

Accept or reject an instant messaging invitation

In the standby mode, when you are connected to the instant messaging service and you receive a new invitation, **New invitation received** is displayed. To read it, select **Read**. If more than one invitation is received, scroll to an invitation, and select **Open**.

To join the private group conversation, select **Accept**. Enter the screen name that you want to use as a nickname in the conversation.

To reject or delete the invitation, select **Options** > **Reject** or **Delete**. You can write an explanation for the rejection.

Read a received instant message

In the standby mode, when you are connected to the instant messaging service and you receive a new message that is not a message associated with an active conversation, **New instant message** is displayed. To read it, select **Read**.

If more than one message is received, the number of messages, followed by **new instant messages**, is displayed. Select **Read**, scroll to a message, and select **Open**.

Messaging

New messages received during an active conversation are held in [Instant messages > Conversations](#). If you receive a message from someone who is not in [IM contacts](#), the sender ID is displayed. If the sender is in the phone memory and the phone recognizes it, the name of the person is displayed. To save a new contact that is not in the phone memory, select [Options > Save contact](#).

Participate in an instant messaging conversation

To join or start a conversation, select [Write](#) or start writing.





Tip: If you receive a new message during a conversation from a person who is not taking part in the current conversation,  is displayed, and the phone sounds an alert tone.

Write your message. To send it, select [Send](#), or press the call key. The message stays on the display, and the reply message appears below your message.

Edit your availability status

1. Open the [Instant messages](#) menu, and connect to the instant messaging service.
2. To view and edit your own availability information or screen name, select [My settings](#).
3. To allow all the other instant messaging users to see when you are online, select [Availability > Available for all](#).
To allow only the contacts on your instant messaging contact list to see when you are online, select [Availability > Available for contacts](#).
To appear as being offline, select [Availability > Appear offline](#).

When you are connected to the instant messaging service,  indicates that you are online and  that you are not visible to others.

Contacts for instant messaging

To add contacts to the instant messaging contacts list, do the following:

1. Connect to the instant messaging service, and select [IM contacts](#).

2. Select **Options** > *Add contact*, or if you have no contacts added, select **Add**. Select *Enter ID manually*, *Search from server*, *Copy from server*, or *By mobile number*. When the contact is successfully added, the phone confirms it.
3. Scroll to a contact, and to start a conversation, select **Chat**.

Block and unblock messages

To block messages, connect to the instant messaging service, and select **Conversations** > *IM contacts*, or join or start a conversation. Scroll to the contact from whom you want to block incoming messages, and select **Options** > *Block contact* > **OK**.

To unblock messages, connect to the instant messaging service, and select *Blocked list*. Scroll to the contact from whom you want to unblock the messages, and select **Unblock**.

You can also unblock messages from the contact list.

Groups

You can create your own private groups for an instant messaging conversation, or use the public groups provided by the service provider. The private groups exist only during an instant messaging conversation. The groups are saved on the server of the service provider. If the server you are logged into does not support group services, all group-related menus are dimmed.

Public groups

You can bookmark public groups that your service provider may maintain. Connect to the instant messaging service, and select **Groups** > *Public groups*. Scroll to a group that you want to chat with, and select **Join**. If you are not in the group, write your screen name as your nickname for the group. To delete a group from your group list, select **Options** > *Delete group*.

To search for a group, select **Groups** > *Search groups*. You can search for a group by a member in the group or by group name, topic, or ID.

Messaging

Create a private group

Connect to the instant messaging service, and select [Groups > Create group](#). Enter the name for the group and the screen name that you want to use. Mark the private group members in the contacts list, and write an invitation.

■ E-mail application

The e-mail application uses (E)GPRS (network service) to allow you to access your e-mail account from your phone when you are not in the office or at home. This e-mail application is different from the SMS e-mail function. To use the e-mail function on your phone, you need a compatible e-mail system.

You can write, send, and read e-mail with your phone. You can also save and delete the e-mail on a compatible PC. Your phone supports POP3 and IMAP4 e-mail servers.

Before you can send and retrieve any e-mail messages, you must do the following:

- Obtain a new e-mail account or use your current account. To check the availability of your e-mail account, contact your e-mail service provider.
- Check your e-mail settings with your network operator or e-mail service provider. You may receive the e-mail configuration settings as a configuration message. See "Configuration settings service," p. 10. You can also enter the settings manually. See "Configuration," p. 70.

To activate the e-mail settings, select [Menu > Messaging > Message settings > E-mail messages](#). See "E-mail messages," p. 48.

This application does not support keypad tones.

Write and send an e-mail

You can write your e-mail message before connecting to the e-mail service, or connect to the service first, and then write and send your e-mail.

1. Select **Menu** > *Messaging* > *E-mail* > *Create e-mail*.
2. Enter the recipient's e-mail address, and select **OK**.
3. Write a subject for the e-mail, and select **OK**.
4. Write the e-mail message. See "Write text," p. 27.
To attach a file to the e-mail, select **Options** > *Attach* and a file from *Gallery*.
5. To send the e-mail message immediately, select **Send** > *Send now*.
To save the e-mail in the *Outbox* folder to be sent later, select **Send** > *Send later*.
To edit or continue writing your e-mail later, select **Options** > *Save draft*. The e-mail is saved in *Other folders* > *Drafts*.
To send the e-mail later, select **Menu** > *Messaging* > *E-mail* > **Options** > *Send now* or *Retrieve and send*.

Download e-mail

1. To access the e-mail application, select **Menu** > *Messaging* > *E-mail*.
2. To download e-mail messages that have been sent to your e-mail account, select *Retrieve*.
To download new e-mail messages and to send e-mail that has been saved in the *Outbox* folder, select **Options** > *Retrieve and send*.
To first download the headings of the new e-mail messages that have been sent to your e-mail account, select **Options** > *Check new e-mail*. Then, to download the selected e-mail, mark the desired ones, and select **Options** > *Retrieve*.
3. Select the new message in *Inbox*. To view it later, select **Back**.
 indicates an unread message.

Messaging

Read and reply to e-mail



Important: Exercise caution when opening messages. E-mail messages may contain malicious software or otherwise be harmful to your device or PC.

1. Select **Menu** > *Messaging* > *E-mail* > *Inbox* and the desired message.
2. While reading the message, select **Options** to view the available options.
3. To reply to an e-mail, select **Reply** > *Original text* or *Empty screen*. To reply to many, select **Options** > *Reply to all*. Confirm or edit the e-mail address and subject, then write your reply.
4. To send the message, select **Send** > *Send now*.

Inbox and Other folders

Your phone saves e-mail that you have downloaded from your e-mail account in the *Inbox* folder. *Other folders* contains the following folders: *Drafts* for saving unfinished e-mail, *Archive* for organizing and saving your e-mail, *Outbox* for saving e-mail that has not been sent, and *Sent items* for saving e-mail that has been sent.

To manage the folders and their e-mail content, select **Options** > *Manage folder*.

Delete e-mail messages

Select **Menu** > *Messaging* > *E-mail* > **Options** > *Manage folder* and the desired folder. Mark the messages that you want to delete, and select **Options** > *Delete*.

Deleting an e-mail from your phone does not delete it from the e-mail server. To set the phone to delete the e-mail also from the e-mail server, select **Menu** > *Messaging* > *E-mail* > **Options** > *Extra settings* > *Leave copy:* > *Delete retrieved msgs*.

■ Voice messages

The voice mailbox is a network service and you may need to subscribe to it. For more information and for your voice mailbox number, contact your service provider.

To call your voice mailbox, select **Menu** > *Messaging* > *Voice messages* > *Listen to voice messages*. To enter, search for, or edit your voice mailbox number, select *Voice mailbox number*.

If supported by the network,  indicates new voice messages. To call your voice mailbox number, select *Listen*.

■ Info messages

With the *Info messages* network service, you can receive messages on various topics from your service provider. To check availability, topics, and the relevant topic numbers, contact your service provider.

■ Service commands

Select **Menu** > *Messaging* > *Service commands*. Write and send service requests (also known as USSD commands), such as activation commands for network services, to your service provider.

■ Delete messages

To delete messages one by one, select **Menu** > *Messaging* > *Delete messages* > *By message* and the folder from which you want to delete messages. Scroll to the desired message, and select *Delete*. If one or more messages are marked, select *Mark*. Mark all the messages you want to delete, and select *Options* > *Delete marked*.

To delete all messages from a folder, select **Menu** > *Messaging* > *Delete messages* > *By folder* and the folder from which you want to delete the messages. Depending on the folder, the phone asks if you want to delete the messages. To delete, select *Yes*. Otherwise, if the folder contains unread messages or messages which are waiting to be sent, the phone asks whether you want to keep them. To keep these messages, select *Yes*.

Messaging

To delete all messages from all folders, select [Menu](#) > [Messaging](#) > [Delete messages](#) > [All messages](#) > [Yes](#).

■ Message settings

General settings

General settings are common for text and multimedia messages.

Select [Menu](#) > [Messaging](#) > [Message settings](#) > [General settings](#) and from the following options:

[Save sent messages](#) > [Yes](#) – to set the phone to save the sent messages in the [Sent items](#) folder

[Overwriting in sent items](#) > [Allowed](#) – to set the phone to overwrite the old sent messages with the new ones when the message memory is full. This setting is shown only if you set [Save sent messages](#) > [Yes](#).

[Font size](#) – to select the font size used in messages

[Graphical smileys](#) > [Yes](#) – to set the phone to replace character-based smileys with graphical ones

Text messages

The text message settings affect the sending, receiving, and viewing of text and SMS e-mail messages.

Select [Menu](#) > [Messaging](#) > [Message settings](#) > [Text messages](#) and from the following options:

[Delivery reports](#) > [Yes](#) – to ask the network to send delivery reports about your messages (network service)

[Message centres](#) > [Add centre](#) – to set the phone number and name of the message center that is required for sending text messages. You receive this number from your service provider. If you select [SIM message centre](#), you can view the SIM message center information.

[Message centre in use](#) – to select the message center in use

E-mail message centres > Add centre – to set the phone numbers and name of the e-mail center for sending SMS e-mails. If you select *SIM e-mail centre*, you can view the SIM e-mail center information.

E-mail centre in use – to select the SMS e-mail message center in use

Message validity – to select the length of time for which the network attempts to deliver your message

Messages sent via – to select the format of the messages to be sent: *Text, Paging, or Fax* (network service)

Use packet data > Yes – to set GPRS as the preferred SMS bearer

Character support > Full – to select all characters in the messages to be sent as viewed. If you select *Reduced*, characters with accents and other marks may be converted to other characters. When writing a message, you can check how the message will look to the recipient by previewing the message. See "Write and send SMS messages," p. 30.

Reply via same centre > Yes – to allow the recipient of your message to send you a reply using your message center (network service)

Multimedia messages

The message settings affect the sending, receiving, and viewing of multimedia messages.

You may receive the configuration settings for multimedia messaging as a configuration message. See "Configuration settings service," p. 10. You can also enter the settings manually. See "Configuration," p. 70.

Select *Menu > Messaging > Message settings > Multimedia messages* and from the following options:

Delivery reports > Yes – to ask the network to send delivery reports about your messages (network service)

Default slide timing – to define the default time between slides in multimedia messages

Allow multimedia receipt – to receive or block the multimedia message, select *Yes* or *No*. If you select *In home network*, you cannot receive multimedia messages when outside your home network. The default setting of the multimedia message service is generally *In home network*.

Messaging

Incoming multim. msgs. – to allow the reception of multimedia messages automatically, manually after being prompted, or to reject the reception. This setting is not shown if *Allow multimedia receipt.* is set to *No*.

Allow adverts – to receive or reject advertisements. This setting is not shown if *Allow multimedia receipt.* is set to *No*, or *Incoming multim. msgs.* is set to *Reject*.

Configuration settings > Configuration – only the configurations that support multimedia messaging are shown. Select a service provider, *Default*, or *Personal configuration* for multimedia messaging. Select *Account* and a multimedia messaging service account contained in the active configuration settings.

E-mail messages

The settings affect the sending, receiving, and viewing of e-mail.

You may receive the configuration settings for the e-mail application as a configuration message. See "Configuration settings service," p. 10. You can also enter the settings manually. See "Configuration," p. 70.

To activate the settings for the e-mail application, select **Menu** > *Messaging* > *Message settings* > *E-mail messages* and from the following options:

Configuration – Select the set that you want to activate.

Account – Select an account provided by the service provider.

My name – Enter your name or nickname.

E-mail address – Enter your e-mail address.

Include signature – You can define a signature that is automatically added to the end of your e-mail when you write your message.

Reply-to address – Enter the e-mail address to which you want the replies to be sent.

SMTP user name – Enter the name that you want to use for outgoing mail.

SMTP password – Enter the password that you want to use for outgoing mail.

M e s s a g i n g

Display terminal window – Select *Yes* to perform manual user authentication for intranet connections.

Incoming server type – Select *POP3* or *IMAP4*, depending on the type of e-mail system that you are using. If both types are supported, select *IMAP4*.

Incoming mail settings – Select available options for *POP3* or *IMAP4*.

7. Contacts



You can save names and phone numbers (contacts) in the phone memory and in the SIM card memory.

The phone memory may save contacts with additional details, such as various phone numbers and text items. You can also save an image for a limited number of contacts.

The SIM card memory can save names with one phone number attached to them. The contacts saved in the SIM card memory are indicated by .

■ Search for a contact

Select [Menu](#) > [Contacts](#) > [Names](#). Scroll through the list of contacts, or enter the first characters of the name you are searching for.

■ Save names and phone numbers

Names and numbers are saved in the used memory. To save a name and phone number, select [Menu](#) > [Contacts](#) > [Names](#) > [Options](#) > [Add new contact](#). Enter the last name, first name, and the phone number.

■ Save multiple numbers, text items, or an image

In the phone memory for contacts you can save different types of phone numbers, and short text items per name. You can also select the ringing tone for a contact.

The first number you save is automatically set as the default number, and it is indicated with a frame around the number type indicator (for example, ). When you select a name from contacts (for example, to make a call), the default number is used unless you select another number.

1. Make sure that the memory in use is [Phone](#) or [Phone and SIM](#).
2. Search for the contact to which you want to add a new number or text item, and select [Details](#) > [Options](#) > [Add detail](#).

3. To add a number, select *Number* and a number type.

To add another detail, select a text type, a ringing tone, an image from *Gallery*, or a new image.

To search for an ID from the server of your service provider if you have connected to the presence service, select *User ID* > *Search*. See "My presence," p. 52. If only one ID is found, it is automatically saved. Otherwise, to save the ID, select *Options* > *Save*. To enter the ID, select *Enter ID manually*. Enter the ID, and select *OK* to save it.

To change the number type, scroll to the desired number, and select *Options* > *Change type*. To set the selected number as the default number, select *Set as default*.

4. Enter the number or text item; to save it, select *Save*.

■ Copy contacts

Search for the contact you want to copy, and select *Options* > *Copy*. You can copy names and phone numbers from the phone contact memory to the SIM card memory, or vice versa. The SIM card memory can save names with one phone number attached to them.

■ Edit contact details

Search for the contact you want to edit, and select *Details*. To edit a name, number, text item, or to change the image, select *Options* > *Edit*. You cannot edit an ID when it is on the *IM contacts* or *Subscribed names* list.

■ Delete contacts

To delete all the contacts and the details attached to them from the phone or SIM card memory, select *Menu* > *Contacts* > *Delete all contacts* > *From phone memory* or *From SIM card*. Confirm with the security code.

To delete a contact, search for the desired contact, and select *Options* > *Delete contact*.

C o n t a c t s

To delete a number, text item, or an image attached to the contact, search for the contact, and select **Details**. Scroll to the desired detail, and select **Options** > **Delete** > **Delete number**, **Delete detail**, or **Delete image**. Deleting an image from contacts does not delete it from *Gallery*.

■ My presence

With the presence service (network service) you can share your presence status with other users with compatible devices and access to the service, such as your family, friends, and colleagues. Presence status includes your availability, status message, and personal logo. Other users who have access to the service and who request your information are able to see your status. The requested information is shown in *Subscribed names* in the viewers' *Contacts* menu. You can personalize the information that you want to share with others and control who can see your status.

Before you can use presence, you must subscribe to the service. To check the availability and costs, and to subscribe to the service, contact your network operator or service provider, from whom you also receive your unique ID, password, and the settings for the service. See "Configuration," p. 70.

While you are connected to the presence service, you can use the other functions of the phone, and the presence service is active in the background. If you disconnect from the service, your presence status is shown for a certain amount of time to viewers, depending on the service provider.

Select **Menu** > **Contacts** > **My presence** and from the following options: **Connect to 'My presence'** or **Disconnect from service** — to connect to or disconnect from the service

View my presence > **Private presence** or **Public presence** — to view your presence status

Edit my presence > **My availability**, **My presence message**, **My presence logo**, or **Show to** — to change your presence status

My viewers > *Current viewers*, *Private list*, or *Blocked list* – to view the persons who are subscribed to or blocked from your presence information

Settings > *Show current pres. in idle*, *Connection type*, or *IM and my presence sett.*

■ Subscribed names

You can create a list of contacts whose presence status information you want to be aware of. You can view the information if it is allowed by the contacts and the network. To view these subscribed names, scroll through the contacts, or use the *Subscribed names* menu.

Ensure that the memory in use is *Phone* or *Phone and SIM*.

To connect to the presence service, select *Menu* > *Contacts* > *My presence* > *Connect to 'My presence'*.

Add contacts to the subscribed names

1. Select *Menu* > *Contacts* > *Subscribed names*. If you have not connected to the presence service, the phone asks if you want to connect now.
2. If you have no contacts on your list, select *Add*. Otherwise, select *Options* > *Subscribe new*. Your list of contacts is shown.
3. Select a contact from the list. If the contact has a saved ID, the contact is added to the subscribed names list. If there is more than one ID, select one of them. After subscription to the contact, *Subscription activated* is shown.



Tip: To subscribe to a contact from the *Contacts* list, search for the contact you want, and select *Details* > *Options* > *Request presence* > *As subscription*.

If you only want to view the presence information but not to subscribe to a contact, select *Request presence* > *One time only*.



View the subscribed names

To view the presence information, see also "Search for a contact," p. 50.

C o n t a c t s

1. Select **Menu** > **Contacts** > **Subscribed names**.

The status information of the first contact on the subscribed names list is displayed. The information that the person wants to make available to others may include text and an icon.

, , or  indicates that the person is available, not visible to others, or not available.

 indicates that the person's presence information is not available.

2. Select **Options** > **View details** to view the details of the selected contact; or select **Options** > **Subscribe new**, **Send message**, **Send business card**, or **Unsubscribe**.

Unsubscribe a contact

To unsubscribe a contact from the **Contacts** list, select the contact and **Options** > **Unsubscribe** > **OK**.

To unsubscribe from the **Subscribed names** menu, see "View the subscribed names," p. 53.

Business cards

You can send and receive a person's contact information from a compatible device that supports the vCard standard as a business card.

To send a business card, search for the contact whose information you want to send, and select **Details** > **Options** > **Send business card** > **Via multimedia**, **Via text message**, **Via infrared**, or **Via Bluetooth**.

When you receive a business card, select **Show** > **Save** to save the business card in the phone memory. To discard the business card, select **Exit** > **Yes**.

Settings

Select **Menu** > **Contacts** > **Settings** and from the following options: **Memory in use** — to select the SIM card or phone memory for your contacts. Select **Phone and SIM** to recall names and number from both memories. In that case, when you save names and numbers, they are saved in the phone memory.

Contacts view – to select how the names and numbers in *Contacts* are displayed

Name display – to select whether the contact's first or last name is displayed first

Font size – to set the font size for the list of contacts

Memory status – to view the free and used memory capacity

■ Groups

Select *Menu* > *Contacts* > *Groups* to arrange the names and phone numbers saved in the memory into caller groups with different ringing tones and group images.

■ Speed dials

To assign a number to a speed-dialing key, select *Menu* > *Contacts* > *Speed dials*, and scroll to the speed-dialing number that you want.

Select *Assign*, or if a number has already been assigned to the key, select *Options* > *Change*. Select *Search* and the contact you want to assign. If the *Speed dialling* function is off, the phone asks whether you want to activate it. See also *Speed dialling* in "Call," p. 68.

To make a call using the speed-dialing keys, see "Speed dialing," p. 24.

■ Service and my numbers

Select *Menu* > *Contacts* and from the following options:

Service numbers – to call the service numbers of your service provider if the numbers are included on your SIM card (network service)

My numbers – to view the phone numbers assigned to your SIM card. This is only shown if the numbers are included on your SIM card.

8. Call log



The phone registers your missed, received, and dialed calls if the network supports it and the phone is switched on and within the network service area.

To view the information on your calls, select **Menu > Log > Missed calls**, **Received calls**, or **Dialled numbers**. To view your recent missed and received calls and the dialed numbers chronologically, select **Call log**. To view the contacts to whom you most recently sent messages, select **Message recipients**.

To view the approximate information on your recent communications, select **Menu > Log > Call duration**, **Packet data counter**, or **Packet data timer**.

To view how many text and multimedia messages you have sent and received, select **Menu > Log > Message counter**.



Note: The actual invoice for calls and services from your service provider may vary, depending on network features, rounding off for billing, taxes, and so forth.



Note: Some timers, including the life timer, may be reset during service or software upgrades.

■ Positioning information

The network may send you a location request. You can ensure that the network will deliver location information of your phone only if you approve it (network service). Contact your network operator or service provider to subscribe and to agree upon the delivery of location information.

To accept or reject the location request, select **Accept** or **Reject**. If you miss the request, the phone automatically accepts or rejects it according to what you have agreed with your network operator or service provider. The phone displays **1 missed position request**. To view the missed location request, select **Show**.

Call log

To view the information on the 10 most recent privacy notifications and requests or to delete them, select [Menu](#) > [Log](#) > [Positioning](#) > [Position log](#) > [Open folder](#) or [Delete all](#).

9. Settings



■ Profiles

Your phone has various setting groups, called profiles, for which you can customize the phone tones for different events and environments.

Select **Menu** > [Settings](#) > [Profiles](#) and the desired profile. Select from the following options:

[Activate](#) – to activate the selected profile

[Personalise](#) – to personalize the profile. Select the setting you want to change, and make the changes.

[Timed](#) – to set the profile to be active until a certain time up to 24 hours, and set the end time. When the time set for the profile expires, the previous profile that was not timed becomes active.

■ Themes

A theme contains many elements for personalizing your phone, such as wallpaper, screen saver, color scheme, and a ringing tone.

Select **Menu** > [Settings](#) > [Themes](#) and from the following options:

[Select theme](#) – to set a theme in your phone. A list of folders in [Gallery](#) opens. Open the [Themes](#) folder, and select a theme.

[Theme downloads](#) – to open a list of links to download more themes

■ Tones

You can change the settings of the selected active profile.

Select **Menu** > [Settings](#) > [Tones](#) > [Incoming call alert](#), [Ringing tone](#), [Ringing volume](#), [Vibrating alert](#), [Voice options](#), [Notification tone](#), [Callback tone](#), [Message alert tone](#), [Instant msg. alert tone](#), [Keypad tones](#), or [Warning tones](#). You can find the same settings in the [Profiles](#) menu; see "Profiles," p. 58. [Voice options](#), [Notification tone](#), and [Callback tone](#) are push to talk settings.

To set the phone to ring only upon calls from phone numbers that belong to a selected caller group, select *Alert for*. Scroll to the caller group you want or *All calls*, and select *Mark*.

■ Display

With display settings you can personalize your phone display view.

Standby mode settings

Select *Menu* > *Settings* > *Display* > *Standby mode settings* and from the following options:

Active standby > *My active standby* – to display the active standby.

Select *Options* and from the following options:

- *Personalise* – to change the content. To remove the content, select *(empty)*.
- *Organise* – to reorganize the content on the display
- *Enabling active standby* – to change the key for accessing the navigation mode. The same setting is also in the *My shortcuts* menu. See "Enabling active standby," p. 61.

Wallpaper – to set your phone to display an image or a slide as wallpaper when the phone is in the standby mode. Select *Wallpapers* > *Image* or *Slide set* and an image or a slide from *Gallery*. To download more graphics, select *Graphic downloads*.

Idle state font colour – to select the color for the texts on the display in the standby mode

Navigation key icons – to set the scroll key icons that are shown in the standby mode

Operator logo – to set your phone to display or hide the operator logo

Cell info display > *On* – to receive information from the network operator depending on the network cell used (network service)

Settings

Screen saver

To select a screen saver from *Gallery*, select **Menu** > *Settings* > *Display* > *Screen saver*. Select *Screen savers* > *Image*, *Slide set*, *Video clip*, or *Open camera*. To download more screen savers, select *Graphic downloads*. To select the time after which the screen saver is activated, select *Time-out*. To activate the screen saver, select *On*.

Power saver

To save some battery power, select **Menu** > *Settings* > *Display* > *Power saver*. A digital clock is displayed when no function of the phone is used for a certain time.

Font size

To set the font size for reading and writing messages, and viewing contacts and Web pages, select **Menu** > *Settings* > *Display* > *Font size*.

■ Time and date

To change the time and date settings, and to set the phone to show or hide the time and date in the standby mode, select **Menu** > *Settings* > *Time and date* > *Clock*, *Date*, or *Auto-update of date/time* (network service).

■ My shortcuts

With personal shortcuts you get quick access to often used functions of the phone.

Left selection key

To select a function from the list for the left selection key, select **Menu** > *Settings* > *My shortcuts* > *Left selection key*. See also "Standby mode," p. 19.

To activate a function in the standby mode if the left selection key is **Go to**, select **Go to** and the desired function on your personal shortcut list.

Select **Options** and from the following options:

Select options – to add a function to the shortcut list, or to remove one.

Scroll to the function, and select **Mark** or **Unmark**.

Organise – to rearrange the functions on your personal shortcut list.

Scroll to the function you want to move, and select **Move**. Scroll to where you want to move the function, and select **OK**.

Right selection key

To select a function from the list for the right selection key, select

Menu > **Settings** > **My shortcuts** > **Right selection key**. See also

"Standby mode," p. 19.

Navigation key

To select shortcut functions for the scroll keys, select **Menu** >

Settings > **My shortcuts** > **Navigation key**. Scroll to the desired key,

select **Change** and a function from the list. To remove a shortcut

function from the key, select **(empty)**. To reassign a function for the key,

select **Assign**. See "Standby mode shortcuts," p. 21.

Enabling active standby

To select the key to access the active standby navigation mode, select

Menu > **Settings** > **My shortcuts** > **Enabling active standby** >

Navigation key up, **Navigation key down**, or **Navigation key up/down**.

Voice commands

You can call contacts and carry out phone functions by saying voice commands. Voice commands are language-dependent. To set the language, see **Voice playback language** in "Phone," p. 69.

To select the phone functions to activate with a voice command, select

Menu > **Settings** > **My shortcuts** > **Voice commands** and a folder. Scroll

to a function.  indicates that the voice tag is activated. To deactivate

the voice command, select **Options** > **Remove**. To activate the voice tag,

select **Add**. To play the activated voice command, select **Play**. To use

voice commands, see "Enhanced voice dialing," p. 24.

Settings

To manage the voice commands, scroll to a phone function, and select from the following options:

Edit or *Remove* – to change or deactivate the voice command of the selected function

Add all or *Remove all* – to activate or deactivate voice commands to all functions in the voice commands list.

■ Connectivity

You can connect the phone to a compatible device using an infrared, Bluetooth wireless technology, or USB data cable (CA-53) connection. You can also define the settings for (E)GPRS dial-up connections.

Bluetooth wireless technology

This device is compliant with Bluetooth Specification 2.0 supporting the following profiles: hands-free, headset, object push profile, file transfer profile, dial-up networking profile, SIM access profile, serial port profile, and human interface device profile. To ensure interoperability between other devices supporting Bluetooth technology, use Nokia approved enhancements for this model. Check with the manufacturers of other devices to determine their compatibility with this device.

There may be restrictions on using Bluetooth technology in some locations. Check with your local authorities or service provider.

Features using Bluetooth technology, or allowing such features to run in the background while using other features, increase the demand on battery power and reduce the battery life.

Bluetooth technology allows you to connect the phone to a compatible Bluetooth device within 10 meters (32 feet). Since devices using Bluetooth technology communicate using radio waves, your phone and the other devices do not need to be in direct line-of-sight, although the connection can be subject to interference from obstructions such as walls or from other electronic devices.

Set up a Bluetooth connection

Select **Menu** > *Settings* > *Connectivity* > *Bluetooth* and from the following options:

Bluetooth > *On* or *Off* – to activate or deactivate the Bluetooth function.  indicates an active Bluetooth connection.

Search for audio enhanc. – to search for compatible Bluetooth audio devices. Select the device that you want to connect to the phone.

Paired devices – to search for any Bluetooth device in range. Select **New** to list any Bluetooth device in range. Scroll to a device, and select **Pair**. Enter the Bluetooth passcode of the device to associate (pair) the device to your phone. You must only give this passcode when you connect to the device for the first time. Your phone connects to the device, and you can start data transfer.

Bluetooth wireless connection

Select **Menu** > *Settings* > *Connectivity* > *Bluetooth*. To check which Bluetooth connection is currently active, select *Active devices*. To view a list of Bluetooth devices that are currently paired with the phone, select *Paired devices*.

Select **Options** to access available options depending on the status of the device and the Bluetooth connection.

Bluetooth settings

To define how your phone is shown to other Bluetooth devices, select **Menu** > *Settings* > *Connectivity* > *Bluetooth* > *Bluetooth settings* > *My phone's visibility* or *My phone's name*.

Operating the phone in hidden mode is a safer way to avoid malicious software.

Do not accept Bluetooth connectivity from sources you do not trust.

Another alternative – switch off the Bluetooth functionality. This will not affect other functionalities of the phone.

Settings

Infrared

You can set up the phone to send and receive data through its infrared (IR) port. To use an IR connection, the device with which you want to establish a connection must be IrDA compliant. You can send or receive data to or from a compatible phone or data device (for example, a computer) through the IR port of your phone.

Do not point the IR (infrared) beam at anyone's eye or allow it to interfere with other IR devices. This device is a Class 1 laser product.

When sending or receiving data, ensure that the IR ports of the sending and receiving devices are pointing at each other and that there are no obstructions between the devices.

To activate the IR port of your phone, select **Menu > Settings > Connectivity > Infrared**.

To deactivate the IR connection, select **Menu > Settings > Connectivity > Infrared**. When the phone displays *Deactivate infrared?*, select **Yes**.

If data transfer is not started within 2 minutes after the activation of the IR port, the connection is canceled and must be started again.

IR connection indicator

When **IR** is shown continuously, the IR connection is activated, and your phone is ready to send or receive data through its IR port.

When **IR** blinks, your phone is trying to connect to the other device, or a connection has been lost.

Packet data

General packet radio service (GPRS) is a network service that allows mobile phones to send and receive data over an Internet protocol (IP)-based network. GPRS is a data bearer that enables wireless access to data networks such as the Internet.

Enhanced GPRS (EGPRS) is similar to GPRS but enables faster connections. For more information on availability of (E)GPRS and data transfer speed, contact your network operator or service provider.

The applications that may use (E)GPRS are MMS, video streaming, browsing sessions, e-mail, remote SyncML, Java application downloading, and the PC dial-up.

When you have selected GPRS as a data bearer, the phone uses EGPRS instead of GPRS if this is available in the network. You cannot select between EGPRS and GPRS, but for some applications you may be able to select GPRS or *GSM data* (circuit switched data, CSD).

Packet data connection

Select **Menu** > *Settings* > *Connectivity* > *Packet data* > *Packet data connection*, and from the following options:

- *When needed* to register and establish an (E)GPRS connection when an application using (E)GPRS needs it, and to close the connection when you end the application.
- *Always online* to set the phone to automatically register to an (E)GPRS network when you switch on the phone. **G** or **E** indicates that the GPRS or EGPRS service is available.

If you receive a call or a text message, or make a call during a GPRS or EGPRS connection, **G** or **E** indicates that the GPRS or EGPRS connection is suspended (on hold).

Packet data settings

You can connect the phone using Bluetooth wireless technology, infrared, or USB data cable connection to a compatible PC and use the phone as a modem to enable (E)GPRS connectivity from the PC.

To define the settings for (E)GPRS connections from your PC, select **Menu** > *Settings* > *Connectivity* > *Packet data* > *Packet data settings* > *Active access point*, and activate the access point you want to use. Select *Edit active access point* > *Alias for access point*, enter a name to change the access point settings, and select **OK**. Select *Packet data access point*, enter the access point name (APN) to establish a connection to an (E)GPRS network, and select **OK**.

You can also set the (E)GPRS dial-up service settings (access point name) on your PC using the Nokia Modem Options software. See "Nokia

Settings

PC Suite," p. 104. If you have set the settings both on your PC and on your phone, the PC settings are used.

Data transfer

Synchronize your calendar, contacts data, and notes with another compatible device (for example, a mobile phone), a compatible PC, or a remote Internet server (network service).

Your phone allows data transfer with a compatible PC or another compatible device when using the phone without a SIM card. Note that when you use the phone without a SIM card, some functions appear dimmed in the menus and cannot be used. Synchronizing with a remote Internet server is not possible without a SIM card.

Partner list

To copy or synchronize data from your phone, the name of the device and the settings must be in the list of partners in transfer contacts. If you receive data from another device (for example, a compatible mobile phone), the partner is automatically added to the list, using the contact data from the other device. *Server synchronisation* and *PC synchronisation* are the original items in the list.

To add a new partner to the list (for example a new device), select **Menu** > **Settings** > **Connectivity** > **Data transfer** > **Options** > **Add transfer contact** > **Phone synchronisation** or **Phone copy**, and enter the settings according to the transfer type.

To edit the copy and synchronize settings, select a contact from the partner list and **Options** > **Edit**.

To delete a partner, select a contact from the partner list and **Options** > **Delete**, and confirm **Delete transfer contact?** You cannot delete *Server synchronisation* or *PC synchronisation*.

Data transfer with a compatible device

For synchronization, Bluetooth wireless technology or infrared is used. The other device is in the standby mode.

To start data transfer, select **Menu > Settings > Connectivity > Data transfer** and the transfer partner from the list, other than *Server synchronisation* or *PC synchronisation*. According to the settings, the selected data is copied or synchronized. The other device also must be activated for receiving data.

Synchronize from a compatible PC

Before you synchronize data from calendar, notes, and contacts from a compatible PC, you must install the Nokia PC Suite software of your phone on the PC. Use Bluetooth wireless technology, infrared, or a USB data cable for the synchronization, and start the synchronization from the PC.

Synchronize from a server

To use a remote Internet server, you must subscribe to a synchronization service. For more information and the settings required for this service, contact your service provider. You may receive the settings as a configuration message. See "Configuration settings service," p. 10 and "Configuration," p. 70.

If you have saved data on the remote Internet server, to synchronize your phone, start the synchronization from your phone.

Select **Menu > Settings > Connectivity > Data transfer > Server synchronisation**. Depending on the settings, select *Initialising synchronisation* or *Initialising copy*.

Synchronizing for the first time or after an interrupted synchronization may take up to 30 minutes to complete, if the contacts or calendar are full.

USB data cable

You can use the USB data cable to transfer data between the memory card inserted in the phone and a compatible PC or a printer supporting PictBridge. You can also use the USB data cable with Nokia PC Suite.

Settings

To activate the memory card for data transfer or picture printing, connect the data cable; when the phone displays *USB data cable connected*, select *Select mode*, select **OK**. Select from the following modes:

Default mode – to use the cable for PC Suite

Printing – to print pictures directly from the phone using a compatible printer

Data storage – to activate the memory card for data transfer

To change the USB mode, select **Menu** > *Settings* > *Connectivity* > *USB data cable* > *Default mode*, *Printing*, or *Data storage*.

■ Call

Select **Menu** > *Settings* > *Call* and from the following options:

Call divert – to divert your incoming calls (network service). You may not be able to divert your calls if some call barring functions are active. See *Call barring service* in "Security," p. 71.

Anykey answer > *On* – to answer an incoming call by briefly pressing any key, except the power key, the left and right selection keys, PTT key, camera key, or the end key

Automatic redial > *On* – to make a maximum of 10 attempts to connect the call after an unsuccessful call attempt

Speed dialling > *On* – to dial the names and phone numbers assigned to the speed-dialling keys 2 to 9 by pressing and holding the corresponding number key

Call waiting > *Activate* – to have the network notify you of an incoming call while you have a call in progress (network service). See "Call waiting," p. 26.

Summary after call > *On* – to briefly display the approximate duration and cost (network service) of the call after each call

Send my caller ID > *Yes* – to show your phone number to the person you are calling (network service). To use the setting agreed upon with your service provider, select *Set by network*.

Line for outgoing calls – to select the phone line 1 or 2 for making calls if supported by your SIM card (network service).

Slide call handling – to set the phone to answer calls when you open the slide, or end the calls when you close it.

■ Phone

Select *Menu* > *Settings* > *Phone* and from the following options:

Language settings – to set the display language of your phone, select *Phone language*. If you select *Automatic*, the phone selects the language according to the information on the SIM card.

To select the USIM card language, select *SIM language*.

To set a language for the voice playback, select *Voice playback language*. See "Make a voice dialing call," p. 25 and *Voice commands* in "My shortcuts," p. 60.

Security keyguard – to set the phone to ask for the security code when you unlock the keyguard. Enter the security code, and select *On*.

Automatic keyguard – to set the keypad of your phone to lock automatically after a preset time delay when the phone is in the standby mode and no function of the phone has been used. Select *On*, and set the time.

When the keyguard is on, calls still may be possible to the official emergency number programmed into your device.

Welcome note – to write the note you would like to be shown briefly when the phone is switched on

Operator selection > *Automatic* – to set the phone to automatically select one of the cellular networks available in your area. With *Manual* you can select a network that has a roaming agreement with your home network operator.

Confirm SIM serv. actions – See "SIM services," p. 103.

Help text activation – to select whether the phone shows help texts

Start-up tone – to select whether the phone plays a tone when the phone is switched on

Settings

■ Enhancements

This menu is shown only if the phone is or has been connected to a compatible mobile enhancement.

Select [Menu](#) > [Settings](#) > [Enhancements](#). Depending on the enhancement, you can select some of the following options:

[Default profile](#) – to select the profile that you want to be automatically activated when you connect to the selected enhancement

[Automatic answer](#) – to set the phone to answer an incoming call automatically after 5 seconds. If [Incoming call alert](#) is set to [Beep once](#) or [Off](#), automatic answer is off.

[Lights](#) – to set the lights permanently [On](#). Select [Automatic](#) to set the lights on for 15 seconds after a key press.

[Ignition detector](#) > [On](#) – to automatically switch off the phone about 20 seconds after you switch off the car ignition, when the phone is connected to the full car kit

[Text phone](#) > [Use text phone](#) > [Yes](#) – to use text phone settings instead of headset or loopset settings

■ Configuration

You can configure your phone with settings that are required for certain services to function correctly. The services are multimedia messaging, instant messaging, synchronization, e-mail application, streaming, push to talk, and browser. Your service provider may also send you these settings. See "Configuration settings service," p. 10.

For information on availability and the appropriate configuration settings, contact your network operator or service provider.

Select [Menu](#) > [Settings](#) > [Configuration](#) and from the following options:

[Default config. settings](#) – to view the service providers saved in the phone. Scroll to a service provider, and select [Details](#) to view the applications that the configuration settings of this service provider support. To set the configuration settings of the service provider as

default settings, select **Options** > *Set as default*. To delete configuration settings, select *Delete*.

Activ. default in all apps. – to activate the default configuration settings for supported applications

Preferred access point – to view the saved access points. Scroll to an access point, and select **Options** > *Details* to view the name of the service provider, data bearer, and packet data access point or GSM dial-up number.

Connect to serv. support – to download the configuration settings from your service provider if this is supported by the service provider.

Personal config. settings – to add new personal accounts for various services, and to activate or delete them. To add a new personal account if you have not added any, select **Add**; otherwise, select **Options** > *Add new*. Select the service type, and select and enter each of the required parameters. The parameters differ according to the selected service type. To delete or activate a personal account, scroll to it, and select **Options** > *Delete* or *Activate*.

■ Security

When security features that restrict calls are in use (such as call barring, closed user group, and fixed dialing) calls still may be possible to the official emergency number programmed into your device.

Select **Menu** > **Settings** > **Security** and from the following options:

PIN code request and *UPIN code request* – to set the phone to ask for your PIN or UPIN code every time the phone is switched on. Some SIM cards do not allow the code request to be turned off.

PIN2 code request – to select whether the PIN2 code is required when using a specific phone feature which is protected by the PIN2 code. Some SIM cards do not allow the code request to be turned off.

Call barring service – to restrict incoming calls to and outgoing calls from your phone (network service). A barring password is required.

Fixed dialling – to restrict your outgoing calls to selected phone numbers if this function is supported by your SIM card

Settings

[Closed user group](#) – to specify a group of people whom you can call and who can call you (network service)

[Security level](#) > [Phone](#) – to set the phone to ask for the security code whenever a new SIM card is inserted into the phone. If you select [Memory](#), the phone asks for the security code when the SIM card memory is selected, and you want to change the memory in use.

[Access codes](#) – to change the security code, PIN code, UPIN code, PIN2 code, or barring password

[Code in use](#) – to select whether the PIN code or UPIN code should be active

[Authority certificates](#) or [User certificates](#) – to view the list of the authority or user certificates downloaded into your phone. See "Certificates," p. 101.

[Security module settings](#) – to view [Security module details](#), activate [Module PIN request](#), or change the module PIN and signing PIN. See also "Access codes," p. 9.

■ Restore factory settings

To reset some of the menu settings to their original values, select [Menu](#) > [Settings](#) > [Restore factory sett.](#). Enter the security code. The data you have entered or downloaded, such as names and phone numbers saved in [Contacts](#), are not deleted.

10. Operator menu

This menu lets you access a portal to services provided by your network operator. The name and the icon depend on the operator. For more information, contact your network operator. If this menu is not shown, the other menu numbers change accordingly.

The operator can update this menu with a service message. For more information, see "Service inbox," p. 99.

11. Gallery



In this menu you can manage graphics, images, recordings, and tones. These files are arranged in folders.

Your phone supports an activation key system to protect acquired content. Always check the delivery terms of any content and activation key before acquiring them, as they may be subject to a fee.

The files stored in *Gallery* use a memory that may have a capacity of about 5 MB in the phone. You can use a compatible memory card to extend the memory capacity to store images, themes, graphics, ringing tones, video clips, and sound clips in *Gallery*.

To manage the files and folders:

1. Select **Menu** > *Gallery*. A list of folders is shown. If a memory card is inserted in the phone, the folder *Memory card, (unformatted)*, or the name of the memory card is shown.
2. Scroll to the desired folder. To view a list of files in the folder, select **Open**. For the available options, select **Options**.
3. Scroll to the file you want to view, and select **Open**. For the available options, select **Options**.

Copyright protections may prevent some images, music (including ringing tones), and other content from being copied, modified, transferred or forwarded.

■ Format memory card

To format a new memory card, select **Menu** > *Gallery*. Scroll to the memory card folder, and select **Options** > *Format memory card*.

12. Media



■ Camera

You can take photos or record video clips with the built-in camera. The camera produces pictures in .jpg format and video clips in .3gp format.

Take a photo

Keep a safe distance when using the flash. Do not use the flash on people or animals at close range. Do not cover the flash while taking a picture.

- To open the camera viewfinder, select **Menu** > **Media** > **Camera**.
If **Video** is selected as the default mode, select **Options** > **Still image**.
To zoom in or out, press the volume key up or down.
If the lighting is dim, or to use the camera flash, select **Options** > **Night mode on** or **Flash on**.
To take up to four photos in quick succession, select **Options** > **Img. sequence on**. The higher the resolution, the fewer photos you can take sequentially.
- Turn the phone counterclockwise (1), and to take a photo, press the camera key (2), or select **Capture**. If you take sequential photos, select **Sequence**. The phone saves the photo in **Gallery** > **Images** or unless you set the phone to use the memory card for saving the photos.
- To take another photo, select **Options** > **New image**; to send the photo as a multimedia message, select **Options** > **Send**.

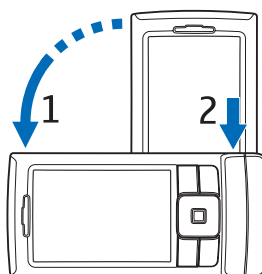

Tip: To activate the camera, press the camera key.

The Nokia 6270 device supports an image capture resolution of 1600 x 1200 pixels. The image resolution in these materials may appear different.

Media

Record a video clip

Select [Menu](#) > [Media](#) > [Camera](#) > [Options](#) > [Video](#) > [Record](#). To pause the recording, select [Pause](#); to resume the recording, select [Continue](#). To stop the recording, select [Stop](#). The phone saves the recording in [Gallery](#) > [Video clips](#). To change the folder for saving the recordings, see "Camera settings," p. 76.

Camera settings

Select [Menu](#) > [Media](#) > [Camera](#) > [Options](#) > [Settings](#). You can define [Image quality](#), [Image size](#), [Video clip quality](#), [Video clip length](#), [Camera sounds](#), [Default title](#), [Image and video storage](#), and [Default mode](#). In [Image and video storage](#) you can select the folder or memory card to save your photos and video clips.

■ [Media player](#)

With the media player you can view, play, and download files, such as images, audio, video, and animated images. You can also view compatible streaming videos from a network server (network service).

Select [Menu](#) > [Media](#) > [Media player](#) > [Open gallery](#), [Bookmarks](#), [Go to address](#), or [Media downloads](#).

Set up the phone for a streaming service

You may receive the configuration settings required for streaming as a configuration message from the network operator or service provider. See "Configuration settings service," p. 10. You can also enter the settings manually. See "Configuration," p. 70.

To activate the settings:





1. Select [Menu](#) > [Media](#) > [Media player](#) > [Streaming settings](#).
2. Select [Configuration](#). Only the configurations that support streaming are shown. Select a service provider, [Default](#), or [Personal configuration](#) for streaming.
3. Select [Account](#) and a streaming service account contained in the active configuration settings.

■ Music player

Your phone includes a music player for listening to music tracks, recordings, or other .mp3, .mp4, or .aac format sound files that you have transferred to the phone with the Nokia Audio Manager application. .mp3, .mp4 and .aac format files are stored in the memory card or in the *Gallery* folders. Music files saved in the *Music files* folder and in another location, such as a folder of the memory card, are automatically detected and added to the default track list.



Play the music tracks transferred to the phone



1. Select **Menu** > **Media** > **Music player**. The details of the first track on the default track list are shown.

To use the graphical keys , , , or  on the display, scroll left or right to the desired key, and select it.

2. To play a track, scroll to the track that you want, and select .

To adjust the volume level, use the volume keys on the side of the phone.

To skip to the beginning of the next track, select . To skip to the beginning of the previous track, select  twice.

To rewind the current track, select and hold . To fast forward the current track, select and hold . Release the key at the position you want.

3. To stop the playing, select .



Warning: Listen to music at a moderate level. Continuous exposure to high volume may damage your hearing. Do not hold the device near your ear when the loudspeaker is in use, because the volume may be extremely loud.

Music player settings

In the *Music player* menu, the following options may be available:

Play via bluetooth – to make a connection to an audio enhancement using a Bluetooth connection

Media

Track list – to view all the tracks available on the track list. To play a track, scroll to the desired track, and select **Play**.

Select **Options** > **Refresh all tracks** or **Change track list** to refresh the track list (for example, after adding new tracks to the list) or to change the track list that is shown when you open the **Music player** menu, if several track lists are available in the phone.

Play options > **Random** > **On** – to play the tracks in the track list in random order. Select **Repeat** > **Current track** or **All tracks** to play the current track or the entire track list repeatedly.

Media equaliser – to open the list of media equalizer sets. See "Equalizer," p. 81.

Loudspeaker or **Headset** – to listen to the music player through the loudspeaker or a compatible headset connected to the phone



Tip: When using a headset, to skip to the next track, press the headset key.

Send – to send the selected file using MMS, Bluetooth wireless technology, or an infrared connection

Music downloads – to connect to a browser service related to the current track. This function is only available when the address of the service is included in the track.

Memory status – to view the free and used memory capacity

Radio

The FM radio depends on an antenna other than the wireless device's antenna. A compatible headset or enhancement needs to be attached to the device for the FM radio to function properly.







Warning: Listen to music at a moderate level. Continuous exposure to high volume may damage your hearing. Do not hold the device near your ear when the loudspeaker is in use, because the volume may be extremely loud.



Select **Menu** > **Media** > **Radio**.

To use the graphical keys ▲, ▼, ◀, or ▶ on the display, scroll left or right to the desired key, and select it.

Save radio channels

1. To start the channel search, select and hold  or . To change the radio frequency in 0.05 MHz steps, briefly press  or .
2. To save the channel to a memory location, 1 to 9, press and hold the corresponding number key. To save the channel to a memory location from 10 to 20, press briefly 1 or 2, and press and hold the desired number key, 0 to 9.
3. Enter the name of the channel, and select **OK**.

Listen to the radio

Select **Menu > Media > Radio**. To scroll to the desired channel, select  or , or press the headset key. To select a radio channel location, briefly press the corresponding number keys. To adjust the volume, press the volume keys.

Select from the following options:

Switch off – to turn off the radio

Save station – to enter a channel name and save the new channel

Visual Radio – to set whether the Visual Radio application is used (network service). To check the availability and costs, contact your network operator or service provider. Some radio channels may send text or graphical information that you can view using the Visual Radio application.

Visual Radio settings – to select the options for Visual Radio. To set whether the Visual Radio application starts automatically when you turn on the radio, select **Enable visual service > Automatically**.

Stations – to select the list of saved channels. To delete or rename a channel, scroll to the desired channel, and select **Options > Delete station** or **Rename**.

Mono output or **Stereo output** – to listen to the radio in monophonic sound or in stereo

Loudspeaker or **Headset** – to listen to the radio using the loudspeaker or headset. Keep the headset connected to the phone. The lead of the headset functions as the radio antenna.

Media

Set frequency – to enter the frequency of the desired radio channel

You can normally make a call or answer an incoming call while listening to the radio. During the call, the volume of the radio is muted.

When an application using a packet data or HSCSD connection is sending or receiving data, it may interfere with the radio.

■ Voice recorder

You can record pieces of speech, sound, or an active call, and save them in *Gallery* or a memory card. This is useful when recording a name and phone number to write down later.

The recorder cannot be used when a data call or GPRS connection is active.

Record sound

1. Select **Menu** > *Media* > *Voice recorder*.

To use the graphical keys ●, ■, or ■ on the display, scroll left or right to the desired key, and select it.

2. To start the recording, select ●. To start the recording during a call, select **Options** > *Record*. While recording a call, all parties to the call hear a faint beeping sound. When recording a call, hold the phone in the normal position near to your ear.

3. To end the recording, select ■. The recording is saved in *Gallery* > *Recordings*.

4. To listen to the latest recording, select **Options** > *Play last recorded*.

5. To send the last recording using infrared, Bluetooth, or a multimedia message, select **Options** > *Send last recorded*.

List of recordings

Select **Menu** > *Media* > *Voice recorder* > **Options** > *Recordings list*. The list of folders in the *Gallery* is shown. Open *Recordings* to see the list with recordings. Select **Options** to select options for files in the *Gallery*. See "Gallery," p. 74.

Define a storage folder

To use another folder than *Recordings* as the default folder in *Gallery*, select **Menu** > *Media* > *Voice recorder* > **Options** > *Select memory*. Scroll to a folder, and select **Set**.

■ Equalizer

You can control the sound quality when using the music player by amplifying or diminishing frequency bands.

Select **Menu** > *Media* > *Equaliser*.

To activate a set, scroll to one of the equalizer sets, and select **Activate**.

To view, edit, or rename a selected set, select **Options** > *View*, *Edit*, or *Rename*. Not all sets can be edited or renamed.

■ Stereo widening

To enhance the sound that is available in stereo with a wider stereo effect, select **Menu** > *Media* > *Stereo widening* > *On*.

13. Push to talk



Push to talk (PTT) over cellular is a two-way radio service available over a GSM/GPRS cellular network (network service). PTT provides direct voice communication. To connect, press the PTT key.



You can use PTT to have a conversation with one person or with a group of people having compatible devices. When your call is connected, the people you are calling do not have to answer the phone. The participants should confirm the reception of any communication where appropriate, as there is no other confirmation whether the recipients have heard the call.

To check availability and costs, and to subscribe to the service, contact your network operator or service provider. Roaming services may be more limited than for normal calls.

Before you can use the PTT service, you must define the required PTT service settings. See "PTT settings," p. 87.

While you are connected to the PTT service, you can use the other functions of the phone. The PTT service is not connected to traditional voice communication; therefore many of the services available for traditional voice calls (for example, voice mailbox) are not available for PTT communication.

■ Connect to and disconnect from the PTT service

To connect to the PTT service, select **Menu** > *Push to talk* > *Switch PTT on*.  indicates the PTT connection.  indicates that the service is temporarily unavailable. The phone automatically tries to reconnect to the service until you disconnect from the PTT service. If you have added channels to the phone, you are automatically joined to the active (*Default* or *Listened*) channels, and the name of the default channel is displayed in the standby mode.

To disconnect from the PTT service, select *Switch PTT off*.

■ Make and receive a PTT call





Set the phone to use the loudspeaker or earpiece for PTT communication. When the earpiece is selected, you can use the phone normally, by holding it to your ear.



Warning: Do not hold the device near your ear when the loudspeaker is in use, because the volume may be extremely loud.

When connected to the PTT service, you can make or receive channel calls, group calls, or one-to-one calls. One-to-one calls are calls you make to only one person.

Press and hold the PTT key the entire time you are talking, and hold the phone in front of you so that you can see the display. When you are finished, release the PTT key. Talking is allowed on a first-come, first-served basis. When someone stops talking, the first person to press the PTT key can talk next.

To check the login status of your contacts, select **Menu** > **Push to talk** > **Contacts list**. This service depends on your network operator or service provider and is only available for subscribed contacts. , , or  indicate that the contact is available, not logged into the PTT service, or unknown.  indicates that the contact does not want to be disturbed. You cannot call the contact, but you can send a callback request.

To subscribe a contact, select **Options** > **Subscribe contact**, or if one or more contacts are marked, select **Subscribe marked**.

Make a channel or a group call

To make a call to the default channel, press the PTT key. A tone sounds, indicating that the access is granted, and the phone displays your nickname and channel name. See "PTT channels," p. 86.

To make a call to a nondefault channel, select **Channel list** in the PTT menu, scroll to the desired channel, and press the PTT key.

To make a group call from **Contacts**, the recipients must be connected to the PTT service. Select **Menu** > **Contacts** > **Groups**, scroll to the desired group, and press the PTT key.

Push to talk

Make a one-to-one call

- To start a one-to-one call from the list of contacts to which you added the PTT address, select [Contacts list](#). Scroll to a contact, and press the PTT key.
You can also select the contact from [Contacts](#).
- To start a one-to-one call from the list of PTT channels, select [Channel list](#), and scroll to the desired channel. Select [Members](#), scroll to the desired contact, and press the PTT key.
- To start a one-to-one call from the list of callback requests you have received, select [Callback inbox](#). Scroll to the desired contact, and press the PTT key.

Make a PTT call to multiple recipients

You can select multiple PTT contacts from the contact list. The recipients receive an incoming call and must accept the call to participate.

Select [Menu](#) > [Push to talk](#) > [Contacts list](#), and mark the desired contacts. To make the call, press the PTT key. The contacts who accept the call are shown.

Receive a PTT call

A short tone notifies you of an incoming PTT call. Information such as the channel name or the nickname (network service) of the caller is displayed.

If you have set the phone to first notify you of one-to-one calls, accept or reject the call.

If you press the PTT key to try to respond to a call while another member is talking, you hear a tone, and [Queuing](#) is displayed as long as you press the PTT key. Press and hold the PTT key, and wait for the other person to finish; then you can talk.

■ [Callback requests](#)

If you make a one-to-one call and do not get a response, you can send a request for the person to call you back.

Send a callback request

You can send a callback request in the following ways:

- To send a callback request from the contacts list in the *Push to talk* menu, select *Contacts list*. Scroll to a contact, and select **Options** > *Send callback*.
- To send a callback request from *Contacts*, search for the desired contact, select **Details**, scroll to the PTT address, and select **Options** > *Send callback*.
- To send a callback request from the channel list in the *Push to talk* menu, select *Channel list*, and scroll to the desired channel. Select **Members**, scroll to the desired contact, and select **Options** > *Send callback*.
- To send a callback request from the callback request list in the *Push to talk* menu, select *Callback inbox*. Scroll to a contact, and select **Options** > *Send callback*.

Respond to a callback request

When you receive a callback request, *Callback request received* is shown in the standby mode. Select **View**. The list of contacts who have sent you callback requests is shown.

To make a one-to-one call, press the PTT key.

To send a call request back to the sender, select **Options** > *Send callback*.

To delete the request, select **Delete**.

To view the sender's PTT address, select **Options** > *View PTT address*.

To save a new contact or to add the PTT address to a contact, select **Options** > *Save as* or *Add to contact*.

Push to talk

■ Add a one-to-one contact

You can save the names of persons to whom you often make one-to-one calls in the following ways:

- To add a PTT address to a name in *Contacts*, search for the desired contact, and select **Details** > **Options** > *Add detail* > *Push to talk address*.
- To add a contact to the PTT contacts list, select **Menu** > *Push to talk* > *Contacts list* > **Options** > *Add contact*.
- To add a contact from the channel list, connect to the PTT service, select *Channel list*, and scroll to the desired channel. Select **Members**, scroll to the member whose contact information you want to save, and select **Options**. To add a new contact, select *Save as*. To add a PTT address to a name in *Contacts*, select *Add to contact*.

■ PTT channels

When you call a channel, all members joined to the channel hear the call simultaneously.

There are three types of PTT channels:

- Provisioned channel – permanent channel created by the service provider
- *Public channel* – every channel member can invite other persons
- *Private channel* – only persons who receive an invitation from the channel creator can join in

Add a channel

To add a public or private channel, select **Menu** > *Push to talk* > *Add channel*, and edit the settings in the form fields:

Channel status: – Select *Default*, *Listened*, or *Inactive*. *Default* and *Listened* are active channels. When you press the PTT key to make a channel call, the default channel is called if you have not scrolled to any other channel or contact.

Nickname in channel: – Enter your nickname for the channel.

Channel security: – Select *Public channel* or *Private channel*.

To send an invitation to the group, select **Yes** when the phone requests it. You can send the invitation using a text message or infrared.

To add a provisioned channel, select **Menu** > *Push to talk* > *Add channel* > **Options** > *Edit address manually*. Enter the channel address provided by your service provider.

Receive an invitation

When you receive a text message invitation to a group, *Channel invitation received:* is displayed.

1. To view the contact who sent the invitation and the channel address if the group is not a private channel, select **View**.
2. To add the channel to your phone, select **Save**.
3. To set the status for the channel, select *Default*, *Listened*, or *Inactive*.

To reject the invitation, select **View** > **Discard** > **Yes**.

PTT settings

There are two kinds of PTT settings: settings for connecting to the service and settings for use.

You may receive the settings for connecting to the service from your network operator or service provider. See "Configuration settings service," p. 10. You can enter the settings manually. See "Configuration," p. 70.

To select the settings for connecting to the service, select **Menu** > *Push to talk* > *Configuration sett.* and from the following options:

Configuration – to select a service provider, *Default*, or *Personal configuration* for PTT service. Only the configurations that support the PTT service are shown.

Account – to select a PTT service account in the active configuration settings

Push to talk

You can also select from the following options: *Push to talk user name*, *Default nickname*, *Push to talk password*, *Domain*, and *Server address*.

To edit the PTT settings for use, select **Menu** > *Push to talk* > *Push to talk settings*, and from the following options:

1 to 1 calls > *On* – to set the phone to allow the reception of one-to-one calls. To make but not receive one-to-one calls, select *Off*. The service provider may offer some services that override these settings. To set the phone to first notify you of incoming one-to-one calls with a ringing tone, select *Notify*.

Listened channels > *On* – to activate the listened channels

Show my login status > *Yes* – to enable the sending of the login status

PTT status in startup > *Yes* or *Ask first* – to set the phone to automatically connect to the PTT service when you switch on the phone

Push to talk when abroad – to switch the PTT service on or off when the phone is used outside of the home network

Send my PTT address > *No* – to hide your PTT address from calls

14. Organizer



■ Alarm clock

You can set the phone to alarm at a desired time. Select **Menu** > *Organiser* > *Alarm clock*.

To set the alarm, select *Alarm time*, enter the alarm time, and select **OK**. To change the alarm time when the alarm time is set, select *On*.

To set the phone to alert you on selected days of the week, select *Repeat alarm*.

To select the alarm tone or set a radio channel as the alarm tone, select *Alarm tone*. If you select the radio as an alarm tone, connect the headset to the phone. The phone uses the last channel you listened to as the alarm, and the alarm plays through the loudspeaker. If you remove the headset or switch off the phone, the default alarm tone replaces the radio.

To set a snooze time-out, select *Snooze time-out* and the time.

Stop the alarm

The phone sounds an alert tone, and flashes *Alarm!* and the current time on the display, even if the phone was switched off. To stop the alarm, select **Stop**. If you let the phone continue to sound the alarm for a minute or select *Snooze*, the alarm stops for the time you set in *Snooze time-out*, and then resumes.

If the alarm time is reached while the device is switched off, the device switches itself on and starts sounding the alarm tone. If you select **Stop**, the device asks whether you want to activate the device for calls. Select **No** to switch off the device or **Yes** to make and receive calls. Do not select **Yes** when wireless phone use may cause interference or danger.

■ Calendar





Select **Menu** > *Organiser* > *Calendar*.

Organizer

The current day is indicated by a frame in the month view. If there are any notes set for the day, the day is in bold type, and the beginning of the note is shown below the calendar. To view the day notes, select **View**. To view a week, select **Options** > *Week view*. To delete all notes in the calendar, select the month or week view, and select **Options** > *Delete all notes*.

Other options for the calendar day view can make a note; delete, edit, move, or repeat a note; copy a note to another day; send a note with Bluetooth technology; or send a note to the calendar of another compatible phone as a text message or multimedia message. In *Settings* you can set the date, time, time zone, date or time format, date separator, default view, or the first day of the week. In the *Auto-delete notes* option you can set the phone to delete old notes automatically after a specified time.

Make a calendar note

Select **Menu** > *Organiser* > *Calendar*. Scroll to the date you want, select **Options** > *Make a note*, and select one of the following note types:  *Meeting*,  *Call*,  *Birthday*,  *Memo*, or  *Reminder*. Fill in the fields for the note.

Note alarm

The phone beeps, and displays the note. With a call note  on the display, to call the displayed number, press the call key. To stop the alarm and to view the note, select **View**. To stop the alarm for 10 minutes, select **Snooze**.

To stop the alarm without viewing the note, select **Exit**.

■ To-do list

To save a note for a task that you must do, select **Menu** > *Organiser* > *To-do list*.

To make a note if no note is added, select **Add**; otherwise, select **Options** > *Add*. Write the note, select the priority, set the deadline and alarm for the note, and select **Save**.

To view a note, scroll to it, and select **View**.

You can also select an option to delete the selected note and delete all the notes that you have marked as done. You can sort the notes by priority or by deadline, send a note to another phone as a text message or a multimedia message, save a note as a calendar note, or access the calendar.

While viewing a note, you can also select an option to edit the deadline or priority for the note, or mark the note as done.

■ Notes

To write and send notes, select **Menu** > *Organiser* > *Notes*.

To make a note if no note is added, select **Add**; otherwise, select **Options** > *Make a note*. Write the note, and select **Save**.

Other options include deleting and editing a note. While editing a note, you can also exit the text editor without saving the changes. You can send the note to compatible devices through infrared, Bluetooth wireless technology, text message, or a multimedia message.

■ Countdown timer

Select **Menu** > *Organiser* > *Countdown timer*. Enter the alarm time in hours, minutes, and seconds, and select **OK**. If you wish, write your own note text that is displayed when the time expires. To start the countdown timer, select **Start**. To change the countdown time, select *Change time*. To stop the timer, select *Stop timer*.

If the alarm time is reached when the phone is in the standby mode, the phone sounds a tone and flashes the note text if it is set or *Countdown time up*. To stop the alarm, press any key. If no key is pressed, the alarm automatically stops within 60 seconds. To stop the alarm and delete the note text, select **Exit**. To restart the countdown timer, select **Restart**.

Organizer

■ Stopwatch

You can measure time, take intermediate times, or take lap times using the stopwatch. During timing, the other functions of the phone can be used. To set the stopwatch timing in the background, press the end key.

Using the stopwatch or allowing it to run in the background when using other features increases the demand on battery power and reduces the battery life.

Select **Menu** > **Organiser** > **Stopwatch** and from the following options:

Split timing – to take intermediate times. To start the time observation, select **Start**. Select **Split** every time that you want to take an intermediate time. To stop the time observation, select **Stop**.

To save the measured time, select **Save**.

To start the time observation again, select **Options** > **Start**. The new time is added to the previous time. To reset the time without saving it, select **Reset**.

To set the stopwatch timing in the background, press the end key.

Lap timing – to take lap times. To set the stopwatch timing in the background, press the end key.

Continue – to view the timing that you have set in the background

Show last – to view the most recently measured time if the stopwatch is not reset

View times or **Delete times** – to view or delete the saved times

15. Applications



■ Games

Your phone software includes some games.

Launch a game

Select **Menu** > *Applications* > *Games*. Scroll to the desired game, and select **Open**.

For options related to a game, see "Some application options," p. 93.

Game downloads

Select **Menu** > *Applications* > *Options* > *Downloads* > *Game downloads*. The list of available bookmarks is shown.



Important: Only install and use applications and other software from sources that offer adequate security and protection against harmful software.

Game settings

To set sounds, lights, and shakes for the game, select **Menu** > *Applications* > *Options* > *Application settings*.

■ Collection

Your phone software includes some Java applications, such as a calculator.

Launch an application

Select **Menu** > *Applications* > *Collection*. Scroll to an application, and select **Open**.

Some application options

Delete – to delete the application from the phone

Applications

Details – to give additional information about the application

Update version – to check if a new version of the application is available for download from *Web* (network service)

Application access – to restrict the application from accessing the network. Different categories are shown. Select in each category one of the available permissions.

Web page – to provide further information or additional data for the application from an Internet page (network service). It is only shown if an Internet address has been provided with the application.

Download an application

Your phone supports J2ME Java applications. Make sure that the application is compatible with your phone before downloading it.



Important: Only install and use applications and other software from sources that offer adequate security and protection against harmful software.

You can download new Java applications in different ways:

- Select **Menu** > *Applications* > **Options** > *Downloads* > *Application downloads*, and the list of available bookmarks is shown.

For the availability of different services, pricing, and tariffs, contact your service provider.

- Use the game download function. See "Game downloads," p. 93.
- Use the Nokia Application Installer from PC Suite to download the applications to your phone.

Your device may have some bookmarks loaded for sites not affiliated with Nokia. Nokia does not warrant or endorse these sites. If you choose to access them, you should take the same precautions, for security or content, as you would with any Internet site.

16. Web



You can access various mobile Internet services with your phone browser.



Important: Use only services that you trust and that offer adequate security and protection against harmful software.

Check the availability of these services, pricing, tariffs, and instructions with your service provider.

With the phone browser you can view the services that use wireless markup language (WML) or extensible hypertext markup language (XHTML) on their pages. Appearance may vary due to screen size. You may not be able to view all details of the Internet pages.

■ Basic steps to access and use services

1. Save the service settings that are required to access the service that you want to use. See "Set up browsing," p. 95.
2. Make a connection to the service. See "Connect to a service," p. 96.
3. Start browsing the pages of the service. See "Browse pages," p. 96.
4. When you finish browsing, end the connection to the service. To disconnect, see "Options while browsing," p. 97.

■ Set up browsing

You may receive the configuration settings required for browsing as a configuration message from the network operator or service provider that offers the service that you want to use. See "Configuration settings service," p. 10. You can also enter all the configuration settings manually. See "Configuration," p. 70.

Web

■ Connect to a service

First, ensure that the correct configuration settings of the service that you want to use are activated.



1. To select the settings for connecting to the service, select **Menu** > *Web* > *Settings* > *Configuration settings*.
2. Select *Configuration*. Only the configurations that support browsing service are shown. Select a service provider, *Default*, or *Personal configuration* for browsing. See "Set up browsing," p. 95.
3. Select *Account* and a browsing service account contained in the active configuration settings.
4. Select *Display terminal window* > *Yes* to perform manual user authentication for intranet connections.

Secondly, make a connection to the service in one of the following ways:

- Select **Menu** > *Web* > *Home*; or in the standby mode, press and hold 0.
- To select a bookmark of the service, select **Menu** > *Web* > *Bookmarks*.
- To select the last URL, select **Menu** > *Web* > *Last web address*.
- To enter the address of the service, select **Menu** > *Web* > *Go to address*. Enter the address of the service, and select **OK**.

■ Browse pages

After you make a connection to the service, you can start browsing its pages. The function of the phone keys may vary in different services. Follow the text guides on the phone display. For more information, contact your service provider.

If GPRS is selected as the data bearer,  is shown on the top left of the display during browsing. If you receive a call or a text message, or make a call during an (E)GPRS connection,  is shown on the top right of the display to indicate that the (E)GPRS connection is suspended (on hold). After a call the phone tries to reconnect the (E)GPRS connection.

Browse with phone keys

To browse through the page, scroll in any direction.

To select a highlighted item, press the call key, or select [Select](#).

To enter letters and numbers, press the 0 to 9 keys. To enter special characters, press *.

Options while browsing

Select from the following options:

[Shortcuts](#) – to open a new list of options that are specific to the page. This option is only available if the page contains shortcuts.

[Home](#) – to return to your start page

[Add bookmark](#) – to save the page as a bookmark

[Bookmarks](#) – to access the list of bookmarks. See “Bookmarks,” p. 97.

[History](#) – to get a list showing the last visited URLs

[Page options](#) – to show the list of options for the active page

[Downloads](#) – to show the list of bookmarks for downloading

[Other options](#) – to show a list of other options

[Reload](#) – to reload and update the current page

[Quit](#) – to disconnect from a service

The service provider may also offer other options.

Direct calling

The browser supports functions that you can access while browsing. You can make a phone call, send DTMF tones while a voice call is in progress, and save a name and a phone number from a page.

■ Bookmarks

You can save page addresses as bookmarks in the phone memory.

1. While browsing, select [Options](#) > [Bookmarks](#); or in the standby mode, select [Menu](#) > [Web](#) > [Bookmarks](#).

Web

2. Scroll to a bookmark, and select it, or press the call key to make a connection to the page associated with the bookmark.
3. Select **Options** to view, edit, delete, or send the bookmark; to create a new bookmark; or to save the bookmark to a folder.

Your device may have some bookmarks loaded for sites not affiliated with Nokia. Nokia does not warrant or endorse these sites. If you choose to access them, you should take the same precautions, for security or content, as you would with any Internet site.

Receive a bookmark

When you have received a bookmark that is sent as a bookmark, *1 bookmark received* is displayed. The received bookmark is saved automatically to *Bookmarks*. To view it, select **Show** > *Bookmarks*.

■ Appearance settings

While browsing, select **Options** > *Other options* > *Appearance settings*, or in the standby mode, select **Menu** > *Web* > *Settings* > *Appearance settings* and from the following options:

Text wrapping > *On* – to set the text to continue on the next line on the display. If you select *Off*, the text is abbreviated.

Font size – to set the font size

Show images > *No* – to hide pictures on the page. This can speed up the browsing of pages that contain a lot of pictures.

Alerts > *Alert for unsecure conn.* > *Yes* – to set the phone to alert when a secure connection changes to an unsecure one during browsing

Alerts > *Alert for unsecure items* > *Yes* – to set the phone to alert when a secure page contains an unsecure item. These alerts do not guarantee a secure connection. For more information, see "Browser security," p. 101.

Character encoding > *Content encoding* – to select the encoding for the browser page content

[Character encoding](#) > [Unicode \(UTF-8\) web add.](#) > [On](#) – to set the phone to send a URL as a UTF-8 encoding. You may need this setting when you access a Web page created in foreign language.

[Screen size](#) > [Full](#) or [Small](#) – to set the screen layout

[JavaScript](#) > [Enable](#) – to enable the Java scripts

■ Security settings

Cookies

A cookie is data that a site saves in the cache memory of your phone. Cookies are saved until you clear the cache memory. See "Cache memory," p. 100.

While browsing, select [Options](#) > [Other options](#) > [Security](#) > [Cookie settings](#); or in the standby mode, select [Menu](#) > [Web](#) > [Settings](#) > [Security settings](#) > [Cookies](#). To allow or prevent the phone from receiving cookies, select [Allow](#) or [Reject](#).

Scripts over secure connection

You can select whether to allow the running of scripts from a secure page. The phone supports WML scripts.

While browsing, to allow the scripts, select [Options](#) > [Other options](#) > [Security](#) > [WMLScript settings](#); or in the standby mode, select [Menu](#) > [Web](#) > [Settings](#) > [Security settings](#) > [WMLScripts in sec. conn.](#) > [Allow](#).

■ Download settings

To automatically save all downloaded files in [Gallery](#), select [Menu](#) > [Web](#) > [Settings](#) > [Downloading settings](#) > [Automatic saving](#) > [On](#).

■ Service inbox

The phone is able to receive service messages (pushed messages) sent by your service provider (network service). Service messages are notifications (for example, news headlines), and they may contain a text message or an address of a service.

Web

To access the *Service inbox* in the standby mode, when you have received a service message, select **Show**. If you select **Exit**, the message is moved to the *Service inbox*. To access the *Service inbox* later, select **Menu** > *Web* > *Service inbox*.

To access the *Service inbox* while browsing, select **Options** > *Other options* > *Service inbox*. Scroll to the message you want, and to activate the browser and download the marked content, select **Retrieve**. To display detailed information on the service notification or to delete the message, select **Options** > *Details* or *Delete*.

Service inbox settings

Select **Menu** > *Web* > *Settings* > *Service inbox settings*.

To set whether you want to receive service messages, select *Service messages* > *On* or *Off*.

To set the phone to receive service messages only from content authors approved by the service provider, select *Message filter* > *On*. To view the list of the approved content authors, select *Trusted channels*.

To set the phone to automatically activate the browser from the standby mode when the phone has received a service message, select *Automatic connection* > *On*. If you select *Off*, the phone activates the browser only after you select **Retrieve** when the phone has received a service message.

Cache memory

A cache is a memory location that is used to store data temporarily. If you have tried to access or have accessed confidential information requiring passwords, empty the cache after each use. The information or services you have accessed is stored in the cache.

To empty the cache while browsing, select **Options** > *Other options* > *Clear the cache*; in the standby mode, select **Menu** > *Web* > *Clear the cache*.

■ Browser security

Security features may be required for some services, such as online banking or shopping. For such connections you need security certificates and possibly a security module, which may be available on your SIM card. For more information, contact your service provider.

Security module

The security module improves security services for applications requiring a browser connection, and allows you to use a digital signature. The security module may contain certificates as well as private and public keys. The certificates are saved in the security module by the service provider.

To view or change the security module settings, select **Menu** > **Settings** > **Security** > **Security module settings**.

Certificates



Important: Even if the use of certificates makes the risks involved in remote connections and software installation considerably smaller, they must be used correctly in order to benefit from increased security. The existence of a certificate does not offer any protection by itself; the certificate manager must contain correct, authentic, or trusted certificates for increased security to be available. Certificates have a restricted lifetime. If Expired certificate or Certificate not valid yet is shown even if the certificate should be valid, check that the current date and time in your device are correct.

Before changing any certificate settings, you must make sure that you really trust the owner of the certificate and that the certificate really belongs to the listed owner.

There are three kinds of certificates: server certificates, authority certificates, and user certificates. You may receive these certificates from your service provider. Authority certificates and user certificates may also be saved in the security module by the service provider.

To view the list of the authority or user certificates downloaded into your phone, select **Menu** > **Settings** > **Security** > **Authority certificates** or **User certificates**.

W e b

 is displayed during a connection, if the data transmission between the phone and the content server is encrypted.

The security icon does not indicate that the data transmission between the gateway and the content server (or place where the requested resource is stored) is secure. The service provider secures the data transmission between the gateway and the content server.

Digital signature

You can make digital signatures with your phone if your SIM card has a security module. Using the digital signature can be the same as signing your name to a paper bill, contract, or other document.

To make a digital signature, select a link on a page, for example, the title of the book you want to buy and its price. The text to sign, which may include the amount and date, is shown.

Check that the header text is *Read* and that the digital signature icon  is shown.

If the digital signature icon does not appear, there is a security breach, and you should not enter any personal data such as your signing PIN.

To sign the text, read all of the text first, and select **Sign**.

The text may not fit within a single screen. Therefore, make sure to scroll through and read all of the text before signing.

Select the user certificate you want to use. Enter the signing PIN (see "Access codes," p. 9), and select **OK**. The digital signature icon disappears, and the service may display a confirmation of your purchase.

17. SIM services



Your SIM card may provide additional services. You can access this menu only if it is supported by your SIM card. The name and contents of the menu depend on the available services.

For availability and information on using SIM card services, contact your SIM card vendor. This may be the service provider, network operator, or other vendor.

To set the phone to show you the confirmation messages sent between your phone and the network when you are using the SIM services, select [Menu](#) > [Settings](#) > [Phone](#) > [Confirm SIM serv. actions](#) > [Yes](#). This option is shown only if supported by your SIM card.

Accessing these services may involve sending messages or making a phone call for which you may be charged.

18. PC connectivity

You can send and receive e-mail, and access the Internet when your phone is connected to a compatible PC through an infrared, Bluetooth, or USB data cable (CA-53) connection. You can use your phone with a variety of PC connectivity and data communications applications.

■ USB data storage

You can use the USB data cable to transfer data between the memory card inserted in the phone and a compatible PC. See "USB data cable," p. 67.

After transferring data, ensure that it is safe to unplug the USB data cable from the PC.

PC connectivity

■ Nokia PC Suite

With Nokia PC Suite you can synchronize contacts, calendar, notes, and to-do notes between your phone and the compatible PC or a remote Internet server (network service). You may find more information and PC Suite on the Nokia Web site at www.nokia.com/support.

■ Data communication applications

For information on using a data communication application, refer to the documentation provided with it.

Making or answering phone calls during a computer connection is not recommended, as it might disrupt the operation.

■ (E)GPRS, HSCSD, and CSD

With your phone you can use the enhanced GPRS (EGPRS), general packet radio service (GPRS), high speed circuit switched data (HSCSD), and circuit switched data (CSD, *GSM data*) data services.

For availability and subscription to data services, contact your network operator or service provider.

The use of HSCSD services consumes the phone battery faster than normal voice or data calls. You may need to connect the phone to a charger for the duration of data transfer.

See "Packet data settings," p. 65.

19. Battery information

■ Charging and discharging

Your device is powered by a rechargeable battery. The full performance of a new battery is achieved only after two or three complete charge and discharge cycles. The battery can be charged and discharged hundreds of times, but it will eventually wear out. When the talk and standby times are noticeably shorter than normal, replace the battery. Use only Nokia approved batteries, and recharge your battery only with Nokia approved chargers designated for this device.

If a replacement battery is being used for the first time or if the battery has not been used for a prolonged period, it may be necessary to connect the charger and then disconnect and reconnect it to start the charging.

Unplug the charger from the electrical plug and the device when not in use. Do not leave fully charged battery connected to a charger, since overcharging may shorten its lifetime. If left unused, a fully charged battery will lose its charge over time.

If the battery is completely discharged, it may take a few minutes before the charging indicator appears on the display or before any calls can be made.

Use the battery only for its intended purpose. Never use any charger or battery that is damaged.

Do not short-circuit the battery. Accidental short-circuiting can occur when a metallic object such as a coin, clip, or pen causes direct connection of the positive (+) and negative (-) terminals of the battery. (These look like metal strips on the battery.) This might happen, for example, when you carry a spare battery in your pocket or purse. Short-circuiting the terminals may damage the battery or the connecting object.

Leaving the battery in hot or cold places, such as in a closed car in summer or winter conditions, will reduce the capacity and lifetime of the battery. Always try to keep the battery between 15°C and 25°C (59°F and 77°F). A device with a hot or cold battery may not work temporarily, even when the battery is fully charged. Battery performance is particularly limited in temperatures well below freezing.

Do not dispose of batteries in a fire as they may explode. Batteries may also explode if damaged. Dispose of batteries according to local regulations. Please recycle when possible. Do not dispose as household waste.

Battery information

■ Nokia battery authentication guidelines

Always use original Nokia batteries for your safety. To check that you are getting an original Nokia battery, purchase it from an authorized Nokia dealer, look for the Nokia Original Enhancements logo on the packaging, and inspect the hologram label using the following steps:

Successful completion of the four steps is not a total assurance of the authenticity of the battery. If you have any reason to believe that your battery is not an authentic original Nokia battery, you should refrain from using it and take it to the nearest authorized Nokia service point or dealer for assistance. Your authorized Nokia service point or dealer will inspect the battery for authenticity. If authenticity cannot be verified, return the battery to the place of purchase.

Authenticate hologram

1. When looking at the hologram on the label, you should see the Nokia connecting hands symbol from one angle and the Nokia Original Enhancements logo when looking from another angle.

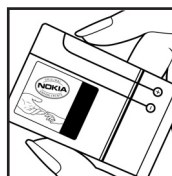

2. When you angle the hologram left, right, down, and up, you should see 1, 2, 3, and 4 dots on each side respectively.



3. Scratch the side of the label to reveal a 20-digit code, for example, 12345678919876543210. Turn the battery so that the numbers are facing upwards. The 20-digit code reads starting from the number at the top row followed by the bottom row.



Battery information

4. Confirm that the 20-digit code is valid by following the instructions at www.nokia.com/batterycheck.

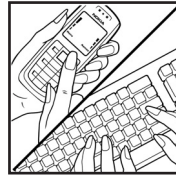

What if your battery is not authentic?

If you cannot confirm that your Nokia battery with the hologram on the label is an authentic Nokia battery, please do not use the battery. Take it to the nearest authorized Nokia service point or dealer for assistance. The use of a battery that is not approved by the manufacturer may be dangerous and may result in poor performance and damage to your device and its enhancements. It may also invalidate any approval or warranty applying to the device.

To find out more about original Nokia batteries, visit www.nokia.com/battery.

Care and maintenance

Your device is a product of superior design and craftsmanship and should be treated with care. The suggestions below will help you protect your warranty coverage.

- Keep the device dry. Precipitation, humidity and all types of liquids or moisture can contain minerals that will corrode electronic circuits. If your device does get wet, remove the battery and allow the device to dry completely before replacing it.
- Do not use or store the device in dusty, dirty areas. Its moving parts and electronic components can be damaged.
- Do not store the device in hot areas. High temperatures can shorten the life of electronic devices, damage batteries, and warp or melt certain plastics.
- Do not store the device in cold areas. When the device returns to its normal temperature, moisture can form inside the device and damage electronic circuit boards.
- Do not attempt to open the device other than as instructed in this guide.
- Do not drop, knock, or shake the device. Rough handling can break internal circuit boards and fine mechanics.
- Do not use harsh chemicals, cleaning solvents, or strong detergents to clean the device.
- Do not paint the device. Paint can clog the moving parts and prevent proper operation.
- Use a soft, clean, dry cloth to clean any lenses (such as camera, proximity sensor, and light sensor lenses).
- Use only the supplied or an approved replacement antenna. Unauthorized antennas, modifications, or attachments could damage the device and may violate regulations governing radio devices.
- Use chargers indoors.
- Always create a backup of data you want to keep (such as contacts and calendar notes) before sending your device to a service facility.

All of the above suggestions apply equally to your device, battery, charger, or any enhancement. If any device is not working properly, take it to the nearest authorized service facility for service.

Additional safety information

Your device and its enhancements may contain small parts. Keep them out of the reach of small children.

■ Operating environment

Remember to follow any special regulations in force in any area, and always switch off your device when its use is prohibited or when it may cause interference or danger. Use the device only in its normal operating positions. This device meets RF exposure guidelines when used either in the normal use position against the ear or when positioned at least 2.2 centimeters (7/8 inch) away from the body. When a carry case, belt clip or holder is used for body-worn operation, it should not contain metal and should position the device the above-stated distance from your body.

To transmit data files or messages, this device requires a quality connection to the network. In some cases, transmission of data files or messages may be delayed until such a connection is available. Ensure that the above separation distance instructions are followed until the transmission is completed.

Parts of the device are magnetic. Metallic materials may be attracted to the device. Do not place credit cards or other magnetic storage media near the device, because information stored on them may be erased.

■ Medical devices

Operation of any radio transmitting equipment, including wireless phones, may interfere with the functionality of inadequately protected medical devices. Consult a physician or the manufacturer of the medical device to determine if they are adequately shielded from external RF energy or if you have any questions. Switch off your device in health care facilities when any regulations posted in these areas instruct you to do so. Hospitals or health care facilities may be using equipment that could be sensitive to external RF energy.

Pacemakers

Pacemaker manufacturers recommend that a minimum separation of 15.3 centimeters (6 inches) be maintained between a wireless phone and a pacemaker to avoid potential interference with the pacemaker. These recommendations are consistent with the independent research by and recommendations of Wireless Technology Research. Persons with pacemakers should do the following:

Additional safety information

- Always keep the device more than 15.3 centimeters (6 inches) from the pacemaker
- Not carry the device in a breast pocket
- Hold the device to the ear opposite the pacemaker to minimize the potential for interference.

If you suspect interference, switch off your device, and move the device away.

Hearing aids

Some digital wireless devices may interfere with some hearing aids. If interference occurs, consult your service provider.

■ Vehicles

RF signals may affect improperly installed or inadequately shielded electronic systems in motor vehicles such as electronic fuel injection systems, electronic antiskid (antilock) braking systems, electronic speed control systems, an air bag systems. For more information, check with the manufacturer or its representative of your vehicle or any equipment that has been added.

Only qualified personnel should service the device, or install the device in a vehicle. Faulty installation or service may be dangerous and may invalidate any warranty that may apply to the device. Check regularly that all wireless device equipment in your vehicle is mounted and operating properly. Do not store or carry flammable liquids, gases, or explosive materials in the same compartment as the device, its parts, or enhancements. For vehicles equipped with an air bag, remember that air bags inflate with great force. Do not place objects, including installed or portable wireless equipment in the area over the air bag or in the air bag deployment area. If in-vehicle wireless equipment is improperly installed and the air bag inflates, serious injury could result.

Using your device while flying in aircraft is prohibited. Switch off your device before boarding an aircraft. The use of wireless teledevices in an aircraft may be dangerous to the operation of the aircraft, disrupt the wireless telephone network, and may be illegal.

■ Potentially explosive environments

Switch off your device when in any area with a potentially explosive atmosphere and obey all signs and instructions. Potentially explosive atmospheres include areas where you would normally be advised to turn off your vehicle engine. Sparks in such areas could cause an explosion or fire resulting in bodily injury or even death. Switch off the device at refueling points such as near gas pumps at service stations. Observe restrictions on the use of radio equipment in fuel

Additional safety information

depots, storage, and distribution areas; chemical plants; or where blasting operations are in progress. Areas with a potentially explosive atmosphere are often but not always clearly marked. They include below deck on boats, chemical transfer or storage facilities, vehicles using liquefied petroleum gas (such as propane or butane), and areas where the air contains chemicals or particles such as grain, dust, or metal powders.

■ Emergency calls



Important: Wireless phones, including this device, operate using radio signals, wireless networks, landline networks, and user-programmed functions. Because of this, connections in all conditions cannot be guaranteed. You should never rely solely on any wireless device for essential communications like medical emergencies.

To make an emergency call:

1. If the device is not on, switch it on. Check for adequate signal strength.
Some networks may require that a valid SIM card is properly inserted in the device.
2. Press the end key as many times as needed to clear the display and ready the device for calls.
3. Enter the official emergency number for your present location. Emergency numbers vary by location.
4. Press the call key.

If certain features are in use, you may first need to turn those features off before you can make an emergency call. Consult this guide or your service provider for more information.

When making an emergency call, give all the necessary information as accurately as possible. Your wireless device may be the only means of communication at the scene of an accident. Do not end the call until given permission to do so.

■ Certification information (SAR)

This mobile device meets guidelines for exposure to radio waves

Your mobile device is a radio transmitter and receiver. It is designed not to exceed the limits for exposure to radio waves recommended by international guidelines. These guidelines were developed by the independent scientific organization ICNIRP and include safety margins designed to assure the protection of all persons, regardless of age and health.

A d d i t i o n a l s a f e t y i n f o r m a t i o n

The exposure guidelines for mobile devices employ a unit of measurement known as the Specific Absorption Rate or SAR. The SAR limit stated in the ICNIRP guidelines is 2.0 watts/kilogram (W/kg) averaged over 10 grams of tissue. Tests for SAR are conducted using standard operating positions with the device transmitting at its highest certified power level in all tested frequency bands. The actual SAR level of an operating device can be below the maximum value because the device is designed to use only the power required to reach the network. That amount changes depending on a number of factors such as how close you are to a network base station. The highest SAR value under the ICNIRP guidelines for use of the device at the ear is 0.74 W/kg.

Use of device accessories and enhancements may result in different SAR values. SAR values may vary depending on national reporting and testing requirements and the network band. Additional SAR information may be provided under product information at www.nokia.com.

Your mobile device is also designed to meet the requirements for exposure to radio waves established by the Federal Communications Commission (USA) and Industry Canada. These requirements set a SAR limit of 1.6 W/kg averaged over 1 gram of tissue. The highest SAR value reported under this standard during product certification for use at the ear is 1.01 W/kg and when properly worn on the body is 0.90 W/kg. Information about this device model can be found at <http://www.fcc.gov/oet/fccid> by searching the equipment authorization system using FCC ID: LJPRM-56.

INDEX

A

- access codes 9
- accessories. See enhancements
- active standby 20, 59
 - content items 20
 - enabling 61
 - navigation mode 20
 - passive mode 20
- alarm clock 89
- antenna 17
- applications 93
 - collection 93
 - download 94
 - games 93
 - downloads 93
 - settings 93
- audio messages 36

B

- barring password 10
- battery
 - authentication 106
 - charge level 19
 - charging 15, 105
 - discharging 105
 - installation 13
- bluetooth
 - connection 63
 - set up connection 63
 - settings 63
- bookmarks 97
- browser 95
 - appearance settings 98
 - bookmarks 97
 - browsing pages 96
 - cache memory 100
 - certificates 101
 - cookies 99
 - digital signature 102
 - script settings 99
 - security 99
 - security module 101
 - set up 95
- business cards 54

C

- cache memory 100
- calendar
 - note 90
 - note alarm 90
- call
 - settings 68
- call key 18
- call log 56
- call register. See call log
- call waiting 26
- callback requests 84
- caller groups 55
- calls
 - answer 25
 - call log 56
 - dialed numbers 56
 - ending 24, 25
 - international 24
 - making 24
 - missed calls 56
 - options during call 26
 - received calls 56
 - reject 25
 - speed dialling 24
 - voice dialling 24
 - waiting 26
- camera
 - key 18
 - lens 18
 - record a video clip 76
 - settings 76
 - take a photo 75
- camera light 18
- care 108
- certificates 101
- certification information 111
- character case 27
- charge the battery 15
- charger connector 19
- chargers 15
- circuit switched data 104
- clock settings 60
- codes
 - barring password 10

INDEX

- PIN 10
- PUK 10
- security code 9
- UPIN 10
- UPUK 10
- configuration 70
 - plug and play service 16
 - settings service 10
- contact information 11
- contacts
 - business cards 54
 - caller groups 55
 - copy 51
 - delete 51
 - delete contact details 51, 52
 - edit details 51
 - memory in use 54
 - my numbers 55
 - my presence 52
 - save an image 50
 - save multiple numbers 50
 - save names 50
 - save phone numbers 50
 - save text items 50
 - search 50
 - service numbers 55
 - settings 54
 - speed dialing 55
 - subscribed names 53
- cookies 99
- countdown timer 91
- counters. See call register
- CSD 104
- customer service 11

D

- data cable 67
- data communication 103
- data transfer
 - synchronize from PC 67
 - synchronize from server 67
 - with a compatible device 66
- date settings 60
- delete
 - e-mail messages 44
 - messages 45
- digital signature 102
- display settings 59
- downloads

114

- applications 11, 94
- content 11
- games 93
- settings 99

E

- earpiece 18
- e-mail application 42
 - delete e-mail 44
 - download e-mail 43
 - folders
 - inbox, other folders 44
 - read e-mail 44
 - reply e-mail 44
 - retrieve e-mail 43, 44
 - send e-mail 43
 - servers
 - IMAP4 42
 - POP3 42
 - write e-mail 43
- emergency calls 111
- end key 18
- ending call 24, 25
- enhancements
 - settings 70
- enhancements connector 19
- equalizer 81
- explosive environments 110

F

- factory settings 72
- flash messages 35
- FM radio 78
- functions
 - overview 9

G

- gallery 74
- GPRS, EGPRS 64

H

- handsfree. See loudspeaker
- hearing aids 110
- high-speed circuit switched data 104
- HSCSD 104

I

IM. See instant messaging
 IMAP4 42
 indicators 21
 info messages 45
 infrared 64
 installation
 battery 13
 memory card 14
 SIM card 13
 instant messaging
 accept invitation 39
 availability 40
 block 41
 connect/disconnect 38
 contacts 40
 groups 41
 participate in a conversation 40
 read 39
 reject invitation 39
 start session 38
 unblock 41
 Internet 95
 IR port 19
 IR. See infrared

K

keyguard. See keypad lock
 keypad lock 23
 keys 18
 call 18
 end 18
 keypad lock 23
 navigation key
 numbers and characters 18
 power on/off 18
 PTT 19
 selection keys 18, 19
 volume 18

L

language
 writing language 27
 location information. See positioning
 lock keypad 23
 loudspeaker 18, 26

M

maintenance 108
 maintenance service 11
 making calls 24
 media 75
 media player
 settings 76
 medical devices 109
 memory card
 formatting 74
 installation 14
 slot 19
 menu
 main menu view 29
 navigating 29
 scrolling 29
 message center number 30
 message counter. See call register
 message settings
 e-mails 48
 multimedia messages 47
 SMS e-mail 46
 text messages 46
 messages 30
 audio messages 36
 cancel sending 34
 counter. See call register
 delete 45
 flash messages 35
 folders 35
 info messages 45
 instant messaging 37
 message settings 46
 general settings 46
 sending 33
 service commands 45
 templates 35
 text messages
 voice messages 45
 write text messages 30
 MMS. See multimedia messages
 multimedia messages
 create 32
 read 34
 reply 34
 send 32
 write 32
 music player 77
 settings 77

INDEX

my numbers 55
my presence 52
my shortcuts 60

N

navigating 29
navigation key 18
network
 EGSM 7
 GSM 7
 name on display 19
 services 7
Nokia contact information 11
Nokia support 11
notes 91
 calendar 90

O

operator logo 59
operator menu 73
organiser 89
overview
 keys and parts 18

P

pacemakers 109
packet data 104
 connection 65
 settings 65
parts 18
PC connectivity 103
PC Suite 104
phone
 care 108
 configuration 70
 earpiece 18
 keys 18
 loudspeaker 18
 parts 18
 personalize 58, 59
 settings 69
phone lock. See keypad lock
phone maintenance 108
phonebook. See contacts
photo 75
PIN code 16
PIN codes 10
POP3 42

Pop-port connector. See
enhancements connector
positioning 56
power key 18
power saver 60
predictive text input 27
 prediction settings 27
profiles 58
PTT 82
 callback requests 84
 respond 85
 send 85
 channel call 83
 channels 86
 add 86
 receive invitation 87
 connect 82
 disconnect 82
 group call 83
 make a call 83
 one-to-one call 84
 one-to-one contact
 add 86
 receive a call 83, 84
 settings 87
PTT key 19
PUK codes 10
punctuation marks 28
Push to talk. See PTT
pushed messages 99

R

radio 78
recent calls list 56
record sound 80
recorder 80
repair service 11
ringing tones 58
 caller groups 55
 mute 25

S

safety
 additional information 109
 certification information (SAR) 111
 emergency calls 111
 enhancements
 explosive environments 110

INDEX

- guidelines 6
 - hearing aids 110
 - medical devices 109
 - operating environment 109
 - pacemakers 109
 - SAR 111
 - vehicles 110
 - SAR 111
 - screen saver 60
 - script settings 99
 - scripts over secure connection 99
 - scroll key. See navigation key
 - security code 9
 - security module 101
 - security settings 71
 - selection keys 18, 19
 - service commands 45
 - service inbox 99
 - settings 100
 - service messages 99
 - service numbers 55
 - services 95
 - settings 58
 - bluetooth settings 63
 - call 68
 - camera 76
 - clock 60
 - configuration 70
 - connectivity 62
 - data transfer 66
 - date 60
 - display 59
 - downloads 99
 - enhancements 70
 - GPRS, EGPRS 64
 - infrared 64
 - message settings 46
 - music player 77
 - my shortcuts 60
 - packet data connection 65
 - packet data settings 65
 - phone 69
 - profiles 58
 - restore factory settings 72
 - service inbox 100
 - themes 58
 - time 60
 - tones 58
 - USB data cable 67
 - shared memory 8
 - shortcuts in the standby mode 21
 - signal strength 19
 - SIM card
 - installation 13
 - SIM messages 31
 - SIM services 103
 - SMS e-mail 31
 - SMS. See text messages
 - special characters 28
 - speed dialing 24, 55
 - standby mode 19
 - shortcuts 21, 60
 - stereo widening 81
 - stopwatch 92
 - strap 17
 - subscribed names 53
 - add contacts 53
 - unsubscribe a contact 54
 - view 53
 - support 11
 - switch on and off 16
- ## T
- take a photo 75
 - templates 31, 35
 - text
 - character case 27
 - predictive text input 27
 - punctuation marks 28
 - settings 27
 - special characters 28
 - traditional text input 28
 - writing 27
 - text messages
 - read 31
 - reply 31
 - send 30
 - SIM messages 31
 - templates 31
 - write 30
 - themes 58
 - time settings 60
 - timers. See call register
 - to-do list 90
 - tones 58
 - traditional text input 28

I N D E X

U

unlock keypad 23
UPIN 10
UPIN code 16
UPUK code 10

V

vehicles 110
vibrating alert 58
video clip 76
voice commands 61
voice dialing 24
voice messages 45
voice recorder 80
volume keys 18

W

wallpaper 58, 59
Web 95
 bookmarks 97
 connect 96
wireless markup language 95
wrist strap 17
write text 27
writing language 27

X

XHTML 95