

Nokia 6720 classic User Guide

D
R
A
F
T

© 2009 Nokia. All rights reserved.

DECLARATION OF CONFORMITY

CE 0434

Hereby, NOKIA CORPORATION declares that this RM-564 product is in compliance with the essential requirements and other relevant provisions of Directive 1999/5/EC. A copy of the Declaration of Conformity can be found at www.nokia.com/phones/declaration_of_conformity/.

Nokia, Nokia Connecting People, Nokia XpressMusic, Navi, Mail for Exchange, N-Gage, OVI, and Nokia Original Enhancements logo are trademarks or registered trademarks of Nokia Corporation. Nokia tune is a sound mark of Nokia Corporation. Other product and company names mentioned herein may be trademarks or tradenames of their respective owners.

Reproduction, transfer, distribution, or storage of part or all of the contents in this document in any form without the prior written permission of Nokia is prohibited. US Patent No 5818437 and other pending patents. T9 text input software Copyright © 1997-2008. Tegic Communications, Inc. All rights reserved.

symbian

This product includes software licensed from Symbian Software Ltd ©1998-2008. Symbian and Symbian OS are trademarks of Symbian Ltd.



Java
POWERED

Java and all Java-based marks are trademarks or registered trademarks of Sun Microsystems, Inc.

Portions of the Nokia Maps software are ©1996-2008 The FreeType Project. All rights reserved.

This product is licensed under the MPEG-4 Visual Patent Portfolio License (i) for personal and noncommercial use in connection with information which has been encoded in compliance with the MPEG-4 Visual Standard by a consumer engaged in a personal and noncommercial activity and (ii) for use in connection with MPEG-4 video provided by a licensed video provider. No license is granted or shall be implied for any other use. Additional information, including that related to promotional, internal, and commercial uses, may be obtained from MPEG LA, LLC. See <http://www.mpegla.com>

Nokia operates a policy of ongoing development. Nokia reserves the right to make changes and improvements to any of the products described in this document without prior notice.

TO THE MAXIMUM EXTENT PERMITTED BY APPLICABLE LAW, UNDER NO CIRCUMSTANCES SHALL NOKIA OR ANY OF ITS LICENSORS BE RESPONSIBLE FOR ANY LOSS OF DATA OR INCOME OR ANY SPECIAL, INCIDENTAL, CONSEQUENTIAL OR INDIRECT DAMAGES HOWSOEVER CAUSED.

THE CONTENTS OF THIS DOCUMENT ARE PROVIDED "AS IS". EXCEPT AS REQUIRED BY APPLICABLE LAW, NO WARRANTIES OF ANY KIND, EITHER EXPRESS OR IMPLIED, INCLUDING, BUT NOT LIMITED TO, THE IMPLIED WARRANTIES OF MERCHANTABILITY AND FITNESS FOR A PARTICULAR PURPOSE, ARE MADE IN RELATION TO THE ACCURACY, RELIABILITY OR CONTENTS OF THIS DOCUMENT. NOKIA RESERVES THE RIGHT TO REVISE THIS DOCUMENT OR WITHDRAW IT AT ANY TIME WITHOUT PRIOR NOTICE.

Reverse engineering of any software in the Nokia device is prohibited to the extent permitted by applicable law. Insofar as this user guide contains any limitations on Nokia's representations, warranties, damages and liabilities, such limitations shall likewise limit any representations, warranties, damages and liabilities of Nokia's licensors.

The availability of particular products and applications and services for these products may vary by region. Please check with your Nokia dealer for details, and availability of language options.

Export controls

This device may contain commodities, technology or software subject to export laws and regulations from the US and other countries. Diversion contrary to law is prohibited.

FCC/INDUSTRY CANADA NOTICE

Your device may cause TV or radio interference (for example, when using a telephone in close proximity to receiving equipment). The FCC or Industry Canada can require you to stop using your telephone if such interference cannot be eliminated. If you require assistance, contact your local service facility. This device complies with part 15 of the FCC rules. Operation is subject to the following two conditions: (1) This device may not cause harmful interference, and (2) this device must accept any interference received, including interference that may cause undesired operation. Any changes or modifications not expressly approved by Nokia could void the user's authority to operate this equipment.

RM-564 FCC Draft/Issue 1 EN

Model number 6720c-1b

D
D
A
F
T

Contents

Safety	7	Wrist strap.....	18
About your device.....	7	3. Support	18
Network services.....	8	In-device help.....	18
1. Get started	9	My Nokia.....	18
Insert SIM card and battery.....	9	Nokia support and contact information.....	19
Insert a memory card.....	9	Software updates.....	19
Remove a memory card.....	10	Nokia Software Checker.....	20
Charge the battery.....	10	4. Call functions	20
Switch the device on and off.....	11	Voice calls.....	20
Antenna locations.....	11	Active noise cancellation.....	22
Configuration settings.....	11	Video calls.....	23
Settings wizard.....	12	Call settings.....	24
2. Your device	12	Video sharing.....	25
Keys and parts.....	12	5. Music	26
Home screen.....	13	Music player.....	27
Offline profile.....	13	FM Radio.....	28
Display indicators.....	14	6. Positioning	28
Power saver.....	15	About GPS.....	29
Menu.....	15	Assisted GPS (A-GPS).....	29
Volume control.....	15	Maps.....	29
Keypad lock (keyguard).....	16	Landmarks.....	31
Access codes.....	16	GPS data.....	31
Remote lock.....	16	7. Write text	32
About Download!.....	16	Traditional text input.....	32
Installations.....	17		
Connect a compatible headset.....	17		
Connect a USB data cable.....	17		

Predictive text input.....	33	Nokia Podcasting.....	45
Change the writing language.....	33	Mobile search.....	46
Copy and delete text.....	33		
8. Messaging.....	33	13. Personalisation.....	47
Messaging main view.....	34	Themes.....	46
Write and send messages.....	34	Profiles.....	47
Mail for Exchange.....	35	Sensor settings.....	48
9. Contacts.....	36	14. Time management.....	48
Manage names and numbers.....	36	Alarm clock.....	48
Save and edit names and numbers.....	36	Clock settings.....	48
Ringing tones, images, and call text for contacts.....	37	15. Office applications.....	49
Copy contacts.....	37	PDF reader.....	49
10. Gallery.....	37	Dictionary.....	49
About Photos.....	37	About Quickoffice.....	49
About Video & TV suite.....	38	Converter.....	49
11. Camera.....	38	Calculator.....	50
Capture an image.....	38	Active notes.....	51
Panorama mode.....	39	Notes.....	51
Record videos.....	39	Zip manager.....	52
12. Internet.....	39	16. Settings.....	52
Web browser.....	39	Application settings.....	52
About Contacts on Ovi.....	42	Device and SIM card security.....	52
Nokia Music Store.....	43	Common accessory settings.....	52
About N-Gage.....	43	Speech.....	53
Share online.....	43	Restore original settings.....	53
Nokia Video Centre.....	44	17. Data management.....	53
		Install or remove applications.....	53

Contents

File manager.....	55	Potentially explosive environments.....	68
Device manager.....	55	Emergency calls.....	69
Update device software.....	56	Certification information (SAR).....	69
About Licenses.....	57	Index.....	71
18. Connectivity.....	57		
Transfer content from another device.....	57		
PC connections.....	58		
Bluetooth.....	58		
Data cable.....	61		
Sync.....	61		
Virtual private network.....	61		
19. Green tips.....	62		
Save energy.....	62		
Recycle.....	62		
Save paper.....	62		
Learn more.....	63		
Battery.....	64		
Battery and charger information.....	64		
Nokia battery authentication guidelines.....	65		
Care and maintenance.....	65		
Disposal.....	66		
Additional safety information.....	67		
Small children.....	67		
Operating environment.....	67		
Medical devices.....	67		
Vehicles.....	68		

Safety

Read these simple guidelines. Not following them may be dangerous or illegal. Read the complete user guide for further information.



SWITCH ON SAFELY

Do not switch the device on when wireless phone use is prohibited or when it may cause interference or danger.



ROAD SAFETY COMES FIRST

Obey all local laws. Always keep your hands free to operate the vehicle while driving. Your first consideration while driving should be road safety.



INTERFERENCE

All wireless devices may be susceptible to interference, which could affect performance.



SWITCH OFF IN RESTRICTED AREAS

Follow any restrictions. Switch the device off in aircraft, near medical equipment, fuel, chemicals, or blasting areas.



QUALIFIED SERVICE

Only qualified personnel may install or repair this product.



ACCESSORIES AND BATTERIES

Use only approved accessories and batteries. Do not connect incompatible products.



WATER-RESISTANCE

Your device is not water-resistant. Keep it dry.

About your device

The wireless device described in this guide is approved for use on the (E)GSM 850, 900, 1800, and 1900 networks, and UMTS 850/1900/2100 HSDPA networks. Contact your service provider for more information about networks.

When using the features in this device, obey all laws and respect local customs, privacy and legitimate rights of others, including copyrights.

Copyright protection may prevent some images, music, and other content from being copied, modified, or transferred.

Your device supports several methods of connectivity. Like computers, your device may be exposed to viruses and other harmful content. Exercise caution with messages, connectivity requests, browsing, and downloads. Only install and use services and other software from trustworthy sources that offer adequate security and protection against harmful software, such as applications that are Symbian Signed or have passed the Java Verified™ testing. Consider installing antivirus and other security software on your device and any connected computer.

Your device may have preinstalled bookmarks and links for third-party internet sites. You may also access other third-

Safety

party sites through your device. Third-party sites are not affiliated with Nokia, and Nokia does not endorse or assume liability for them. If you choose to access such sites, you should take precautions for security or content.



Warning: To use any features in this device, other than the alarm clock, the device must be switched on. Do not switch the device on when wireless device use may cause interference or danger.

The office applications support common features of Microsoft Word, PowerPoint, and Excel (Microsoft Office 2000, XP, and 2003). Not all file formats can be viewed or modified.

Remember to make back-up copies or keep a written record of all important information stored in your device.

When connecting to any other device, read its user guide for detailed safety instructions. Do not connect incompatible products.

The images in this guide may differ from your device display.

Network services

To use the device you must have service from a wireless service provider. Many of the features require special network

features. These features are not available on all networks; other networks may require that you make specific arrangements with your service provider before you can use the network services. Using network services involves transmission of data. Check with your service provider for details about fees in your home network and when roaming on other networks. Your service provider can give you instructions and explain what charges will apply. Some networks may have limitations that affect how you can use network services. For instance, some networks may not support all language-dependent characters and services.

Your service provider may have requested that certain features be disabled or not activated in your device. If so, these features will not appear on your device menu. Your device may also have a special configuration such as changes in menu names, menu order, and icons. Contact your service provider for more information.

This device supports WAP 2.0 protocols (HTTP and SSL) that run on TCP/IP protocols. Some features of this device, such as e-mail, browsing, and multimedia messaging (MMS), require network support for these technologies.

1. Get started

Insert SIM card and battery

A USIM card is an enhanced version of the SIM card and is supported by UMTS mobile phones.

1. To remove the back cover of the device, press the back cover with your fingers, slide the cover open (1), and lift the cover off.
2. To remove the battery, lift it from the end (2).
3. Slide the SIM card into the SIM card holder (3).

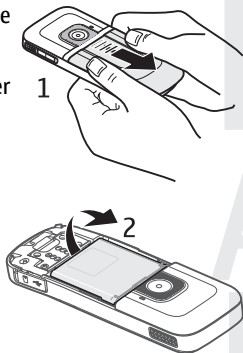

Make sure that the gold-coloured contact area on the card is facing down on the device, and the bevelled corner is facing toward the card holder slot.

4. Replace the battery (4).
5. Replace the back cover (5).

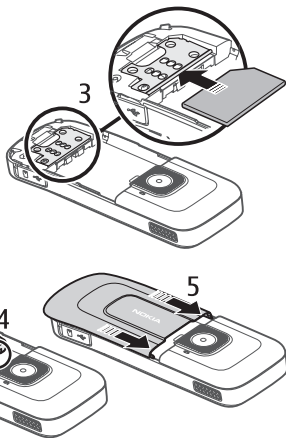

Insert a memory card

The memory card may be supplied with the device, and may already be inserted.

1. Open the memory card slot cover (1).

Get started

2. Place the card in the slot with the contact area facing down (2).
3. Push the card gently to lock it into place. Close the slot cover (3).

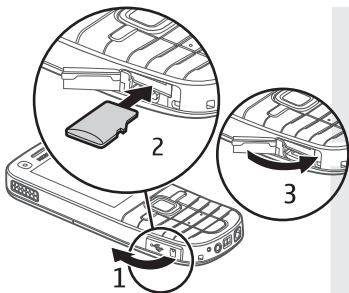

Remove a memory card

 **Important:** Do not remove the memory card in the middle of an operation when the card is being accessed. Removing the card in the middle of an operation may damage the memory card as well as the device, and data stored on the card may be corrupted.

1. Press the power key briefly, and select **Remove memory card > Yes**.
2. Open the memory card slot cover.
3. Press the memory card gently to release it.
4. Pull the card out, and press **OK**.
5. Close the slot cover.

Charge the battery

Your battery has been partially charged at the factory. If the device indicates a low charge, do the following:

1. Connect the charger to a wall outlet.
2. Connect the charger to the device.
3. When the device indicates a full charge, disconnect the charger from the device, then from the wall outlet.

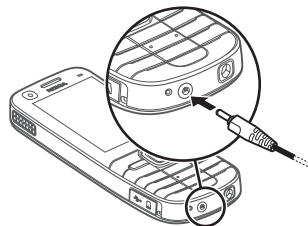

You also may charge the battery with a USB cable with power from a computer.

1. Connect the USB cable to the USB port of a computer and to your device.
2. When the battery is fully charged, disconnect the USB cable.

You do not need to charge the battery for a specific length of time, and you can use the device while it is charging. If the battery is completely discharged, it may take several minutes before the charging indicator appears on the display or before any calls can be made.

Switch the device on and off

Press and hold the power key to switch the device on and off. A short press of this key ends calls and applications.

If the device asks for a PIN code, enter the PIN code, and select **OK**.

If the device asks for the lock code, enter the lock code, and select **OK**. The factory setting for the lock code is 12345.

To set the correct time zone, time, and date, select the country you are presently in, then enter the local time and date.

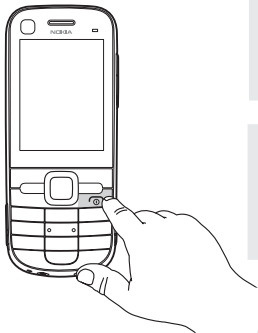

Antenna locations

Your device may have internal and external antennas. As with any radio transmitting device, avoid touching the antenna area unnecessarily while the antenna is transmitting or receiving. Contact with such an antenna affects the communication quality and may cause the device to operate at a higher power level than otherwise needed and may reduce the battery life.



Configuration settings

Before you can use multimedia messaging, e-mail, synchronisation, streaming, and the browser, you must have the proper configuration settings in your device. Your device may automatically configure browser, multimedia messaging, access point, and streaming settings based on the SIM card used. If not, you can use the Settings wizard application to configure the settings. You may receive the settings as a configuration message that you can save to your device. For more information on availability, contact your service provider or nearest authorised Nokia dealer.

When you receive a configuration message, and the settings are not automatically saved and activated, **1 new message** is displayed. To save the settings, select **Show > Options > Save**. You may need to enter a PIN code provided by the service provider.

Your device

Settings wizard

Select  > **Settings** > **Sett. wizard**.

The Settings wizard application configures your device for operator and e-mail settings based on your service provider. Configuring other settings may also be possible.

To use these services, you may have to contact your service provider to activate a data connection or other services.

2. Your device

Keys and parts



- 1 — Earpiece
- 2 — Secondary camera lens
- 3 — Display

- 4 — Menu key 
- 5 — Call key
- 6 — Navi™ key; hereafter referred to as scroll key
- 7 — Light sensor
- 8 — Left and right selection keys
- 9 — Clear key **C**
- 10 — End key and Power key
- 11 — Number keys

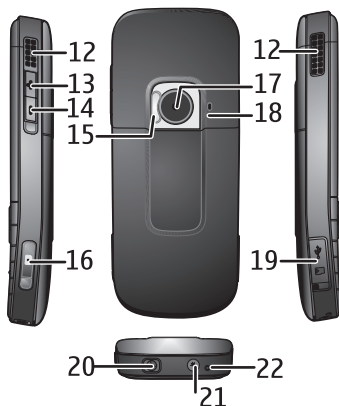

- 12 — Stereo loudspeakers
- 13 — Volume up key
- 14 — Volume down key
- 15 — Camera flash
- 16 — Capture key
- 17 — Main camera lens
- 18 — Secondary microphone for active noise cancellation
- 19 — Micro USB connector and SD memory card slot
- 20 — Nokia AV connector
- 21 — Charger connector
- 22 — Microphone

Home screen

When you have switched on the device, and it is registered to a network, the device is in the home screen and ready for use.

To open a list of most recently dialled numbers, press the call key.

To use voice commands or voice dialling, press and hold the right selection key.

To change the profile, press the power key briefly, and select a profile.

To open a connection to the web, press and hold **0**.

To modify the home screen, select  > **Settings** > **Settings** and **General** > **Personalisation** > **Standby mode** and from the following:

- **Standby theme** — Select a home screen theme.
- **Shortcuts** — Add shortcuts to applications or events, or assign shortcuts to the scroll key, depending on the selected home screen theme.

Offline profile

To quickly activate the Offline profile, press the power key briefly, and select **Offline**.

To switch to another profile, press the power key briefly, and select a profile.

When the Offline profile is active, all connections that use radio frequencies are closed. However, you can use your device without the SIM card and listen to the radio or music.

Your device

Remember to switch off your device when wireless phone use is prohibited.

Display indicators



The device is being used in a UMTS network or a GSM network (network service). The bar next to the icon indicates the signal strength of the network at your current location. The higher the bar, the stronger the signal.



HSDPA (network service) in the UMTS network is activated.



The device is using the Offline profile and is not connected to a cellular network.



The battery charge level. The higher the bar, the stronger the charge in the battery.



You have unread messages in the Inbox folder in Messaging.



You have received new e-mail in the remote mailbox.



There are messages waiting to be sent in the Outbox folder in Messaging.



You have missed calls.



The keys of the device are locked.



An alarm is active.



You have activated the Silent profile, and the device does not ring for an incoming call or message.



Bluetooth connectivity is activated.



A Bluetooth connection is established. When the indicator is blinking, your device is trying to connect with another device.



A GPRS packet data connection is available (network service). indicates that the connection is active. indicates that the connection is on hold.





An EGPRS packet data connection is available (network service). indicates that the connection is active. indicates that the connection is on hold.



A UMTS packet data connection is available (network service). indicates that the connection is active. indicates that the connection is on hold.

356

High-speed downlink packet access (HSDPA) is supported and available (network service). The icon may vary between regions.  indicates that the connection is active.  indicates that the connection is on hold.



Your device is connected to a computer with a USB data cable.



All calls are forwarded to another number.



A headset is connected to the device.



A hands-free car kit is connected to the device.



A loopset is connected to the device.



Your device is synchronising.

Other indicators may also be displayed.

Power saver

Select  > **Settings** > **Settings**.

To set the screen saver settings, select **General** > **Personalisation** > **Display** and from the following:

- **Power saver time-out** — Set the length of time that the device is inactive before the power saver is activated.

- **Light time-out** — Set the length of time that the device is inactive before the screen is dimmed.

Menu

Select .

In the menu, you can access the functions in your device.

To open an application or a folder, select the item.

If you change the order of the functions in the menu, the order may differ from the default order described in this user guide.

To mark or unmark an item in applications, press #.

To mark or unmark several consecutive items, press and hold #, and scroll up or down.

To change the menu view, select **Options** > **Change Menu view**.

To close an application or a folder, select **Options** > **Exit**.

To display and switch between open applications, press and hold , and select an application.

Leaving applications running in the background increases the demand on battery power and reduces the battery life.

Volume control

To adjust the earpiece or loudspeaker volume during a call or when listening to an audio file, press the volume keys.

To activate or deactivate the loudspeaker during a call, select **Loudsp.** or **Handset**.

Your device

Keypad lock (keyguard)

To lock the keypad in the home screen, press the left selection key and * within 1.5 seconds.

To set the device to automatically lock the keypad after a certain time, select  > **Settings** > **Settings** and **General** > **Security** > **Phone and SIM card** > **Keypad autolock period** > **User defined** and the desired time.

To unlock the keypad, select **Unlock**, and press * within 1.5 seconds. When the device or keypad is locked, calls may be possible to the official emergency number programmed into your device.

Access codes

Select  > **Settings** > **Settings**.

To define how your device uses the access codes and security settings, select **General** > **Security** > **Phone and SIM card** and from the following:

- The PIN (UPIN) code, supplied with the SIM (USIM) card, helps to protect the card against unauthorised use.
- The PIN2 (UPIN2) code, supplied with some SIM (USIM) cards, is required to access certain services.
- PUK (UPUK) and PUK2 (UPUK2) codes may be supplied with the SIM (USIM) card. If you enter the PIN code incorrectly three times in succession, you are asked for the PUK code. If the codes are not supplied, contact your service provider.
- The security code helps to protect your phone against unauthorised use. You can create and change the code, and set the phone to request the code. Keep the code

secret and in a safe place separate from your phone. If you forget the code and your phone is locked, your phone will require service and additional charges may apply. For more information, contact your service provider.

- The barring password is required when using the call barring service to restrict calls to and from your phone (network service).

Remote lock

You can lock your device from another device using a text message. To enable your device to be locked remotely, and to define the lock message to be used, select  > **Settings** > **Settings** > **General** > **Security** and **Phone and SIM card** > **Remote phone locking**. When you have entered the message, select **OK**. The message can be up to 20 characters long.

To lock your device, send the lock message as a text message to your mobile phone number. To unlock your device later, select **Unlock**, and enter the lock code.

About Download!

Select  > **Download!**.

With Download!, you can discover, preview, buy, download, and upgrade content, services, and applications. Games, ringing tones, wallpapers, applications, and much more are easily accessible. The items are categorised under catalogues and folders from different service providers. The available content depends on your service provider.

Download! uses your network services to access the most up-to-date content. For information on additional items available through Download!, contact your service provider or the supplier or manufacturer of the item.

Download! receives updates continuously and provides you with the latest content your service provider offers for your device.

Items may be chargeable, but you can usually preview them free of charge. For more information about the charges, contact your service provider or the provider of the item.

To update the content in Download! manually, select **Options > Refresh content**.

Installations

Select **Options > Applications > Installations**.

You can find additional applications and download applications into this folder.

Important: Only install and use applications and other software from trusted sources, such as applications that are Symbian Signed or have passed the Java Verified™ testing.

Connect a compatible headset

Do not connect products that create an output signal as this may cause damage to the device. Do not connect any voltage source to the Nokia AV Connector.

When connecting any external device or any headset, other than those approved by Nokia for use with this device, to the Nokia AV Connector, pay special attention to volume levels.

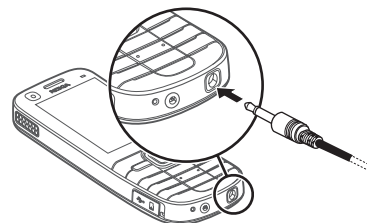

Connect a USB data cable

Connect a compatible USB data cable to the USB connector.

To select the default USB connection mode or change the active mode, select **Options > Settings and Connectivity > USB > USB connection mode** and the desired mode.

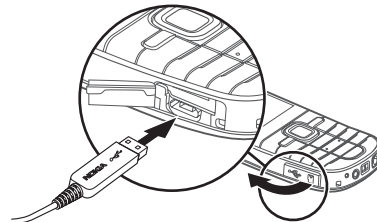

To select whether the default mode is activated automatically, select **Ask on connection**.

Support

Wrist strap

Thread the wrist strap, and tighten it.

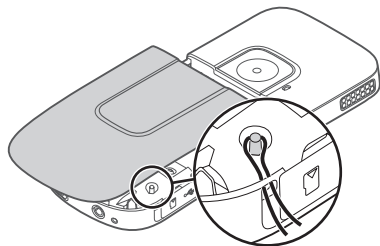

3. Support

In-device help

Your device contains instructions to help to use the applications in your device.

To open help texts from the main menu, select  > **Settings** > **Help** > **Help** and the application for which you want to read instructions.

When an application is open, to access the help text for the current view, select **Options** > **Help**.

When you are reading the instructions, to change the size of the help text, select **Options** > **Decrease font size** or **Increase font size**.

You can find links to related topics at the end of the help text. If you select an underlined word, a short explanation is displayed. Help texts use the following indicators:  shows

a link to a related help topic.  shows a link to the application being discussed.

When you are reading the instructions, to switch between help texts and the application that is open in the background, press and hold the menu key, and select from the list of open applications.

My Nokia

My Nokia is a free service that regularly sends you text messages containing tips, tricks, and support for your Nokia device. If My Nokia is available in your country and supported by your service provider, your device invites you to join the My Nokia service after you have set the time and the date.

To sign-up to My Nokia, select **Accept** and follow the instructions on the display.

Call charges apply when you send messages to sign up or unsubscribe.

For terms and conditions, see the documentation supplied with your device or www.nokia.com/mynokia.

To sign-up to My Nokia later, select  > **Applications** > **My Nokia**. After the invitation to join My Nokia, the Phone setup application starts.

To open the Phone setup application later, select  > **Settings** > **Help** > **Phone setup**.

Nokia support and contact information

Check www.nokia.com/support or your local Nokia Web site for the latest version of this guide, additional information, downloads, and services related to your Nokia product.

On the website, you can get information on the use of Nokia products and services. If you need to contact customer service, check the list of local Nokia contact centers at www.nokia.com/customerservice.

For maintenance services, check your nearest Nokia service center at www.nokia.com/repair.

Software updates

Nokia may produce software updates that offer new features, enhanced functions, and improved performance. You may be able to request these updates through the Nokia Software Updater PC application. Software updates may not be

available for all products or their variants. Not all operators may endorse the latest software versions available.

To update the device software, you need the Nokia Software Updater application and a compatible PC with Microsoft Windows 2000, XP, or Vista operating system, broadband internet access, and a compatible data cable to connect your device to the PC.



Warning: If you install a software update, you cannot use the device, even to make emergency calls, until the installation is completed and the device is restarted. Be sure to back up data before accepting installation of an update.

The download and installation may take up to 20 minutes with Device manager and up to 30 minutes with Nokia Software Updater.

To get more information and to download the Nokia Software Updater application, visit www.nokiausa.com/softwareupdate in the United States or www.nokia-latinoamerica.com/nsu in Latin America.

If software updates over the air are supported by your network, you may also be able to request updates through the device.

Your device may be able to periodically check for new software updates with Nokia Software Checker. Select  > **Settings** > **SW checker**.



Tip: To check the software version in your device, enter ***#0000#** in the home screen.

Call functions

Nokia Software Checker

Nokia Software checker

Select  > **Settings** > **SW checker**.

Nokia may produce software updates for your device that offer new features, enhanced functionality, and improved performance. Software updates may not be available for all products or their variants. Not all service providers may endorse the latest software versions available.

Your device may be able to periodically check for new software updates with Nokia Software checker.

Select **Options** and from the following:

- **Check for updates** — Check if software updates are available for your device.

4. Call functions

Voice calls

Make a call



Important: If the device has been locked, enter the lock code to activate the phone function.

When the device is locked, calls may be possible to the official emergency number. Making an emergency call in the offline profile or when the device is locked requires that the device recognise the number to be an official emergency number. It is advisable to change the profile or unlock the device by entering the lock code before you make the emergency call.

- **Settings** — Adjust the application settings, such as how often your device checks for updates and which access point is used.

Software checker settings

Select  > **Settings** > **SW checker**.

To modify the software checker settings, select **Options** > **Settings** and from the following:

- **Checking frequency** — Define how often the device checks for updates, or deactivate the automatic checking.
- **Default Access Point** — Select the default access point that the application uses to check for software updates.

To make a call, enter the phone number, including the area code, and press the call key.



Tip: For international calls, add the + character that replaces the international access code, and enter the country code, area code (omit the leading 0, if necessary), and phone number.

To end the call or cancel the call attempt, press the end key.

To make a call using the saved contacts, open the contacts. Enter the first letters of the name, scroll to the name, and press the call key.

To make a call using the log, press the call key to view up to 20 numbers that you last called or attempted to call. Scroll to the desired number or name, and press the call key.

To adjust the volume of an active call, use the volume keys.

To switch from a voice call to a video call, select **Options** > **Switch to video call**. The device ends the voice call and makes a video call to the recipient.

Speed dialling

Select  > **Settings** > **Settings** and **Phone** > **Call** > **Speed dialling**.

Speed dialling allows you to make a call by pressing and holding a number key in the home screen.

To activate speed dialling, select **On**.

To assign a number key to a phone number, select  > **Settings** > **Speed dial**. Scroll to the number key (2 - 9) on the display, and select **Options** > **Assign**. Select the desired number from the contacts list.

To delete the phone number assigned to a number key, scroll to the speed dialling key, and select **Options** > **Remove**.

To modify a phone number assigned to a number key, scroll to the speed dialling key, and select **Options** > **Change**.

Voice mail

Select  > **Settings** > **Call mailbox**.

When you open the Voice mail application for the first time, you are asked to enter the number of your voice mailbox.

To call your voice mailbox, scroll to Voice mailbox, and select **Options** > **Call voice mailbox**.

To call your video mailbox, scroll to Video mailbox, and select **Options** > **Call video mailbox**.

To call your mailbox in the home screen, press and hold **1**; or press **1** and then the call key. Select the mailbox you want to call.

To change the mailbox number, select the mailbox and **Options** > **Change number**.

Voice dialling

Make a phone call by saying the name that is saved in the contacts list.



Note: Using voice tags may be difficult in a noisy environment or during an emergency, so you should not rely solely upon voice dialling in all circumstances.

1. In the home screen, press and hold the right selection key. A short tone sounds, and **Speak now** is displayed.
2. Say the name of the contact you want to dial. If the voice recognition is successful, a list of proposed matches is displayed. The phone plays the voice command of the first match on the list. If it is not the correct command, scroll to another entry.

Make a conference call

1. To make a conference call, enter a participant's phone number, and press the call key.

Call functions

2. When the participant answers, select **Options** > **New call**.
3. When you have made a phone call to all the participants, select **Options** > **Conference** to merge the calls into a conference call.

To mute the microphone of your device during the call, select **Options** > **Mute**.

To drop a participant from the conference call, scroll to the participant, and select **Options** > **Conference** > **Drop participant**.

To discuss privately with a conference call participant, scroll to the participant, and select **Options** > **Conference** > **Private**.

Answer a call

To answer a call, press the call key.

To reject a call, press the end key.

To mute the ringing tone instead of answering a call, select **Silence**.

When you have an active call and the call waiting function (network service) is activated, press the call key to answer a new incoming call. The first call is put on hold. To end the active call, press the end key.

Call and data registers

Select  > **Log**.

To view recently missed, received, and dialled calls, select **Recent calls**.



Tip: To view the dialled numbers when in the home screen, press the call key.

To view the approximate duration of calls to and from your device, select **Call duration**.

To view the amount of data transferred during packet data connections, select **Packet data**.

Active noise cancellation

Noise from the surrounding environment is actively removed from your speech and at the earpiece using dual microphone noise cancellation technology.

Noise picked up by a secondary microphone is removed from the signal of the main microphone into which you speak. This results in a significantly improved transmission of speech in a noisy environment. This feature is always activated.

Additionally, you can activate the active noise cancellation also at the earpiece. To activate this feature, select  > **Settings** > **Settings** and **Phone** > **Call** > **Noise cancellation**.

Active noise cancellation is not available if handsfree mode or the loudspeaker is active.

For the best noise cancellation, hold the device with the earpiece to your ear and the main microphone (1) towards your mouth. Do not cover the microphone (2) at the back of the device.

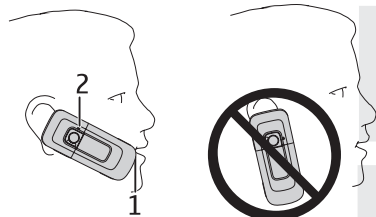

Video calls

Make a video call



Warning: Do not hold the device near your ear when the loudspeaker is in use, because the volume may be extremely loud.

To make a video call, enter the phone number or select the recipient from the contacts list and **Options > Call > Video call**. When the video call starts, the camera of the device is activated. If the camera is already in use, video sending is disabled. If the recipient of the call does not want to send video back to you, a still image is shown instead. To define the still image sent from your device instead of video, select **⚙ > Settings > Settings and Phone > Call > Image in video call**.

To disable the sending of audio, video, or video and audio, select **Options > Disable > Sending audio, Sending video, or Sending aud. & video**.

To adjust the volume of an active video call, use the volume keys.

To use the loudspeaker, select **Options > Activate loudspeaker**. To mute the loudspeaker and use the earpiece, select **Options > Activate handset**.

To swap the places of images, select **Options > Swap images**.

To zoom the image on the display, select **Options > Zoom** and scroll up or down.

To end the video call and make a new voice call to the same recipient, select **Options > Switch to voice call**.

Answer or decline a video call

When a video call arrives,  is displayed.

To answer the video call, press the call key. **Allow video image to be sent to caller?** is displayed. To start sending live video image, select **Yes**.

If you do not activate the video call, you only hear the sound of the caller. A grey screen replaces the video image. To replace the grey screen with a still image captured by the camera in your device, select **Tools > Settings > Phone > Call > Image in video call**.

To end the video call, press the end key.

Call settings

Call settings

Select  > **Settings** > **Settings and Phone** > **Call**.

Select from the following:

- **Send my caller ID** — Display your phone number to the person you are calling.
- **Call waiting** — Set the device to notify you of incoming calls while you are in a call (network service).
- **Reject call with message** — Reject a call, and send a text message to the caller.
- **Message text** — Write the standard text message that is sent when you reject a call.
- **Own video in recvd. call** — Allow or deny video sending during a video call from your device.
- **Image in video call** — Display a still image if video is not sent during a video call.
- **Automatic redial** — Set your device to make a maximum of 10 attempts to connect the call after an unsuccessful call attempt. To stop automatic redialling, press the end key.
- **Show call duration** — Display the length of a call during the call.
- **Summary after call** — Display the length of a call after the call.
- **Speed dialling** — Activate speed dialling.
- **Anykey answer** — Activate anykey answer.
- **Noise cancellation** — Activate earpiece active noise cancellation.

Call divert

Select  > **Settings** > **Settings and Phone** > **Call divert**.

Divert incoming calls to your voice mailbox or to another phone number. For details, contact your service provider.

Select the type of calls to divert and from the following options:

- **All voice calls** or **All fax calls** — Divert all incoming voice or fax calls. You cannot answer data or fax calls, only divert the calls to another number.
- **If busy** — Divert incoming calls if you have an active call.
- **If not answered** — Divert incoming calls after your device rings for a specified length of time. Select the length of time for the device to ring before diverting the call.
- **If out of reach** — Divert calls when the device is switched off or out of network coverage.
- **If not available** — Divert calls if you have an active call, do not answer, or the device is switched off or out of network coverage.

To divert calls to your voice mailbox, select a call type, a diverting option, and **Options** > **Activate** > **To voice mailbox**.

To divert calls to another phone number, select a call type, a diverting option, and **Options** > **Activate** > **To other number**. Enter the number, or select **Find** to retrieve a number saved in Contacts.

To check the current diverting status, scroll to the diverting option, and select **Options** > **Check status**.

To stop diverting calls, scroll to the diverting option, and select **Options > Deactivate**.

Call barring

Select  > **Settings > Settings and Phone > Call barring**.

You can bar the calls that can be made or received with the device (network service). To change the settings, you need the barring password from your service provider. Call barring affects all call types.

Call barring and call diverting cannot be active at the same time.

When calls are barred, calls may be possible to certain official emergency numbers.

To bar calls, select from the following:

- **Outgoing calls** — Prevent making voice calls with your device.
- **Incoming calls** — Prevent incoming calls.
- **International calls** — Prevent calling to foreign countries or regions.
- **Incoming calls when roaming** — Prevent incoming calls when outside your home country.
- **International calls except to home country** — Prevent calls to foreign countries or regions, but allow calls to your home country.

To check the status of voice call barrings, select the barring option and **Options > Check status**.

To deactivate all voice call barrings, select a barring option and **Options > Deactivate all barrings**.

To change the password used for barring voice and fax calls, select . Enter the current code, then the new code twice. The barring password must be four digits long. For details, contact your service provider.

Network settings

Select  > **Settings > Settings and Phone > Network**.

To select the network mode, select **Network mode** and **Dual mode, UMTS**, or **GSM**. In dual mode, the device switches automatically between networks.



Tip: Selecting **UMTS** enables faster data transfer, but may increase the demand on battery power and reduce the battery life. In regions close to both GSM and UMTS networks, selecting **Dual mode** may cause constant jumping between the two networks, which also increases the demand on battery power.

To select the operator, select **Operator selection** and **Manual** to select from available networks, or **Automatic** to set the device to select the network automatically.

To set the device to indicate when it is used in a microcellular network (MCN), select **Cell info display > On**.

Video sharing

Video sharing requirements

Video sharing requires a UMTS connection. For more information on the service, UMTS network availability, and

Music

fees associated with using this service, contact your service provider.

To use video sharing you must do the following:

- Ensure that your device is set up for person-to-person connections.
- Ensure you have an active UMTS connection and are within UMTS network coverage. If you move outside the UMTS network during a video sharing session, the sharing stops while your voice call continues.
- Ensure that both the sender and recipient are registered to the UMTS network. If you invite someone to a sharing session and the recipient's device is not within UMTS network coverage, does not have video sharing installed, or person-to-person connections set up, the recipient does not receive invitations. You receive an error message that indicates that the recipient cannot accept the invitation.

Share live video or video clips

During an active voice call, select **Options** > **Share video**.

1. To share live video during the call, select **Live video**.









To share a video clip, select **Video clip** and the clip you want to share.

You may need to convert the video clip into a suitable format to be able to share it. If your device notifies you that the video clip must be converted, select **OK**. Your device must have a video editor for the conversion to work.

2. If the recipient has several SIP addresses or phone numbers including the country code saved in the contacts list, select the desired address or number. If the SIP address or phone number of the recipient is not available, enter the address or number of the recipient including the country code, and select **OK** to send the invitation. Your device sends the invitation to the SIP address.

Sharing begins automatically when the recipient accepts the invitation.

Options during video sharing

-  Zoom the video (available for sender only).
-  Adjust the brightness (available for sender only).
-  or  Mute or unmute the microphone.
-  or  Turn the loudspeaker on and off.
-  or  Pause and resume video sharing.
-  Switch to full screen mode (available for receiver only).

3. To end the sharing session, select **Stop**. To end the voice call, press the end key. When you end the call, video sharing also ends.

To save the live video you shared, select **Yes** when prompted. The device notifies you of the location of the saved video.

If you access other applications while you are sharing a video clip, the sharing is paused. To return to the video sharing view, and to continue sharing, in the home screen, select **Options** > **Continue**.

5. Music

 **Warning:** Listen to music at a moderate level. Continuous exposure to high volume may damage your hearing. Do not hold the device near your ear when the loudspeaker is in use, because the volume may be extremely loud.

You can listen to music and podcast episodes also when the offline profile is activated. See "Offline profile", p. 13.

Music player

Select  > **Applications** > **Music player**.

With Music player, you can play music files, and create and listen to playlists. Music player supports file formats such as MP3 and AAC.

Play a song or a podcast episode

To add all available songs and podcasts to the music library, select **Options** > **Refresh library**.

To play a song or a podcast episode, select the desired category, and the song or podcast episode.

To pause playback, press the scroll key; to resume, press the scroll key again. To stop playback, scroll down.

To fast-forward or rewind, press and hold the scroll key to the right or left.

To skip to the next item, scroll right. To return to the beginning of the item, scroll left. To skip to the previous item, scroll left again within 2 seconds after a song or podcast has started.

To modify the tone of the music playback, select **Options** > **Equaliser**.

To modify the balance and stereo image, or to enhance bass, select **Options** > **Audio settings**.

To view a visualisation during playback, select **Options** > **Show visualisation**.

To return to the home screen and leave the player playing in the background, press the end key.



Say and Play

With Say and Play, you can start playing the music you wish by saying, for example, the artist's name.

To start the Say and Play application, press and hold the * key. When the tone sounds, say an artist's name, artist's name and song title, album title, or playlist title. Hold the device about 20 cm (8 inches) from your mouth, and speak in a regular tone. Do not cover the device microphone with your hand.

When you use Say and Play for the first time, and after you have downloaded new songs to your device, to update voice commands, select **Options** > **Refresh**.

Positioning

 **Tip:** You can also start the Say and Play application by selecting  > **Internet** > **Music search**.

The voice commands are based on the metadata (artist's name and song title) of the songs in your device. Say and Play supports two spoken languages: English and the language you have chosen as the device language. The written language of the song metadata must match either English or your chosen device language.

 **Tip:** To improve search accuracy, use the voice commands for dialling. The dialler adapts to your voice and uses it also for music search.

Transfer music from PC

To transfer music from your PC, connect your device to the PC with a compatible USB data cable or Bluetooth connectivity. If you are using the USB cable, select **Mass storage** as the connection mode. Make sure that a compatible memory card is inserted in the device.

If you select **Media transfer** as the connection mode, you can use Windows Media Player to synchronise music between your device and PC.

FM Radio

Listen to the radio

Select  > **Applications** > **Radio**.

The FM radio depends on an antenna other than the wireless device antenna. A compatible headset or accessory needs to be attached to the device for the FM radio to function properly.





Warning: Listen to music at a moderate level. Continuous exposure to high volume may damage your hearing. Do not hold the device near your ear when the loudspeaker is in use, because the volume may be extremely loud.

The quality of the radio broadcast depends on the coverage of the radio station in that particular area.

You can make a call or answer an incoming call while listening to the radio. The radio is muted when there is an active call.

To start a station search, select  or .

If you have saved radio stations in your device, to go to the next or previous saved station, select  or .

Select **Options** and from the following:

- **Manual tuning** — Change the frequency manually.
- **Station directory** — View available stations based on location (network service).
- **Save station** — Save the station to which you are currently tuned to your station list.
- **Stations** — Open the list of your saved stations.
- **Play in background** — Return to the home screen while listening to the FM radio in the background.

6. Positioning

About GPS

The coordinates in the GPS are expressed in the degrees and decimal degrees format using the international WGS-84 coordinate system.

The Global Positioning System (GPS) is operated by the government of the United States, which is solely responsible for its accuracy and maintenance. The accuracy of location data can be affected by adjustments to GPS satellites made by the United States government and is subject to change with the United States Department of Defense civil GPS policy and the Federal Radionavigation Plan. Accuracy can also be affected by poor satellite geometry. Availability and quality of GPS signals may be affected by your location, buildings, natural obstacles, and weather conditions. The GPS receiver should only be used outdoors to allow reception of GPS signals.

Any GPS should not be used for precise location measurement, and you should never rely solely on location data from the GPS receiver and cellular radio networks for positioning or navigation.

Different positioning methods can be enabled or disabled in positioning settings.

Assisted GPS (A-GPS)

Your device also supports assisted GPS (A-GPS).

A-GPS is a network service.

Assisted GPS (A-GPS) is used to retrieve assistance data over a packet data connection, which assists in calculating the coordinates of your current location when your device is receiving signals from satellites.

When you activate A-GPS, your device receives useful satellite information from an assistance data server over the cellular network. With the help of assisted data, your device can obtain the GPS position faster.

Your device is preconfigured to use the Nokia A-GPS service, if no service provider-specific A-GPS settings are available. The assistance data is retrieved from the Nokia A-GPS service server only when needed.

To disable the A-GPS service, select  > **Settings** > **Connectivity** > **GPS data and Options** > **Positioning settings** > **Positioning methods** > **Assisted GPS** > **Disable**.

You must have an internet access point defined in the device to retrieve assistance data from the Nokia A-GPS service over a packet data connection. The access point for A-GPS can be defined in positioning settings. Only a packet data internet access point can be used. Your device asks you to select the internet access point when GPS is used for the first time.

Maps

Select  > **Maps**.

Positioning

About Maps

With Maps, you can see your current location on the map, browse maps of different cities and countries, search for places, plan routes from one location to another, save locations, and send them to compatible devices. You can also purchase licences for traffic information and navigation services, if available for your country or region.

When you use Maps for the first time, you may need to select an internet access point for downloading maps.

If you browse to an area which is not covered by maps already downloaded in your device, a map for the area is automatically downloaded through the internet. Some maps may be available in your device or on a memory card. You can also use the Nokia Map Loader PC software to download maps. To install Nokia Map Loader to a compatible PC, see www.nokia.com/maps.



Tip: To avoid data transfer costs, you can also use Maps without an internet connection, and browse the maps that are saved in your device or memory card.



Note: Downloading maps may involve the transmission of large amounts of data through your service provider's network. Contact your service provider for information about data transmission charges.

Almost all digital cartography is inaccurate and incomplete to some extent. Never rely solely on the cartography that you download for use in this device.

For instructions on how to use the various features of Maps, select  > **Settings** > **Help** > **Help** and **Maps**, or when using Maps, select **Options** > **Help**.

Move on a map

When the GPS connection is active,  shows your current location on the map.

To zoom in to your current or last known location, select **Options** > **My position**.

To move on the map, scroll up, down, left, or right with the scroll key. The map is oriented towards north by default.

When you have an active GPS connection and browse the map on the display, a new map is automatically downloaded if you scroll to an area not covered by the maps that have already been downloaded. The maps are automatically saved in the device memory or on a compatible memory card, if inserted.

To zoom in and out on the map, press * and #.

To change the map type, select **Options** > **Map mode**.

Display indicators

The GPS indicator  shows the availability of the satellite signals. One bar is one satellite. When the device tries to find satellite signals, the bar is yellow. When the device receives enough data from the satellites for GPS to calculate your location, the bar turns green. The more green bars, the more reliable the location calculation.

Initially, your device must receive signals from at least four satellites to calculate the coordinates of your location. After

the initial calculation, signals from three satellites may be enough.

The data transfer indicator  **21.5 kb** shows the internet connection used, and the amount of data transferred since the application started.

Landmarks



Select  > **Applications** > **Landmarks**.

With Landmarks, you can save the position information of specific locations in your device. You can sort the saved locations into different categories, such as business, and add other information to them, such as addresses. You can use your saved landmarks in compatible applications, such as GPS data.

GPS coordinates are expressed in the degrees and decimal degrees format using the international WGS-84 coordinate system.

Select **Options** and from the following:

- **New landmark** — Create a new landmark. To make a positioning request for your current location, select **Current position**. To select the location from map, select **Select from map**. To enter the position information manually, select **Enter manually**.
- **Edit** — Edit or add information to a saved landmark (for example, a street address).
- **Add to category** — Add a landmark to a category in Landmarks. Select each category to which you want to add the landmark.

- **Send** — Send one or several landmarks to a compatible device. Your received landmarks are placed in the Inbox folder in Messaging.

You can sort your landmarks into preset categories, and create new categories. To edit and create new landmark categories, open the categories tab, and select **Options** > **Edit categories**.

GPS data

Route guidance

Select  > **Settings** > **Connectivity** > **GPS data and Navigation**.

Start the route guidance outdoors. If started indoors, the GPS receiver may not receive the necessary information from the satellites.

Route guidance uses a rotating compass on the device display. A red ball shows the direction to the destination, and the approximate distance to it is shown inside the compass ring.

Route guidance is designed to show the straightest route and the shortest distance to the destination, measured in a straight line. Any obstacles on the route, such as buildings and natural obstacles, are ignored. Differences in altitude are not taken into account when calculating the distance. Route guidance is active only when you move.

To set your trip destination, select **Options** > **Set destination** and a landmark as the destination, or enter the latitude and longitude coordinates.

Write text

To clear the destination set for your trip, select **Stop navigation**.

Retrieve position information

Select  > **Settings** > **Connectivity** > **GPS data and Position**.

In the position view, you can view the position information of your current location. An estimate of the accuracy of the location is displayed.

To save your current location as a landmark, select **Options** > **Save position**. Landmarks are saved locations with more information, and they can be used in other compatible applications and transferred between compatible devices.

Trip meter

Select  > **Settings** > **Connectivity** > **GPS data and Trip distance**.

The trip meter has limited accuracy, and rounding errors may occur. Accuracy can also be affected by availability and quality of GPS signals.

To turn trip distance calculation on or off, select **Options** > **Start** or **Stop**. The calculated values remain on the display. Use this feature outdoors to receive a better GPS signal.

To set the trip distance and time and average and maximum speeds to zero, and to start a new calculation, select **Options** > **Reset**. To set the trip meter and total time to zero, select **Restart**.

7. Write text

Traditional text input

Abc indicates traditional text input.

ABC and **abc** indicate the uppercase and lowercase.

Abc indicates the sentence case, that is, the first letter of the sentence is written in uppercase and all the other letters are automatically written in lowercase. **123** indicates number mode.

To write text with the keypad, press a number key, 2-9, repeatedly until the desired character is displayed. There are more characters available for a number key than are printed on the key. If the next letter is located on the same key as the present one, wait until the cursor is displayed, and enter the letter.

To insert a number, press and hold the number key.

To switch between the different character cases and modes, press **#**.

To erase a character, press the clear key. Press and hold the clear key to erase more than one character.

To enter the most common punctuation marks, press **1** repeatedly until the desired punctuation mark is displayed.

To add special characters, press and hold *****.

To insert a space, press **0**. To insert a line break, press **0** three times.

Predictive text input

1. To activate predictive text input, press **#** twice quickly. This activates predictive text input for all editors in the device. The indicator  is shown on the display.
2. To write the desired word, press **2-9**. Press each key only once for one letter.
3. When you have finished writing the word and it is correct, scroll right to confirm it, or press **0** to add a space.

If the word is not correct, press ***** repeatedly to view the matching words the dictionary has found.

If the **?** character is shown after the word, the word you intended to write is not in the dictionary. To add a word to the dictionary, select **Spell**, enter the word (up to 32 letters) using traditional text input, and select **OK**. The word is added to the dictionary. When the dictionary is full, the new word replaces the oldest added word.

Write the first half of a compound word; to confirm it, scroll right. Write the last part of the compound word. To complete the compound word, press **0** to add a space.

To switch predictive text input off for all editors in the device, press **#** twice quickly.

Change the writing language

When you are writing text, you can change the writing language. For example, if you press the **6** key repeatedly to reach a specific character, changing the writing language gives you access to characters in a different order.

If you are writing text using a non-Latin alphabet and want to write Latin characters, for example e-mail or web addresses, you may need to change the writing language. To change the writing language, select **Options > Input options > Writing language**, and a writing language that uses Latin characters.

Copy and delete text

1. To select letters and words, press and hold **#**, and at the same time scroll left or right. To select lines of text, press and hold **#**, and at the same time scroll up or down.
2. To copy the text, press and hold **#**, and at the same time select **Copy**.
To delete the selected text, press the clear key **C**.
3. To paste the text, scroll to the desired location, press and hold **#**, and at the same time select **Paste**.

8. Messaging



Only devices that have compatible features can receive and display multimedia messages. The appearance of a message may vary depending on the receiving device.

Messaging main view



Press , and select **Messaging** (network service).



To create a new message, select **New message**.

Messaging contains the following folders:

-  **Inbox** — Received messages, except e-mail and cell broadcast messages, are stored here.
-  **My folders** — Organise your messages into folders.

 **Tip:** To avoid rewriting messages that you send often, use texts in the **Templates** folder in **My folders**. You can also create and save your own templates.

-  **New mailbox** — Connect to your remote mailbox to retrieve your new e-mail messages, or view your previously retrieved e-mail messages offline.
-  **Drafts** — Draft messages that have not been sent are stored here.
-  **Sent** — The last messages that have been sent, excluding messages sent using Bluetooth connectivity, are stored here. You can change the number of messages to save in this folder.

-  **Outbox** — Messages waiting to be sent are temporarily stored in the outbox, for example, when your device is outside network coverage.
-  **Reports** — You can request the network to send you a delivery report of the text messages and multimedia messages you have sent (network service).

Write and send messages

Select  > **Messaging**.

Before you can create a multimedia message or write an e-mail, you must have the correct connection settings in place.

The wireless network may limit the size of MMS messages. If the inserted picture exceeds this limit the device may make it smaller so that it can be sent by MMS.

1. Select **New message** > **Message** to send a text or multimedia message (MMS), **Audio message** to send a multimedia message that includes one sound clip, or **E-mail** to send an e-mail message.
2. In the To field, press the scroll key to select recipients or groups from the contacts list, or enter the recipient's phone number or e-mail address. To add a recipient (;) that separates the recipients, press *.
3. In the Subject field, enter the subject of the e-mail. To change the fields that are visible, select **Options** > **Message header fields**.

4. In the message field, write the message.
5. To add a media object to a multimedia message, select **Options** > **Insert content**, the object type or source, and the desired object. To add a business card, slide, note, or some other file to the message, select **Options** > **Insert content** > **Insert other**.
6. To capture an image or record a video or sound clip for a multimedia message, select **Options** > **Insert content** > **Insert image** > **New**, **Insert video clip** > **New**, or **Insert sound clip** > **New**.
7. To add an attachment to an e-mail, select **Options** and the attachment type. E-mail attachments are indicated with .
8. To send the message, select **Options** > **Send**, or press the call key.



Note: The message sent icon or text on your device screen does not indicate that the message is received at the intended destination.

Your device supports text messages beyond the limit for a single message. Longer messages are sent as two or more messages. Your service provider may charge accordingly. Characters with accents or other marks, and characters from some language options, take up more space, and limit the number of characters that can be sent in a single message.

You may not be able to send video clips that are saved in the MP4 file format or that exceed the size limit of the wireless network in a multimedia message.

Mail for Exchange

With Mail for Exchange, you can receive your work e-mail to your device. You can read and reply to your e-mails, view and edit attachments, view calendar information, receive and reply to meeting requests, schedule meetings, and view, add, and edit contact information. Mail for Exchange can be set up only if your company has Microsoft Exchange Server. In addition, your company's IT administrator must have activated Mail for Exchange for your account.

Before starting to set up Mail for Exchange, ensure that you have the following:

- A corporate e-mail ID
- Your office network user name
- Your office network password
- Your network domain name (contact your company's IT department)
- Your Mail for Exchange server name (contact your company's IT department)

Depending on your company's Mail for Exchange server configuration, you may need to enter other information in addition to those listed. If you do not know the correct information, contact your company's IT department.

With Mail for Exchange, the use of the lock code may be mandatory. The default lock code of your device is 12345, but your company's IT administrator may have set a different one for you to use.

Depending on your company, the Mail for Exchange installation may show you different information popups

Contacts

during the setup process. Read the popups, and select **Continue**, **OK**, **Next**, or **Yes** to continue.

To set up Mail for Exchange:

1. In the home screen, select the e-mail wizard.
2. Select **Start e-mail setup**.
3. Read the information, and select **Start**.
4. To allow your device to access the network, select **Yes**.
5. Enter your e-mail address, and select **OK**.
6. Enter your password, and select **OK**.

7. Enter your user name, and select **OK**.
8. Select Mail for Exchange.
9. Enter the domain name of your network, and select **OK**.
10. Enter the Mail for Exchange server name, and select **OK**.
11. To install the Mail for Exchange application to your device, select **Yes**.

After the setup, you may create your Mail for Exchange profile by changing the settings. Depending on your company, the profile may be created automatically.

9. Contacts

Select  > **Contacts**.

In Contacts, you can save and update contact information, such as phone numbers, home addresses, or e-mail addresses of your contacts. You can add a personal ringing tone or a thumbnail image to a contact card. You can also create contact groups, which allow you to send text messages or e-mail to many recipients at the same time.

To listen to the voice tag assigned to the contact, select a contact card and **Options** > **Voice tag details** > **Play voice tag**.

Save and edit names and numbers

1. Press , and select **Contacts** > **Options** > **New contact**.

2. Fill in the fields that you want, and select **Done**.

To edit contact cards, scroll to a contact, and select **Options** > **Edit**. You can also search for the desired contact by entering the first letters of the name to the search field.

To attach an image to a contact card, open the contact card, and select **Options** > **Add image**. The image is shown when the contact calls.

Manage names and numbers

To delete a contact card, select a card, and press **C**.

To delete several contact cards at the same time, select **Options** > **Mark/Unmark** to mark the desired contact cards, and press **C** to delete.

To send contact information, select a card, **Options** > **Send**, and the desired option.

Ringling tones, images, and call text for contacts

You can define a ringing tone for a contact or group, and an image and a call text for a contact. When the contact calls you, the device plays the selected ringing tone and shows the call text or image (if the caller's phone number is sent with the call and your device recognises it).

To define a ringing tone for a contact or a contact group, select the contact or contact group and **Options** > **Ringling tone**, and a ringing tone.

To define a call text for a contact, select the contact and **Options** > **Add text for call**. Enter the call text, and select **OK**.

To add an image for a contact saved in the device memory, select the contact, **Options** > **Add image**, and an image from Gallery.

To remove the ringling tone, select **Default tone** from the list of ringling tones.

To view, change or remove the image from a contact, select the contact, **Options** > **Image**, and the desired option.

Copy contacts

When you open the contacts list for the first time, the device asks if you want to copy names and numbers from the SIM card to your device.

To start copying, select **OK**.

If you do not want to copy the contacts from the SIM card to your device, select **Cancel**. The device asks if you want to view the SIM card contacts in the contacts directory. To view the contacts, select **OK**. The contacts list opens, and the names stored on your SIM card are indicated with .

10. Gallery

Select  > **Gallery**.

Use Gallery to access different types of media, such as images and videos, music, sound clips, streaming links and presentations. All viewed images and videos, and music and sound clips are automatically saved to Gallery. Sound clips and music are played in the Music player, streaming links by the Video centre. Images are viewed and videos are played with the Photos application.

About Photos

Select  > **Gallery** > **Images & videos** and from the following:

- **Captured** — View all the images and videos you have captured.
- **Months** — View images and videos categorised by the month they were captured.

Camera

- **Albums** — View the default albums and the ones you have created.
- **Tags** — View the tags you have created for each item.
- **Downloads** — View items and videos downloaded from the web or received as a multimedia or e-mail message.
- **All** — View all items.
- **Share online** — Post your images or videos to the web.

Files stored on your compatible memory card (if inserted) are indicated with .

To copy or move files to another memory location, select a file, **Options** > **Move and copy**, and from the available options.

About Video & TV suite

With Video & TV suite (network service), you can download and stream video clips over the air from compatible internet

video services. You can also transfer video clips from a compatible PC to your device and view them in Video & TV suite.

Using packet data access points to download video clips may involve the transmission of large amounts of data through your service provider's network. Contact your service provider for information about data transmission charges.

Your device may have predefined services. Service providers may provide free content or charge a fee. Check the pricing in the service or from the service provider.

11. Camera

Capture an image

Select  > **Camera**. The screen is automatically rotated to landscape mode.

To capture an image, use the display as a viewfinder, and press the capture key. The device saves the image in Gallery.

To zoom in or out before capturing an image, use the volume keys.







To focus on the subject before capturing the image, press the capture key halfway down.

The toolbar provides you with shortcuts to different items and settings before and after capturing an image or recording a video clip. Select from the following:

 Switch between video and image mode.

 Select the scene.

 Activate panorama mode.

-  Turn the video light on (video mode only).
-  Select the flash mode (images only).
-  Activate the self-timer (images only).
-  Activate sequence mode (images only).
-  Select a colour effect.
-  Adjust the white balance.
-  Go to Photos.

The available options vary depending on the capture mode and view you are in. The settings return to the default values when you close the camera.

To customise the camera toolbar, select **Options** > **Customise toolbar**.

To activate the toolbar when it is hidden, press the scroll key.

Panorama mode

Select panorama mode  from the toolbar.

To start capturing a panoramic image, press the capture key.

Slowly turn the camera left or right to start capturing the panoramic image. A panorama preview is displayed and the camera captures the image as you turn. The green arrow indicates that you can slowly proceed to turn. The red pause mark indicates that you should stop moving until the green arrow is displayed again. You can predict when the next key frame will be captured when the red rectangle moves to the centre of the preview area.

To complete the capture, press the capture key or select **Stop**. The panoramic capture stops automatically when the maximum image width has been reached.

Record videos

1. If the camera is in the image mode, select the video mode from the toolbar.
2. To start recording, press the capture key.
3. To pause recording at any time, select **Pause**. Select **Continue** to resume recording.
4. To stop recording, select **Stop**. The video clip is automatically saved in Gallery. The maximum length of the video clip depends on the available memory.

designed specifically for mobile devices, and use extensible hypertext markup language (XHTML), or the wireless markup language (WML).

To browse the web, you need to have an internet access point configured in your device.

12. Internet

Web browser

With the Web browser application, you can view hypertext markup language (HTML) web pages on the internet as originally designed. You can also browse web pages that are

Internet

Browse the web

Select  > **Internet** > **Web**.



Shortcut: To start the browser, press and hold **0** in the home screen.



Important: Use only services that you trust and that offer adequate security and protection against harmful software.



Important: Only install and use applications and other software from trusted sources, such as applications that are Symbian Signed or have passed the Java Verified testing.

The web browser starts with a homepage or the bookmark list. To change the browser start page, select **Options** > **Settings** > **General** > **Homepage**.

To browse a web page, in the bookmarks view, select a bookmark, or enter the address in the field () and press the scroll key.

Some web pages may contain material, such as graphics and sounds, that require a large amount of memory to view. If your device runs out of memory while loading such a web page, the graphics on the page are not displayed.

To browse web pages without graphics, to save memory, select **Options** > **Settings** > **Page** > **Load content** > **Text only**.

To enter a new web address you want to visit, select **Options** > **Go to web address**.



Tip: While browsing, to visit a web page saved as a bookmark in the bookmarks view, press **1**, and select a bookmark.

To refresh the content of the web page, select **Options** > **Navigation options** > **Reload**.

To save the current web page as a bookmark, select **Options** > **Save as bookmark**.

To view snapshots of the web pages you have visited during the current browsing session, select **Back** (available if **History list** is turned on in the browser settings and the current web page is not the first web page you visit). Select the web page you want.

To save a web page while browsing, select **Options** > **Tools** > **Save page**.

You can save web pages and browse them later when offline. You can also group web pages into folders. To access the web pages you have saved, select **Saved pages** in the Web browser main view.

To open a sublist of commands or actions for the current web page, select **Options** > **Service options** (if supported by the web page).



To prevent or allow the automatic opening of multiple windows, select **Options** > **Block pop-ups** or **Allow pop-ups**.

Shortcuts while browsing

- Press **1** to open your bookmarks.
- Press **2** to search for keywords on the current page.

- Press **3** to return to the previous page.
- Press **5** to list all open windows.
- Press **8** to show the page overview of the current page. Press **8** again to zoom in and view the desired section of the page.
- Press **9** to enter a new web address.
- Press **0** to go to the home page (if defined in settings).
- Press ***** and **#** to zoom in or out on the page.



Tip: To return to the home screen with the web browser open in the background, press  twice or the end key. To return to the web browser, press and hold , and select the web browser.

Web feeds and blogs

Web feeds are XML files on web pages that are used to share, for example, the latest news headlines or blogs. Blogs or weblogs are web diaries. It is common to find web feeds on web, blog, and wiki pages.

The Web application automatically detects if a web page contains web feeds.

To subscribe to a web feed, select a feed and **Options** > **Subscribe to web feeds**.

To update a web feed, select a feed and **Options** > **Refresh**.

To define how the web feeds are updated, select **Options** > **Settings** > **Web feeds**.

Widgets

Your device supports widgets. Widgets are small, downloadable web applications that deliver multimedia, news feeds, and other information, such as weather reports, to your device. Installed widgets appear as separate applications in the Applications folder.

You can download widgets using the Download! application or from the web.

You can also install widgets on a compatible memory card (if available).

The default access point for widgets is the same as in the web browser. When active in the background, some widgets may update information automatically to your device.

Using widgets may involve the transmission of large amounts of data through your service provider's network. For information about data transmission charges, contact your service provider.

Empty the cache

The information or services you have accessed are stored in the cache memory of the device.

A cache is a memory location that is used to store data temporarily. If you have tried to access or have accessed confidential information requiring passwords, empty the cache after each use.

To empty the cache, select **Options** > **Clear privacy data** > **Cache**.

End the connection

To end the connection and view the browser page offline, select **Options > Tools > Disconnect**.

To end the connection and close the browser, select **Options > Exit**.

To minimise the browser without ending the connection, press the end key once. To end the connection, press and hold the end key.

To delete the information the network server collects about your visits to various web pages, select **Options > Clear privacy data > Cookies**.

Connection security

If the security indicator () is displayed during a connection, the data transmission between the device and the internet gateway or server is encrypted.

The security icon does not indicate that the data transmission between the gateway and the content server (or the place where the requested resource is stored) is secure. The service provider secures the data transmission between the gateway and the content server.

Security certificates may be required for some services, such as banking services. You are notified if the identity of the server is not authentic or if you do not have the correct security certificate in your device. For more information, contact your service provider.



Important: Even if the use of certificates makes the risks involved in remote connections and software installation considerably smaller, they must be used correctly in order to benefit from increased security. The existence of a certificate does not offer any protection by itself; the certificate manager must contain correct, authentic, or trusted certificates for increased security to be available. Certificates have a restricted lifetime. If "Expired certificate" or "Certificate not valid yet" is shown, even if the certificate should be valid, check that the current date and time in your device are correct.

Before changing any certificate settings, you must make sure that you really trust the owner of the certificate and that the certificate really belongs to the listed owner.

About Contacts on Ovi

With Contacts on Ovi, you can stay connected to the people who matter most. Search for contacts, and discover friends in the Ovi community. Keep in touch with your friends - chat, share your location and presence, and easily follow what your friends are up to and where they are. You can even chat with friends who use Google Talk™. Sync your contacts, calendar, and other content between your Nokia device and Ovi.com. Your important information is stored and kept up-to-date both in your device and on the web. With Contacts on Ovi, you can make your contacts list dynamic and be confident that your contacts are stored on Ovi.com.

You must have a Nokia Account to use the service. Create an account on your mobile device, or go to www.ovi.com on your PC.

Nokia Music Store

Select  > **Applications** > **Music store**.

In the Nokia Music Store (network service) you can search, browse, and purchase music to download to your device. To purchase music, you first need to register for the service.

To access the Nokia Music Store, you must have a valid internet access point in the device.

Nokia Music Store is not available for all countries or regions.

Nokia Music Store settings

The availability and appearance of the Nokia Music Store settings may vary. The settings may also be predefined and not editable. You may be asked to select the access point to use when connecting to the Nokia Music Store. Select **Default access point**.

In the Nokia Music Store, you may be able to edit the settings by selecting **Options** > **Settings**.

About N-Gage

Select  > **Internet** > **Games**.

With N-Gage, you can download free game trials to try out new games, and buy the ones you like. You can play the games by yourself or with friends. N-Gage also provides a way

to keep in touch with other players, and to track and share your scores and other gaming achievements.

Share online

About Share online

Select  > **Internet** > **Share online**.

With Share online, you can post images, video clips, and sound clips from your device to compatible online sharing services, such as albums and blogs. You can also view and send comments to the posts in these services, and download content to your compatible Nokia device.

The supported content types and the availability of the Share online service may vary.

Subscribe to services

Select  > **Internet** > **Share online**.

To subscribe to an online sharing service, go to the service provider's website, and check that your Nokia device is compatible with the service. Create an account as instructed on the website. You receive a user name and password needed to set up your device with the account.

1. To activate a service, open the Share online application in your device, select a service and **Options** > **Activate**.
2. Allow the device to create a network connection. If you are prompted for an internet access point, select one from the list.
3. Sign in to your account as instructed on the service provider's website.

Internet

Nokia's services in the online sharing service are free of charge. Any data transferred over the network may incur charges from your service provider. For the availability and cost of the third party services and data transfer costs, contact your service provider or the relevant third party.

Create a post

Select  > **Internet** > **Share online**.

To post multimedia files to a service, select a service and **Options** > **New post**. If the online sharing service provides channels for posting files, select the desired channel.

To add an image, video clip, or sound clip to the post, select **Options** > **Insert**.

To add a title or description to the post, enter text directly to the fields, if available.

To add tags to the post, select **Tags**.

To select whether to enable the posting of location information contained in the file, select **Location**.

To set the level of privacy for a file, select **Privacy**. To allow everyone to view your file, select **Public**. To restrict others from seeing your files, select **Private**. You can define the **Default** setting on the service provider's website.

To send the post to the service, select **Options** > **Upload**.

Nokia Video Centre



With Nokia Video Centre (network service), you can download and stream video clips over the air from compatible internet

video services using a packet data connection. You can transfer video clips from a compatible PC to your device and view them in Video centre.

Using packet data access points to download videos may involve the transmission of large amounts of data through your service provider's network. Contact your service provider for information about data transmission charges.

Your device may have predefined services.

Service providers may provide free content or charge a fee. Check the pricing in the service or from the service provider.

View and download video clips

Connect to video services

1. Select  > **Internet** > **Video centre**.
2. To connect to a service to install video services, select **Add new services** and the desired video service from the service catalogue.

View a video clip

To browse the content of installed video services, select **Video feeds**.

The content of some video services is divided into categories. To browse video clips, select a category. To search for a video clip in the service, select **Video search**. Search may not be available in all services.

To view information about the selected video clip, select **Options** > **Video details**.

Some video clips can be streamed over the air, but others must be first downloaded to your device. To download a video clip, select **Options** > **Download**. Downloads continue in the background if you exit the application. The downloaded video clips are saved in My videos. To stream a video clip or view a downloaded one, select **Options** > **Play**. When the video clip is playing, use the selection keys and the scroll key to control the player. To adjust the volume, use the volume key.



Warning: Listen to music at a moderate level. Continuous exposure to high volume may damage your hearing.

Schedule downloads

Setting the application to download video clips automatically may involve the transmission of large amounts of data through your service provider's network. For information about data transmission charges, contact your service provider. To schedule an automatic download for video clips in a service, select a category and **Options** > **Schedule downloads**. Video centre automatically downloads new video clips daily at the time you define.

To cancel scheduled downloads for a category, select **Manual download** as the download method.

Nokia Podcasting

With the Nokia Podcasting application (network service), you can search, discover, subscribe to, and download podcasts

over the air, and play, manage, and share audio and video podcasts with your device.

Podcasting settings

To open Nokia Podcasting, select  > **Internet** > **Podcasting**.

Before using Nokia Podcasting, define your connection and download settings.

Check with your service provider for terms and data service fees before using different connection methods. For example, a flat rate data plan can allow large data transfers for one monthly fee.

Connection settings

To edit the connection settings, select **Options** > **Settings** > **Connection** and from the following:

- **Default access point** — Select the access point to define your connection to the internet.
- **Search service URL** — Define the podcast search service URL to be used in searches.

Download settings

To edit the download settings, select **Options** > **Settings** > **Download** and from the following:

- **Save to** — Define the location where you want to save your podcasts.
- **Update interval** — Define how often podcasts are updated.
- **Next update date** — Define the date of the next automatic update.

Internet

- **Next update time** — Define the time of the next automatic update.

Automatic updates only occur if a specific default access point is selected and Nokia Podcasting is running. If Nokia Podcasting is not running, the automatic updates are not activated.

- **Download limit (%)** — Define the percentage of memory that is reserved for podcast downloads.
- **If limit exceeds** — Define what to do if the downloads exceed the download limit.

Setting the application to retrieve podcasts automatically may involve the transmission of large amounts of data through your service provider's network. Contact your service provider for information about data transmission charges.

To restore the default settings, select **Options > Restore default** in the settings view.

Downloads

After you have subscribed to a podcast, from directories, search, or by entering a URL, you can manage, download, and play episodes in **Podcasts**.

To see the podcasts you have subscribed to, select **Podcasting > Podcasts**.

To see individual episode titles (an episode is a particular media file of a podcast), select the podcast title.

To start a download, select the episode title. To download or to continue to download selected or marked episodes, select **Download**. You can download multiple episodes at the same time.

To play a portion of a podcast during download or after partial downloading, select the podcast and **Options > Play preview**.

Fully downloaded podcasts can be found in the **Podcasts** folder, but are not shown until the library is refreshed.

Mobile search

Press , and select **Search**.

Use Mobile Search to search the internet and the content in your device, such as calendar entries, e-mail, and other messages.

To do an internet search (network service) or search the content in your device, enter a keyword in the internet search or my content search field.

13. Personalisation

Themes

Change the display theme

Select **⚙** > **Settings** > **Themes**.

To change the theme used in all applications, select **General**.

To change the theme used in the main menu, select **Menu view**.

To change the theme for a particular application, select the application-specific folder.

To change the background image of the home screen, select **Wallpaper**.

To select an animation for the screen saver, select **Power saver**.

To turn theme effects on or off, select **General** > **Options** > **Theme effects**.

Download a theme

Select **⚙** > **Settings** > **Themes**.

To download a theme, select **General** > **Download themes** > **Options** > **Go to web address**. Enter the web address from which you want to download your theme. Once the theme is downloaded, you can preview or activate the theme.

To preview a theme, select **Options** > **Preview**.

To activate a theme, select **Options** > **Set**.

Profiles

Select **⚙** > **Settings** > **Profiles**.

You can adjust and customise the ringing tones, alert tones, and other device tones for different events, environments, or caller groups. The active profile is shown at the top of the display in the home screen. However, if the active profile is General, only today's date is shown.

To create a new profile, select **Options** > **Create new**, and define the settings.

To customise a profile, select a profile and **Options** > **Personalise**.

To change a profile, select a profile and **Options** > **Activate**. The Offline profile prevents your device from accidentally switching on, sending or receiving messages, or using Bluetooth connectivity, GPS, or FM radio; it also closes any internet connection that may be in operation when the profile is selected. The Offline profile does not prevent you from establishing a Bluetooth connection at a later time, or from restarting the GPS or FM radio, so comply with any applicable safety requirements when establishing and using these features.

Time management

To set the profile to be active until a certain time within the next 24 hours, scroll to the profile, select **Options** > **Timed**, and set the time. When the time expires, the profile changes back to the previously active non-timed profile.

When the profile is timed,  is displayed in the home screen. The Offline profile cannot be timed.

To delete a profile that you created, select **Options** > **Delete profile**. You cannot delete the predefined profiles.

Sensor settings

Mute calls or snooze alarms by turning the phone.

14. Time management

Alarm clock

Select  > **Settings** > **Clock**.

To view your active and inactive alarms, open the alarms tab. To set a new alarm, select **Options** > **New alarm**. Define the repetition, if needed. When an alarm is active,  is displayed.

To turn off the sounding alarm, select **Stop**. To stop the alarm for a certain time period, select **Snooze**. If your device is switched off when an alarm is due, your device switches itself on and starts sounding the alarm tone.



Tip: To define the time period after which the alarm sounds again when you set it to snooze, select **Options** > **Settings** > **Alarm snooze time**.

Select  > **Settings** > **Settings and General** > **Sensor settings**.

Select from the following:

- **Sensors** — Activate the sensors.
- **Turning control** — Mute calls or snooze alarms by turning your device.

To cancel an alarm, select **Options** > **Remove alarm**.

To change the time, date, and clock type settings, select **Options** > **Settings**.

Clock settings

Select **Options** > **Settings**.

To change the time or date, select **Time** or **Date**.

To change the clock shown on the home screen, select **Clock type** > **Analogue** or **Digital**.

To allow the mobile phone network to update the time, date, and time zone information to your device (network service), select **Automatic time update** > **On**.

To change the alarm tone, select **Clock alarm tone**.

15. Office applications

PDF reader

Select  > **Applications** > **Organiser** > **Adobe PDF**.

With PDF reader, you can read PDF documents on the display of your device; search for text in the documents; modify settings, such as zoom level and page views; and send PDF files using e-mail.

Dictionary

Select  > **Applications** > **Organiser** > **Dictionary**.

To translate words from one language to another, enter text in the search field. As you enter text, suggestions of words to translate are displayed. To translate a word, select the word from the list.

Select **Options** and from the following:

- **Listen** — Listen to the selected word.
- **History** — Find previously translated words from the current session.
- **Languages** — Change the source or target language.
- **Languages** — Download languages from the internet or remove a language from the dictionary. You cannot remove the English language from the dictionary. You can have two additional languages installed, besides English.
- **Speech** — Edit the voice feature settings. You can adjust the speed and volume of the voice.

About Quickoffice

Select  > **Applications** > **Organiser** > **Quickoffice**.

Quickoffice consists of Quickword for viewing Microsoft Word documents, Quicksheet for viewing Microsoft Excel worksheets, Quickpoint for Microsoft PowerPoint presentations, and Quickmanager for purchasing software. You can view Microsoft Office 2000, XP, and 2003 documents (DOC, XLS, and PPT file formats) with Quickoffice. If you have the editor version of Quickoffice, you can also edit files.

Not all file formats or features are supported.

Converter

With Converter, you can convert measures from one unit to another.

The converter has limited accuracy, and rounding errors may occur.

Currency converter

Select  > **Applications** > **Organiser** > **Converter**.

Select **Type** > **Currency**. Before you can make currency conversions, you must select a base currency and add exchange rates. The default base currency is Home. The rate of the base currency is always 1.

Office applications

1. Select **Options > Currency rates**.
2. The default name for the currency items is Foreign. To rename a currency, select **Options > Rename currency**.
3. Add the exchange rates for the currencies, and select **Done**.
4. In the other Unit field, select the currency to which you want to convert.
5. In the first Amount field, enter the value you want to convert. The other Amount field shows the converted value automatically.

To change the base currency, select **Options > Currency rates**, a currency and **Options > Set as base currency**.

When you change base currency, you must enter new exchange rates because all previously set exchange rates are cleared.

Convert measures

Select **☞ > Applications > Organiser > Converter**.

1. In the Type field, select the measure you want to use.
2. In the first Unit field, select the unit from which you want to convert.
3. In the other Unit field, select the unit to which you want to convert.
4. In the first Amount field, enter the value you want to convert.

The other Amount field shows the converted value automatically.

Calculator

Select **☞ > Applications > Organiser > Calculator**.

This calculator has limited accuracy and is designed for simple calculations.

To make a calculation, enter the first number of the calculation. Select a function such as add or subtract from the function map. Enter the second number of the calculation, and select **=**. The calculator performs operations in the order they are entered. The result of the calculation remains in the editor field and can be used as the first number of a new calculation.

The device saves the result of the last calculation in its memory. Exiting the Calculator application or switching off the device does not clear the memory. To recall the last saved result the next time you open the Calculator application, select **Options > Last result**.

To save the numbers or results of a calculation, select **Options > Memory > Save**.

To retrieve the results of a calculation from the memory and use them in a calculation, select **Options > Memory > Recall**.

Active notes



Active notes allows you to create notes that contain images and sound or video clips. You can also link a note to a contact. The note is displayed during a call with the contact.

Create and edit notes

Select  > **Applications** > **Organiser** > **Active notes**.

To create a note, start writing.

To edit a note, select the note and **Options** > **Editing options**.

To add boldface, italics, or underlining to your text or change the font colour, press and hold #, and scroll to select the text. Then select **Options** > **Text**.

Select **Options** and from the following:

- **Insert object** — Insert images, sound or video clips, business cards, web bookmarks, and files.
- **Insert new** — Add new items to the note. You can record sound and video clips, and capture images.
- **Send** — Send the note.
- **Link note to call** — Select **Add contacts** to link a note to a contact. The note is displayed when making a call to or receiving a call from the contact.

Settings for Active notes

Select  > **Applications** > **Organiser** > **Active notes** and **Options** > **Settings**.

To select where to save notes, select **Memory in use** and the desired memory.

To change the layout of active notes, or to view the notes as a list, select **Change view** > **Grid** or **List**.

To see a note in the background when making or receiving phone calls, select **Show note during call** > **Yes**.



Tip: If you temporarily do not want to see notes during phone calls, select **Show note during call** > **No**. This way you do not have to remove the links between notes and contact cards.

Notes



Write notes

Select  > **Applications** > **Organiser** > **Notes**. To write a note, start entering the text. The note editor opens automatically.

You can save plain text files (.txt file format) you receive to Notes.

Manage notes

Select  > **Applications** > **Organiser** > **Notes**.

Select **Options** and from the following:

- **Open** — Open the note.
- **Send** — Send the note to other compatible devices.
- **Delete** — Delete a note. You can also delete several notes at once. To mark each note you want to delete, select **Options** > **Mark/Unmark**, and delete the notes.

Settings

- **Synchronisation** — Synchronise the notes with compatible applications on a compatible device, or define the synchronisation settings.

Zip manager

Select  > **Applications** > **Organiser** > **Zip**.

With Zip manager, you can create new archive files to store compressed ZIP formatted files; add single or multiple

compressed files or directories to an archive; set, clear, or change the archive password for protected archives; and change settings, such as compression level, and file name encoding.

You can save the archive files in the device memory or on a memory card.

16. Settings

Application settings

Select  > **Settings** > **Settings** and **Applications**.

Select an application from the list to adjust its settings.

code is entered, select **Phone and SIM card** > **Phone autolock period**. Enter the length of the time-out period in minutes, or select **None** to deactivate the autolock feature. When the device is locked, you can still answer incoming calls, and calls may still be possible to the official emergency number programmed into your device.

Device and SIM card security

Select  > **Settings** > **Settings** > **General** > **Security**.

To change the PIN code, select **Phone and SIM card** > **PIN code**. The new code must be 4 to 8 digits long. The PIN code protects your SIM card against unauthorised use and is provided with the SIM card. After three consecutive incorrect PIN code entries, the code is blocked, and you need to use the PUK code to unblock it before you can use the SIM card again.

To set the keypad to lock automatically after a defined period, select **Phone and SIM card** > **Keypad autolock period**.

To set a time-out period after which the device is automatically locked and can be used only if the correct lock

To change the lock code, select **Phone and SIM card** > **Lock code**. The default lock code is 12345. Enter the current code and then the new code twice. The new code must be 4-25 characters long. Alphanumeric (uppercase and lowercase) characters can be used. The device notifies you if the lock code is not properly formatted.

Common accessory settings

Select  > **Settings** > **Settings** and **General** > **Enhancement**.

With most accessories, you can do the following:

To define which profile is activated when you attach an accessory to your device, select the accessory and **Default profile**.

To set the device to answer phone calls automatically after 5 seconds when an accessory is attached, select **Automatic answer** > **On**. If the ringing type is set to **Beep once** or **Silent** in the selected profile, automatic answering is disabled.

To illuminate the device while it is attached to an accessory, select **Lights** > **On**.

Speech

Select  > **Settings** > **Speech**.

To set the language for the message reader, select **Language**. To download additional languages to your device, see the Nokia website or use the Download! application.

17. Data management

Install or remove applications

Install applications

Select  > **Applications** > **App. mgr..**

You can transfer installation files to your device from a compatible computer, download them during browsing, or receive them in a multimedia message, as an e-mail attachment, or using other connectivity methods, such as Bluetooth connectivity. You can use Nokia Application

To set the speaking voice, select **Voice**. The voice is language-dependent.

To set the speaking rate, select **Speed**.

To set the speaking volume, select **Volume**.

To listen to a voice, open the voice tab, select the voice and **Options** > **Play voice**.

Restore original settings

To restore the original device settings, select  > **Settings** > **Settings and General** > **Factory settings**. To do this, you need your device lock code. After resetting, the device may take a longer time to switch on. Documents, contact information, calendar entries, and files are unaffected.

Installer in Nokia Ovi Suite to install an application to your device.

Icons in Application manager indicate the following:

 SIS or SISX application

 Java™ application

 widgets



Important: Only install and use applications and other software from trusted sources, such as applications that are Symbian Signed or have passed the Java Verified testing.

Before installation, note the following:

- To view the application type, version number, and the supplier or manufacturer of the application, select **Options > View details**.

To display the security certificate details of the application, in Details:, scroll to Certificates:, and select **View details**.

- If you install a file that contains an update or repair to an existing application, you can only restore the original application if you have the original installation file or a full backup copy of the removed software package. To restore the original application, remove the application, and install the application again from the original installation file or the backup copy.

The JAR file is required for installing Java applications. If it is missing, the device may ask you to download it. If there is no access point defined for the application, you are asked to select one. When you are downloading the JAR file, you may need to enter a user name and password to access the server. You obtain these from the supplier or manufacturer of the application.

To install an application or software:

1. To locate an installation file, select  > **Applications > App. mgr.** Alternatively, search for installation files using

File manager, or open a message in **Messaging > Inbox** that contains an installation file.

2. In Application manager, select **Options > Install**. In other applications, to start the installation, select the installation file.

During installation, the device shows information about the progress of the installation. If you install an application without a digital signature or certification, the device displays a warning. Continue installation only if you are sure of the origin and contents of the application.

To start an installed application, locate the application in the menu, and select the application.

To see which software packages are installed or removed and when, select **Options > View log**.



Important: Your device can only support one antivirus application. Having more than one application with antivirus functionality could affect performance and operation or cause the device to stop functioning.

After you install applications to a compatible memory card, installation files (.sis, .sisx) remain in the device memory. The files may use large amounts of memory and prevent you from storing other files. If the .sis file is a message attachment, delete the message from the Messaging inbox.

Remove applications and software

Select  > **Applications > App. mgr.**

Scroll to a software package, and select **Options** > **Uninstall**. Select **Yes** to confirm.

If you remove software, you can only reinstall it if you have the original software package or a full backup of the removed software package. If you remove a software package, you may no longer be able to open documents created with that software.

If another software package depends on the software package that you removed, the other software package may stop working. For more information, see the documentation of the installed software package.

File manager

About File manager

Select  > **Applications** > **Organiser** > **File mgr..**

With File manager, you can browse, manage, and open files on your device, memory card, or a compatible external drive.

The available options depend on the memory you select.

Find and organise files

Select  > **Applications** > **Organiser** > **File mgr..**

To find a file, select **Options** > **Find**. Enter a search term that matches the file name.

To move and copy files and folders, or to create new folders, select **Options** > **Organise**.



Shortcut: To apply actions to multiple items at once, mark the items. To mark or unmark items, press #.

Back up files to a memory card

Select  > **Applications** > **Organiser** > **File mgr..**

To back up files to a memory card, select the file types you want to back up, and **Options** > **Back up phone memory**. Ensure that your memory card has enough free memory for the files that you have chosen to back up.

Manage a memory card

Select  > **Applications** > **Organiser** > **File mgr..**

These options are available only if a compatible memory card is inserted in the device.

Select **Options** and from the following:

- **Memory card options** — Rename or format a memory card.
- **Memory card password** — Password protect a memory card.
- **Unlock memory card** — Unlock a memory card.

Device manager

Remote configuration

Select  > **Settings** > **Device manager**.

With Device manager, you can manage settings, data, and software on your device remotely.

You can connect to a server, and receive configuration settings for your device. You may receive server profiles and different configuration settings from your service providers or company information management department.

Data management

Configuration settings may include connection and other settings used by different applications in your device. The available options may vary.

The remote configuration connection is usually started by the server when the device settings need to be updated.

To create a new server profile, select **Options > Server profiles > Options > New server profile**.

You may receive these settings from your service provider in a configuration message. If not, define the following:

- **Server name** — Enter a name for the configuration server.
- **Server ID** — Enter the unique ID to identify the configuration server.
- **Server password** — Enter a password to identify your device to the server.
- **Access point** — Select the access point to use for the connection, or create a new access point. You can also choose to be asked for the access point every time you start a connection. This setting is available only if you have selected **Internet** as the bearer type.
- **Host address** — Enter the web address of the configuration server.
- **Port** — Enter the port number of the server.
- **User name and Password** — Enter your user ID and password for the configuration server.
- **Allow configuration** — Select **Yes** to allow the server to initiate a configuration session.
- **Auto-accept all requests** — Select **Yes** if you do not want the server to ask for your confirmation when it initiates a configuration session.

- **Network authentication** — Select whether to use http authentication.
- **Network user name and Network password** — Enter your user ID and password for the http authentication. This setting is available only if you have selected **Network authentication** to be used.

To connect to the server and receive configuration settings for your device, select **Options > Start configuration**.

To view the configuration log of the selected profile, select **Options > View log**.

To update the device software over the air, select **Options > Check for updates**. The update does not erase your settings. When you receive the update package on your device, follow the instructions on the display. Your device is restarted once the installation is complete. Downloading software updates may involve the transmission of large amounts of data through your service provider's network. Contact your service provider for information about data transmission charges. Make sure that the device battery has enough power, or connect the charger before starting the update.



Warning: If you install a software update, you cannot use the device, even to make emergency calls, until the installation is completed and the device is restarted. Be sure to back up data before accepting installation of an update.

Update device software

Software updates may include new features and enhanced functions that were not available at the time of purchase of

your device. Updating the software may also improve the device performance.

Nokia Software Updater is a PC application that enables you to update your device software. To update your device software, you need a compatible PC, broadband internet access, and a compatible USB data cable to connect your device to the PC.

To get more information, to check the release notes for the latest software versions, and to download the Nokia Software Updater application, see www.nokia.com/softwareupdate in the United States or in Latin America.

To update the device software, do the following:

1. Download and install the Nokia Software Updater application to your PC.

18. Connectivity

Transfer content from another device

Select  > **Settings** > **Connectivity** > **Switch**.

With the Switch application, you can transfer content, such as contacts, between two compatible Nokia devices.

The type of content that can be transferred depends on the model of the device from which you want to transfer content. If the other device supports synchronisation, you can also synchronise data between the other device and your device. Your device notifies you if the other device is not compatible.

If the other device cannot be switched on without a SIM card, you can insert your SIM card in it. When your device is

2. Connect your device to the PC using a USB data cable, and start the Nokia Software Updater application. The Nokia Software Updater application guides you to back up your files, update the software, and restore your files.

About Licenses

Select  > **Applications** > **Licences**.

Some media files, such as images, music, or video clips, are protected by digital usage rights. The licenses for such files may allow or restrict their usage. For example, with some licenses you may listen to a song only a limited number of times. During one playback session you may rewind, fast-forward, or pause the song, but once you stop it, you have used one of the instances allowed.

switched on without a SIM card, the offline profile is automatically activated.

Transfer content

To retrieve data from your other device for the first time:

1. Select the connection type you want to use to transfer the data. Both devices must support the selected connection type.
2. Select the device from which you want to transfer content. You are asked to enter a code on your device. Enter a code (1-16 digits), and select **OK**. Enter the same code on the other device, and select **OK**. The devices are now paired.

Connectivity

For some device models, the Switch application is sent to the other device as a message. To install the Switch application on the other device, open the message, and follow the instructions.

3. From your device, select the content you want to transfer from the other device.

Content is transferred from the memory of the other device to the corresponding location in your device.

Transfer time depends on the amount of data to be transferred. You can cancel the transfer and continue later.

The synchronisation is two-way, and the data in both devices is the same. If an item is deleted from either device, it is deleted from the other device when synchronising; you cannot restore deleted items by synchronising.

To view the log of the last transfer, select a shortcut in the main view and **Options** > **View log**.

PC connections

You can use your mobile device with a variety of compatible PC connectivity and data communications applications. With Nokia Ovi Suite, you can, for example, transfer files and images between your device and a compatible computer.

For more information about Ovi Suite and the download link, see www.ovi.com.

Bluetooth

About Bluetooth

Bluetooth technology enables wireless connections between electronic devices within a range of 10 metres (33 feet). A Bluetooth connection can be used to send images, videos, text, business cards, calendar notes, or to connect wirelessly to devices that use Bluetooth technology.

Since devices using Bluetooth technology communicate using radio waves, your device and the other devices do not need to be in direct line-of-sight. The two devices only need to be within a maximum of 10 metres of each other, although the connection can be subject to interference from obstructions such as walls or other electronic devices.

Several Bluetooth connections can be active at a time. For example, if your device is connected to a headset, you can also transfer files to another compatible device at the same time.

This device is compliant with Bluetooth Specification 2.0 + EDR supporting the following profiles: Advanced Audio Distribution, Audio/Video Remote Control, Basic Imaging, Basic Printing, Device ID, Dial-up Networking, File Transfer, Generic Audio/Video Distribution, Generic Access, Generic Object Exchange, Handsfree, (Human Interface Device) Headset, Object Push, Phone Book Access, Serial Port, and SIM Access. To ensure interoperability between other devices supporting Bluetooth technology, use Nokia approved accessories for this model. Check with the manufacturers of other devices to determine their compatibility with this device.

Features using Bluetooth technology increase the demand on battery power and reduce the battery life.

Security tips

When you are not using Bluetooth connectivity, select **Bluetooth > Off** or **My phone's visibility > Hidden**.

Do not pair with an unknown device.

Send and receive data with Bluetooth

Select  > **Settings > Connectivity > Bluetooth**.

1. When you activate Bluetooth connectivity for the first time, you are asked to name your device. Give your device a unique name to make it easy to recognise if there are several Bluetooth devices nearby.
2. Select **Bluetooth > On**.
3. Select **My phone's visibility > Shown to all** or **Define period**. If you select **Define period**, you need to define the time during which your device is visible to others. Your device and the name you entered can now be seen by other users with devices using Bluetooth technology.
4. Open the application where the item you want to send is stored.
5. Select the item and **Options > Send > Via Bluetooth**. The device searches for other devices using Bluetooth technology within range and lists them.



Tip: If you have sent data using Bluetooth connectivity before, a list of the previous search

results is displayed. To search for more Bluetooth devices, select **More devices**.

6. Select the device with which you want to connect. If the other device requires pairing before data can be transmitted, you are asked to enter a passcode.

When the connection has been established, **Sending data** is displayed.

The Sent folder in the Messaging application does not store messages sent using Bluetooth connectivity.

To receive data using Bluetooth connectivity, select **Bluetooth > On** and **My phone's visibility > Shown to all** to receive data from a non-paired device or **Hidden** to receive data from a paired device only. When you receive data through Bluetooth connectivity, depending on the settings of an active profile, a tone sounds, and you are asked if you want to accept the message in which the data is included. If you accept, the message is placed in the Inbox folder in the Messaging application.



Tip: You can access the files in the device or on the memory card using a compatible accessory that supports the File Transfer Profile Client service (for example, a laptop computer).

A Bluetooth connection is disconnected automatically after sending or receiving data. Only Nokia Ovi Suite and some accessories such as headsets may maintain a connection even if not actively used.

Pair devices

Select  > **Settings > Connectivity > Bluetooth**.

Connectivity

Open the paired devices tab.

Before pairing, decide on your own passcode (1-16 digits), and agree with the user of the other device to use the same code. Devices that do not have a user interface have a fixed passcode. You need the passcode only when you connect the devices for the first time. After pairing, it is possible to authorise the connection. Pairing and authorising the connection makes connecting quicker and easier, as you do not have to accept the connection between paired devices every time you establish a connection.

The passcode for remote SIM access must have 16 digits.

1. Select **Options** > **New paired device**. The device starts to search for Bluetooth devices within range. If you have sent data using Bluetooth connectivity before, a list of the previous search results is displayed. To search for more Bluetooth devices, select **More devices**.
2. Select the device with which you want to pair, and enter the passcode. The same passcode must be entered to the other device as well.
3. Select **Yes** to make the connection between your device and the other device automatic, or **No** to confirm the connection manually every time a connection attempt is made. After pairing, the device is saved to the paired devices page.

To give a nickname to the paired device, select **Options** > **Assign short name**. The nickname is only displayed in your device.

To delete a pairing, select the device whose pairing you want to delete and **Options** > **Delete**. To delete all pairings, select

Options > **Delete all**. If you are currently connected to a device and cancel the pairing with that device, pairing is removed immediately, and the connection is ended.

To allow a paired device to connect automatically to your device, select **Set as authorised**. Connections between your device and the other device can be made without your knowledge. No separate acceptance or authorisation is needed. Use this status for your own devices, such as your compatible headset or computer, or devices that belong to someone you trust. If you want to accept connection requests from the other device separately every time, select **Set as unauthorised**.

To use a Bluetooth audio accessory such as a Bluetooth handsfree or headset, you need to pair your device with the accessory. For the passcode and further instructions, see the accessory user guide. To connect to the audio accessory, switch on the accessory. Some audio accessories connect automatically to your device. Otherwise, open the paired devices tab, select the accessory and **Options** > **Connect to audio device**.

Block devices

Select  > **Settings** > **Connectivity** > **Bluetooth**.

1. To block a device from establishing a Bluetooth connection to your device, open the paired devices tab.
2. Select a device you want to block and **Options** > **Block**.
To allow the pairing of a device again after it was blocked, delete it from the blocked devices list.

Open the blocked devices tab, and select **Options** > **Delete**.

If you reject a pairing request from another device, you are asked if you want to block all future connection requests from this device. If you accept the query, the remote device is added to the list of blocked devices.

Data cable

To avoid damaging the memory card or corrupting data, do not disconnect the USB data cable during a data transfer.

Transfer data between your device and a PC

1. Insert a memory card in your device, and connect the device to a compatible PC with the USB data cable.
2. When the device asks which mode to use, select **Mass storage**. In this mode, you can see your device as a removable hard drive in your computer.
3. Transfer data between the computer and your device.
4. End the connection from the computer (for example, from an Unplug or Eject Hardware wizard in Windows) to avoid damaging the memory card.

To modify the USB mode settings, select  > **Settings** > **Connectivity** > **USB**.

To change the USB mode you normally use with the data cable, select **USB connection mode**.

To set the device to ask which mode to use each time you connect the USB data cable to the device, select **Ask on connection** > **Yes**.

To use Nokia PC Suite with your device, install Nokia PC Suite on your PC, connect the USB data cable, and select **PC Suite**.

Sync

Select  > **Settings** > **Connectivity** > **Sync**.

Sync enables you to synchronise your notes, calendar entries, text and multimedia messages, browser bookmarks, or contacts with various compatible applications on a compatible computer or on the internet.

You may receive synchronisation settings in a special message from your service provider.

A synchronisation profile contains the necessary settings for synchronisation.

When you open the Sync application, the default or previously used sync profile is displayed. To modify the profile, scroll to a sync item, and select **Mark** to include it in the profile or **Unmark** to leave it out.

To manage sync profiles, select **Options** and the desired option.

To synchronise data, select **Options** > **Synchronise**. To cancel synchronisation before it finishes, select **Cancel**.

Virtual private network

Select  > **Settings** > **Settings** > **Connection** > **VPN**.

The Nokia mobile virtual private network (VPN) client creates a secure connection to compatible corporate intranets and services, such as e-mail. Your device connects from a mobile

Green tips

network, through the internet, to a corporate VPN gateway that acts as a front door to the compatible corporate network. The VPN client uses IP Security (IPSec) technology. IPSec is a framework of open standards for supporting the secure exchange of data over IP networks.

VPN policies define the method used by the VPN client and a VPN gateway to authenticate each other, and the encryption

algorithms that they use to help protect the confidentiality of data.

To install and configure the VPN client, certificates, and policies, contact the IT administrator of your organisation.

19. Green tips

Here are tips on how you can contribute to protecting the environment.

Save energy

When you have fully charged the battery and disconnected the charger from the device, remember to also unplug the charger from the wall outlet.

You do not need to charge your battery so often if you do the following:

- Close and disable applications, services, and connections when you are not using them.
- Decrease the brightness of the screen.
- Set the device to enter the power saver mode after the minimum period of inactivity, if available in your device.
- Disable unnecessary sounds, such as keypad tones. Set the volume of your device to an average level.



Recycle

Did you remember to recycle your old device? 65-80% of the materials in a Nokia mobile phone can be recycled. Always return your used electronic products, batteries, and packaging materials to a dedicated collection point. By doing this, you help prevent uncontrolled waste disposal and promote the recycling of materials. Check how to recycle your Nokia products at www.nokia.com/werecycle or www.nokia.mobi/werecycle.

You may recycle the packaging and user guides at your local recycling scheme.

Save paper

This user guide helps you get started with your device. For more comprehensive instructions, open the help function that is included in your device (in most applications, select **Options > Help**). You can also find user guides and other support at www.nokia.com/support.

Learn more

For more information on the environmental attributes of your device, see www.nokia.com/ecodeclaration.

D
R
A
F
T

Battery

Battery and charger information

Your device is powered by a rechargeable battery. The battery intended for use with this device is BP-6MT. Nokia may make additional battery models available for this device. This device is intended for use when supplied with power from the following chargers: AC-8. The exact charger model number may vary depending on the type of plug. The plug variant is identified by one of the following: E, EB, X, AR, U, A, C, or UB.

The battery can be charged and discharged hundreds of times, but it will eventually wear out. When the talk and standby times are noticeably shorter than normal, replace the battery. Use only Nokia approved batteries, and recharge your battery only with Nokia approved chargers designated for this device. Use of an unapproved battery or charger may present a risk of fire, explosion, leakage, or other hazard.

If a battery is being used for the first time or if the battery has not been used for a prolonged period, it may be necessary to connect the charger, then disconnect and reconnect it to begin charging the battery. If the battery is completely discharged, it may take several minutes before the charging indicator appears on the display or before any calls can be made.

Always switch the device off and disconnect the charger before removing the battery.

Unplug the charger from the electrical plug and the device when not in use. Do not leave a fully charged battery connected to a charger, since overcharging may shorten its lifetime. If left unused, a fully charged battery will lose its charge over time.

Always try to keep the battery between 15°C and 25°C (59°F and 77°F). Extreme temperatures reduce the capacity and lifetime of the battery. A device with a hot or cold battery may not work temporarily. Battery performance is particularly limited in temperatures well below freezing.

Do not short-circuit the battery. Accidental short-circuiting can occur when a metallic object such as a coin, clip, or pen causes direct connection of the positive (+) and negative (-) terminals of the battery. (These look like metal strips on the battery.) This might happen, for example, when you carry a spare battery in your pocket or purse. Short-circuiting the terminals may damage the battery or the connecting object.

Do not dispose of batteries in a fire as they may explode. Batteries may also explode if damaged. Dispose of batteries according to local regulations. Please recycle when possible. Do not dispose as household waste.

Do not dismantle, cut, open, crush, bend, deform, puncture, or shred cells or batteries. In the event of a battery leak, do not allow the liquid to come in contact with the skin or eyes. In the event of such a leak, flush your skin or eyes immediately with water, or seek medical help.

Do not modify, remanufacture, attempt to insert foreign objects into the battery, or immerse or expose it to water or other liquids.

Improper battery use may result in a fire, explosion, or other hazard. If the device or battery is dropped, especially on a hard surface, and you believe the battery has been damaged, take it to a service centre for inspection before continuing to use it.

Use the battery only for its intended purpose. Never use any charger or battery that is damaged. Keep your battery out of the reach of small children.

Nokia battery authentication guidelines

Always use original Nokia batteries for your safety. To check that you are getting an original Nokia battery, purchase it from a Nokia authorised service centre or dealer, and inspect the hologram label using the following steps:

Successful completion of the steps is not a total assurance of the authenticity of the battery. If you have any reason to believe that your battery is not an authentic, original Nokia battery, you should refrain from using it, and take it to the nearest Nokia authorised service centre or dealer for assistance. If authenticity cannot be verified, return the battery to the place of purchase.

Authenticate hologram

1. When you look at the hologram on the label, you should see the Nokia connecting hands symbol from one angle and the Nokia Original Enhancements logo when looking from another angle.
2. When you angle the hologram left, right, down and up, you should see 1, 2, 3 and 4 dots on each side respectively.

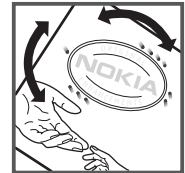

What if your battery is not authentic?

If you cannot confirm that your Nokia battery with the hologram on the label is an authentic Nokia battery, please do not use the battery. Take it to the nearest Nokia authorised service centre or dealer for assistance. The use of a battery that is not approved by Nokia may be dangerous and may result in poor performance and damage to your device and its accessories. It may also invalidate any approval or warranty applying to the device.

For additional information, refer to the warranty and reference leaflet included with your Nokia device.

Care and maintenance

Your device is a product of superior design and craftsmanship and should be treated with care. The following suggestions will help you protect your warranty coverage.

- Keep the device dry. Precipitation, humidity, and all types of liquids or moisture can contain minerals that will corrode electronic circuits. If your device does get wet, remove the battery, and allow the device to dry completely before replacing it.
- Do not use or store the device in dusty, dirty areas. Its moving parts and electronic components can be damaged.
- Do not store the device in hot areas. High temperatures can shorten the life of electronic devices, damage batteries, and warp or melt certain plastics.
- Do not store the device in cold areas. When the device returns to its normal temperature, moisture can form inside the device and damage electronic circuit boards.
- Do not attempt to open the device other than as instructed in this guide.
- Do not drop, knock, or shake the device. Rough handling can break internal circuit boards and fine mechanics.
- Do not use harsh chemicals, cleaning solvents, or strong detergents to clean the device.
- Do not paint the device. Paint can clog the moving parts and prevent proper operation.

- Use a soft, clean, dry cloth to clean any lenses, such as camera, proximity sensor, and light sensor lenses.
- Use only the supplied or an approved replacement antenna. Unauthorised antennas, modifications, or attachments could damage the device and may violate regulations governing radio devices.
- Use chargers indoors.
- Always create a backup of data you want to keep, such as contacts and calendar notes.
- To reset the device from time to time for optimum performance, power off the device and remove the battery.

These suggestions apply equally to your device, battery, charger, or any enhancement. If any device is not working properly, take it to the nearest authorised service facility for service.

Disposal



The crossed-out wheeled-bin symbol on your product, literature, or packaging reminds you that all electrical and electronic products, batteries, and accumulators must be taken to separate collection at the end of their working life. This requirement applies to the European Union and other locations where separate collection systems are available. Do not dispose of these products as unsorted municipal waste.

By returning the products to collection you help prevent uncontrolled waste disposal and promote the reuse of material resources. More detailed information is available from the product retailer, local waste authorities, national

producer responsibility organizations, or your local Nokia representative. For the product Eco-Declaration or instructions for returning your obsolete product, go to country-specific information at www.nokia.com.

Additional safety information

Small children

Your device and its accessories may contain small parts. Keep them out of the reach of small children.

Operating environment

This device meets RF exposure guidelines when used either in the normal use position against the ear or when positioned at least 2.2 centimetres (7/8 inch) away from the body. When a carry case, belt clip, or holder is used for body-worn operation, it should not contain metal and should position the device the above-stated distance from your body.

To transmit data files or messages, this device requires a quality connection to the network. In some cases, transmission of data files or messages may be delayed until such a connection is available. Ensure the above separation distance instructions are followed until the transmission is completed.

Parts of the device are magnetic. Metallic materials may be attracted to the device. Do not place credit cards or other magnetic storage media near the device, because information stored on them may be erased.

Medical devices

Operation of any radio transmitting equipment, including wireless phones, may interfere with the functionality of inadequately protected medical devices. Consult a physician or the manufacturer of the medical device to determine if they are adequately shielded from external RF energy or if you have any questions. Switch off your device in health care facilities when any regulations posted in these areas instruct you to do so. Hospitals or health care facilities may be using equipment that could be sensitive to external RF energy.

Implanted medical devices

Manufacturers of medical devices recommend that a minimum separation of 15.3 centimetres (6 inches) should be maintained between a wireless device and an implanted medical device, such as a pacemaker or implanted cardioverter defibrillator, to avoid potential interference with the medical device. Persons who have such devices should:

- Always keep the wireless device more than 15.3 centimetres (6 inches) from the medical device when the wireless device is turned on.

Additional safety information

- Not carry the wireless device in a breast pocket.
- Hold the wireless device to the ear opposite the medical device to minimise the potential for interference.
- Turn the wireless device off immediately if there is any reason to suspect that interference is taking place.
- Read and follow the directions from the manufacturer of their implanted medical device.

If you have any questions about using your wireless device with an implanted medical device, consult your health care provider.

Hearing aids

Some digital wireless devices may interfere with some hearing aids. If interference occurs, consult your service provider.

Vehicles

RF signals may affect improperly installed or inadequately shielded electronic systems in motor vehicles such as electronic fuel injection systems, electronic antiskid (antilock) braking systems, electronic speed control systems, and air bag systems. For more information, check with the manufacturer, or its representative, of your vehicle or any equipment that has been added.

Only qualified personnel should service the device or install the device in a vehicle. Faulty installation or service may be dangerous and may invalidate any warranty that may apply to the device. Check regularly that all wireless device

equipment in your vehicle is mounted and operating properly. Do not store or carry flammable liquids, gases, or explosive materials in the same compartment as the device, its parts, or accessories. For vehicles equipped with an air bag, remember that air bags inflate with great force. Do not place objects, including installed or portable wireless equipment in the area over the air bag or in the air bag deployment area. If in-vehicle wireless equipment is improperly installed and the air bag inflates, serious injury could result.

Using your device while flying in aircraft is prohibited. Switch off your device before boarding an aircraft. The use of wireless teledevices in an aircraft may be dangerous to the operation of the aircraft, disrupt the wireless telephone network, and may be illegal.

Potentially explosive environments

Switch off your device when in any area with a potentially explosive atmosphere, and obey all signs and instructions. Potentially explosive atmospheres include areas where you would normally be advised to turn off your vehicle engine. Sparks in such areas could cause an explosion or fire resulting in bodily injury or even death. Switch off the device at refuelling points such as near gas pumps at service stations. Observe restrictions on the use of radio equipment in fuel depots, storage, and distribution areas; chemical plants; or where blasting operations are in progress. Areas with a potentially explosive atmosphere are often, but not always, clearly marked. They include below deck on boats, chemical transfer or storage facilities and areas where the air contains

chemicals or particles such as grain, dust, or metal powders. You should check with the manufacturers of vehicles using liquefied petroleum gas (such as propane or butane) to determine if this device can be safely used in their vicinity.

Emergency calls



Important: This device operates using radio signals, wireless networks, landline networks, and user-programmed functions. If your device supports voice calls over the internet (internet calls), activate both the internet calls and the cellular phone. The device will attempt to make emergency calls over both the cellular networks and through your internet call provider if both are activated. Connections in all conditions cannot be guaranteed. You should never rely solely on any wireless device for essential communications like medical emergencies.

To make an emergency call:

1. If the device is not on, switch it on. Check for adequate signal strength. Depending on your device, you may also need to complete the following:
 - Insert a SIM card if your device uses one.
 - Remove certain call restrictions you have activated in your device.
 - Change your profile from offline or flight profile mode to an active profile.
2. Press the end key as many times as needed to clear the display and ready the device for calls.

3. Enter the official emergency number for your present location. Emergency numbers vary by location.
4. Press the call key.

When making an emergency call, give all the necessary information as accurately as possible. Your wireless device may be the only means of communication at the scene of an accident. Do not end the call until given permission to do so.

Certification information (SAR)

This mobile device meets guidelines for exposure to radio waves.

Your mobile device is a radio transmitter and receiver. It is designed not to exceed the limits for exposure to radio waves recommended by international guidelines. These guidelines were developed by the independent scientific organisation ICNIRP and include safety margins designed to assure the protection of all persons, regardless of age and health.

The exposure guidelines for mobile devices employ a unit of measurement known as the Specific Absorption Rate or SAR. The SAR limit stated in the ICNIRP guidelines is 2.0 watts/kilogram (W/kg) averaged over 10 grams of tissue. Tests for SAR are conducted using standard operating positions with the device transmitting at its highest certified power level in all tested frequency bands. The actual SAR level of an operating device can be below the maximum value because the device is designed to use only the power required to reach the network. That amount changes depending on a number of factors such as how close you are to a network base station.

Additional safety information

The highest SAR value under the ICNIRP guidelines for use of the device at the ear is 0.69 W/kg.

Use of device accessories may result in different SAR values. SAR values may vary depending on national reporting and testing requirements and the network band. Additional SAR information may be provided under product information at www.nokia.com.

Your mobile device is also designed to meet the requirements for exposure to radio waves established by the Federal Communications Commission (USA) and Industry Canada. These requirements set a SAR limit of 1.6 W/kg averaged over one gram of tissue. The highest SAR value reported under this standard during product certification for use at the ear is 0.96 W/kg and when properly worn on the body is 0.53 W/kg.

Index

A

- access codes 16
- accessories
 - settings 52
- active notes 51
 - settings 51
- alarm clock 48
- animated screen saver 47
- antennas 11
- application settings 52
- audio messages 34
- auto-update for time/date 48
- autolock period 52

B

- background image 47
- barring password 16
- battery 9, 10
 - charge level 14
- blogs 41
- Bluetooth

- authorising devices 59
- pairing 59
- passcode 59
- receiving data 59
- security 59
- sending data 59

Bluetooth connectivity

- blocking devices 60

browser

- cache memory 41
- security 42
- widgets 41

C

- cable 61
- cache memory 41
- calculator 50
- call barring 25
- call divert 24
- caller ID 24
- calls
 - answering 22
 - call waiting 24
 - caller ID 24
 - conference call 21
 - making 20
 - muting the ringing tone 22
 - rejecting 22
 - rejecting with text message 24
 - selecting type 24
 - settings 24
 - speed dialling 21
 - voice mail 21
- camera
 - capturing images 38

- toolbar 38
- video clips 39

Clock

- settings 48

computer connections 58

See also *data connections*

conference calls 21

configuration settings 11

connection methods

- Bluetooth 59
- data cable 61

contact information 19

contacts

- copying 37
- deleting 36
- editing 36
- images in 36
- names and numbers 36
- ringing tones 37
- saving 36
- sending 36
- synchronising 61
- voice tags 36

Contacts on Ovi 42

converter 49, 50

currency

- converter 49

customer service 19

D

data connections

- PC connectivity 58
- synchronisation 61

date and time 48

device manager 55

dictionary 49

display

- changing the look 47
- indicators 14

Download! 16

E

e-mail 35

F

feeds, news 41

file manager 55

FM radio 28

H

headphones 17

headset 17

help application 18

home screen 13

I

indicators 14

installation of applications 53

installations 17

internet connection 39

See also *browser*

K

keyguard 16

keypad

- lock settings 52

keypad lock 16

keys and parts 12

L

landmarks 31

language

- changing 33

lock code 52

locking

- device autolock 52
- keypad 52

log 22

M

mail for exchange 35

maintenance 19

making a call 20

maps 30

- browsing 30
- indicators 30

media

- radio 28

memory

- web cache 41

memory card 9, 10

menu 15

menu view 15

message reader

- selecting voice 53

messages

- call rejection messages 24
- folders for 34

MMS (multimedia message service) 34

multimedia messages 34

Music player

- transferring music 28

music player

- playing 27

music search 27

My Nokia 18

N

N-Gage 43

network

- settings 25

news feeds 41

Nokia Music Store 43

notes 51

O

offline 13

operator

- selecting 25

original settings 53

outbox, message 34

P

pairing

- devices 59
- passcode 59

PDF reader 49

personalisation 47

PIN 16

PIN code

- changing 52

podcasting

- downloads 46
- settings 45

power saver 15

predictive text input 33

profiles

- creating 47
- customising 47

PUK 16

R

radio 28

- listening 28

remote configuration 55

repair service 19

restoring original settings 53

S

Say and Play 27

screen saver 47

security

- Bluetooth 59
- device and SIM card 52
- web browser 42

security code 16

security module 16

sending

- using Bluetooth 59

sensors 48

sent messages folder 34

settings

- accessories 52
- active notes 51
- applications 52
- calls 24
- clock 48
- configuration 11
- keypad lock 52
- network 25
- podcasting 45
- restoring 53

settings wizard 12

Share online

- activating services 43
- creating posts 44
- subscribing 43

share online 43

signal strength 14

SIM card 9

SMS (short message service) 34

software update 19

software updates 56

speech 53

speed dialling 21

support information 19

switch the device off 11

switch the device on 11

synchronisation of data 61

T

text

- letter mode 32
- number mode 32
- predictive input 33
- traditional input 32

text messages

- sending 34

themes

- changing 47
- downloading 47

time and date 48

toolbar

- camera 38

traditional text input 32

U

updates

- device software 56
- updating firmware 20
- updating software 20

UPIN 16

UPIN code

- changing 52

Index

USB data cable 61

V

video 38

- downloading 38
- internet video clips 38

video calls 23

- making a call 23
- switching to voice call 23

Video Centre 44

video centre

- downloading 44
- viewing 44

video sharing

- sharing live video 26
- sharing video clips 26

virtual private network 61

voice dialling 21

voice mail

- calling 21
- changing number 21

volume control 15

VPN 61

W

web browser

- browsing pages 40

web connection 39

web logs 41

widgets 41

writing language 33

Z

Zip manager 52

D
R
A
F
T