

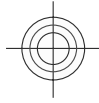

Nokia 5230 User Guide

555555
Issue 1



DECLARATION OF CONFORMITY

CE 0434 Hereby, NOKIA CORPORATION declares that this RM-594 product is in compliance with the essential requirements and other relevant provisions of Directive 1999/5/EC. A copy of the Declaration of Conformity can be found at www.nokia.com/phones/declaration_of_conformity/.

© 2009 Nokia. All rights reserved.

Nokia, Nokia Connecting People, Nokia Care, Nokia Original Enhancements logos, and Ovi are trademarks or registered trademarks of Nokia Corporation. Nokia tune is a sound mark of Nokia Corporation. Other product and company names mentioned herein may be trademarks or tradenames of their respective owners.

Reproduction, transfer, distribution, or storage of part or all of the contents in this document in any form without the prior written permission of Nokia is prohibited. Nokia operates a policy of continuous development. Nokia reserves the right to make changes and improvements to any of the products described in this document without prior notice.

symbian This product includes software licensed from Symbian Software Ltd ©1998-2009. Symbian and Symbian OS are trademarks of Symbian Ltd.



Java

POWERED Java and all Java-based marks are trademarks or registered trademarks of Sun Microsystems, Inc.





Portions of the Nokia Maps software are ©1996-2009 The FreeType Project. All rights reserved.

This product is licensed under the MPEG-4 Visual Patent Portfolio License (i) for personal and noncommercial use in connection with information which has been encoded in compliance with the MPEG-4 Visual Standard by a consumer engaged in a personal and noncommercial activity and (ii) for use in connection with MPEG-4 video provided by a licensed video provider. No license is granted or shall be implied for any other use. Additional information, including that related to promotional, internal, and commercial uses, may be obtained from MPEG LA, LLC. See <http://www.mpegla.com>.

TO THE MAXIMUM EXTENT PERMITTED BY APPLICABLE LAW, UNDER NO CIRCUMSTANCES SHALL NOKIA OR ANY OF ITS LICENSORS BE RESPONSIBLE FOR ANY LOSS OF DATA OR INCOME OR ANY SPECIAL, INCIDENTAL, CONSEQUENTIAL OR INDIRECT DAMAGES HOWSOEVER CAUSED.

THE CONTENTS OF THIS DOCUMENT ARE PROVIDED "AS IS". EXCEPT AS REQUIRED BY APPLICABLE LAW, NO WARRANTIES OF ANY KIND, EITHER EXPRESS OR IMPLIED, INCLUDING, BUT NOT LIMITED TO, THE IMPLIED WARRANTIES OF





MERCHANTABILITY AND FITNESS FOR A PARTICULAR PURPOSE, ARE MADE IN RELATION TO THE ACCURACY, RELIABILITY OR CONTENTS OF THIS DOCUMENT. NOKIA RESERVES THE RIGHT TO REVISE THIS DOCUMENT OR WITHDRAW IT AT ANY TIME WITHOUT PRIOR NOTICE.

Reverse engineering of software in the device is prohibited to the extent permitted by applicable law. Insofar as this user guide contains any limitations on Nokia's representations, warranties, damages and liabilities, such limitations shall likewise limit any representations, warranties, damages and liabilities of Nokia's licensors.

The availability of some features may vary by region. Please contact your operator for more details. The availability of particular products and applications and services for these products may vary by region. Please check with your Nokia dealer for details and availability of language options. This device may contain commodities, technology or software subject to export laws and regulations from the US and other countries. Diversion contrary to law is prohibited.

FCC/INDUSTRY CANADA NOTICE

Your device may cause TV or radio interference (for example, when using a telephone in close proximity to receiving equipment). The FCC or Industry Canada can require you to stop using your telephone if such interference cannot be eliminated. If you require assistance, contact your local service facility. This device complies with part 15 of the FCC rules. Operation is subject to the following two conditions: (1) This device may not cause harmful interference, and (2) this device must accept any interference received, including interference that may cause undesired operation. Any changes or modifications not expressly approved by Nokia could void the user's authority to operate this equipment.

Some operations and features are SIM card and/or network dependent, MMS dependent, or dependent on the compatibility of devices and the content formats supported. Some services are subject to a separate charge.

Your device may have preinstalled bookmarks and links for third-party internet sites. You may also access other third-party sites through your device. Third-party sites are not affiliated with Nokia, and Nokia does not endorse or assume liability for them. If you choose to access such sites, you should take precautions for security or content.

555555/Issue 1 EN

Contents

Safety	6	Offline profile.....	26
About your device.....	7	Shortcuts.....	26
Network services.....	8	Sensor settings and display rotation.....	27
1. Find help	9	Headset.....	27
In-device help.....	9	Attach a wrist strap.....	28
Accessibility solutions.....	9	Remove the SIM card.....	29
Extended user guide.....	9	Remove the memory card.....	29
Support.....	10	4. Make calls	31
Software updates over the air.....	10	Proximity sensor.....	31
Software updates using your PC.....	11	Calls	31
Access codes.....	12	5. Write text	32
2. Get started	13	Virtual keyboard.....	32
Insert the SIM card.....	13	Handwriting.....	33
Insert the battery.....	14	Alphanumeric keypad.....	34
Insert the memory card.....	15	Touch input settings.....	36
Charge the battery.....	16	6. Messaging	38
Keys and parts.....	17	Messaging main view.....	38
Switch the device on.....	19	Write and send messages.....	39
Lock the keys and touch screen.....	19	Set up e-mail.....	40
Home screen.....	20	Mail for Exchange.....	40
Access the menu.....	20	7. Music player	42
Touch screen actions.....	21	Play a song or a podcast.....	42
Media key.....	23	Playlists.....	43
Change the ringing tone.....	23	Transfer music from a computer.....	44
Nokia support.....	23	Nokia Music.....	45
3. Your device	25		
Contacts bar.....	25		
Antenna locations.....	25		

	Contents
8. Camera.....	46
Activate the camera.....	46
Image capture.....	46
Video recording.....	49
9. Gallery.....	52
View and organise files.....	52
View images and videos.....	52
10. Share online.....	54
About Share online.....	54
Subscribe to services.....	54
Manage your accounts.....	54
Create a post.....	55
Post files from Gallery	55
11. Nokia Video Centre.....	56
View and download video clips.....	56
Video feeds.....	57
My videos.....	58
Transfer videos from your PC.....	58
Video centre settings.....	59
12. Web browser.....	60
Browse the web.....	60
Browser toolbar.....	61
Bookmarks.....	62
Empty the cache.....	62
Connection security.....	63
13. Positioning (GPS).....	64
About GPS.....	64
Assisted GPS (A-GPS).....	64
Hold your device correctly.....	65
14. Connectivity.....	66
15. Green tips.....	67
Save energy.....	67
Recycle.....	67
Save paper.....	67
Learn more.....	68
Accessories.....	69
Battery.....	70
Battery and charger information.....	70
Nokia battery authentication guidelines.....	71
Taking care of your device.....	73
Recycle.....	74
Additional safety information.....	75
Small children.....	75
Operating environment.....	75
Medical devices.....	75
Vehicles.....	76
Potentially explosive environments.....	77
Emergency calls.....	77
Certification information (SAR).....	78
Index.....	80

Safety

Read these simple guidelines. Not following them may be dangerous or illegal. Read the complete user guide for further information.



SWITCH ON SAFELY

Do not switch the device on when wireless phone use is prohibited or when it may cause interference or danger.



ROAD SAFETY COMES FIRST

Obey all local laws. Always keep your hands free to operate the vehicle while driving. Your first consideration while driving should be road safety.



INTERFERENCE

All wireless devices may be susceptible to interference, which could affect performance.



SWITCH OFF IN RESTRICTED AREAS

Follow any restrictions. Switch the device off in aircraft, near medical equipment, fuel, chemicals, or blasting areas.



QUALIFIED SERVICE

Only qualified personnel may install or repair this product.



ACCESSORIES AND BATTERIES

Use only approved accessories and batteries. Do not connect incompatible products.



WATER-RESISTANCE

Your device is not water-resistant. Keep it dry.



Safety

About your device

The wireless device described in this guide is approved for use on the WCDMA 900/2100 and GSM/EDGE 850/900/1800/1900. Contact your service provider for more information about networks.

Your device supports several connectivity methods and like computers may be exposed to viruses and other harmful content. Exercise caution with messages, connectivity requests, browsing, and downloads. Only install and use services and software from trustworthy sources that offer adequate security and protection, such as applications that are Symbian Signed or have passed the Java Verified™ testing. Consider installing antivirus and other security software on your device and any connected computer.

Your device may have preinstalled bookmarks and links for third-party internet sites and may allow you to access third-party sites. These are not affiliated with Nokia, and Nokia does not endorse or assume liability for them. If you access such sites, take precautions for security or content.



Warning: To use any features in this device, other than the alarm clock, the device must be switched on. Do not switch the device on when wireless device use may cause interference or danger.

When using this device, obey all laws and respect local customs, privacy and legitimate rights of others, including copyrights. Copyright protection may prevent some images, music, and other content from being copied, modified, or transferred.

Make back-up copies or keep a written record of all important information stored in your device.

When connecting to any other device, read its user guide for detailed safety instructions. Do not connect incompatible products.

The images in this guide may differ from your device display.

Refer to the user guide for other important information about your device.





Safety

Network services

To use the device you must have service from a wireless service provider. Some features are not available on all networks; other features may require that you make specific arrangements with your service provider to use them. Network services involve transmission of data. Check with your service provider for details about fees in your home network and when roaming on other networks. Your service provider can explain what charges will apply. Some networks may have limitations that affect how you can use some features of this device requiring network support such as support for specific technologies like WAP 2.0 protocols (HTTP and SSL) that run on TCP/IP protocols and language-dependent characters.

Your service provider may have requested that certain features be disabled or not activated in your device. If so, these features will not appear on your device menu. Your device may also have customized items such as menu names, menu order, and icons.



1. Find help

For local services and warranty information, see the separate booklet.



In-device help

Your device contains instructions to help to use the applications in your device.

To open help texts from the main menu, select **Menu** > **Help** and the application for which you want to read instructions.

When an application is open, to access the help text for the current view, select **Options** > **Help**.

When you are reading the instructions, to change the size of the help text, select **Options** > **Decrease font size** or **Increase font size**.

You may find links to related topics at the end of the help text. If you select an underlined word, a short explanation is displayed. Help texts use the following indicators:  Link to a related help topic.  Link to the application being discussed.

When you are reading the instructions, to switch between help texts and the application that is open in the background, select **Options** > **Show open apps**. and the desired application.

Accessibility solutions

Nokia is committed to making mobile phones easy to use for all individuals, including those with disabilities. For more information, visit the Nokia website at www.nokiaaccessibility.com.

Extended user guide

An extended version of this user guide is available on the product support pages of the Nokia website. Some applications or functions are explained only in the extended user guide.

www.nokia.com/support

9

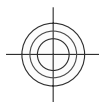

Find help

Support

When you want to learn more about how to use your product or you are unsure how your device should function, see the support pages at www.nokia.com/support or your local Nokia website, www.nokia.mobi/support (with a mobile device), the Help application in the device, or the user guide.

If this does not resolve your issue, do one of the following:

- Restart the device: switch off the device, and remove the battery. After about a minute, replace the battery, and switch on the device.
- Restore the original factory settings as explained in the user guide. Your documents and files will be deleted in the reset, so back up your data first.
- Update your device software regularly for optimum performance and possible new features, as explained in the user guide.

If your issue remains unsolved, contact Nokia for repair options. See www.nokia.com/repair, or in Latin America, www.nokia-latinoamerica.com/centrosdeservicio. Before sending your device for repair, always back up the data in your device.



Software updates over the air

Select **Menu > Applications > SW update**.

With Software update (network service), you can check if there are updates available for your device software or applications, and download them to your device.

Downloading software updates may involve the transmission of large amounts of data (network service).

Make sure that the device battery has enough power, or connect the charger before starting the update.

 **Warning:** If you install a software update, you cannot use the device, even to make emergency calls, until the installation is completed and the device is restarted. Be sure to back up data before accepting installation of an update.





Find help

After updating your device software or applications using Software update, the instructions related to the updated applications in the user guide or the helps may no longer be up to date.

To download the available updates, select . To unmark specific updates that you do not want to download, select the updates from the list.

To view information on an update, select the update and .

To view the status of previous updates, select .

Select **Options** and from the following:

- **Update via PC** — Update your device using a PC. This option replaces the Start update option when updates are only available using the Nokia Software Updater PC application.
- **View update history** — View the status of previous updates.
- **Settings** — Change the settings, such as the default access point used for downloading updates.
- **Disclaimer** — View the Nokia licence agreement.

Software updates using your PC

Software updates may include new features and enhanced functions that were not available at the time of purchase of your device. Updating the software may also improve the device performance.

Nokia Software Updater is a PC application that enables you to update your device software. To update your device software, you need a compatible PC, broadband internet access, and a compatible USB data cable to connect your device to the PC.

To get more information, to check the release notes for the latest software versions, and to download the Nokia Software Updater application, see www.nokia.com/softwareupdate, or in Latin America, www.nokia-latinoamerica.com/nsu.

To update the device software, do the following:

1. Download and install the Nokia Software Updater application to your PC.





Find help

2. Connect your device to the PC using a USB data cable, and open the Nokia Software Updater application. The Nokia Software Updater application guides you to back up your files, update the software, and restore your files.

Access codes

If you forget any of the access codes, contact your service provider.

- Personal identification number (PIN) code — This code protects your SIM card against unauthorised use. The PIN code (4 to 8 digits) is usually supplied with the SIM card. After three consecutive incorrect PIN code entries, the code is blocked, and you need the PUK code to unblock it.
- UPIN code — This code may be supplied with the USIM card. The USIM card is an enhanced version of the SIM card and is supported by UMTS mobile phones.
- PIN2 code — This code (4 to 8 digits) is supplied with some SIM cards, and is required to access some functions in your device.
- Lock code (also known as security code) — The lock code helps you to protect your device against unauthorised use. The preset code is 12345. You can create and change the code, and set the device to request the code. Keep the new code secret and in a safe place separate from your device. If you forget the code and your device is locked, your device will require service and additional charges may apply. For more information, contact a Nokia Care point or your device dealer.
- Personal Unblocking Key (PUK) code and PUK2 code — These codes (8 digits) are required to change a blocked PIN code or PIN2 code, respectively. If the codes are not supplied with the SIM card, contact the operator whose SIM card is in your device.
- UPUK code — This code (8 digits) is required to change a blocked UPIN code. If the code is not supplied with the USIM card, contact the operator whose USIM card is in your device.



2. Get started

Insert the SIM card

 **Important:** To prevent damage to the SIM card, always remove the battery before you insert or remove the card.

A SIM card may be already inserted in the device. If not, do the following:

1. Open the cover of the SIM card slot.
2. Insert a SIM card in the SIM card slot. Ensure that the contact area on the card is facing down and the bevelled corner is facing toward the device. Push the card in.

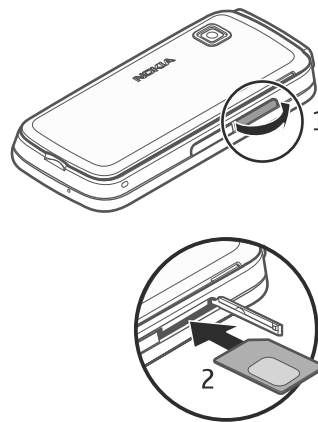

Get started

3. Close the cover of the SIM card slot. Ensure that the cover is properly closed.

If the SIM card is not properly in place, the device can only be used in the offline profile.

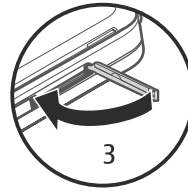

Insert the battery

Always switch the device off and disconnect the charger before removing the battery.

1. Remove the back cover.
2. Insert the battery.

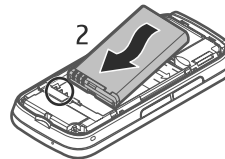
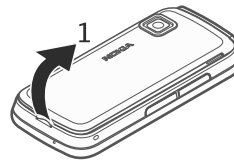



Get started

3. To replace the cover, direct the top locking catches toward their slots, and press down until the cover locks into place.

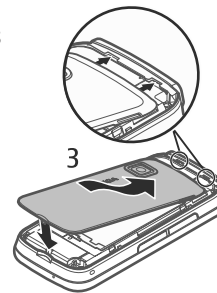

Insert the memory card

Use only compatible microSD and microSDHC cards approved by Nokia for use with this device. Nokia uses approved industry standards for memory cards, but some brands may not be fully compatible with this device. Incompatible cards may damage the card and the device and corrupt data stored on the card.

1. Open the cover of the memory card slot.

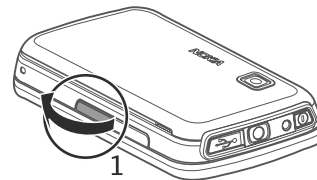

Get started

2. Insert a compatible memory card in the memory card slot. Ensure that the contact area on the card is facing down. Push the card in. You can hear a click when the card locks into place.
3. Close the cover of the memory card slot. Ensure that the cover is properly closed.

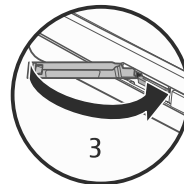
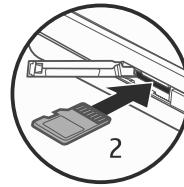

Charge the battery

Your battery has been partially charged at the factory. If the device indicates a low charge, do the following:

1. Connect the charger to a wall outlet.
2. Connect the charger to the device.

Get started

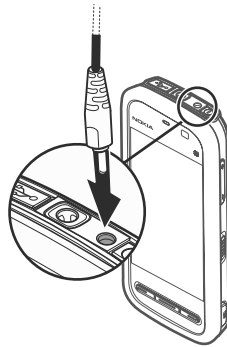

3. When the device indicates a full charge, disconnect the charger from the device, then from the wall outlet.

You do not need to charge the battery for a specific length of time, and you can use the device while it is charging. If the battery is completely discharged, it may take several minutes before the charging indicator appears on the display or before any calls can be made.

 **Tip:** Disconnect the charger from the wall outlet when the charger is not in use. A charger that is connected to the outlet consumes power even when it is not connected to the device.

Keys and parts

1 - Micro USB connector	
-------------------------	--

Get started

2 - Nokia AV connector (3.5mm)
3 - Charger connector
4 - Power key
5 - Earpiece
6 - Touch screen
7 - Proximity sensor
8 - Volume/Zoom key
9 - Media key
10 - Lock switch
11 - Capture key
12 - End key
13 - Menu key
14 - Call key

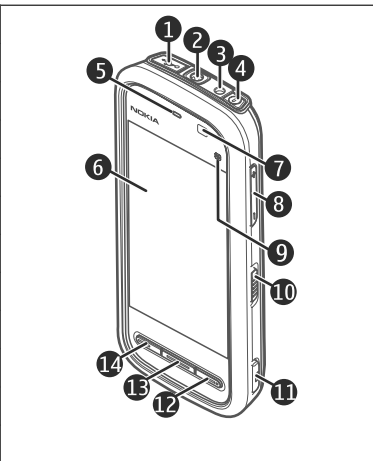

15 - Camera lens
16 - Loudspeaker
17 - SIM card slot
18 - Memory card slot
19 - Wrist strap hole
20 - Microphone

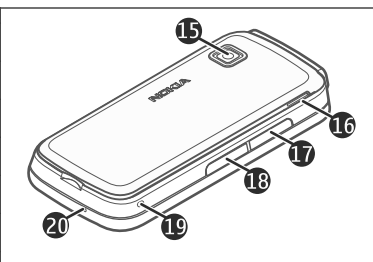

Get started

Your device also comes with a plectrum stylus that can be attached to the device with the wrist strap.

Do not cover the area above the touch screen, for example, with protective film or tape.

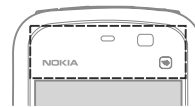

Switch the device on

1. Press and hold the power key.
2. If the device asks for a PIN code or lock code, enter it, and select **OK**. To delete a number, select . The factory setting for the lock code is **12345**.
3. Select your location. If you accidentally select the wrong location, select **Back**.
4. Enter the date and time. When using the 12-hour time format, to switch between a.m. and p.m., select any number.

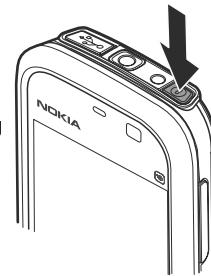

Lock the keys and touch screen

To lock or unlock the touch screen and the keys, slide the lock switch on the side of the device.

When the touch screen and keys are locked, the touch screen is switched off and the keys are inactive.

The screen and keys may be locked automatically after a period of inactivity. To change settings for automatic screen and key locking, select **Menu > Settings and Phone > Phone mgmt. > Auto. keyguard > Keypad autolock period**.

Get started

Home screen

The home screen is your starting point where you can collect all your important contacts or application shortcuts.

Interactive display elements

To open the clock application, select the clock (1).

To open the calendar, or to change the profile, select the date or the profile name (2).

To view or modify connectivity settings (↔), or to view missed events, select the top right corner (3).

To make a phone call, select **Telephone** or ☎ (4).

To open the contacts list, select **Contacts** or 👤 (5).

To open the main menu, press the menu key (6).

Start using the contacts bar

To start using the contacts bar, and to add your contacts to the home screen, select ☰ > **Options** > **New contact**, and follow the instructions.

Change the home screen theme

To change the home screen theme or the shortcuts, select **Menu** > **Settings** and **Personal** > **Home screen**.

Music keys

When music or the radio is playing in the background, music keys (play/pause, skip backward, and skip forward) are displayed in the home screen.

Access the menu

To access the menu, press the menu key.

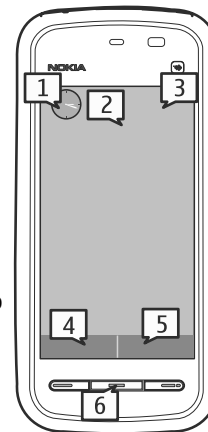

Get started

To open an application or folder in the menu, select the item.

Touch screen actions

Tap and double-tap

To open an application or other element on the touch screen, you normally tap it with your finger. However, to open the following items, you must tap them twice.



Important: Use only a stylus approved by Nokia for use with this device. Using any other stylus may invalidate any warranty applying to the device and may damage the touch screen. Avoid scratching the touch screen. Never use an actual pen or pencil or other sharp objects to write on the touch screen.

- List items in an application, such as the Drafts folder in the folder list in Messaging



Tip: When you open a list view, the first item is already highlighted. To open the highlighted item, tap it once.

- Applications and folders in the menu when using the list view type
- Files in a file list, for example, an image in the images and videos view in Gallery.

If you tap a file or similar item once, it is not opened, it becomes highlighted. To see the options available for the item, select **Options** or, if available, select an icon from a toolbar.

Select

In this user documentation, opening applications or items by tapping them once or twice is called "selecting". If you need to select several items in a sequence, the menu items to select are separated by arrows.



Example: To select **Options** > **Help**, tap **Options**, and then tap **Help**.

Drag

To drag, place your finger on the screen, and slide it across the screen.

Get started

 **Example:** To scroll up or down on a web page, drag the page with your finger.

Swipe

To swipe, slide your finger quickly left or right on the screen.

 **Example:** When viewing an image, to view the next or previous image, swipe the image left or right, respectively.

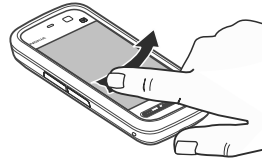

Scroll

To scroll up or down in lists that have a scroll bar, drag the slider of the scroll bar.

In some list views, you can scroll by placing your finger on a list item and dragging up or down.

 **Example:** To scroll through contacts, place your finger on a contact, and drag up or down.

 **Tip:** To view a brief description of an icon, place your finger on the icon. Descriptions are not available for all icons.

Touch screen backlight

The touch screen backlight is turned off after a period of inactivity. To turn the screen backlight on, tap the screen.

If the touch screen and keys are locked, tapping the screen does not turn the screen backlight on.

Get started

Media key

To open applications such as the music player or browser, select the media key (🎵) to open the media bar, and select the application.



Change the ringing tone

Select **Menu** > **Settings and Personal** > **Profiles**.

You can use profiles to set and customise the ringing tones, message alert tones, and other tones for different events, environments, or caller groups. To personalise a profile, scroll to the profile, and select **Options** > **Personalise**.

Nokia support

To find the latest version of this guide, additional information, downloads, and services related to your Nokia product, see www.nokia.com/support or your local Nokia website.

You may find additional detailed information in the Nokia Care Services and Warranty Conditions booklet.

Configuration settings service

To download configuration settings such as MMS, GPRS, e-mail, and other services for your phone model, see www.nokia.com/support.

www.nokia.com/support

23



Get started

Nokia Care services

If you need to contact Nokia Care services, check the list of local Nokia Care contact centres at www.nokia-latinoamerica.com/contactenos.

Maintenance

For maintenance services, find your nearest Nokia Care point at www.nokia-latinoamerica.com/centrosdeservicio.





**NOKIA
Care**



3. Your device

Contacts bar

To add a contact to the home screen, in the home screen, select  > **Options** > **New contact**, and follow the instructions.

To communicate with a contact, select the contact and from the following:  Call the contact.  Send a message to the contact.  Modify the contact's details.  Refresh the contact's web feeds.

To view past communication events with a contact, select the contact. To view the details of a communication event, select the event.

To close the view, select .

Antenna locations

Your device may have internal and external antennas. Avoid touching the antenna area unnecessarily while the antenna is transmitting or receiving. Contact with antennas affects the communication quality and may cause a higher power level during operation and may reduce the battery life.

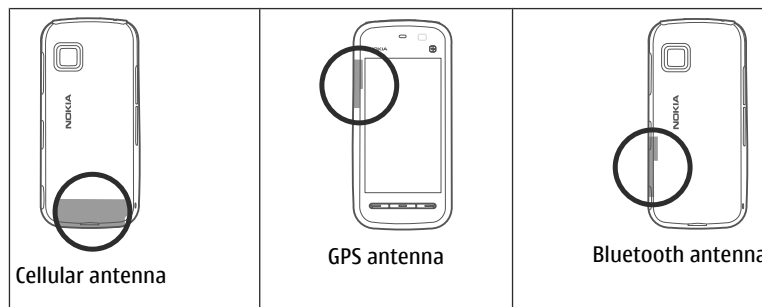

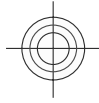

Your device

Offline profile

To activate the Offline profile, press the power key briefly, and select **Offline**.

The Offline profile lets you use the device without connecting to the wireless network. When you activate the Offline profile, the connection to the wireless network is turned off, as indicated by **X** in the signal strength indicator area. All wireless RF signals to and from the device are prevented. If you try to send messages, they are placed in the Outbox folder to be sent later.

When the Offline profile is active, you can use your device without a SIM card.

If the SIM card is not properly in place, the device starts in the Offline profile.



Important: In the Offline profile you cannot make or receive any calls, or use other features that require cellular network coverage. Calls may still be possible to the official emergency number programmed into your device. To make calls, you must first activate the phone function by changing profiles. If the device has been locked, enter the lock code.

To switch to another profile, press the power key briefly, and select another profile. The device re-enables wireless transmissions (providing there is sufficient signal strength).

Shortcuts

To switch between open applications, press and hold the menu key. Leaving applications running in the background increases the demand on battery power and reduces the battery life.

To start a web connection (network service), in the dialler, tap and hold **0**.

To access applications available in the media bar, such as the music player and web browser, in any view, press the media key.

To change the profile, press the power key, and select a profile.

To call your voice mailbox (network service), in the dialler, tap and hold **1**.





Your device

To open a list of last dialed numbers, in the home screen, press the call key.

To use voice commands, in the home screen, press and hold the call key.

Sensor settings and display rotation

When you activate the sensors in your device, you can control certain functions by turning the device.

Select **Menu** > **Settings** and **Phone** > **Sensor settings**.

Select from the following:

- **Sensors** — Activate the sensors.
- **Turning control** — Select **Silencing calls** and **Snoozing alarms** to mute calls and snooze alarms by turning your device so that the display faces down. Select **Auto-rotate display** to rotate the display content automatically when you turn the device on its left side or back to a vertical position. Some applications and features may not support rotating the display content.

Headset

You can connect a compatible headset or compatible headphones to your device. You may need to select the cable mode.

Some headsets come in two parts, a remote control unit and headphones. A remote control unit has a microphone and keys to answer or end a phone call, adjust the volume, and play music or video files. To use the headphones with a remote control unit, connect the unit to the Nokia AV Connector in the device, then connect the headphones to the unit.



Your device

 **Warning:** When you use the headset, your ability to hear outside sounds may be affected. Do not use the headset where it can endanger your safety.

Do not connect products that create an output signal as this may cause damage to the device. Do not connect any voltage source to the Nokia AV Connector.

When connecting any external device or any headset, other than those approved by Nokia for use with this device, to the Nokia AV Connector, pay special attention to volume levels.

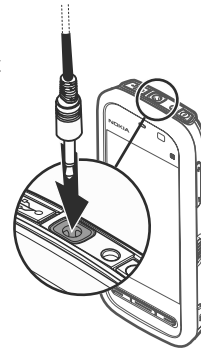

Attach a wrist strap

 **Tip:** Attach the plectrum stylus to the device like a wrist strap.

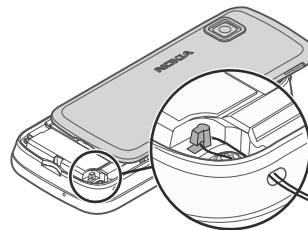

Your device

Remove the SIM card

1. Remove the back cover by lifting it from the top end of the device.
2. Remove the battery.
3. Open the cover of the SIM card slot. Place the tip of a pen or stylus in the opening under the battery, and push the SIM card sideways to slide it out of the slot. Pull the SIM card out.
4. Replace the battery and the back cover.

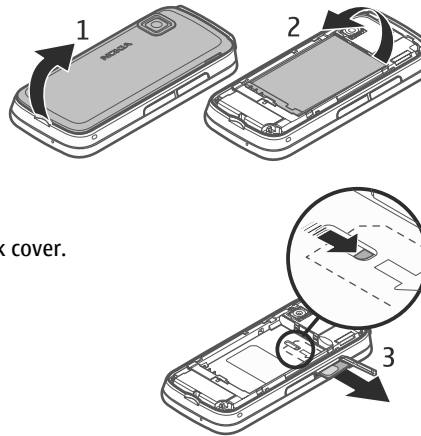

Remove the memory card

 **Important:** Do not remove the memory card during an operation when the card is being accessed. Doing so may damage the memory card and the device, and corrupt data stored on the card.

1. If the device is switched on, before you remove the card, press the power key, and select **Remove memory card**.
2. When **Remove memory card? Some applications will be closed.** is displayed, select **Yes**.
3. When **Remove memory card and press 'OK'** is displayed, open the cover of the memory card slot.

www.nokia.com/support

29



Your device

4. Press the memory card to release it from the slot.
5. Pull out the memory card. If the device is switched on, select **OK**.





4. Make calls

Proximity sensor

Your device has a proximity sensor. To prevent accidental selections, the touch screen is disabled automatically during calls when you place the device next to your ear.

Do not cover the proximity sensor, for example, with protective film or tape.

Calls

1. In the home screen, select **Telephone** to open the dialler, and enter the phone number, including the area code. To remove a number, select **C**.

For international calls, select * twice for the + character (which replaces the international access code), and enter the country code, area code (omit the leading zero if necessary), and phone number. The + character as a replacement for the international access code may not work in all regions. In this case, enter the international access code directly.

2. To make the call, press the call key.
3. To end the call (or to cancel the call attempt), press the end key.

Pressing the end key always ends a call, even if another application is active.

To make a call from the contacts list, select **Menu > Contacts**. Go to the desired name. Or, select the search field, enter the first letters or characters of the name, and go to the name. To call the contact, press the call key. If you have saved several numbers for a contact, select the desired number from the list, and press the call key.



5. Write text

The on-screen keyboards allow you to enter characters by tapping them with your fingers.

Tap any text input field to enter letters, numbers, and special characters.

Your device can complete words based on the built-in dictionary for the selected text input language. The device also learns new words from your input.

Virtual keyboard

You can use the virtual keyboard in landscape mode.

To activate the virtual keyboard, select  > **Full screen QWERTY**.

When using the virtual keyboard in full screen mode, you can select keys with your fingers.

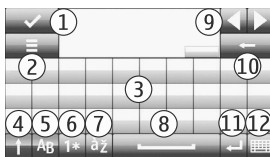

1 — Close - Close the virtual keyboard.

2 — Input menu - Open the touch input options menu to access commands such as **Writing language**.

3 — Virtual keyboard

4 — Shift and caps lock - To enter an uppercase character when writing in lowercase, or vice versa, select the key before entering the character. To activate the caps lock, select the key twice. A line under the key indicates that the caps lock is activated.

5 — Letters

6 — Numbers and special characters

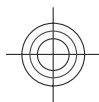

Write text

7 — Character accents

8 — Space bar

9 — Move - Move the cursor.

10 — Backspace

11 — Enter - Move the cursor to the next row or text input field. Additional functions are based on the current context (for example, in the web address field of the web browser, it acts as the Go icon).

12 — Input mode - Select the input method. When you tap an item, the current input method view closes, and the selected one opens.

Handwriting

The input methods and languages supported by the handwriting recognition vary by region and may not be available for all languages.

To activate handwriting mode, select  > **Handwriting**.

Write legible, upright characters on the text input area, and leave a space between each character.

To teach the device your handwriting style, select  > **Handwriting training**.

To enter letters and numbers (default mode), write words as you would normally.

To select number mode, select . To enter non-Latin characters, select the corresponding icon, if available.

To enter special characters, write them as you would normally, or select  and the desired character.

To delete characters or move the cursor back, swipe backwards (see Figure 1).

To insert a space, swipe forwards (see Figure 2).



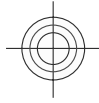

Write text



Alphanumeric keypad

Icons and functions

Use the on-screen keypad (**Alphanumeric keypad**) to enter characters like you would with a traditional phone keypad with numbers on the keys. For an explanation of each icon and its function, see the following figure.

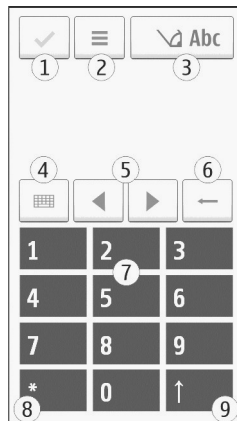

- 1 — Close - Closes on-screen keypad (**Alphanumeric keypad**).
- 2 — Input menu - Opens the touch input menu, which includes commands such as **Activate predictive text** and **Writing language**.





Write text

3 — Text input indicator - Opens a pop-up window, in which you can turn predictive text input modes on or off, change the character case, and switch between letter and number mode.

4 — Input mode - Opens a pop-up window, in which you can select from the available input modes. When you tap an item, the current input method view closes, and the selected one opens.

5 — Arrow keys - Moves the cursor left or right.

6 — Backspace - Deletes the previously entered character.

7 — Number keys - Enters the desired numbers or characters according to the current case and input mode.

8 — Star - Opens a special characters table.

9 — Shift - Changes the character case, turns predictive text input modes on or off, and switches between the alphabet and number modes.

Traditional text input



Tap a number key (1-9) repeatedly until the desired character appears. There are more characters available for a number key than are visible on the key.

If the next letter is located on the same key as the present one, wait until the cursor appears (or move the cursor forward to end the time-out period), and enter the letter.

To insert a space, tap **0**. To move the cursor to the next line, tap **0** three times.

Predictive text input

With predictive text input, you can enter any word with a single key selection. Predictive text input is based on a built-in dictionary to which you can add new words. Predictive text input is not available for all languages.

1. To activate predictive text input for all editors on the device, select  > **Activate prediction**. You can also select  > **Activate predictive text**.



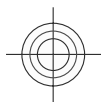



Write text

2. To write the desired word, use the keys 2-9. Select each key only once for one letter. For example, to write "Nokia" when the English dictionary is selected, select **6** for N, **6** for o, **5** for k, **4** for i, and **2** for a.
The word suggestion changes after each key selection.
3. When you finish writing the word correctly, move the cursor right to confirm it, or select **0** to add a space.
If the word is not correct, select ***** repeatedly to view the matching words the dictionary has found one by one.
If the ? character is displayed after the word, the word is not in the dictionary. To add a word to the dictionary, select **Spell**, enter the word using traditional text input, and select **OK**. The word is added to the dictionary. When the dictionary is full, a new word replaces the oldest added word.
4. Start writing the next word.

Switch between text modes

To turn predictive text input off for all editors in your device, tap  and select **Deactivate prediction** or quickly double-tap#. Alternatively, you can tap , and select **Predictive text > Off**.

Touch input settings

Select **Menu > Settings and Phone > Touch input**.

To modify text input settings for the touch screen, select from the following:

- **Handwriting training** — Open the handwriting training application. Train the device to recognise your handwriting better. This option is not available in all languages.
- **Writing language** — Define which language-specific characters in your handwriting are recognised and how the virtual keyboard is laid out.
- **Writing speed** — Select the writing speed.





Write text

- **Guiding line** — Display or hide the guiding line in the writing area. The guiding line helps you write in a straight line, and it also helps the device recognise your writing.
- **Pen trail width** — Select the pen trail width for the text written with the stylus. Stylus is sold separately.
- **Writing colour** — Select the colour of the text written with the stylus. Stylus is sold separately.
- **Adaptive search** — Activate adaptive search.
- **Touch screen calibration** — Calibrate the touch screen.



6. Messaging

Only devices that have compatible features can receive and display multimedia messages. The appearance of a message may vary depending on the receiving device.

Messaging main view







Select **Menu** > **Messaging** (network service).

To create a new message, select **New message**.



Tip: To avoid rewriting messages that you send often, use texts in the Templates folder in My folders. You can also create and save your own templates.

Messaging contains the following folders:

-  **Inbox** — Received messages, except e-mail and cell broadcast messages, are stored here.
-  **My folders** — Organise your messages into folders.
-  **Mailbox** — Connect to your remote mailbox to retrieve your new e-mail messages, or view your previously retrieved e-mail messages offline.
-  **Drafts** — Draft messages that have not been sent are stored here.
-  **Sent** — The last messages that have been sent, excluding messages sent using Bluetooth connectivity, are stored here. You can change the number of messages to save in this folder.
-  **Outbox** — Messages waiting to be sent are temporarily stored in the outbox, for example, when your device is outside network coverage.
-  **Delivery reports** — You can request the network to send you a delivery report of the text messages and multimedia messages you have sent (network service).

Write and send messages

Select **Menu** > **Messaging**.



Important: Exercise caution when opening messages. Messages may contain malicious software or otherwise be harmful to your device or PC.

Before you can create a multimedia message or write an e-mail, you must have the correct connection settings defined.

The wireless network may limit the size of MMS messages. If the inserted picture exceeds this limit, the device may make it smaller so that it can be sent by MMS.

Only devices that have compatible features can receive and display multimedia messages. The appearance of a message may vary depending on the receiving device.

Check the size limit of e-mail messages with your service provider. If you attempt to send an e-mail message that exceeds the size limit of the e-mail server, the message is left in the Outbox folder, and the device attempts to resend it periodically. Sending an e-mail requires a data connection, and continuous attempts to resend the e-mail may incur charges from your service provider. In the Outbox folder, you can delete such a message or move it to the Drafts folder.

Messaging requires network services.

1. To send a text or a multimedia message, select **New message**.
To send an audio or e-mail message, select **Options** > **Create message**, and the relevant option.
2. To select recipients or groups from the contacts list, select  from the toolbar; Or to enter the number or e-mail manually, tap the **To** field.
3. In the Subject field, enter the subject of the e-mail or multimedia message. If the Subject field is not visible, select **Options** > **Message header fields** to change the fields that are visible.
4. To write the message, tap the message field.



Messaging

5. To add an object to a message or e-mail, select  and the relevant type of content.

The message type may change to multimedia message based on the inserted content.

6. To send the message or e-mail, select , or press the call key.

Your device supports text messages beyond the limit for a single message. Longer messages are sent as two or more messages. Your service provider may charge accordingly. Characters with accents, other marks, or some language options take more space, and limit the number of characters that can be sent in a single message.

Set up e-mail

To set up e-mail, select **Menu** > **Messaging** and **Mailbox**.

You can set up several e-mail accounts, for example, a personal e-mail account and a corporate e-mail account.

To set up e-mail from your home screen, select the relevant plug-in. Alternatively, to set up an e-mail account, select **Menu** > **Applications** > **Sett. wizard**.

Mail for Exchange

With Mail for Exchange, you can receive your work e-mail to your device. You can read and reply to your e-mails, view and edit compatible attachments, view calendar information, receive and reply to meeting requests, schedule meetings, and view, add, and edit contact information.

ActiveSync

Use of the Mail for Exchange application is limited to over-the-air synchronisation of PIM information between the Nokia device and the authorised Microsoft Exchange server.

Mail for Exchange can be set up only if your company has Microsoft Exchange Server. In addition, your company's IT administrator must have activated Mail for Exchange for your account.



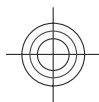

Messaging

Before starting to set up Mail for Exchange, ensure that you have the following:

- A corporate e-mail ID
- Your office network user name
- Your office network password
- Your network domain name (contact your company's IT department)
- Your Mail for Exchange server name (contact your company's IT department)

Depending on your company's Mail for Exchange server configuration, you may need to enter other information in addition to those listed. If you do not know the correct information, contact your company's IT department.

With Mail for Exchange, the use of the lock code may be mandatory. The default lock code of your device is 12345, but your company's IT administrator may have set a different one for you to use.

You can access and modify the Mail for Exchange profile and settings in the Messaging settings.



7. Music player

Music player supports file formats such as AAC, AAC+, eAAC+, MP3, and WMA. Music player does not necessarily support all features of a file format or all the variations of file formats.

You can also use Music player to listen to podcasts. Podcasting is a method for delivering audio or video content over the internet using either RSS or Atom technologies for playback on mobile devices and computers.

You can transfer music from other compatible devices to your device.

Play a song or a podcast

To open Music player, select **Menu** > **Music** > **Music player**.

You may have to refresh the music and podcast libraries after you have updated the song or podcast selection in your device. To add all available items to the library, select **Options** > **Refresh library**.

To play a song or a podcast:

1. Select categories to navigate to the song or podcasts you want to hear.
2. To play an item, select the item from the list.

To pause playback, tap ; to resume, tap .



Music player

To fast-forward or rewind, tap and hold or .

To go to the next item, tap . To return to the beginning of the item, tap . To skip to the previous item, tap again within 2 seconds after a song or podcast has started.

To turn random play () on or off, select **Options** > **Shuffle play**.

To repeat the current item () , all items () , or to turn repeat off, select **Options** > **Repeat**.

If you play podcasts, shuffle and repeat are automatically turned off.

To adjust the volume, press the volume key.

To modify the tone of the music playback, select **Options** > **Equaliser**.

To modify the balance and stereo image or to enhance the bass, select **Options** > **Settings**.

To return to the home screen and leave the player playing in the background, press the end key.

To close the player, select **Options** > **Exit**.

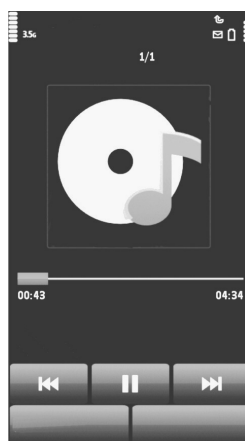

Playlists

Select **Menu** > **Music** > **Music player** and **Playlists**.

To view details of the playlist, select **Options** > **Playlist details**.

Create a playlist

1. Select **Options** > **New playlist**.
2. Enter a name for the playlist, and select **OK**.

www.nokia.com/support

43



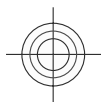

Music player

3. To add songs now, select **Yes**; or to add the songs later, select **No**.
4. If you select **Yes**, select artists to find the songs you want to add to the playlist. Select **Add** to add items.
To show the song list under an artist title, select **Expand**. To hide the song list, select **Collapse**.
5. When you have made your selections, select **Done**.
If a compatible memory card is inserted, the playlist is saved to the memory card.

To add more songs later, when viewing the playlist, select **Options** > **Add songs**.

To add songs, albums, artists, genres, and composers to a playlist from the different views of the music menu, select an item and **Options** > **Add to playlist** > **Saved playlist** or **New playlist**.

To remove a song from a playlist, select **Options** > **Remove**. This does not delete the song from the device; it only removes it from the playlist.

To reorder songs in a playlist, select the song you want to move, and **Options** > **Reorder playlist**. To grab a song and drop it to a new position, select the song in the desired position and **Drop**. To finish reordering the playlist, select **Done**.

Transfer music from a computer

You can use the following methods to transfer music:

- To view your device on a computer as a mass memory device where you can transfer any data files, make the connection with a compatible USB data cable or Bluetooth connectivity. If you are using a USB data cable, select **Mass storage** as the connection mode. A compatible memory card must be inserted in the device.
- To synchronise music with Windows Media Player, connect a compatible USB data cable, and select **Media transfer** as the connection mode. A compatible memory card must be inserted in the device.





Music player

- To install Nokia Music to manage and organise your music files, download the PC software from www.music.nokia.com/download, and follow the instructions.

To change the default USB connection mode, select **Menu > Settings and Connectivity > USB > USB connection mode**.

Nokia Music

With the Nokia Music PC software, you can transfer music to your device from your computer, and manage and organise your music files.

To manage your music in Nokia Music, do the following:

1. Open the Nokia Music software on your PC, and register or sign in to Nokia Music Store.
2. Connect your device to your PC with a compatible USB data cable.
3. To select the connection mode on your device, select **Media transfer**.



8. Camera

Your device supports an image capture resolution of 1600x1200 pixels. The image resolution in this guide may appear different.

Activate the camera

To activate the camera, press the capture key.

Image capture

Still image controls and indicators

The still image viewfinder displays the following:



- 1 — Mode indicator
- 2 — Zoom slider. To activate or deactivate the zoom slider, tap the screen.
- 3 — Capture icon
- 4 — Capture settings
- 5 — Battery charge level indicator
- 6 — Image resolution indicator
- 7 — Image counter (the estimated number of images you can capture using the current image quality setting and available memory)
- 8 — Memory in use. Depending on the setup of your device, there are the following options: device memory (📱) or memory card (💻).
- 9 — GPS signal indicator

10 — Scene modes

Capture and recording settings

To open the capture and recording settings view before capturing an image or recording a video clip, select **Menu > Applications > Camera** and .



The capture and recording settings view provides you with shortcuts to different items and settings before capturing an image or recording a video clip.

The capture and recording settings return to the default settings after you close the camera.

Select from the following:

 — Select the scene.

 or  — Switch between video and image mode.

 or  — Show or hide the viewfinder grid (images only).

 — Activate the self-timer (images only).

 — Activate sequence mode (images only).

 — Open Gallery.

Image settings:

 — Select a colour effect.

 — Adjust the white balance. Select the current lighting conditions. This allows the camera to reproduce colours more accurately.

 — Adjust the exposure compensation (images only). If you are shooting a dark subject against a very light background, such as snow, adjust the exposure to +1 or +2 to compensate for the background brightness. For light subjects against a dark background, use -1 or -2.



Camera

 — Adjust light sensitivity (images only). Increase the light sensitivity in low light conditions to avoid too dark images and blurry images. Increasing the light sensitivity may also increase the image noise.

 — Adjust contrast (images only). Adjust the difference between the lightest and darkest parts of the image.

 — Adjust sharpness (images only).

The screen display changes to match the settings you define.

The capture settings are shooting-mode specific. Switching between the modes does not reset the defined settings.

If you select a new scene, the capture settings are replaced by the selected scene. You can change the capture settings after selecting a scene if needed.

Saving the captured image may take longer if you change the zoom, lighting, or colour settings.





Capture images

When capturing an image, note the following:

- Use both hands to keep the camera still.
- The quality of a digitally zoomed image is lower than that of a non-zoomed image.
- The camera goes into battery saving mode if there are no actions for about a minute. To continue capturing images, select **Continue**.

To capture an image, do the following:

1. To switch from video mode to image mode, if necessary, select  > .
2. To capture an image, press the capture key. Do not move the device before the image is saved and the final image displayed.

To zoom in or out when capturing an image, use the zoom slider.

To leave the camera open in the background and use other applications, press the menu key. To return to the camera, press and hold the capture key.









Camera

After capturing an image

After you capture an image, select from the following options (available only if you have selected **Options > Settings > Show captured image > Yes**):

-  — Send the image in a multimedia or e-mail message, or through connection methods such as Bluetooth connectivity.
 - To send the image to the person you are talking to, select  during a call.
-  — Upload the image to a compatible online album.
-  **Delete** — Delete the image.

To use the image as wallpaper in the home screen, select **Options > Use image > Set as wallpaper**.

To set the image as a default call image to be used for every call situation, select **Options > Use image > Set as call image**.



To assign the image to a contact, **Options > Use image > Assign to contact**.

To return to the viewfinder to capture a new image, press the capture key.



Video recording

Record videos

1. To switch from image mode to video mode, if necessary, select  and the video mode .
2. To start recording, press the capture key or tap . A red record icon is displayed, and a tone sounds.
3. To pause recording at any time, select **Pause**. To resume, select **Continue**. If you pause recording and do not press any key within one minute, the recording stops.

To zoom in or out of the subject, use the zoom key in your device.



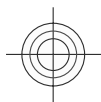

Camera

4. To stop recording, press the capture key. The video clip is automatically saved in Gallery. The maximum length of a video clip is approximately 30 seconds with sharing quality and 90 minutes with other quality settings.

Video recording controls and indicators

The video viewfinder displays the following:





- 1 — Mode indicator
- 2 — Audio mute indicator
- 3 — Record icon
- 4 — Recording settings
- 5 — Battery charge level indicator
- 6 — Video quality indicator. To modify this setting, select **Options** > **Settings** > **Video quality**.
- 7 — Video clip file type
- 8 — Available recording time. When you are recording, the current video length indicator also shows the elapsed and remaining time.
- 9 — The location to which the video clip is saved
- 10 — Scene modes

After recording a video clip

After you record a video clip, select from the following options (available only if you have selected **Options** > **Settings** > **Show last captured video** > **Yes**):



Camera

-  **Play** — Play the video clip you just recorded.
-  — Upload the image to a compatible online album.
-  **Delete** — Delete the video clip.

To return to the viewfinder to record a new video clip, press the capture key.





www.nokia.com/support

51







9. Gallery

To store and organise your images, video clips, sound clips, and streaming links, select **Menu** > **Gallery**.

 **Tip:** To access the images and video clips view quickly, tap the media key () to open the media bar, and select .

View and organise files

Select **Menu** > **Gallery** and from the following:

-  **Images & videos** — View images in the image viewer and videos in Video centre.
-  **Songs** — Open Music player.
-  **Sound clips** — Listen to sound clips.
-  **Other media** — View presentations.

You can browse, open, and create folders; and mark, copy, move, and add items to folders.

Files stored on your compatible memory card (if inserted) are indicated with



To open a file, select a file from the list. Video clips and files with the .ram file extension open and play in Video centre, and music and sound clips in Music player.

To copy or move files to the memory card (if inserted) or device memory, select a file, **Options** > **Organise** > **Copy** or **Move**, and from the available options.

View images and videos

Select **Menu** > **Gallery** and **Images & videos**.



Gallery

The images, video clips, and folders are displayed in a loop and ordered by date and time. To browse the files one by one, swipe left or right. To browse files in groups, swipe up or down.

To open a file, select a file from the list. To zoom in an image, use the volume key in your device.

Select **Options** and from the following:

- **Edit** — Edit a video clip or an image.
- **Use file** — To use the image as wallpaper in the home screen, select **Set as wallpaper**.

To set the image as a generic call image, select **Set as call image**.



To set the image as a call image for a contact, select **Assign to contact**.

To set the video clip as a ringing tone, select **As ringing tone**.

To assign the video clip as a ringing tone for a contact, select **Assign to contact**.

The toolbar helps you select frequently used functions with images, video clips, and folders.

From the toolbar, select from the following:

-  **Send** — Send the selected image or video clip.
-  **Edit** — Edit the selected image or video clip.
-  **Delete** — Delete the selected image or video clip.





10. Share online

About Share online

Select **Menu** > **Internet** > **Share online**.

With Share online (network service), you can post your images, video clips, and sound clips from your device to compatible online sharing services, such as albums and blogs. You can also view and send comments to the posts in these services, and download content to your compatible Nokia device.

The supported content types and the availability of the Share online service may vary.

Subscribe to services

Select **Menu** > **Internet** > **Share online**.

To subscribe to an online sharing service, go to the service provider's website, and check that your Nokia device is compatible with the service. Create an account as instructed on the website. You receive a user name and password needed to set up your device with the account.

1. To activate a service, open the Share online application in your device, select a service and **Options** > **Activate**.
2. Allow the device to create a network connection. If you are prompted for an internet access point, select one from the list.
3. Sign in to your account as instructed on the service provider's website.

For the availability and cost of the third party services and data transfer costs, contact your service provider or the relevant third party.

Manage your accounts

To view your accounts, select **Options** > **Settings** > **My accounts**.

To create a new account, select **Options** > **Add new account**.





Share online

To change your user name or password for an account, select the account and **Options > Open**.

To set the account as the default when sending posts from your device, select **Options > Set as default**.

To remove an account, select the account and **Options > Delete**.

Create a post

Select **Menu > Internet > Share online**.

To post media files to a service, select a service and **Options > New upload**. If the online sharing service provides channels for posting files, select the desired channel.

To add an image, video clip, or sound clip to the post, select **Options > Insert**.

Enter a title or description for the post, if available.

To add tags to the post, select **Tags**.

To enable the posting of location information contained in the file, select **Location**.

To set the level of privacy for a file, select **Privacy**. To allow everyone to view your file, select **Public**. To restrict others from seeing your files, select **Private**. You can define the **Default** setting on the service provider's website.

To send the post to the service, select **Options > Upload**.

Post files from Gallery

You can post your files from Gallery to an online sharing service.

1. Select **Menu > Gallery** and the files you want to post.
2. Select **Options > Send > Upload** and the desired account.
3. Edit your post as required.
4. Select **Options > Upload**.

www.nokia.com/support

55





11. Nokia Video Centre

With Nokia Video Centre (network service), you can download and stream video clips over the air from compatible internet video services using a packet data connection. You can also transfer video clips from a compatible PC to your device and view them in Video centre.

Using packet data access points to download videos may involve the transmission of large amounts of data through your service provider's network. Contact your service provider for information about data transmission charges.

Your device may have predefined services.

Service providers may provide free content or charge a fee. Check the pricing in the service or from the service provider.

View and download video clips

Connect to video services

1. Select **Menu** > **Applications** > **Video centre**.
2. To connect to a service to install video services, select **Add new services** and the desired video service from the service catalogue.

View a video clip

To browse the content of installed video services, select **Video feeds**.

The content of some video services is divided into categories. To browse video clips, select a category. To search for a video clip in the service, select **Video search**. Search may not be available in all services.

To view information about the selected video clip, select **Options** > **Video details**.

Some video clips can be streamed over the air, but others must be first downloaded to your device. To download a video clip, select **Options** > **Download**. Downloads continue in the background if you exit the application. The downloaded video clips are saved in My videos. To stream a video clip or view a downloaded one, select



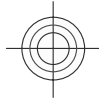

Nokia Video Centre

Options > Play. When the video clip is playing, to use the control keys for controlling the player, tap the screen. To adjust the volume, use the volume key.



Warning: Continuous exposure to high volume may damage your hearing. Listen to music at a moderate level, and do not hold the device near your ear when the loudspeaker is in use.

Schedule downloads

Setting the application to download video clips automatically may involve the transmission of large amounts of data through your service provider's network. For information about data transmission charges, contact your service provider. To schedule an automatic download for video clips in a service, select a category and **Options > Schedule downloads.** Video centre automatically downloads new video clips daily at the time you define.

To cancel scheduled downloads for a category, select **Manual download** as the download method.



Video feeds

Select **Menu > Applications > Video centre.**

The content of the installed video services is distributed using RSS feeds. To view and manage your feeds, select **Video feeds.**

Select **Options** and from the following:

- **Feed subscriptions** — Check your current feed subscriptions.
- **Feed details** — View information about a video.
- **Add feed** — Subscribe to new feeds. Select **Via Video directory** to select a feed from the services in the video directory.
- **Refresh feeds** — Refresh the content of all feeds.
- **Manage account** — Manage your account options for a particular feed, if available.
- **Move** — Move video clips to a desired location.

To view the videos available in a feed, select a feed from the list.

www.nokia.com/support

57





Nokia Video Centre

My videos

My videos is a storage place for all video clips in the Video centre application. You can list downloaded video clips and video clips recorded with the device camera in separate views.

1. To open a folder and view video clips, select the folder. When a video clip is playing, to use the control keys for controlling the player, tap the screen.
2. To adjust the volume, press the volume key.

Select **Options** and from the following:

- **Resume download** — Resume a paused or failed download.
- **Cancel download** — Cancel a download.
- **Video details** — View information about a video clip.
- **Find** — Find a video clip. Enter a search term that matches the file name.
- **Memory status** — View the amount of free and used memory.
- **Sort by** — Sort video clips. Select the desired category.
- **Move and copy** — Move or copy video clips. Select **Copy** or **Move** and the desired location.



Transfer videos from your PC

Transfer your own video clips to Video centre from compatible devices using a compatible USB data cable. Video centre will display only the video clips which are in a format supported by your device.

1. To view your device on a PC as a mass memory device where you can transfer any data files, make the connection with a USB data cable.
2. Select **Mass storage** as the connection mode. A compatible memory card needs to be inserted in the device.
3. Select the video clips you want to copy from your PC.
4. Transfer the video clips to **E:\My Videos** in the memory card.

The transferred video clips appear in the My videos folder in Video centre. Video files in other folders of your device are not displayed.

Video centre settings

In the Video centre main view, select **Options** > **Settings** and from the following:

- **Video service selection** — Select the video services that you want to appear in Video centre. You can also add, remove, edit, and view the details of a video service. You cannot edit preinstalled video services.
- **Connection settings** — To define the network destination used for the network connection, select **Network connection**. To select the connection manually each time Video centre opens a network connection, select **Always ask**.

To set GPRS connection on or off, select **Confirm GPRS usage**.



To set roaming on or off, select **Confirm roaming**.

- **Parental control** — Set an age limit to videos. The required password is the same as the device lock code. The factory setting for the lock code is **12345**. In video-on-demand services, videos which have the same or a higher age limit than you have set, are hidden.
- **Preferred memory** — Select whether downloaded videos are saved in the device memory or on a compatible memory card.
- **Thumbnails** — Select whether to download and view thumbnail images in video feeds.

12. Web browser

With the web browser, you can view hypertext markup language (HTML) pages on the web as originally designed (network service). You can also browse web pages that are designed specifically for mobile devices, and use extensible hypertext markup language (XHTML), or the wireless markup language (WML).

To browse the web, you need to have an internet access point defined in your device.

 **Tip:** To open the browser, select the media key () to open the media bar, and select .

Browse the web

Select **Menu > Internet > Web**.

 **Important:** Use only services that you trust and that offer adequate security and protection against harmful software.

 **Important:** Only install and use applications and other software from trusted sources, such as applications that are Symbian Signed or have passed the Java Verified™ testing.

To browse a web page, in the bookmarks view, select a bookmark, or enter the address in the field () and select **Go to**.

Some web pages may contain material, such as graphics and sounds, that requires a large amount of memory to view. If your device runs out of memory while loading such a web page, the graphics on the page are not shown.

To browse web pages without graphics to save memory, select **Options > Settings > Page > Load content > Text only**.

To enter a new web address you want to visit, select **Options > Go to > New web page**.



Web browser

To refresh the content of the web page, select **Options > Web page options > Reload**.

To save the current web page as a bookmark, select **Options > Web page options > Save as bookmark**.

To view snapshots of the web pages you have visited during the current browsing session, select **Back** (available if **History list** is set on in the browser settings and the current web page is not the first web page you visit). Select the web page you want.

To open a sublist of commands or actions for the current web page, select **Options > Service options** (if supported by the web page).

To prevent or allow the automatic opening of multiple windows, select **Options > Web page options > Block pop-ups** or **Allow pop-ups**.





Tip: To take the browser to the background, press the end key once. To end the connection, press and hold the end key.







Browser toolbar

The browser toolbar helps you select frequently used functions of the browser.

From the toolbar, select from the following:

-  **Expand toolbar** — Expand the toolbar to access more toolbar functions.
-  **Go to web address** — Enter a new web address.
-  **Show zoom** — Zoom in or out on the web page.

To use the expanded toolbar, select  **Expand toolbar** and from the following:

-  **Go to feeds** — View your current feed subscriptions.
-  **Full screen** — Switch to the full screen view.
-  **Subsc. feeds** — View a list of available web feeds on the current web page, and subscribe to a web feed.
-  **Settings** — Edit the settings.
-  **Save bkmrk.** — Save the current web page as a bookmark.

www.nokia.com/support

61





Web browser

- **Reload** — Refresh the web page.
- **Overview** — View an overview of the current web page.
- **Homepage** — Go to the homepage (if defined in the settings).
- **Bookmarks** — Open the bookmarks view.
- **Find keyword.** — Search on the current web page.

Bookmarks

The bookmarks view opens when you open the Web application. You can select web addresses from a list or from a collection of bookmarks in the **Recently visited pages** folder.

The toolbar helps you select frequently used functions of the browser.

On the toolbar, select from the following:

- **Add bookmark** — Add a new bookmark.
- **Go to web address** — Enter a new web address.
- **Delete** — Delete a bookmark.

Select **Options** and from the following:

- **Go to** — Enter a new web address, go to the previous web page, or view saved links to web feeds and blogs.
- **Bookmark options** — Send and add bookmarks, and set bookmarks as a homepage.
- **Bookmark manager** — Edit, move, and delete bookmarks.

Web also keeps track of the web pages you visit during browsing. In the **Recently visited pages** folder, you can view the list of the visited web pages.

Empty the cache

The information or services you have accessed are stored in the cache memory of the device.





Web browser

A cache is a memory location that is used to store data temporarily. If you have tried to access or have accessed confidential information requiring passwords, empty the cache after each use.

To empty the cache, select **Options** > **Clear privacy data** > **Cache**.

Connection security

If the security indicator (🔒) is displayed during a connection, the data transmission between the device and the internet gateway or server is encrypted.

The security icon does not indicate that the data transmission between the gateway and the content server (where the data is stored) is secure. The service provider secures the data transmission between the gateway and the content server.

Security certificates may be required for some services, such as banking services. You are notified if the identity of the server is not authentic or if you do not have the correct security certificate in your device. For more information, contact your service provider.

 **Important:** Even if the use of certificates makes the risks involved in remote connections and software installation considerably smaller, they must be used correctly in order to benefit from increased security. The existence of a certificate does not offer any protection by itself; the certificate manager must contain correct, authentic, or trusted certificates for increased security to be available. Certificates have a restricted lifetime. If "Expired certificate" or "Certificate not valid yet" is shown, even if the certificate should be valid, check that the current date and time in your device are correct.

Before changing any certificate settings, you must make sure that you really trust the owner of the certificate and that the certificate really belongs to the listed owner.





13. Positioning (GPS)

You can use applications such as GPS data to calculate your location or measure distances. These applications require a GPS connection.

About GPS

The coordinates in the GPS are expressed using the international WGS-84 coordinate system. The availability of the coordinates may vary by region.

The Global Positioning System (GPS) is operated by the government of the United States, which is solely responsible for its accuracy and maintenance. The accuracy of location data can be affected by adjustments to GPS satellites made by the United States government and is subject to change with the United States Department of Defense civil GPS policy and the Federal Radionavigation Plan. Accuracy can also be affected by poor satellite geometry. Availability and quality of GPS signals may be affected by your location, buildings, natural obstacles, and weather conditions. GPS signals may not be available inside buildings or underground and may be impaired by materials such as concrete and metal.

GPS should not be used for precise location measurement, and you should never rely solely on location data from the GPS receiver and cellular radio networks for positioning or navigation.

The trip meter has limited accuracy, and rounding errors may occur. Accuracy can also be affected by availability and quality of GPS signals.

Different positioning methods can be enabled or disabled in positioning settings.

Assisted GPS (A-GPS)

Your device also supports Assisted GPS (A-GPS).

A-GPS is a network service.

Assisted GPS (A-GPS) is used to retrieve assistance data over a packet data connection, which assists in calculating the coordinates of your current location when your device is receiving signals from satellites.



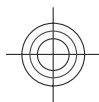

Positioning (GPS)

When you activate A-GPS, your device receives useful satellite information from an assistance data server over the cellular network. With the help of assisted data, your device can obtain the GPS position faster.

Your device is preconfigured to use the Nokia A-GPS service, if no service provider-specific A-GPS settings are available. The assistance data is retrieved from the Nokia A-GPS service server only when needed.

You must have an internet access point defined in the device to retrieve assistance data from the Nokia A-GPS service over a packet data connection. To define an access point for A-GPS, select **Menu > Applications > Location and Positioning > Positioning server > Access point**. Only a packet data internet access point can be used. Your device asks for the internet access point when GPS is used for the first time.

Hold your device correctly

When using the GPS receiver, ensure you do not cover the antenna with your hand.

Establishing a GPS connection may take from a couple of seconds to several minutes. Establishing a GPS connection in a vehicle may take longer.

The GPS receiver draws its power from the device battery. Using the GPS receiver may drain the battery faster.

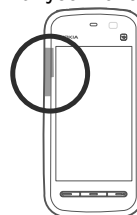

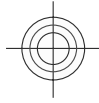

14. Connectivity

Your device offers several options to connect to the internet or to another compatible device or PC.





15. Green tips

Here are tips on how you can contribute to protecting the environment.



Save energy

When you have fully charged the battery and disconnected the charger from the device, unplug the charger from the wall outlet.

You do not need to charge your battery so often if you do the following:

- Close and disable applications, services, and connections when not in use.
- Decrease the brightness of the screen.
- Set the device to enter the power saver mode after the minimum period of inactivity, if available in your device.
- Disable unnecessary sounds, such as keypad and ringing tones.



Recycle

Most of the materials in a Nokia phone are recyclable. Check how to recycle your Nokia products at www.nokia.com/werecycle, or with a mobile device, www.nokia.mobi/werecycle.

Recycle packaging and user guides at your local recycling scheme.

Save paper

This user guide helps you get started with your device. For more detailed instructions, open the in-device help (in most applications, select **Options** > **Help**). For further support, see www.nokia.com/support.

www.nokia.com/support

67

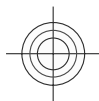



Green tips

Learn more

For more information on the environmental attributes of your device, see www.nokia.com/ecodeclaration.



68

www.nokia.com/support

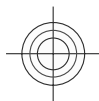



Accessories

 **Warning:** Use only batteries, chargers, and accessories approved by Nokia for use with this particular model. The use of any other types may invalidate any approval or warranty, and may be dangerous.

For availability of approved accessories, please check with your dealer. When you disconnect the power cord of any accessory, grasp and pull the plug, not the cord.



www.nokia.com/support

69





Battery

Battery and charger information

Your device is powered by a rechargeable battery. The battery intended for use with this device is BL-5J. Nokia may make additional battery models available for this device. This device is intended for use when supplied with power from the following chargers: AC-8E. The exact charger model number may vary depending on the type of plug. The plug variant is identified by one of the following: E, EB, X, AR, U, A, C, K, or UB.

The battery can be charged and discharged hundreds of times, but it will eventually wear out. When the talk and standby times are noticeably shorter than normal, replace the battery. Use only Nokia approved batteries, and recharge your battery only with Nokia approved chargers designated for this device.

If a battery is being used for the first time or if the battery has not been used for a prolonged period, it may be necessary to connect the charger, then disconnect and reconnect it to begin charging the battery. If the battery is completely discharged, it may take several minutes before the charging indicator appears on the display or before any calls can be made.

Safe removal. Always switch the device off and disconnect the charger before removing the battery.

Proper charging. Unplug the charger from the electrical plug and the device when not in use. Do not leave a fully charged battery connected to a charger, since overcharging may shorten its lifetime. If left unused, a fully charged battery will lose its charge over time.

Avoid extreme temperatures. Always try to keep the battery between 15°C and 25°C (59°F and 77°F). Extreme temperatures reduce the capacity and lifetime of the battery. A device with a hot or cold battery may not work temporarily. Battery performance is particularly limited in temperatures well below freezing.

Do not short-circuit. Accidental short-circuiting can occur when a metallic object such as a coin, clip, or pen causes direct connection of the positive (+) and negative (-) terminals of the battery. (These look like metal strips on the battery.) This might





Battery

happen, for example, when you carry a spare battery in your pocket or purse. Short-circuiting the terminals may damage the battery or the connecting object.

Disposal. Do not dispose of batteries in a fire as they may explode. Dispose of batteries according to local regulations. Please recycle when possible. Do not dispose as household waste.

Leak. Do not dismantle, cut, open, crush, bend, puncture, or shred cells or batteries. In the event of a battery leak, prevent battery liquid contact with skin or eyes. If this happens, flush the affected areas immediately with water, or seek medical help.

Damage. Do not modify, remanufacture, attempt to insert foreign objects into the battery, or immerse or expose it to water or other liquids. Batteries may explode if damaged.

Correct use. Use the battery only for its intended purpose. Improper battery use may result in a fire, explosion, or other hazard. If the device or battery is dropped, especially on a hard surface, and you believe the battery has been damaged, take it to a service centre for inspection before continuing to use it. Never use any charger or battery that is damaged. Keep your battery out of the reach of small children.



Nokia battery authentication guidelines

Always use original Nokia batteries for your safety. To check that you are getting an original Nokia battery, purchase it from a Nokia authorised service centre or dealer, and inspect the hologram label using the following steps:

Authenticate hologram

1. When you look at the hologram on the label, you should see the Nokia connecting hands symbol from one angle and the Nokia Original Enhancements logo when looking from another angle.





Battery

2. When you angle the hologram left, right, down and up, you should see 1, 2, 3 and 4 dots on each side respectively.

Successful completion of the steps is not a total assurance of the authenticity of the battery. If you cannot confirm authenticity or if you have any reason to believe that your Nokia battery with the hologram on the label is not an authentic Nokia battery, you should refrain from using it, and take it to the nearest Nokia authorised service centre or dealer for assistance.

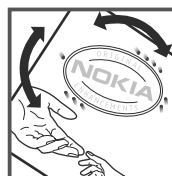

For additional information, refer to the warranty and reference leaflet included with your Nokia device.



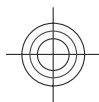

Taking care of your device

Your device is a product of superior design and craftsmanship and should be treated with care. The following suggestions will help you protect your warranty coverage.

- Keep the device dry. Precipitation, humidity, and all types of liquids or moisture can contain minerals that will corrode electronic circuits. If your device does get wet, remove the battery, and allow the device to dry completely before replacing it.
- Do not use or store the device in dusty, dirty areas. Its moving parts and electronic components can be damaged.
- Do not store the device in high or cold temperature. High temperatures can shorten the life of electronic devices, damage batteries, and warp or melt certain plastics. When the device warms to its normal temperature from a cold temperature, moisture can form inside the device and damage electronic circuit boards.
- Do not attempt to open the device other than as instructed in this guide.
- Do not drop, knock, or shake the device. Rough handling can break internal circuit boards and fine mechanics.
- Do not use harsh chemicals, cleaning solvents, or strong detergents to clean the device. Only use a soft, clean, dry cloth to clean the surface of the device.
- Do not paint the device. Paint can clog the moving parts and prevent proper operation.
- Use only the supplied or an approved replacement antenna. Unauthorised antennas, modifications, or attachments could damage the device and may violate regulations governing radio devices.
- Use chargers indoors.
- Backup all data you want to keep, such as contacts and calendar notes.
- To reset the device from time to time for optimum performance, power off the device and remove the battery.

These suggestions apply equally to your device, battery, charger, or any accessory.

www.nokia.com/support

73



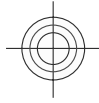

Taking care of your device

Recycle

Always return your used electronic products, batteries, and packaging materials to dedicated collection points. This way you help prevent uncontrolled waste disposal and promote the recycling of materials. Check product environmental information and how to recycle your Nokia products at www.nokia.com/werecycle, or nokia.mobi/werecycle.





Additional safety information

Small children

Your device and its accessories are not toys. They may contain small parts. Keep them out of the reach of small children.

Operating environment

This device meets RF exposure guidelines in the normal use position at the ear or at least 1.5 centimetres (5/8 inch) away from the body. Any carry case, belt clip, or holder for body-worn operation should not contain metal and should position the device the above-stated distance from your body.

To send data files or messages requires a quality connection to the network. Data files or messages may be delayed until such a connection is available. Follow the separation distance instructions until the transmission is completed.

Parts of the device are magnetic. Metallic materials may be attracted to the device. Do not place credit cards or other magnetic storage media near the device, because information stored on them may be erased.

During extended operation such as an active high speed data connection, the device may feel warm. In most cases, this condition is normal. If you suspect the device is not working properly, take it to the nearest authorised service facility.

Medical devices

Operation of radio transmitting equipment, including wireless phones, may interfere with the function of inadequately protected medical devices. Consult a physician or the manufacturer of the medical device to determine whether they are adequately shielded from external RF energy. Switch off your device when regulations posted instruct you to do so. Hospitals or health care facilities may use equipment sensitive to external RF energy.





Additional safety information

Implanted medical devices

Manufacturers of medical devices recommend a minimum separation of 15.3 centimetres (6 inches) between a wireless device and an implanted medical device, such as a pacemaker or implanted cardioverter defibrillator, to avoid potential interference with the medical device. Persons who have such devices should:

- Always keep the wireless device more than 15.3 centimetres (6 inches) from the medical device.
- Not carry the wireless device in a breast pocket.
- Hold the wireless device to the ear opposite the medical device.
- Turn the wireless device off if there is any reason to suspect that interference is taking place.
- Follow the manufacturer directions for the implanted medical device.

If you have any questions about using your wireless device with an implanted medical device, consult your health care provider.



Hearing aids

Some digital wireless devices may interfere with some hearing aids.



Vehicles

RF signals may affect improperly installed or inadequately shielded electronic systems in motor vehicles such as electronic fuel injection, electronic antilock braking, electronic speed control, and air bag systems. For more information, check with the manufacturer of your vehicle or its equipment.

Only qualified personnel should service the device or install the device in a vehicle. Faulty installation or service may be dangerous and may invalidate your warranty. Check regularly that all wireless device equipment in your vehicle is mounted and operating properly. Do not store or carry flammable liquids, gases, or explosive materials in the same compartment as the device, its parts, or accessories. Remember that air bags inflate with great force. Do not place your device or accessories in the air bag deployment area.





Additional safety information

Switch off your device before boarding an aircraft. The use of wireless teledevices in an aircraft may be dangerous to the operation of the aircraft and may be illegal.

Potentially explosive environments

Switch off your device in any area with a potentially explosive atmosphere. Obey all posted instructions. Sparks in such areas could cause an explosion or fire resulting in bodily injury or death. Switch off the device at refuelling points such as near gas pumps at service stations. Observe restrictions in fuel depots, storage, and distribution areas; chemical plants; or where blasting operations are in progress. Areas with a potentially explosive atmosphere are often, but not always, clearly marked. They include areas where you would be advised to turn off your vehicle engine, below deck on boats, chemical transfer or storage facilities and where the air contains chemicals or particles such as grain, dust, or metal powders. You should check with the manufacturers of vehicles using liquefied petroleum gas (such as propane or butane) to determine if this device can be safely used in their vicinity.



Emergency calls

 **Important:** This device operates using radio signals, wireless networks, landline networks, and user-programmed functions. If your device supports voice calls over the internet (internet calls), activate both the internet calls and the cellular phone. The device will attempt to make emergency calls over both the cellular networks and through your internet call provider if both are activated. Connections in all conditions cannot be guaranteed. You should never rely solely on any wireless device for essential communications like medical emergencies.

To make an emergency call:

1. If the device is not on, switch it on. Check for adequate signal strength. Depending on your device, you may also need to complete the following:
 - Insert a SIM card if your device uses one.
 - Remove certain call restrictions you have activated in your device.
 - Change your profile from offline profile mode to an active profile.

www.nokia.com/support

77





Additional safety information

- If the screen and keys are locked, slide the lock switch on the side of the device to unlock them.
2. Press the end key as many times as needed to clear the display and ready the device for calls.
 3. To open the dialler, select **Telephone** or .
 4. Enter the official emergency number for your present location. Emergency numbers vary by location.
 5. Press the call key.

When making an emergency call, give all the necessary information as accurately as possible. Your wireless device may be the only means of communication at the scene of an accident. Do not end the call until given permission to do so.

Certification information (SAR)

This mobile device meets guidelines for exposure to radio waves.

Your mobile device is a radio transmitter and receiver. It is designed not to exceed the limits for exposure to radio waves recommended by international guidelines. These guidelines were developed by the independent scientific organisation ICNIRP and include safety margins designed to assure the protection of all persons, regardless of age and health.

The exposure guidelines for mobile devices employ a unit of measurement known as the Specific Absorption Rate or SAR. The SAR limit stated in the ICNIRP guidelines is 2.0 watts/kilogram (W/kg) averaged over 10 grams of tissue. Tests for SAR are conducted using standard operating positions with the device transmitting at its highest certified power level in all tested frequency bands. The actual SAR level of an operating device can be below the maximum value because the device is designed to use only the power required to reach the network. That amount changes depending on a number of factors such as how close you are to a network base station.

The highest SAR value under the ICNIRP guidelines for use of the device at the ear is 1.08 W/kg.





Additional safety information

Use of device accessories may result in different SAR values. SAR values may vary depending on national reporting and testing requirements and the network band. Additional SAR information may be provided under product information at www.nokia.com.

Your mobile device is also designed to meet the requirements for exposure to radio waves established by the Federal Communications Commission (USA) and Industry Canada. These requirements set a SAR limit of 1.6 W/kg averaged over one gram of tissue. The highest SAR value reported under this standard during product certification for use at the ear is 1.01 W/kg and when properly worn on the body is 0.91 W/kg.



www.nokia.com/support

79



Index

A

A-GPS (assisted GPS) 64
access codes 12
antenna 25
assisted GPS (A-GPS) 64
audio messages 39

B

battery
 inserting 14
bookmarks 62
browser
 bookmarks 62
 browsing pages 60
 cache memory 62
 security 63
 toolbar 61

C

cache memory 62
calls 31
camera
 assigning images to contacts 49
 image mode 48
 indicators 46, 50
 options 49
 recording 50
 sending images 49
 video mode 49
capture settings
 in camera 47

contacts bar 25

D

display rotation 27

E

e-mail 40

G

gallery 52
 organising 52
 viewing 52
 viewing images 52
 viewing videos 52
general information 9
GPS (Global Positioning System) 64

H

headset 27
help application 9
home screen 20

I

internet connection 60
 See also *browser*

K

keypad lock 19
keys 17

L

location information 64
lock code 12
lock switch 19
locking the keys 19

M

Mail for Exchange 40

media

music player 42

media bar 23

media key 23

memory

web cache 62

memory card 15

menu 20

messages

folders for 38

MMS (multimedia message service) 39

multimedia messages 39

music player 42

playlists 43

transferring music 44

N

navigation tools 64

Nokia Care 23

Nokia Music 45

Nokia support information 10

O

offline profile 26

www.nokia.com/support

outbox, message 38

P**photos**

See camera

PIN code 12

PIN2 code 12

positioning information 64

profiles

offline restrictions 26

proximity sensor 31

PUK codes 12

R

recording settings

in camera 47

recording video clips 49

S**security**

web browser 63

security code 12

sensors 27

sent messages folder 38

settings 47

video centre 59

Share online 54

accounts 54

activating services 54

creating posts 55

posting 55

subscribing 54

sharing media files online 54

Index

SIM card

- inserting 13
- removing 29

SMS (short message service) 39

software

- updating 10

software updates 11

songs 42

support resources 10

T

text input 33, 35

text messages

- sending 39

touch screen 21, 36

U

updates

- device software 11

UPIN code 12

uploading media files 54

UPUK code 12

useful information 9

V

Video Centre 56

video centre

- downloading 56
- my videos 58
- transferring videos 58
- video feeds 57
- viewing 56

virtual keyboard 32

voice calls

See *calls*

W

web connection 60

wrist strap 28

Z

zooming 49