

Nokia X5-01 User Guide

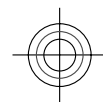

9221954
Issue 1

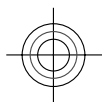
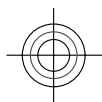
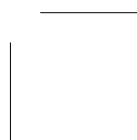
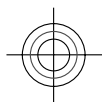
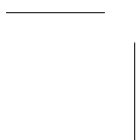

2 Contents

Contents		4. Make calls	20
Safety	4	Make a call	20
About your device	4	Answer or reject a call	21
Network services	6	Voice mail	21
Shared memory	6	5. Contacts	22
About Digital Rights Management	6	Stay connected with your online friends	22
1. Get started	8	Save and edit names and numbers	22
Keys and parts	8	6. Messaging	22
Insert SIM card and battery	9	Write and send messages	22
Memory card	10	Check the number of unread messages	24
Antenna locations	11	Set up your e-mail	25
Switch the device on and off	11	About Chat	25
Charge the battery	12	Ovi Contacts	25
Keypad lock (keyguard)	13	7. Music and audio	27
Volume control	14	Music key	27
Copy content from your old device	14	Music player	27
Visit Ovi by Nokia	15	Ovi Music	29
2. Your device	16	8. Images and videos	30
Home screen	16	Camera	30
Write text	16	Share online	30
3. Personalise your device	18	9. Connectivity	31
Profiles	18	Wireless LAN	31
Select ringing tones	19		
Change the display theme	20		

www.nokia.com/support

Bluetooth	34
10. Find help	37
Support	37
Keep your device software up to date	38
In-device help	40
Extended user guide	40
Access codes	40
11. Green tips	41
Save energy	41
Recycle	42
Product and safety information	42
Index	50

www.nokia.com/support

4 Safety

Safety

Read these simple guidelines. Not following them may be dangerous or illegal. Read the complete user guide for further information.

SWITCH ON SAFELY



Do not switch the device on when wireless phone use is prohibited or when it may cause interference or danger.

ROAD SAFETY COMES FIRST



Obey all local laws. Always keep your hands free to operate the vehicle while driving. Your first consideration while driving should be road safety.

INTERFERENCE



All wireless devices may be susceptible to interference, which could affect performance.

SWITCH OFF IN RESTRICTED AREAS



Follow any restrictions. Switch the device off in aircraft, near medical equipment, fuel, chemicals, or blasting areas.

QUALIFIED SERVICE



Only qualified personnel may install or repair this product.

ACCESSORIES AND BATTERIES



Use only approved accessories and batteries. Do not connect incompatible products.

WATER-RESISTANCE



Your device is not water-resistant. Keep it dry.

About your device

The wireless device described in this guide is approved for use on the (E)GSM 850, 900, 1800, and 1900 networks, and UMTS 900, 1900, and 2100 HSDPA and HSUPA networks. Contact your service

www.nokia.com/support

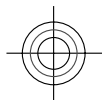

provider for more information about networks.

Your device supports several connectivity methods and like computers may be exposed to viruses and other harmful content. Exercise caution with messages, connectivity requests, browsing, and downloads. Only install and use services and software from trustworthy sources that offer adequate security and protection, such as applications that are Symbian Signed or have passed the Java Verified™ testing. Consider installing antivirus and other security software on your device and any connected computer.

Your device may have preinstalled bookmarks and links for third-party internet sites and may allow you to access third-party sites. These are not affiliated with Nokia, and Nokia does not endorse or assume liability for them. If you access such sites, take precautions for security or content.

Warning:

To use any features in this device, other than the alarm clock, the device must be switched on. Do not switch the device on when wireless device use may cause interference or danger.

When using this device, obey all laws and respect local customs, privacy and legitimate rights of others, including copyrights. Copyright protection may prevent some images, music, and other content from being copied, modified, or transferred.

Make back-up copies or keep a written record of all important information stored in your device.

When connecting to any other device, read its user guide for detailed safety instructions. Do not connect incompatible products.

The images in this guide may differ from your device display.

Refer to the user guide for other important information about your device.

www.nokia.com/support

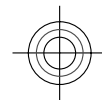
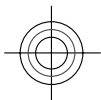
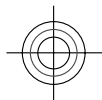

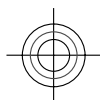

6 Safety

Network services

To use the device you must have service from a wireless service provider. Some features are not available on all networks; other features may require that you make specific arrangements with your service provider to use them. Network services involve transmission of data. Check with your service provider for details about fees in your home network and when roaming on other networks. Your service provider can explain what charges will apply. Some networks may have limitations that affect how you can use some features of this device requiring network support such as support for specific technologies like WAP 2.0 protocols (HTTP and SSL) that run on TCP/IP protocols and language-dependent characters.

Your service provider may have requested that certain features be disabled or not activated in your device. If so, these features will not appear on your device menu. Your device may also have customized items such as menu names, menu order, and icons.

Shared memory

The following features in this device may share memory: multimedia messaging (MMS), e-mail application, instant messaging, for example. Use of one or more of these features may reduce the memory available for the remaining features. If your device displays a message that the memory is full, delete some of the information stored in the shared memory.

About Digital Rights Management

When using this device, obey all laws and respect local customs, privacy and legitimate rights of others, including copyrights. Copyright protection may prevent you from copying, modifying, or transferring images, music, and other content.

Content owners may use different types of digital rights management (DRM) technologies to protect their intellectual property, including copyrights. This device uses various types of DRM software to access DRM-protected content. With this device you can access content protected with WMDRM 10 and OMA DRM 2.0. If certain DRM software fails to protect the

www.nokia.com/support

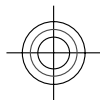
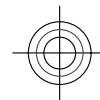
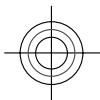

content, content owners may ask that such DRM software's ability to access new DRM-protected content be revoked. Revocation may also prevent renewal of such DRM-protected content already in your device. Revocation of such DRM software does not affect the use of content protected with other types of DRM or the use of non-DRM-protected content.

Digital rights management (DRM) protected content comes with an associated licence that defines your rights to use the content.

If your device has OMA DRM-protected content, to back up both the licence and the content, use the backup feature of Nokia Ovi Suite.

Other transfer methods may not transfer the licences which need to be restored with the content for you to be able to continue the use of OMA DRM-protected content after the device memory is formatted. You may also need to restore the licence in case the files on your device get corrupted.

If your device has WMDRM-protected content, both the licence and the content will be lost if the device memory

is formatted. You may also lose the licence and the content if the files on your device get corrupted. Losing the licence or the content may limit your ability to use the same content on your device again. For more information, contact your service provider.

Some licences may be connected to a specific SIM card, and the protected content can be accessed only if the SIM card is inserted in the device.

www.nokia.com/support

8 Get started

1. Get started

Keys and parts

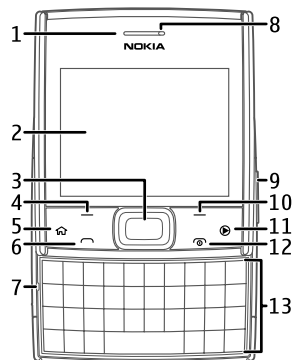

- 1 Ambient light sensor
- 2 Display
- 3 Navi™ key (scroll key)
- 4 Left selection key
- 5 Home key
- 6 Call key
- 7 Microphone
- 8 Earpiece
- 9 Volume/Zoom keys
- 10 Right selection key
- 11 Music key

- 12 End/Power key
- 13 Keyboard

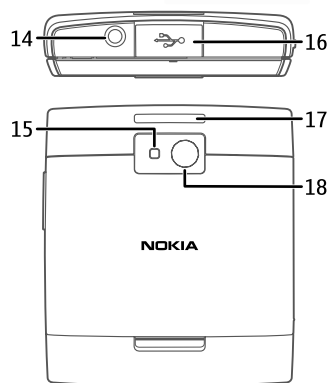

- 14 Nokia AV connector (3.5 mm)
- 15 Camera flash
- 16 Micro USB / Charger connector
- 17 Wrist strap hole
- 18 Camera lens

Note: The surface of this device does not contain nickel in the platings. The surface of this device contains stainless steel.

www.nokia.com/support

During extended operation such as high speed data connection and extensive WLAN usage, the device may feel warm. In most cases, this condition is normal. If you suspect the device is not working properly, take it to the nearest authorised service facility.

Insert SIM card and battery

Safe removal. Always switch the device off and disconnect the charger before removing the battery.

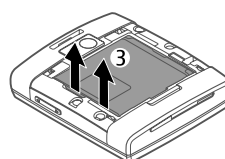

- 3 Remove the battery, if inserted.

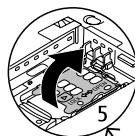

- 4 To unlock the SIM card holder, push it to the right.
5 Lift the SIM card holder up.

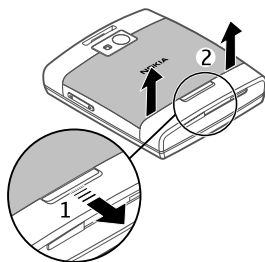

- 1 To release the back cover, pull and hold the release button.
2 While holding the release button, lift the back cover.

www.nokia.com/support

10 Get started

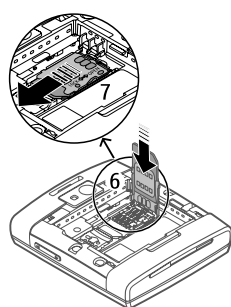

- 6 Slide the SIM card into the SIM card holder. Make sure the contact area of the card is facing down.
- 7 Push the holder down, and to lock it, push it to the left.

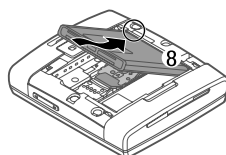

- 8 Line up the battery contacts with the battery compartment connectors, and insert the battery.
- 9 Replace the back cover.

Memory card

Use only compatible microSD cards approved by Nokia for use with this device. Nokia uses approved industry standards for memory cards, but some brands may not be fully compatible with this device. Incompatible cards may damage the card and the device and corrupt data stored on the card.

Insert a memory card

A memory card may already be inserted in the device. If not, do the following:

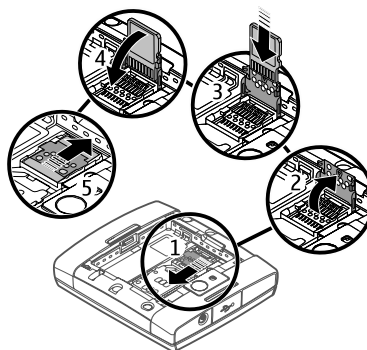

www.nokia.com/support

- 1 To release the memory card holder, push the holder to the direction indicated by the arrow on the holder.
- 2 Lift the memory card holder up.
- 3 Slide a compatible memory card into the memory card holder. Make sure the contact area of the card is facing down.
- 4 Push the memory card holder down.
- 5 To lock the memory card holder, push the holder to its original position.



Switch the device on and off

Remove the memory card

- 1 Switch the device off.
- 2 Remove the back cover and the battery.
- 3 Remove the memory card from the memory card holder.

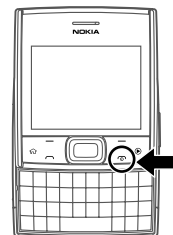

Antenna locations

Your device may have internal and external antennas. Avoid touching the antenna area unnecessarily while the antenna is transmitting or receiving. Contact with antennas affects the communication quality and may cause a higher power level during operation and may reduce the battery life.

Press and hold the power key to switch the device on and off. Briefly pressing this key ends an active call or closes an application.

If the device asks for a PIN code, enter the PIN code, and select **OK**.

www.nokia.com/support

12 Get started

If the device asks for the lock code, enter the lock code, and select **OK**. The factory setting for the lock code is 12345.

To set the correct time zone, time, and date, select the country you are presently in, then enter the local time and date.

Charge the battery

Your battery has been partially charged at the factory, but you may need to recharge it before you can switch on your device for the first time.

If the device indicates a low charge, do the following:

- 1 Connect the charger to a wall outlet.
- 2 Connect the charger to the device.

- 3 When the device indicates a full charge, disconnect the charger from the device, then from the wall outlet.

To avoid breaking the charger connector, be careful when connecting or disconnecting the charger cable.

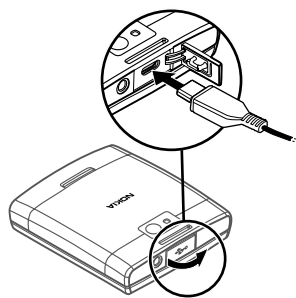

www.nokia.com/support

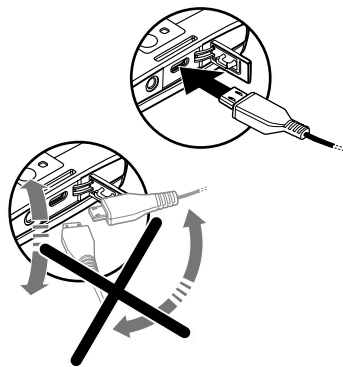

You do not need to charge the battery for a specific length of time, and you can use the device while it is charging. If the battery is completely discharged, it may take several minutes before the charging indicator appears on the display or before any calls can be made.

Charge over USB

- 1 Use a compatible USB cable to connect to a compatible device, such as a computer.
- 2 If your device is switched on, when prompted, select a USB mode.

If connected to a computer, you can synchronise your device while charging.

Charging over USB can take longer to start, and may not work if you connect through a non-powered USB hub. Your device charges more quickly when connected to a wall outlet.

Keypad lock (keyguard)

To unlock the keypad, open the slide, or select **Unlock**, then quickly select **OK**.

Select **Menu > Ctrl. panel > Settings and General**.

To set the device to lock the keypad when you close the slide, select **Slide handling > Keyguard activation**.

To set the device to automatically lock the keypad after a certain length of time, select **Security > Phone and SIM card > Keypad autolock period > User defined**, and select the desired time.

When the device or keypad is locked, calls may be possible to the official emergency number programmed into your device.

www.nokia.com/support

14 Get started

Volume control

To adjust the earpiece or loudspeaker volume during a call or when listening to an audio file, use the volume keys.

To activate or deactivate the loudspeaker during a call, select **Loudsp.** or **Handset**.

Warning:

Continuous exposure to high volume may damage your hearing. Listen to music at a moderate level, and do not hold the device near your ear when the loudspeaker is in use.

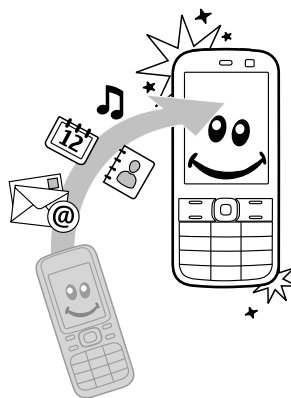

Copy content from your old device

You can use the Switch application to copy content such as phone numbers, addresses, calendar items, and images from your previous compatible Nokia device to your new device.

Copy content for the first time

- 1 To retrieve data from the other device for the first time, on your device, select **Menu > Ctrl. panel > Switch**.
- 2 Pair the two devices. To have your device search for devices with Bluetooth connectivity, select **Continue**. Select the device from which you want to transfer content. You are asked to enter a code on your device. Enter a code (1-16 digits), and select **OK**. Enter the

www.nokia.com/support

same code on the other device, and select **OK**. The devices are now paired.

If your old Nokia device does not have the Switch application, your new device sends it in a message. Open the message in the old device, and follow the instructions on the display.

- 3 On your device, select the content you want to transfer from the other device.

When the transfer has started, you can cancel it and continue later.

Content is transferred from the memory of the other device to the corresponding location in your device. The transfer time depends on the amount of data to be transferred.

The type of content that can be transferred depends on the model of the device from which you want to transfer content. If that device supports synchronisation, you can also synchronise data between the devices. Your device notifies you if the other device is not compatible.

Visit Ovi by Nokia

 With Ovi by Nokia, you can find new places and services, and stay in touch with your friends. You can do, for example, the following:

- Create a mail account
- Plan trips and view locations on a map
- Download games, applications, videos, and ringing tones to your device
- Purchase music

The available services may vary by country or region, and not all languages are supported.

To access Nokia's Ovi services, go to www.ovi.com, and register your own Nokia account.

For more information, go to www.ovi.com/support.

www.nokia.com/support

16 Your device

2. Your device

Home screen

About home screen

The home screen is your starting point where you can collect all your important contacts and application shortcuts.

When you have switched on the device, and it is registered to a network, the device is in the home screen view.

Use the scroll key to navigate in the home screen.

Depending on your home screen theme, your home screen may include the following:

- Contacts bar
- Application plug-ins
- Application shortcuts
- Notification area

To customise application plug-ins and shortcuts, or to change the home screen theme, select **Menu > Ctrl. panel > Settings and General > Personalisation > Standby mode** and the appropriate option. You may not be able to change all shortcuts.

Write text

The available input methods may vary.

Use the keyboard

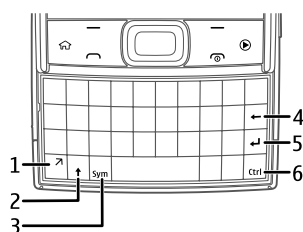

- 1 Function key
- 2 Shift key
- 3 Sym key
- 4 Backspace key
- 5 Enter key
- 6 Ctrl key

Switch between the different character cases

To change between the upper and lower case modes, press the shift key twice. To enter a single upper case letter in lower case mode, or vice versa, press the shift key once, and then the desired alphabet key.

www.nokia.com/support

Insert a number or special character printed at the top of a key

Press the function key, and then press the corresponding alphabet key, or press and hold the alphabet key only. To enter several special characters in a row, press the function key twice quickly, and then press the desired alphabet keys. To return to normal mode, press the function key once.

Insert a special character that is not on the keyboard

Press the sym key, and select  and a character.

Insert a letter that is not on the keyboard

It is possible to insert variations of letters, for example, letters with accents. For example, to insert á, press and hold the sym key, and simultaneously press the A key repeatedly, until the desired character is displayed. The order and availability of letters depends on the selected writing language.

Insert a smiley

Press the sym key, and select a smiley. Smileys are only available for text and multimedia messages.

Tip: To add a recently used special character, while pressing and holding the ctrl key, press the sym key, and from the pop-up menu, select the character.

Copy and paste text

- 1 Press and hold the shift key, and scroll to highlight the text you want to copy.
- 2 Press **ctrl + C**.
- 3 Go to the place where you want to paste the text, and press **ctrl + V**.

Change the writing language or activate predictive text input

Select **Options > Input options**.

Predictive text input

To activate predictive text input, select **Options > Input options > Activate prediction**. The indicator  is displayed.

18 Personalise your device

When you start writing a word, your device suggests possible words. When the correct word is found, scroll right to confirm it.

While writing, you can also scroll down to access a list of suggested words. If the desired word is on the list, select the word.

If the word you are writing is not in the dictionary of the device, the device suggests a possible word, while the word you were writing is shown above the suggested word. Scroll up to select your word. The word is added to the dictionary when you start writing the next word.

To deactivate predictive text input, select **Options** > **Input options** > **Deactivate prediction**.

To define the settings for text input, select **Options** > **Input options** > **Settings**.

To change the writing language, select **Options** > **Input options** > **Writing language**.

3. Personalise your device

Profiles

Select Menu > Ctrl. panel > Profiles.

You can adjust and customise the ringing tones, alert tones, and other device tones for different events, environments, or caller groups. The active profile is shown at the top of the display in the home screen. However, if the active profile is General, only today's date is shown.

To create a new profile, select **Options** > **Create new**, and define the settings.

To customise a profile, select a profile and **Options** > **Personalise**.

To activate a profile, select a profile and **Options** > **Activate**.

To set the profile to be active until a certain time within the next 24 hours, scroll to the profile, select **Options** > **Timed**, and set the time. When the time expires, the profile changes back to the previously active non-timed profile.

www.nokia.com/support

When the profile is timed,  is displayed in the home screen. The Offline profile cannot be timed.

To delete a profile that you created, select **Options > Delete profile**. You cannot delete the predefined profiles.

When the Offline profile is activated, your connection to the cellular network is closed. All radio frequency signals between the device and the cellular network are prevented. If you try to send a message, it is placed in the Outbox folder, and is sent only when another profile is activated.

You can also use your device without a SIM card. If you remove the SIM card, the Offline profile is activated.

Important: In the Offline profile you cannot make or receive any calls, or use other features that require cellular network coverage. Calls may still be possible to the official emergency number programmed into your device. To make calls, you must first activate the phone function by changing profiles. If the device has been locked, enter the lock code.

When you use the Offline profile, you can still use a wireless LAN (WLAN), for example, to read your mail or browse the internet. You can also use Bluetooth connectivity. Remember to comply with any applicable safety requirements when you establish and use WLAN or Bluetooth connections.

Select ringing tones

To set a ringing tone for a profile, select **Options > Personalise > Ringing tone**. Select a ringing tone from the list, or select **Download sounds** to open a bookmark folder containing a list of bookmarks for downloading tones using the browser. Any downloaded tones are saved to Gallery.

To play the ringing tone for a selected contact group only, select **Options > Personalise > Alert for**, and select the desired group. Phone calls coming from outside that group have a silent alert.

To change the message tone, select **Options > Personalise > Message alert tone**.

www.nokia.com/support

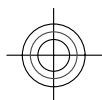

20 Make calls

Change the display theme

Select **Menu > Ctrl. panel > Themes**.

Select from the following:

General — Change the theme used in all applications.

Menu view — Change the theme used in the main menu.

Standby — Change the theme used in the home screen.

Wallpaper — Change the background image of the home screen.

Call image — Change the image displayed during calls.

Audio themes — Set sounds for various device events.

To activate or deactivate the theme effects, select **General > Options > Theme effects**.

4. Make calls

Make a call

To make a call, open the slide, enter the phone number, including the area code, and press the call key.

If you use a headset, you do not need to open the slide to make a call.

Tip: For international calls, add the + character that replaces the international access code, and enter the country code, area code (omit the leading 0, if necessary), and phone number.

To end the call or cancel the call attempt, close the slide. If you are using a headset, to end the call, press the end key.

To make a call using the saved contacts, open the contacts list. Enter the first letters of the name, scroll to the name, and press the call key.

To make a call using the log, press the call key to view up to 20 numbers that you last called or attempted to call. Scroll to the desired number or name, and press the call key.

To adjust the volume of an active call, use the volume keys.

To switch from a voice call to a video call, select **Options > Switch to video call**. The device ends the voice call and makes a video call to the recipient.

www.nokia.com/support

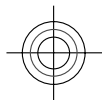
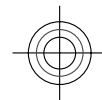
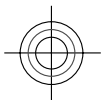

Answer or reject a call

Answer a call

Open the slide, or connect a headset and press the call key.

Mute the ringing tone of an incoming call

Select **Silence**.

Reject a call

Press the end key. If you activate the **Call divert > Voice calls > If busy** function in phone settings, rejecting an incoming call also diverts the call.

Send a reject call text message

Select **Silence** and **Send msg.**, edit the message text, and press the call key. With the reply message you can inform the caller that you cannot answer the call.

Activate the reject call text message feature

Select **Menu > Ctrl. panel > Settings and Phone > Call > Reject call with message > Yes**.

Write a standard reject call text message

Select **Menu > Ctrl. panel > Settings and Phone > Call > Message text**, and write the message.

Voice mail

Select **Menu > Ctrl. panel > Call mailbox**.

When you open the Call mailbox application (network service) for the first time, you are asked to enter the number of your voice mailbox.

To call your voice mailbox, go to the voice mailbox, open the slide, and select **Options > Call voice mailbox**.

To call your mailbox in the home screen, press and hold **1**, and select the mailbox to call.

To change the mailbox number, select the mailbox and **Options > Change number**.

22 Contacts

5. Contacts

Stay connected with your online friends

You can synchronise the contact information on your device with contacts you have on Facebook. When you allow synchronisation, you are able to view your contacts' Facebook profile information, such as their picture and status updates, in the Contacts application on your device.

Synchronising your contacts and retrieving status updates are network services. Roaming and data transfer charges may apply. If the social networking service is not available or functioning correctly, you may not be able to synchronise or retrieve status updates.

To start synchronising your contacts, go to the settings of the social networking application on your device, select an access point and set the frequency of the automatic synchronisation.

To deactivate the connection between Contacts and the social networking service, in the settings of the social

networking service application on your device, clear the Enable check box.

This feature may not be available in certain regions.

Save and edit names and numbers

Select Menu > Contacts.

Add a new contact to the contacts list

- 1 Select **Options** > **New contact**.
- 2 Fill in the appropriate fields, and select **Done**.

Edit a contact

Select a contact and **Options** > **View details** > **Options** > **Edit**.

6. Messaging

Write and send messages

Select Menu > Messaging.

Important: Exercise caution when opening messages. Messages may contain malicious software or otherwise be harmful to your device or PC.

Before you can create a multimedia message or write an e-mail, you must

www.nokia.com/support

have the correct connection settings in place.

The wireless network may limit the size of MMS messages. If the inserted picture exceeds this limit, the device may make it smaller so that it can be sent by MMS.

Check the size limit of e-mail messages with your service provider. If you attempt to send an e-mail message that exceeds the size limit of the e-mail server, the message is left in the Outbox folder, and the device attempts to resend it periodically. Sending an e-mail requires a data connection, and continuous attempts to resend the e-mail may increase your data transfer costs. In the Outbox folder, you can delete such a message, or move it to the Drafts folder.

- 1 Select **New message**.
- 2 To send a text or multimedia message (MMS), select **Message**. To send a multimedia message that includes one sound clip, select **Audio message**. To send an e-mail, select **E-mail**.
- 3 In the **To** field, press the scroll key to select recipients or groups from the contacts list, or enter the

recipient's phone number or e-mail address. You can also copy and paste the number or address from the clipboard.

- 4 In the subject field, enter the subject of the message. To hide or display fields when writing a text or multimedia message, select **Options > Message header fields**.
- 5 In the message field, write the message. To insert a template or note, select **Options > Insert content > Insert text > Template or Note**.
- 6 To add a media file to a multimedia message, select **Options > Insert content**, the file type or source, and the desired file. To insert a business card, slide, note, or other file to the message, select **Options > Insert content > Insert other**.
- 7 To capture an image or record a video or sound clip for a multimedia message, select **Options > Insert content > Insert image > New**, **Insert video clip > New**, or **Insert sound clip > New**.

www.nokia.com/support

24 Messaging

- 8 To insert a smiley to a text or multimedia message, press the sym key, and select the smiley.
- 9 To add an attachment to an e-mail, select **Options > Add attachment**, the memory, and the file to attach.  indicates an e-mail attachment.
- 10 To send the message, select **Options > Send**, or press the call key.

The available options may vary.

Note: The message sent icon or text on your device screen does not indicate that the message is received at the intended destination.

Your device supports text messages beyond the limit for a single message. Longer messages are sent as two or more messages. Your service provider may charge accordingly. Characters with accents, other marks, or some language options take more space, and limit the number of characters that can be sent in a single message.

You may not be able to send video clips that are saved in the MP4 file format or

that exceed the size limit of the wireless network in a multimedia message.

Check the number of unread messages

Shake your device to check how many unread text and multimedia messages you have.

- 1 Make sure the keypad is locked.
- 2 Press and hold one of the volume keys, and shake the device. The number of tones indicates the number of unread messages.

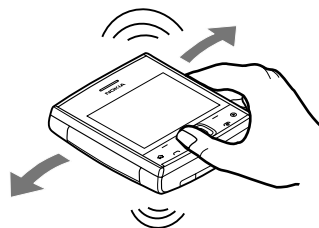

The number of tones is limited. If you have many unread messages, fewer tones may be played than there are messages.

www.nokia.com/support

Set up your e-mail

With the E-mail wizard, you can set up your corporate e-mail account, such as Mail for Exchange, and your internet e-mail account.

When setting up your corporate e-mail, you may be prompted for the name of the server associated with your e-mail address. Contact your company IT department for details before you start setting up your corporate e-mail account.

When setting up your internet e-mail, you may need to contact your e-mail service provider to obtain your e-mail account type (POP or IMAP).

- 1 To start the wizard, go to the home screen, and select the E-mail wizard.
- 2 Enter your e-mail address and password. If the wizard is not able to configure your e-mail settings automatically, you need to select your e-mail account type and enter the related account settings.

If your device contains any additional e-mail clients, those are offered to you when you start the E-mail wizard.

About Chat

With Chat (network service), you can exchange instant messages with your friends. You can access several chat services or communities simultaneously and switch between them. If you want to, for example, browse the web, you can leave the Chat application to run in the background, and still be notified of new instant messages.

The Chat application is preinstalled on your device. To start chatting, select **Menu > Chat**.

Using network services and downloading content to your device may result in data traffic costs.

Ovi Contacts

About Ovi Contacts

With Ovi Contacts, you can stay connected to your friends and family, follow what they are up to, and discover new friends in the Ovi community. You can also back up contacts from your device to Ovi.

To use Ovi Contacts, go to www.ovi.com.

www.nokia.com/support

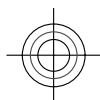

26 Messaging

Start using Ovi Contacts

Select **Contacts**, and open the Ovi tab.

The Ovi Contacts service is part of Ovi, and uses the same account information.

If you are new to Ovi and its services, to start using the Ovi Contacts application, you must register to Ovi by creating a Nokia account.

Create a Nokia account

- 1 Select **Ovi Chat**, and when prompted, connect to the internet.
- 2 Enter the required information.
- 3 In the My profile view, enter your profile information. Your first and last name are mandatory details.
- 4 Select **Done**.

If you have already registered to Ovi using your PC or mobile device, you can start using Ovi Contacts with the same account details.

Sign in to Ovi Contacts and activate the service

Select **Ovi Chat**, and enter your user name and password. When you have activated the Ovi Contacts service on

your device, you can connect to the service directly from the home screen.

If you have not yet provided your profile information for Ovi Contacts, do so, and select **Done**. Your first and last name are mandatory details.

Connect to the service

Select **Menu** > **Contacts**, and open the Ovi tab.

Connect to Ovi Contacts

Select **Go online** and the connection method. Use a wireless LAN (WLAN) connection where available.

Cancel the connection

Select **Options** > **Cancel connecting**.

A packet data connection may generate additional data transmission charges. For pricing details, contact your network service provider.

Select **Go online** > **Options** and from the following:

Select — Select the item.

Go online — Connect to the service if you are offline.

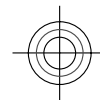
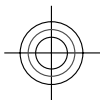

www.nokia.com/support

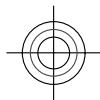

My profile — Edit your profile information.

Recommend to friend — Invite a contact to join Ovi Contacts. The invitation is sent as a text message.

Settings — Modify the Ovi Contacts settings.

The available options may vary.

7. Music and audio

Music key

With the music key, the songs stored on your device are quickly at hand. You can always access Music player with a single key press.

Go to the Now playing view

Press the music key. If no song is currently playing, the last played song is displayed.

Access the Music menu

Press and hold the music key.

Music player

Play a song or podcast

Select Menu > Music > Music player.

Start playing

- 1 Select the songs or podcasts you want to play.
- 2 To play the selected items, press the scroll key.

Pause, resume, or stop playback

To pause playback, press the scroll key; to resume, press the scroll key again. To stop playback, scroll down.

Fast-forward or rewind a song

Press and hold the scroll key to the right or left.

Play songs in random order

Select Options > Shuffle play.

Repeat the current item or all items

Select Options > Repeat.

If you play podcasts, shuffle and repeat are automatically deactivated.

Modify the tone of the music playback

Select Options > Equaliser.

28 Music and audio

Modify the balance and stereo image, or enhance the bass

Select **Options** > **Settings**.

Return to the home screen, and leave the player playing in the background

Press the end key.

Close Music player

Select **Options** > **Exit**.



Spin your device to play a random song

Let your device surprise you with music! While listening to music, to play a random song from your music library, set your device on a table, and spin it.

- 1 Open Music player, and start listening to music.
- 2 To change the song, place your device on its back on an even surface, and spin it with your finger. When the device stops spinning, a random song starts playing.

Transfer music from a computer

You can use the following methods to transfer music:

- To install Nokia Ovi Player to manage and organise your music files, download the PC software from www.ovi.com, and follow the instructions.
- To view your device on a computer as a mass memory device where you can transfer any data files, make the connection with a compatible USB data cable or Bluetooth connectivity. If you are using a USB data cable, select **Mass storage** as the USB connection mode.

www.nokia.com/support

- To synchronise music with Windows Media Player, connect a compatible USB data cable, and select **PC Suite** as the USB connection mode.

To change the default USB connection mode, select **Menu > Ctrl. panel > Connectivity > USB** and **USB connection mode**.

Nokia Ovi Player

With Nokia Ovi Player, you can download music from Ovi Music, transfer music to your device from your computer, and manage and organise your music files.

To download Nokia Ovi Player, go to www.ovi.com.

You need an internet connection to download music.

Download, transfer, and manage music between your computer and mobile device

- 1 Open Nokia Ovi Player on your computer. If you want to download music, register or sign in.

- 2 Use a compatible USB data cable to connect your device to the computer.
- 3 Select **PC Suite** as the USB connection mode.

Ovi Music

With Ovi Music (network service), you can search, browse, purchase, and download music to your device.

The Ovi Music service will eventually replace the Music store.

Select **Menu > Music > Ovi Music**.

To download music, you first need to register for the service.

Downloading music may involve additional costs and the transmission of large amounts of data (network service). For information about data transmission charges, contact your network service provider.

To access Ovi Music, you must have a valid internet access point in the device. You may be asked to select the access point to use when connecting to Ovi Music.

www.nokia.com/support

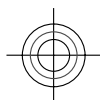

30 Images and videos

Select the access point

Select **Default access point**.

The availability and appearance of Ovi Music settings may vary. The settings may also be predefined and you may not be able to modify them. When browsing Ovi Music, you may be able to modify the settings.

Modify Ovi Music settings

Select **Options > Settings**.

Ovi Music is not available for all countries or regions.

8. Images and videos

Camera

Capture an image

Select **Menu > Applications > Camera**.

When capturing an image, note the following:

- Use both hands to keep the camera steady.

- The quality of a digitally zoomed image is lower than that of a non-zoomed image.
 - The camera goes into battery saving mode after about a minute of inactivity.
 - Keep a safe distance when using the flash. Do not use the flash on people or animals at close range. Do not cover the flash while taking a picture.
- 1 To switch from video mode to image mode, if necessary, select .
 - 2 Press the scroll key. Do not move the device before the image is saved and the final image displayed.

Zoom in or out when capturing an image

Use the zoom keys.

Images are automatically saved in Gallery.

Share online

About Share online

Select **Menu > Internet > Share online**.

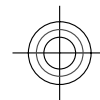
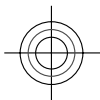

www.nokia.com/support

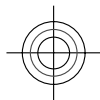

With Share online (network service), you can post your images, video clips, and sound clips from your device to compatible online sharing services, such as albums and blogs. You can also view and send comments to the posts in these services, and download content to your compatible Nokia device.

The supported content types and the availability of the Share online service may vary.

9. Connectivity

Wireless LAN About WLAN

Your device can detect and connect to wireless local area networks (WLAN). Using a WLAN, you can connect your device to the internet and compatible devices that support WLAN.

To use a WLAN connection, you need the following:

- WLAN must be available in your location.
- Your device must be connected to the WLAN. Some WLANs are protected, and you need an access

key from the service provider to connect to them.

- An internet access point created for WLAN. Use the access point for applications that need to connect to the internet.

A WLAN connection is established when you create a data connection using a WLAN internet access point. The active WLAN connection ends when you end the data connection.

You can use WLAN during a voice call or when packet data is active. You can only be connected to one WLAN access point device at a time, but several applications can use the same access point.

Features that use WLAN, or that are allowed to run in the background while using other features, increase the demand on battery power and reduce the battery life.

Your device supports the following WLAN features:

- IEEE 802.11b/g standard
- Operation at 2.4 GHz

www.nokia.com/support

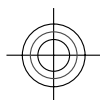

32 Connectivity

- Wired equivalent privacy (WEP), Wi-Fi protected access (WPA/WPA2), and 802.1x authentication methods. These functions can be used only if they are supported by the network.

Important: Always enable one of the available encryption methods to increase the security of your wireless LAN connection. Using encryption reduces the risk of unauthorised access to your data.

When the device is in the offline profile, you can still use WLAN, if available. Remember to comply with any applicable safety requirements when establishing and using a WLAN connection.

Tip: To check the unique media access control (MAC) address that identifies your device, enter ***#62209526#** in the home screen.

Note: Using WLAN may be restricted in some countries. For example, in France, you are only allowed to use WLAN indoors. For more information, contact your local authorities.

See WLAN availability

To set your device to show wireless LAN (WLAN) availability, select **Menu > Ctrl. panel > Settings and Connection > Wireless LAN > Show WLAN availability**.

If a WLAN is available,  is displayed.

WLAN wizard

Select **Menu > Ctrl. panel > Connectivity > WLAN wiz..**

The WLAN wizard helps you find and connect to a wireless LAN (WLAN). When you open the application, your device starts to scan for available WLANs and lists them.

Select **Options** and from the following:

Refresh — Update the list of available WLANs.

Filter WLAN networks — Filter out WLANs in the list of found networks. The selected networks are filtered out the next time the application searches for WLANs.

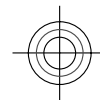
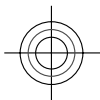

www.nokia.com/support

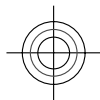

Start web browsing — Start browsing the web using the access point of the WLAN.

Cont.web browsing — Continue web browsing using the currently active WLAN connection.

Disconnect WLAN — Disconnect the active connection to the WLAN.

Details — View the details of the WLAN.

Important: Always enable one of the available encryption methods to increase the security of your wireless LAN connection. Using encryption reduces the risk of unauthorised access to your data.

Use the WLAN wizard in the home screen

To view the available options, select the row showing the status. Depending on the status, you can start the web browser using a WLAN connection, connect to your net call service, disconnect from a WLAN, search for WLANs, or enable or disable network scanning.

To enable WLAN scanning, and to search for available WLANs, select the row showing the status.

To start a search for available WLANs, select the row showing the status and **Search for WLAN**.

To disable WLAN scanning, select the row showing the status and **Switch WLAN scan off**.

When **Start web browsing** or **Use for** is selected, the WLAN wizard automatically creates an access point for the selected WLAN. The access point can also be used with other applications requiring WLAN connection.

If you select a secured WLAN, you are asked to enter the relevant passcodes. To connect to a hidden network, you must enter the correct service set identifier (SSID).

To use the found WLAN for a net call connection, select the row showing the status, **Use for**, the desired net call service, and the WLAN to be used.

34 Connectivity

Bluetooth

Select Menu > Ctrl. panel > Connectivity > Bluetooth.

About Bluetooth

Bluetooth technology in your device enables wireless connections between electronic devices within a range of 10 metres (33 feet). A Bluetooth connection can be used to send images, videos, text, business cards, calendar notes, or to connect wirelessly to devices that use Bluetooth technology.

Since devices using Bluetooth technology communicate using radio waves, your device and the other devices do not need to be in direct line-of-sight. The two devices only need to be within a maximum of 10 metres of each other, although the connection can be subject to interference from obstructions such as walls or other electronic devices.

Several Bluetooth connections can be active at a time. For example, if your device is connected to a headset, you can also transfer files to another compatible device at the same time.

This device is compliant with Bluetooth Specification 2.0 + EDR supporting the following profiles: Advanced Audio Distribution, Audio/Video Remote Control, Basic Imaging, Device Identification, Dial-Up Networking, File Transfer, Generic Access, Generic Audio/Video Distribution, Generic Object Exchange, Hands-free, Headset, Object Push, Phonebook Access, Serial Port, and Remote SIM Access. To ensure interoperability between other devices supporting Bluetooth technology, use Nokia approved accessories for this model. Check with the manufacturers of other devices to determine their compatibility with this device.

Features using Bluetooth technology increase the demand on battery power and reduce the battery life.

Send and receive data with Bluetooth

Select Menu > Ctrl. panel > Connectivity > Bluetooth.

- 1 When you activate Bluetooth connectivity for the first time, you are asked to name your device. Give your device a unique name to make

www.nokia.com/support

it easy to recognise if there are several Bluetooth devices nearby.

- 2 Select **Bluetooth > On**.
- 3 Select **My phone's visibility > Shown to all** or **Define period**. If you select **Define period**, you need to define the time during which your device is visible to others. Your device and the name you entered can now be seen by other users with devices using Bluetooth technology.
- 4 Open the application where the item you want to send is stored.
- 5 Select the item and **Options > Send > Via Bluetooth**. The device searches for other devices using Bluetooth technology within range and lists them.
Tip: If you have sent data using Bluetooth connectivity before, a list of the previous search results is displayed. To search for more Bluetooth devices, select **More devices**.
- 6 Select the device with which you want to connect. If the other device requires pairing before data can be transmitted, you are asked to enter a passcode.

When the connection has been established, **Sending data** is displayed.

The Sent folder in the Messaging application does not store messages sent using Bluetooth connectivity.

To receive data using Bluetooth connectivity, select **Bluetooth > On** and **My phone's visibility > Shown to all** to receive data from a non-paired device or **Hidden** to receive data from a paired device only. When you receive data through Bluetooth connectivity, depending on the settings of an active profile, a tone sounds, and you are asked if you want to accept the message in which the data is included. If you accept, the message is placed in the Inbox folder in the Messaging application.

Tip: You can access the files in the device or on the memory card using a compatible accessory that supports the File Transfer Profile Client service (for example, a laptop computer).

A Bluetooth connection is disconnected automatically after sending or receiving data. Only Nokia Ovi Suite and some accessories such as headsets may

www.nokia.com/support

36 Connectivity

maintain a connection even if not actively used.

Pair devices

Select **Menu > Ctrl. panel > Connectivity > Bluetooth.**

Open the paired devices tab.

Before pairing, decide on your own passcode (1-16 digits), and agree with the user of the other device to use the same code. Devices that do not have a user interface have a fixed passcode. You need the passcode only when you connect the devices for the first time. After pairing, it is possible to authorise the connection. Pairing and authorising the connection makes connecting quicker and easier, as you do not have to accept the connection between paired devices every time you establish a connection.

The passcode for remote SIM access must have 16 digits.

In remote SIM mode you can use your device's SIM card with compatible accessories.

When the wireless device is in the remote SIM mode, you can only use a compatible connected accessory, such as a car kit, to make or receive calls.

Your wireless device will not make any calls, except to the emergency numbers programmed into your device, while in this mode.

To make calls, you must first leave the remote SIM mode. If the device has been locked, enter the lock code to unlock it first.

- 1 Select **Options > New paired device.** The device starts to search for Bluetooth devices within range. If you have sent data using Bluetooth connectivity before, a list of the previous search results is displayed. To search for more Bluetooth devices, select **More devices.**
- 2 Select the device with which you want to pair, and enter the passcode. The same passcode must be entered in the other device as well.
- 3 To make the connection between your device and the other device automatic, select **Yes.** To confirm

www.nokia.com/support

the connection manually every time a connection attempt is made, select **No**. After pairing, the device is saved to the paired devices page.

To give a nickname to the paired device, select **Options > Assign short name**. The nickname is displayed in your device.

To delete a pairing, select the device whose pairing you want to delete and **Options > Delete**. To delete all pairings, select **Options > Delete all**. If you are currently connected to a device and cancel the pairing with that device, pairing is removed immediately, and the connection is ended.

To allow a paired device to connect automatically to your device, select **Set as authorised**. Connections between your device and the other device can be made without your knowledge. No separate acceptance or authorisation is needed. Use this status only for your own devices, such as your compatible headset or computer, or devices that belong to someone you trust. If you want to accept connection requests

from the other device separately every time, select **Set as unauthorised**.

To use a Bluetooth audio accessory, such as a Bluetooth handsfree or headset, you need to pair your device with the accessory. For the passcode and further instructions, see the accessory user guide. To connect to the audio accessory, switch on the accessory. Some audio accessories connect automatically to your device. Otherwise, open the paired devices tab, and select the accessory and **Options > Connect to audio device**.

10. Find help

Support

When you want to learn more about how to use your product or you are unsure how your device should function, go to www.nokia.com/support, or using a mobile device, nokia.mobi/support. You can also select **Menu > Applications > Help > Help** in your device.

If this does not resolve your issue, do one of the following:

www.nokia.com/support

38 Find help

- Switch off the device, and remove the battery. After about a minute, replace the battery, and switch on the device.
- Restore the original factory settings.
- Update your device software.

If your issue remains unsolved, contact Nokia for repair options. Go to www.nokia.com/repair. Before sending your device for repair, always back up the data in your device.

Keep your device software up to date About software updates

Software updates may include new features and enhanced functions that were not available at the time of purchase of your device. Updating the software may also improve the device performance.

To get a notification when new software is available for your device, register with My Nokia, and subscribe to notifications for text or e-mail messages. For more information, go to www.nokia.com/mynokia.

Warning:

If you install a software update, you cannot use the device, even to make emergency calls, until the installation is completed and the device is restarted. Be sure to back up data before accepting installation of an update.

Downloading software updates may involve the transmission of large amounts of data (network service).

Make sure that the device battery has enough power, or connect the charger before starting the update.

After updating your device software or applications, the instructions related to the updated applications in the user guide or helps may no longer be up to date.

Software updates over the air

Select Menu > Ctrl. panel > Data mgr. > SW update.

With Software update (network service), you can check if there are updates available for your device software or applications, and download them to your device.

www.nokia.com/support

Downloading software updates may involve the transmission of large amounts of data (network service).

Make sure that the device battery has enough power, or connect the charger before starting the update.

Warning:

If you install a software update, you cannot use the device, even to make emergency calls, until the installation is completed and the device is restarted. Be sure to back up data before accepting installation of an update.

After updating your device software or applications using Software update, the instructions related to the updated applications in the user guide or the helps may no longer be up to date.

Select **Options** and from the following:

Start update — Download the available updates. To unmark specific updates that you do not want to download, select the updates from the list.

Update via PC — Update your device using a PC. This option replaces the Start

update option when updates are only available using the Nokia Software Updater PC application.

View details — View information on an update.

View update history — View the status of previous updates.

Settings — Change the settings, such as the default access point used for downloading updates.

Disclaimer — View the Nokia licence agreement.

Update software using your PC

Nokia Software Updater is a PC application that enables you to update your device software. To update your device software, you need a compatible PC, broadband internet access, and a compatible USB data cable to connect your device to the PC.

To get more information and to download the Nokia Software Updater application, go to www.nokia.com/softwareupdate.

www.nokia.com/support

40 Find help

In-device help

Your device contains instructions to help to use the applications in your device.

To open help texts from the main menu, select **Menu > Applications > Help > Help** and the application for which you want to read instructions.



When an application is open, to access the help text for the current view, select **Options > Help**.

When you are reading the instructions, to change the size of the help text, select **Options > Decrease font size** or **Increase font size**.

You may find links to related topics at the end of the help text.

If you select an underlined word, a short explanation is displayed.

Help texts use the following indicators:

-  Link to a related help topic.
-  Link to the application being discussed.

When you are reading the instructions, to switch between help texts and the application that is open in the background, select **Options > Show open apps**, and the desired application.

Extended user guide

For more information on applications or functions in your device, see the extended version of this user guide, which is available on the product support pages of the Nokia website.

Access codes

If you forget any of the access codes, contact your service provider.

Personal identification number (PIN) code — This code protects your SIM card against unauthorised use. The PIN code (4 - 8 digits) is usually supplied with the SIM card. After three consecutive incorrect PIN code entries, the code is blocked, and you need the PUK code to unblock it.

UPIN code — This code may be supplied with the USIM card. The USIM card is an enhanced version of the SIM card and is supported by 3G mobile phones.

www.nokia.com/support

PIN2 code — This code (4 - 8 digits) is supplied with some SIM cards, and is required to access some functions in your device.

Lock code (also known as security code) — The lock code helps you to protect your device against unauthorised use. The preset code is 12345. You can create and change the code, and set the device to request the code. Keep the new code secret and in a safe place separate from your device. If you forget the code and your device is locked, your device will require service. Additional charges may apply, and all the personal data in your device may be deleted. For more information, contact a Nokia Care Point or your device dealer.

Personal Unlocking Key (PUK) code and PUK2 code — These codes (8 digits) are required to change a blocked PIN code or PIN2 code, respectively. If the codes are not supplied with the SIM card, contact the network service provider whose SIM card is in your device.

UPUK code — This code (8 digits) is required to change a blocked UPIN code. If the code is not supplied with the USIM card, contact the network service provider whose USIM card is in your device.

International Mobile Equipment Identity (IMEI) number — This number (15 or 17 digits) is used to identify valid devices on the GSM network. Devices that are, for example, stolen, can be blocked from accessing the network. The IMEI number for your device can be found under the battery.

11. Green tips



Save energy

You do not need to charge your battery so often if you do the following (if available for your device):

- Close applications and data connections, for example, your Bluetooth connection, when not in use.
- Decrease the brightness of the screen.
- Set your device to enter power saver mode after the minimum period of inactivity, if available in your device.

www.nokia.com/support

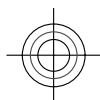

42 Product and safety information

- Deactivate unnecessary sounds, such as key tones.

Recycle

All materials of this device can be recovered as materials and energy. For information on how to recycle your old Nokia products, go to www.nokia.com/wecycle, or using a mobile device, nokia.mobi/wecycle.

Recycle packaging and user guides at your local recycling scheme.

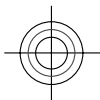

The crossed-out wheeled-bin symbol on your product, battery, literature, or packaging reminds you that all electrical and electronic products, batteries, and accumulators must be taken to separate collection at the end of their working life. This requirement applies in the European Union. Do not dispose of these products as unsorted municipal waste. For more information on the environmental attributes of your device, see www.nokia.com/ecodeclaration.

Product and safety information

Accessories

Warning:

Use only batteries, chargers, and accessories approved by Nokia for use with this particular model. The use of any other types may invalidate any approval or warranty, and may be dangerous. In particular, use of unapproved chargers or batteries may present a risk of fire, explosion, leakage, or other hazard.

For availability of approved accessories, please check with your dealer. When you disconnect the power cord of any accessory, grasp and pull the plug, not the cord.

Battery

Battery and charger information

Your device is powered by a rechargeable battery. The battery intended for use with this device is BL-5F. Nokia may make additional battery models available for this device. This device is intended for use when supplied with power from the following chargers: AC-6. The exact charger model number may vary depending on the type of plug. The plug variant is identified by one of the following: E, EB, X, AR, U, A, C, K, or UB.

The battery can be charged and discharged hundreds of times, but it will eventually wear out. When the talk and standby times are noticeably shorter than normal, replace the battery. Use only Nokia approved batteries, and recharge your battery only with Nokia approved chargers designated for this device.

If a battery is being used for the first time or if the battery has not been used for a prolonged period, it may be necessary to connect the charger, then disconnect and reconnect it to begin charging the battery. If the battery

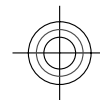

www.nokia.com/support

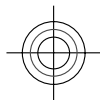

is completely discharged, it may take several minutes before the charging indicator appears on the display or before any calls can be made.

Safe removal. Always switch the device off and disconnect the charger before removing the battery.

Proper charging. Unplug the charger from the electrical plug and the device when not in use. Do not leave a fully charged battery connected to a charger, since overcharging may shorten its lifetime. If left unused, a fully charged battery will lose its charge over time.

Avoid extreme temperatures. Always try to keep the battery between 15°C and 25°C (59°F and 77°F). Extreme temperatures reduce the capacity and lifetime of the battery. A device with a hot or cold battery may not work temporarily. Battery performance is particularly limited in temperatures well below freezing.

Do not short-circuit. Accidental short-circuiting can occur when a metallic object such as a coin, clip, or pen causes direct connection of the positive (+) and negative (-) terminals of the battery. (These look like metal strips on the battery.) This might happen, for example, when you carry a spare battery in your pocket or purse. Short-circuiting the terminals may damage the battery or the connecting object.

Disposal. Do not dispose of batteries in a fire as they may explode. Dispose of batteries according to local regulations. Please recycle when possible. Do not dispose as household waste.

Leak. Do not dismantle, cut, open, crush, bend, puncture, or shred cells or batteries. In the event of a battery leak, prevent battery liquid contact with skin or eyes. If this happens, flush the affected areas immediately with water, or seek medical help.

Damage. Do not modify, remanufacture, attempt to insert foreign objects into the battery, or immerse or expose it to water or other liquids. Batteries may explode if damaged.

Correct use. Use the battery only for its intended purpose. Improper battery use may result in a fire, explosion, or other hazard. If the device or battery is dropped, especially on a hard surface, and you believe the battery has been damaged, take it to a service centre for inspection before continuing to use it. Never use any charger or battery that is damaged. Keep your battery out of the reach of small children.

Nokia battery authentication guidelines

Always use original Nokia batteries for your safety. To check that you are getting an original Nokia battery, purchase it from a Nokia authorised service centre or dealer, and inspect the hologram label using the following steps:

Authenticate hologram

- 1 When you look at the hologram on the label, you should see the Nokia connecting hands symbol from one angle and the Nokia Original Enhancements logo when looking from another angle.

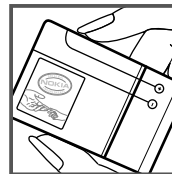

44 Product and safety information

- 2 When you angle the hologram left, right, down and up, you should see 1, 2, 3 and 4 dots on each side respectively.

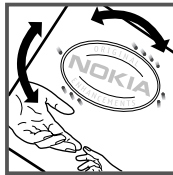

Successful completion of the steps is not a total assurance of the authenticity of the battery. If you cannot confirm authenticity or if you have any reason to believe that your Nokia battery with the hologram on the label is not an authentic Nokia battery, you should refrain from using it, and take it to the nearest Nokia authorised service centre or dealer for assistance.

To find out more about original Nokia batteries, see www.nokia.com/battery.

Taking care of your device

Your device is a product of superior design and craftsmanship and should be treated with care. The following suggestions will help you protect your warranty coverage.

- Keep the device dry. Precipitation, humidity, and all types of liquids or moisture can contain minerals that will corrode electronic circuits. If your device does get wet, remove the battery, and allow the device to dry completely before replacing it.

- Do not use or store the device in dusty, dirty areas. Its moving parts and electronic components can be damaged.
- Do not store the device in high or cold temperature. High temperatures can shorten the life of electronic devices, damage batteries, and warp or melt certain plastics. When the device warms to its normal temperature from a cold temperature, moisture can form inside the device and damage electronic circuit boards.
- Do not attempt to open the device other than as instructed in this guide.
- Do not drop, knock, or shake the device. Rough handling can break internal circuit boards and fine mechanics.
- Do not use harsh chemicals, cleaning solvents, or strong detergents to clean the device. Only use a soft, clean, dry cloth to clean the surface of the device.
- Do not paint the device. Paint can clog the moving parts and prevent proper operation.
- Use only the supplied or an approved replacement antenna. Unauthorised antennas, modifications, or attachments could damage the device and may violate regulations governing radio devices.
- Use chargers indoors.
- Backup all data you want to keep, such as contacts and calendar notes.
- To reset the device from time to time for optimum performance, power off the device and remove the battery.

These suggestions apply equally to your device, battery, charger, or any accessory.

www.nokia.com/support

Recycle

Always return your used electronic products, batteries, and packaging materials to dedicated collection points. This way you help prevent uncontrolled waste disposal and promote the recycling of materials. Check product environmental information and how to recycle your Nokia products at www.nokia.com/werecycle, or <http://nokia.mobi/werecycle>.

Additional safety information

The surface of this device is nickel-free.

Small children

Your device and its accessories are not toys. They may contain small parts. Keep them out of the reach of small children.

Operating environment

This device meets RF exposure guidelines in the normal use position at the ear or at least 1.5 centimetres (5/8 inch) away from the body. Any carry case, belt clip, or holder for body-worn operation should not contain metal and should position the device the above-stated distance from your body.

To send data files or messages requires a quality connection to the network. Data files or messages may be delayed until such a connection is available. Follow the separation distance instructions until the transmission is completed.

Medical devices

Operation of radio transmitting equipment, including wireless phones, may interfere with the function of inadequately protected medical devices. Consult a physician or the manufacturer of the medical device to determine whether they are adequately shielded from external RF energy. Switch off your device when regulations posted instruct you to do so. Hospitals or

health care facilities may use equipment sensitive to external RF energy.

Implanted medical devices

Manufacturers of medical devices recommend a minimum separation of 15.3 centimetres (6 inches) between a wireless device and an implanted medical device, such as a pacemaker or implanted cardioverter defibrillator, to avoid potential interference with the medical device. Persons who have such devices should:

- Always keep the wireless device more than 15.3 centimetres (6 inches) from the medical device.
- Not carry the wireless device in a breast pocket.
- Hold the wireless device to the ear opposite the medical device.
- Turn the wireless device off if there is any reason to suspect that interference is taking place.
- Follow the manufacturer directions for the implanted medical device.

If you have any questions about using your wireless device with an implanted medical device, consult your health care provider.

Hearing aids

Some digital wireless devices may interfere with some hearing aids.

Vehicles

RF signals may affect improperly installed or inadequately shielded electronic systems in motor vehicles such as electronic fuel injection, electronic antilock braking, electronic speed control, and air bag systems. For more information, check with the manufacturer of your vehicle or its equipment.

www.nokia.com/support

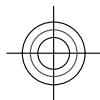

46 Product and safety information

Only qualified personnel should service the device or install the device in a vehicle. Faulty installation or service may be dangerous and may invalidate your warranty. Check regularly that all wireless device equipment in your vehicle is mounted and operating properly. Do not store or carry flammable liquids, gases, or explosive materials in the same compartment as the device, its parts, or accessories. Remember that air bags inflate with great force. Do not place your device or accessories in the air bag deployment area.

Switch off your device before boarding an aircraft. The use of wireless teledevices in an aircraft may be dangerous to the operation of the aircraft and may be illegal.

Potentially explosive environments

Switch off your device in any area with a potentially explosive atmosphere. Obey all posted instructions. Sparks in such areas could cause an explosion or fire resulting in bodily injury or death. Switch off the device at refuelling points such as near gas pumps at service stations. Observe restrictions in fuel depots, storage, and distribution areas; chemical plants; or where blasting operations are in progress. Areas with a potentially explosive atmosphere are often, but not always, clearly marked. They include areas where you would be advised to turn off your vehicle engine, below deck on boats, chemical transfer or storage facilities and where the air contains chemicals or particles such as grain, dust, or metal powders. You should check with the manufacturers of vehicles using liquefied petroleum gas (such as propane or butane) to determine if this device can be safely used in their vicinity.

Emergency calls

Important: This device operates using radio signals, wireless networks, landline networks, and user-programmed functions. If your device supports voice calls over the internet (internet calls), activate both the internet calls and the cellular phone. The device may attempt to make emergency calls over both the cellular networks and

through your internet call provider if both are activated. Connections in all conditions cannot be guaranteed. You should never rely solely on any wireless device for essential communications like medical emergencies.

Make an emergency call

- 1 Ensure the device is switched on.
- 2 Check for adequate signal strength. You may also need to do the following:
 - Insert a SIM card.
 - Remove call restrictions you have activated for your device, such as call barring, fixed dialling, or closed user group.
 - Ensure your device is not in an offline or flight profile.
- 3 To clear the display, press the end key as many times as needed.
- 4 Enter the official emergency number for your present location. Emergency call numbers vary by location.
- 5 Open the slide, and press the call key.

When making an emergency call, give all the necessary information as accurately as possible. Your wireless device may be the only means of communication at the scene of an accident. Keep the slide open and do not end the call until given permission to do so.

Certification information (SAR)

This mobile device meets guidelines for exposure to radio waves.

Your mobile device is a radio transmitter and receiver. It is designed not to exceed the limits for exposure to radio waves recommended by international guidelines. These guidelines were developed by the independent scientific organisation ICNIRP and include safety margins designed

www.nokia.com/support

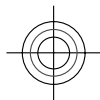
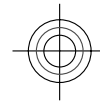
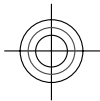

to assure the protection of all persons, regardless of age and health.

The exposure guidelines for mobile devices employ a unit of measurement known as the Specific Absorption Rate or SAR. The SAR limit stated in the ICNIRP guidelines is 2.0 watts/kilogram (W/kg) averaged over 10 grams of tissue. Tests for SAR are conducted using standard operating positions with the device transmitting at its highest certified power level in all tested frequency bands. The actual SAR level of an operating device can be below the maximum value because the device is designed to use only the power required to reach the network. That amount changes depending on a number of factors such as how close you are to a network base station.

The highest SAR value under the ICNIRP guidelines for use of the device at the ear is 0.64 W/kg.

Use of device accessories may result in different SAR values. SAR values may vary depending on national reporting and testing requirements and the network band. Additional SAR information may be provided under product information at www.nokia.com.

Your mobile device is also designed to meet the requirements for exposure to radio waves established by the Federal Communications Commission (USA) and Industry Canada. These requirements set a SAR limit of 1.6 W/kg averaged over one gram of tissue. The highest SAR value reported under this standard during product certification for use at the ear is 0.92 W/kg and when properly worn on the body is 0.85 W/kg.

www.nokia.com/support

© 2010 Nokia. All rights reserved.

DECLARATION OF CONFORMITY

CE0434 

Hereby, NOKIA CORPORATION declares that this RM-627 product is in compliance with the essential requirements and other relevant provisions of Directive 1999/5/EC. A copy of the Declaration of Conformity can be found at www.nokia.com/phones/declaration_of_conformity/.

Nokia, Nokia Connecting People, N-Gage, Navi, Ovi, Visual Radio, and Nokia Original Enhancements logo are trademarks or registered trademarks of Nokia Corporation. Nokia tune is a sound mark of Nokia Corporation. Other product and company names mentioned herein may be trademarks or tradenames of their respective owners.

Reproduction, transfer, distribution, or storage of part or all of the contents in this document in any form without the prior written permission of Nokia is prohibited. Nokia operates a policy of continuous development. Nokia reserves the right to make changes and improvements to any of the products described in this document without prior notice.



Java and all Java-based marks are trademarks or registered trademarks of Sun Microsystems, Inc.

This product is licensed under the MPEG-4 Visual Patent Portfolio License (i) for personal and noncommercial use in connection with information which has been encoded in compliance with the MPEG-4 Visual Standard by a consumer engaged in a personal and noncommercial activity and (ii) for use in connection with MPEG-4 video provided by a licensed video provider. No license is granted or shall be implied for any other use. Additional information, including that related to promotional, internal, and commercial uses, may be obtained from MPEG LA, LLC. See <http://www.mpegla.com>.

TO THE MAXIMUM EXTENT PERMITTED BY APPLICABLE LAW, UNDER NO CIRCUMSTANCES SHALL NOKIA OR ANY OF ITS LICENSORS BE RESPONSIBLE FOR ANY LOSS OF DATA OR INCOME OR ANY SPECIAL, INCIDENTAL, CONSEQUENTIAL OR INDIRECT DAMAGES HOWSOEVER CAUSED.

THE CONTENTS OF THIS DOCUMENT ARE PROVIDED "AS IS". EXCEPT AS REQUIRED BY APPLICABLE LAW, NO WARRANTIES OF ANY KIND, EITHER EXPRESS OR IMPLIED, INCLUDING, BUT NOT LIMITED TO, THE IMPLIED WARRANTIES OF MERCHANTABILITY AND FITNESS FOR A PARTICULAR PURPOSE, ARE MADE IN RELATION TO THE ACCURACY, RELIABILITY OR CONTENTS OF THIS DOCUMENT. NOKIA RESERVES THE RIGHT TO REVISE THIS DOCUMENT OR WITHDRAW IT AT ANY TIME WITHOUT PRIOR NOTICE.

Reverse engineering of software in the device is prohibited to the extent permitted by applicable law. Insofar as this user guide contains any limitations on Nokia's representations, warranties, damages and liabilities, such limitations shall likewise limit any representations, warranties, damages and liabilities of Nokia's licensors.

The third-party applications provided with your device may have been created and may be owned by persons or entities not affiliated with or related to Nokia. Nokia does not own the copyrights or intellectual property rights to the third-party applications. As such, Nokia does not take

any responsibility for end-user support, functionality of the applications, or the information in the applications or these materials. Nokia does not provide any warranty for the third-party applications. BY USING THE APPLICATIONS YOU ACKNOWLEDGE THAT THE APPLICATIONS ARE PROVIDED AS IS WITHOUT WARRANTY OF ANY KIND, EXPRESS OR IMPLIED, TO THE MAXIMUM EXTENT PERMITTED BY APPLICABLE LAW. YOU FURTHER ACKNOWLEDGE THAT NEITHER NOKIA NOR ITS AFFILIATES MAKE ANY REPRESENTATIONS OR WARRANTIES, EXPRESS OR IMPLIED, INCLUDING BUT NOT LIMITED TO WARRANTIES OF TITLE, MERCHANTABILITY OR FITNESS FOR A PARTICULAR PURPOSE, OR THAT THE APPLICATIONS WILL NOT INFRINGE ANY THIRD-PARTY PATENTS, COPYRIGHTS, TRADEMARKS, OR OTHER RIGHTS.

The availability of particular products and applications and services for these products may vary by region. Please check with your Nokia dealer for details and availability of language options. This device may contain commodities, technology or software subject to export laws and regulations from the US and other countries. Diversion contrary to law is prohibited.

FCC NOTICE

Your device may cause TV or radio interference (for example, when using a telephone in close proximity to receiving equipment). The FCC can require you to stop using your telephone if such interference cannot be eliminated. If you require assistance, contact your local service facility. This device complies with part 15 of the FCC rules. Operation is subject to the following two conditions: (1) This device may not cause harmful interference, and (2) this device must accept any interference received, including interference that may cause undesired operation. Any changes or modifications not expressly approved by Nokia could void the user's authority to operate this equipment.

Some operations and features are SIM card and/or network dependent, MMS dependent, or dependent on the

compatibility of devices and the content formats supported. Some services are subject to a separate charge.

Your device may have preinstalled bookmarks and links for third-party internet sites. You may also access other third-party sites through your device. Third-party sites are not affiliated with Nokia, and Nokia does not endorse or assume liability for them. If you choose to access such sites, you should take precautions for security or content.

9221954/Issue 1 EN

50 Index

Index	
A	
access codes	40
answering calls	21
antennas	11
audio messages	22
B	
background image	20
battery	
— charging	12
— inserting	9
Bluetooth	36
— receiving data	34
— sending data	34
C	
calls	
— answering	21
— emergency	20
— making	20
— rejecting	21
— voice mail	21
— volume	20
camera	
— capturing images	30
— image mode	30
charging the battery	12
chat services (IM)	25
connection methods	
— Bluetooth	34
connectors	8
contacts	
— copying	14
— images in	22
— in social networks	22
— managing	22
D	
data connections	
— wireless	31
declining calls	
— See <i>rejecting calls</i>	
E	
e-mail	
— sending	22
— setup	25
G	
general information	37
H	
help application	40
home screen	16

www.nokia.com/support

I		Nokia Ovi Player	28, 29
IM (instant messaging)	25	Nokia support information	37
inbox, messages	24		
K		O	
keyboard	16	Ovi by Nokia	15
keyguard	13	Ovi Contacts	25, 26
keypad lock	13	Ovi Music	29
keys and parts	8		
L		P	
lock code	40	pairing devices	36
		personalising your device	18
M		pictures	
mailbox		— copying	14
— voice	21	PIN code	40
media		PIN2 code	40
— music player	27	podcasting	27
memory card	10	predictive text input	17
messages	24	profiles	
MMS (multimedia message service)	22	— creating	18
multimedia messages	22	— personalising	18
music	27, 28	— selecting ringing tones	19
music player	27, 28	PUK codes	40
muting incoming calls	21		
		R	
N		rejecting calls	21
Nokia account	26	ringing tones	
		— in profiles	19

www.nokia.com/support

52 Index

S		U	
screen saver	20	updates	39
security code	40	UPIN code	40
sending		uploading media files	30
— using Bluetooth	34	UPUK code	40
Share online	30	useful information	37
sharing media files online	30		
SIM card		V	
— inserting	9	videos	
SMS (short message service)	22	— copying	14
software		voice mail	21
— updating	38	volume control	14
software updates	38, 39		
songs	27	W	
support	37	WLAN	
switch the device off	11	— access points	32
switch the device on	11	— availability	32
		WLAN (wireless local area network)	31
T		WLAN wizard	32
text			
— predictive input	17		
text input	16		
text messages	24		
— sending	22		
themes	20		
transferring content	14		
transferring music	28		

www.nokia.com/support