

Confidential
jedrocha
David Zhang; PCO reviewer
2014-12-01 10:38
© 2014 Microsoft

Confidential
jedrocha
David Zhang; PCO reviewer
2014-12-01 10:38
© 2014 Microsoft

Confidential
jedrocha
David Zhang; PCO reviewer
2014-12-01 10:38
© 2014 Microsoft

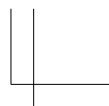

Quick Guide
Microsoft Lumia xxx
Microsoft Lumia xxx



[ERROR: book part number not defined] 1069
1 EN RM-1071

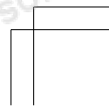
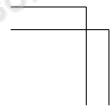

Confidential
jedrocha
David Zhang; PCO reviewer
2014-12-01 10:38
© 2014 Microsoft

Confidential
jedrocha
David Zhang; PCO reviewer
2014-12-01 10:38
© 2014 Microsoft

Confidential
jedrocha
David Zhang; PCO reviewer
2014-12-01 10:38
© 2014 Microsoft

Confidential
jedrocha
David Zhang; PCO reviewer
2014-12-01 10:38
© 2014 Microsoft

Confidential
jedrocha
David Zhang; PCO reviewer
2014-12-01 10:38
© 2014 Microsoft

Confidential
jedrocha
David Zhang; PCO reviewer
2014-12-01 10:38
© 2014 Microsoft

Confidential
jedrocha
David Zhang; PCO reviewer
2014-12-01 10:38
© 2014 Microsoft

Confidential
jedrocha
David Zhang; PCO reviewer
2014-12-01 10:38
© 2014 Microsoft

Confidential
jedrocha
David Zhang; PCO reviewer
2014-12-01 10:38
© 2014 Microsoft



Confidential
jedrocha
David Zhang; PCO reviewer
2014-12-01 10:38
© 2014 Microsoft

Keys and parts

Important: For important info on the safe use of your device and battery, read "For your safety" and "Product and safety info" at www.microsoft.com/mobile/support/ before you take your device into use. The same info is available in the in-device user guide. Select **Lumia Help + Tips**.

- 1 Earpiece
- 2 Audio connector (3.5 mm)
- 3 Front camera
- 4 Volume keys
- 5 Power/Lock key
- 6 Search key
- 7 Microphone
- 8 Micro-USB connector
- 9 Back key
- 10 Start key
- 11 Touch screen
- 12 Back camera
- 13 Antenna area
- 14 Loudspeaker

Some of the accessories mentioned in this user guide, such as charger, headset, or data cable, may be sold separately.

Avoid touching the antenna area while the antenna is in use. Contact with antennas affects the communication quality and may reduce battery life due to higher power level during operation.

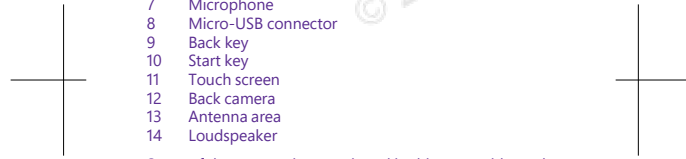

Confidential
jedrocha
David Zhang; PCO reviewer
2014-12-01 10:38
© 2014 Microsoft

Confidential
jedrocha
David Zhang; PCO reviewer
2014-12-01 10:38
© 2014 Microsoft

Confidential
jedrocha
David Zhang; PCO reviewer
2014-12-01 10:38
© 2014 Microsoft

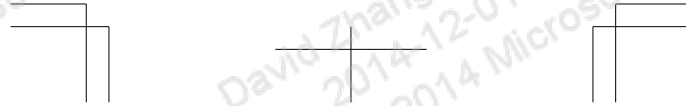

Confidential
jedrocha
David Zhang; PCO reviewer
2014-12-01 10:38
© 2014 Microsoft

Confidential
jedrocha
David Zhang; PCO reviewer
2014-12-01 10:38
© 2014 Microsoft

Confidential
jedrocha
David Zhang; PCO reviewer
2014-12-01 10:38
© 2014 Microsoft

Confidential
jedrocha
David Zhang; PCO reviewer
2014-12-01 10:38
© 2014 Microsoft

Confidential
jedrocha
David Zhang; PCO reviewer
2014-12-01 10:38
© 2014 Microsoft

Confidential
jedrocha
David Zhang; PCO reviewer
2014-12-01 10:38
© 2014 Microsoft

Confidential
jedrocha
David Zhang; PCO reviewer
2014-12-01 10:38
© 2014 Microsoft

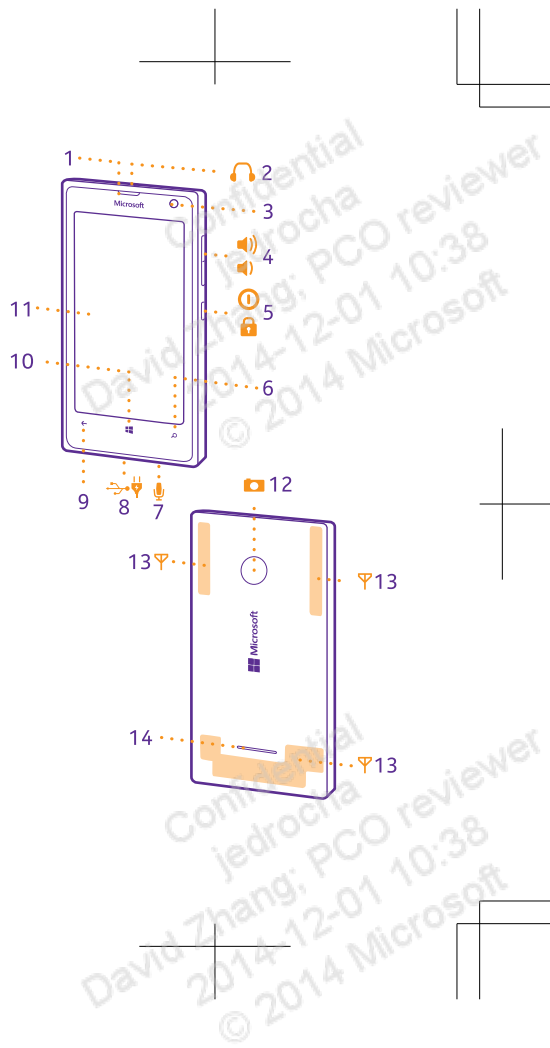

Confidential
jedrocha
David Zhang; PCO reviewer
2014-12-01 10:38
© 2014 Microsoft

Confidential
jedrocha
David Zhang; PCO reviewer
2014-12-01 10:38
© 2014 Microsoft

Confidential
jedrocha
David Zhang; PCO reviewer
2014-12-01 10:38
© 2014 Microsoft

Confidential
jedrocha
David Zhang; PCO reviewer
2014-12-01 10:38
© 2014 Microsoft

Confidential
jedrocha
David Zhang; PCO reviewer
2014-12-01 10:38
© 2014 Microsoft

Confidential
jedrocha
David Zhang; PCO reviewer
2014-12-01 10:38
© 2014 Microsoft

Confidential
jedrocha
David Zhang; PCO reviewer
2014-12-01 10:38
© 2014 Microsoft

Confidential
jedrocha
David Zhang; PCO reviewer
2014-12-01 10:38
© 2014 Microsoft

Confidential
jedrocha
David Zhang; PCO reviewer
2014-12-01 10:38
© 2014 Microsoft

Confidential
jedrocha
David Zhang; PCO reviewer
2014-12-01 10:38
© 2014 Microsoft

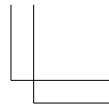
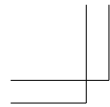

Confidential
jedrocha
David Zhang; PCO reviewer
2014-12-01 10:38
© 2014 Microsoft

Get started

Before you start using your phone, remove the back cover and battery to insert the micro-SIM cards (also known as mini-UICC cards).

Remove the back cover and battery

Make sure the phone is switched off.

1. Hold your phone by the top corners in one hand, and with the thumb of your other hand, press the back cover, and remove it. Do not use any sharp tools, as they may damage the phone.
2. If the battery is in, lift it out.

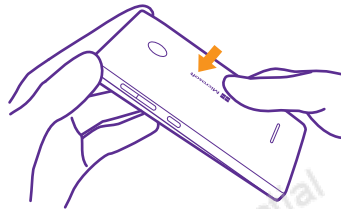

Confidential
jedrocha
David Zhang; PCO reviewer
2014-12-01 10:38
© 2014 Microsoft

Confidential
jedrocha
David Zhang; PCO reviewer
2014-12-01 10:38
© 2014 Microsoft

Confidential
jedrocha
David Zhang; PCO reviewer
2014-12-01 10:38
© 2014 Microsoft

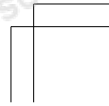
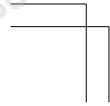

Confidential
jedrocha
David Zhang; PCO reviewer
2014-12-01 10:38
© 2014 Microsoft

Confidential
jedrocha
David Zhang; PCO reviewer
2014-12-01 10:38
© 2014 Microsoft

Confidential
jedrocha
David Zhang; PCO reviewer
2014-12-01 10:38
© 2014 Microsoft

Confidential
jedrocha
David Zhang; PCO reviewer
2014-12-01 10:38
© 2014 Microsoft

Confidential
jedrocha
David Zhang; PCO reviewer
2014-12-01 10:38
© 2014 Microsoft

Confidential
jedrocha
David Zhang; PCO reviewer
2014-12-01 10:38
© 2014 Microsoft

Confidential
jedrocha
David Zhang; PCO reviewer
2014-12-01 10:38
© 2014 Microsoft

Insert the SIM and memory card

1. Open the SIM holder, and put the micro-SIM in place with the metal contact area down. Close the holder.
2. For RM-1069: If you have a second SIM card, open the SIM2 holder, and put the SIM in place with the metal contact area down. Close the holder.

You can use 2G or 3G SIMs in both SIM1 and SIM2 holders. While 3G network is active on one SIM, the other supports only 2G network.

3. If you have a memory card, slide the card into the memory card slot.

It is recommended that you use a fast microSD card from a well-known manufacturer.

Use only original micro-SIM cards. Use of incompatible SIM cards, or use of SIM card adapters, may damage the card or the device, and may corrupt data stored on the card.

Confidential
jedrocha
David Zhang; PCO reviewer
2014-12-01 10:38
© 2014 Microsoft

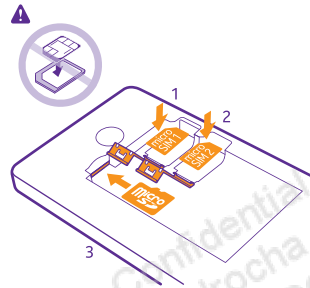

Confidential
jedrocha
David Zhang; PCO reviewer
2014-12-01 10:38
© 2014 Microsoft

Confidential
jedrocha
David Zhang; PCO reviewer
2014-12-01 10:38
© 2014 Microsoft

Confidential
jedrocha
David Zhang; PCO reviewer
2014-12-01 10:38
© 2014 Microsoft

Confidential
jedrocha
David Zhang; PCO reviewer
2014-12-01 10:38
© 2014 Microsoft

Confidential
jedrocha
David Zhang; PCO reviewer
2014-12-01 10:38
© 2014 Microsoft

Confidential
jedrocha
David Zhang; PCO reviewer
2014-12-01 10:38
© 2014 Microsoft

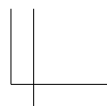

Get started

Replace the battery and back cover

1. Line up the battery contacts, and put the battery in.
2. Press the bottom edge of the back cover against the bottom edge of your phone, and snap the cover into place.
3. To switch your phone on, press and hold the power key.

Charge the battery

Plug a compatible charger into a wall outlet, and connect the micro-USB end to your phone. You can also charge your phone from a computer with a USB cable.

If the battery is completely discharged, it may take up to 20 minutes before the charging indicator is displayed.

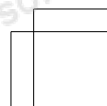
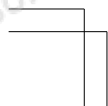
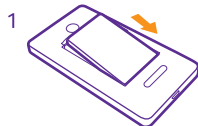

Confidential
jedrocha
David Zhang; PCO reviewer
2014-12-01 10:38
© 2014 Microsoft

Confidential
jedrocha
David Zhang; PCO reviewer
2014-12-01 10:38
© 2014 Microsoft

Confidential
jedrocha
David Zhang; PCO reviewer
2014-12-01 10:38
© 2014 Microsoft

Confidential
jedrocha
David Zhang; PCO reviewer
2014-12-01 10:38
© 2014 Microsoft

Confidential
jedrocha
David Zhang; PCO reviewer
2014-12-01 10:38
© 2014 Microsoft

Confidential
jedrocha
David Zhang; PCO reviewer
2014-12-01 10:38
© 2014 Microsoft

Confidential
jedrocha
David Zhang; PCO reviewer
2014-12-01 10:38
© 2014 Microsoft

Confidential
jedrocha
David Zhang; PCO reviewer
2014-12-01 10:38
© 2014 Microsoft

Confidential
jedrocha
David Zhang; PCO reviewer
2014-12-01 10:38
© 2014 Microsoft

Confidential
jedrocha
David Zhang; PCO reviewer
2014-12-01 10:38
© 2014 Microsoft

Set up your phone

1. To switch your phone on, press and hold the power key, and follow the instructions shown on your phone.
2. When asked, create your Microsoft account if you don't have one already, or sign in with your existing Xbox, Hotmail, or Outlook username and password.

You need a Microsoft account to back up and restore your phone, to buy, install, and update apps, and to access some Microsoft services, such as OneDrive.

Allow some minutes while your phone installs all its features.

Tip: If your screen switches off, press the power key, and drag the lock screen up.

Confidential
jedrocha
David Zhang; PCO reviewer
2014-12-01 10:38
© 2014 Microsoft

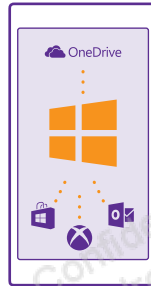

Confidential
jedrocha
David Zhang; PCO reviewer
2014-12-01 10:38
© 2014 Microsoft

Confidential
jedrocha
David Zhang; PCO reviewer
2014-12-01 10:38
© 2014 Microsoft

Confidential
jedrocha
David Zhang; PCO reviewer
2014-12-01 10:38
© 2014 Microsoft

Confidential
jedrocha
David Zhang; PCO reviewer
2014-12-01 10:38
© 2014 Microsoft

Confidential
jedrocha
David Zhang; PCO reviewer
2014-12-01 10:38
© 2014 Microsoft

Confidential
jedrocha
David Zhang; PCO reviewer
2014-12-01 10:38
© 2014 Microsoft

Confidential
jedrocha
David Zhang; PCO reviewer
2014-12-01 10:38
© 2014 Microsoft



Confidential
jedrocha
David Zhang; PCO reviewer
2014-12-01 10:38
© 2014 Microsoft

Confidential
jedrocha
David Zhang; PCO reviewer
2014-12-01 10:38
© 2014 Microsoft

Explore your tiles and apps

The start screen is the main view of your phone. Pin shortcuts to apps, contacts, browser bookmarks, and more, and arrange and resize the tiles. Some tiles may show you notifications and updates.

The apps menu is the home to all your apps. To go to the apps menu from the start screen, swipe left. To go back, swipe right.

Tip: To go back to the start screen from any view, tap . To switch between open apps, tap and hold , and choose the app you want. To close an app, tap .

To see more options, such as settings, in an app, tap  at the bottom right corner.

Confidential
jedrocha
David Zhang; PCO reviewer
2014-12-01 10:38
© 2014 Microsoft

Confidential
jedrocha
David Zhang; PCO reviewer
2014-12-01 10:38
© 2014 Microsoft

Confidential
jedrocha
David Zhang; PCO reviewer
2014-12-01 10:38
© 2014 Microsoft

Confidential
jedrocha
David Zhang; PCO reviewer
2014-12-01 10:38
© 2014 Microsoft

Confidential
jedrocha
David Zhang; PCO reviewer
2014-12-01 10:38
© 2014 Microsoft

Confidential
jedrocha
David Zhang; PCO reviewer
2014-12-01 10:38
© 2014 Microsoft

Confidential
jedrocha
David Zhang; PCO reviewer
2014-12-01 10:38
© 2014 Microsoft

Confidential
jedrocha
David Zhang; PCO reviewer
2014-12-01 10:38
© 2014 Microsoft

Confidential
jedrocha
David Zhang; PCO reviewer
2014-12-01 10:38
© 2014 Microsoft

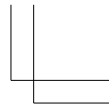
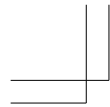

Confidential
jedrocha
David Zhang; PCO reviewer
2014-12-01 10:38
© 2014 Microsoft

Navigate by touch

To use your phone, simply swipe, tap, or tap and hold the screen.

Swipe

Place your finger on the screen, and slide your finger in the direction you want.

For example, to open the action centre, place a finger at the top of the screen, and slide it down.

Zoom in or out

Place 2 fingers on an item, such as a photo or a web page, and slide your fingers apart or together.

Tap and hold to open a menu

Place your finger on an item, until the menu opens.

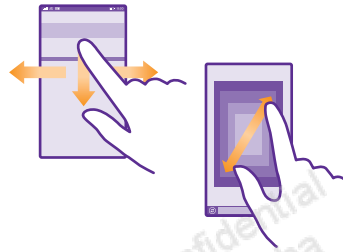

Confidential
jedrocha
David Zhang; PCO reviewer
2014-12-01 10:38
© 2014 Microsoft

Confidential
jedrocha
David Zhang; PCO reviewer
2014-12-01 10:38
© 2014 Microsoft

Confidential
jedrocha
David Zhang; PCO reviewer
2014-12-01 10:38
© 2014 Microsoft

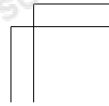
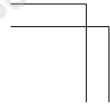

Confidential
jedrocha
David Zhang; PCO reviewer
2014-12-01 10:38
© 2014 Microsoft

Confidential
jedrocha
David Zhang; PCO reviewer
2014-12-01 10:38
© 2014 Microsoft

Confidential
jedrocha
David Zhang; PCO reviewer
2014-12-01 10:38
© 2014 Microsoft

Confidential
jedrocha
David Zhang; PCO reviewer
2014-12-01 10:38
© 2014 Microsoft

Confidential
jedrocha
David Zhang; PCO reviewer
2014-12-01 10:38
© 2014 Microsoft

Confidential
jedrocha
David Zhang; PCO reviewer
2014-12-01 10:38
© 2014 Microsoft

Confidential
jedrocha
David Zhang; PCO reviewer
2014-12-01 10:38
© 2014 Microsoft

Transfer content from your old phone

You can transfer content from your old phone in several ways.

To transfer your contacts, text messages, pictures, and videos, use the Transfer my Data app. Your old phone must support Bluetooth. Not all phones or content may be compatible with the transfer.

To transfer other content, such as music, see the section for new Lumia users in the [Lumia Help + Tips](#) app, or go to www.microsoft.com/mobile/switch-easy.



Confidential
jedrocha
David Zhang; PCO reviewer
2014-12-01 10:38
© 2014 Microsoft

Confidential
jedrocha
David Zhang; PCO reviewer
2014-12-01 10:38
© 2014 Microsoft

Confidential
jedrocha
David Zhang; PCO reviewer
2014-12-01 10:38
© 2014 Microsoft

Confidential
jedrocha
David Zhang; PCO reviewer
2014-12-01 10:38
© 2014 Microsoft

Confidential
jedrocha
David Zhang; PCO reviewer
2014-12-01 10:38
© 2014 Microsoft

Confidential
jedrocha
David Zhang; PCO reviewer
2014-12-01 10:38
© 2014 Microsoft

Confidential
jedrocha
David Zhang; PCO reviewer
2014-12-01 10:38
© 2014 Microsoft

Confidential
jedrocha
David Zhang; PCO reviewer
2014-12-01 10:38
© 2014 Microsoft

Confidential
jedrocha
David Zhang; PCO reviewer
2014-12-01 10:38
© 2014 Microsoft

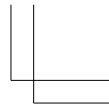
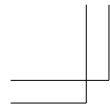

Confidential
jedrocha
David Zhang; PCO reviewer
2014-12-01 10:38
© 2014 Microsoft

Help and tips

There's a user guide in your phone – it's always with you, available when needed. Check out videos, find answers to your questions, and get helpful tips. On the start screen, swipe left, and tap  Lumia Help + Tips. If you're new to Lumia, check out the section for new users. Make sure to keep the Lumia Help + Tips app up to date.

For the online user guide, even more info, and troubleshooting help, go to www.microsoft.com/mobile/support/.

If your phone doesn't respond

To restart the phone without losing your data and settings, press and hold the volume down key and power key at the same time for about 10 seconds. The phone vibrates and restarts.

You can also remove and replace the battery, and switch the phone on.



Confidential
jedrocha
David Zhang; PCO reviewer
2014-12-01 10:38
© 2014 Microsoft

Confidential
jedrocha
David Zhang; PCO reviewer
2014-12-01 10:38
© 2014 Microsoft

Confidential
jedrocha
David Zhang; PCO reviewer
2014-12-01 10:38
© 2014 Microsoft

Confidential
jedrocha
David Zhang; PCO reviewer
2014-12-01 10:38
© 2014 Microsoft

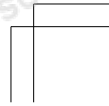
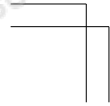

Confidential
jedrocha
David Zhang; PCO reviewer
2014-12-01 10:38
© 2014 Microsoft

Confidential
jedrocha
David Zhang; PCO reviewer
2014-12-01 10:38
© 2014 Microsoft

Confidential
jedrocha
David Zhang; PCO reviewer
2014-12-01 10:38
© 2014 Microsoft

Confidential
jedrocha
David Zhang; PCO reviewer
2014-12-01 10:38
© 2014 Microsoft

Confidential
jedrocha
David Zhang; PCO reviewer
2014-12-01 10:38
© 2014 Microsoft

Confidential
jedrocha
David Zhang; PCO reviewer
2014-12-01 10:38
© 2014 Microsoft

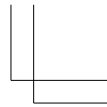
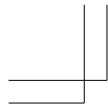

Product and safety info

For info on Microsoft Mobile Service terms and Privacy policy, go to www.microsoft.com/mobile/privacypolicy.

This user guide applies to RM-1069 and RM-1071.

You can only use your device on the GSM 850, 900, 1800, 1900 MHz networks; WCDMA 900, 2100 MHz networks.

Use your device only with an original BV-SJ rechargeable battery. Do not dispose batteries as household waste. Charge your device with AC-18 charger. Charger plug type may vary. Microsoft Mobile may make additional battery or charger models available for this device.

Do not drop, knock, or shake the device or the battery. Rough handling can break them.

Third-party chargers that comply with the IEC/EN 62684 standard, and that can connect to your device micro USB connector, may also be compatible.

To prevent possible hearing damage, do not listen at high volume levels for long periods. Exercise caution when holding your device near your ear while the loudspeaker is in use.

The crossed-out wheeled-bin symbol on your product, battery, literature, or packaging reminds you that all electrical and electronic products and batteries must be taken to separate collection at the end of their working life. Do not dispose of these products as unsorted municipal waste; take them for recycling. For info on your nearest recycling point, check with your local waste authority, or go to www.microsoft.com/mobile/support/. For more info on the environmental attributes of your device, see www.microsoft.com/mobile/ecoprofile.

When using this device, obey all laws and respect local customs, privacy and legitimate rights of others, including copyrights.

Additional safety information

Hearing

Warning: When you use the headset, your ability to hear outside sounds may be affected. Do not use the headset where it can endanger your safety.

Some wireless devices may interfere with some hearing aids.



Confidential
jedrocha
David Zhang; PCO reviewer
2014-12-01 10:38
© 2014 Microsoft

Confidential
jedrocha
David Zhang; PCO reviewer
2014-12-01 10:38
© 2014 Microsoft

Confidential
jedrocha
David Zhang; PCO reviewer
2014-12-01 10:38
© 2014 Microsoft

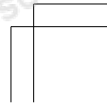
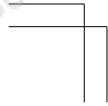

Confidential
jedrocha
David Zhang; PCO reviewer
2014-12-01 10:38
© 2014 Microsoft

Confidential
jedrocha
David Zhang; PCO reviewer
2014-12-01 10:38
© 2014 Microsoft

Confidential
jedrocha
David Zhang; PCO reviewer
2014-12-01 10:38
© 2014 Microsoft

Confidential
jedrocha
David Zhang; PCO reviewer
2014-12-01 10:38
© 2014 Microsoft

Confidential
jedrocha
David Zhang; PCO reviewer
2014-12-01 10:38
© 2014 Microsoft

Confidential
jedrocha
David Zhang; PCO reviewer
2014-12-01 10:38
© 2014 Microsoft

Confidential
jedrocha
David Zhang; PCO reviewer
2014-12-01 10:38
© 2014 Microsoft

Confidential
jedrocha
David Zhang; PCO reviewer
2014-12-01 10:38
© 2014 Microsoft

Confidential
jedrocha
David Zhang; PCO reviewer
2014-12-01 10:38
© 2014 Microsoft

Confidential
jedrocha
David Zhang; PCO reviewer
2014-12-01 10:38
© 2014 Microsoft

Confidential
jedrocha
David Zhang; PCO reviewer
2014-12-01 10:38
© 2014 Microsoft

Confidential
jedrocha
David Zhang; PCO reviewer
2014-12-01 10:38
© 2014 Microsoft

Confidential
jedrocha
David Zhang; PCO reviewer
2014-12-01 10:38
© 2014 Microsoft

Confidential
jedrocha
David Zhang; PCO reviewer
2014-12-01 10:38
© 2014 Microsoft

Confidential
jedrocha
David Zhang; PCO reviewer
2014-12-01 10:38
© 2014 Microsoft

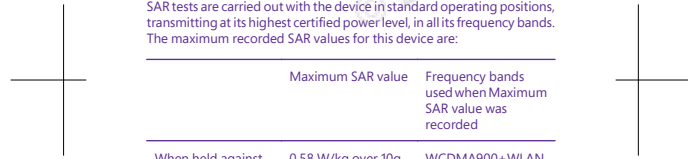
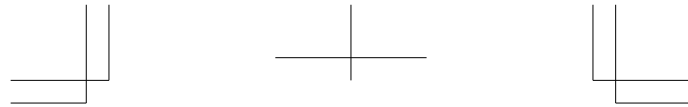

Nickel

The surface of this device is nickel-free.

Certification information (SAR)

This mobile device meets international guidelines for exposure to radio waves.

Your mobile device is a radio transmitter and receiver. It is designed not to exceed the limits for exposure to radio waves (radio frequency electromagnetic fields), recommended by international guidelines from the independent scientific organization ICNIRP. These guidelines incorporate substantial safety margins that are intended to assure the protection of all persons regardless of age and health.

The exposure guidelines are based on the Specific Absorption Rate (SAR), which is an expression of the amount of radio frequency (RF) power deposited in the head or body when the device is transmitting. The ICNIRP SAR limit for mobile devices is 2.0 W/kg averaged over 10 grams of tissue.

SAR tests are carried out with the device in standard operating positions, transmitting at its highest certified power level, in all its frequency bands. The maximum recorded SAR values for this device are:

	Maximum SAR value	Frequency bands used when Maximum SAR value was recorded
When held against the head	0.58 W/kg over 10g	WCDMA900+WLAN 2450
When operated at a separation distance of 1.5 centimetres (5/8 inch) from the body	0.54 W/kg over 10g	WCDMA900+WLAN 2450

This device meets RF exposure guidelines when used against the head or when positioned at least 1.5 centimetres (5/8 inch) away from the body. When a carry case, belt clip or other form of device holder is used for body-worn operation, it should not contain metal and should provide at least the above stated separation distance from the body.

Confidential
jedrocha
David Zhang; PCO reviewer
2014-12-01 10:38
© 2014 Microsoft

Confidential
jedrocha
David Zhang; PCO reviewer
2014-12-01 10:38
© 2014 Microsoft

Confidential
jedrocha
David Zhang; PCO reviewer
2014-12-01 10:38
© 2014 Microsoft

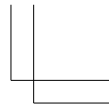
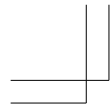

Confidential
jedrocha
David Zhang; PCO reviewer
2014-12-01 10:38
© 2014 Microsoft

To send data or messages, a good connection to the network is needed. Sending may be delayed until such a connection is available. Follow the separation distance instructions until the sending is finished. During general use, the SAR values are usually well below the values stated above. This is because, for purposes of system efficiency and to minimise interference on the network, the operating power of your mobile is automatically decreased when full power is not needed for the call. The lower the power output, the lower the SAR value. Device models may have different versions and more than one value. Component and design changes may occur over time and some changes could affect SAR values. The latest available SAR information for this and other Microsoft Mobile device models can be found at www.microsoft.com/mobile/sar.

For more info, go to www.sar-tick.com. Note that mobile devices may be transmitting even if you are not making a voice call. The World Health Organization (WHO) has stated that current scientific information does not indicate the need for any special precautions when using mobile devices. If you are interested in reducing your exposure, they recommend you limit your usage or use a hands-free kit to keep the device away from your head and body. For more information and explanations and discussions on RF exposure, go to the WHO website at www.who.int/peh-emf/en.

Confidential
jedrocha
David Zhang; PCO reviewer
2014-12-01 10:38
© 2014 Microsoft



Copyrights and other notices

Declaration of Conformity

Hereby, Microsoft Mobile Oy declares that this RM-1069 or RM-1071 product is in compliance with the essential requirements and other relevant provisions of Directive 1999/5/EC. A copy of the Declaration of Conformity can be found at www.microsoft.com/mobile/declaration-of-conformity.

The availability of products, features, apps and services may vary by region. For more info, contact your dealer or your service provider. The contents of this document are provided "as is". Except as required by applicable law, no warranties of any kind, either express or implied, including, but not limited to, the implied warranties of merchantability and fitness for a particular purpose, are made in relation to the accuracy, reliability or contents of this document. Microsoft Mobile reserves the right to revise this document or withdraw it at any time without prior notice.

To the maximum extent permitted by applicable law, under no circumstances shall Microsoft Mobile or any of its licensors be

Confidential
jedrocha
David Zhang; PCO reviewer
2014-12-01 10:38
© 2014 Microsoft

Confidential
jedrocha
David Zhang; PCO reviewer
2014-12-01 10:38
© 2014 Microsoft

Confidential
jedrocha
David Zhang; PCO reviewer
2014-12-01 10:38
© 2014 Microsoft

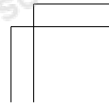
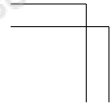

Confidential
jedrocha
David Zhang; PCO reviewer
2014-12-01 10:38
© 2014 Microsoft

Confidential
jedrocha
David Zhang; PCO reviewer
2014-12-01 10:38
© 2014 Microsoft

Confidential
jedrocha
David Zhang; PCO reviewer
2014-12-01 10:38
© 2014 Microsoft

Confidential
jedrocha
David Zhang; PCO reviewer
2014-12-01 10:38
© 2014 Microsoft

Confidential
jedrocha
David Zhang; PCO reviewer
2014-12-01 10:38
© 2014 Microsoft

Confidential
jedrocha
David Zhang; PCO reviewer
2014-12-01 10:38
© 2014 Microsoft

Confidential
jedrocha
David Zhang; PCO reviewer
2014-12-01 10:38
© 2014 Microsoft

Confidential
jedrocha
David Zhang; PCO reviewer
2014-12-01 10:38
© 2014 Microsoft

Confidential
jedrocha
David Zhang; PCO reviewer
2014-12-01 10:38
© 2014 Microsoft

Confidential
jedrocha
David Zhang; PCO reviewer
2014-12-01 10:38
© 2014 Microsoft

Confidential
jedrocha
David Zhang; PCO reviewer
2014-12-01 10:38
© 2014 Microsoft

Confidential
jedrocha
David Zhang; PCO reviewer
2014-12-01 10:38
© 2014 Microsoft

Confidential
jedrocha
David Zhang; PCO reviewer
2014-12-01 10:38
© 2014 Microsoft

Confidential
jedrocha
David Zhang; PCO reviewer
2014-12-01 10:38
© 2014 Microsoft

Confidential
jedrocha
David Zhang; PCO reviewer
2014-12-01 10:38
© 2014 Microsoft

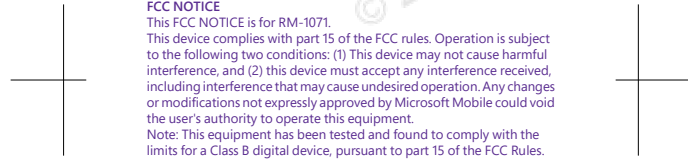
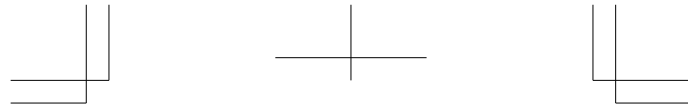

responsible for any loss of data or income or any special, incidental, consequential or indirect damages howsoever caused. Reproduction, transfer or distribution of part or all of the contents in this document in any form without the prior written permission of Microsoft Mobile is prohibited. Microsoft Mobile operates a policy of continuous development. Microsoft Mobile reserves the right to make changes and improvements to any of the products described in this document without prior notice. Microsoft Mobile does not make any representations, provide a warranty, or take any responsibility for the functionality, content, or end-user support of third-party apps provided with your device. By using an app, you acknowledge that the app is provided as is. To access the Windows Phone software license terms, select **Settings > about**. Please read the terms. Please note that by using the software, you accept the terms. If you do not accept the terms, do not use the device or software. Instead contact Microsoft Mobile or the party from which you purchased the device to determine its return policy.

FCC NOTICE

This FCC NOTICE is for RM-1071.

This device complies with part 15 of the FCC rules. Operation is subject to the following two conditions: (1) This device may not cause harmful interference, and (2) this device must accept any interference received, including interference that may cause undesired operation. Any changes or modifications not expressly approved by Microsoft Mobile could void the user's authority to operate this equipment.

Note: This equipment has been tested and found to comply with the limits for a Class B digital device, pursuant to part 15 of the FCC Rules. These limits are designed to provide reasonable protection against harmful interference in a residential installation. This equipment generates, uses and can radiate radio frequency energy and, if not installed and used in accordance with the instructions, may cause harmful interference to radio communications. However, there is no guarantee that interference will not occur in a particular installation. If this equipment does cause harmful interference to radio or television reception, which can be determined by turning the equipment off and on, the user is encouraged to try to correct the interference by one or more of the following measures:

- Reorient or relocate the receiving antenna.
- Increase the separation between the equipment and receiver.
- Connect the equipment into an outlet on a circuit different from that to which the receiver is connected.
- Consult the dealer or an experienced radio/TV technician for help.

Confidential
jedrocha
David Zhang; PCO reviewer
2014-12-01 10:38
© 2014 Microsoft

Confidential
jedrocha
David Zhang; PCO reviewer
2014-12-01 10:38
© 2014 Microsoft

Confidential
jedrocha
David Zhang; PCO reviewer
2014-12-01 10:38
© 2014 Microsoft

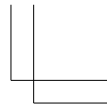

Confidential
jedrocha
David Zhang; PCO reviewer
2014-12-01 10:38
© 2014 Microsoft

Manufacturer: Microsoft Mobile Oy, Keilalahdentie 2-4, 02150 Espoo, Finland
Importer: Microsoft Mobile Oy (see above), or Nokia Komárom Kft, Nokia Utca 1., 2900 Komárom, Hungary
TM © 2014 Microsoft Mobile. All rights reserved. Microsoft, Windows, the Windows logo and Lumia are trademarks of the Microsoft group of companies. Third party products/names may be TM of respective owner. The Bluetooth word mark and logos are owned by the Bluetooth SIG, Inc. and any use of such marks by Microsoft Mobile is under license. This product is licensed under the MPEG-4 Visual Patent Portfolio License (i) for personal and noncommercial use in connection with information which has been encoded in compliance with the MPEG-4 Visual Standard by a consumer engaged in a personal and noncommercial activity and (ii) for use in connection with MPEG-4 video provided by a licensed video provider. No license is granted or shall be implied for any other use. Additional information, including that related to promotional, internal, and commercial uses, may be obtained from MPEG LA, LLC. See www.mpegla.com.

Confidential
jedrocha
David Zhang; PCO reviewer
2014-12-01 10:38
© 2014 Microsoft



MANUFACTURER'S LIMITED WARRANTY

1. GENERAL

Microsoft Mobile Oy, Keilalahdentie 2-4 FIN-02150 Espoo, Finland (hereinafter "Manufacturer") provides this Manufacturer's Limited Warranty ("Warranty") for the genuine product (the "Product"), which Manufacturer has released for sale in the European Union, Iceland, Norway, Switzerland, and Turkey ("Covered Countries") since 1 November 2013. This Warranty is distinct from any statutory rights under any mandatory consumer protection laws of your country applicable to you. It is intended to grant you specific, and as the case may be, additional rights, within the limits of what is permissible under such law, and does not limit the rights you may have under applicable statutory product warranty provisions. You may have other rights based on local laws during or after the Warranty period. These rights are not excluded by this Warranty.

Confidential
jedrocha
David Zhang; PCO reviewer
2014-12-01 10:38
© 2014 Microsoft

Confidential
jedrocha
David Zhang; PCO reviewer
2014-12-01 10:38
© 2014 Microsoft

Confidential
jedrocha
David Zhang; PCO reviewer
2014-12-01 10:38
© 2014 Microsoft

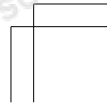
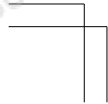

Confidential
jedrocha
David Zhang; PCO reviewer
2014-12-01 10:38
© 2014 Microsoft

Confidential
jedrocha
David Zhang; PCO reviewer
2014-12-01 10:38
© 2014 Microsoft

Confidential
jedrocha
David Zhang; PCO reviewer
2014-12-01 10:38
© 2014 Microsoft

Confidential
jedrocha
David Zhang; PCO reviewer
2014-12-01 10:38
© 2014 Microsoft

Confidential
jedrocha
David Zhang; PCO reviewer
2014-12-01 10:38
© 2014 Microsoft

Confidential
jedrocha
David Zhang; PCO reviewer
2014-12-01 10:38
© 2014 Microsoft

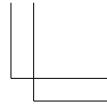
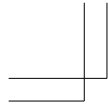

Confidential
jedrocha
David Zhang; PCO reviewer
2014-12-01 10:38
© 2014 Microsoft

2. WARRANTY

From the date the Product is sold to an end-user for the first time, as evidenced by the original proof of purchase, Manufacturer warrants the Product is free from defects in materials and workmanship ("Defect") as follows:

- (i) Twenty four (24) months for the main device;
- (ii) Twelve (12) months for accessories sold separately or included in the sales pack of the main device excluding batteries, covers, cables and chargers; and
- (iii) Six (6) months for all batteries, covers, cables and chargers, unless otherwise specified in the Product user guide.

During the warranty period, Manufacturer will, in a reasonable time, remedy the Defect free of charge by either repairing or replacing the defective Product or the defective part of it at its option provided that you have informed Manufacturer of the Defect before the warranty period expires. When repairing or replacing your Product, Manufacturer may use new or re-conditioned parts or products.

To the fullest extent permitted by applicable law, no repair or replacement will renew or extend the warranty period. Original or replacement parts or replacement Products provided under this Warranty will be covered by this Warranty for the remainder of the original warranty period or for sixty (60) days from the date of repair or replacement, whichever is longer.

The Product or all parts of your Product that Manufacturer has replaced shall become Manufacturer's property.

Manufacturer does not warrant that software preinstalled by or on behalf of Manufacturer in the Product (or subsequent updates and upgrades) (together "Manufacturer software") will meet your requirements, work in combination with any hardware or software not provided by Manufacturer, is uninterrupted or error free or that errors are correctable or will be corrected. For Manufacturer software related errors, Manufacturer will make available the latest version of the Manufacturer software for reinstallation on your Product or, if that would not be possible, another remedy, which in Manufacturer's reasonable discretion, satisfactorily addresses the error. Some Manufacturer software may be subject to separate license terms that are available with the software or your local section of www.microsoft.com/mobile. Please always back up all data and content stored on your Product before taking your Product in for service since service activities will erase all data from your Product.

3. WHAT THIS WARRANTY DOES NOT COVER

Manufacturer does not provide any warranty for the following:



Confidential
jedrocha
David Zhang; PCO reviewer
2014-12-01 10:38
© 2014 Microsoft

Confidential
jedrocha
David Zhang; PCO reviewer
2014-12-01 10:38
© 2014 Microsoft

Confidential
jedrocha
David Zhang; PCO reviewer
2014-12-01 10:38
© 2014 Microsoft

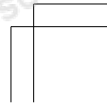
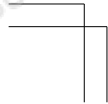

Confidential
jedrocha
David Zhang; PCO reviewer
2014-12-01 10:38
© 2014 Microsoft

Confidential
jedrocha
David Zhang; PCO reviewer
2014-12-01 10:38
© 2014 Microsoft

Confidential
jedrocha
David Zhang; PCO reviewer
2014-12-01 10:38
© 2014 Microsoft

Confidential
jedrocha
David Zhang; PCO reviewer
2014-12-01 10:38
© 2014 Microsoft

Confidential
jedrocha
David Zhang; PCO reviewer
2014-12-01 10:38
© 2014 Microsoft

Confidential
jedrocha
David Zhang; PCO reviewer
2014-12-01 10:38
© 2014 Microsoft

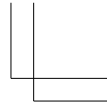
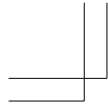

Confidential
jedrocha
David Zhang; PCO reviewer
2014-12-01 10:38
© 2014 Microsoft



1 User guides;
2 Any (i) third party software, settings, content, data, or links installed or downloaded onto your Product at any time, or (ii) Manufacturer and third party services or enabling clients even if preinstalled by Manufacturer (please read the terms and conditions that may accompany the services as those will define your rights and obligations);
3 Any (i) normal wear and tear, (ii) reduced charging capacity of the battery resulting from its natural end of product life, or (iii) pixel defects in your Product's display that are within the scope of industry standards;
4 SIM card and/or any cellular or other networks or system on which your Product operates; or
5 Errors or damage caused by: (i) misuse or not using your Product in accordance with the user guide, such as if the Product has been exposed to moisture, to dampness or to extreme thermal or environmental conditions or to rapid changes in such conditions, to corrosion, to oxidation, to spillage of food or liquid or to influence from chemical products, (ii) using your Product with, or connecting it to, any product, accessory, software, or service not manufactured or supplied by Manufacturer, (iii) any products combined with your Product by a third party, (iv) damage or errors caused by hacking, cracking, viruses, or other malware, or by unauthorised access to services, accounts, computer systems or networks; or (v) other acts beyond Manufacturer's reasonable control.



This Warranty is not valid:
1 Outside of the Covered Countries;
2 If your Product, or the software it runs on, has been (i) opened, modified, or repaired without Manufacturer's authorisation, or (ii) repaired with unauthorised spare parts;
3 If your Product's serial number, the mobile accessory date code, or the IMEI number has been removed, erased, defaced, altered or if these are illegible in any way;
4 If you have not installed the latest software updates that are publicly available for your Product within a reasonable time of their release; or
5 If you refuse to give possession of the Product to Manufacturer for repair and investigation.

If this Warranty does not cover your Product or the issue based on which it requires service, Manufacturer reserves the right to charge for the repair or replacement of your Product, as well as a handling fee.

4. LIMITATION OF MANUFACTURER'S LIABILITY
To the extent permitted by applicable law(s), Manufacturer shall not under any circumstances be liable, either expressly or impliedly, for any

Confidential
jedrocha
David Zhang; PCO reviewer
2014-12-01 10:38
© 2014 Microsoft

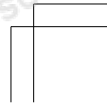
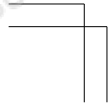

Confidential
jedrocha
David Zhang; PCO reviewer
2014-12-01 10:38
© 2014 Microsoft

Confidential
jedrocha
David Zhang; PCO reviewer
2014-12-01 10:38
© 2014 Microsoft

Confidential
jedrocha
David Zhang; PCO reviewer
2014-12-01 10:38
© 2014 Microsoft

Confidential
jedrocha
David Zhang; PCO reviewer
2014-12-01 10:38
© 2014 Microsoft

Confidential
jedrocha
David Zhang; PCO reviewer
2014-12-01 10:38
© 2014 Microsoft

Confidential
jedrocha
David Zhang; PCO reviewer
2014-12-01 10:38
© 2014 Microsoft

Confidential
jedrocha
David Zhang; PCO reviewer
2014-12-01 10:38
© 2014 Microsoft

Confidential
jedrocha
David Zhang; PCO reviewer
2014-12-01 10:38
© 2014 Microsoft

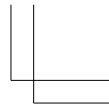
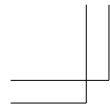

Confidential
jedrocha
David Zhang; PCO reviewer
2014-12-01 10:38
© 2014 Microsoft

1 Damages or losses of any kind whatsoever resulting from or relating to loss of, damage to, or corruption of, content or data or the recreation or transfer thereof even if such loss, damage, or corruption was a result of a Defect in your Product; and/or
2 Loss of profit, products or functionality, business, contracts, revenues or anticipated savings, increased costs or expenses, or for any indirect, consequential or special loss or damage.
To the extent permitted by applicable law, Manufacturer's liability shall be limited to the purchase value of your Product.
The limitations in this clause 4 shall not apply in case of Manufacturer's negligence or intentional misconduct or in case of death or personal injury resulting from Manufacturer's proven negligence.

5. OTHER IMPORTANT NOTICES

For further information on your Warranty, as well as information needed to process your warranty queries, please visit www.microsoft.com/mobile.

Please ensure your operator has removed any SIM-locks (or other equivalent mechanisms that may lock your Product to a specific network or operator) prior to delivering your Product for repair.

Your Product may contain country specific elements, including software. The warranty services available in a particular country may be limited to the Products and country specific elements available in that country. Also, if your Product has been re-exported from its original destination to another country, your Product may contain country specific elements that are not considered a defect under this Warranty even if it would not be operational.

Microsoft Mobile Oy, Keilalahdentie 2-4, FIN-02150 Espoo, Finland



Confidential
jedrocha
David Zhang; PCO reviewer
2014-12-01 10:38
© 2014 Microsoft

Confidential
jedrocha
David Zhang; PCO reviewer
2014-12-01 10:38
© 2014 Microsoft

Confidential
jedrocha
David Zhang; PCO reviewer
2014-12-01 10:38
© 2014 Microsoft

Confidential
jedrocha
David Zhang; PCO reviewer
2014-12-01 10:38
© 2014 Microsoft

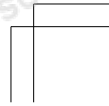
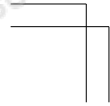

Confidential
jedrocha
David Zhang; PCO reviewer
2014-12-01 10:38
© 2014 Microsoft

Confidential
jedrocha
David Zhang; PCO reviewer
2014-12-01 10:38
© 2014 Microsoft

Confidential
jedrocha
David Zhang; PCO reviewer
2014-12-01 10:38
© 2014 Microsoft