

## Nokia Bluetooth Headset BH-201

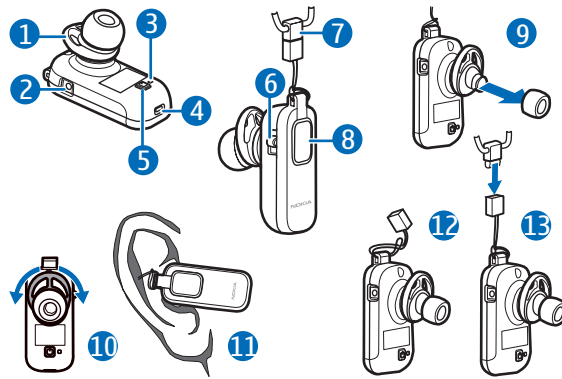

9200041/1

ENGLISH

DECLARATION OF CONFORMITY

Hereby, NOKIA CORPORATION declares that this HS-52W product is in compliance with the essential requirements and other relevant provisions of Directive 1999/5/EC. A copy of the Declaration of Conformity can be found at [http://www.nokia.com/phones/declaration\\_of\\_conformity/](http://www.nokia.com/phones/declaration_of_conformity/).

**CE 0434**



The crossed-out wheeled bin means that within the European Union the product must be taken to separate collection at the product end-of-life. Do not dispose

of these products as unsorted municipal waste. For more information, see product Eco-Declaration or country specific information at [www.nokia.com](http://www.nokia.com).

© 2007 Nokia. All rights reserved.

Reproduction, transfer, distribution, or storage of part or all of the contents in this document in any form without the prior written permission of Nokia is prohibited.

Nokia and Nokia Connecting People are registered trademarks of Nokia Corporation. Other product and company names mentioned herein may be trademarks or tradenames of their respective owners.

Bluetooth is a registered trademark of Bluetooth SIG, Inc.

Nokia operates a policy of ongoing development. Nokia reserves the right to make changes and improvements to any of the products described in this document without prior notice.

Under no circumstances shall Nokia be responsible for any loss of data or income or any special, incidental, consequential or indirect damages howsoever caused.

The contents of this document are provided "as is". Except as required by applicable law, no warranties of any kind, either express or implied, including, but not limited to, the implied warranties of merchantability and fitness for a particular purpose, are made in relation to the accuracy, reliability or contents of this document. Nokia reserves the right to revise this document or withdraw it at any time without prior notice.



**ENGLISH**



The availability of particular products may vary by region. Please check with your Nokia dealer for details.  
Unauthorized changes or modifications to this device may void the user's authority to operate the equipment.

**Export Controls**  
This device may contain commodities, technology or software subject to export laws and regulations from the US and other countries. Diversion contrary to law is prohibited.

**Introduction**

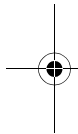

The Nokia Bluetooth Headset BH-201 allows you to make and receive calls while on the move. You can use the headset with compatible phones that support Bluetooth wireless technology.

Read this user guide carefully before using the headset. Also read the user guide for your phone, which provides important safety and maintenance information. Keep all accessories and enhancements out of the reach of small children.

**Bluetooth wireless technology**

Bluetooth wireless technology allows you to connect compatible devices without cables. The phone and the headset do not need to be in line of sight, but they should be within 10 meters (30 feet) of each other. Connections may be subject to interference from obstructions, such as walls, or other electronic devices.

The headset complies with the Bluetooth Specification 2.0 + EDR that supports the Headset Profile 1.1 and Hands-Free Profile 1.5. Check with the manufacturers of other

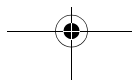
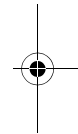



ENGLISH



devices to determine their compatibility with this headset.

There may be restrictions on using Bluetooth technology in some locations. Check with your local authorities or service provider.

Get started

The headset contains the following parts shown on the title page: earpiece wheel (1), charger connector (2), indicator light (3), microphone (4), power key (5), volume key (6), strap lock (7), and answer/end key (8).

Before using the headset, you must charge the battery and pair the headset with a compatible phone.

Parts of the headset are magnetic. Metallic materials may be attracted to the headset. Do not place credit cards or other magnetic storage media near the headset, because information stored on them may be erased.

Chargers

Check the model number of any charger before using it with this headset. The headset is intended for use with the AC-3, AC-4, and DC-4 chargers.



Warning: Use only chargers approved by Nokia for use with this particular headset.

The use of any other types may invalidate any approval or warranty and may be dangerous.

For availability of approved enhancements, please check with your dealer. When you disconnect the power cord of any enhancement, grasp and pull the plug, not the cord.

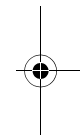
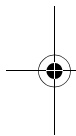

**ENGLISH**

**Charge the battery**

The headset has an internal, nonremovable, rechargeable battery. Do not attempt to remove the battery from the headset, as you may damage the headset.

1. Connect the charger to a wall outlet.
2. Connect the charger cable to the charger connector on the headset. The red indicator light is on while charging. It may take a while before charging starts. If charging does not start, connect the charger again and retry. Charging the battery fully may take up to 2 hours.
3. When the battery is fully charged, the red indicator light turns off. Disconnect the charger from the headset and the wall outlet.

The fully charged battery has power for up to 5 hours and 30 minutes of

talk-time or up to 150 hours of standby time. However, the talk and standby times may vary when the headset is used with different mobile phones or other compatible Bluetooth devices, usage settings, usage styles, and environments.

When battery power is low, the headset sounds a series of beeps, and the red indicator light starts to flash.

**Switch the headset on or off**

To switch on, press and hold the power key until the green indicator light starts to flash.

To switch off, press and hold the power key until the red indicator light is displayed briefly.

**Pair the headset**

1. Switch on your phone and the headset.



## ENGLISH



2. Activate the Bluetooth feature on the phone, and set the phone to search for Bluetooth devices.
3. Select the headset from the list of found devices.
4. Enter the Bluetooth passcode 0000 to pair and connect the headset to your phone. In some phones you may need to make the connection separately after pairing. You only need to pair the headset with your phone once.

If the pairing is successful, the headset beeps and appears in the phone menu where you can view the currently paired Bluetooth devices.

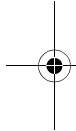

## Basic use

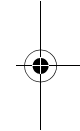

### Place the headset on your ear

The adjustable earpiece wheel helps you keep the headset securely in the ear. Rotate the earpiece wheel into the most suitable and comfortable position for your ear (10).

For example, if you use the headset on the right ear, you may need to rotate the wheel to the right for the best fit. Insert the earpiece into your ear in a secure and comfortable position, and

point the headset toward your mouth (11).

### Wear the headset

You can wear the headset on your neck using the supplied strap. To fix the headset to the strap, attach the shorter part of the strap (with the lock) to the headset (12), and attach the longer part to the lock (13). To release the strap, pull it from the lock.





**ENGLISH**



**Change the earbud**

The headset may be supplied with earbuds in different sizes. To change the earbud, pull the current earbud from the headset (9), and push the new earbud into place, with the wider end first.

To answer or end a call, press the answer/end key. To reject an incoming call, press the answer/end key twice. To switch the call between the headset and a compatible phone, press and hold the answer/end key. To adjust the headset volume, press the volume key up or down.

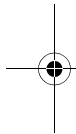

**Call handling**

To make a call, use your phone in the normal way when the headset is connected to your phone. If your phone supports last number redialing with the headset, press the answer/end key twice briefly when no call is in progress. If your phone supports voice dialing with the headset, press and hold the answer/end key when no call in progress, and proceed as described in the user guide of your phone.

**Clear the settings or reset the headset**

To clear the settings, press and hold the power key and the answer/end key over 10 seconds. To reset the headset if it does not function properly, although it is charged, plug the headset into a charger, and press the power key and the answer/end key at the same time.

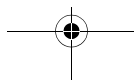
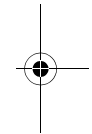



ENGLISH



### Battery information

Your headset is powered by a rechargeable battery. The battery can be charged and discharged hundreds of times, but it will eventually wear out. Recharge your battery only with Nokia approved chargers designated for this headset.

Unplug the charger from the electrical plug and the headset when not in use. Do not leave a fully charged battery connected to a charger, since overcharging may shorten its lifetime. If left unused, a fully charged battery will lose its charge over time.

Never use any charger that is damaged.

Leaving the headset in hot or cold places, such as in a closed car in summer or winter conditions, will reduce the capacity and lifetime of the battery.

Always try to keep the battery between 15°C and 25°C (59°F and 77°F). A headset with a hot or cold battery may not work temporarily, even when the battery is fully charged. Battery performance is particularly limited in temperatures well below freezing.

Do not dispose of batteries in a fire as they may explode. Batteries may also explode if damaged. Dispose of batteries according to local regulations. Please recycle when possible. Do not dispose as household waste.

### Care and maintenance

Your device is a product of superior design and craftsmanship and should be treated with care. The following

suggestions will help you protect your warranty coverage.





ENGLISH

- Keep the device dry. Precipitation, humidity, and all types of liquids or moisture can contain minerals that will corrode electronic circuits. If your device does get wet, allow it to dry completely.
- Do not use or store the device in dusty, dirty areas. Its moving parts and electronic components can be damaged.
- Do not store the device in hot areas. High temperatures can shorten the life of electronic devices, damage batteries, and warp or melt certain plastics.
- Do not store the device in cold areas. When the device returns to its normal temperature, moisture can form inside the device and damage electronic circuit boards.
- Do not attempt to open the device.
- Do not drop, knock, or shake the device. Rough handling can break internal circuit boards and fine mechanics.
- Do not use harsh chemicals, cleaning solvents, or strong detergents to clean the device.
- Do not paint the device. Paint can clog the moving parts and prevent proper operation.

All of the above suggestions apply equally to your device, battery, charger, or any enhancement. If any device is not working properly, take it to the nearest authorized service facility for service.

### FCC/Industry Canada notice

This device complies with Part 15 of the FCC Rules. Operation is subject to the following two conditions: 1. This device may not cause harmful interference; and 2. This device must accept any interference received, including interference that may cause undesired operation. This equipment has



**ENGLISH**



been tested and found to comply with the limits for a Class B digital device, pursuant to Part 15 of the FCC Rules. These limits are designed to provide reasonable protection against harmful interference in a residential installation. This equipment generates, uses and can radiate radio frequency energy and, if not installed and used in accordance with the instructions, may cause harmful interference to radio communications. However, there is no guarantee that interference will not occur in a particular installation. If this equipment does cause harmful interference to radio or television reception, which can be determined by turning the equipment off and on, the user is encouraged to try to correct the interference by one or more of the following measures: Reorient or relocate the receiving antenna. Increase the separation between the equipment and receiver. Connect the equipment into an outlet on a circuit different from that to which the receiver is connected. Consult the dealer or an experienced radio/TV technician for help.

NOTE: FCC Radiation Exposure Statement: This equipment complies with FCC radiation exposure limits set forth for an uncontrolled

environment. This transmitter must not be co-located or operating in conjunction with any other antenna or transmitter. NOTE: Changes or modifications not expressly approved by Nokia could void the user's authority to operate the equipment.

