

**Microtek  
ScanMaker V6USL  
User's Manual**

**(for Windows)**

English

**Copyright © 1999 by Microtek International, Inc.**

All rights reserved.

Deutsch

### Trademarks

Microtek, ScanMaker, and ScanWizard are trademarks of Microtek International, Inc. IBM PC is the trademark of International Business Machines Corporation. Windows and MS-DOS are trademarks of Microsoft Corporation. Other product or company names are trademarks or registered trademarks of their respective holders.

Français

### Important

Documents that you scan may be protected under copyright law. The unauthorized use of such documents could be a violation of the rights of the copyright holder. Microtek bears no responsibility for the unauthorized use of copyrighted materials.

Doc. No. I49-002195, A

#### Microtek Lab, Inc.

3715 Doolittle Drive  
Redondo Beach, CA 90278-1226  
Main: 310-297-5000 Sales: 800-654-4160  
FAX: 310-297-5050 BBS: 310-297-5102  
Technical Support: 310-297-5151  
AutoTech fax back system: 310-297-5101  
<http://www.microtekusa.com>

#### Microtek International, Inc.

6, Industry East Road 3  
Science Based Industrial Park  
Hsinchu, 30077, Taiwan, R.O.C.  
TEL: 886-3-5772155  
FAX: 886-3-5772598

#### Microtek Europe B.V.

Max Euwelaan 68  
NL-3062 MA Rotterdam  
The Netherlands  
TEL: 31-10-2425688  
FAX: 31-10-2425699

### Federal Communications Commission (FCC) Statement

This equipment (Trade name: ScanMaker V6USL, Model name: MRS-1200V6US) has been tested and found to comply with the limits for a Class B digital device, pursuant to Part 15 of the FCC Rules. These limits are designed to provide reasonable protection against harmful interference in a residential installation. This equipment generates, uses and can radiate radio frequency energy and, if not installed and used in accordance with the instructions, may cause harmful interference to radio communications. However, there is no guarantee that interference will not occur in a particular installation. If this equipment does cause harmful interference to radio or television reception, which can be determined by turning the equipment off and on, the user is encouraged to try to correct the interference by one or more of the following measures:

- Reorient/relocate the receiving antenna.
- Increase the separation between the equipment and receiver.
- Connect the equipment into an outlet on a circuit different from that to which the receiver is connected.
- Consult the dealer or an experienced radio/TV technician for help.

FCC Caution: To assure continued compliance, (example — use only shielded interface cables when connecting to computer or peripheral devices). Any changes or modifications not expressly approved by the party responsible for compliance could void the user's authority to operate this equipment.

This device complies with Part 15 of the FCC Rules. Operation is subject to the following two conditions: (1) This device may not cause harmful interference, and (2) this device must accept any interference received, including interference that may cause undesired operation.

Responsible Party: Microtek Lab, Inc.  
3715 Doolittle Drive  
Redondo Beach, CA 90278-1226  
U.S.A.

Telephone No: (310) 297-5000

# Contents

<b>1</b>	<b>Introduction</b>	<b>1</b>
	Basic Requirements .....	1
<b>2</b>	<b>Before You Begin</b>	<b>2</b>
	Unpacking your scanner and checking components .....	2
<b>3</b>	<b>Installation under Windows 98 (USB Environment)</b>	<b>3</b>
	1. Verify the presence of USB .....	3
	2. Connect the scanner and install scanner software .....	3
	3. Test your scanner .....	6
	Troubleshooting .....	7
<b>4</b>	<b>Installation under Windows 95 (SCSI Environment)</b>	<b>9</b>
	1. Installing the interface card .....	9
	2. Checking interface card status .....	9
	3. Installing software .....	10
	Using the Manuals .....	10
	4. Resetting the scanner's SCSI ID if necessary .....	11
	5. Connecting the scanner .....	11
	6. Checking scanner status .....	12
	7. Testing your scanner .....	13
	Troubleshooting .....	14
<b>5</b>	<b>Installation under Windows 98 (SCSI Environment)</b>	<b>16</b>
	Troubleshooting .....	16
<b>6</b>	<b>Installation under Windows NT 4.0 (SCSI Environment)</b>	<b>19</b>
	1. Resetting the scanner's SCSI ID if necessary .....	19
	2. Installing the interface card .....	19
	3. Checking your Windows NT configuration .....	19
	4. Installing software .....	20
	5. Connecting the scanner .....	20
	6. Testing your scanner .....	20
	Troubleshooting .....	21
<b>7</b>	<b>Miscellaneous</b>	<b>22</b>
	Performing the Power-on Test .....	22
	Returning your scanner for repair .....	22
	Lamp Replacement .....	22

English

Deutsch

Français

English

Deutsch

Français

<b>8</b>	<b>Components</b>	<b>23</b>
<b>9</b>	<b>Specifications</b>	<b>25</b>
	<b>Important Notes</b>	<b>26</b>
	Choose only one interface .....	26
	Power up notice .....	26

## Introduction

An image scanner is a device that captures and converts illustrations, graphics, photographs, or text into electronic files that can be edited or enhanced and then incorporated in printed documents or multimedia presentations.

The single-pass, 36-bit, high-resolution ScanMaker V6USL has been specifically designed and engineered for the discriminating scanner user, who demands rich, detailed images suitable for any prepress or multimedia need.

The ScanMaker V6USL color flatbed scanner scans reflective originals, but also features media interface, allowing you to upgrade for scanning 35mm positive or negative film in a variety of industry-standard formats.

The ScanMaker V6USL is a dual-interface scanner which supports two widely used interfaces -- USB and SCSI. Choose either of them to connect with your computer for scan. If you are running Pentium computer with a built-in USB interface under Windows 98, it is best to choose USB. If you have installed SCSI card, in your computer, SCSI interface supports full-range of Windows family (i.e., Windows 95, Windows 98, and NT 4.0) for your ease of scan.

The ScanMaker V6USL includes 36-bit throughput capability for delivering images with more image data than 30- or 24-bit scanner are capable of capturing, superior optics and hardware components, as well as Microtek ScanWizard scanner controller software.

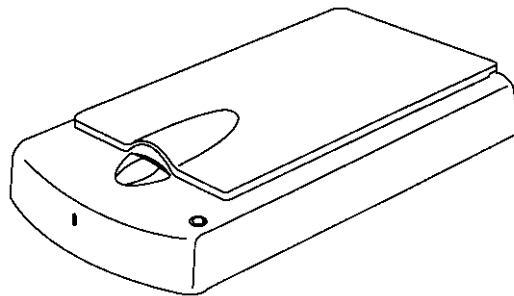

### Basic Requirements

- Pentium or compatibles
- Microsoft Windows 95, 98, or NT4.0
- CD-ROM drive (internal or external)
- At least 32MB RAM; 64MB is recommended
- At least 100MB available hard disk space
- Super VGA Color display with 256 colors or better

English

Deutsch

Français

English

Deutsch

Français

## Before You Begin

### Unpacking your scanner and checking components

Open your scanner package and check the components as stated in your packing list. If any component is missing, call Microtek Sales.

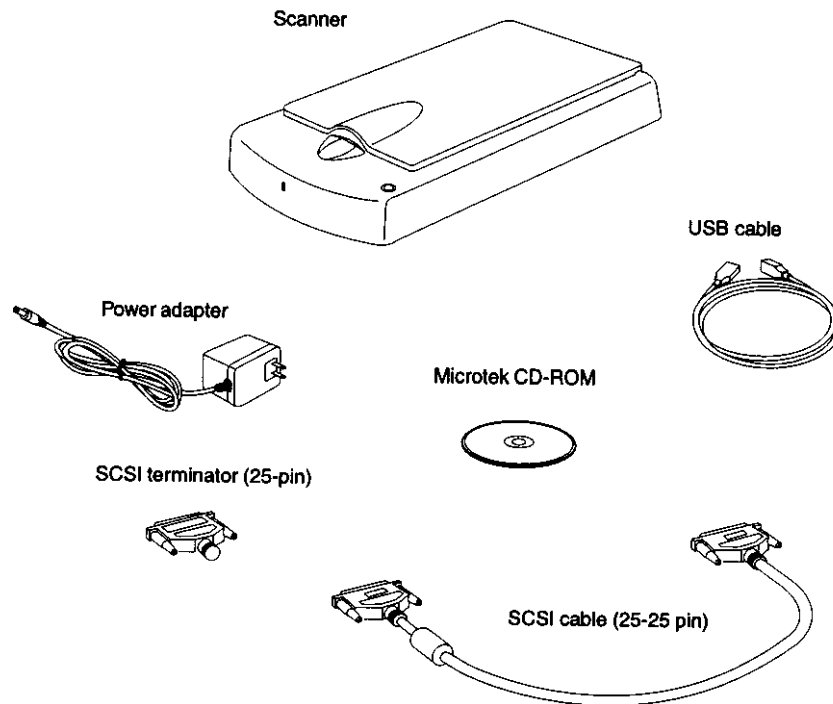

**Note:** The SCSI interface card is not included with your scanner package. For purchase, contact Microtek.

## Installation under Windows 98 (USB Environment)

To install under Windows 98, take the steps below:

1. Verify the presence of USB
2. Connect the scanner and install scanner software
3. Test your scanner

### 1. Verify the presence of USB

Turn on your computer and check to see if USB is implemented.

Visually inspect the USB ports of your computer.

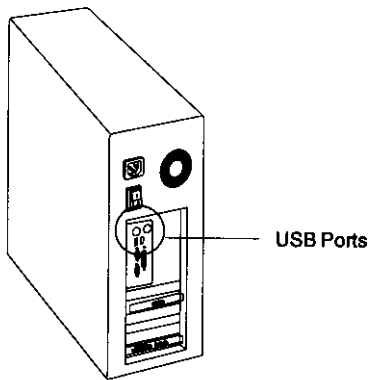

If you cannot find the USB ports at the back of your computer, read the documentation that came with your computer main board.

#### For computer main board with USB supported:

To enter BIOS settings and enable USB, see the documentation that came with your computer. Normally when the computer power is turned on, before starting Windows 98, the computer will hint you to press some keys for displaying BIOS menu.

#### For computer main board without USB supported:

In this case, USB can be implemented by an USB add-on card. The BIOS settings for main board type USB are not required.

### 2. Connect the scanner and install scanner software

1. Connect the scanner to your computer, using the USB cable that provided in the scanner package.

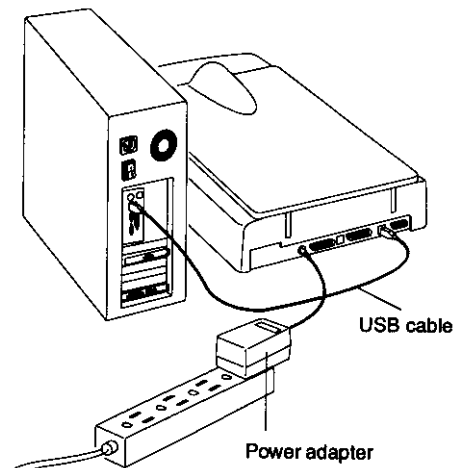

2. Plug the power adapter to the power connector at the back panel of the scanner, and plug the other end of the power adapter to your AC power source at wall outlet.

Your scanner automatically turns on when the power adapter is connected. The scanner has no power switch. The green light on the front of the scanner will start flashing, and after a few seconds, will remain on solid.

English

Deutsch

Français

English

Deutsch

Français

- An Unknown Device message appears, asking you to search a new device.

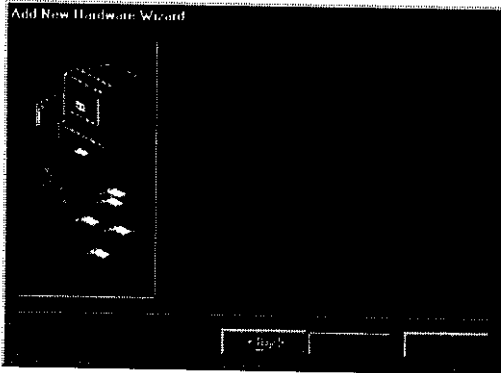

Click **Next** to continue.

- Click "Search for the best driver for your device (Recommended)." to start searching.

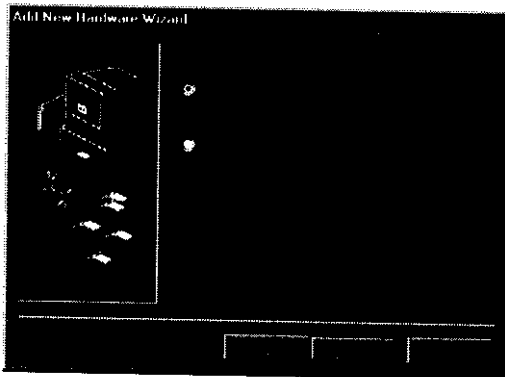

- Insert the Microtek CD-ROM into your CD-ROM drive.

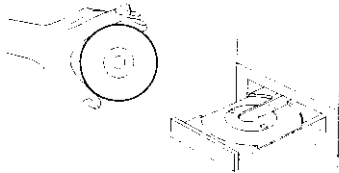

- From the "Add New Hardware Wizard" dialog box, click "Next" to display the following screen.

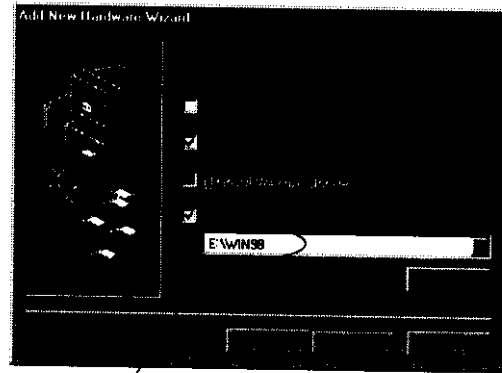

Letter "E" indicates the location of your CD-ROM drive.

On the above screen, E:\ indicates the default CD-ROM drive location. Click Browse if your CD-ROM drive is elsewhere. Click Next to continue.

- Your scanner is automatically detected. Click Next to continue.

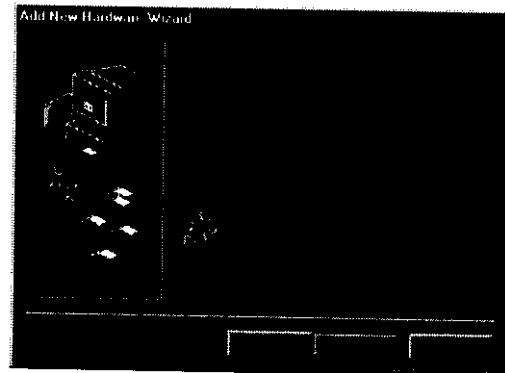



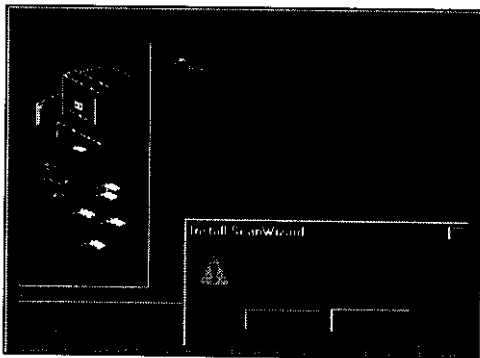

Click OK to prepare installing ScanWizard driver program.

- The screen shows you the **setup.exe** program in your Windows directory. You should **NOT** click on the OK button at this time. Instead, click the **Drives** selection to choose the CD-ROM.

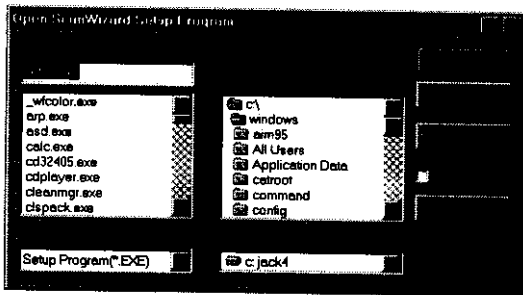

- Locate the correct **setup.exe** program, which is under **E:\Scanwiz\Disk1** directory.

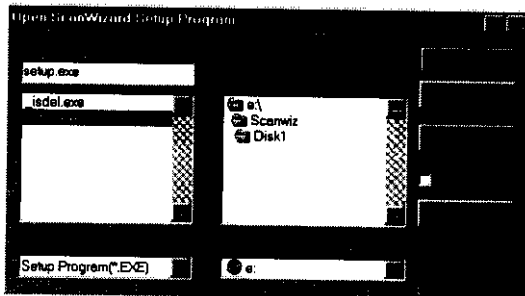

- Click OK to continue.

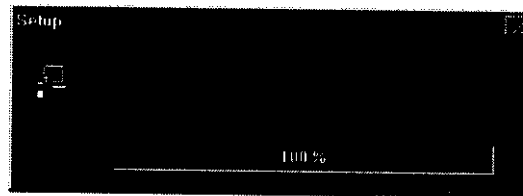

ScanWizard Installation has begun.

Microtek ScanWizard is the Twain driver used for the scanner to communicate with various applications. ScanWizard cannot be used by itself and requires another program in order to work.

Follow screen instructions to complete installation. When installation is complete, **Microtek ScanWizard for Windows** appears as a folder on the **Programs** menu.

- Install application programs

Install each application software by clicking on the individual program options.

- Install documentation reader

Click **Adobe Acrobat Reader**, then follow screen instructions until installation is complete. Acrobat Reader is available for reading the manuals on your CD-ROM.

English

Deutsch

Français

English

Deutsch

Français

### 3. Test your scanner

1. Restart Windows 98. Click **Start**, **Settings**, and select **Control Panel**.
2. Double-click on the **System** icon in Control Panel, then select **Device Manager** from the top.
3. Double-click on "Imaging Device", you can find "Microtek ScanMaker V6USL" is listed. The scanner is ready to scan.

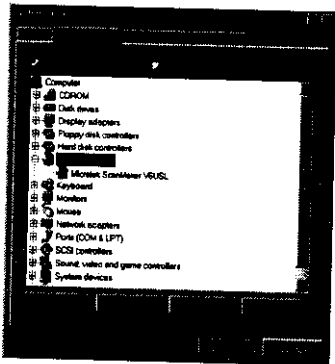

4. Start up **Scanner Test** from the **Microtek ScanWizard for Windows** folder in the **Programs** menu. When started up successfully, the screen below appears.

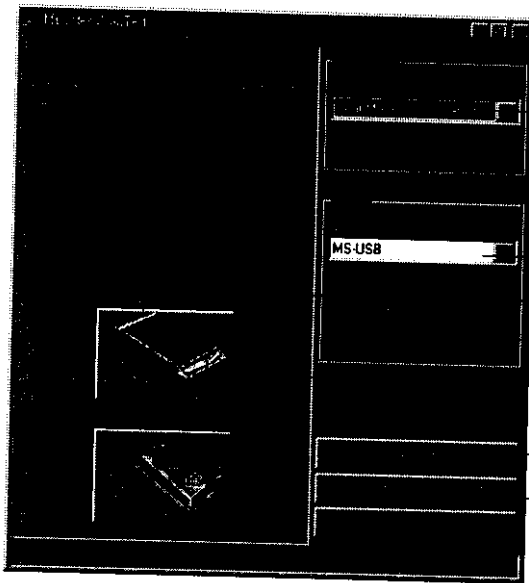

5. Place a reflective document with faced down on the scanner glass. Center the top of the document along the horizontal ruler on the scanner.

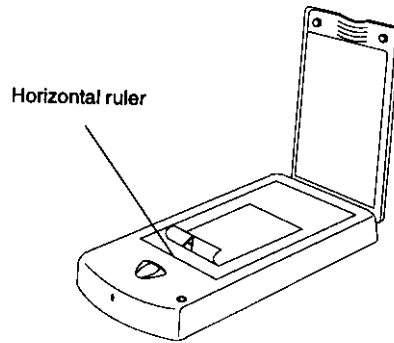

6. Click the **Flatbed** button on the Microtek ScanTest program screen. A preview of your image will be displayed in the Microtek ScanTest window. This indicates the Scanner Test was successful and that the scanner is now ready to be used.
7. Close and exit Microtek Scanner Test.

For more details on how to operate your scanner with ScanWizard, refer to the file *ScanWizard.pdf* in the folder *Manuals* on the CD-ROM.

The **Scanner Model** shows the scanner connected to your computer along with the scanner ID.

**Detected interface**

The **Flatbed** button is used for preview reflective material.

If 35TA is installed, the **TMA** button is used for preview 35mm transparency or negative material.

The **Scanner Check** acts as a scanner probe to verify the location of your scanner and check the scanner ID.

The **Reconfigure Equipment** allows the system to update its own internal reference file and is useful when you have changed your setup or reconfigured your system.

## Troubleshooting

If Windows 98 cannot detect USB device, follow the steps below.

1. Check to make sure the SCSI cable or terminator is disconnected to your scanner.
2. Restart Windows 98. Click **Start**, **Settings**, and select **Control Panel**.
3. Double-click on the **System** icon in Control Panel and select **Device Manager** from the top.
4. Double-click "Universal serial bus controller" to display two-line messages indicating the detected chipset info. For example, "Intel 82371AB PCI to USB Universal Host Controller" and "USB Root Hub".

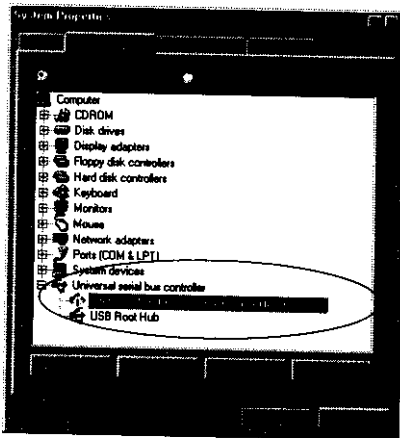

A yellow exclamation mark appears next to the message.

If a yellow exclamation mark appears in front of the "Intel 82371AB PCI to USB Universal Host Controller" string, this means the driver — Intel 82371 driver is not automatically installed.

For example, your computer is shown as the above figure. You have two solutions to approach:

### Solution A: Automatic setting

1. Select "Intel 82371AB PCI to USB Universal Host Controller".
2. Click the **Remove** button.
3. Restart Windows 98, your computer should be able to detect the presence of ScanMaker V6USL scanner.

### Solution B: Manual setting

1. Select "Intel 82371AB PCI to USB Universal Host Controller".
2. Click the **Remove** button.
3. To fix the problem, double-click the "Universal serial bus controller" string to display the following dialog box.

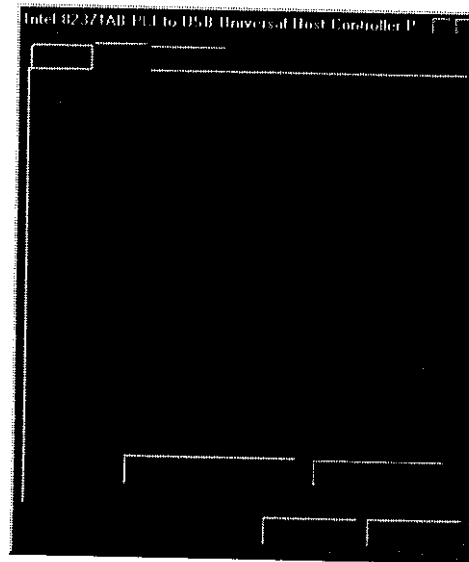

English

Deutsch

Français

English

Deutsch

Français

- 4. Click "Update Driver" to display the driver selection dialog box.

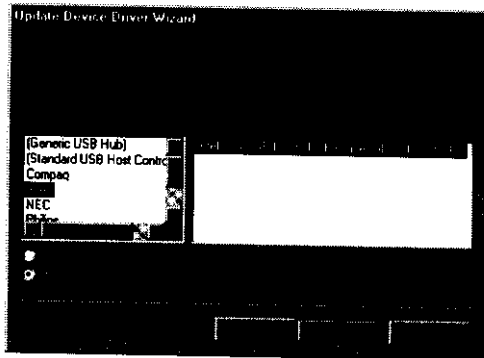

- 5. At the left column, select "Intel"; the message "Intel 82371AB PCI to USB Universal Host Controller" will appear at right column. Click **Finish** to exit.
- 6. Restart Windows 98, your computer should be able to detect the presence of ScanMaker V6USL scanner.

To check the availability of ScanMaker V6USL scanner:

**Option 1:** Check it by clicking the "Scanners and Cameras" icon in the Control Panel dialog box.

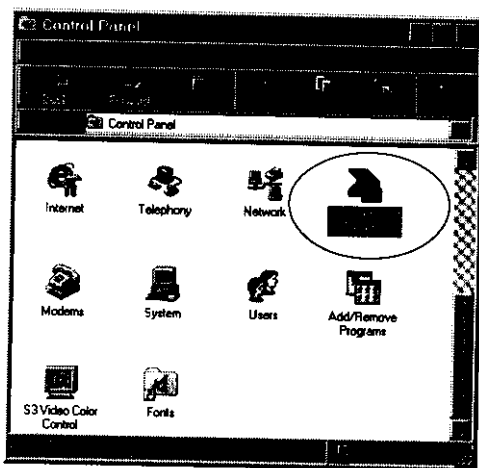

The detected scanner is displayed in the "Scanners and Cameras Properties" dialog box.

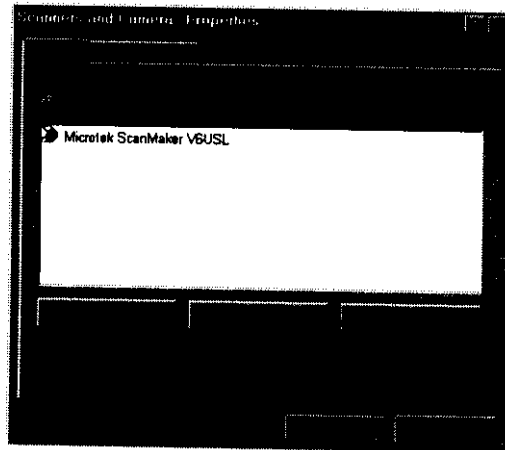

**Option 2:** Check it by clicking the "System" icon in the Control Panel dialog box. Then click the **Device Manager** tab. The detected scanner is displayed in the Image Device item.

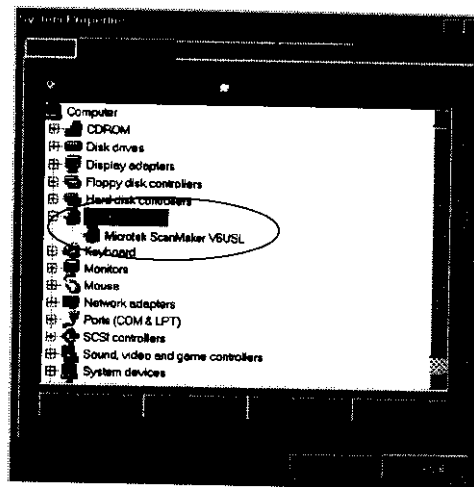

## Installation under Windows 95 (SCSI Environment)

English

Deutsch

Français

To install under Windows 95, take the steps below:

1. Install the interface card in your computer
2. Check the interface card status
3. Install software
4. Reset the scanner's SCSI ID if necessary
5. Connect the scanner and computer
6. Check the scanner status
7. Test your scanner

### 1. Installing the interface card

Before installing the interface card, make sure you turn off your computer and peripherals. Then follow the steps below:

1. Shut down your computer and unplug the power cord. Next, remove the cover from your computer.
2. Look for an available PCI card slot (typically white or ivory) in your computer, remove the slot cover, and insert the PCI SCSI card (e.g. Adaptec AVA-2902E) into the slot. Push the card in to make sure it's seated all the way in the slot.

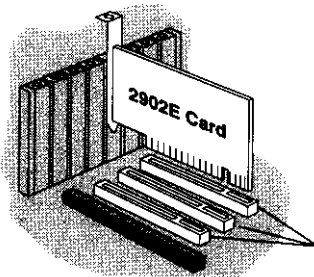

This is important, as an improper card connection will make you unable to use your scanner, and you will then have to remove the computer case and restart the card all over again.

3. Replace the cover of the computer, then plug the power cord back in.

### 2. Checking interface card status

When you run Windows 95, the Adaptec AVA-2902E SCSI adapter is detected and the driver is automatically installed. Make your Windows 95 CD-ROM ready for use. Some computers may prompt you to load Windows 95 software during your installing AVA-2902E driver. Follow steps below to check.

1. Turn on your computer, click **Start**, **Settings**, and select **Control Panel**.
2. Double-click on the **System** icon in Control Panel and select **Device Manager** from the top.
3. Double-click on "SCSI controllers" to display the screen below.

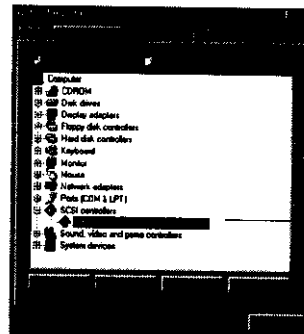

The result of the check is displayed here.

The message "Adaptec AIC-7850 PCI SCSI Controller" displays indicates that the driver is installed and the AVA-2902E interface card works properly.

If a conflict exists, either of the following will occur:

- a yellow exclamation mark appears next to the phrase:  
 **Adaptec AIC-7850 PCI SCSI Controller**
  - or -
  - nothing is listed under "SCSI Controllers".
- In either case, refer to the *Troubleshooting* section.

English

Deutsch

Français

### 3. Installing software

Insert the Microtek CD-ROM into your CD-ROM drive. The *Microtek Scanner Software* installer should come up automatically, and list the software available for you. Click on each software program in the order they appear on your screen to install all software components.

*Note: If the Microtek Scanner Software is not automatically displayed, click **Start**, select **Run** and type `e:\cdsetup` (where `e:` is your CD-ROM drive).*

#### Step 1 Install Microtek ScanWizard

ScanWizard is a Twain driver used for the scanner to work with various applications. ScanWizard cannot be used by itself and requires another program in order to work.

1. Click **Microtek ScanWizard**, then follow screen instructions to start installation.
2. During installation, choose "**Adaptec SCSI Interface Card**" option as your interface type.

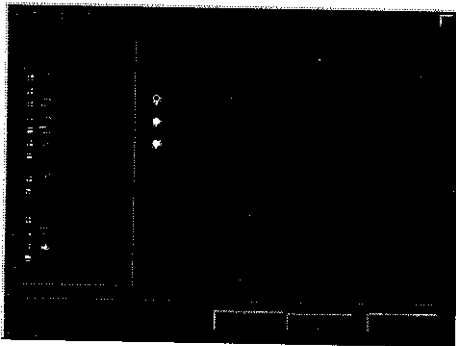

3. When installation is complete, the **Microtek ScanWizard for Windows 95** group appears as a folder in the Programs menu.

#### Step 2 Install software application

The bundled image editing, OCR, and other applications you receive depend on the scanner model you purchase. Click each option on the installer screen to install the software.

#### Step 3 Install Microtek DCR

DCR is Microtek's proprietary color calibration technology for use with Microtek color scanners. With DCR installed, your scanner is capable of capturing extremely accurate color images.

#### Step 4 Install documentation reader

Click **Adobe Acrobat Reader**, then follow screen instructions until installation is complete. Acrobat Reader is necessary for reading the manuals on your CD-ROM.

### Using the Manuals

Other documentations for your scanner are provided on the Microtek CD-ROM. To read the documents, you will be using the Adobe Acrobat Reader program, which is automatically launched when you open the file for the manuals.

To open the manuals: Go to *Manuals* folder, and locate the manual that you wish to view. Double-click on the file you want, and the manual is ready to be viewed or printed.

#### 4. Resetting the scanner's SCSI ID if necessary

This procedure is provided as a reference. You may or may not need to change the SCSI ID on your scanner.

A SCSI ID is a number assigned to each SCSI device in your daisy chain to differentiate the devices from one another. The SCSI ID for your Microtek scanner is factory-set to 6.

You won't need to change the SCSI ID on your scanner unless another SCSI device on your system (such as external hard drive, additional scanner, etc.) is using the same number.

Locate the SCSI ID switch, use a small screwdriver to turn the switch to the desired SCSI ID number.

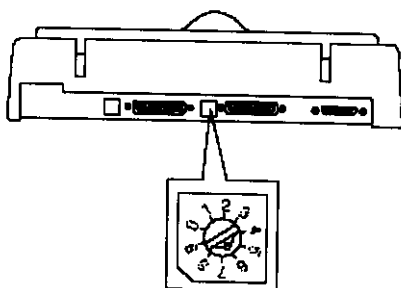

Valid SCSI ID numbers are 0 to 6. SCSI ID #7, #8 and #9 are also not used.

#### 5. Connecting the scanner

Before connecting the scanner to your computer, make sure the scanner driver (ScanWizard) is installed. Take the following steps to connect.

1. Shut down your computer.
2. Connect the card and the scanner, using the SCSI cable that provided in the scanner package. Make sure your computer are turned off when you perform the connection.

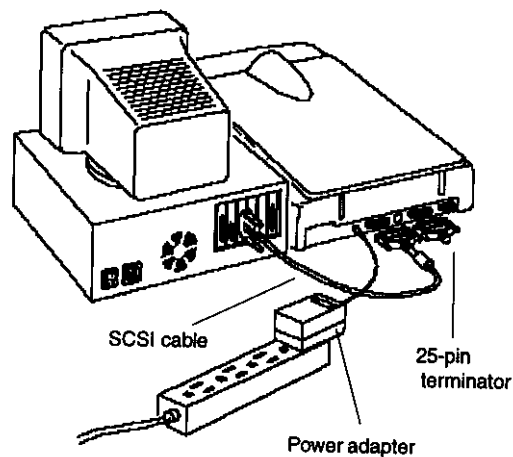

3. Plug the 25-pin terminator to another SCSI port.
  4. Plug the power adapter to the power connector at the back panel of the scanner, and plug the other end of the power adapter to your AC power source at wall outlet.
- Your scanner automatically turns on when the power adapter is connected. The scanner has no power switch. The green light on the front of the scanner will start flashing, and after a few seconds, will remain on solid.
5. Then power up your computer.

#### 4. Resetting the scanner's SCSI ID if necessary

This procedure is provided as a reference. You may or may not need to change the SCSI ID on your scanner.

A SCSI ID is a number assigned to each SCSI device in your daisy chain to differentiate the devices from one another. The SCSI ID for your Microtek scanner is factory-set to 6.

You won't need to change the SCSI ID on your scanner unless another SCSI device on your system (such as external hard drive, additional scanner, etc.) is using the same number.

Locate the SCSI ID switch, use a small screwdriver to turn the switch to the desired SCSI ID number.

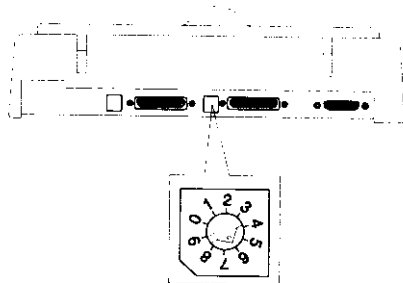

Valid SCSI ID numbers are 0 to 6. SCSI ID #7, #8 and #9 are also not used.

#### 5. Connecting the scanner

Before connecting the scanner to your computer, make sure the scanner driver (ScanWizard) is installed. Take the following steps to connect.

1. Shut down your computer.
2. Connect the card and the scanner, using the SCSI cable that provided in the scanner package. Make sure your computer are turned off when you perform the connection.

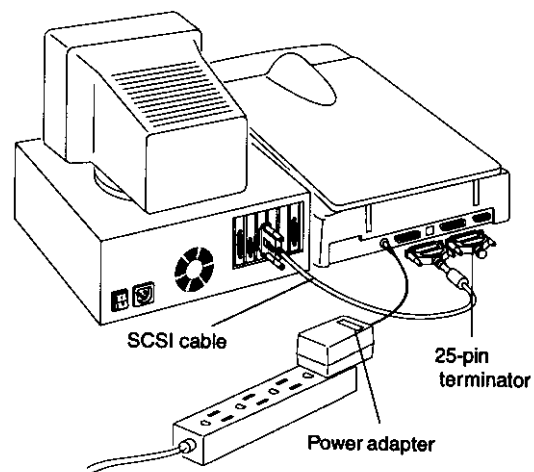

3. Plug the 25-pin terminator to another SCSI port.
4. Plug the power adapter to the power connector at the back panel of the scanner, and plug the other end of the power adapter to your AC power source at wall outlet.

Your scanner automatically turns on when the power adapter is connected. The scanner has no power switch. The green light on the front of the scanner will start flashing, and after a few seconds, will remain on solid.

5. Then power up your computer.

English

Deutsch

Français



## 6. Checking scanner status

When running Windows, **ALWAYS** turn on the scanner before the computer. If you don't, Windows will not be able to "see" your scanner.

1. Click **Start, Settings**, and select **Control Panel**.
2. Double-click on the **System** icon in Control Panel and select **Device Manager** from the top.
3. The screen that appears displays the message "Microtek Scanners". Double-click it, the scanner model you connected shows under it.

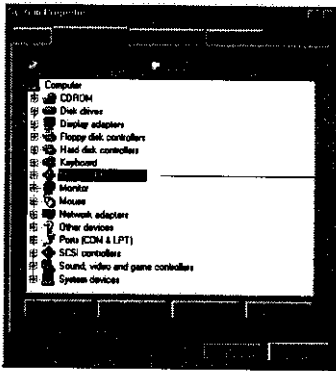

The message "Microtek Scanners" displays, indicating the scanner is installed.

If your system can't find your scanner, maybe SCSI conflict happens between your scanner and other SCSI device. To resolve the conflict, refer to *Troubleshooting* on page 14.

## Terminator



A Terminator is a piece of electrical equipment installed at the end of a SCSI chain to ensure that electrical impulses are properly routed.

You probably won't need a terminator for your installation, but because of varying SCSI standards, there is no way to predict with absolute certainty whether or not you need one.

You will need a terminator in the following instances:

- If you get odd symptoms after hooking up your PC and scanner (such as communication errors during scanning, in which your scanner can't be "seen" by your computer), or if your PC refuses to boot up properly after you installed the scanner.
- If you are hooking up your PC in a daisy chain to two or more SCSI devices (such as your scanner and a CD-ROM drive). In this case, the terminator should be on the last SCSI device in the daisy chain.

Take note that in a daisy-chain connection, different drivers come into play and complicated configurations may result. If you are not familiar with the procedure for daisy chaining, consult a technician on how to do this. Microtek bears no responsibility for damages that may occur to peripherals due to inexperienced handling.

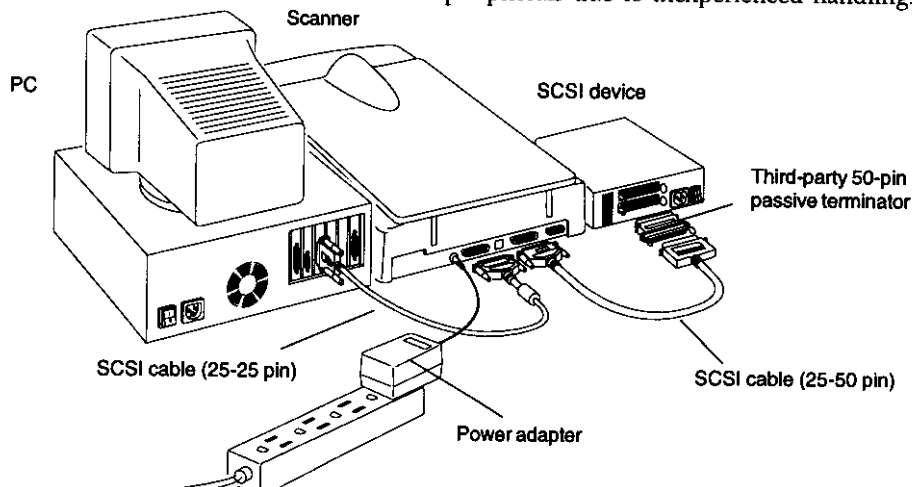

## 7. Testing your scanner

1. Restart Windows 95. Before you restart the computer, make sure your scanner is on and ready.
2. Click Start, Programs, Microtek ScanWizard for Windows 95, and then select Scanner Test.

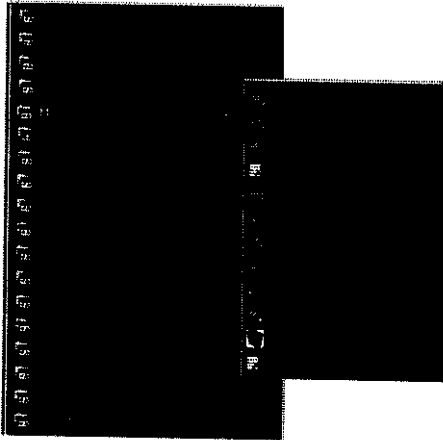

3. When started up successfully, the screen below appears.

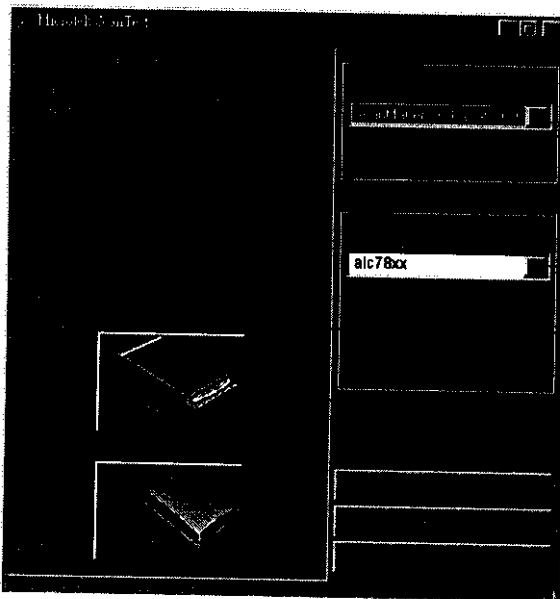

4. Place a reflective document with faced down on the scanner glass. Center the top of the document along the horizontal ruler on the scanner.

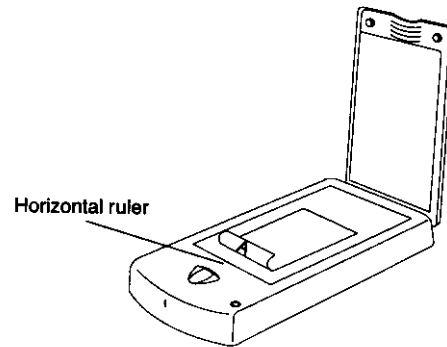

5. Click the **Flatbed** button on the Microtek ScanTest program screen. A preview of your image will be displayed in the Microtek ScanTest window. This indicates the Scanner Test was successful and that the scanner is now ready to be used.
6. Close and exit Microtek Scanner Test program.

For more details on how to operate your scanner with ScanWizard, refer to the file *ScanWizard.pdf* in the folder *Manuals* on the CD-ROM.

The **Scanner Model** shows the scanner connected to your computer along with the scanner's SCSI ID.

The "aic78xx" message indicates you are using Adaptec SCSI interface card.

The **Flatbed** button is used for preview reflective material.

If 35TA is installed, the **TMA** button is used for preview 35mm transparency or negative material.

The **Scanner Check** acts as a scanner probe to verify the location of your scanner and check the scanner ID.

The **Reconfigure Equipment** allows the system to update its own internal reference file and is useful when you have changed your setup or reconfigured your system.

English

Deutsch

Français

## Troubleshooting

After installing the interface card in your computer and connecting the scanner, you may find yourself unable to use the scanner. This is usually due to any of the situations described below:

**Situation A** Your interface card is not properly seated in the PCI card slot on your computer.

**Situation B** Your interface card conflicts with another device.

**Situation C** Windows 95 can not recognize your interface card.

**Situation D** If your interface card and scanner do not seem to be working properly.

See details below for resolving the individual situations above.

### Resolving situation A

Power down your computer, remove the AVA-2902E interface card from your computer. Then re-install it, make sure the card is seated all the way in and secured into the PCI card slot. The PCI card slot normally appears in white or ivory.

### Resolving situation B

1. Click **Start**, **Settings**, and select **Control Panel**.
2. Double-click on the **System** icon in Control Panel and select **Device Manager** from the top.
3. Double-click on "SCSI controllers" to display the dialog box below.

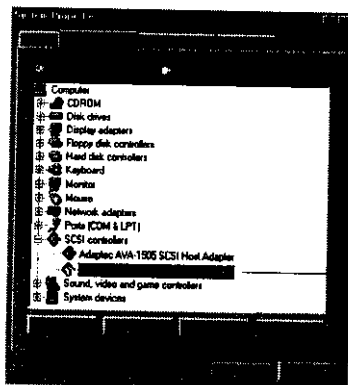

A yellow exclamation mark appears next to the message "Adaptec AIC-7850 PCI SCSI Controller".

4. Click on the **Adaptec AIC-7850 PCI SCSI Controller** option, and then click **Properties**.
5. Select **Resources** from the top. The dialog box gives you information about the Interrupt Request (IRQ) and Input/Output (I/O) address settings, including whether a conflict happens.
6. If a conflict exists in Input/Output option, then click **Change Setting**. Use the Up/Down arrow keys to select a different range.

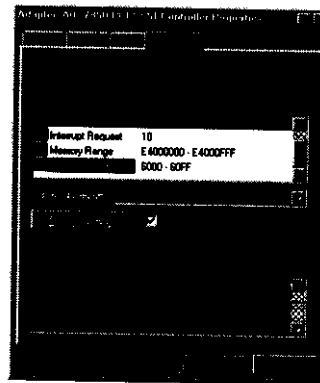

If conflicts happen, the message shows here. Currently no conflicts happen.

7. Next, select the Interrupt/Request option, click **Change Setting**, and use the Up/Down arrow keys to select different IRQ number. If all IRQs are taken, you need to contact your dealer or computer manufacturer to help on how to free up an IRQ in this range.

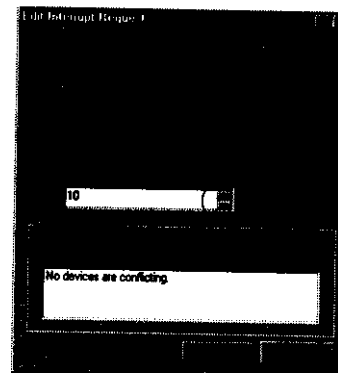

Click the Up/Down arrow buttons to select IRQ.

- When all the settings are correct, click **OK** to save the modifications. The dialog box should now show the correct Interrupt Request and Input/Output address settings. If you're asked to shut down your computer, select **No**, then click **Close**. You will be asked whether you wish to restart your computer. Click **Yes** and restart your computer.

### Resolving situation C

- Click **Start, Settings**, and select **Control Panel**.
- Double-click **Add New Hardware**.
- Click **Next** and select **No** for "Do you want Windows to search for your new hardware?".
- From the next menu, select **SCSI controllers** and click **Next**.

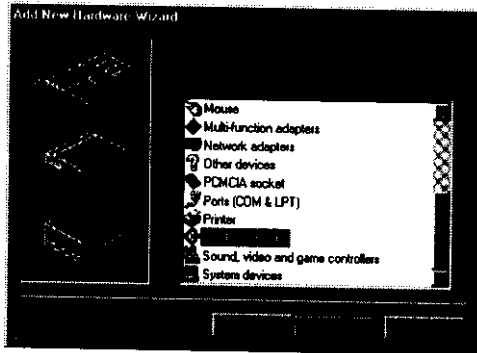

- Select **Adaptec** on the left and "Adaptec AHA-294X/AIC-78XX PCI SCSI Controller" on the right. Click **Next**.

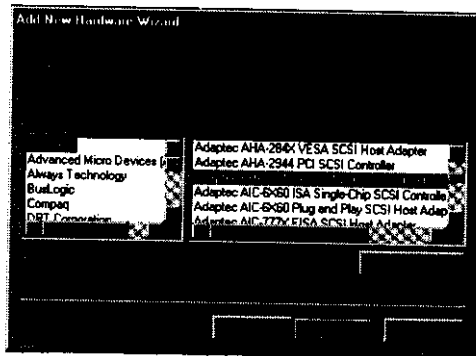

- In the next menu, make a note of the Input/Output (I/O) range setting, as well as Interrupt Request (IRQ) number that Windows recommends you.

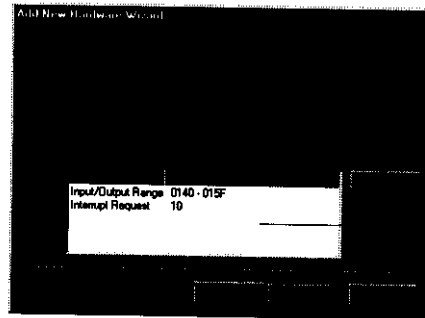

Write this message down on a piece of paper for handy reference.

- When the "Add New Hardware Wizard" dialog box appears, click **Finish**.
- Continue until the installation is completed. Windows 95 will then ask if you want to shut down your computer. Select **No**.
- Click **Start, Settings**, and select **Control Panel**.
- Double-click on the **System** icon in Control Panel and select **Device Manager** from the top.
- Double-click on "SCSI controllers" to check whether conflict happens.

If conflict exists, following the steps of *Resolving Situation B* (see page 14) to reset it.

- When all settings are correct, click **OK** to save the modifications. The dialog box should now show the correct Interrupt Request and Input/Output address settings. If you're asked to shut down your computer, select **No**, then click **Close**. You will be asked whether you wish to restart your computer. Click **Yes** and restart your computer.

### Resolving situation D

See the section *Technical Tips of Installation Guide* that came with your AVA-2902E interface card.

English

Deutsch

Français

## Installation under Windows 98 (SCSI Environment)

Windows 95 and 98 installation is very similar...Windows 98 just makes it easier to install your interface card and software.

1. Install the AVA-2902E interface card  
(Refer to Step 1 on page 9)

*Note: Windows 98 should automatically detect your new hardware and install the proper drivers, upon restarting your computer.*

2. Check interface card status  
(Refer to Step 2 on page 9)

*Note: If a conflict exists, refer to "Troubleshooting" on this page.*

3. Install your software  
(Refer to Step 3 on page 10)
4. Reset the scanner's SCSI ID if necessary  
(Refer to Step 4 on page 11)
5. Connect the scanner  
(Refer to Step 5 on page 11)
6. Test your scanner  
(Refer to Step 7 on page 13)

## Troubleshooting

After installing the interface card in your computer and connecting the scanner, you may find yourself unable to use the scanner. This is usually due to any of the situations described below:

- Situation A** Your interface card is not properly seated in the PCI card slot on your computer.
- Situation B** Your interface card conflicts with another device.
- Situation C** Windows 98 cannot recognize your interface card.
- Situation D** If your interface card and scanner do not seem to be working properly.

See details below for resolving the individual situations.

### Resolving situation A

Power down your computer, remove the AVA-2902E interface card from your computer. Then re-install it, make sure the card is seated all the way in and secured into the PCI card slot. The PCI card slot normally appears in white or ivory.

### Resolving situation B

1. Click **Start, Settings**, and select **Control Panel**.
2. Double-click on the **System** icon in Control Panel and select **Device Manager** from the top.
3. Double-click on "SCSI controllers" to display the dialog box below.

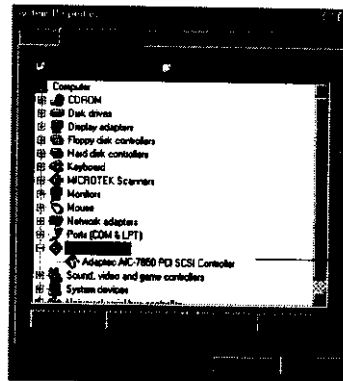

A yellow exclamation mark appears next to the message "Adaptec AIC-7850 PCI SCSI Controller".

4. Click on the **Adaptec AIC-7850 PCI SCSI Controller** option, and then click **Properties**.

5. Select Resources from the top. The dialog box gives you information about the 3 resources: Interrupt Request (IRQ), Memory Range, and Input/Output range. Any conflict in the 3 resources is detected and displayed in the "Conflicting device list".
6. To resolve the conflict, uncheck "Use automatic settings", then click to modify the individual resource, one after another, until the message "No conflicts" appears in the Conflicting device list.

For example, to resolve the Memory Range conflict, take these steps:

- a) At the Resource type, double-click on the Memory Range string, the Edit Memory Range dialog box is displayed.

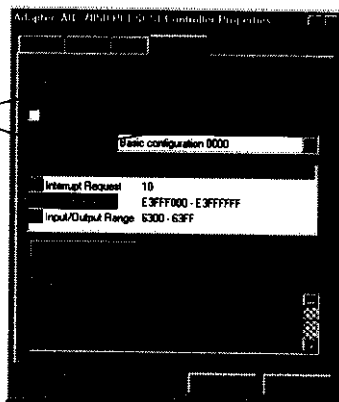

Uncheck "Use automatic settings" first.

If conflict happens, the message shows here.

- b) At the Value entry, use the Up/Down arrow keys to select a different range.

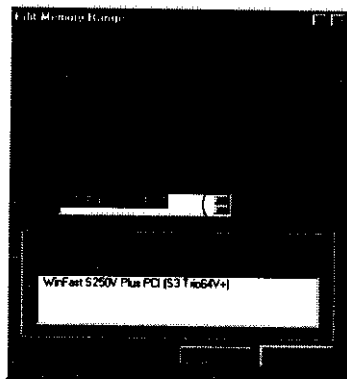

Click the Up/Down arrow buttons to select different range.

7. When you get a "No conflicts" message is in the Conflicting device list, the Memory Range conflict is resolved. Take the similar procedures on the Interrupt Request (IRQ) and Input/Output Range resources. If all of IRQs are taken, you need to contact your computer dealer to help on how to free up an IRQ for you.

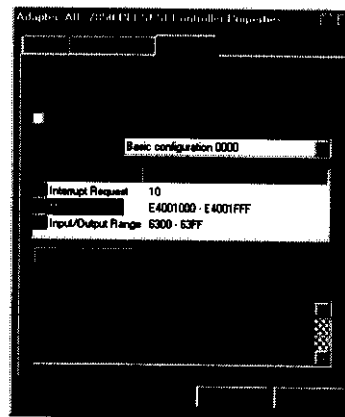

Currently no conflicts happen.

8. When the settings are all correct, click OK to save the modifications. The dialog box should now show the correct Interrupt Request, Memory Rang, and Input/Output address settings.

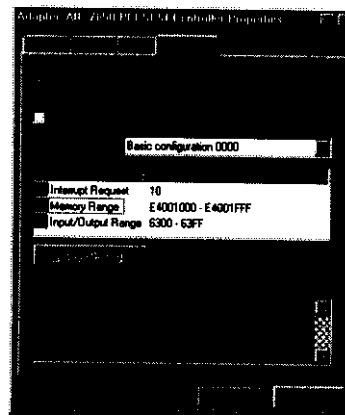

If you're asked to shut down your computer, select **No**, then click **Close**. You will be asked whether you wish to restart your computer. Click **Yes** and restart your computer.

English

Deutsch

Français

English

Deutsch

Français

### Resolving situation C

1. Click **Start, Settings**, and select **Control Panel**.
2. Double-click **Add New Hardware**.
3. Click **Next** and select **No** for “Do you want Windows to search for your new hardware?”.
4. From the next menu, select **SCSI controllers** and click **Next**.

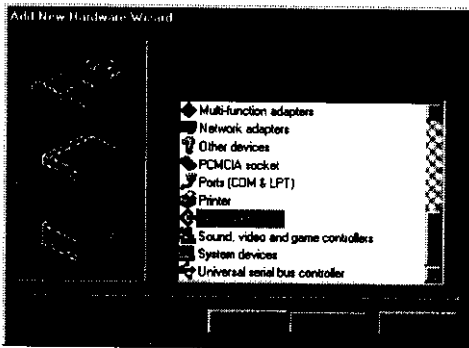

5. Select **Adaptec** on the left and “**Adaptec AIC-7850 PCI SCSI Controller**” on the right. Click **Next**.

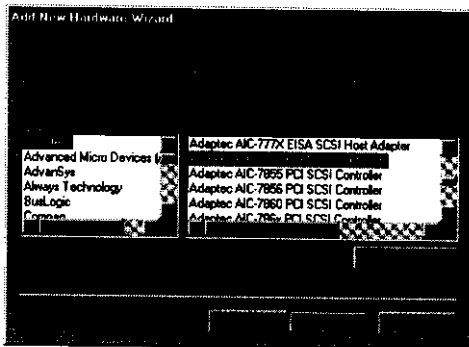

6. When the “Add New Hardware Wizard” dialog box appears, click **Finish**.

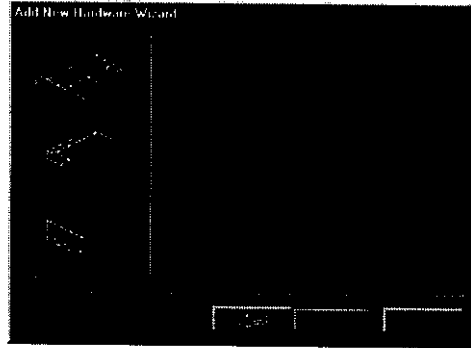

7. When installation is complete. Windows 98 will then ask if you want to shut down your computer. Select **No**.
8. Click **Start, Settings**, and select **Control Panel**.
9. Double-click on the **System** icon in Control Panel and select **Device Manager** from the top.
10. Double-click on “**SCSI controllers**” to check whether conflict happens.

If conflict exists, follow the steps of *Resolving Situation B* (see page 16) to reset it.

11. When settings are all correct, click **OK** to save the modifications. The dialog box should now show the correct Interrupt Request, Memory Range, and Input/Output address settings. If you're asked to shut down your computer, select **No**, then click **Close**. You will be asked whether you wish to restart your computer. Click **Yes** and restart your computer.

### Resolving situation D

See the section *Technical Tips of Installation Guide* that came with your AVA-2902E interface card.

## Installation under Windows NT 4.0 (SCSI Environment)

English

Deutsch

Français

To install under Windows NT 4.0, take the steps below:

1. Reset the scanner's SCSI ID if necessary
2. Install the interface card in your computer
3. Check your Windows NT configuration
4. Install software
5. Connect the scanner and computer
6. Test your scanner

Part of the above procedures, especially to hardware installation should refer to the previous pages (Installation under Windows 95 section). Descriptions below follow installation sequence, but concentrated on Windows NT 4.0

### 1. Resetting the scanner's SCSI ID if necessary

You may or may not need to change the SCSI ID on your scanner. For more details on how to reset your scanner's SCSI ID, refer to Step 4 on page 11.

### 2. Installing the interface card

Before installing the interface card supplied with your scanner, make sure you have turned off your computer and peripherals. Then refer to Step 1 on page 9.

### 3. Checking your Windows NT configuration

When you run Windows NT, the Adaptec AVA-2902E SCSI Host Adapter is detected and the driver is automatically installed. Follow the steps below to check.

1. In Windows NT, click on the **Start** menu, go to **Programs, Administrative Tools (Common)**, and select **Windows NT Diagnostics**. This will bring you to the following partial screen shot:

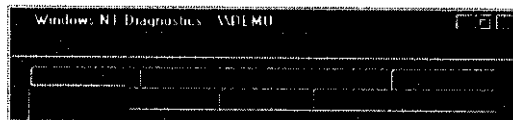

2. Click on the **Resources** tab to bring up the following screen:

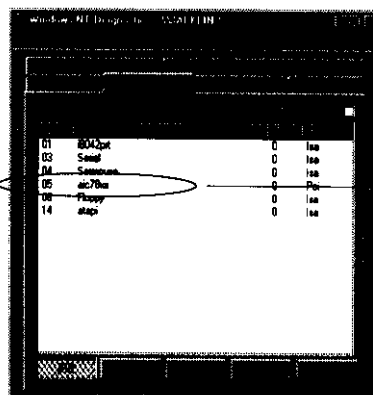

The "aic78xx" message indicates you are using AVA-2902E SCSI interface card.

Number 05 appears, indicating IRQ 5 is in use.

At this screen you see a list of IRQs that are currently in use. By clicking on the **I/O Port** button at the bottom of the screen, you can see a list of I/O addresses that are in use.

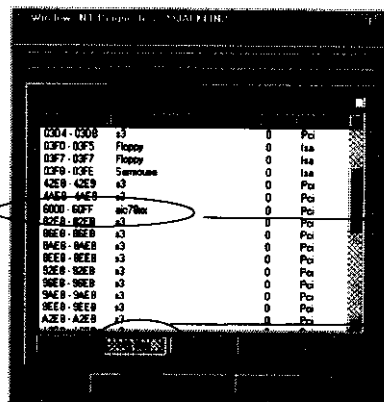

This I/O address is used by AVA-2902E interface card.

I/O Port button.



From these two screens you have seen, the available IRQ and I/O address for use with the AVA-2902E interface card.

If the message "aic78xx" is not listed on the screen, indicating the SCSI driver is not installed; refer to the *Troubleshooting* section.

## 4. Installing software

1. Launch Windows NT 4.0, log in as Administrator.
2. Insert the Microtek CD-ROM into your CD-ROM drive. The *Microtek Scanner Software* installer should come up automatically, and list the available software for you. Click on each software program in the order they appear on your screen to install all software components.

*Note: If the Microtek Scanner Software Installer is not automatically displayed on the screen, click Start, select Run and type e:\cdsetup (where e: is the drive letter of your CD-ROM).*

### Step 1 Install Microtek ScanWizard

ScanWizard is a Twain driver used for the scanner to work with various applications. ScanWizard cannot be used by itself and requires another program in order to work.

1. Click **Microtek ScanWizard**, then follow screen instructions to start installation.
2. During installation, choose "**Adaptec SCSI Interface Card**" as your interface type.
3. Follow screen instructions to complete installation. When installation is complete, **Microtek ScanWizard for Windows NT** appears as a folder on the Programs menu.

### Step 2 Install software application

The bundled image editing, OCR, and other applications you receive depend on the scanner model you purchase. Click each option on the installer screen to install the software.

### Step 3 Install Microtek DCR

DCR is Microtek's proprietary color calibration technology for use with Microtek color scanners. With DCR installed, your scanner is capable of capturing extremely accurate color images.

### Step 4 Install documentation reader

Click **Adobe Acrobat Reader**, then follow screen instructions until installation is completed. Acrobat Reader is necessary for reading the manuals on your CD-ROM.

## 5. Connecting the scanner

Make sure your computer are turned off before connection begins. See Step 5 on page 11 to connect the scanner and computer.

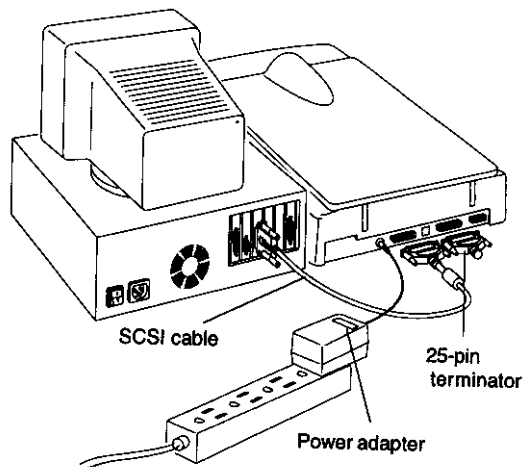

## 6. Testing your scanner

Restart your computer, and start up **Scanner Test** from the **Microtek ScanWizard for Windows NT** group. The scanner test reports the detected scanner model and the interface card — aic78xx. You are now ready to scan. For more details, refer to step 7 on page 13.

## Troubleshooting

After installing the interface card in your computer and connecting the scanner, you may find yourself unable to use the scanner. This is usually due to any of the situations described below:

**Situation A** Your interface card is not properly seated in the PCI card slot on your computer.

**Situation B** The AVA-2902E SCSI driver is not properly installed in your computer.

See details below for resolving the individual situations above.

### Resolving situation A

Power down your computer, remove the AVA-2902E interface card from your computer. Then re-install it, make sure the card is seated all the way in and secured into the PCI card slot. The PCI card slot normally appears in white or ivory.

### Resolving situation B

1. Restart your computer. Start up Windows NT 4.0.
2. Click **Start**, **Settings**, and select **Control Panel**.
3. In the Control Panel window, find **SCSI Adapters** and double click it. A window like the following will appear.

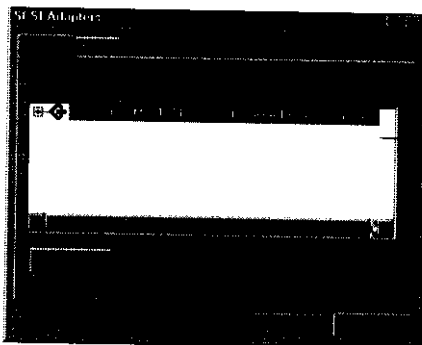

The Adaptec 2902E SCSI driver is not listed here.

The Devices screen will list any SCSI controllers that may already have installed in your computer.

*Note: Although IDE CD-ROM drives are not SCSI, because of the way the driver is implemented, Windows NT 4.0 will still list it on this screen.*

4. Click on the **Drivers** tab, and click on the **Add...** button to select **Adaptec** on the left and "Adaptec AHA-294X/AHA-394X or AIC-78XX PCI SCSI Controller" on the right to install.

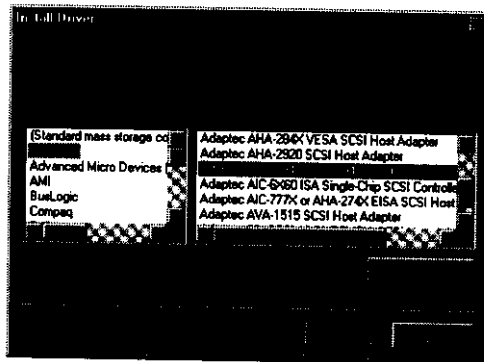

5. Click OK to bring up the following screen.

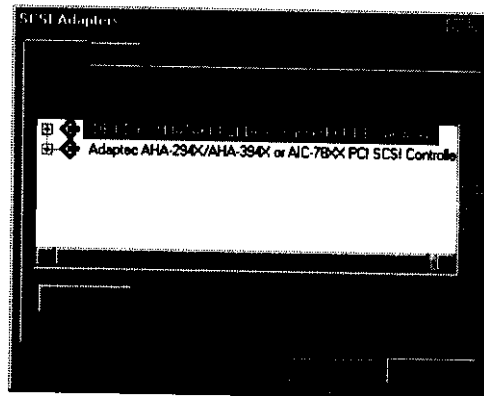

The Adaptec card should now be listed as "Adaptec AHA-294X/AHA-394X or AIC-78XX PCI SCSI Controller", indicating the driver is installed.

6. Restart your computer. Start up Windows NT 4.0, follow the step 3 on page 19 to check Windows NT configuration.

English

Deutsch

Français

## Miscellaneous

In this section, you will learn the following topics.

- Perform the power-on self-test
- Return your scanner for repairs

### Performing the Power-on Test

1. Connect the power adapter to the back of the scanner.
2. Plug the power adapter into a wall outlet or power source.
3. The scanner automatically turns on when the power adapter is connected. The ScanMaker V6USL scanner has no power switch.

The green light on the front of the scanner will start flashing, and after a few seconds, will remain on solid.

**Important:** If the green light continues flashing for more than a minute, contact your reseller.

### Returning your scanner for repair

Your scanner has been built to exacting standards. Just like any piece of electrical equipment, however, your scanner or the delicate parts in it are subject to wear and tear and may malfunction for any number of reasons. If your scanner needs to be serviced or repaired, do the following:

#### For U.S. users:

- Call 310-297-5151 to obtain an RMA number from Microtek Technical Support.
- Pack the scanner in the original box without any software, and send the interface card and cables (only if applicable and asked to do so). If you have lost the original box, you will need to buy one from Microtek for a nominal fee.

- Send the scanner to Microtek Lab, Inc., 3715 Doolittle Drive, Redondo Beach, CA 90278, Attention RMA number <put the RMA number here>.

**Important:** Make sure the RMA number is on the outside address label and is visible. Packages without an RMA number or with the wrong RMA number on the outside of the box will be refused and returned to sender.

#### For Canadian users:

Call Microtek Technical Support. You will be given an RMA number and address to where your scanner can be sent for repair.

#### For users in parts other than the U.S. or Canada:

Call your authorized dealer for further instructions.

### Lamp Replacement

The lamp inside your scanner is not user serviceable and should be replaced if it does not come on or begins to flicker/dim after some time.

If the lamp requires replacement, call Microtek Technical Support to get a Repair Merchandise Authorization (RMA) number, and send the scanner in for lamp replacement. Outside the U.S. and Canadian, call your authorized Microtek dealer for lamp replacement.

# Components

English

Deutsch

Français

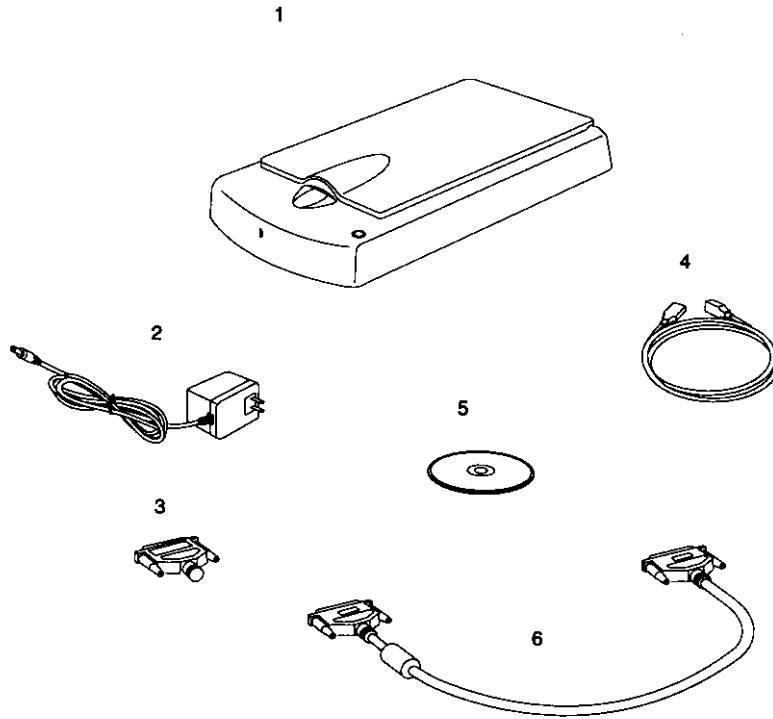

- 1. ScanMaker V6USL scanner
- 2. Power adapter\*
- 3. SCSI terminator (25-pin)

- 4. USB cable
- 5. Microtek CD-ROM
- 6. SCSI cable (25-25pin)

\* Depending on the voltage condition for individual marketing areas, your power adapter may have a different look.

## Optional Accessories Kit

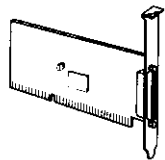

Adaptec 2902E SCSI Interface Card

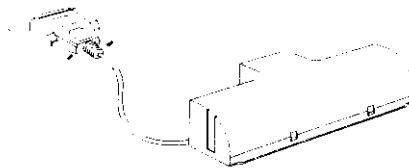

LightLid 35

English

Deutsch

Français

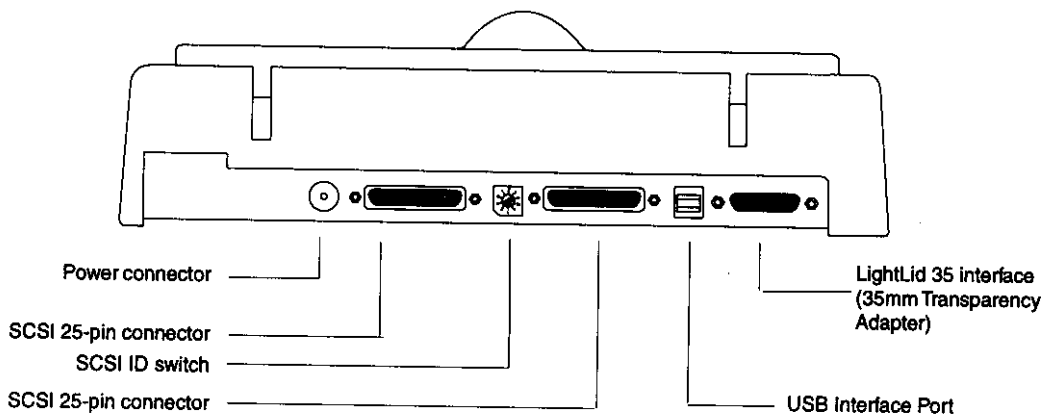
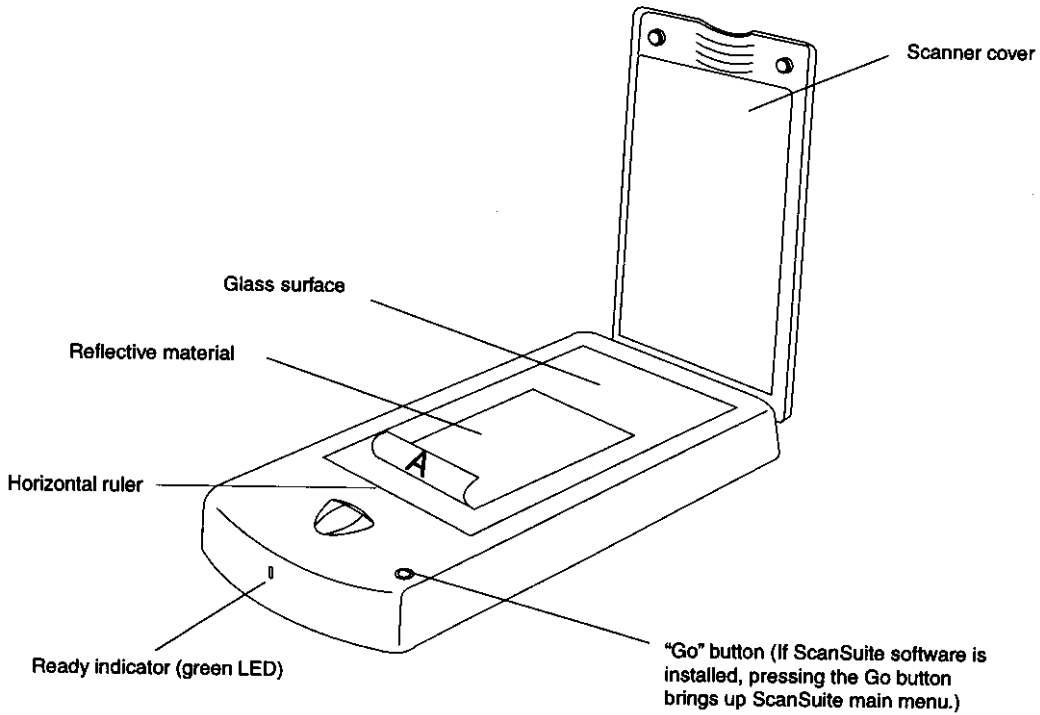

## Specifications

<b>Product Name</b>	ScanMaker V6USL
<b>Model number</b>	MRS-1200V6US
<b>Type</b>	Desktop, Flatbed, Single pass
<b>Resolution</b>	600 dpi(H) x 1200dpi(V)
<b>Sample depth</b>	12 bits per color
<b>Calibration time</b>	4 sec. (gray) 5 sec. (color)
<b>Scanning speed</b>	in speed mode gray: 5 ms/line color: 15 ms/line in quality mode gray: 5 ms/line color: 15 ms/line
<b>Transmission speed</b>	Preview <20s (letter size) USB: 1 MB/s SCSI: 1 MB/s
<b>Scanning Area</b>	Min. 16 pixels x 16 pixels Max. 215.9mm x 355.6mm (8.5" x 14")
<b>Warm up time</b>	30sec. 3min. for image quality level
<b>Power Adapter</b>	110 V (USA) 220 V (other countries)
<b>Voltage Frequency</b>	47 Hz to 63 Hz
<b>Power Consumption</b>	18W max.
<b>Dimensions</b>	21.5" x 11.8" x 3.2" (L x W x H)
<b>Weight</b>	5.2kg

English

Deutsch

Français

## Important Notes

### Choose only one interface

When connecting ScanMaker V6USL to computer, you should choose either USB or SCSI, not both.

If SCSI interface is chosen, the terminator has to be connected to finish a complete connection.

Depending on different configurations, you may require 25-pin SCSI terminator. **If USB is chosen, the SCSI cable along with the terminator should all be removed.**

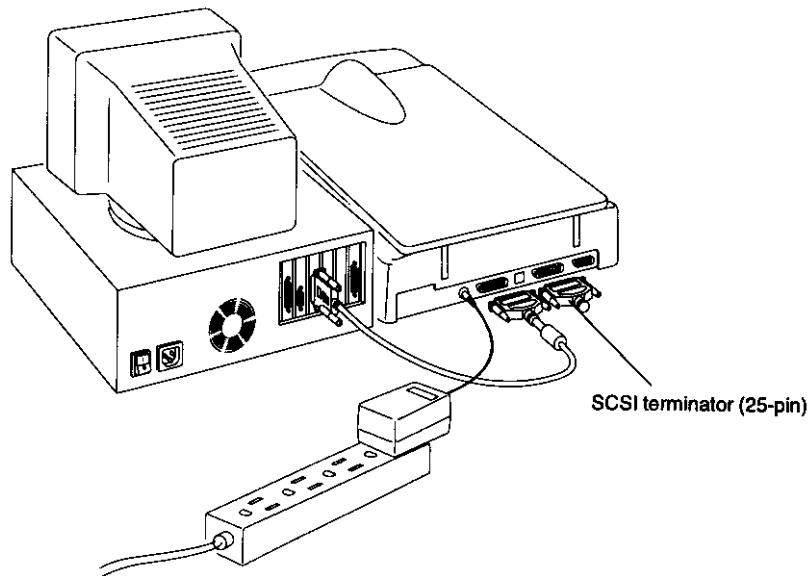

### Power up notice

When using SCSI interface, be sure you have connected the SCSI cable and the terminator first, then connect the DC power adapter.