

# INSTRUCTION MANUAL

# MICROWAVE OVEN

EM134A2XC

Please review this instruction manual before operating.

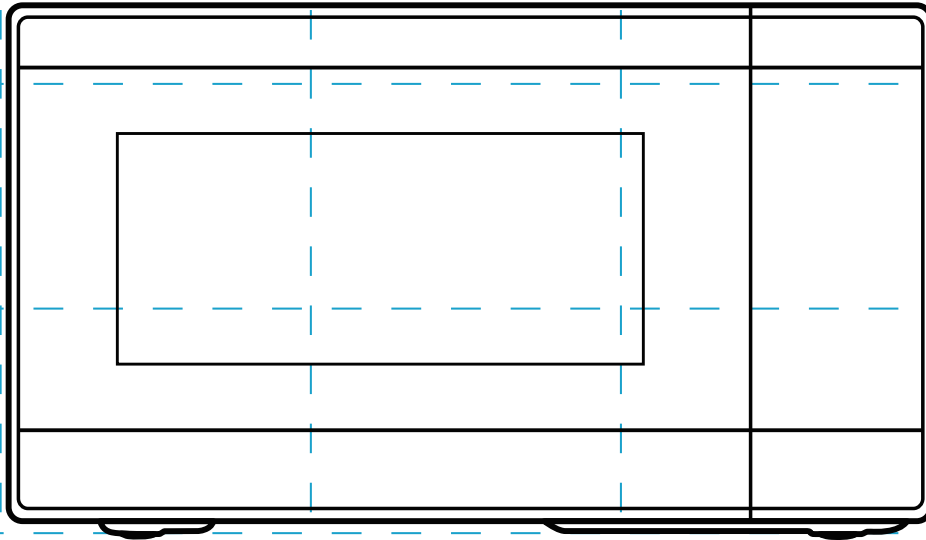

# CONTENTS

## PRODUCT SAFETY

Precautions to avoid possible exposure to excessive microwave energy .....	EN-01
Specifications .....	EN-02
Important safety instructions .....	EN-03
Grounding instructions.....	EN-07
Radio interference .....	EN-09
Utensils.....	EN-10
Materials you can use in microwave oven .....	EN-11
Materials can not be used in microwave oven .....	EN-13

## PRODUCT SETTING

Names of microwave oven parts and accessories .....	EN-14
Turntable installation .....	EN-15
Countertop installation .....	EN-16
Installation .....	EN-16

## INSTRUCTION FOR USE

Before using for the first time .....	EN-17
Control panel and features .....	EN-18
1. Safety lock.....	EN-19
2. Setting the clock.....	EN-20
3. Setting the Kitchen timer.....	EN-20
4. Microwave cooking .....	EN-21
5. Speedy cooking.....	EN-22

6. Defrost by weight .....	EN-23
7. Defrost by time .....	EN-23
8. Multi-stage cooking .....	EN-24
9. Auto menu .....	EN-25
10. Sensor menu.....	EN-26
11. Inquiring function .....	EN-26
12. Lock function for children.....	EN-27
13. Mute mode .....	EN-27
14. ECO function .....	EN-27

## CLEANING AND MAINTENANCE

Cleaning.....	EN-28
Trouble shooting.....	EN-30



### NOTE

BEFORE OPERATING THIS PRODUCT, READ, UNDERSTAND, AND FOLLOW THESE INSTRUCTIONS. BE SURE TO SAVE THIS BOOKLIST FOR FUTURE REFERENCE.

## PRECAUTIONS TO AVOID POSSIBLE EXPOSURE TO EXCESSIVE MICROWAVE ENERGY

---

- (a). Do not attempt to operate this oven with the door open since open door operation can result in harmful exposure to microwave energy.

It is important not to defeat or tamper with the safety interlocks.

- (b). Do not place any object between the oven front face and the door or allow soil or cleaner residue to accumulate on sealing surfaces.

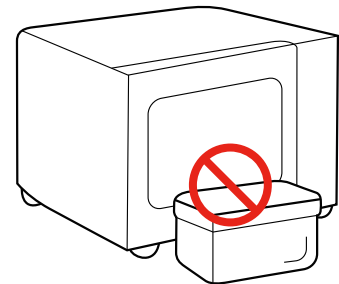

- (c). Do not operate the oven if it is damaged. It is particularly important that the oven door closes properly and that there is no damage to the:
- (1). DOOR (bent)
  - (2). HINGES AND LATCHES (broken or loosened)
  - (3). DOOR SEALS AND SEALING SURFACES
- (d). The oven should not be adjusted or repaired by anyone except properly qualified service personnel.

## SPECIFICATIONS

---

MODEL	EM134A2XC
RATED VOLTAGE	120VAC 60Hz
RATED INPUT POWER(MICROWAVE)	1500 W
RATED OUTPUT POWER(MICROWAVE)	1100 W

---



### NOTE

All pictures in this manual are for illustrative purposes only; these may be slightly different from the purchased equipment, please refer to the actual product.

# IMPORTANT SAFETY INSTRUCTIONS



## WARNING

When using electrical appliances basic safety precautions should be followed, including the following. To reduce the risk of burns, electric shock, fire, injury to persons or exposure to excessive microwave energy.



Read all instructions before using the appliance.



Read and follow the specific:  
**"PRECAUTIONS TO AVOID POSSIBLE EXPOSURE TO EXCESSIVE MICROWAVE ENERGY"** found on page 01.



This appliance must be grounded. Connect only to properly grounded outlet. See **"GROUNDING INSTRUCTIONS"** found on page 07.



Install or locate this appliance only in accordance with the provided installation instructions.



**HOT CONTENTS CAN CAUSE SEVERE BURNS. DO NOT ALLOW CHILDREN TO**

## USE THE MICROWAVE.

Use caution when removing hot items.



When cleaning surfaces of door and oven that comes together on closing the door, use only mild, nonabrasive soaps, or detergent applied with a sponge or soft cloth. Please keep the waveguide area clean. Use soft damp cloth to clean it up when there is food splash residue on the waveguide area or the cavity. Failure to clean food residue may cause innocuous sparking or some smoke in the microwave cavity, discoloration of the cavity may also occur.

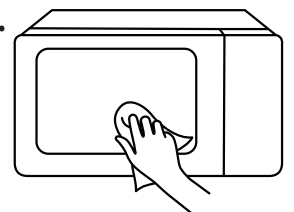

# IMPORTANT SAFETY INSTRUCTIONS

 Keep cord away from heated surface.

---

 Liquids, such as water, coffee, or tea are able to overheat beyond the boiling point without appearing to be boiling. Visible bubbling or boiling when the container is removed from the microwave oven is not always present.

**THIS COULD RESULT IN VERY HOT LIQUID SUDDENLY BOILING OVER WHEN THE CONTAINER IS DISTURBED OR A SPOON OR OTHER UTENSIL IS INSERTED INTO THE LIQUID.** To reduce the risk of injury to persons:

1. Do not overheat the liquid.
2. Stir the liquid both before and halfway through heating it.
3. Do not use straight-sided containers with narrow necks.
4. After heating, allow

the container to stand in the microwave oven for a short time before removing the container.

5. Use extreme care when inserting a spoon or other utensil into the container.

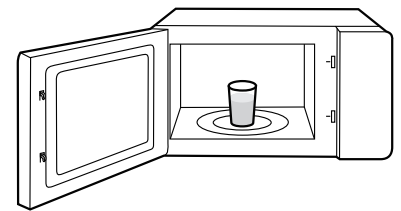

 This appliance should be serviced only by qualified service personnel. Contact nearest authorized service facility for examination, repair, or adjustment.

---

 To reduce the risk of fire in the oven cavity:

1. Do not overcook food. Carefully attend appliance when paper, plastic, or other combustible materials are placed inside the oven to facilitate cooking.

# IMPORTANT SAFETY INSTRUCTIONS

2. Remove wire twist-ties from paper or plastic bag before placing bag in oven.
3. If material inside of the oven ignite, keep oven door closed, turn oven off, and disconnect the power cord, or shut off power at the fuse or circuit breaker panel.
4. Do not use the cavity for storage purposes. Do not leave paper products, cooking utensils, or food in the cavity when not in use.

-  Some products such as whole eggs and sealed containers, for example, closed glass jars are able to explode and should not be heated in this oven.

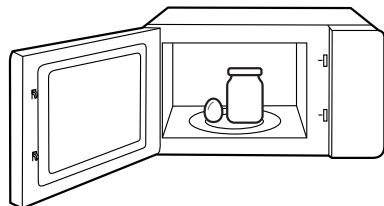

-  Do not store this appliance outdoors. Do not use this product near water - for example, near a kitchen sink, in a wet basement, near a swimming pool, or similar location.

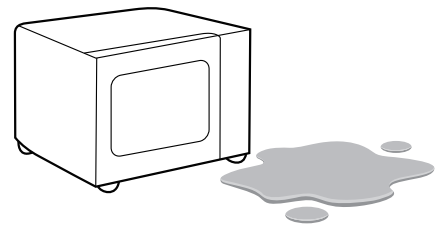

-  Do not immerse cord or plug in water or any other liquid.



-  Use this appliance only for its intended use as described in the manual. Do not use corrosive chemicals or vapors in this appliance. This type of oven is specifically designed to heat, cook or dry food. It is not designed for industrial or laboratory use.



# IMPORTANT SAFETY INSTRUCTIONS

 Do not operate this appliance if it has a damaged cord or plug, if it is not working properly, or if it has been damaged or dropped.

---

 Do not cover or block any openings on the appliance.

 Do not let cord hang over edge of table or counter.

**SAVE THESE INSTRUCTIONS  
HOUSEHOLD USE ONLY  
(NOT FOR COMMERCIAL USE)**

# GROUNDING INSTRUCTIONS

This appliance must be grounded. In the event of an electrical short circuit, grounding reduces the risk of electric shock by providing an escape wire for the electric current. This appliance is equipped with a cord having a grounding wire with a grounding plug. The plug must be plugged into an outlet that is properly installed and grounded.

**WARNING** - Improper use of the grounding can result in a risk of electric shock. Consult a qualified electrician or serviceman if the grounding instructions are not completely understood, or if doubt exists as to whether the appliance is properly grounded. If it is necessary to use an extension cord, use only a 3-wire extension cord that has a 3-blade grounded plug, and 3-slot receptacle that will accept the plug on the appliance. The marked rating of the extension cord shall be equal to or greater than the electrical rating of the appliance.



**DANGER**

Electric Shock Hazard:

Touching some of the internal components can cause serious personal injury or death. Do not disassemble this appliance.

# GROUNDING INSTRUCTIONS



**WARNING**

## Electric Shock Hazard:

Improper use of the grounding can result in electric shock. Do not plug into an outlet until appliance is properly installed and grounded.

1. A short power-supply cord is provided to reduce the risks resulting from becoming entangled in or tripping over a longer cord.
2. Longer cord sets or extension cords are available and may be used if care is exercised in their use.
3. If a long cord or extension cord is used:
  - (1). The marked electrical rating of the cord set or extension cord should be at least as great as the electrical rating of the appliance.
  - (2). The extension cord must be a grounding-type 3-wire cord.
  - (3). The longer cord should be arranged so that it will not drape over the counter top or tabletop where it can be pulled on by children or tripped over unintentionally.

# RADIO INTERFERENCE

1. Operation of the microwave oven may cause interference to your radio, TV or similar equipment.
2. When there is interference, it may be reduced or eliminated by taking the following measures:
  - (1).Clean door and sealing surface of the oven.
  - (2).Reorient the receiving antenna of radio or television.
  - (3).Relocate the microwave oven with respect to the receiver.
  - (4).Move the microwave oven away from the receiver.
  - (5).Plug the microwave oven into a different outlet so that microwave oven and receiver are on different branch circuits.
3. This equipment generates, uses and can radiate radio frequency energy and, if not installed and used in accordance with the instructions, may cause harmful interference to radio communications. However, there is no guarantee that interference will not occur in a particular installation. If this equipment does cause harmful interference to radio or television reception, which can be determined by turning the equipment off and on, the user is encouraged to try to correct the interference by one or more of the following measures:
  - (1) Reorient or relocate the receiving antenna.
  - (2) Increase the separation between the equipment and receiver.
  - (3) Connect the equipment into an outlet on a circuit different from that to which the receiver is connected.
  - (4) Consult the dealer or an experienced radio/TV technician for help.

**This device complies with part 18 of the FCC Rules.**

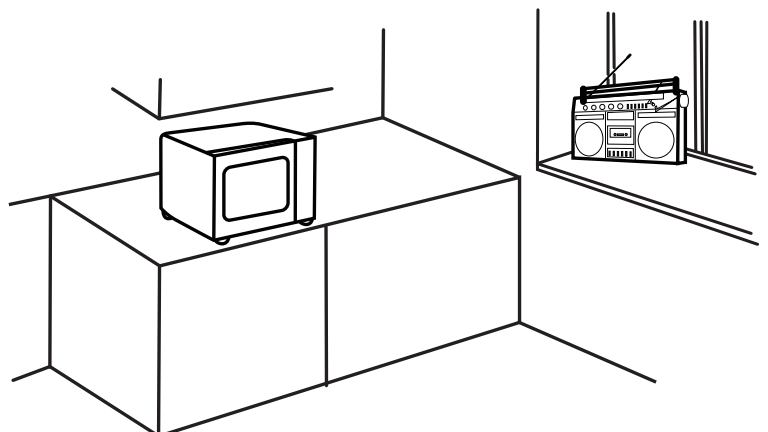

# UTENSILS



## CAUTION

### Personal Injury Hazard:

Tightly-closed utensils could explode. Closed containers should be opened and plastic pouches should be pierced before cooking.

See the instructions on "**Materials you can use in microwave oven.**" or "**Materials can not be used in microwave oven .**"

There may be certain non-metallic utensils that are not safe to use for microwaving. If in doubt, you can test the utensil in question following the procedure below.

### Utensil Test:

1. Fill a microwave-safe container with 1 cup of cold water (250ml) along with the utensil in question.
2. Cook on maximum power for 1 min.
3. Carefully feel the utensil. If the empty utensil is warm, do not use it for microwave cooking.
4. Do not exceed 1 min cooking time.

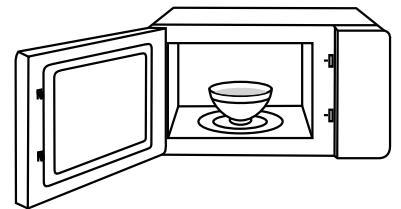





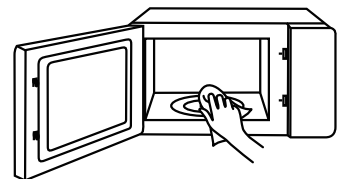







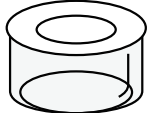



## NOTE



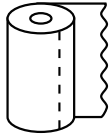

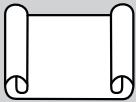



KEEP THE CAVITY AND  
WAVEGUIDE AREA CLEAN

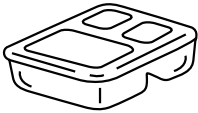



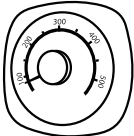







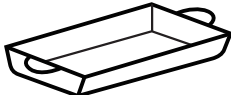

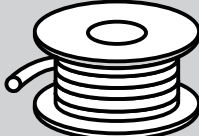

# MATERIALS YOU CAN USE IN MICROWAVE OVEN

UTENSILS	REMARKS	
 <p>Browning dish</p>	<p>Follow manufacturer's instructions. The bottom of browning dish must be at least 3/16 inch (5mm) above the turntable. Incorrect usage may cause the turntable to break.</p>	
 <p>Dinnerware</p>	<p>Microwave-safe only. Follow manufacturer's instructions. Do not use cracked or chipped dishes.</p>	
 <p>Glass jars</p>	<p>Always remove lid. Use only to heat food until just warm. Most glass jars are not heat resistant and may break.</p>	
 <p>Glassware</p>	<p>Heat-resistant oven glassware only. Make sure there is no metallic trim. Do not use cracked or chipped dishes.</p>	
 <p>Oven cooking bags</p>	<p>Follow manufacturer's instructions. Do not close with metal tie. Make slits to allow steam to escape.</p>	
 <p>Paper plates and cups</p>	<p>Use for short-term cooking/warming only. Do not leave oven unattended while cooking.</p>	
 <p>Paper towels</p>	<p>Use to cover food for reheating and absorbing fat. Use with supervision for a short-term cooking only.</p>	
 <p>Parchment paper</p>	<p>Use as a cover to prevent splattering or a wrap for steaming.</p>	

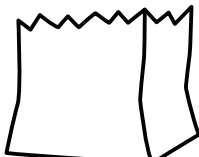
# MATERIALS YOU CAN USE IN MICROWAVE OVEN

UTENSILS	REMARKS
 <p data-bbox="264 633 360 667">Plastic</p>	<p data-bbox="518 497 1302 694">Microwave-safe only. Follow the manufacturer's instructions. Should be labeled "Microwave Safe". Some plastic containers soften, as the food inside gets hot. "Boiling bags" and tightly closed plastic bags should be slit, pierced or vented as directed by package.</p> 
 <p data-bbox="226 896 397 929">Plastic wrap</p>	<p data-bbox="518 779 1299 891">Microwave-safe only. Use to cover food during cooking to retain moisture. Do not allow plastic wrap to touch food.</p> 
 <p data-bbox="205 1124 418 1158">Thermometers</p>	<p data-bbox="518 1052 1286 1086">Microwave-safe only (meat and candy thermometers).</p> 
 <p data-bbox="236 1352 387 1386">Wax paper</p>	<p data-bbox="518 1261 1187 1330">Use as a cover to prevent splattering and retain moisture.</p> 

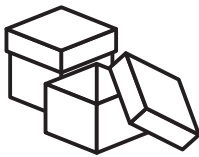
# MATERIALS CAN NOT BE USED IN MICROWAVE OVEN

UTENSILS	REMARKS	
 <p>Aluminum tray</p>	May cause arcing. Transfer food into microwave-safe dish.	
 <p>Food carton with metal handle</p>	May cause arcing. Transfer food into microwave-safe dish.	
 <p>Metal or metal trimmed utensils</p>	Metal shields the food from microwave energy. Metal trim may cause arcing.	
 <p>Metal twist ties</p>	May cause arcing and could cause a fire in the oven.	
 <p>Paper bags</p>	May cause a fire in the oven.	
 <p>Plastic foam</p>	Plastic foam may melt or contaminate the liquid inside when exposed to high temperature.	
 <p>Wood</p>	Wood will dry out when used in the microwave oven and may split or crack.	



# PRODUCT SETTING

## NAMES OF MICROWAVE OVEN PARTS AND ACCESSORIES

Remove the oven and all materials from the carton and oven cavity.

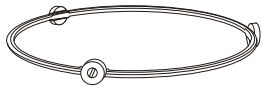

Turntable Ring Assembly

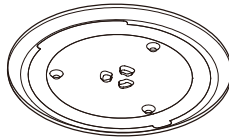

Glass turntable

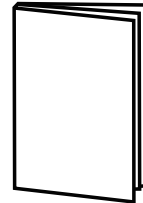

Instruction Manual

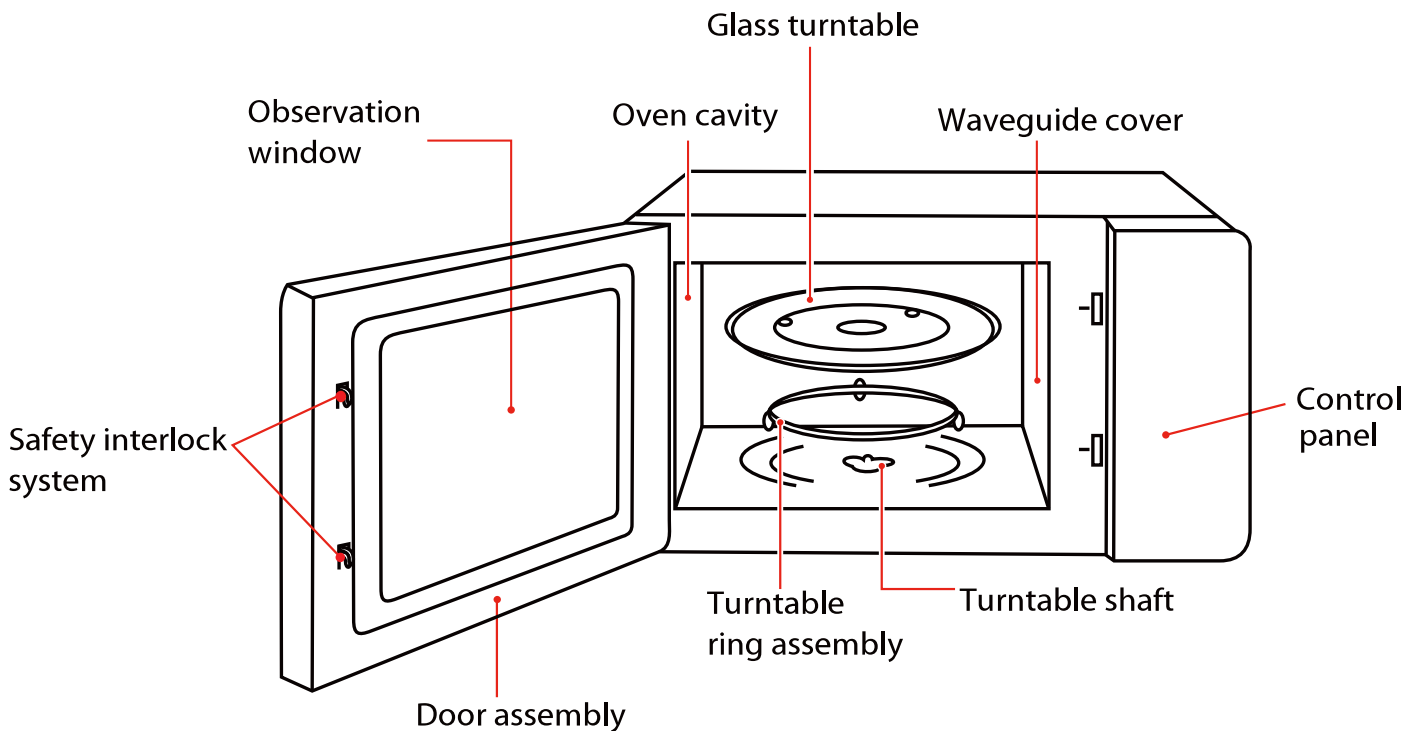

### NOTE

In case of any differences between the appliance and the pictures in this manual, the product shall prevail.

## TURNTABLE INSTALLATION

Cleaning the cooking compartment and putting the turntable in place.

For new installations, make sure all packaging and shipping tape has been removed from the turntable shaft.

Before using the appliance to prepare food for the first time, you will need to put the turntable in place correctly. You must clean the cooking compartment and accessories.

How to put the turntable in place:

1. Place the turntable ring assembly<sup>③</sup> into the recess in the cooking compartment.
2. Place the glass turntable<sup>①</sup> on the turntable ring assembly<sup>③</sup>. Fit the raised, curved lines in the center of the glass turntable bottom between the three spokes of the shaft. Make sure that the glass turntable<sup>①</sup> engages in the turntable shaft<sup>②</sup> in the center of the cooking compartment floor. The rollers on the shaft should fit inside the turntable bottom ridge.

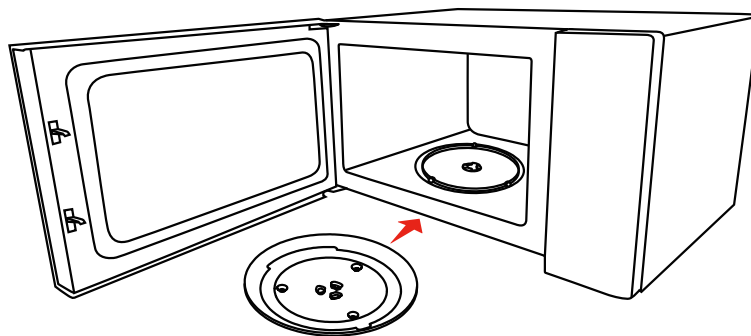
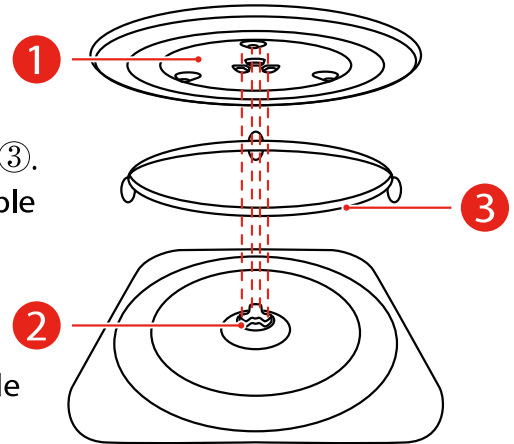

### NOTE

- Never use the appliance without the turntable. Make sure that it is properly engaged. The turntable can turn clockwise or anti-clockwise.
- Never place the glass turntable upside down. The glass turntable should never be restricted.
- Both glass turntable and turntable ring assembly must always be used during cooking.
- All food and containers of food are always placed on the glass turntable for cooking.
- Never restrict the movement of the turntable.
- If glass turntable or turntable ring assembly cracks or breaks, contact your nearest authorized service center.

## COUNTERTOP INSTALLATION

Remove all packing material and accessories. Examine the oven for any damage such as dents or broken door. Do not install if oven is damaged.

Cabinet: Remove any protective film found on the microwave oven cabinet surface. Do not remove the waveguide cover that is attached to the oven cavity to protect the magnetron.

## INSTALLATION

1. Select a level surface that provide enough open space for the intake and/or outlet vents.
  - a. The minimum installation height is 36 inches.
  - b. Leave a minimum clearance of 3.0 inches on each side, 3.0 inches on top and 1.0 inch in the rear.
  - c. Do not remove the legs from the bottom of the oven.
  - d. Blocking the intake and/or outlet openings can damage the oven.
  - e. Operation of microwave oven may cause interference to your radio or TV reception.  
Please place the oven as far away from radios and TV as possible.

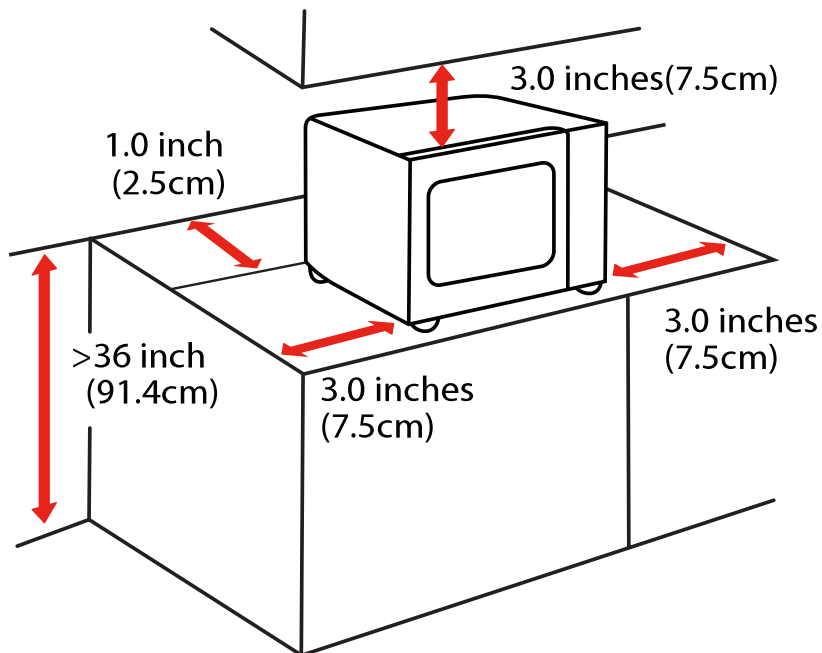

2. Plug the microwave oven into a standard household outlet. Be sure the voltage and the frequency are the same as the voltage and the frequency on the rating label.



**NOTE**

- Do not install oven over a range cooktop or other heat-producing appliance. If installed near or over a heat source, the oven could be damaged and the warranty would be void.

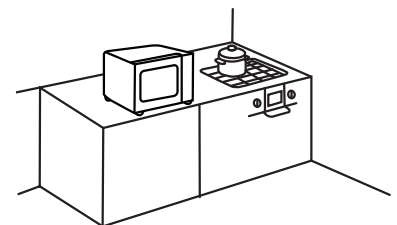

The accessible surface may be hot during operation

# INSTRUCTION FOR USE

## BEFORE USING FOR THE FIRST TIME

**It is normal that the oven may produce unpleasant odors when it is used for the first time.**

This section tells you what you need to do before using your microwave to prepare food for the first time. Read the section entitled "**PRODUCT SAFETY**" beforehand.

Before you can use your new appliance, you will need to put the turntable in place correctly. You must also clean the cooking compartment and accessories.



**NOTE**

- Never use the appliance without the turntable.
- Make sure that it is properly engaged. The turntable can turn clockwise or anti-clockwise.

# OPERATION

## CONTROL PANEL AND FEATURES

---

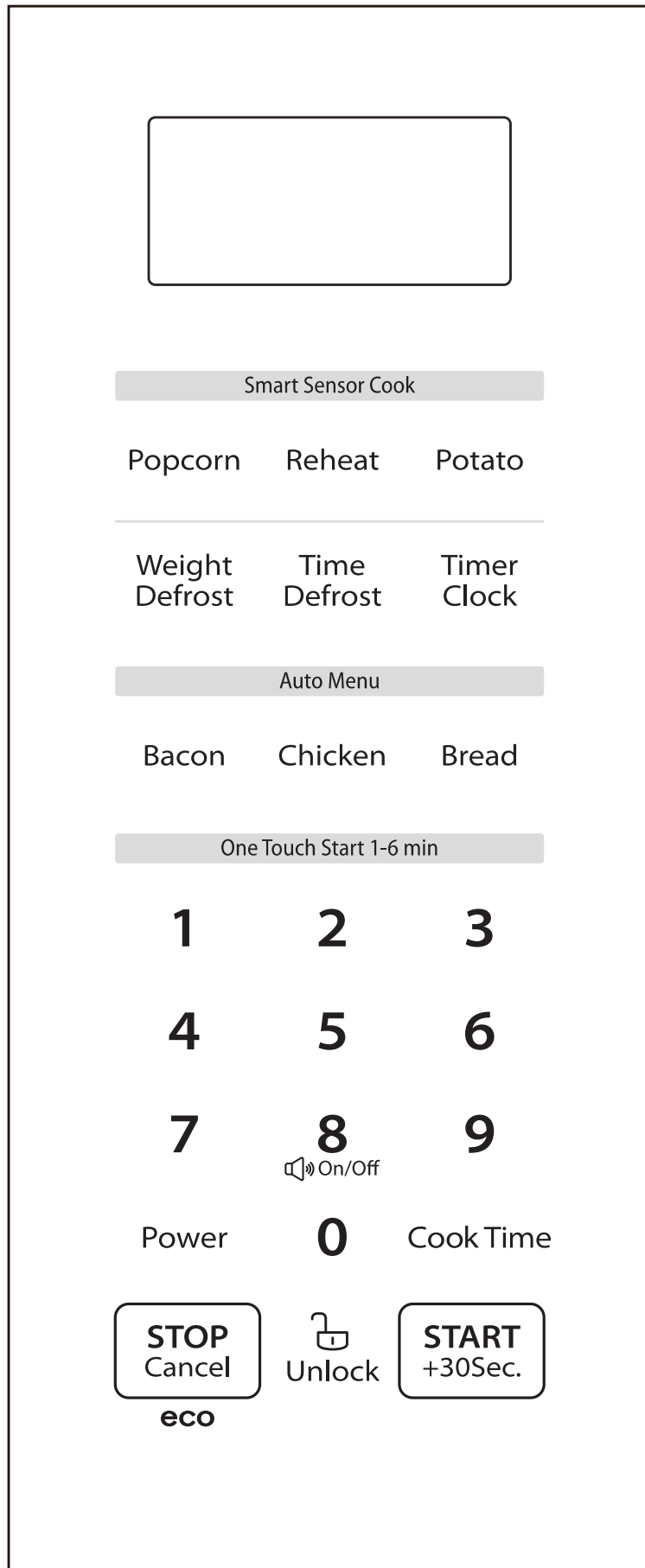

# 1. SAFETY LOCK

Safety Lock is a system that safeguards against unintended activation of the oven, providing a protective measure to ensure child safety.

## (1) How the safety lock works

Initiating a cooking process triggers the door lock, and it also engages if the door remains unlocked for additional 30 minutes following the completion of the cooking.

Safety Lock is active by default. It will only be deactivated if the user chooses to do so manually. Even in the event of a power disconnection, the oven will preserve the state of the safety lock, whether it is activated or deactivated.

## (2) Unlock the door

Press  during operation and open the door within 10 seconds, or the safety lock will re-engage. The door will stay unlocked until cooking is initiated.

Or:

Press  within 30 minutes after cooking is complete to manually disable the door lock and switch to standby mode. If no key is pressed, the safety lock will automatically disengage after 30 minutes.

## (3) Deactivate the safety lock

If there are no children in the house, you can choose to permanently deactivate the safety lock function.

Press "7" , "9" in consecutive order and then press and hold  for three seconds within 30 seconds, the screen will display "ULoc", indicating the successful deactivation of the safety lock.

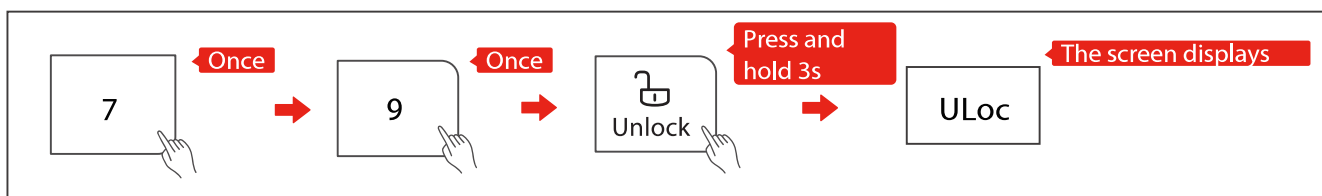

## (4) Re-activate the safety lock

Press "7" , "9" in consecutive order and then press and hold  for three seconds within 30 seconds, the screen will display "Loc", indicating the successful re-activation of the safety lock.

## 2. SETTING THE CLOCK

- a Press **Timer Clock** twice and then "00:00" will display.

Timer  
Clock

- b Press the number keys to enter the time.  
Example: To set the clock to 12:10, please press "1,2,1,0" in turn.

1 2 3

- c Press **Timer Clock** to confirm. The clock is set.

Timer  
Clock



### NOTE

- The clock is a 12-hour display. And if the clock is not set, it will not work when powered.
- To reset the clock, please repeat step a to step c.

## 3. SETTING THE KITCHEN TIMER

- a Press **Timer Clock** once and then "00:00" will display.

Timer  
Clock

- b Press the number keys to enter the desired time.  
The maximum time value is "99:99".

1 2 3

- c Press **START +30Sec.** to confirm. The timer starts counting down.

**START**  
**+30Sec.**



### NOTE

- The kitchen timer is a timer.
- Any other program can't be set during the kitchen timer.

## 4. MICROWAVE COOKING

### 11 power levels are available

LEVEL	POWER	DISPLAY
1	100%	PL10
2	90%	PL9
3	80%	PL8
4	70%	PL7
5	60%	PL6
6	50%	PL5
7	40%	PL4
8	30%	PL3
9	20%	PL2
10	10%	PL1
11	0%	PL0

a Press **Cook Time** once and then "00:00" will display.

Cook Time

b Press the number keys to set the cooking time.  
The maximum time value is "99:99".

1 2 3

c Press **Power** once and then "PL10" will display.

Power

d Press **Power** repeatedly or press the number keys to set the power level.  
The 11 power levels are available.

Power

or

1 2 3

e Press **START**  
+30Sec. to start cooking.

START  
+30Sec.



Example: To cook the food with PL5 for 15 minutes.

- a Press **Cook Time** once and then "00:00" will display.

Cook Time

- b Press the number keys "1", "5", "0", and "0" to set the cooking time to 15 minutes.

1 5 0 0

- c Press **Power** once and then press the number key "5" to select PL5.

Power

5

- d Press **START** +30Sec. to start cooking.

START  
+30Sec.

## 5. SPEEDY COOKING

- a In standby mode, press **START** +30Sec. to cook food with 100% power level for 30 seconds. Each press on the same key can increase 30 seconds and the maximum time value is "99:99".

START  
+30Sec.

- b In standby mode, pressing the number keys 1 to 6 lets you quickly select a cooking time from 1 to 6 minutes. Then you can press **START** +30Sec. to increase the cooking time. The maximum time value is "99:99".

1	2	3
4	5	6



### NOTE

- In the microwave cooking state and defrosting by time state, each more press on **START** +30Sec. can increase the cooking time by 30 seconds (except defrosting by weight, auto menu, and kitchen timer).

## 6. DEFROST BY WEIGHT

- a Press **Weight Defrost** repeatedly to choose the type of the food, and then "dEF1", "dEF2", "dEF3", will display.



- b Press the number keys to set the weight of the food.

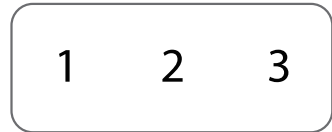

- c Press **START +30Sec.** to start defrosting.



Food	Display	Weight
Meat	dEF1	4~70 Oz
Fish	dEF2	4~32 Oz
Vegetable	dEF3	4~32 Oz



### NOTE

- The buzzer will sound to remind you to turn the food over during defrosting. If no operation, the oven will continue working.

## 7. DEFROST BY TIME

- a Press **Time Defrost** once and then "00:00" will display.



- b Press the number keys to set the desired defrost time. The maximum time value is "99:99".



- c Press **Power** once, "PL3" will display. And then press the number keys to set the power level. (If you do not need to set the power level, skip this step.)

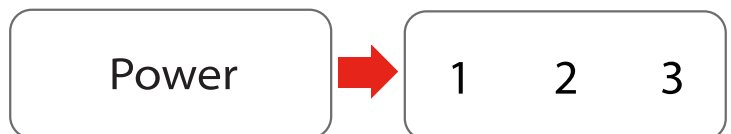

- d Press **START +30Sec.** to start defrosting.



### NOTE

- The buzzer will sound to remind you to turn the food over during defrosting. If no operation, the oven will continue working.
- The defrost power is PL3 and it cannot be changed during defrosting.

## 8. MULTI-STAGE COOKING

---

Example: Defrost food for 5 minutes and then cook with 80% microwave power for 7 minutes.

- a Press **Time Defrost** once and then "00:00" will display.

Time  
Defrost

- b Press "5", "0", and "0" to set the desired defrost time to 5 minutes.

5 0 0

- c Press **Cook Time** once and then press "7", "0", and "0" to set the cooking time.

Cook Time → 7 0 0

- d Press **Power** once and then press the number key "8" to select PL8.

Power → 8

- e Press **START +30Sec.** to start cooking.

START  
+30Sec.



### NOTE

- Two cooking stages can be set in multi-stage cooking.
- If you set the defrost function, it will work automatically in the first stage.
- The auto menu and sensor menu cannot be set as one of the multi-stage.

## 9. AUTO MENU

- a** In standby mode, press the corresponding menu key repeatedly to select the weight of food you want.  
Example: Press **Popcorn** once and then "2.75 Oz" displays.

Popcorn      Potato  
Bacon    Chicken    Bread

- b** Press **START**  
+30Sec. to start cooking.

**START**  
+30Sec.

### Auto menu chart

Menu	Weight	Display	Power
Popcorn	2.75 Oz	2.75 Oz	PL10
	3.2 Oz	3.2 Oz	
Potato	1 Pcs	1	PL10
	2 Pcs	2	
	3 Pcs	3	
	4 Pcs	4	
Bacon	1 Slice	1	PL10
	2 Slices	2	
	3 Slices	3	
	4 Slices	4	
	5 Slices	5	
	6 Slices	6	
Bread	1.76 Oz	1.76 Oz	PL10
	3.52 Oz	3.52 Oz	
	5.29 Oz	5.29 Oz	
Chicken	8.81 Oz	8.81 Oz	PL8
	15.87 Oz	15.87 Oz	
	22.92 Oz	22.92 Oz	

## 10. SENSOR MENU

Sensor Cook allows you to cook many of your favorite foods without selecting the cooking time and the power level.

- a In standby mode, press **Reheat** once and then "SC01" displays.

Reheat

- b Press **START**  
+30Sec., the program will start sensing.  
When the sensing is complete, the buzzer will sound and the calculated cook time will start to count down.

**START**  
+30Sec.

### Sensor Menu chart

Menu	Display	Weight	Power
Reheat	SC01	8~16Oz	PL10



#### NOTE

- Do not open the door during the sensing process, or the program will be canceled.
- Once the calculated cook time is displayed, you can open the door to stir, turn, or rearrange the food. Press **START**  
+30Sec. to resume operation.

## 11. INQUIRING FUNCTION

- a If the clock has been set, the current time will display for three seconds by pressing **Timer Clock** in the cooking state.

Timer  
Clock

- b In the microwave cooking state, press **Power** to inquire about the power level. It will display for three seconds.

Power

## 12. LOCK FUNCTION FOR CHILDREN

---

You can use this function to disable the screen buttons and prevent your child from accidentally turning the oven on.

- a** To activate the lock:  
In standby mode, press and hold  for three seconds.  
A beep sounds and the locked icon will display.



- b** To deactivate the lock:  
In the locked state, press and hold  for three seconds.  
A beep sounds.



## 13. MUTE MODE

---

- a** To activate the mute mode:  
In standby mode, press and hold  for 3 seconds.  
A long beep will sound and "OFF" will display.  
When you press the key, it does not make a sound.



- b** To deactivate the mute mode:  
In mute mode, press and hold  for 3 seconds.  
A long beep will sound and "On" will display.



## 14. ECO FUNCTION

---

- a** To enter ECO mode:  
In standby mode, press  once. The screen will turn off.



- b** To cancel ECO mode:  
In ECO mode, pressing any key, or opening and closing the door will cancel it.

# CLEANING AND MAINTENANCE

## CLEANING

With good care and cleaning, your appliance will retain its appearance and remain fully functioning for a long time to come. Here are the instructions on how to properly care for the microwave oven.



**WARNING**

- Scratched glass in the appliance door may develop into a crack. Do not use a glass scraper, sharp or abrasive cleaning aids or detergents.
- The surface of the appliance may become damaged if it is not cleaned properly. Microwave energy may escape. Clean the appliance on a regular basis, and remove any food remnants immediately.
- Do not immerse the appliance in water or clean under a jet of water.

### Cleaning agent

To ensure that the different surfaces are not damaged by using the wrong cleaning agent, see the information in the table. Wash new sponge or cloth thoroughly before use.

#### Do not use:



Harsh or abrasive cleaning agents



Metal or glass scrapers to clean the door panels

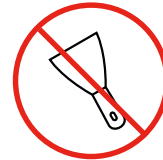

Metal or glass scrapers to clean the door seal



Hard scouring pads or sponges



Cleaning agents with a high alcohol content

### APPLIANCE FRONT

#### Hot soapy water:

Clean using a dish cloth and then dry with a soft cloth. Do not use metal or glass scrapers for cleaning.

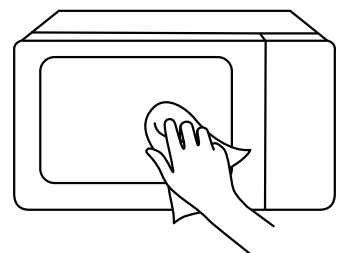

## APPLIANCE FRONT WITH STAINLESS STEEL

---

### Hot soapy water:

Clean using a dish cloth and then dry with a soft cloth. Remove splashes and patches of limescale, grease, starch and albumin immediately. Corrosion can form under these patches or splashes. Do not use glass cleaners or metal or glass scrapers for cleaning.

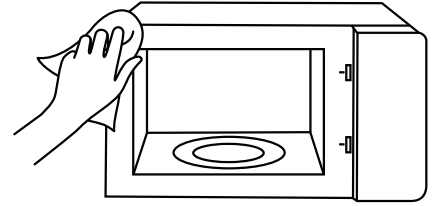

## COOKING COMPARTMENT MADE OF STAINLESS STEEL

---

### Hot soapy water or vinegar solution:

Clean using a dish cloth and then dry with a soft cloth. Do not use oven spray or any other aggressive oven cleaners or abrasive materials. Scouring pads, rough sponges and pan cleaners are also unsuitable. These items scratch the surface. Allow the interior surfaces to dry completely.

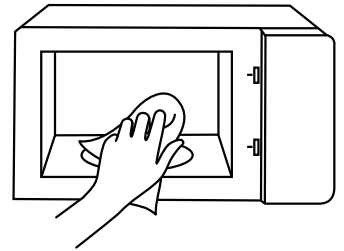

## RECESS IN THE COOKING COMPARTMENT

---

### Damp cloth:

Water must not be allowed to run into the appliance through the turntable drive. Dry the turntable drive with a cloth.

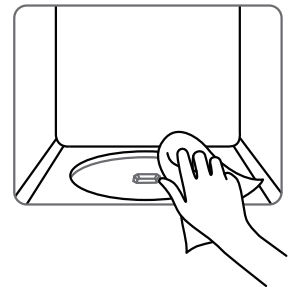

## TURNTABLE AND ROLLER RING

---

### Hot soapy water:

When placing the turntable back into its recess, it must engage properly.



## DOOR PANELS

---

### Glass cleaner:

Clean with a dish cloth. Do not use glass scrapers.



# TROUBLE SHOOTING

Check your problem by using the chart below and try the solutions for each problem.  
If the microwave oven still does not work properly, contact the nearest authorized service center.

TROUBLE	POSSIBLE CAUSE	POSSIBLE REMEDY
Oven will not start	<ul style="list-style-type: none"> <li>a. Electrical cord for oven is not plugged in.</li> <li>b. Door is open.</li> <li>c. Wrong operation is set.</li> </ul>	<ul style="list-style-type: none"> <li>a. Plug into the outlet.</li> <li>b. Close the door and try again.</li> <li>c. Check instructions</li> </ul>
Arcing or sparking	<ul style="list-style-type: none"> <li>a. Materials to be avoided in microwave oven were used.</li> <li>b. The oven is operated when empty.</li> <li>c. Spilled food remains in the cavity.</li> </ul>	<ul style="list-style-type: none"> <li>a. Use microwave-safe cookware only.</li> <li>b. Do not operate with oven empty.</li> <li>c. Clean cavity with soft damp cloth.</li> </ul>
Unevenly cooked foods	<ul style="list-style-type: none"> <li>a. Materials to be avoided in microwave oven were used.</li> <li>b. Food is not defrosted completely.</li> <li>c. Cooking time, power level is not suitable.</li> <li>d. Food is not turned or stirred.</li> </ul>	<ul style="list-style-type: none"> <li>a. Use microwave-safe cookware only.</li> <li>b. Completely defrost food.</li> <li>c. Use correct cooking time, power level.</li> <li>d. Turn or stir food.</li> </ul>
Overcooked foods	Cooking time, power level is not suitable.	Use correct cooking time, power level.
Undercooked foods	<ul style="list-style-type: none"> <li>a. Materials to be avoided in microwave oven were used.</li> <li>b. Food is not defrosted completely.</li> <li>c. Oven ventilation ports are restricted.</li> <li>d. Cooking time, power level is not suitable.</li> </ul>	<ul style="list-style-type: none"> <li>a. Use microwave-safe cookware only.</li> <li>b. Completely defrost food.</li> <li>c. Check to see that oven ventilation ports are not restricted.</li> <li>d. Use correct cooking time, power level</li> </ul>
Improper defrosting	<ul style="list-style-type: none"> <li>a. Materials to be avoided in microwave oven were used.</li> <li>b. Cooking time, power level is not suitable.</li> <li>c. Food is not turned or stirred.</li> </ul>	<ul style="list-style-type: none"> <li>a. Use microwave-safe cookware only.</li> <li>b. Use correct cooking time, power level.</li> <li>c. Turn or stir food.</li> </ul>

**#DetailsMatter**