

Microwave Oven
INSTRUCTION MANUAL
Model:EM145AXX-P

Read these instructions carefully before using your microwave oven, and keep it carefully.

If you follow the instructions, your oven will provide you with many years of good service.

SAVE THESE INSTRUCTIONS CAREFULLY

PRECAUTIONS TO AVOID POSSIBLE EXPOSURE TO EXCESSIVE MICROWAVE ENERGY

- (a) Do not attempt to operate this oven with the door open since this can result in harmful exposure to microwave energy. It is important not to defeat or tamper with the safety interlocks.
- (b) Do not place any object between the oven front face and the door or allow soil or cleaner residue to accumulate on sealing surfaces.
- (c) **Do not operate the oven if it is damaged. It is particularly important that the oven door closes properly and that there is no damage to the:**
 - (1) **DOOR (bent)**
 - (2) **HINGES AND LATCHES (broken or loosened)**
 - (3) **DOOR SEALS AND SEALING SURFACE**
- (d) **The oven should not be adjusted or repaired by anyone except properly qualified service personnel.**

Specifications

Model:	EM145AXX-P
Rated Voltage:	120V~ 60Hz
Rated Input Power(Microwave):	1550W
Rated Output Power(Microwave):	1100W
Oven Capacity:	
Turntable Diameter:	Ø
External Dimensions:	
Net Weight:	
Warning:	Handling the cord on this press or cords associated with accessories sold with this product, will expose you to lead a chemical known to the state of California to cause cancer, and birth defects or other reproductive harm. Wash hands after handling.

IMPORTANT SAFETY INSTRUCTIONS

WARNING

1. Read all instructions before using the appliance.
2. Read and follow the specific: "**PRECAUTIONS TO AVOID POSSIBLE EXPOSURE TO EXCESSIVE MICROWAVE ENERGY**" found on page 2.
3. As with most cooking appliances, close supervision is necessary to reduce the risk of a fire in the oven cavity.
4. To reduce the risk of fire in the oven cavity:
 - i). Do not overcook food. Carefully attend the appliance when paper, plastic, or other combustible materials are placed inside the oven to facilitate cooking.
 - ii). Remove wire twist-ties and metal handles from paper or plastic containers/bags before placing them in the oven.
 - iii). If materials inside the oven ignite, keep the oven door closed. Turn the oven off, and unplug the appliance. Disconnect the power cord, shut off power at the fuse or circuit breaker panel.
 - iv). Do not use the oven cavity for storage purposes. Do not leave paper products, cooking utensils, or food in the cavity when not in use.
5. This oven must be grounded. Connect only to properly grounded outlet. See "**GROUNDING INSTRUCTIONS**" found on page 4.
6. Install or locate this oven only in accordance with the installation instructions provided.
7. Some products such as whole eggs and sealed containers-for example, closed glass jars-are able to explode and should not be heated in the oven.
8. Use this appliance only for its intended uses as described in this manual. Do not use corrosive chemicals or vapors in this appliance. This oven is specifically designed to heat or cook or dry food. It is not designed for industrial or laboratory use.
9. As with any appliance, close supervision is necessary when used by children.
10. Do not operate this oven if it has a damaged cord or plug, if it is not working properly or if it has been damaged or dropped.
11. This appliance should be serviced only by qualified service technicians. Contact the nearest authorized service facility for examination, repair or adjustment.
12. Do not cover or block any openings on the oven.
13. Do not store or use this appliance outdoors.
14. Do not use this oven near water, for example, near a kitchen sink, in a wet basement, near a swimming pool, or similar locations.
15. Do not immerse cord or plug in water.
16. Keep cord away from heated surfaces.
17. Do not let cord hang over edge of table or counter.
18. When cleaning surfaces of door and oven that comes together on closing the door, use only mild, nonabrasive soaps or detergents applied with a sponge or soft cloth.

19. Liquids, such as water, coffee, or tea are able to be overheated beyond the boiling point without appearing to be boiling. Visible bubbling or boiling when the container is removed from the microwave oven is not always present. **THIS COULD RESULT IN VERY HOT LIQUIDS SUDDENLY BOILING OVER WHEN THE CONTAINER IS DISTURBED OR A SPOON OR OTHER UTENSIL IS INSERTED INTO THE LIQUID.**
- i) Do not overheat the liquid.
 - ii) Stir the liquid both before and halfway through heating it.
 - iii) Do not use straight-sided containers with narrow necks.
 - iv) After heating, allow the container to stand in the microwave oven for a short time before removing the container.
 - v) Use extreme care when inserting a spoon or other utensil into the container.

SAVE THESE INSTRUCTIONS

GROUNDING INSTRUCTIONS

DANGER

Electric Shock Hazard

Touching some of the internal components can cause serious personal injury or death. Do not disassemble this appliance.

WARNING

Electric Shock Hazard

Improper use of the grounding can result in electric shock. Do not plug into an outlet until appliance is properly installed and grounded.

Three-pronged (grounding) plug

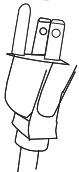

This appliance must be grounded. In the event of an electrical short circuit, grounding reduces the risk of electric shock by providing an escape wire for the electric current. This appliance is equipped with a cord having grounding wire with a grounding plug. The plug must be plugged into an outlet that is properly installed and grounded.

Consult a qualified electrician or serviceman if the grounding instructions are not completely understood or if doubt exists as to whether the appliance is properly grounded. If it is necessary to use an extension cord, use only a 3-wire extension cord that has a 3-pronged grounding plug, and a 3-slot receptacle that will accept the plug on the appliance. The marked rating of the extension cord shall be equal to or greater than the electrical rating of the appliance.

1. A short power-supply cord is provided to reduce the risks resulting from becoming entangled in or tripping over a longer cord.
2. Longer cord sets or extension cords are available and may be used if care is exercised in their use.
3. If a long cord set or extension cord is used:
 - 1) The marked electrical rating of the cord set or extension marked electrical rating of the cord set or extension cord should be at least as great as the electrical rating of the appliance.
 - 2) The extension cord must be a grounding-type 3-wire cord; and
 - 3) The longer cord should be arranged so that it will not drape over the countertop or tabletop where it can be pulled on by children or tripped over unintentionally.

Radio Interference

1. Operation of the microwave oven may cause interference to your radio, TV or similar equipment.
2. When there is interference, it may be reduced or eliminated by taking the following measures:
 - 1) Clean door and sealing surface of the oven
 - 2) Reorient the receiving antenna of radio or television.
 - 3) Relocate the microwave oven with respect to the receiver.
 - 4) Move the microwave oven away from the receiver.
 - 5) Plug the microwave oven into a different outlet so that microwave oven and receiver are on different branch circuits.

UTENSILS

CAUTION

Personal Injury Hazard

Tightly-closed utensils could explode. Closed containers should be opened and plastic pouches should be pierced before cooking.

See the instructions on "Materials you can use in microwave oven or to be avoided in microwave oven."

There may be certain non-metallic utensils that are not safe to use for microwaving. If in doubt, you can test the utensil in question following the procedure below.

Utensil Test:

1. Fill a microwave-safe container with 1 cup of cold water (250ml) along with the utensil in question.
2. Cook on maximum power for 1 minute.
3. Carefully feel the utensil. If the empty utensil is warm, do not use it for microwave cooking.
4. **Do not exceed 1 minute cooking time.**

Materials you can use in microwave oven

Utensils	Remarks
Aluminum foil	Shielding only. Small smooth pieces can be used to cover thin parts of meat or poultry to prevent overcooking. Arcing can occur if foil is too close to oven walls. The foil should be at least 1 inch (2.5cm) away from oven walls.
Browning dish	Follow manufacturer's instructions. The bottom of browning dish must be at least 3/16 inch (5mm) above the turntable. Incorrect usage may cause the turntable to break.
Dinnerware	Microwave-safe only. Follow manufacturer's instructions. Do not use cracked or chipped dishes.
Glass jars	Always remove lid. Use only to heat food until just warm. Most glass jars are not heat resistant and may break.
Glassware	Heat-resistant oven glassware only. Make sure there is no metallic trim. Do not use cracked or chipped dishes.
Oven cooking bags	Follow manufacturer's instructions. Do not close with metal tie. Make slits to allow steam to escape.
Paper plates and cups	Use for short-term cooking/warming only. Do not leave oven unattended while cooking.
Paper towels	Use to cover food for reheating and absorbing fat. Use with supervision for a short-term cooking only.
Parchment paper	Use as a cover to prevent splattering or a wrap for steaming.
Plastic	Microwave-safe only. Follow the manufacturer's instructions. Should be labeled "Microwave Safe". Some plastic containers soften, as the food inside gets hot. "Boiling bags" and tightly closed plastic bags should be slit, pierced or vented as directed by package.
Plastic wrap	Microwave-safe only. Use to cover food during cooking to retain moisture. Do not allow plastic wrap to touch food.
Thermometers	Microwave-safe only (meat and candy thermometers).
Wax paper	Use as a cover to prevent splattering and retain moisture.

Materials to be avoided in microwave oven

Utensils	Remarks
Aluminum tray	May cause arcing. Transfer food into microwave-safe dish.
Food carton with metal handle	May cause arcing. Transfer food into microwave-safe dish.
Metal or metal-trimmed utensils	Metal shields the food from microwave energy. Metal trim may cause arcing.
Metal twist ties	May cause arcing and could cause a fire in the oven.
Paper bags	May cause a fire in the oven.
Plastic foam	Plastic foam may melt or contaminate the liquid inside when exposed to high temperature.
Wood	Wood will dry out when used in the microwave oven and may split or crack.

SETTING UP YOUR OVEN

Names of Oven Parts and Accessories

Remove the oven and all materials from the carton and oven cavity.

Your oven comes with the following accessories:

Glass tray	1
Turntable ring assembly	1
Instruction Manual	1

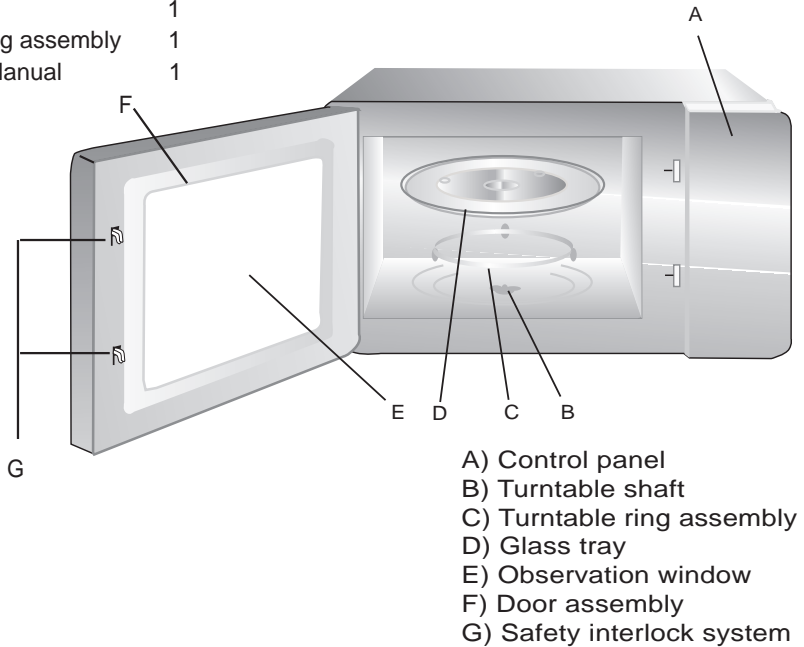

Turntable Installation

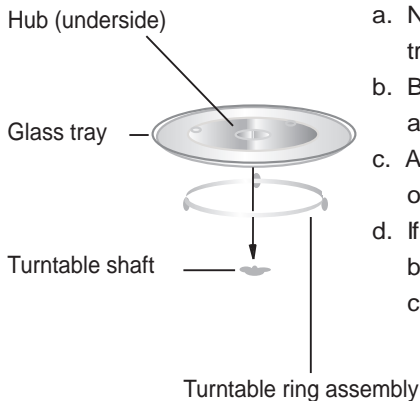

- Never place the glass tray upside down. The glass tray should never be restricted.
- Both glass tray and turntable ring assembly must always be used during cooking.
- All food and containers of food are always placed on the glass tray for cooking.
- If glass tray or turntable ring assembly cracks or breaks, contact your nearest authorized service center.

Countertop Installation

Remove all packing material and accessories. Examine the oven for any damage such as dents or broken door. Do not install if oven is damaged.

Cabinet: Remove any protective film found on the microwave oven cabinet surface. **Do not remove the light brown Mica cover that is attached to the oven cavity to protect the magnetron.**

Installation

1. Select a level surface that provide enough open space for the intake and/or outlet vents.

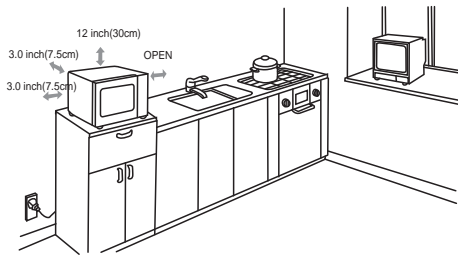

A minimum clearance of 3.0 inches (7.5cm) is required between the oven and any adjacent walls. One side must be open.

- (1) Leave a minimum clearance of 12 inches (30cm) above the oven.
- (2) Do not remove the legs from the bottom of the oven.

- (3) Blocking the intake and/or outlet openings can damage the oven.
 - (4) Place the oven as far away from radios and TV as possible. Operation of microwave oven may cause interference to your radio or TV reception.
2. Plug your oven into a standard household outlet. Be sure the voltage and the frequency is the same as the voltage and the frequency on the rating label.

WARNING: Do not install oven over a range cooktop or other heat-producing appliance. If installed near or over a heat source, the oven could be damaged and the warranty would be void.

OPERATION

Control Panel and Features

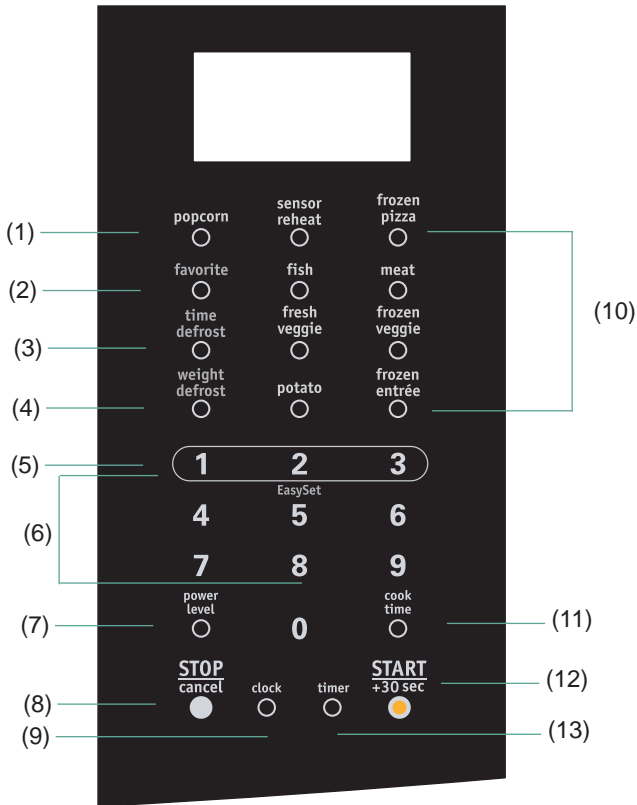

(1) Popcorn

(2) Favorite

(3) Time defrost

(4) Weight Defrost

(5) Express cooking button

(6) Number Keys

(7) Power level

(8) **Stop/Cancel:** clears all previous settings pressed before cooking starts.

During cooking: press once to stop oven; twice to stop and clear all entries.

(9) Clock

(10) Auto menu

(11) Cook time

(12) Start/+30Sec.

(13) Timer

OPERATION

1. Power Level

Ten power levels are available.

Level	10	9	8	7	6	5	4	3	2	1
Power	100%	90%	80%	70%	60%	50%	40%	30%	20%	10%
Display	PL10	PL9	PL8	PL7	PL6	PL5	PL4	PL3	PL2	PL1

Remarks: when a power between level 10-8 is chosen, the high level indicator is lighted and it will flash when in operation.

When a power between level 7-1 is chosen, the low level indicator is lighted and it will flash when in operation.

2. Clock Setting

When the microwave oven is plugged into a outlet, the oven will display " 0:00 "

- (1) Press " **CLOCK**", LED will display 00:00, clock indicator will be lighted. The hour figures will flash; ":" and "0" will be lighted.
- (2) Press the number keys and enter the correct time. For example,time is 10:12 now, please press "1,0,1,2" in turn.
- (3) Press " **CLOCK**" to finish clock setting, and the clock indicator will go out. ":" will flash and the clock will be lighted.
- (5) If the numbers input are not within the range of 1:00--12:59, the setting will be invalid until valid numbers are input.

Note: In the process of clock setting, if the " **STOP/CANCEL** " button is pressed or if there is no operation within 1 minute, the oven will go back to the former state automatically.

3. Kitchen Timer

- (1) Press " **TIMER** ", LED will display 00:00, clock indicator will be lighted.
- (2) Press the number keys and enter the correct timer.(The maximum time is 99 minutes and 99 seconds)
- (3) Press " **START/+30SEC.** " to confirm setting, clock indicator will be lighted.
- (4) When the kitchen time arrives, clock indicator will go out. The buzzer will ring 5 times. If the clock be set (12-hour system), LED will display the current time by counting down.

Note: 1)The kitchen time is differ from 12-hour system,Kitchen Timer is a timer.

That is to say it processes the function of alarming clock.

2)During timer process,any program cannot be set. Time cannot be increased by pressing "**START/+30SEC.**" key.

4. Microwave cook

- (1) Press "**COOK TIME**" once, LED will display "00:00".
- (2) Press number keys to input the cooking time; the maximum cooking time is 99 minutes and 99 seconds.

(3) Press "**POWER LEVEL**" once, LED will display "PL10". The default power is 100% power. Now you can press number keys to adjust the power level.

(4) Press "**START/+30SEC.**" to start cooking.

Example: to cook the food with 50% microwave power for 15 minutes.

a. Press "**COOK TIME**" once."00:00" displays.

b. Press "1", "5", "0", "0" in order.

c. Press "**POWER LEVEL**" once, then press "5" to select 50% microwave power.

d. Press "**START/+30SEC.**" to start cooking.

Note: In the process of cooking, if the "**STOP/CANCEL**" button is pressed or if there is no operation within 1 minute, the oven will go back to the former setting automatically.

5. Express Cooking

(1) In waiting state, instant cooking at 100% power level can be started by select a cooking time from 1 to 3 minutes by pressing number pads 1 to 3. Press "**START/+30SEC.**" to increase the cooking time; the maximum cooking time is 99 minutes and 99 seconds.

(2) In waiting state, instant cooking at 100% power level with 30 seconds' cooking time can be started by pressing "**START/+30SEC**". Each press on the same button will increase cooking time by 30 seconds. the maximum cooking time is 99 minutes and 99 seconds.

(3) Press "**COOK TIME**" first and adjust cooking time, then press "**START/+30SEC**" to start cooking with full microwave power.

Note: Under microwave, time defrost and popcorn states, press "**START/+30SEC**" button to increase cooking time by 30 seconds.

6. Weight Defrost Function

(1) Press "**WEIGHT DEFROST**", LED will display "0.0".

(2) Press numerical buttons to input weight to be defrosted.

Input the weight ranged should be between 0.3~6.3 Lbs.

(3) If the weight input is not within 0.3~6.3 Lbs, the input will be invalid. No "beep" will be sound and the unit will not work until valid numbers are input.

(4) Press "**START/+30SEC.**" to start defrosting and the cooking time remained will be displayed.

7. Time Defrost Function



(1) Press "**TIME DEFROST**", LED will display "00:00".

(2) Press numerical buttons to input defrost time to be defrosted.



Input the time ranged is between 0:01~99:99.

(3) Press "**START/+30SEC.**" to start defrosting. The default microwave power is PL3. The power cannot be adjusted.

8.POPCORN

a) Press "**POPCORN**" repeatedly until the weight you needed appears in the display, ", "" and "Oz" light.

For example, press "**POPCORN**" twice, "1.75" displays.

b) Press "**START/+30SEC.**" to cook, "Oz" disappears, ", "" are flashing.

Times(Press " POPCORN ")	Weight	Display
Once	3.0 Oz	3.0
Twice	1.75 Oz	1.75
Thrice	3.5 Oz	3.5

9.Sensor Cook

1) In waiting state,press the menu key in the sensor cook, put the food in the oven.

For example: if frozen entree is selected, " SC-8" is displayed.

2) Press "**START/+30SEC**" to start sensor reheat function and no need to set time.

3) The sensor will sound twice when the steaming is emanated.The surplus time will display, the buzzer will sound 5 beeps when finishing. At last, the oven will turn back to the waiting state.

Note:

1)When cooking or reheating food, you should do these in order to have the best effect.

a.The room temperature cannot be over 35 degrees.

b.The weight of food must be more than 110g (4 Oz).

c.The cavity,glass tray and utensils must kept drying before putting the food in.

d.The reheat food can be covered with the lid.But the lid must has venthole in order to emanate the steam.Sealed utensil is forbidden.

2) During cooking process, following points must be done.

a.Keep the door close when the surplus time not displays or the buzzer does not sound twice.

b.When the buzzer sound twice , the time will count down and display the suplus time, you can open the door to mix the food up ,turn over or replace the food. And then go on the next operation.

3) Please leave the food alone for a while after cooking have been finished.

4) During sensor cooking process, if the time not count down,please **do not** open the oven door or press "**STOP/CANCEL**" key. Otherwise,the sensor will make mistakes.

For example: to use the menu of potato.

1)Press "**POTATO**" key once, "SC-7" displays.

Put the food in the cavity ,the max. amount is 4 and each is about 8 Oz.

2) Press "**START/+30SEC**" key ,the buzzer will sound once and the sensor cooking starts.

3)The buzzer will sound twice when the sensor induce the steam.Time will counts down and display the surplus cooking time.

When the cooking have been finished, the buzzer will sound 5 beeps and the oven will turn back to the waiting states.

Note:a.Each potato is stabbed 6 finestra with the fork on surface.

b.Place the potato on the edge of glass tray, if more potatoes, please keep them deteched and the interval of each one is 2.5mm.

c.When the buzzer sound 2 beeps, the time counts down and display the suplus time,please open the door to turn the food over.

Sensor Cook Chart

Menu	Weight	Inicial Temp.	Additional Instructions
SC-1 Sensor Reheat	8~12 Oz (225~340g)	5 degrees	The food reheated is Dinner Plate. It may be covered with a lid.but the lid must have a vent hole so that steam can escape.Sealed utensils are not permitted.When cooking time counts down. Press "Stop/cancel"to pause and open the oven door to mix and then continue to cook.
SC-2 Frozen Pizza	6~12 Oz (170~340g)	minus 18 degrees	If the weight is over 12 OZ,please set the additional cooking time manually.
SC-3 Fish	4~16 g (110~450g)	5 degrees	Arrange in a single layer. Cover with lid or vented plastic wrap.Cover the film before cooking and leave a spacing near the edge of the container in order to let the steam out. When cooking time counts down, press "STOP" to pause and open the oven door to turn over and then continue to cook.
SC-4 Meat	8~24 Oz (225~680g)	5 degrees	Break apart in glass bowl or colander. Cover with lid or vented plastic wrap. Juices should be clear when done, Drain.When cooking time counts down. Press "STOP" to pause and open the oven door to mix and then continue to cook.
SC-5 Fresh Veggie	4~16Oz (110~450g)	Room Temp.	All pieces should be the same size. Wash thoroughly, add 15ml water per 125g vegetables, and cover with a lid or vented plastic wrap. When cooking time counts down. Press "STOP" to pause and open the oven door to mix and then continue to cook.
SC-6 Frozen Veggie	6~16Oz (170~450g)	minus 18 degrees	Wash thoroughly, add 15ml water per 125g vegetables, and cover with a lid or vented plastic wrap. Do not salt/butter vegetables until after cooking.
SC-7 Potato	1~4 Unit (6~8Oz each one)	Room Temp.	Pierce each potato with a fork 6 times around it's surface. Place potatoes around the edge of a paper-towel-lined turntable. Do not cover. If additional time is needed, continue to cook manually. Please let stand for 5 minutes in the oven after finishing to avoid burning.
SC-8 Frozen Entree	8~32 Oz (225~900g)	minus 18 degrees	Be careful when removing the film cover after cooking. Remove Facing away from you to avoid steam burns. If additional time is needed, continue to cook manually. Cover the film before cooking and leave a spacing near the edge of the container in order to let the steam out. When buzzer sound twice, cooking time counts down. Press "STOP" to pause and open the oven door to mix.

Sensor Reheat

- 1) In waiting states, press "**SENSOR REHEAT**". And put the food into the microwave oven. "SC-1" is displayed.
- 2) Press "**START/+30SEC**" to start sensor reheat function and no need to set time.
- 3)The sensor will sound twice when the steaming was be emanated.The surplus time will displays, the buzzer will sound 5 beeps when finishing and the oven will turn back to the waiting states.

Note:1) Food to be avoided in sensor reheating.

- a.Bread and other dry food, such as biscuit, cake.
 - b.For raw or uncooked foods.
 - c.Beverage and frozen food.
- 2)The oven cannot cook automatically when the temperature of the oven cavity is high.
 - 3)The reheat food can be covered with the lid.But the lid must has venthole in order to emanate the steam. Sealed utensil is forbidden.
 - 4) The inicial temperature is 5 degrees.cover with a lid or vented plastic wrap. The food should be dinner plate.
 - 5) During sensor cooking process, please **do not** open the oven door or press "**STOP/CANCEL**" key. Otherwise,the sensor will make mistakes.
 - 6)The sensor reheat has different request for different food.

Casseroles- Add 2 to 3 tablespoons of liquid, cover with lid or vented plastic wrap.

Stir when time appears in the display window.

Canned foods-Empty contents into casserole dish or serving bowl,cover dish with lid or vented plastic wrap. After reheating, let stand for a few minutes.

Plate of food- Arranged food on plate; top with butter, gravy,etc. Cover with lid or vented plastic wrap. After reheating, let stand for a few minutes.

10. MEMORY FUNCTION

- (1) Press "**FAVORITE**" to choose memory 1-3 procedure. 1,2,3 will display.
- (2) If the program has been set, press "**START/+30SEC.**" to use it. If not, continue to set the procedure. Only one or two stages can be set.
- (3) After finishing the setting, press "**FAVORITE**" to save the program and turn back to the waiting states. If press "**START/+30SEC.**" ,it can save and operate the setting.

Example: save one program as memory 2. To cook the food with 80% microwave power for 3 minutes and 20 seconds. Operate the following steps:

- a. In waiting states, press "**FAVORITE**" twice, "2" displays.
- b. Press "**COOK TIME**", then input number keys "3", "2", "0" to choose the cooking time.
- c. Press "**POWER LEVEL**" once, then press number button "8", "PL8" displays.
- d. Press "**FAVORITE**" to save the current setting. If press "**START/+30SEC.**", the cooking program can be operated and save it as memory 2.
- e. To run the saved program, in waiting states, press "**FAVORITE**" twice, "2" displays and press "**START/+30SEC.**" to run the saved cooking program.

11. Multi-section cooking

At most 2 sections can be set for cooking. In multi-section cooking, if one section is defrosting, then defrosting shall be placed in the first section. When the first stage finish, the buzzer will sound once and the next stage will begin cooking.

Example: if you want to cook with 80% microwave power for 5 minutes + 60% microwave power for 10 minutes. The cooking steps are as following.

- (1) Press "**COOK TIME**" once, then press "5", "0", "0" to set 5 minutes.
- (2) Press "**POWER LEVEL**" once.
- (3) Press number button "8" to set 80% microwave power.
- (4) Press "**COOK TIME**" once, then press "1", "0", "0", "0" to set 10 minutes.
- (5) Press "**POWER LEVEL**" once.
- (6) Then press press number button "6" to set 60% microwave power.
- (7) Press "**START/+30SEC.**" to start cooking.

12. INQUIRING FUNCTION

- 1) In cooking state, press " **CLOCK** ", the clock will displays for three seconds. After that, the oven will turn back to the clock state.
- 2) In the microwave cooking state, press " **POWER LEVEL** " to inquire microwave power level the current microwave power will be displayed. After three seconds, the oven will turn back to the previous state. In the 2 stage cooking state, the inquiring way can be done by the same way as above.

13. LOCK FUNCTION FOR CHILDREN

Lock: In waiting state, press " **STOP/CANCEL** " for 3 seconds, there will be a long "beep" denoting the entering into the children-lock state; meanwhile, the lock indicator will appear.

Unlock: In locked state, press " **STOP/CANCEL** " for 3 seconds, there will be a long "beep" denoting that lock is released.

14. COOKING END REMINDING FUNCTION

When the cooking is over, the buzzer will sound 5 "beep" to reminds user the cooking is finished.

15. OTHER SPECIFICATIONS

- (1) In waiting state , if the current time displays, the icon " : " would flash; otherwise, it shows " **0:00** ".
- (2) In setting function state, the corresponding setting displays.
- (3) In working or pause state, the surplus cooking time displays.

Maintenance

Troubleshooting

Check your problem by using the chart below and try the solutions for each problem. If the microwave oven still does not work properly, contact the nearest authorized service center.

TROUBLE	POSSIBLE CAUSE	POSSIBLE REMEDY
Oven will not start	<ul style="list-style-type: none">a. Electrical cord for oven is not plugged in.b. Door is open.c. Wrong operation is set.	<ul style="list-style-type: none">a. Plug into the outlet.b. Close the door and try again.c. Check instructions.
Arcing or sparking	<ul style="list-style-type: none">a. Materials to be avoided in microwave oven were used.b. The oven is operated when empty.c. Spilled food remains in the cavity.	<ul style="list-style-type: none">a. Use microwave-safe cookware only.b. Do not operate with oven empty.c. Clean cavity with wet towel.
Unevenly cooked foods	<ul style="list-style-type: none">a. Materials to be avoided in microwave oven were used.b. Food is not defrosted completely.c. Cooking time, power level is not suitable.d. Food is not turned or stirred.	<ul style="list-style-type: none">a. Use microwave-safe cookware only.b. Completely defrost food.c. Use correct cooking time, power level.d. Turn or stir food.
Overcooked foods	Cooking time, power level is not suitable.	Use correct cooking time, power level.
Undercooked foods	<ul style="list-style-type: none">a. Materials to be avoided in microwave oven were used.b. Food is not defrosted completely.c. Oven ventilation ports are restricted.d. Cooking time, power level is not suitable.	<ul style="list-style-type: none">a. Use microwave-safe cookware only.b. Completely defrost food.c. Check to see that oven ventilation ports are not restricted.d. Use correct cooking time, power level.
Improper defrosting	<ul style="list-style-type: none">a. Materials to be avoided in microwave oven were used.b. Cooking time, power level is not suitable.c. Food is not turned or stirred.	<ul style="list-style-type: none">a. Use microwave-safe cookware only.b. Use correct cooking time, power level.c. Turn or stir food.