

INSTRUCTION MANUAL

MICROWAVE OVEN

EC9P04-S00K00

Please review this instruction manual before operating.

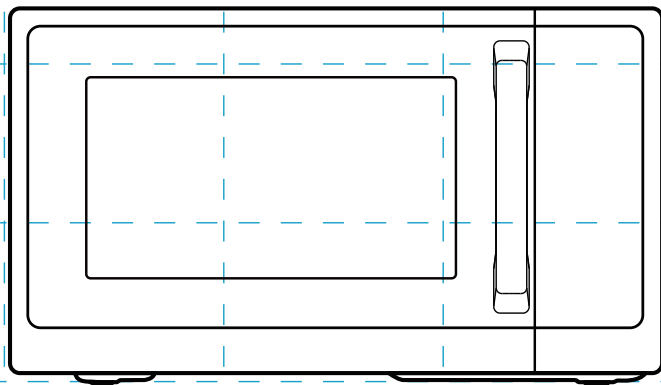

CONTENTS

PRODUCT SAFETY

Precautions to avoid possible exposure to excessive microwave energy	EN-01
Specifications	EN-02
Important safety instructions	EN-03
Grounding instructions.....	EN-07
Radio interference	EN-09
Utensils.....	EN-10
Materials you can use in microwave oven	EN-11
Materials can not be used in microwave oven	EN-13

PRODUCT SETTING

Names of microwave oven parts and accessories	EN-14
Door opening guidance	EN-15
Turntable installation.....	EN-16
Countertop installation	EN-17
Installation	EN-17

INSTRUCTION FOR USE

Before using for the first time	EN-18
Operation	EN-19
Control panel and features	EN-19
1. Setting the clock	EN-20
2. Setting the kitchen timer	EN-20
3. Microwave cooking	EN-21
4. Speedy cooking	EN-22
5. Broil cooking	EN-22
6. Combination cooking	EN-23

7. Convection cooking without preheat function.....	EN-24
8. Convection cooking with preheat function	EN-25
9. Defrost by weight	EN-26
10. Defrost by time	EN-26
11. Potato, popcorn, pizza, reheat	EN-27
12. Auto menu	EN-28
13. Airfry menu	EN-30
14. Manual airfry cooking	EN-31
15. Multi-stage cooking	EN-32
16. Eco function	EN-33
17. Lock function for children	EN-33
18. Inquiring function	EN-33

CLEANING AND MAINTENANCE

Cleaning.....	EN-34
Trouble shooting	EN-36



NOTE

BEFORE OPERATING THIS PRODUCT, READ, UNDERSTAND, AND FOLLOW THESE INSTRUCTIONS. BE SURE TO SAVE THIS BOOKLIST FOR FUTURE REFERENCE.

PRODUCT SAFETY

PRECAUTIONS TO AVOID POSSIBLE EXPOSURE TO EXCESSIVE MICROWAVE ENERGY

- (a). Do not attempt to operate this oven with the door open since open door operation can result in harmful exposure to microwave energy.
It is important not to defeat or tamper with the safety interlocks.

- (b). Do not place any object between the oven front face and the door or allow soil or cleaner residue to accumulate on sealing surfaces.

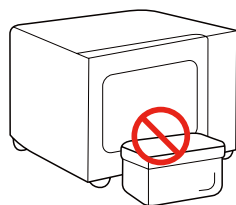

- (c). Do not operate the oven if it is damaged. It is particularly important that the oven door closes properly and that there is no damage to the:
- (1). DOOR (bent)
 - (2). HINGES AND LATCHES (broken or loosened)
 - (3). DOOR SEALS AND SEALING SURFACES
- (d). The oven should not be adjusted or repaired by anyone except properly qualified service personnel.

SPECIFICATIONS

MODEL	EC9P04-S00K00
RATED VOLTAGE	120VAC 60Hz
RATED INPUT POWER (MICROWAVE)	1450 W
RATED OUTPUT POWER (MICROWAVE)	900 W
GRILL	1000 W
CONVECTION	1500 W



NOTE

All pictures in this manual are for illustrative purposes only; these may be slightly different from the purchased equipment, please refer to the actual product.

IMPORTANT SAFETY INSTRUCTIONS



WARNING

When using electrical appliances basic safety precautions should be followed, including the following. To reduce the risk of burns, electric shock, fire, injury to persons or exposure to excessive microwave energy.



Read all instructions before using the appliance.



Read and follow the specific:
"PRECAUTIONS TO AVOID POSSIBLE EXPOSURE TO EXCESSIVE MICROWAVE ENERGY" found on page 1.



This appliance must be grounded. Connect only to properly grounded outlet. See **"GROUNDING INSTRUCTIONS"** found on page 7.



Install or locate this appliance only in accordance with the provided installation instructions.



HOT CONTENTS CAN CAUSE SEVERE BURNS. DO NOT ALLOW CHILDREN TO

USE THE MICROWAVE.

Use caution when removing hot items.



When cleaning surfaces of door and oven that comes together on closing the door, use only mild, nonabrasive soaps, or detergent applied with a sponge or soft cloth. Please keep the wave guide area clean. Use soft damp cloth to clean it up when there is food splash residue on the wave guide area or the cavity. Failure to clean food residue may cause innocuous sparking or some smoke in the microwave cavity, discoloration of the cavity may also occur.

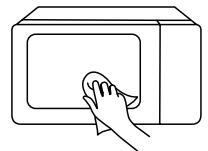

IMPORTANT SAFETY INSTRUCTIONS

 Keep cord away from heated surface.

 Liquids, such as water, coffee, or tea are able to overheat beyond the boiling point without appearing to be boiling. Visible bubbling or boiling when the container is removed from the microwave oven is not always present.

THIS COULD RESULT IN VERY HOT LIQUID SUDDENLY BOILING OVER WHEN THE CONTAINER IS DISTURBED OR A SPOON OR OTHER UTENSIL IS INSERTED INTO THE LIQUID. To reduce the risk of injury to persons:

1. Do not overheat the liquid.
2. Stir the liquid both before and halfway through heating it.
3. Do not use straight-sided containers with narrow necks.
4. After heating, allow

the container to stand in the microwave oven for a short time before removing the container.

5. Use extreme care when inserting a spoon or other utensil into the container.

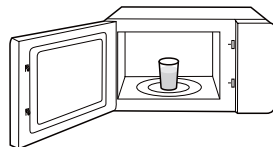

 Oversized food or oversized metal utensils should not be inserted in a microwave/toaster oven as they may create a fire or risk of electric shock.

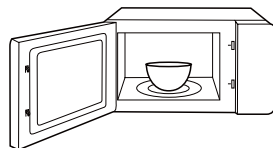

 This appliance should be serviced only by qualified service personnel. Contact nearest authorized service facility for examination, repair, or adjustment.

IMPORTANT SAFETY INSTRUCTIONS

 To reduce the risk of fire in the oven cavity:

1. Do not overcook food. Carefully attend appliance when paper, plastic, or other combustible materials are placed inside the oven to facilitate cooking.
2. Remove wire twist-ties from paper or plastic bag before placing bag in oven.
3. If material inside of the oven ignites, keep oven door closed, turn oven off, and disconnect the power cord, or shut off power at the fuse or circuit breaker panel.
4. Do not use the cavity for storage purposes. Do not leave paper products, cooking utensils, or food in the cavity when not in use.

 Some products such as whole eggs and sealed containers, for example, closed glass jars are able to explode and should not be heated in this oven.

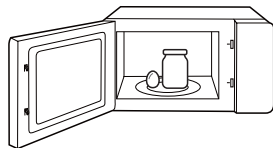

 Do not store this appliance outdoors. Do not use this product near water - for example, near a kitchen sink, in a wet basement, near a swimming pool, or similar location.

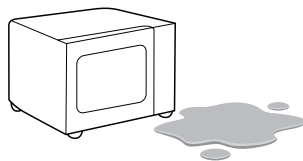



 Do not immerse cord or plug in water or any other liquid.





IMPORTANT SAFETY INSTRUCTIONS

 Use this appliance only for its intended use as described in the manual. Do not use corrosive chemicals or vapors in this appliance. This type of oven is specifically designed to heat, cook or dry food. It is not designed for industrial or laboratory use.

 Do not operate this appliance if it has a damaged cord or plug, if it is not working properly, or if it has been damaged or dropped.

 Do not clean with metal scouring pads. Pieces can burn off the pad and touch electrical parts involving a risk of electric shock.

 Do not cover or block any openings on the appliance.

 Do not let cord hang over edge of table or counter.

 Do not use paper products when appliance is operated in the toaster mode.

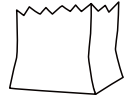

 Do not store any materials, other than manufacturer's recommended accessories, in this oven when not in use.

 Do not cover racks or any other part of the oven with metal foil. This will cause over-heating of the oven.

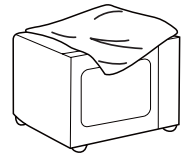

SAVE THESE INSTRUCTIONS
HOUSEHOLD USE ONLY(NOT FOR
COMMERCIAL USE)

GROUNDING INSTRUCTIONS

This appliance must be grounded. In the event of an electrical short circuit, grounding reduces the risk of electric shock by providing an escape wire for the electric current. This appliance is equipped with a cord having a grounding wire with a grounding plug. The plug must be plugged into an outlet that is properly installed and grounded.

WARNING - Improper use of the grounding can result in a risk of electric shock. Consult a qualified electrician or serviceman if the grounding instructions are not completely understood, or if doubt exists as to whether the appliance is properly grounded. If it is necessary to use an extension cord, use only a 3-wire extension cord that has a 3-blade grounded plug, and 3-slot receptacle that will accept the plug on the appliance. The marked rating of the extension cord shall be equal to or greater than the electrical rating of the appliance.



DANGER

Electric Shock Hazard:

Touching some of the internal components can cause serious personal injury or death. Do not disassemble this appliance.

GROUNDING INSTRUCTIONS



WARNING

Electric Shock Hazard:

Improper use of the grounding can result in electric shock. Do not plug into an outlet until appliance is properly installed and grounded.

1. A short power-supply cord is provided to reduce the risks resulting from becoming entangled in or tripping over a longer cord.
2. Longer cord sets or extension cords are available and may be used if care is exercised in their use.
3. If a long cord or extension cord is used:
 - (1). The marked electrical rating of the cord set or extension cord should be at least as great as the electrical rating of the appliance.
 - (2). The extension cord must be a grounding-type 3-wire cord.
 - (3). The longer cord should be arranged so that it will not drape over the counter top or tabletop where it can be pulled on by children or tripped over unintentionally.

RADIO INTERFERENCE

1. Operation of the microwave oven may cause interference to your radio, TV or similar equipment.
2. When there is interference, it may be reduced or eliminated by taking the following measures:
 - (1).Clean door and sealing surface of the oven.
 - (2).Reorient the receiving antenna of radio or television.
 - (3).Relocate the microwave oven with respect to the receiver.
 - (4).Move the microwave oven away from the receiver.
 - (5).Plug the microwave oven into a different outlet so that microwave oven and receiver are on different branch circuits.
3. This equipment generates, uses and can radiate radio frequency energy and, if not installed and used in accordance with the instructions, may cause harmful interference to radio communications. However, there is no guarantee that interference will not occur in a particular installation. If this equipment does cause harmful interference to radio or television reception, which can be determined by turning the equipment off and on, the user is encouraged to try to correct the interference by one or more of the following measures:
 - (1) Reorient or relocate the receiving antenna.
 - (2) Increase the separation between the equipment and receiver.
 - (3) Connect the equipment into an outlet on a circuit different from that to which the receiver is connected.
 - (4) Consult the dealer or an experienced radio/TV technician for help.

This device complies with part 18 of the FCC Rules.

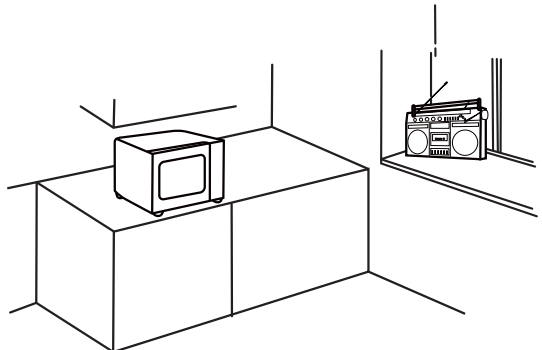

UTENSILS



CAUTION

Personal Injury Hazard:

Tightly-closed utensils could explode. Closed containers should be opened and plastic pouches should be pierced before cooking.

See the instructions on "**Materials you can use in microwave oven.**" or "**Materials can not be used in microwave oven .**"

There may be certain non-metallic utensils that are not safe to use for microwaving. If in doubt, you can test the utensil in question following the procedure below.

Utensil Test:

1. Fill a microwave-safe container with 1 cup of cold water (250ml) along with the utensil in question.
2. Cook on maximum power for 1 min.
3. Carefully feel the utensil. If the empty utensil is warm, do not use it for microwave cooking.
4. Do not exceed 1 min cooking time.

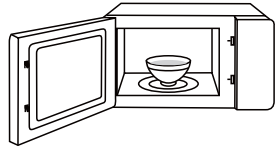





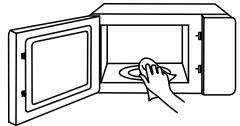











NOTE









KEEP THE CAVITY AND
WAVEGUIDE AREA CLEAN

















MATERIALS YOU CAN USE IN MICROWAVE OVEN

UTENSILS	REMARKS
 Browning dish	Follow manufacturer's instructions. The bottom of browning dish must be at least 3/16 inch (5mm) above the turntable. Incorrect usage may cause the turntable to break. 
 Dinnerware	Microwave-safe only. Follow manufacturer's instructions. Do not use cracked or chipped dishes. 
 Glass jars	Always remove lid. Use only to heat food until just warm. Most glass jars are not heat resistant and may break. 
 Glassware	Heat-resistant oven glassware only. Make sure there is no metallic trim. Do not use cracked or chipped dishes. 
 Oven cooking bags	Follow manufacturer's instructions. Do not close with metal tie. Make slits to allow steam to escape. 
 Paper plates and cups	Use for short-term cooking/warming only. Do not leave oven unattended while cooking. 
 Paper towels	Use to cover food for reheating and absorbing fat. Use with supervision for a short-term cooking only. 
 Parchment paper	Use as a cover to prevent splattering or a wrap for steaming. 

MATERIALS YOU CAN USE IN MICROWAVE OVEN

UTENSILS	REMARKS
 <p data-bbox="169 454 240 478">Plastic</p>	<p data-bbox="349 359 900 494">Microwave-safe only. Follow the manufacturer's instructions. Should be labeled "Microwave Safe". Some plastic containers soften, as the food inside gets hot. "Boiling bags" and tightly closed plastic bags should be slit, pierced or vented as directed by package.</p> 
 <p data-bbox="147 638 262 662">Plastic wrap</p>	<p data-bbox="349 558 900 638">Microwave-safe only. Use to cover food during cooking to retain moisture. Do not allow plastic wrap to touch food.</p> 
 <p data-bbox="131 805 278 829">Thermometers</p>	<p data-bbox="349 750 889 774">Microwave-safe only (meat and candy thermometers).</p> 
 <p data-bbox="152 965 256 989">Wax paper</p>	<p data-bbox="349 901 819 949">Use as a cover to prevent splattering and retain moisture.</p> 

MATERIALS CAN NOT BE USED IN MICROWAVE OVEN

UTENSILS	REMARKS
 <p>Aluminum tray</p>	May cause arcing. Transfer food into microwave-safe dish. 
 <p>Food carton with metal handle</p>	May cause arcing. Transfer food into microwave-safe dish. 
 <p>Metal or metal trimmed utensils</p>	Metal shields the food from microwave energy. Metal trim may cause arcing. 
 <p>Metal twist ties</p>	May cause arcing and could cause a fire in the oven. 
 <p>Paper bags</p>	May cause a fire in the oven. 
 <p>Plastic foam</p>	Plastic foam may melt or contaminate the liquid inside when exposed to high temperature. 
 <p>Wood</p>	Wood will dry out when used in the microwave oven and may split or crack. 

PRODUCT SETTING

NAMES OF MICROWAVE OVEN PARTS AND ACCESSORIES

Remove the oven and all materials from the carton and oven cavity.

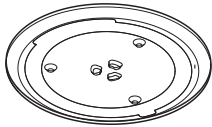

Glass Tray

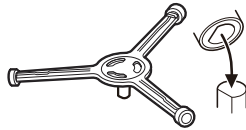

Turntable Ring Assembly

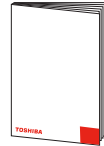

Instruction Manual

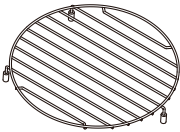

Lower Grill Rack(Can not be used in microwave function and must be placed on the glass tray.)

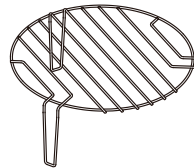

Higher Grill Rack(Can not be used in microwave function and must be placed on the glass tray.)

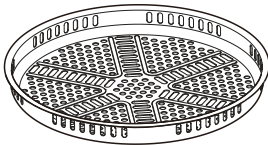

Bake Tray (Cannot be used in conjunction with microwave function and can be placed on the grill rack.)

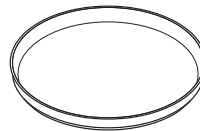

Bake Tray (Cannot be used in conjunction with microwave function and can be placed on the grill rack.)



NOTE

In case of any differences between the appliance and the pictures in this manual, the product shall prevail.

NAMES OF MICROWAVE OVEN PARTS AND ACCESSORIES

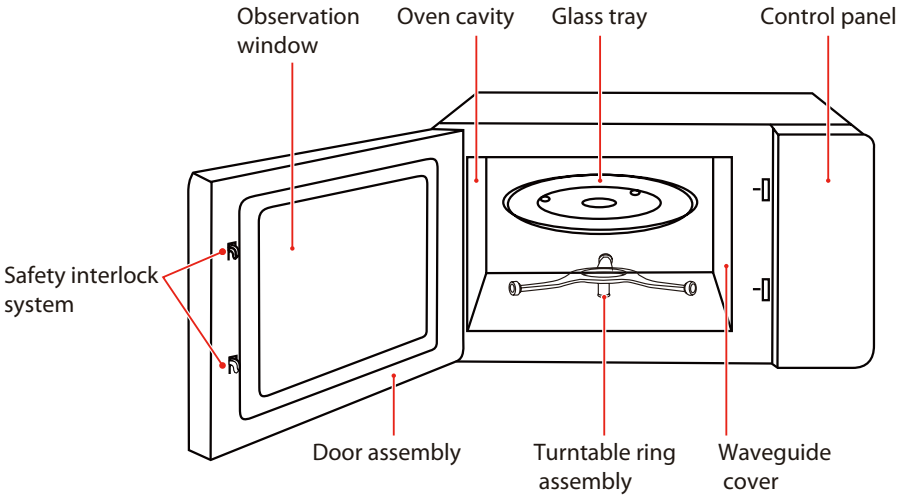

DOOR OPENING GUIDANCE

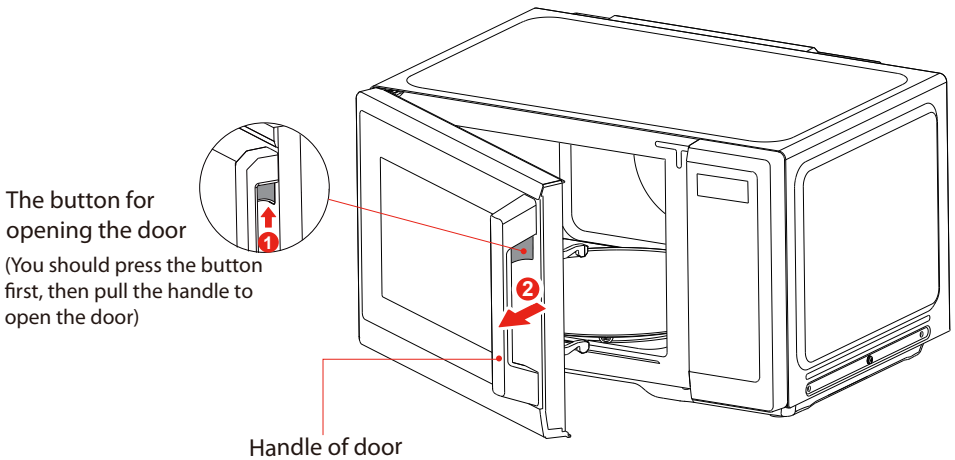

NOTE

In case of any differences between the appliance and the pictures in this manual, the product shall prevail.

TURNTABLE INSTALLATION

Clean the cooking compartment and place the turntable.

For new installations, make sure all packaging and shipping tape has been removed from the turntable shaft.

Before using the appliance to prepare food for the first time, you will need to put the turntable in place correctly. You must clean the cooking compartment and accessories. You can also refer them to the cleaning section.

How to put the turntable in place:

1. Place the turntable ring assembly ② into the recess in the cooking compartment.
2. Place the glass tray ① on the turntable ring assemblies ②.

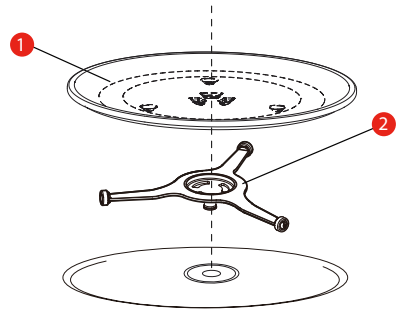

- 1) Glass Tray
2) Turntable Ring Assembly

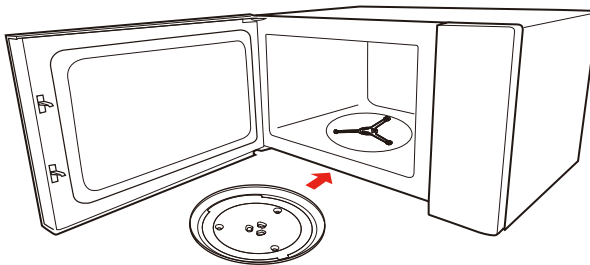

NOTE

- Never use the appliance without the turntable. Make sure that it is properly engaged. The turntable can turn clockwise or anti-clockwise.
- Never place the glass tray upside down. The glass tray should never be restricted.
- Both glass tray and turntable ring assembly must always be used during cooking.
- All food and containers of food are always placed on the glass tray for cooking.
- Never restrict the movement of the turntable.
- If glass tray or turntable ring assembly cracks or breaks, contact your nearest authorized service center.

COUNTERTOP INSTALLATION

Remove all packing material and accessories. Examine the oven for any damage such as dents or broken door. Do not install if the oven is damaged.

Cabinet: Remove any protective film found on the microwave oven cabinet surface. Do not remove the waveguide cover that is attached to the oven cavity to protect the magnetron.

INSTALLATION

1. Select a level surface that provides enough open space for the intake and/or outlet vents.
 - a. The minimum installation height is 36 inches.
 - b. Leave a minimum clearance of 3.0 inches on each side, 3.0 inches on top, and 1.0 inch on the rear.
 - c. Do not remove the legs from the bottom of the oven.
 - d. Blocking the intake and/or outlet openings can damage the oven.
 - e. Operation of microwave oven may cause interference to your radio or TV reception.
Please place the oven as far away from the radios and TV as possible.

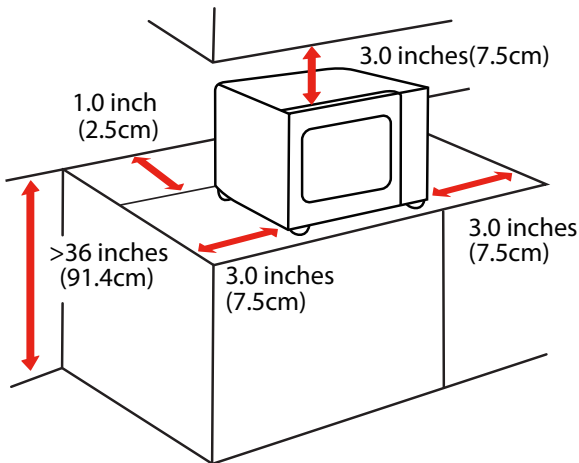

2. Plug microwave oven into a standard household outlet. Be sure the voltage and the frequency are the same as the voltage and the frequency on the rating label.



NOTE

- Do not install oven over a range cooktop or other heat-producing appliance. If installed near or over a heat source, the oven could be damaged and the warranty would be avoided.

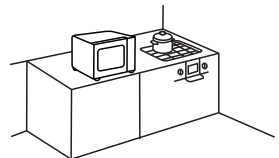

The accessible surface may be hot during operation

INSTRUCTION FOR USE

BEFORE USING FOR THE FIRST TIME

It is normal that the oven may produce unpleasant odors when it is used for the first time.

This section tells you what you need to do before using your microwave to prepare food for the first time. Read the section entitled "**PRODUCT SAFETY**" beforehand.

Before you can use your new appliance, you will need to put the turntable in place correctly. You must also clean the cooking compartment and accessories.



NOTE

- Never use the appliance without the turntable.
- Make sure that it is properly engaged. The turntable can turn clockwise or anti-clockwise.

OPERATION

CONTROL PANEL AND FEATURES

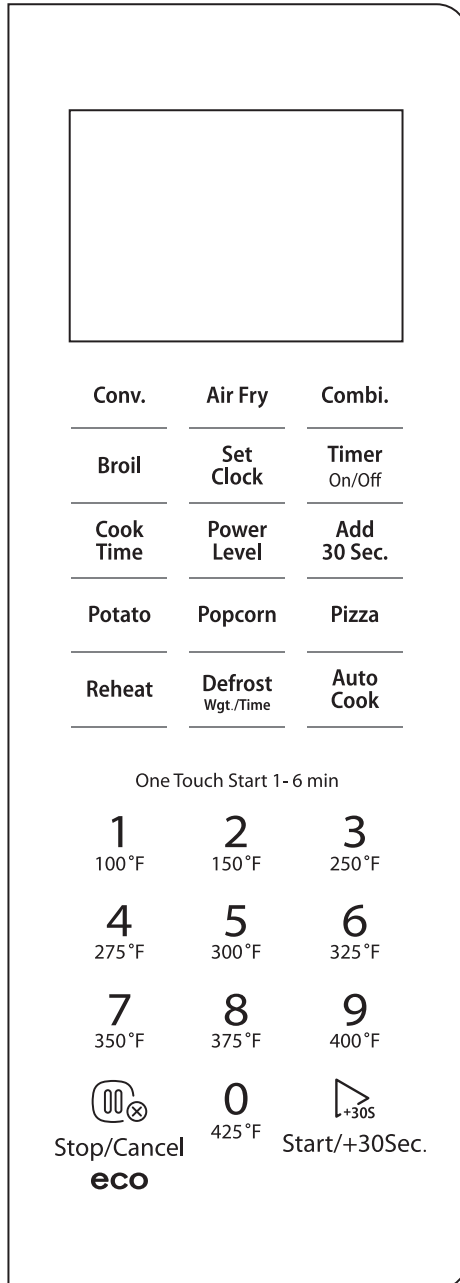

1. SETTING THE CLOCK

- 1 In standby mode, press " **Set Clock** " once, "12:00" will display.



- 2 Press the number keys to enter the time.
Example: To set the clock to 12:10, please press "1,2,1,0" in turn.

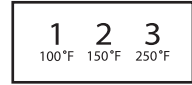

- 3 Press " **Set Clock** " to confirm.



NOTE

- The clock is a 12-hour display. If the clock is not set, it will not work when powered.
- To reset the clock, please repeat the step 1 to step 3.

2. SETTING THE KITCHEN TIMER

- 1 In standby mode, press " **Timer On/Off** " once, "00:00" displays.



- 2 Press the number keys to set the desired time.
The maximum time value is "99:99".



- 3 Press "  " to confirm. The timer starts counting down.



NOTE

- The kitchen timer is a timer.

3. MICROWAVE COOKING

Microwave Power Chart

Level	10	9	8	7	6	5	4	3	2	1
Power	100%	90%	80%	70%	60%	50%	40%	30%	20%	10%
Display	PL10	PL9	PL8	PL7	PL6	PL5	PL4	PL3	PL2	PL1

1 Press " **Cook Time** " once, and "0:00" displays.



2 Press the number keys to set the cooking time.
The maximum time value is "99:99".

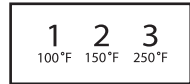

3 Press " **Power Level** " once, and "PL10" displays.

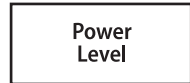

4 Press " **Power Level** " repeatedly or press the number key to adjust the power level. 10 power levels are available.

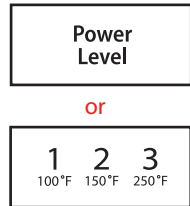

5 Press "  " to start cooking .



NOTE

• The power level can be changed during operation. Press " **Power Level** " once, the current power will display for 3 seconds. And then press " **Power Level** " repeatedly or press the number keys to change the power. The oven will work with the selected power.

4. SPEEDY COOKING

- 1 In standby mode, pressing number keys 1 to 6 lets you quickly select a cooking time from 1 to 6 minutes. Then you can press " **Add 30 Sec.** " to increase the cooking time. The maximum time value is "99:99".



NOTE

- The power level can be changed during operation. Press " **Power Level** " once, the current power will display for 3 seconds. Then press " **Power Level** " repeatedly or press the number keys to change the power. The oven will work with the selected power.

- 2 In standby mode, press " **Add 30 Sec.** " to cook food at 100% power level for 30 seconds. Each press on the same key can increase 30 seconds and the maximum time value is "99:99".



NOTE

- In the cooking state, each more press on " **Add 30 Sec.** " can increase the cooking time by 30 seconds (except for defrosting by weight and auto menu).

5. BROIL COOKING

- 1 In standby mode, press " **Broil** " once, "0:00" will display.



- 2 Press the number keys to set the cooking time. The maximum time value is "99:99".



- 3 Press "  " to start cooking.



6. COMBINATION COOKING

1 In standby mode, press "Combi." once, "C-1" will display. → 

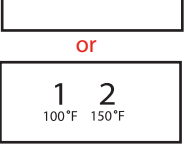
2 Press " Combi." repeatedly or press the number key "1" or "2" to select the mode. "C-1" and "C-2" are available. → 

3 Press " Start/+30Sec." to confirm. → 

4 Press the number keys to set the cooking time. The maximum time value is "99:99". → 

5 Press " Start/+30Sec." to start cooking. → 

Note: Combination instructions

Instructions	Display	Microwave	Grill	Convection
1	C-1	●		●
2	C-2	●	●	

7. CONVECTION COOKING WITHOUT PREHEAT FUNCTION

1 In standby mode, press " **Conv.** " once, and "100°F" will display. → 

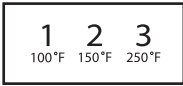

2 Press the number keys to set the temperature, "100°F, 150°F, 250°F, 275°F, 300°F, 325°F, 350°F, 375°F, 400°F, 425°F" are available. → 

3 Press "  " to confirm. → 

4 Press the number keys to set the cooking time. The maximum time value is "99:99". → 



5 Press "  " to start cooking. → 

8. CONVECTION COOKING WITH PREHEAT FUNCTION

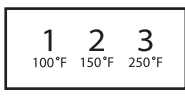
1 In standby mode, press "  Conv." once, and "100°F" will display. → 

2 Press the number keys to set the temperature, "100°F, 150°F, 250°F, 275°F, 300°F, 325°F, 350°F, 375°F, 400°F, 425°F" are available. → 

3 Press "  " to confirm. → 

4 Press "  " again to start preheating. When preheating is completed, the oven will beep. Open the door and place food in the oven. And then close the door. → 

5 Press the number keys to set the cooking time. The maximum time value is "99:99". → 

6 Press "  " to start cooking. → 

9. DEFROST BY WEIGHT

- 1 In standby mode, press "**Defrost**
Wgt./Time" once,
and "dEF1" will display.



- 2 Press the number keys to set the weight of
the food. The range of weight is 4 to 70 Oz.



- 3 Press ""
Start/+30Sec." to start defrosting.



NOTE

- The buzzer will sound to remind you to turn over the food during defrosting. If there is not any operation, it will keep on working.

10. DEFROST BY TIME

- 1 In standby mode, press "**Defrost**
Wgt./Time" twice,
and "dEF2" will display.



- 2 Press the number keys to set the time.
The maximum time value is "99:99".



- 3 Press ""
Start/+30Sec." to start defrosting.



NOTE

- The defrost power is PL3 and it cannot be changed.

11. POTATO, POPCORN, PIZZA, REHEAT

- 1** In standby mode, press the corresponding key once, and then the default weigh of food will display.

Example: Press " **Pizza** " once and then "4Oz" displays.

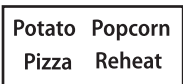

- 2** Press the corresponding key repeatedly or press the number key "1-3" to set the weight of the food.

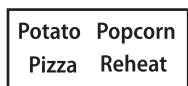

or

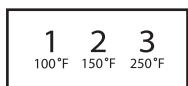



- 3** Press "  " to start cooking.



MENU	WEIGHT	POWER
Popcorn	1.75Oz	PL10
	3.0Oz	
	3.5Oz	
Pizza	4Oz	PL10
	8Oz	
	14Oz	
Potato	8Oz	PL10
	16Oz	
	24Oz	
Reheat	9Oz	PL10
	12Oz	
	18Oz	

12. AUTO MENU

1 In standby mode, press "  " once, "Ac-1" will display. → 

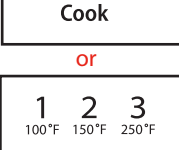
2 Press "  " repeatedly or press the number key "1-7" to select the menu. "Ac-1-Ac-7" are available. → 

3 Press "  " to confirm. → 

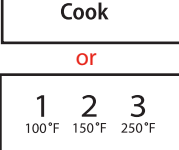
4 Press "  " repeatedly or press the number key "1-3" to select the weight of the food. → 

5 Press "  " to start cooking. → 

NOTE



- For menus "Ac-5" to "Ac-7", please skip the steps 3-4.

Auto Menu Chart

DISPLAY	MENU	WEIGHT	POWER
Ac-1	Beverage	4Oz	PL10
		8Oz	
		12Oz	
Ac-2	Dinner Plate	9Oz	PL10
		12Oz	
Ac-3	Soup	8Oz	PL10
		16Oz	
		24Oz	
Ac-4	Vegetables	4Oz	PL10
		8Oz	
		16Oz	
Ac-5	Oatmeal	28Oz	PL10
Ac-6	Cake	16Oz	Conv. 350°F with preheat
Ac-7	Cookie	7.5Oz	Conv. 375°F with preheat

13. AIRFRY MENU

1 In standby mode, press and hold " Air Fry " for 3 seconds, "AF01" will display. → 

2 Press " Air Fry " repeatedly or press the number key to select the menu. → 
"AF01-AF10" are available. 

3 Press "  " to start cooking. → 

NOTE

- For menus "AF02" to "AF10", the buzzer will sound to remind you to turn over the food during cooking. If there is not any operation, it will keep on working.

DISPLAY	MENU	WEIGHT	POWER
AF01	Frozen French Fries	11Oz	Conv. 425°F
AF02	Frozen onion Rings	10Oz	Conv. 425°F
AF03	Frozen chicken nuggets	12Oz	Conv. 425°F
AF04	Frozen chicken wings	18Oz	Conv. 425°F
AF05	Frozen chicken legs	27Oz	Conv. 425°F
AF06	Frozen Chicken Tenders	11Oz	Conv. 425°F
AF07	Frozen Shrimps	9Oz	Conv. 425°F
AF08	Frozen Fish Sticks	12Oz	Conv. 425°F
AF09	Frozen Spring Rolls	11Oz	Conv. 425°F
AF10	Frozen Mozzarella Sticks	11Oz	Conv. 425°F

14. MANUAL AIRFRY COOKING

1 In standby mode, press " Air Fry " once, "dEG" will display. → 

2 Press the number key "0" or "5-9" to select the temperature, "300°F, 325°F, 350°F, 375°F, 400°F, 425°F" are available. → 
OR

5 300°F	6 325°F	7 350°F
8 375°F	9 400°F	0 425°F

3 Press "  " to confirm. → 

4 Press the number keys to set the cooking time. → 

5 Press "  " to start cooking. → 

15. MULTI-STAGE COOKING

Example: Defrost food for 5 minutes and then broil cook for 7 minutes.

1 Press " **Defrost** " twice and then "dEF2" will display. →

Defrost
Wgt./Time

2 Press "5", "0", "0" to set the desired defrost time of 5 minutes. →

5 0 0
300°F 425°F 425°F

3 Press " **Broil** " once, "0:00" will display. →

Broil

4 Press "7", "0", "0" to set the cooking time. →

7 0 0
350°F 425°F 425°F

5 Press "  " to start cooking. →

Start/+30Sec.

NOTE

- Two cooking stages can be set in multi-stage cooking.
- If you set the defrost function, it will work automatically in the first stage.
- The kitchen timer, auto menu, and preheat cannot be set as one of the multi-stage.

16. ECO FUNCTION

- 1 To enter ECO mode:
In standby mode, press "  " once.
The screen will turn off.



- 2 To cancel ECO mode:
In ECO mode, pressing any key, or opening and closing the door will cancel it.

17. LOCK FUNCTION FOR CHILDREN

You can use this function to prevent children from accidentally turning the oven on.

- 1 To activate the lock:
In standby mode, press and hold
"  " for three seconds. A beep sounds and the locked icon will display.



- 2 To deactivate the lock:
In the locked state, press and hold
"  " for three seconds.
A beep sounds.



18. INQUIRING FUNCTION

- 1 If the clock has been set, the current time will display for three seconds by pressing
" **Set Clock** " in the cooking state.



- 2 In the microwave cooking state, press " **Power Level** "
to inquire about the power level. It will display for three seconds.



CLEANING AND MAINTENANCE

CLEANING

With good care and cleaning, your appliance will retain its appearance and remain fully functioning for a long time to come. Here are the instructions on how to properly care for the microwave oven.



WARNING

- Scratched glass in the appliance door may develop into a crack. Do not use a glass scraper, sharp or abrasive cleaning aids or detergents.
- The surface of the appliance may become damaged if it is not cleaned properly. Microwave energy may escape. Clean the appliance on a regular basis, and remove any food remnants immediately.
- Do not immerse the appliance in water or clean under a jet of water.

Cleaning agent

To ensure that the different surfaces are not damaged by using the wrong cleaning agent, see the information in the table. Wash new sponge or cloth thoroughly before use.

Do not use:



Harsh or abrasive cleaning agents



Metal or glass scrapers to clean the door panels



Metal or glass scrapers to clean the door seal



Hard scouring pads or sponges



Cleaning agents with a high alcohol content

APPLIANCE FRONT

Hot soapy water:

Clean using a dish cloth and then dry with a soft cloth. Do not use metal or glass scrapers for cleaning.

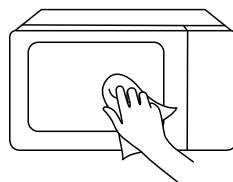

APPLIANCE FRONT WITH STAINLESS STEEL

Hot soapy water:

Clean using a dish cloth and then dry with a soft cloth. Remove splashes and patches of limescale, grease, starch and albumin immediately. Corrosion can form under these patches or splashes. Do not use glass cleaners or metal or glass scrapers for cleaning.

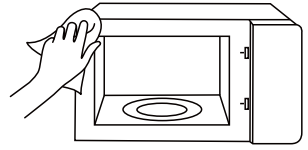

COOKING COMPARTMENT MADE OF STAINLESS STEEL

Hot soapy water or vinegar solution:

Clean using a dish cloth and then dry with a soft cloth. Do not use oven spray or any other aggressive oven cleaners or abrasive materials. Scouring pads, rough sponges and pan cleaners are also unsuitable. These items scratch the surface. Allow the interior surfaces to dry completely.

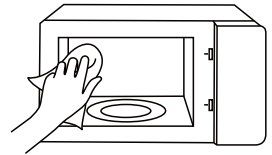

RECESS IN THE COOKING COMPARTMENT

Damp cloth:

Water must not be allowed to run into the appliance through the turntable drive. Dry the turntable drive with a cloth.

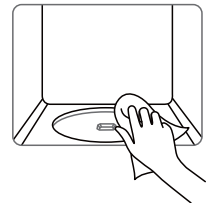

TURNTABLE AND ROLLER RING

Hot soapy water:

When placing the turntable back into its recess, it must engage properly.

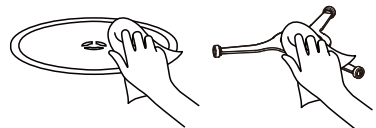

DOOR PANELS

Glass cleaner:

Clean with a dish cloth. Do not use glass scrapers.

TROUBLE SHOOTING

Check your problem by using the chart below and try the solutions for each problem. If the microwave oven still does not work properly, contact the nearest authorized service center.

TROUBLE	POSSIBLE CAUSE	POSSIBLE REMEDY
Oven will not start	<ul style="list-style-type: none"> a. Electrical cord for oven is not plugged in. b. Door is open. c. Wrong operation is set. 	<ul style="list-style-type: none"> a. Plug into the outlet. b. Close the door and try again. c. Check instructions
Arcing or sparking	<ul style="list-style-type: none"> a. Materials to be avoided in microwave oven were used. b. The oven is operated when empty. c. Spilled food remains in the cavity. 	<ul style="list-style-type: none"> a. Use microwave-safe cookware only. b. Do not operate with oven empty. c. Clean cavity with soft damp cloth.
Unevenly cooked foods	<ul style="list-style-type: none"> a. Materials to be avoided in microwave oven were used. b. Food is not defrosted completely. c. Cooking time, power level is not suitable. d. Food is not turned or stirred. 	<ul style="list-style-type: none"> a. Use microwave-safe cookware only. b. Completely defrost food. c. Use correct cooking time, power level. d. Turn or stir food.
Overcooked foods	<ul style="list-style-type: none"> Cooking time, power level is not suitable. 	<ul style="list-style-type: none"> Use correct cooking time, power level.
Undercooked foods	<ul style="list-style-type: none"> a. Materials to be avoided in microwave oven were used. b. Food is not defrosted completely. c. Oven ventilation ports are restricted. d. Cooking time, power level is not suitable. 	<ul style="list-style-type: none"> a. Use microwave-safe cookware only. b. Completely defrost food. c. Check to see that oven ventilation ports are not restricted. d. Use correct cooking time, power level
Improper defrosting	<ul style="list-style-type: none"> a. Materials to be avoided in microwave oven were used. b. Cooking time, power level is not suitable. c. Food is not turned or stirred. 	<ul style="list-style-type: none"> a. Use microwave-safe cookware only. b. Use correct cooking time, power level. c. Turn or stir food.

#DetailsMatter