

Microwave Oven

INSTRUCTION MANUAL

Model:EM245A5L-PV

Read these instructions carefully before using your microwave oven, and keep it carefully.

If you follow the instructions, your oven will provide you with many years of good service.

SAVE THESE INSTRUCTIONS CAREFULLY

PRECAUTIONS TO AVOID POSSIBLE EXPOSURE TO EXCESSIVE MICROWAVE ENERGY

- (a) Do not attempt to operate this oven with the door open since this can result in harmful exposure to microwave energy. It is important not to defeat or tamper with the safety interlocks.
- (b) Do not place any object between the oven front face and the door or allow soil or cleaner residue to accumulate on sealing surfaces.
- (c) Do not operate the oven if it is damaged. It is particularly important that the oven door closes properly and that there is no damage to the:
 - (1) DOOR (bent)
 - (2) HINGES AND LATCHES (broken or loosened)
 - (3) DOOR SEALS AND SEALING SURFACE
- (d) The oven should not be adjusted or repaired by anyone except properly qualified service personnel.

Specifications

Model:	EM245A5L-PV
Rated Voltage:	120V~ 60Hz
Rated Input Power(Microwave):	1350W
Rated Output Power(Microwave):	1250W
Oven Capacity:	1.6 Cu.ft.
Turntable Diameter:	Ø 14.2 inch
External Dimensions:	21.8X18.9X12.8 inch (553X480X326mm)
Net Weight:	Approx. 35.5 Lbs(16 kg)

IMPORTANT SAFETY INSTRUCTIONS

WARNING

1. Read all instructions before using the appliance.
2. Read and follow the specific: "PRECAUTIONS TO AVOID POSSIBLE EXPOSURE TO EXCESSIVE MICROWAVE ENERGY" found on page 2.
3. As with most cooking appliances, close supervision is necessary to reduce the risk of a fire in the oven cavity.
4. To reduce the risk of fire in the oven cavity:
 - i). Do not overcook food. Carefully attend the appliance when paper, plastic, or other combustible materials are placed inside the oven to facilitate cooking.
 - ii). Remove wire twist-ties and metal handles from paper or plastic containers/bags before placing them in the oven.
 - iii). If materials inside the oven ignite, keep the oven door closed. Turn the oven off, and unplug the appliance. Disconnect the power cord, shut off power at the fuse or circuit breaker panel.
 - iv). Do not use the oven cavity for storage purposes. Do not leave paper products, cooking utensils, or food in the cavity when not in use.
5. This oven must be grounded. Connect only to properly grounded outlet. See "GROUNDING INSTRUCTIONS" found on page 4.
6. Install or locate this oven only in accordance with the installation instructions provided.
7. Some products such as whole eggs and sealed containers-for example, closed glass jars-are able to explode and should not be heated in the oven.
8. Use this appliance only for its intended uses as described in this manual. Do not use corrosive chemicals or vapors in this appliance. This oven is specifically designed to heat or cook or dry food. It is not designed for industrial or laboratory use.
9. As with any appliance, close supervision is necessary when used by children.
10. Do not operate this oven if it has a damaged cord or plug, if it is not working properly or if it has been damaged or dropped.
11. This appliance should be serviced only by qualified service technicians. Contact the nearest authorized service facility for examination, repair or adjustment.
12. Do not cover or block any openings on the oven.
13. Do not store or use this appliance outdoors.
14. Do not use this oven near water, for example, near a kitchen sink, in a wet basement, near a swimming pool, or similar locations.
15. Do not immerse cord or plug in water.
16. Keep cord away from heated surfaces.
17. Do not let cord hang over edge of table or counter.
18. When cleaning surfaces of door and oven that comes together on closing the door, use only mild, nonabrasive soaps or detergents applied with a sponge or soft cloth.

19. Liquids, such as water, coffee, or tea are able to be overheated beyond the boiling point without appearing to be boiling. Visible bubbling or boiling when the container is removed from the microwave oven is not always present. THIS COULD RESULT IN VERY HOT LIQUIDS SUDDENLY BOILING OVER WHEN THE CONTAINER IS DISTURBED OR A SPOON OR OTHER UTENSIL IS INSERTED INTO THE LIQUID.
- i) Do not overheat the liquid.
 - ii) Stir the liquid both before and halfway through heating it.
 - iii) Do not use straight-sided containers with narrow necks.
 - iv) After heating, allow the container to stand in the microwave oven for a short time before removing the container.
 - v) Use extreme care when inserting a spoon or other utensil into the container.

SAVE THESE INSTRUCTIONS

GROUNDING INSTRUCTIONS

DANGER

Electric Shock Hazard

Touching some of the internal components can cause serious personal injury or death. Do not disassemble this appliance.

WARNING

Electric Shock Hazard

Improper use of the grounding can result in electric shock. Do not plug into an outlet until appliance is properly installed and grounded.

Three-pronged
(grounding) plug

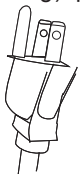

This appliance must be grounded. In the event of an electrical short circuit, grounding reduces the risk of electric shock by providing an escape wire for the electric current. This appliance is equipped with a cord having grounding wire with a grounding plug. The plug must be plugged into an outlet that is properly installed and grounded.

Consult a qualified electrician or serviceman if the grounding instructions are not completely understood or if doubt exists as to whether the appliance is properly grounded. If it is necessary to use an extension cord, use only a 3-wire extension cord that has a 3-pronged grounding plug, and a 3-slot receptacle that will accept the plug on the appliance. The marked rating of the extension cord shall be equal to or greater than the electrical rating of the appliance.

1. A short power-supply cord is provided to reduce the risks resulting from becoming entangled in or tripping over a longer cord.
2. Longer cord sets or extension cords are available and may be used if care is exercised in their use.
3. If a long cord set or extension cord is used:
 - 1) The marked electrical rating of the cord set or extension marked electrical rating of the cord set or extension cord should be at least as great as the electrical rating of the appliance.
 - 2) The extension cord must be a grounding-type 3-wire cord; and
 - 3) The longer cord should be arranged so that it will not drape over the countertop or tabletop where it can be pulled on by children or tripped over unintentionally.

Radio Interference

1. Operation of the microwave oven may cause interference to your radio, TV or similar equipment.
2. When there is interference, it may be reduced or eliminated by taking the following measures:
 - 1) Clean door and sealing surface of the oven
 - 2) Reorient the receiving antenna of radio or television.
 - 3) Relocate the microwave oven with respect to the receiver.
 - 4) Move the microwave oven away from the receiver.
 - 5) Plug the microwave oven into a different outlet so that microwave oven and receiver are on different branch circuits.

UTENSILS

CAUTION

Personal Injury Hazard

Tightly-closed utensils could explode. Closed containers should be opened and plastic pouches should be pierced before cooking.

See the instructions on "Materials you can use in microwave oven or to be avoided in microwave oven." There may be certain non-metallic utensils that are not safe to use for microwaving. If in doubt, you can test the utensil in question following the procedure below.

Utensil Test:

1. Fill a microwave-safe container with 1 cup of cold water (250ml) along with the utensil in question.
2. Cook on maximum power for 1 minute.
3. Carefully feel the utensil. If the empty utensil is warm, do not use it for microwave cooking.
4. Do not exceed 1 minute cooking time.

Materials you can use in microwave oven

Utensils	Remarks
Aluminum foil	Shielding only. Small smooth pieces can be used to cover thin parts of meat or poultry to prevent overcooking. Arcing can occur if foil is too close to oven walls. The foil should be at least 1 inch (2.5cm) away from oven walls.
Browning dish	Follow manufacturer's instructions. The bottom of browning dish must be at least 3/16 inch (5mm) above the turntable. Incorrect usage may cause the turntable to break.
Dinnerware	Microwave-safe only. Follow manufacturer's instructions. Do not use cracked or chipped dishes.
Glass jars	Always remove lid. Use only to heat food until just warm. Most glass jars are not heat resistant and may break.
Glassware	Heat-resistant oven glassware only. Make sure there is no metallic trim. Do not use cracked or chipped dishes.
Oven cooking bags	Follow manufacturer's instructions. Do not close with metal tie. Make slits to allow steam to escape.
Paper plates and cups	Use for short-term cooking/warming only. Do not leave oven unattended while cooking.
Paper towels	Use to cover food for reheating and absorbing fat. Use with supervision for a short-term cooking only.
Parchment paper	Use as a cover to prevent splattering or a wrap for steaming.
Plastic	Microwave-safe only. Follow the manufacturer's instructions. Should be labeled "Microwave Safe". Some plastic containers soften, as the food inside gets hot. "Boiling bags" and tightly closed plastic bags should be slit, pierced or vented as directed by package.
Plastic wrap	Microwave-safe only. Use to cover food during cooking to retain moisture. Do not allow plastic wrap to touch food.
Thermometers	Microwave-safe only (meat and candy thermometers).
Wax paper	Use as a cover to prevent splattering and retain moisture.

Materials to be avoided in microwave oven

Utensils	Remarks
Aluminum tray	May cause arcing. Transfer food into microwave-safe dish.
Food carton with metal handle	May cause arcing. Transfer food into microwave-safe dish.
Metal or metal-trimmed utensils	Metal shields the food from microwave energy. Metal trim may cause arcing.
Metal twist ties	May cause arcing and could cause a fire in the oven.
Paper bags	May cause a fire in the oven.
Plastic foam	Plastic foam may melt or contaminate the liquid inside when exposed to high temperature.
Wood	Wood will dry out when used in the microwave oven and may split or crack.

SETTING UP YOUR OVEN

Names of Oven Parts and Accessories

Remove the oven and all materials from the carton and oven cavity.

Your oven comes with the following accessories:

- Glass tray 1
- Turntable ring assembly 1
- Instruction Manual 1

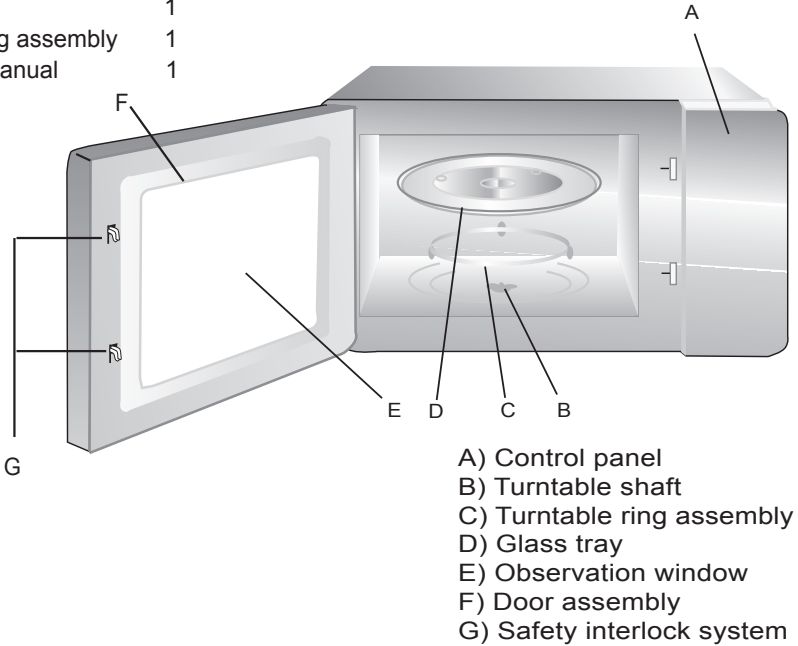

Turntable Installation

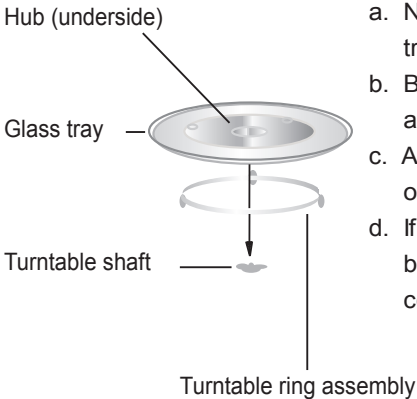

- a. Never place the glass tray upside down. The glass tray should never be restricted.
- b. Both glass tray and turntable ring assembly must always be used during cooking.
- c. All food and containers of food are always placed on the glass tray for cooking.
- d. If glass tray or turntable ring assembly cracks or breaks, contact your nearest authorized service center.

Countertop Installation

Remove all packing material and accessories. Examine the oven for any damage such as dents or broken door. Do not install if oven is damaged.

Cabinet: Remove any protective film found on the microwave oven cabinet surface. Do not remove the light brown Mica cover that is attached to the oven cavity to protect the magnetron.

Installation

1. Select a level surface that provide enough open space for the intake and/or outlet vents.

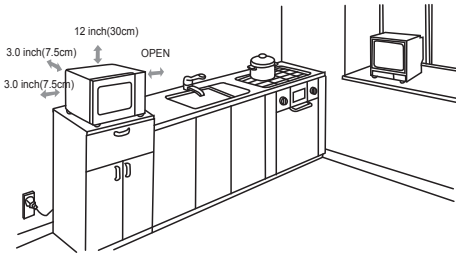

A minimum clearance of 3.0 inches (7.5cm) is required between the oven and any adjacent walls. One side must be open.

- (1) Leave a minimum clearance of 12 inches (30cm) above the oven.
- (2) Do not remove the legs from the bottom of the oven.

- (3) Blocking the intake and/or outlet openings can damage the oven.
 - (4) Place the oven as far away from radios and TV as possible. Operation of microwave oven may cause interference to your radio or TV reception.
2. Plug your oven into a standard household outlet. Be sure the voltage and the frequency is the same as the voltage and the frequency on the rating label.

WARNING: Do not install oven over a range cooktop or other heat-producing appliance. If installed near or over a heat source, the oven could be damaged and the warranty would be void.

OPERATION

1. Power Level

11 power levels are available.

Level	10	9	8	7	6	5	4	3	2	1	0
Display	PL10	PL9	PL8	PL7	PL6	PL5	PL4	PL3	PL2	PL1	PL0

2. Clock Setting

When the microwave oven is plugged into an outlet, LCD will display " WELCOME ". " **INVERTER** " will light. Buzzer sounds once. If there is no operation in 10 seconds, it will enter into waiting state. And LCD will display "0:00".

- (1) Press "Clock", LCD will display "00:00". The first hour figure will flash. ":" and other "0" will light. If there is no operation or invalid number is input in 3 seconds, LCD will display " ENTER THE TIME OF DAY " once, and then turn back to display "00:00".
- (2) Press the number keys to input the time of day.
- (3) Press "Clock" to finish clock setting. ":" will flash and the time of day will light. If there is no operation in 3 seconds after enter the time of day, LCD will display " PRESS CLOCK ".
- (4) If the numbers input are not within the range of 1:00--12:59, the setting will be invalid until valid numbers are input.

Note: In the process of clock setting, if the " STOP/Cancel " button is pressed or if there is no operation within 1 minute, the oven will go back to the former state automatically.

3. Kitchen Timer

- (1) Press " Timer ", LCD will display "00:00". If there is no operation in 2 seconds, LCD will display "ENTER TIME IN MINUTES AND SECONDS" once, and then turn back to display "00:00".
- (2) Press the number keys to input the time. The maximum time is 99 minutes 99 seconds.
- (3) Press " START/+30sec. " to confirm the setting. If there is no operation in 3 seconds, LCD will display "PRESS START".
- (4) When the kitchen time arrives, buzzer sounds 5 times. If the clock has been set, LCD will display the current time by counting down.

Note: 1) Kitchen time is different from the clock. Kitchen Timer is a timer.

That is to say it processes the function of alarming clock.

2) During timer process, any program cannot be set.

4. Microwave cook



- (1) Press "Cook Time" once, LCD will display "00:00". "  " will light. If there is no operation in 2 seconds, LCD will display "ENTER TIME IN MINUTES AND SECONDS" once, and then turn back to display "00:00".

- (2) Press number keys to input the cooking time. The maximum cooking time is 99 minutes 99 seconds. If there is no operation in 3 seconds, LCD will display "PRESS START OR CHANGE NEW LEVEL" once, and then turn back to display the cooking time.
 - (3) Press " Power " once, LCD will display "PL10". If there is no operation in 2 seconds, LCD will display " ENTER NEW LEVEL OR PRESS START". Press the number keys to input power level.
 - (4) Press " START/+30sec." to start cooking.
 - (3) During cooking, " Power " can be pressed to change the power level. Press " Power ", LCD will display the power level for about 3 seconds. Press the number keys to input new power level. The oven will cook with new power level for rest time.
- Note: In the process of cooking, if the " STOP/Cancel " button is pressed or if there is no operation within 1 minute, the oven will go back to the former setting automatically.





5. Speedy Cooking

- (1) In waiting state, instant cooking at 100% power level can be started by select a cooking time from 1 to 3 minutes by pressing number pads 1 to 3. "START/+30sec." can be pressed to increase the cooking time during cooking. The maximum cooking time is 99 minutes 99 seconds. "  " will flash.
 - (2) In waiting state, instant cooking at 100% power level with 30 seconds' cooking time can be started by pressing " START/+30sec.". Each press on the same button will increase cooking time by 30 seconds. The maximum cooking time is 99 minutes 99 seconds.
- Note: Under microwave and time defrost function, "START/+30sec." can be pressed to increase cooking time by 30 seconds.

6. Weight Defrost Function





- (1) Press "Defrost" once, LED will display "WEIGHT". If there is no operation in 3 seconds, LCD will display " PRESS AGAIN TO SELECT DEFROST TYPE OF ENTER COOKING WEIGHT " once. Then LCD display "0.0 LBS".
- (2) Press number keys to input weight to be defrosted between 0.1-6.0 Lbs. If there is no operation in 3 seconds, LCD will display " PRESS START ".
- (3) Press " START/+30sec." to start defrosting. "  " and "  " will flash.

7. Time Defrost Function

- (1) Press "Defrost" twice, LED will display " TIME". If there is no operation in 3 seconds, LCD will display " ENTER TIME IN MINUTES AND SECONDS" once, and then turn back to display "00:00". "  " and "  " will light.
- (2) Press number keys to input the cooking time. The maximum cooking time is 99 minutes 99 seconds. If there is no operation in 3 seconds, LCD will display "PRESS START".
- (3) Press " START/+30sec." to start defrosting. "  " and "  " will flash.





8. Auto Menu

a) Popcorn

- (1) Press " Popcorn ", LCD display "1.75 Oz", "  " and "  " will light.
Continue to press " Popcorn " to choose the weight. If there is no operation in 3 seconds, LCD will display " PRESS AGAIN TO SELECT SERVING SIZE OR PRESS START" once. And then turn back to display the weight.
- (2) Press " START/+30sec." to start defrosting. "  " and "  " will flash.

Times(Press "Popcorn")	Weight	Display
Once	1.75 Oz	1.75 Oz
Twice	3.0 Oz	3.0 Oz
Thrice	3.5 Oz	3.5 Oz

b) Menu

- (1) Press " Sensor Reheat ", " Prozen Pizza", " Fresh Vegetable ", " Potato", and " Meat " keys, LCD will display "SENSOR REHEAT", "PROZEN PIZZA", "FRESH VEGGIES", "POTATO" and "MEAT" for two times, then stop 3 seconds. If there is no operation in 3 seconds, LCD will display "PRESS START". "  " and "  " will light.
- (2) Press " START/+30sec." to start cooking. "  " and "  " will flash.
LCD will display "S-01", "S-02"...."S-05" before the steaming is emanated. The sensor will sound once when the steaming is emanated. The surplus time will display.

Note:

- 1)When cooking or reheating food, you should do these in order to have the best effect.
 - a.The room temperature cannot be over 35 degrees.
 - b.The weight of food must be more than 110g (4 Oz).
 - c.The cavity, glass tray and utensils must be kept drying before putting the food in.
 - d.The reheat food can be covered with the lid. But the lid must have venthole in order to emanate the steam. Sealed utensil is forbidden.
- 2) During cooking process, following points must be done.
 - a.Keep the door closed when the surplus time is not displayed.
 - b.When the surplus time is displayed and begins to count down, the door can be opened to mix the food up, turn over or replace the food. And then go on the next operation.
- 3) Please leave the food alone for a while after cooking have been finished.
- 4) During sensor cooking process, if the time does not count down, please do not open the oven door or press "STOP/Cancel" key. Otherwise, the sensor will make mistakes.

9. Multi-section cooking

At most 2 sections can be set for cooking. In multi-section cooking, if one section is defrosting, then defrosting shall be placed in the first section. When the first stage finishes, the buzzer will sound once and the next stage will begin cooking.

Note: auto menu cannot be set as one of the multi-section.

10. Memory Function

- (1) Press "0/Favorite" to choose memory 1-3 procedure. 1, 2, 3 will display. If there is no operation or invalid number key is input within 3 seconds, LCD will display "ENTER A NEW COOKING OR PRESS 0 KEY AGAIN" once, and then turn back to display "1", "2" or "3".
- (2) If the procedure has been set, press " START/+30sec. " to use it. If not, continue to set the procedure. Only one or two stages can be set.
- (3) After finishing the setting, press "START/+30sec." to save the procedure.
If press " START/+30sec. ", it can be saved and operated.

Note: Auto menu cannot be set as memory cooking.

11. Inquiring Function

- 1) In cooking state, press " Clock ", the clock will display for three seconds. Then the oven will turn back to cooking state.
- 2) In the microwave cooking state, press " Power" to inquire the microwave power level
The current microwave power will be displayed for about three seconds. Then the oven will turn back to the previous state. In the two-stage cooking state, the power level can be checked by the same way.

12. Lock Function for Children

Lock: In waiting state, press " STOP/Cancel" for 3 seconds, there will be a long "beep" denoting entering into the children-lock state. LCD will display the current time or 0:00.

Lock quitting: In locked state, press " STOP/Cancel " for 3 seconds, there will be a long "beep" denoting that lock is released.

13. Cooking End Reminding Function

When the cooking is over, 5 long "beep" will sound to remind the user that the cooking is finished. LCD will display "FINISH".

14. Other Specifications

- (1) "START/+30sec." must be pressed to continue cooking if the door is opened during cooking.
- (2) In working or pause state, the surplus cooking time displays.
- (3) The buzzer sounds once by efficient press, inefficient press will be no response.
- (4) Once the cooking programme has been set , "START/+30sec." is not pressed in 1 minute. The current time will be displayed. The setting will be cancelled.

Maintenance

Troubleshooting

Check your problem by using the chart below and try the solutions for each problem. If the microwave oven still does not work properly, contact the nearest authorized service center.

TROUBLE	POSSIBLE CAUSE	POSSIBLE REMEDY
Oven will not start	a. Electrical cord for oven is not plugged in. b. Door is open. c. Wrong operation is set.	a. Plug into the outlet. b. Close the door and try again. c. Check instructions.
Arcing or sparking	a. Materials to be avoided in microwave oven were used. b. The oven is operated when empty. c. Spilled food remains in the cavity.	a. Use microwave-safe cookware only. b. Do not operate with oven empty. c. Clean cavity with wet towel.
Unevenly cooked foods	a. Materials to be avoided in microwave oven were used. b. Food is not defrosted completely. c. Cooking time, power level is not suitable. d. Food is not turned or stirred.	a. Use microwave-safe cookware only. b. Completely defrost food. c. Use correct cooking time, power level. d. Turn or stir food.
Overcooked foods	Cooking time, power level is not suitable.	Use correct cooking time, power level.
Undercooked foods	a. Materials to be avoided in microwave oven were used. b. Food is not defrosted completely. c. Oven ventilation ports are restricted. d. Cooking time, power level is not suitable.	a. Use microwave-safe cookware only. b. Completely defrost food. c. Check to see that oven ventilation ports are not restricted. d. Use correct cooking time, power level.
Improper defrosting	a. Materials to be avoided in microwave oven were used. b. Cooking time, power level is not suitable. c. Food is not turned or stirred.	a. Use microwave-safe cookware only. b. Use correct cooking time, power level. c. Turn or stir food.